

NOT
an official
Amstrad
publication!

**A
M
S
T
R
A
D
ACTION**

THE BIGGEST AND BEST MEGAZINE FOR THE CPC WORLDWIDE!



CELEBRATE
the CPC's fifth birthday

- The machine's creators reveal their secrets
- We name our 'Desert Island Disks'
- And joysticks – your definitive guide

**CPC FIFTH
BIRTHDAY
SPECIAL ISSUE!**

THE POWER

TAITO COIN-OP HITS

'THE ARCADE COMPILATION OF THE YEAR'

Featuring:

RASTAN

CRASH - "Rastan is slick and compelling"
YOUR SINCLAIR - "So another spanker from Imagine. You'll be a fool if you miss it!"

SLAPFIGHT

COMPUTER & VIDEO GAMES - "Simple. Smooth. Very addictive. A winner." ZZAP - "A superb arcade conversion and a great shoot 'em up. This is one for the ZAPPERS collection."

RENEGADE

COMMODORE USER - "As conversions go this still takes some beating - literally and metaphorically."
YOUR SINCLAIR - "The graphics are so slick you really feel you're part of an action movie rather than just playing a game."

ARKANOID

ZZAP 64 - "I thoroughly recommend Arkanoid - for the simple reason that it's simply gorgeous playing with it."
COMPUTER GAMES WEEK - "The take home message is simple. You want a great arcade game?"

FLYING SHARK

COMPUTER WITH THE AMSTRAD CPC - "This is an excellent game."
ACE - "Incredibly frustrating playable and addictive."

ARKANOID REVENGE OF DOH

AMTIX - "Excellent - can't fault it. A future number one."
YOUR SINCLAIR - "Immensely impressive and chronically addictive. A Classic."

BUBBLE BOBBLE

AMSTRAD ACTION - "It's a cracker. Definitely a game I should keep coming back to."

GAMES MACHINE - "Packed to the brim with entertainment."

LEGEND OF KAGE

CRASH - "One I won't put down until I get through to the next level."

COMMODORE
CASSETTE: £12.95
DISK: £14.95

AMSTRAD
CASSETTE: £12.95
DISK: £14.95

SPECTRUM
CASSETTE: £12.95
DISK: £14.95



the name of the game



R PACKS!

THE IN-CROWD
8 SPECTACULAR GAMES IN 1 SPECIAL PACK



GRYZOR

"If you're looking for a high speed action-packed game that's good to look at and exciting to play - grab Gryzor now!" - Your Sinclair

BARBARIAN

"Its reputation for being the most bloodthirsty computer game ever, means that its phenomenal success will undoubtedly continue." - Sinclair User.

COMBAT SCHOOL

"Combat School is brilliant - definitely the best arcade conversion around." - Zzap 64

TARGET RENEGADE

"If you're after some exciting beat 'em up action this is a good excuse to part with all your hard-earned cash." - Crash

PREDATOR

"Predator is a superb tie-in and really hits the mark." - ZZAP! Sizzler

PLATOON

"Platoon is absolutely superb - a milestone in film tie-ins, and a yardstick by which all others shall be judged." - Zapp 64

CRAZY CARS

"Crazy Cars is a three-dimensional real-time simulation. This must be the ultimate car game." - Sinclair User

KARNOV

"Stunningly colourful screens ... the most accurate conversion of an arcade hit in years." - Your Sinclair

GAME SET & MATCH 2

THE GREATEST SPORTS COMPILATION EVER

Score a goal, race on two wheels, compete in the Bob Sled, Ski jump, Slalom and downhill. Match strokes with Nick Faldo, make the winning break against Steve Davies but play a straight bat against Ian Botham. enter the arena in Track & Field as you compete in 100 metres dash, Long Jump, Javelin, 110 metres hurdles; Hammer Throw and High Jump and if that doesn't finish you off then throw jump shots against the basketball aces and go for a touchdown in the NFL Superbowl - then you can sit down ... in the cockpit of a Formula 1 racing car as you compete to take the chequered flag! Check out GSM 2 - the ultimate in sports compilations.

COMMODORE
 CASSETTE: £14.95
 DISK: £17.95

AMSTRAD
 CASSETTE: £14.95
 DISK: £17.95

SPECTRUM
 CASSETTE: £14.95
 DISK: £17.95

IN-CROWD



Note: SUPERBOWL and WINTER OLYMPIAD are not available on the AMSTRAD version

THE LINE UP

AMSTRAD ACTION ● MAY 1989

FRONT END

NEWSLETTERS

7 AMSCENE

Bursting at the seams with CPC news, stories and info

11 REACTION

You don't have to sit and suffer in silence! Get it off your chest and into your very own pages

SERIOUS SIDE

SOFTWARE ● HARDWARE ● PROGRAMMING

15 THE FIRST FIVE YEARS

Celebrate the fifth birthday of the CPC with us! There's an in-depth report on the remarkable story of how it came into existence; we speak to the men who were there, and who the full story for the first time



Future Publishing Ltd 4 Queen Street, Bath BA1 1EJ

Telephone 0225 446034
Fax 0225 446019

Editor: Steve Carey

Technical Editor: Pat McDonald

Staff Writer: Trenton Webb

Art Editor: Ollie Alderton

Additional Design: Martin Parfitt

Contributors: Phil Craven, Steve Williams, Emma Broadley, Dave Rogers, James Wilson, The Pilchard, Bertram Russell

Publisher: Greg Ingham

Production: Diane Tavener, Claire Woodland, Jenny Reid

Subscriptions: Christine Stacey, Amstrad Action, The Old Barn, Brunel Precinct, Somerton, Somerset TA11 7PY ☎ 0458 74011

Mail Order: Clare Bates, Amstrad Action, The Old Barn, Brunel Precinct, Somerton, Somerset, TA11 7PY ☎ 0458 74011

Advertisements: Elaine Brooks ☎ 0225 446034

Cover photography: Stuart Baynes. ☎ 0225 66343

Colour origination: Wessex Reproductions, Bristol

Printing: Redwood Web Offset, Trowbridge, Wilts

Distribution: Seymour Press, 334 Brixton Road, London

ABC

MEMBER OF THE
AUDIT BUREAU OF
CIRCULATIONS

38,457

July-December 1988

© FUTURE PUBLISHING LTD 1989

Amstrad Action is an independent publication. The company producing it, Future Publishing Ltd, has no connection with Amstrad plc. We welcome contributions from readers, but unfortunately cannot guarantee to return material submitted to us, nor can we enter into personal correspondence. We take great care to ensure that what we publish is accurate, but cannot be liable for any mistakes or misprints. No part of this publication may be reproduced in any form without our written permission.

THE ACTION BEGINS ON 28!

ALL THE TOP CPC GAMES!

28 ACTION TEST SPECIAL

28 joysticks - in what may be the biggest 'Joystick Jury' ever, Trent sorts 'em out and comes up with the winners



35 HKM

He's the meanest son of a snake you've ever seen...



19 THE CPC COLLECTION

A furiously controversial and pigheaded selection of CPC software - both serious and otherwise!



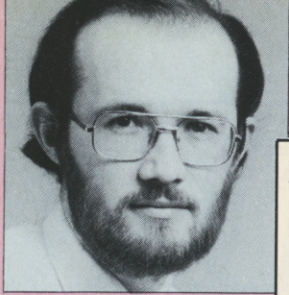

● Dave Rogers talks about life as a games music programmer (p.20)

ACTION TEST begins on page 28!

All this! ▶ Human Killing Machine (p. 35)
 ▶ Question of Sport (p. 42) ▶ Barbarian II (p. 38)
 ▶ Pacland (p.45) ▶ Jinks (p.40) ▶ Blasteroids (p.45)
 ▶ Gary Lineker's Hot-Shots (p.36) ▶ SDI (p.41)...
 plus our great Operation Hormuz competition (p.47)

38 BARBARIANS II

At last! But has it been worth the wait?

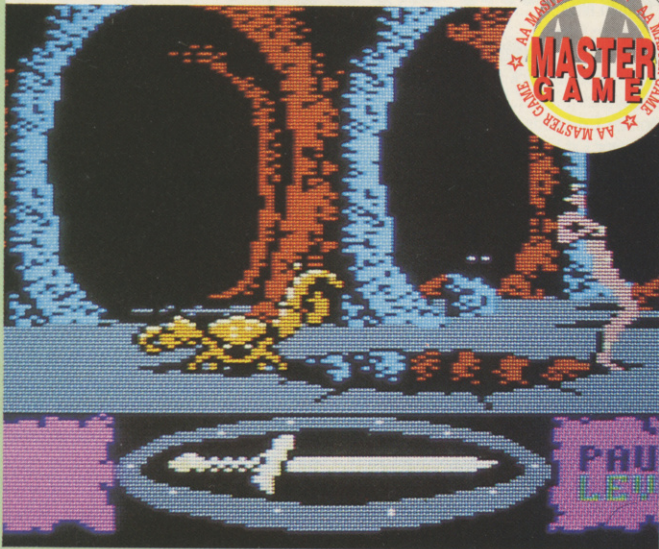

41 SDI

This space ain't big enough for the both of us!

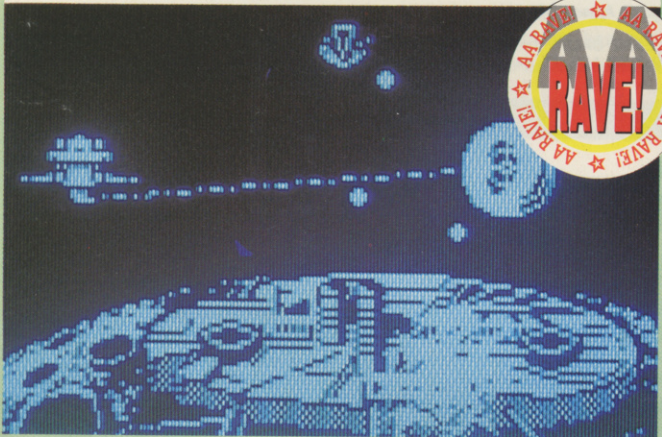

20 CUE SOUND FX

A fascinating insight into the world of the professional music programmer.

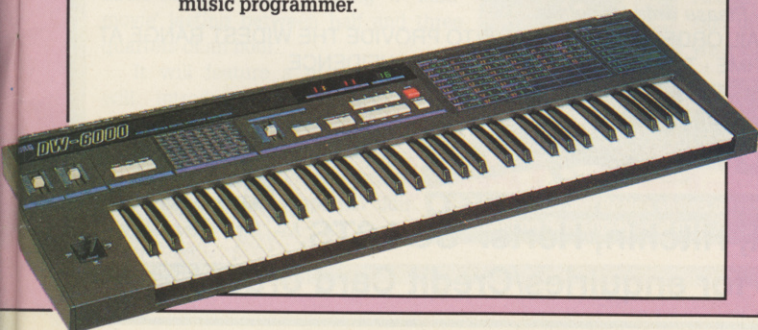

Five more years?

What were you doing five years ago? Hard though it is to believe it, in April 1984 Alan Sugar - who'd just won the Guardian Young Businessman of the Year award - was taking a small company called Amstrad into the very risky world of how a machine called the CPC464. The fascinating story of how a machine called Arnold was born is told in this fifth birthday special issue. And now, five years and two million machines later, how's it doing? Well, contrary to what you might expect and contrary to what some sections of the computer press keep insisting, very well indeed thank you very much. New products (see Amscene), new games (see Action Test), and sales figures that keep on surprising everyone. The CPC's never had it so good!

Steve

22 FORUM

Assistance of the CPC kind with PAT McDONALD

24 BROADLEY SPEAKING

EMMA BROADLEY begins her new outspoken column!

NEW! FEATURE

26 TAKE STOCK

A brand new stock control system. Check it out!

33 QUALITAS PLUS

Enhance your printing - without shelling out £££s!

48 THE LOOK

Our extraordinarily popular graphics series moves on

50 DAY IN THE LIFE

The perfect solution for all your language difficulties...

52 HELP LINE

They have dedicated themselves to helping you!

54 TYPE INS

Another collection of utilities, games and finger exercises

58 SMALL ADS

Whether you're buying or selling, this is the place for you!

59 AA DIY DRIVE SWITCHER

So simple and yet so very useful

60 PILGRIM

The Caped Crusader of the adventuring world strikes again!

62 CHEAT MODE

Crackers, hackers, cheats and pokers gather together for another gamebusting session with TRENTON WEBB

66 ABSOLUTE BEGINNERS

Or absolute experts, as it should be now. For we have stayed the course, right to the very end...

67 BUYERS GUIDE

It's bigger, better and more up to date than ever before

70 AFTERTHOUGHT

The CPC Character Set strikes again!

71 SPECIAL OFFERS

The all-new vibrant spectacular money-saving mail order pages!

DISCOUNT SOFTWARE



from M.J.C. SUPPLIES

DISC GAMES

Batman	11.95
Colossus Mah Jong	11.95
Colossus 4 Chess	11.95
Corruption	15.95
Cyberoid II	11.95
Dark Side	11.95
Driller	14.95
F15 Strike Eagle	11.95
Flight Ace	13.95
Fists and Throttles	11.95
Game Set and Match II	13.95
Giants	16.95
Gunship	14.95
Konami Arcade Collect	14.95
Lancelot	15.95
LED Storm	12.95
Live & Let Die	11.95
Magnificent Seven	14.95
Mickey Mouse	11.95
Monopoly	11.95
Nightraider	11.95
Operation Wolf	11.95
Pac Mania	11.95
Pacland	11.95
Pirates	14.95
Question Of Sport	17.95
Road Blasters	12.95
Robocop	11.95
Savage	11.95
Scrabble Deluxe	12.95
Six Pack III	11.95
Spitting Image	11.95
Superman	11.95
Supreme Challenge	12.95
Thunderblade	11.95
Time and Magik	11.95
Titan	11.95
Total Eclipse	11.95
Trivial Pursuits	16.95
Victory Road	11.95
Vindicator	11.95
WEC Le Mans	11.95
Chuck Yeager AFT	11.95

MJC SPECIAL:

War In Middle Earth
RRP £14.99 OURS £9.95
Offer Ends 30th April

EDUCATION

Animal Veg, Mineral	11.95
Answerback JNR Quiz	11.95
Factfile Arithmetic	7.95
Factfile Spelling	7.95
Factfile Sports	7.95
Fun School 2-5 years	7.95
Fun School 5-8 years	7.95
Fun School 8-12	7.95
Fun School II under 6 yrs	9.95
Fun School II 6-8 yrs	9.95
Fun School II over 8 yrs	9.95
World Wise	11.95

Note: Factfiles are question packs only and require the Answerback JNR Quiz.

DISC SERIOUS

Protect	19.95
Prospell	18.95
Promerge	18.95
Armor File	18.95
Armor Office Suite	26.95
Tasword 6128	19.50
Taspell	12.95
Tasprint	10.95
Tascopy	10.95
Tasdiary	10.95
Tassign 6128	23.95
Qualitas Plus	12.95
Qualitas Pica Font Pack	8.95
Qualitas Clarion Font Pack	8.95
Qualitas Newsroom Font Pack	8.95
Qualitas CPM + Utilities Disk	8.95
French Mistress	16.95
German Master	16.95
Spanish Tutor	16.95
Masterfile III Database	29.95
Mastercalc 128	25.95
Matrix Spreadsheet Plus	29.95
Stop Press Desktop Publishing	38.95
Extra Extra	19.95
Maxam (Assembler/Diss)	19.99
Poke Easy Plus	14.95
Mini Office II	15.95
Rodos Extra Disk	8.95

CPM BASED

Supercalc 2	39.95
Dr Graph	39.95
Dr Draw	39.95
Dr CBasic	35.95
Dr Pascal MT+	35.95
Armor C Compiler	38.95
Maxam II	38.95
Fortran	39.95
Nevada Cobol	39.95
Hisoft Devpac 80	39.95
Hisoft Pascal 80	39.95
Hisoft C Compiler	39.95
lankey 2 Finger Typing	19.95
lankey Crash Course	19.95

MJC SPECIAL

Protect CPM: including
Spellchecker & Mailmerge
RRP £59.95 OURS £39.95

CASSETTE BASED

Maxam 464	15.95
Protect 464	15.95
Tasword 464	15.95
German Master 464	14.95
French Mistress 464	14.95
Answerback JNR Quiz	8.95
Italian Tutor	14.95
Spanish Tutor	14.95

ALL ABOVE PRICES INCLUDE VAT, POSTAGE & PACKING IN THE U.K.
THE ABOVE SOFTWARE IS ONLY FOR THE AMSTRAD CPC RANGE

ACCESSORIES

Multiface II Plus	42.95
Printer Lead 1M	8.95
Printer Lead 1.5M	9.95
Printer Lead 2.0M	10.95
3" Disc Cleaner	6.95
Amstrad RS232 Interface	55.95
Mono Screen filter	12.95
Colour Screen Filter	14.95
Comp Pro 5000 joystick	13.95
Quickshot Turbo Joystick	11.95
Cruiser Joystick	9.95
464 Monitor Ext Leads	6.95
6128 Monitor Ext Leads	7.95
1000 Fanfold Labels	5.95
Second Drive Lead	7.95
DKT 64K Memory Exp	44.95
AMX Mouse + Art Software	59.95
AMX Mouse + Stop Press	69.95
464 Dust Cover (Mono/Col)	7.95
6128 Dust cover (Mono/Col)	7.95
KDS 5 1/4" 800k, disc drive (state 464/6128)	149.95

BOOKS/MANUALS

Adv Amstrad Graphics	7.95
Mastering Machine Code	8.95
The Amstrad CPM+ Book	12.95
Programming the Z80	19.95

RIBBONS

Printer	Quantity	1	2	5
DMP 2000/2160	3.50	6.00	14.00	
Panasonic 1080/1081	3.95	7.00	16.00	
Citizen 120D	3.95	7.00	15.00	
Star LC10 (Black)	3.95	7.00	15.00	
Micro-P165/200	4.95	8.00	18.00	
Star LC10 Colour	5.95	11.00		
Genuine Amsoft CF2 Disc		x 5...12.00		
PLEASE CALL		x10...22.95		
FOR AVAILABILITY		x 20...42.95		

ROM BASED

Maxam	29.95
Maxam 1.5	22.95
Protect	29.95
BCPL	22.95
Utopia	22.95
Prospell	26.95
Promerge+	26.95
Rodos	28.95
Cage Rom (State which I/Face)	31.95
Rombo (if purchased with Rom)	28.95
KDS Rom Board (Holds 6)	24.95

Quali Pack

The Print Enhancement Package

Qualitas Plus
KDS 8 Bit Port
Display Font Pack
R.R.P £44.45

Package Price £34.95

CORNIX SOFTWARE

CARD INDEX: Easy to use filing system

CASS: 19.95

DISC: 24.95

SIMPLE ACCOUNTS: easy to use accounts ideal for small business includes VAT. CASS: 34.95

DISC: 39.95

JOB ESTIMATOR: useful tool for contractors. DISC: 39.95

PRODUCT COSTING: DISC: 39.95 Full specifications on all of the above programs on request.

PRINTERS

All printers listed have a ten inch (A4) carriage, are Epson compatible, and feature friction and tractor feed mechanisms for continuous or single sheet paper. All prices include the necessary cable

PANASONIC KXP - 1081

Offers all the draft mode text sizes of the D.M.P. 2160, but is better built, more reliable, and offers N.L.Q. in all sizes and effects, for only £10.00 extra! Highly recommended.
£169.95

STAR LC-10

As well built and reliable as the Panasonic. Has four N.L.Q. fonts (typefaces), in combination with all sizes and effects. New low prices makes it well worth considering
£195.95

STAR LC-10 COLOUR

All the features of the LC-10, but with a seven colour option for colourful text. If you want colour graphics please call first for advice.
£245.95

STAR LC 24-10

24 pin version of the LC-10. Has 5 excellent letter quality fonts available with all sizes and effects. Two extra effect, outline and shadow are also featured. Good value.
£319.95

Overseas Orders Welcome - Please write for details

WE ARE NOW IN OUR FIFTH YEAR OF SPECIALISING IN AMSTRAD MAIL ORDER, OUR POLICY IS TO PROVIDE THE WIDEST RANGE AT DISCOUNT PRICES WITH A FAST TURN AROUND TIME - TRY OUR SERVICES WITH CONFIDENCE

CALLERS WELCOME: Mon-Fri 9 to 5 Sat 10 to 4

PLEASE SEND CHEQUES/POs TO:

M.J.C SUPPLIES, (AA)

40a Queen Street, Hitchin, Herts. SG4 9TS.

Tel: (0462) 32897/420847 or 421415 for enquiries/Credit Card orders



AMSCENE

releases... updates... previews... new releases... updates... previews... new

Stop Press: Database come to the rescue

Database Software have purchased rights to the AMS range, including the highly rated *Stop Press* and *Extra! Extra!*

According to Chris Payne, Marketing Manager for Database, who already market the ever popular *Mini Office 2*, the move represents a vote of confidence in the CPC. 'Some companies have ended their love affair with the Amstrad' - you can say that again, Chris - 'Some companies have ended their love affair with the Amstrad,' he said, obligingly: 'but we certainly have not. These are excellent products and will perfectly complement our range.' Database may have been encouraged by the success of the educational package *Fun School 2*, which surprised everyone when it made an appearance in the software charts.

Art in the right place

The 'excellent products' involved are:

- three desktop publishing packages: *AMX Stop Press* (£49.99), *Stop Press* and mouse (£79.99),



● Chris Payne, Database Marketing Manager, with his latest acquisitions

and *Extra! Extra!* (£24.99);

- one graphics and art package, *ART* and mouse (£69.99), and

- one desktop environment utility, *MAX* (£19.99).

One product has died: *AMX 3D Zicon*, a 3D modelling program. Nick Pearson of AMS admitted to AA that it 'wasn't as strong selling as either the mice or *Stop Press*, and production has now ceased.' Database have confirmed that they have no plans for the title.

Growing trend

AMS's mother company Logitech, who incidentally claim to be the world's

largest manufacturer of computer mice, are moving up-market into the PC world, where software can cost in the hundreds of pounds and no-one wonders why, and are clearly pleased to be rid of the AMS range. What has been avoided in this instance, however, is the complete abandonment of product. For Database evidently see potential in the range. They have secured exclusive manufacturing rights, meaning that they can produce more copies of a program if it sells well.

Mike Cowley (Database's PR man) has hopes for the future of the AMS range: 'We're not going to increase the prices,' he said, 'and we're going to repackage

MAX so that it makes a stronger impression.'

This transfer of rights to programs looks to be a growing trend. In the games field it has happened since the dawn of time, of course, with licences to full price games being bought up by budget or compilation specialists. But it is beginning to happen more often with serious software, too: in AA42 we revealed that EEC had bought the rights from Rainbird to the *Advanced Art Studio* range, and there are moves afoot for person or persons unknown to do the same for the *Advanced Music System*. There's obvious commercial advantage in this approach, for as companies move into different markets others can move to absorb unsold stock and even revitalise product that has grown stale.

Database Software are on ☎0625 878888.

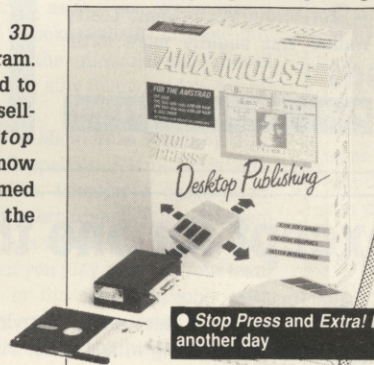

● *Stop Press* and *Extra! Extra!* - live to fight another day

Now it's Amstrad (lights, camera) action!

A new video software magazine has been launched, giving games players the opportunity to see all the new game releases without having to buy them.

'Action Screenplay' is to be published by Hot Shot every other month in VHS format at £6.49, and combines many special audio-visual effects creating a 'mini-movie' lasting between half and three quarters of an hour.

It will feature a presenter who will introduce each individual game category and commentate while each game runs on-screen.

The magazine is the brain-wave of Hot Shot supremo Jon Beales, who told AA: 'It's some-

thing I've been waiting for, but which has taken so long in coming I've had to go out and do it myself!

'Film fans can watch *Film '89*' he went on, 'but what do we computer games players do to find out just how good a game is? AA is just the best mag around for CPC reviews, but even then you can't actually see a game in action. Now, with "Action Screenplay," you can!' (He only said that bit about AA because he knew we'd make it up if he didn't.)

The first issue, available from all good software retailers in the UK, is out on April 28th.

For more details, Hot

Shots are on ☎ 0206 751217.

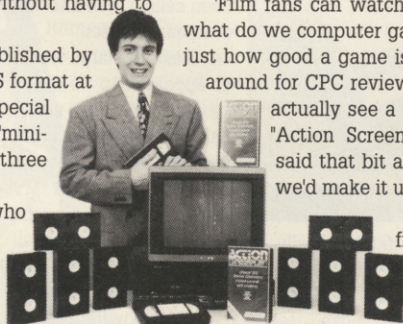

● Hot Shot boss Jon Beales shows off issue one of 'Action Screenplay,' out now

The only way is up!

Figures released by the Audit Bureau of Circulation show *Amstrad Action's* readership continuing to increase. In the six months July-December 1988 - the latest period for which statistics are available - average monthly sales climbed from 35,095 to 38,457, a rise of about 9.5%.

AA's publisher Greg Ingham of Future Publishing explains the boom: 'It's quite clear that AA reaches parts other mags don't.'

'Consistently high quality, fierce independence and a real understanding of what readers want - it's an unbeatable combination!'

Magnum gets go ahead to make Amstrad's day

Amstrad and Virgin/Mastertronic have announced that a light gun package, called the Magnum, is to appear soon. Initially it is aimed (if you'll pardon the pun) primarily at

the gun, which is expected to retail at £29.99. Five have been finished, and Virgin/Mastertronic are currently trying to get more

coming. 'The deal is now well under way. We've got a working proto-

type, and have been testing all the games on it. Amstrad are tooling up to start full scale manufacture in the coming months: people should be able to buy a Magnum

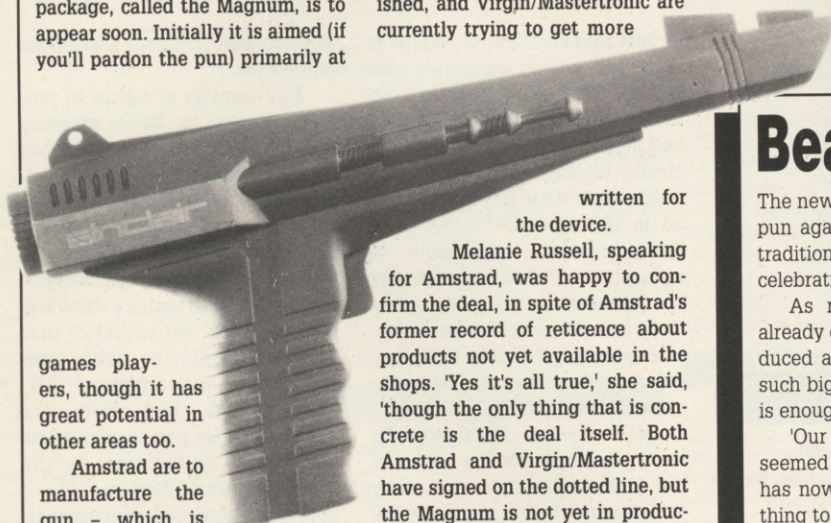

games players, though it has great potential in other areas too.

Amstrad are to manufacture the gun - which is similar to, but not compatible with, the Sega light gun - under the Amstrad/Fidelity label, while Virgin/Mastertronic are to market the gun exclusively.

Six games are included with

written for the device.

Melanie Russell, speaking for Amstrad, was happy to confirm the deal, in spite of Amstrad's former record of reticence about products not yet available in the shops. 'Yes it's all true,' she said, 'though the only thing that is concrete is the deal itself. Both Amstrad and Virgin/Mastertronic have signed on the dotted line, but the Magnum is not yet in production.'

For Virgin/Mastertronic Lesley Walker was slightly more forth-

● Above: the Magnum - coming soon!

Beaten to the draw

The news of the Magnum lightgun is a shot in the arm ('scuse the pun again) for the CPC games market as it moves towards the traditional lazy hazy dog-days of summer. It's not such a cause for celebration, though, at Electric Studio Limited.

As reported exclusively in AA42, Dave Buckingham had already come up with the idea for a light gun, and had in fact produced a working prototype. The mere news of a deal between such big players as Virgin/Mastertronic and Amstrad themselves is enough to scupper his plans.

'Our problem was getting games written for it - nobody seemed interested,' a crestfallen Buckingham told us. 'The project has now been shelved. It was always going to be a risk, something to try - but not with Amstrad competing against us. All our products are built in the UK, but with Amstrad's Far Eastern production lines and sheer muscle power we haven't got a cat in hell's chance. Perhaps if we'd got it out quicker, we might have had a winner. But not now.'

Nice printer, except for one thing...

Mannesmann Tally, makers of the MT81 printer (praised in AA43) have announced the MT222, a 24 pin offering print quality far superior to the 'average' 9 pin printer.

At a rrp of £695 ex vat - with some retailers selling it at £495 - it's medium priced, but has a higher rated speed than most, even allowing for the large dosage of salt necessary for such figures. Its claimed speed of 72 cps in letter quality mode compares favourably with the 30 characters of the Amstrad LQ 3500.

The bad news is that, for the time being at least, you can't actually buy one. MT UK (☎0734 788111) have put the printer on

'technical hold,' which means that strictly speaking it's unfit for sale. Peter Pratt of their UK sales team explained that the situation became apparent about mid-March: 'about one in 20 were unusable. Rather than tarnish our reputation, we decided to contact our parent company in Germany and get a permanent solu-

tion sorted out.'

'Meanwhile I'm trying to trace them. We are resupplying with MT230s, which have a higher specification. One problem we're having to confront is that people just won't let go of their new MT222s.'

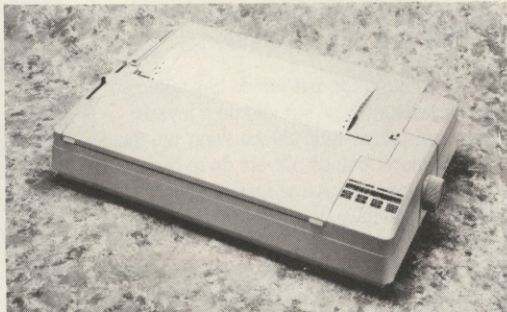

● Mannesmann's latest awaits a clean bill of health

'The trouble,' according to MT spokesman Chris Hewitt, 'is that the UK has higher standards than many countries. It's been selling well into the overseas markets.'

At least one large retailer appeared to be taken by surprise by the news, having already sent out promotional material advertising the new MT printer. Still, since the

company didn't actually have any in stock it was all rather academic. (Far be it from us to wonder why anyone should advertise hardware that's not in stock.)

MT have moved fast to protect a growing reputation, and as soon as trouble free samples are available we shall be rushing you the full review.

High flier

The lucky winner of the fabulous Microprose 'Don't Tell The Editor' competition back in AA42 is Krystyna Gibbons, of Bargoed in Mid Glamorgan. Krystyna wins a day out at Microprose HQ in Tetbury, together with all sorts of goodies and things. She also has to take a flight in the Microprose Piper Cherokee with a very nervous and pale ed, but then we all have our cross to bear. Hard luck Krystyna. Look out for pictures of him trying not to look scared to death soon!

The ten runners up who will all be receiving a 'simulator bundle' of *Gunship*, *F15* and *Silent Service* are: Ahtisham Khan, M. Halfpenny, Lyndon Bosworth, Franco Difato, Kerry Muckart, R. Alonzo, Mark Swettenham, Leon Condon, Jason Boulton and P. Green. Well done all, and commiserations to the 750 (estimate) unlucky losers.

Boot up your CPC!

As a whole league of soccer sims arrives, those whose ambition is to score against Brazil (or, in England's case, against anyone) can live out their dream.

Let's kick off with *Gary Lineker's Hot-Shot*, based on the golden booted one's adventures at an international footie tournament. The title has nothing to do with hepatitis injections (which the Saint reckons cost our lad a yard of pace), but recreates those glory glory days when Gazza actually used to score.

It's viewed from overhead and includes those all-important sliding tackles among its features.

We've played an incomplete version and enjoyed it enormously (Trent won, dammit).

A man once known as 'Crazy Horse,' but has more recently earned the nickname 'prat' due to his showing (off) on *Question of Sport*, has also got in on the game licencing act. *Emlyn Hughes International Soccer* hits the streets soon, courtesy of Audiogenic. It

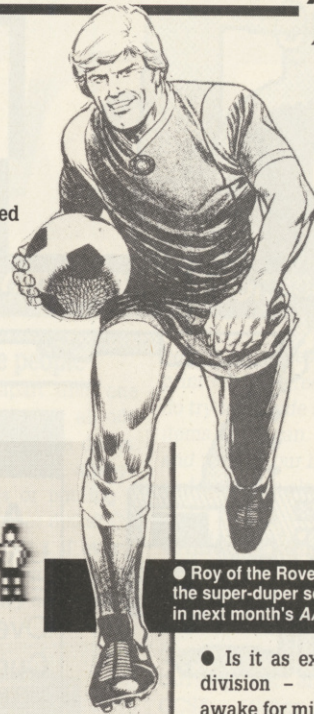

to play the game for you.

So next issue watch out for an in-depth probing report on football and the CPC:

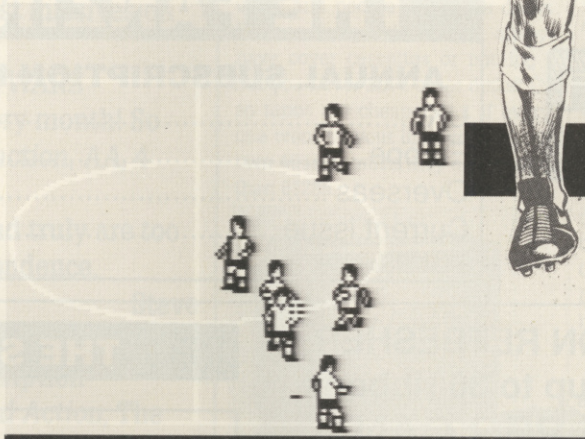

● Roy of the Rovers says: look out for the super-duper soccer sims survey - in next month's AA!

● Is it as exciting as the first division - or can you stay awake for minutes at a time?

● Which is the greatest footie sim ever seen on a green screen?

● Plus all you could ever want to know about the new soccer signings to the CPC team.

Don't miss it, or you could be as sick as a parrot!

Get your skates on!

Electronic Arts don surf punk gear and set the challenge: *Skate or Die*. You're about be taken on courses of training and tests which include high jumps, aerobatics and a hair-raising charge down a back alley to name but a few. The EA people were kind enough to show us an early version, and it's looking good, though of course the really crucial thing is the gameplay, which is not yet complete. You can do it guys, we know you can!

We'll let you know how hot their wheels really are next month.

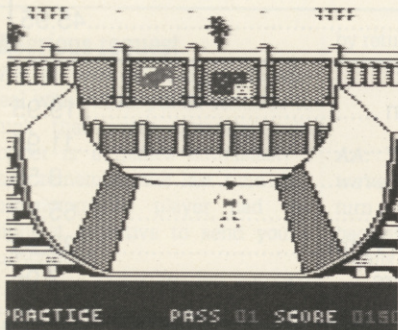

● A sneak preview of EA's *Skate or Die*

● Crazy Horse's *International Soccer* is featured in next month's round-up

takes a *Matchday II* (AA28 86%) approach with a view from the stands as it were. We've seen a demo version and it looks realistic, fast and fun. All that's missing are the inflatables and cries of 'I say, this ref is a jolly silly fellow, and so say all of us, hurrah!'

And there's more! *Microprose Soccer* by, erm, Microprose, and Zeppelin's *Kenny Dalglish's Soccer Manager*. The Microprose game deals with yet another International Tourne where your choice of team is reflected in the skill level of your players. So if you play as Brazil your team can curl the ball in the air and dribble with exceptional skill; if you play as Oman you have only basic abilities; and if you play as England you're lucky to get your boots laced up by half-time. The Laconic One's game, however, takes the more managerial approach: you pick teams

Snot in front of the children

What's green, loud and makes a horrible mess on the carpet? A Gilbert. Well not just any old Gilbert, but the Gilbert from Drill, star of *Get Fresh* and Gilbert's *Fridge*. Now the world's most disgusting TV presenter (even worse than Cilla) is about to splat onto your computer screen!

Gilbert - Escape from Drill features the lil' darling in his bid to find a way back to Earth for the next series of *Get Fresh* (why?). His fellow aliens want to stop him, and the only way he can escape is to play five arcade games and win! So watch the skies, wait - and for goodness sake *blow your nose!*

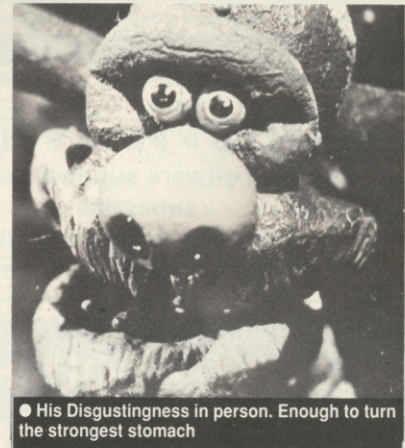

● His Disgustingness in person. Enough to turn the strongest stomach

Run the world

Remember *Run The Gauntlet*? It was a TV show where international teams competed in a series of races using high powered toys such jet skis and dune buggies, making everyone green (and not just with jealousy). Soon we'll all have a chance to join in the fun, with a new game in the offing from Ocean.

R the G is a multiple event game featuring a wide selection of vehicle races on land, water and occasionally even foot. Fancy such a life of danger? Dip into the next AA (available Thursday 11 May from all good newsagents - order yours now!) where it we give it the full treatment.



● You're just about to *Run the Gauntlet*

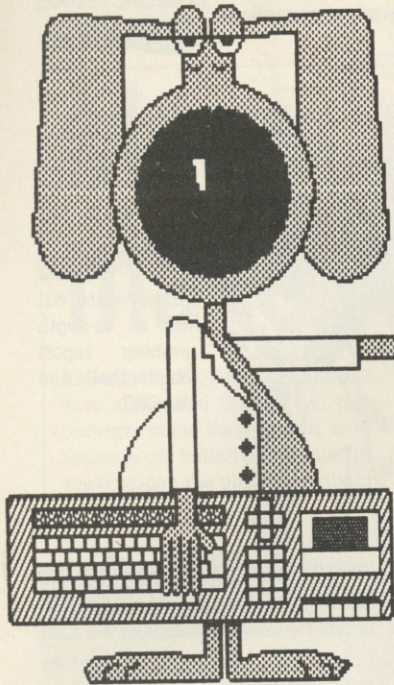

WACCI

unbeatable prices, unbeatable service

THE FANZINE

ANNUAL SUBSCRIPTION RATES

UK.....	£15.00
Europe	£22.50
Overseas	£30.00
Current issue	£1.25

- * Fully illustrated
- * Over 20,000 words per month
- * Proper A4 format

Letters, Basic, Comms, Mcode, Hardware projects and much more.

— A truly —
— Alternative —
— Fanzine —

CASPELL RIBBON REFRESHER
An 8oz can does up to 30 ribbons
ONLY £7.95 PER CAN

THE PUBLIC DOMAIN SOFTWARE

CPM DISC 1 – MACHINE CODE TOOLS Price £5.50

Z80 and 8080 assemblers, Z80 to 8080 to Z80 code translator, Debugging monitor and assembler, Reverse assembler, Binary file comparer, plus NewSweep and more.

CPM DISC 2 – COMPUTER LANGUAGES Price £5.50

Small-C, Prolog, Lisp, EBasic, Small-C-Interpreter plus NewSweep.

CPM DISC 3 – FILE AND DISC MANAGEMENT Price £5.50

Library utilities, Disc quality checker, Unix GREP command, PCW disc reader, Disc sector editor, Text file sorter, Word counter, plus NewSweep and more.

CPM DISC 4 – AT YOUR LEISURE Price £5.50

Cave Adventure, Chess, Othello, Golf, Word search, Biorhythms, Maze generator, On-screen calculator, Prolog, Comms utility, plus NewSweep and more.

CPM DISC 5 – THE BUSINESS Price £5.50

Scrivener spreadsheet, Inventory database, Powerful text editor, Spelling checker with dictionary, Sorter, Word counter, Comms utility, plus NewSweep and more.

CPM DISC 6 and 7 – PASCAL PLUS (Two Discs) Price £9.00

Pascal, SCI, Cobol, EBasic, Powerful text editor, plus NewSweep.

CPM DISC 8 – MORE COMPUTER LANGUAGES Price £5.50

Forth, Stoic, Cobol, Expert 86, Powerful text editor, plus NewSweep

CPM DISC 9 – COMMUNICATIONS Price £5.50

Mex, Kermit, Kermod, Interface and Smart-Modem, overlays, source code, plus NewSweep and more.

PLUS * PLUS * PLUS * PLUS * PLUS
Public Domain software support available to WACCI subscribers.

Mega-big homegrown library
Send a large SAE for details.

THE SPECIAL OFFERS

Rombo Rom Box.....	27.00
VIDI-CPC digitiser	68.00
5 x CF2 discs	12.95
10 x CF2 discs	23.95
20 x CF2 discs	45.95

Micro Music Creator Rom	19.95
Micro Music Creator Disc	11.95
Ram Delta Joystick	8.50
Ram TV Tuner/receiver	65.95
Ram 6128 Speech Synth Rom.....	39.95
Kador Seal 'n' Type covers.....	7.95

MasterCalc 128	24.95
MasterFile III.....	29.95
Mastercalc AND Masterfile	49.95

Protex (CP/M+)	47.00
Pocket Protex (CP/M+)	23.25
Protex Office.....	27.25
Protex Filer	19.50
Maxam 2 (CP/M+)	39.00
BCPL (CP/M+)	19.50
Arnor C (CP/M+)	39.00

WACCI UK, 9 SOUTH CLOSE, TWICKENHAM, MIDDX TW2 5JE
Est. 1986 — Phone 01-898 1090



REACTION

Three pages positively overflowing with reader complaint and comment

Dear readers,
It's time for another assault on your correspondence, as the ed rips open your latest missives on matters CPC.

Remember too there's a £15 SOFTWARE VOUCHER for one lucky winner every month! So get scribbling - or printing - to: *Reaction*, AA, 4 Queen St, Bath BA1 1EJ.

But no SAEs, please: we really and truly are too busy to reply personally to correspondence.

Steve
AA

PS Address all mail order and subscription enquiries to: *Special Offers*, *Amstrad Action*, The Old Barn, Somerton, Somerset TA11 7PY. We can only pass on your letters, changes of address and so on, to them.

● Serious request

Why, oh why do your people who deal with subscriptions continue to think that every potential subscriber is a games enthusiast? I can't remember the last time that the non-games player had the slightest incentive to send you a subscription.

So how about offering a binder in lieu of a game? Make me that offer and I'll send you a subscription

by return!!

H N Gubby
York, Yorkshire

AA: You'll be glad to hear that we've now rectified this situation: turn to our Mail Order pages at the back of this and every issue for full details of the great AA £20 vouchers offer, free with every subscription! We look forward to receiving your details very soon...

● Is this bloke trying to be funny or what?

I enjoy getting your excellent magazine, and am full of admiration for the technical quality of the articles. Could you give us some details on how Pat got his knowledge of computers?

Mike Davis
Mayland

AA: Pat's unbelievable knowledge (well, I never believe a word he says!) comes from The Ladybird Book of Computing, together with something he read in the Sun.

Seriously though, Pat's first experience of computers was the good old ZX81 ('but I never owned one!' he insists). He read every single computer mag on the market (and never bought any!), and all the books, and talked to loads of 'techies'; went to some computer shows, was on schools computers incessantly; hung around a Technical College for two and a half years; and it was only then he was ready for the Ladybird book.

After reading AA1 he burst through the door and demanded a job. Lo and behold he got one - on AA33! (He did, however, write on and off for the mag from AA4). Moral: make a nuisance of yourself!

● Pleasing all the people

Your mag is great apart from one thing. You seem to favour all 464 users and people with tape decks. For one thing, why do you always have cover cassettes or nothing - but you never have cover disks? OK so tapes are cheaper, but if everyone went by your line we would all own 464s because they are cheaper than 6128s.



● 464: unfairly favoured, claims Mr Melody of Purley. Not so, we say

And why, in your subscription offers, do disk users get only a free game but tape users get a free game and another goodie?

In Cheat Mode why are most of the pokes on tape? You may just say go and buy a tape recorder, but I know from my experience with a BBC that tapes always get these nice little messages like 'Rewind Tape' or 'Bad program' which really put me off.

So just for a change, give us a cover disk.

Robert Melody
West Purley

AA: Love to Robert, love to. But how many people would pay an extra couple of quid for their copy of AA? The answer, unfortunately, is 'not enough'. And in any case, as you'll know if you've seen Amscene recently, getting hold of any 3" disks these days is difficult - how hard would it be, do you think, to lay your hands on 50,000?

And as you yourself point out, Robert, we should be fair to all readers, both 464 and 664/6128 owners. Disk drive owners can add a cassette recorder and save our cover tapes to disk; but tape owners can do nothing with a disk except sell it.

As for most of Cheat Mode

being tape pokes: we can only print what we receive, though we do try to include as many disk items as we can. But point taken, and we'll do our best to keep you and everyone else satisfied.

● Information on the line

Please could you send me some information about any computer databases that are available to the general public and/or schools. I am carrying out an assignment for GCSE Office Studies and Information Processing and would be very grateful for any help that you could possibly give me.

I have enclosed a stamped addressed envelope for your reply.

Kathryn Dickinson
Hitchin

AA: You'll notice, Kathryn, that we didn't use your SAE. Instead we're giving the answer to 38,000 readers. Much as we'd love to, we just can't reply personally to all your letters - we have a mag to get out! So please, no SAEs, and if you've sent one and not had a reply don't take it personally. We wish we could, but we can't so we won't.

Now to your request. In the first instance turn to our new, improved now-washes-whiter Buyers Guide; and if you need more info, try the back issues referred to there. There will be a feature before too long on the merits of the various databases, but first I've got to persuade Pat to write it!

● Not at all soft

All right, so I'm slow. I've only just realised that I haven't seen an ad for the famous firmware manual for at least a month now.

Being married with three kids and a house to look after, finding £20 to, as the wife puts it, 'buy a book about the innards of your gadget' is difficult to say the least. Anyway, I eventually conned - I mean, convinced - the Mrs that it was absolutely vital and what happens, Alan Sugar lets the stocks run out and doesn't plan a reprint.

What's he playing at? I mean, we've all done a lot for this geezer, for instance, making him rich! Let's

● **Football! Footbaaaall!**

After being so rudely interrupted on page 13 in AA41 (by Sugarman of all people!), would you please do the honour of printing my name and full (and new) address, so that other *Matchday II* players can contact me (and maybe meet for a match).

My new record score in a short game is (modesty fails me) 9-0.

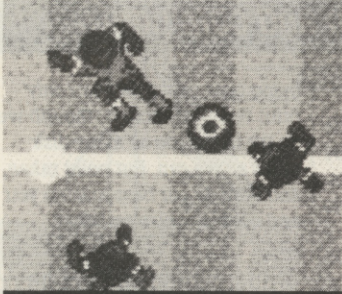

● Microprose's *Soccer* – one of several coming soon. Next month's AA sorts out the champs from the chumps

As a consolation prize not only are we printing your latest boast, we're also planning a mega soccer special for next month. We'll be reviewing at least three new footie games for the CPC, and looking in depth at the history of the genre.

Does that satisfy, Chris?

Chris Kinsella
56 Agar Rd
Queens Drive, West Derby
Liverpool L11 8NQ
☎ 061 445 8111 ext 3659
(daytime only)

AA: Apologies Chris, for Sugarman's bad manners – but what can you expect? This time we've tried to place your letter at a safe distance from him.

As a consolation prize not only are we printing your latest boast, we're also planning a mega soccer special for next month. We'll be reviewing at least three new footie games for the CPC, and looking in depth at the history of the genre.

● **War! What is it good for? Well, business for a start**

While reading AA42 I saw you were talking about war again with the emphasis on again. You keep on promising to stop talking about war but I don't believe you. I feel quite sorry for Mr Smith (*Reaction*, AA41)!

Anyhow, having read all this war junk I thought, 'Well, let's look at the reviews.' I nearly screamed, only three of your reviews didn't have much to do with war.

But it's not just a one off thing – it's every month. Come on you guys is that the only language you talk? Now I expect it's my turn to get slagged off by you and the readers, but I don't care. Obviously filling a magazine with war sells games otherwise you wouldn't be doing it and I expect that you will keep on doing it because if you ignore an adult you won't take any notice of a child like me!

Yours tried-hardingly,

James Hardy (age 11)

Wantage, Oxon

AA: I think you're being unfair, James. We hardly 'ignored' Mr Smith: much to the annoyance of those readers who wrote to complain, we printed not just one but two of his long letters in one issue, and another, shorter one the following month. Now we're printing yours.

As far as the main subject of your letter goes, we're not trying to 'sell games' as you suggest, but review them. We review what appears, much of which is based on war, fighting and other forms of immature male behaviour. Personally I find most wargame scenarios tedious, though I

have to admire the skill with which the games are programmed.

But the Oceans, US Golds and Microproses of this world hardly care what I think: it's what the games playing CPC users of this country think that matters. If significant numbers of our 38,000 readers buy such games, the software houses will continue to make them. They are not in the business of educating their public, but of making money by giving them what they want.

The question, I suppose, is whether people buy such games because they like them, or because that's what is available.



● Are people who play at war sick individuals or harmless gamers?

do a bit of arithmetic. The fabulous AA is read by about 38,000 of us. Now, if half of us bought a 464 and modulator at say £180, and the other half bought a 6128 and colour monitor at about £360 that would mean that at a very conservative estimate we've donated £9,450,000 to the make Sugar rich fund.

Sure it's not all profit, but he doesn't wear Co-op suits or drive a C5 does he? Shouldn't he repay our faith in his products with a bit more support?

Kane Guy
Gillingham, Kent

AA: Depends what you mean by 'should,' Kane. After all, if you're just suggesting that he do something nice for all those people who so kindly bought his computers then yes, absolutely. But on the other hand, Mr Sugar didn't get where he is today by running a charitable trust, and if it doesn't pay then why on earth should he

pour money into reprinting the firmware manual?

That, of course, would be his argument. Mine would be that so many people seem to be trying to locate copies and complaining when they can't, that it would actually be to Amstrad's financial advantage to offer this form of support for the CPC, besides being good public relations.

● **Some of us are looking at the stars**

I am writing to you for information concerning astronomy software for the CPC 6128, particularly aimed at the beginner.

I would also like to contact other users who use their CPC for astronomy purposes. Is there a weather satellite interface for the CPC, if so who supplies it?

I would be very grateful for any help and information you can supply. It seems to be difficult getting information concerning Astronomy and computers linked together. Maybe some of your readers can help. Thank you for your cooperation.

Mr G Dunbar
Belfast

AA: It's a mystery to me, Mr Dunbar, why there aren't many more. There was a program in the Triptych Brainpower series, which was marketed by Amsoft and which is now unfortunately defunct. You may find one second-hand or in the remainders rack of some less up to date shops.

There is a French 6128 program



... AND IN HERE'S OUR CPC MUSIC PROGRAMMER

● Dave Rogers tells it like it is on page 20

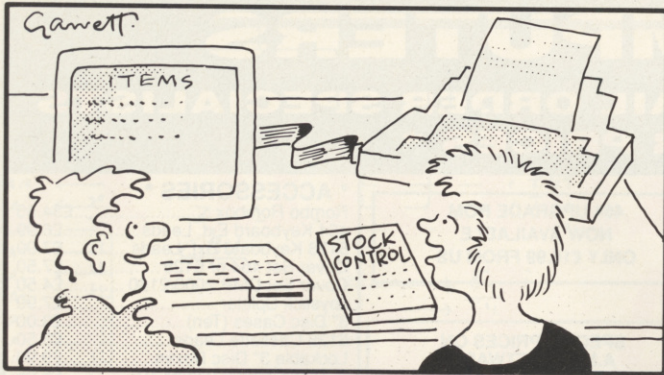

"WE USE IT TO KEEP ACCOUNT OF HOW MANY STOCK CONTROL SYSTEMS WE HAVE"

Well, not quite. Steve Williams reviews the second CPC stock control program on page 26

entitled Astro 2001 Planetarium, available from Semaphore France, Cernex - 740350 Cruseilles ☐ 50 44 02 91.

Unfortunately though it's 325F (that's over £30), and postage is extra on top of that!

As for the weather satellite interface, Microlink did at one time, but then stopped. When we hear more we'll pass it on through Amscene.

And then there was Solar System, a program on the AA40 cover tape (copies available from our Mail Order section: look at the back of this issue).

● This guy has a big problem

I am thirteen and own a CPC 464. I study Latin at school, but I am having difficulties getting to grips with many parts of the language. Is there any program available that can help me?

Trenton is an acid cool dude. Give him a ten year contract, and double his salary. Or else.

I am working on a hack to access NATO computers, disable all manual override, and to nuke Russia. Can you please help me to achieve this by giving me the Access code to NATO computers? Would Sugarman stop a full scale nuclear war if the hack worked? Speaking of Sugarman, how about doing a 1990 calendar of him? I am sure this would be very popular. Act normally, we are watching you.

J Barclay
Guernsey, Channel Islands

● A load of old coddlers

- You asked for it! Ten new Dizzy rotten egg games.....
- 1 Dizzy on a Bike - B M Eggs Simulator
 - 2 Fergie and Dizzy - The Grand Old Duke of York
 - 3 Tir Na (Egg) Nog
 - 4 Dizzy and the Roasted Aliens (Egg and Baked Beings!)
 - 5 Dizzy goes Poaching - A Load of Coddlers
 - 6 Dizzy Heights - Chuckie Egg-er's Advanced Flight Trainer
 - 7 Dizzy goes Salmon Fishing (the Egg and Salmon Ella)
 - 8 Dizzy's forthcoming Hot Weekend - thank God it's Fried-egg
 - 9 Big-mouthed Dizzy - Total Egg-lips (featuring Free-Range Escape)
 - 10 The Last Adventure (Game Ova)
- Hope you think these are eggshellent.

Kevin Patton
Hemel Hempstead



Exposed! Evil Olivers tried to bribe innocent AA staff

AA: Aargh no Kevin, stop, please - you get your tenner! By the way, shortly after that Fast Food review appeared we were privileged to receive the huge item pictured here. Of course we here at AA must be seen to be purer than pure, above the law, not open to bribes &c. So if whoever it was who sent us this clumsy attempted inducement would like to come and collect the wrapper (oh what a giveaway). Honestly, such open corruption makes us feel quite ill, burp...

AA: I knew there was something funny about this person. Accessing NATO computers, sure, I do it all the time - but Trenton? An acid cool dude? I can only suppose you've never seen him dancing to the theme tune from 'Neighbours.' By the way, we thought the calendar was an excellent idea. We've already mentioned it to Sarkar, Sugarman's agent, who's agreed in principle. Only thing is, he's so hugely expensive. Have you any idea how much it would cost to hire him for a whole year?

Sugarman

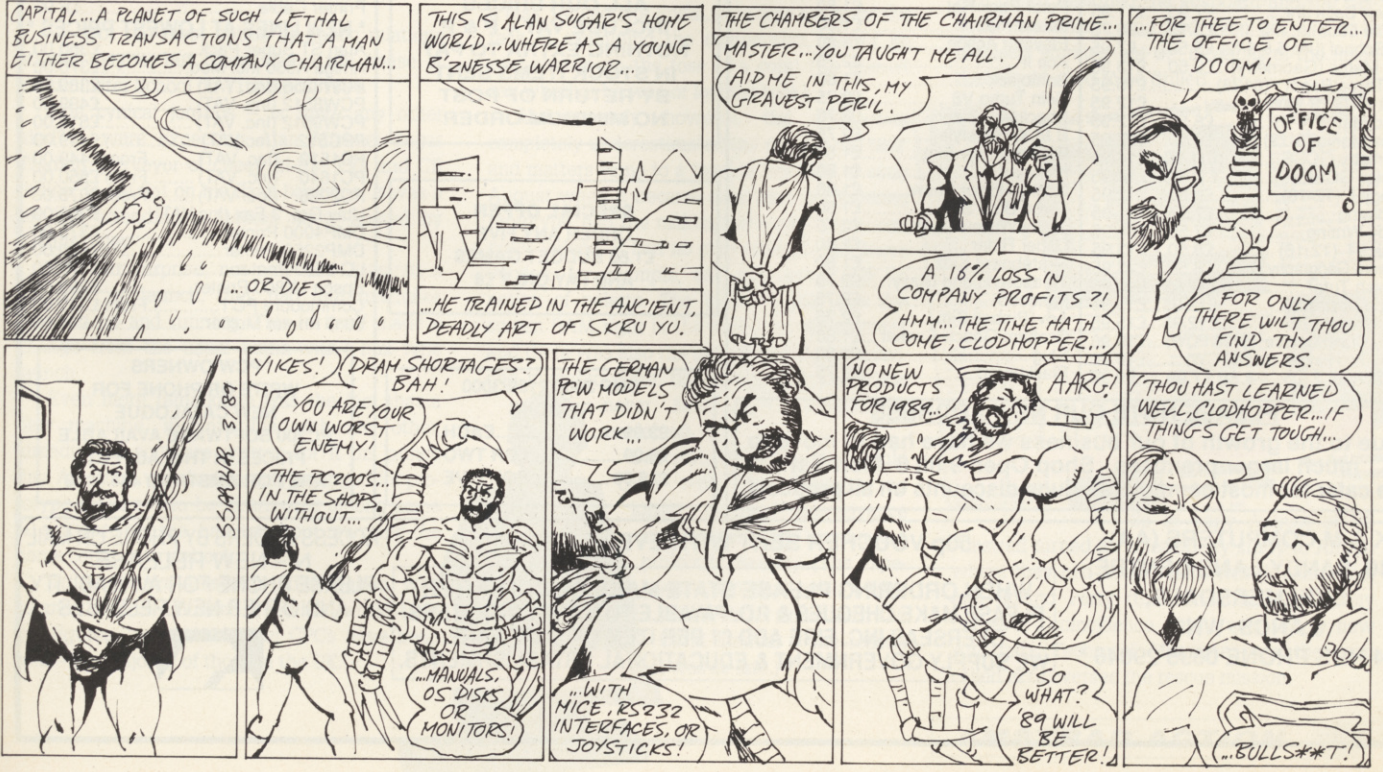

K & M COMPUTERS

THE LEADING AMSTRAD MAIL ORDER SPECIALISTS

* NEW LOWER PRICES *

* ADVENTURE * CASS DISC

Time and Magik	£11.25	£11.25
Gnome II: Ingrid's Back	£11.25	£14.75
Lancelot	£11.25	£14.75
Jinxter (6128)		£14.75
Corruption (6128)		£14.75
Return to Doom		£12.50
Not A Penny More	£11.25	£14.75
Mindfighter	£11.25	£14.75

* COMPILATIONS *

The In Crowd	£11.25	
History N The Making	£15.95	£21.50
Taito Coin-Op (Inc. Rastan)	£9.90	
Supreme Challenge (Inc. Elite)	£9.90	£13.10
Gold, Silver & Bronze	£11.25	£21.50
Giants	£10.50	£15.95
Flight Ace	£11.25	£13.95
Arcade Muscle	£10.50	£Phone
Command Performance	£7.75	£15.95
Frank Brunos Big Box	£9.90	£13.10
We Are The Champions	£7.75	£13.10
Fists N Throttles	£9.90	£13.10
Supreme Challenge (Inc Elite)	£9.90	£13.10
Computer Hits 5	£9.90	£13.10
Game, Set & Match II	£9.90	£13.10
Space Ace	£10.50	£11.25

* STRATEGY/SIMULATION *

Football Manager II	£7.75	£11.25
F.ball Man. II Expansion Kit	£6.25	£7.25
Football Director II		£14.75
Gunship	£11.25	£14.75
Ancient Battles		£11.25
Microprose Soccer	£11.25	£14.75
Times Of Lore	£7.75	£11.25
Chuck Yeagers Ad. Trainer	£7.75	£11.25
3D Pool	£7.75	£11.25
Bards Tale	£7.75	£11.25
Question Of Sport	£11.25	£14.75
Football Director (464)		£7.75
Roy Of The Rovers	£7.75	£11.25
Risk	£7.75	£11.25
War In Middle Earth	£7.75	£Phone
Heroes Of The Lance	£7.75	£15.90
Airborne Ranger	£11.25	£14.75
Trivial Pursuit (New Edition)	£11.25	£14.75
P.H.M. Pegasus	£7.75	£11.25
Track-Suit Manager	£7.75	£11.25
Laser Squad	£7.75	£11.25
4 Soccer Simulator	£7.75	£11.25
Archon Collection	£7.75	£11.25
Classic Games 4	£7.75	£11.25
Night Raider	£7.75	£11.25

* EDUCATIONAL *

Answer Back Jnr.	£7.95	£11.95
Factfile 500s	£3.75	£6.75
Fun School (US, 5-8, 8-12)	£5.50	£7.95
Maxi Maths (Geometry)	£8.50	£13.95
The Three Bears (6128)		£15.95
Giant Killer (9-14)		£12.95
Magic Maths (4-8)	£8.50	£12.95
Maths Mania (8-12)	£8.50	£12.95
Chemistry GCSE	£11.90	£14.95
Physics GCSE	£11.90	£14.95
Biology I (12-16)	£8.50	£12.95
Wordhang	£7.50	£11.95
Happy Writing	£7.50	£11.95
Physics I (12-16)	£8.50	£13.95
Mapwork Geography Quiz	£8.50	£13.95
Spanish Tutor	£12.95	£15.95
French Mistress	£12.95	£15.95
Italian Tutor	£12.95	£15.95
lankey Crash Course (6128/PCW)		£19.90
lankey Two Finger (6128/PCW)		£19.90
Fun School 2 (US, 6-8, 8+)	£7.99	£9.99

* ARCADE * CASS DISC

Operation Wolf	£7.75	£11.25
Last Ninja II	£9.99	£11.25
Run The Gauntlet	£7.75	£11.25
Double Dragon	£7.75	£11.25
Pacland	£7.75	£11.25
H.K.M.	£7.75	£11.25
Robocop	£7.75	£11.25
Rambo 3	£7.75	£11.25
StormLord	£7.75	£11.25
4x4 Off Road Racing	£7.75	£11.25
Dark Fusion	£7.75	£11.25
Road Blasters	£7.75	£11.25
Barbarian II	£7.75	£11.25
Game Over II	£7.75	£11.25
Total Eclipse	£7.75	£11.25
Crazy Cars II	£7.75	£11.25
1943 (Midway)	£7.75	£11.25
Afterburner	£7.75	£11.25
The Train	£7.75	£11.25
Munsters	£7.75	£11.25
WEC Le Mans	£7.75	£11.25
Led Storm	£7.75	£11.25
Vindicators	£7.75	£11.25
Netherworld		£7.75
Purple Saturn Day	£7.75	£11.25
Operation Neptune	£7.75	£11.25
Victory Road	£7.75	£11.25
Blasteroids	£7.75	£11.25
Batman (New)	£7.75	£11.25
Dragon Ninja	£7.75	£11.25
Superman	£7.75	£11.25
Captain Blood	£7.75	£11.25
Inc. Shrinking Sphere	£7.75	£11.25
Butcher Hill	£7.75	£11.25
Titan	£7.75	£11.25
Renegade III	£7.75	£11.25
Spitting Image	£7.75	£11.25
Dynamic Duo	£7.75	£11.25

* BUDGET * CASS ONLY

Spy Hunter	£2.75
Battleships	£1.80
Quest/ Golden Eggcup	£1.80
Split Personalities	£1.80
Frank Bruno Boxing	£1.80
International Speedway	£1.80
Trantor	£2.75
BMX Simulator II	£2.75
Fairlight	£1.80
Video Classics	£1.80
Formula Grand Prix	£1.80
A.T.V. Simulator	£2.75
Peter Pack Rat	£1.80
Scuba Kidz	£1.80
Elevator Action	£1.80
Ace II	£2.75
Bombjack	£1.80
Twin Turbo V8	£2.75
Shockway Rider	£2.75
B.M.X.Freestyle	£2.75
Beach Buggy Sim	£1.80
Kickstart II	£1.80
Rocky Horror Show	£1.80
Turbo Boat Sim	£1.80
Jockey Wilson Darts	£2.75
Glider Rider	£1.80
Skateboard Kidz	£1.80
Treasure Island Dizzy	£2.75
Fastfood	£2.75
Adv. Pinball Sim	£2.75
Graham Gooch Cricket	£1.80
Slug	£1.80
Blackbeard	£2.75

464 UPGRADE ROM
NOW AVAILABLE
ONLY £16.99 FROM US

SPECIAL PRICES ON A.M.S. SOFTWARE

StopPress	£39.95
StopPress & Mouse	£72.95
Mouse & Art	£61.95
Mouse Mats	\$4.95
Max	£16.95
Extra Extra	£21.95

KDS ELECTRONICS SPECIAL OFFERS

Rombox	£24.95
15 1/2 Second Drive	£158.95
18 Bit Pr. Port	£18.75
Serial Int. + Rom	£44.95
Printer T Switch	£24.95
Screen Master	£14.95
Ramdos (Disc)	£23.95
Romdos (Rom)	£27.95

KDS Modems are no longer available

MINI OFFICE II STILL OUR No 1 SELLER Cass. £11.25 Disc. £14.75

AMSOFT/MAXELL 3" DISCS

One	£2.50
Five	£12.50
Ten	£24.95
5 1/2 Discs	TEN £3.90
3 1/2 Discs	TEN £9.50

ROMANTIC ROBOT QUALITY PRODUCTS AT DISCOUNT PRICES

Insider	£13.95
Multiface II+	£44.95
Rodos (on rom)	£25.95
Rodos extra	£8.75

ALL OUR PRICES
INCLUDE VAT + P & P
NOTHING EXTRA TO PAY
IN STOCK ITEMS SENT
BY RETURN OF POST
NO MINIMUM ORDER

SPECIAL OFFER
ORDER ANY FIVE
£1.80 BUDGET GAMES
AND PAY ONLY £8

DMP 2000/2160/3000 RIBBONS	
£3.99	EACH
£6.99	FOR TWO
£15.50	FOR FIVE

* ACCESSORIES *

Rombox Rombox	£34.95
464 Keyboard Ext. Leads	£6.99
6128 Keyboard Ext. Leads	£7.99
Cover Set 464 or 6128	£7.50
Cover Set DMP 2000/2160	£4.50
Joystick Splitter	£7.99
3" Disc Cases (Ten)	£3.00
6128 Cassette Leads	£3.50
Lockable 3" Disc Boxes	£9.99
3" Disc Cabinet (Holds 10)	£5.95

* JOYSTICKS *

Amstrad JY2	£13.95
Cheetah Starfighter	£13.95
Konix Navigator	£13.95
Gunshot	£5.75
Delta (Microswitch)	£9.50
Cheetah 125 +	£7.95
Supercharger	£12.95
Cheetah Challenger	£4.75
Konix Autofire	£11.95
Konix Speedking	£9.99
Cruiser (Microswitch)	£9.50

* BUS/ UTIL * DISC

Mastercalc 128	£27.95
Qualitas +	£12.99
Masterfile III	£32.95
Plan-It	£14.75
Professional Adv. Writer	£24.95
Taspell	£13.95
Poke Easy Plus	£9.99 £14.99
Protex	£20.95
Prospell	£20.95
Promerge	£20.95
Protex Filer	£22.95
Protex CPM (Spell & Merge)	£50.95
Tasword 6128	£22.95
Personal Banking System	£23.95
Protex (on rom)	£32.50
Promerge + (on rom)	£29.95
Prospell (on rom)	£29.95

* HARDWARE ETC *

2160 Printer	£159.95
DDI Disc Drive	(Phone) £159.95
MP2 Modulators	(Phone) £29.95
FDI Second Drive	£99.95
64k Memory Expansion	£47.95
Screen Filter	£19.99
Surge Plugs	£12.50
Continuous Paper 2000	£16.50
Dk' T Colour TV Tuner	£72.95
464 Speech Synthesiser	£29.95
6128 Speech Synthesiser	£35.95
C15 Cassettes	45
Fanfold labels (1000)	£5.90
CPM+ (DISC)	(Phone) £18.95
PCW6128 Manual	£14.95
Printer Cable	£8.99

* NEW LINES AT LOWEST PRICES *

Atari ST Super Pack	£360.00
Amiga A500 Inc. Mod.	£370.00
PCW8256 (Inc. VAT)	£389.00
PCW8512 (Inc. VAT)	£499.00
PCW9512 (Inc. VAT)	£510.00
PPC512 (Inc. VAT)	£449.00
PC1512 (Inc. VAT)	From £449.00
PC1640 (Inc. VAT)	From £550.00
PC2086 (Inc. VAT)	From £675.00
Utax Grp. 3 Fax (Inc. VAT)	£999.00
DMP4000 Printer	£375.00
DMP3250 Printer	£220.00
LQ 3500 Printer	£375.00
Epson LX800 Printer	£299.00
Commodore PC 1	From £349.00
80 C Printer Muffler	£85.00

PCW OWNERS
WRITE OR PHONE FOR
NEW CATALOGUE
PC200 SOFTWARE AVAILABLE
PRICES IN THIS ADVERT
ARE FOR AMSTRAD 464/6128

PLEASE NOTE OUR NEW ADDRESS

Due to the growth of our business we have had to move to much larger premises. Shop Open 9 till 6 Mon-Sat We cater for most computers. Huge discounts on all products.

K & M COMPUTERS (AA),
140, SANDY LANE CENTRE,
SKELMERSDALE,
LANCS, WN8

* 24 HRS PHONE 0695 29046 *

50p VOUCHER SENT WITH EVERY ORDER

WHEN ORDERING PLEASE STATE MAKE OF COMPUTER.
PLEASE MAKE CHEQUES & P.O. PAYABLE TO K & M COMPUTERS.
OVERSEAS INC. EIRE ADD £1 PER ITEM OF SOFTWARE.
WE SUPPLY GOVERNMENT & EDUCATIONAL ESTABLISHMENTS.

ACCESS ORDERS BY PHONE OR MAIL
N = NEW RELEASE
PLEASE PHONE FOR AVAILABILITY
AND OTHER NEW RELEASES

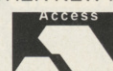

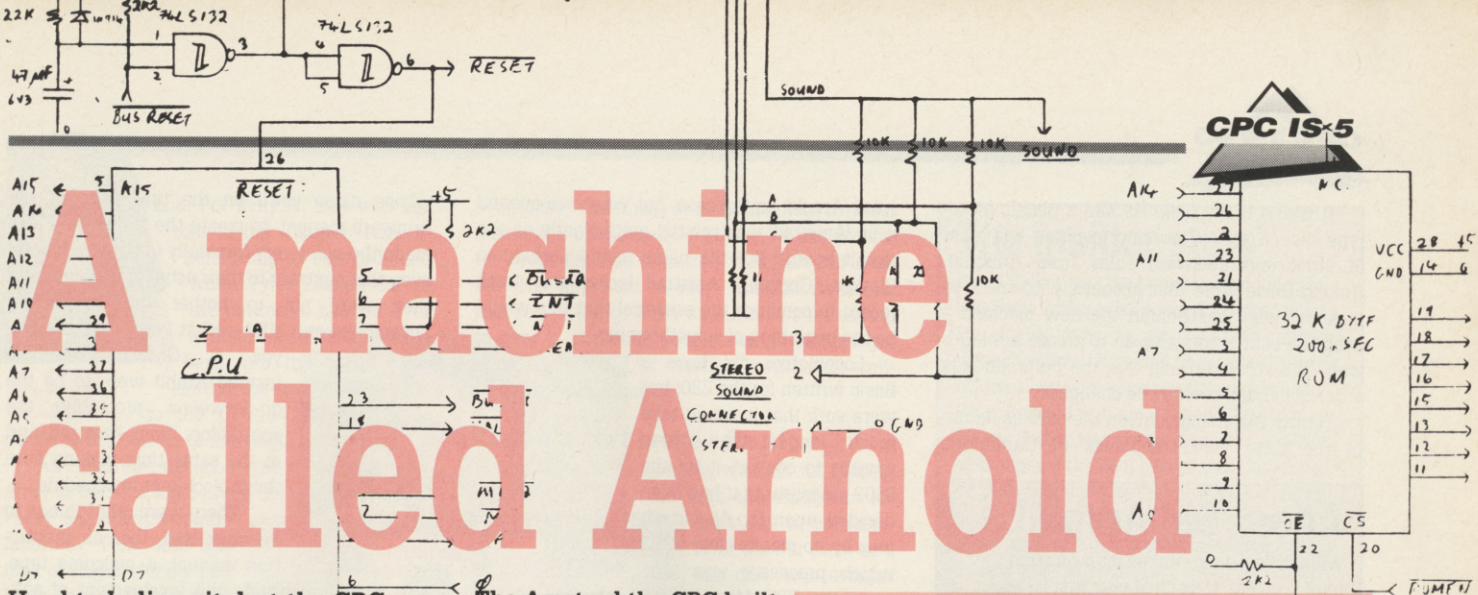

A machine called Arnold

Hard to believe it, but the CPC really is half a decade old. STEVE CAREY talks to the people who made Amstrad's very first computer.

Meet Einstein, Archimedes, William Shakespeare, Monet and Ravel, read the invitation. All of these famous namesakes, apparently, had something to say about Amstrad's 'really rather remarkable new computer.'



Chairman and Chief Executive Amstrad invites you to meet Messrs Einstein, Archimedes, William Shakespeare, Monet and Ravel, all of whom have something to say about Amstrad's really rather remarkable new computer. In The Great Hall, Westminster School, Dean's Yard, Westminster Abbey at 1.30pm on Thursday 12th April 1984

Welcome to the CPC!

Not the most subtle of public relations stunts, maybe, but there was a full house at Westminster School on 11th April, 1984.

The cynical journos - is there any other kind? - were expecting Alan Michael Sugar Trading, purveyor of cheap hi-fis, TVs and CB radios, to fall flat on his flash backside. It was a bit like attending a fashion show hosted by Arthur Daley.

To their surprise, not only had Amstrad a computer to launch, they had four machines present, up and running. This in itself made a change from the usual boffin-with-a-box type launch.

Even more remarkable was the fact that a new machine, incompatible with any other, already had software written for it on launch day. Amstrad, who had cannily arranged for prototype machines to be distributed among some 50 software houses, had set about rewriting the home computer rulebook.

To date, says Amstrad's Mike Walton, who seemed surprised himself when he'd worked out the figures, 'over two million CPCs have been sold - the majority of those in the UK.'

The Amstrad the CPC built

But a computer doesn't just appear and sell two million units: specifications must be drawn up, it has to be designed and built, and not least of all firmware and software have to be commissioned. This may not be a problem for Amstrad now, when they've done it half a dozen times before. When you're primarily a cheap hi-fi importer and box shifter, as Amstrad were in 1983, it's a different proposition altogether. This is the story of the CPC, the computer that Amstrad built - and which in turn built Amstrad.

It's not generally known that the CPC was originally contracted out to a team who never completed the project, and that furthermore in its early days was intended to be based around the 6502 chip rather than the Z80 we all know and love today. The idea for Amstrad's first computer project, in fact, was already formed by Easter of 1983, and with typical Sugar drive people were soon contracted to design a working prototype. This took a large leap of faith, for there was no one in Amstrad at the time with the technical knowledge to gauge the progress of such a task. Indeed Ivor Spital, who was assigned the task of examining the competition, claims he was chosen on the toss of a coin! (He doesn't say whether he won or lost the toss.)

Unfortunately, however, the contractors completely underestimated the scale of the task, and matters came to a head in late July or early August when it became clear that the 'working prototype' had the makings of a very poor computer indeed. It had no grey scales in the mono version, for example, and the colour had no notion of palette. The memory map had the screen RAM right in the middle of the memory, and there was also the bizarre mystery of a second microprocessor, the presence of which has never been very satisfactorily explained.

One member of the team could cope with the pressure no longer, returned the advance and disappeared, leaving the project in disarray. (The experience isn't that rare: it happened three times with the CP/M manual - one reason it was so late.)

Above: as much of Roger Hulley's original circuit design for the CPC464 as we're allowed to show

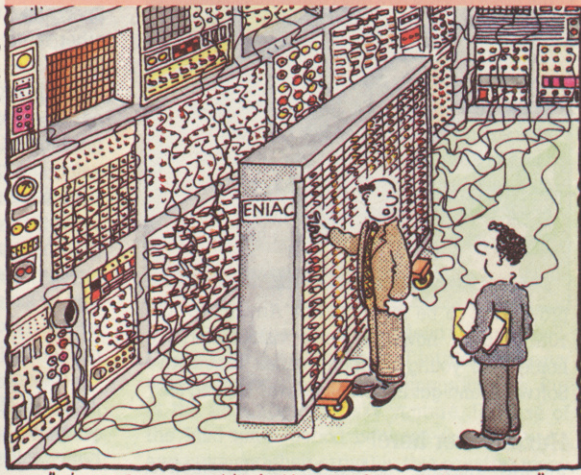

"I'll be glad when they bring out the CPC..."

This sudden departure may just possibly have had something to do with the fact that Sugar himself - a man not known for complacency on deadlines - was apparently in charge at this stage.

On the case

Meanwhile Amstrad themselves had been busy. They had the casing ready; they'd done the tooling; they'd designed the keyboard and the cassette mechanism; and had even got as far as precisely working out the locations of the holes that would need to be drilled.



Alan Sugar and friend

1984

Month	Tu	We	Th	Fr	Sa	Su
Jan	1	2	3	4	5	6
Feb	1	2	3	4	5	6
Mar	1	2	3	4	5	6
Apr	1	2	3	4	5	6
May	1	2	3	4	5	6
Jun	1	2	3	4	5	6
Jul	1	2	3	4	5	6
Aug	1	2	3	4	5	6
Sep	1	2	3	4	5	6
Oct	1	2	3	4	5	6
Nov	1	2	3	4	5	6
Dec	1	2	3	4	5	6

UK expels Libyans after embassy killing
US jazz band leader Count Basie dies
April '84: the dawning of the age of Arnold
South African Zola will run for Britain
Virus that causes HIV discovered

So in early August of '83 Amstrad turned for a feasibility study to Ambit, where they had dealt before with William Poel and Roland Perry (the similarity of company names is a coincidence, by the way). Perry, now Amstrad's Technical Manager, was the man called in to oversee the rescue mission.

Taken from Chronicle of the 20th Century, published by Longmans Chronicle at £29.95

It was a tricky task. He had a plastic prototype case, a 'sort of working machine' and a set of strict and awkward rules from Amstrad. Among these were that absolutely no-one was to know who was behind the new machine – even the contractors chosen to create the hardware and software; and that the parts, already ordered in bulk, couldn't be changed!

Hardly surprisingly, given the curious nature of the brief, two companies in Cambridge

Arise, 'Sir' Arnold!

William Poel, who worked with Amstrad until last year, is credited with first labelling Amstrad's new project as 'Arnold,' misleading some to associate this confidential 'large consumer electronics company' project with GEC, whose chairman was Sir Arnold Weinstock. 'Nobody even noticed it was an anagram of my name for months if not years afterwards,' claims Roland Perry. It came as much of a surprise to me as it did to anyone else – seriously! ('The 'Roland' games, however – *Roland on the Ropes*, *Roland in the Caves* and so on – are named after him.)

proved not to be interested in 'Arnold.' On the 10th August, however, Perry visited Dorking, home of a young company called Locomotive Software, and got the break he was looking for.

Hurrey over here!

Richard Clayton, co-founder of Locomotive, takes up the story. 'We first saw the hardware in August of '83,' he says, 'when Roland showed it to us in my front room. He had letrasetted the

word 'Arnold' on the case, but when we opened it up 'Amstrad' was printed quite clearly on the circuit board!' But the name meant nothing to Clayton. Certainly Amstrad lacked any track record to convince the sceptical that this would be the beginning of something big.

Locomotive did have a Basic written for the Z80, but were sure that it would take much longer than three months to convert it for the 6502 processor that had been decided upon for Arnold. (It was by no means clear in '83 which processor was winning: the BBC Micro, the Commodore 64 and the Apple were all 6502 based, while the Spectrum, the Computers Lynx and several other more obscure computers were using the Z80.)

So it came about that the CPC was recreated, in a rather roundabout way, as a Z80 machine. One project member recalls being at a party in the January of '84 and 'very naughtily' spilling the beans to an astonished competitor that not only had the task been started, it had actually already been completed. 'Z80?' he is said to have exclaimed: 'Nobody told us the bloody processor could be changed!'

Clayton called Mark-Eric Jones of MEJ Electronics, with whom he had worked in a company called Data-Recall, and Roger Hurrey, who came over to look at this early prototype. (Eventually Jones was to do the modifications to turn the design of the 464 into the 664 and 6128, and has since worked on the PCW and Amstrad's various PCs, while Hurrey has continued as a lone jobbing electronics engineer, winning the 1987 *Guardian* Innovation Challenge award. To this day there's a long standing, though fairly good-natured, dispute still running between Jones and Hurrey over who should have the credit over the work MEJ Electronics did on the Arnold project.)

The go between

Locomotive quoted what they thought a high price, but were enthusiastic, since one vital component – the case – had already been built. Believe it or not, this is the difficult and time-consuming aspect of creating a new computer: it takes about a year. By comparison the software and firmware aren't so time-consuming.

On August 17th a schedule was drawn up for the ROMming of the operating system. 'Those were the rules,' says Clayton. 'From early September onwards we had a whiteboard and each week we changed the number of weeks to go, so we knew exactly where we stood. Lo and behold, it went on the arranged day and it was ROMmed.'

The group commenced work in earnest, hiring Bruce Godden,

whose name you'll find on the title page of the firmware manual, to create the firmware. Perry made the point very forcefully to Amstrad, however, that contrary to their usual way of working they were not to bother the contractors Locomotive and MEJ – what Perry calls the 'See you at Gatwick' method. Instead Ambit were to be the go-betweens, protecting the contractors from Amstrad and at the same time making sure the project kept to schedule.

There were other things to be organised, too: an instruction manual, a welcome tape, and most importantly the involvement of software houses to provide games for this new and previously unheard-of machine. The aim was to have 20 games and 10 educational programs ready by launch day. This was William Poel's main task, as a front man with the gift of the gab to persuade all the software suppliers to write for a machine they'd never seen and only had Amstrad's assurance would ever be made, let alone that it would be successful.

One of the easier tasks was the firmware manual, given Locomotive's commendable habit of inserting large amounts of comment into their code. 'In particular,' says Clayton, 'we write a lot of comments at the front of each routine, saying what it's going to do, the registers it uses, which ones are corrupted and so on.' Even so it took Bruce Godden three months hard work to produce the finished manual. It's a tribute to Locomotive's work that Amstrad never had to pay out on their £50-a-bug offer.

The GAS man

The hardest part of the whole project, however, was getting the 50 pre-production units built – amazingly the pcb layout was complete by November – to be sent out to the software houses so they could work on games for the new computer. Perry hired Sally Tyler as an 'angel' to transport these prototypes to various locations at the dead of night and ensure their safe collec-



● Mark-Eric Jones

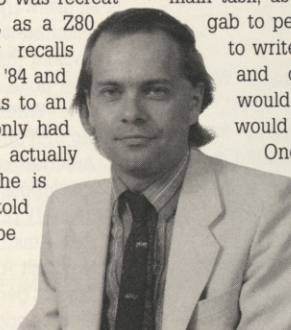

● Roland Perry

The making of the CPC

January 1983: idea of Amstrad's first home computer conceived

April: plastic mouldings designed and tooled
late July: original 6502-based working prototype delivered

August: new technical project management team appointed, led by Roland Perry.

(Note: the final specification is drawn up with Amstrad ten days after initial approach to Perry.)

10 August: Perry offers the project to Locomotive Software, Dorking. Over the next few days Locomotive and MEJ agree to take on project, and Amstrad agree to Z80-based machine

17 August: schedule drawn up
end of October: Locomotive see first Z80 working hardware

November: pcb layout complete
early December: first systems handed to software houses: instruction manual work commences (after completion of software, note!)

February 1984: Gate Array finished

April: All tooling and masks completed in time for CPC464 launch, Westminster School, London

11 April 1984: CPC464 launched, Westminster School, London

664: 'I'd be lynched!'

Perry's 664 sweatshirt has never been worn: 'I can't wear it in public or I'd be lynched!' he jokes. He claims he's still baffled at the failure of that project: 'We gave people exactly what they wanted, a computer with a disk drive in the same box – it's what Amstrad have always been good at. When it came out, something went horribly wrong, and everyone who bought one has cursed us ever since! I'm just totally perplexed.' Of course, what did upset the customers was the appearance very soon after of the 6128, leaving all those 664 owners feeling cheated.





● Richard Clayton

tion. For months, that was her role in life. Clayton remembers being at Perry's house when Tyler loomed out of the darkness, handed over a box – and disappeared back into the night! (She knitted the unique 'Welcome to the CPC464' jumper reproduced at the bottom of this page, by the way.)

An important decision was to create a gate array, a discrete logic board that could be more easily and cheaply manufactured. This was the task of Roger Hurrey (not Mark Jones, as has been mistakenly stated in some quarters), who set about creating the Gate Array Simulator, or GAS board as it was known. The original board was the same size as the entire pcb, giving the prototypes the appearance of a double-decker circuit board. (The CPC could have been made like this, but it would have added up to 50% to the final price.)

Go home and prepare for power up

Amstrad had no intension of launching a machine without software. Indeed they had the foresight to establish the official Amstrad User Club and the official Amstrad Computer User magazine – both of which helped to create an all-round environment for the new CPC owner.

Sugar was keen to press ahead with the project, despite the lack of contracts. According to Perry at the meeting revealing Amstrad as the instigators of this new machine Sugar told the software companies: 'Look, I want you to start work today, when you get home this evening. If,

eventually, something in the [unsigned] contract means the project can't continue, I'll pay you for the work done to date and we'll just call it all off.' His approach is very straightforward on that sort of thing,' Perry says, 'and it's refreshing to hear it. It means people can go off and get cracking, instead of waiting months for contracts to be exchanged.'

Even if it ain't broke – fix it!

A final date, 23rd January, was set for getting the finished prototype onto the aeroplane for departure to the factory in the Far East, and this date was eventually met – but not without a hitch. For when the people at Amstrad tried out the prototype and found that nothing happened when you pressed the cursor keys, they protested. People, they said, would think their machine was broken. The requested alteration was done over the weekend, with the final prototype flying off as planned on the Monday. And that, believe it or not, is why the cursor keys on your CPC work as they do, allowing you to input lines of Basic anywhere on the screen.

One last story: Sugar is said to have sat in front of this new machine, moved the cursor up to the top of the screen and carefully replaced the Locomotive copyright notice with a series of spaces. With a gruesome grin he quipped: 'It's almost like a game in itself!'

But what if...?

And that, more or less, is how the CPC came to be created. We know now, of course, that the CPC was an outstanding success, and looking



● Roger Hulley receives his Grauniad Young Inventor of the Year award

The insider story

David Collier was the brains behind the excellent Basic tutorial. It's so hard to forget what you already know,' he says, 'and then pretend to teach yourself it again!' He recalls sitting on his front lawn one autumn afternoon in 1984 when Roland Perry, an old friend, turned up in his car. Collier was sworn to secrecy, and Perry hauled out of the boot a large box. Collier had no idea for some time that it was an Amstrad project – 'which was just as well,' he says, 'since my own experience of the company was limited to a rather tatty car radio.' He felt that the project was as likely to push Amstrad's shares down as up, and decided not to risk it, only to watch them rise by a factor of ten in a year – on the strength of the 464! Another project member was bolder, and sank his entire life savings into Amstrad at 60p a share. Eighteen months later those same shares had gone up to some 900 pence per share.

'For reasons outside my control I had the experience of delivering eight weeks late on one part of that project,' Collier recalls: 'and after the phone call from Mr Sugar I don't know that I ever want to work for him again...'

back it's easy to see why. Indeed it is still selling, despite Amstrad's lack of interest in heavy advertising or attention-grabbing price cuts. But at the time it was a risky venture. Because of the 'lead time' (period between ordering parts and units and their arrival in this country) many thousands – perhaps as many as 100,000 – CPCs had to be ordered before the launch. So even if the thing had flopped badly Amstrad would have been stuck with a mountain of useless hardware. Just imagine what might have become of Amstrad had that happened... ●

Five more years? No reason why not, as the CPC keeps Galluping ahead

- Five years is a very long time in computing, and you'd naturally expect a range such as the CPC to be declining after half a decade on sale.
- Not a bit of it. All the available evidence suggests that it's doing very well, thank you, and that Amstrad would be daft to cease production now or even soon. There's nothing to indicate that Amstrad give a monkey's about fashion, only about what sells. And Mike Walton of Amstrad reckons the CPC sold over 2,000,000 to the end of last year: the three millionth CPC is not so very far away!
- The Gallup charts these days make interesting reading. CPC hardware and software sales both outweigh the Atari ST and Amiga by a factor of more than two to one, and on one recent software chart overtook the Commodore 64.
- All but a handful – three or four – of the All Formats Top 40 are released in an Amstrad version, suggesting that commercially it is still an important part of any major formats strategy.
- It is believed that the CPC sold more during the six months leading up to Christmas 1988 than during the comparable period of '87 – despite the fact that Comet had such a big price advantage over other stores that most didn't even try to compete.
- The 464 pcb has been redesigned, and some 6128 components integrated onto a custom chip – which hardly suggests that Amstrad is interested in

axeing the machines!

- There has been talk already that an autumn advertising offensive has been planned for the CPC in the crucial lead-up to Christmas '89. (Such a campaign was planned last year, it is said, but was abandoned because the machines were selling without the assistance of advertising! Doesn't sound like hard commercial sense to me, but there you go.)
- And though we're as always reluctant to blow our own trumpet (God forgive me for a liar), AA's latest readership figures covering the period July-December 1988 are up from 35,454 by very nearly 10 per cent.
- None of these facts gives any reason to suppose that the CPC is about to fade away.
- It might be interesting if Amstrad showed the bold business sense and determination that has made them Britain's biggest computer manufacturer, and boosted the CPC's image. How about a major advertising campaign, as frequently used for the PCW range, and a significant, official price-cut? It might seem odd to cut prices and run advertising for a product that appears capable of selling steadily without either. But all the evidence indicates that the CPC has considerable untapped potential.



● And finally: the original 'Arnold.' Artwork by Perry, from an original idea by Powell

! SPEEDTRANS PLUS - NOW EVEN FURTHER AHEAD OF ITS RIVALS !

SPEEDTRANS PLUS - 3

For CPC6128 (or 464/664 with DK Tronics 64K (or larger) Memory)
Once the program has been transferred to disc it will run on any CPC

Fully automatic - Just One Keypress * Only One Program To Run Which Finds The Speedlock Type Automatically * Transfers Many Original And Today's Speedlock Programs * No Meddling - Written With The Amateur In Mind * Automatic Disc Filenames * No Wasted Disc Space - Saves The Correct Amount Of Game Code * Saves 99% Of Opening Screens * Screens Saved In Their Correct Colours * Compresses Screen Code To Save Even More Disc Space * A Normal Data Format Disk Will Hold Six Standard Games. * Faster Loading Times From Disc Because Of Shorter File Lengths *

SPEEDTRANS handles all Speedlock types **Automatically**. No need to hold a key down at anytime during loading. **SPEEDTRANS** has only one program to run - no time wasting running several alternatives making transfers that do not work. **SPEEDTRANS** makes all transfers direct to your destination disc - does not need the **SPEEDTRANS** disc whilst working. **SPEEDTRANS** transfers more Speedlock protected programs to disc than any of its competitors. It also transfers ALL the speedlock protected programs we say it will - we make no unsubstantiated claims.

SPEEDTRANS transfers over 200 programs to Disc, some of the latest it will do are MADBALLS, FREDDY HARDEST (both games) BASKET MASTER, MATCHDAY II, PHANTOM CLUB, GRYZOR (main program) OUT RUN (main prog) SUPER HANG ON, ATV SIMULATOR, R TYPE, REVOLUTION (Including screen) in only 43K and SUPERHERO in only 48K compared with 61K when transferred with another Speedlock utility.

SPEEDTRANS is the only utility that will transfer Mutants 64K. **SPEEDTRANS** is the only utility that will transfer Revolution automatically without meddling. **SPEEDTRANS** saves 99% of opening screens in their full colours.

Added Utility To Dump Any Screen Saved With Speedtrans To Four Different Types of Printers.

SPEEDTRANS will transfer many other titles - some better known ones are:

All Titles From Konami's Coin-Op. Hits From Konami Arcade Collection: Nemesis - Jackal - Jailbreak
Summer Gold By US Gold: Dambusters - Beach Head II - 10th Frame - Bruce Lee - Impossible Mission. From They Sold A Million: Sabrewulf - Beach Head - Jet Set Willy - Daley Thompsons Decathlon. From They Sold A Million 3: Fighter Pilot - Ghostbusters - Daley Thompsons Decathlon

3D Starfighter, Ace Of Aces (Main Program), Acrojet, Advanced Pinball, Alien Highway, Arkonoid, Arkonoid 2, Revenge Of Doh (Main Program), Armageddon Man, Army Moves (1 & 2), ATV Simulator, Brain Clough's Fortunes, Barry McGuigans Boxing, Basket Master, Batman, Beach Head, Beach Head II, Black Magic-Both Parts, BMX Simulator, Bounty Bob, Bounty Bob Strikes Back, Brain Ache, Breakthru, Bruce Lee, Catch 23, Crystal Castles, Cluedo, Cobra (Stallone), Combat School, Copout, Cosmic Shock, Daley Thompsons Decathlon, Daley Thompsons Olympic Challenge (Main Program), Daley Thompsons Super Test, Dambusters, Dan Dare 2,

Desert Fox, Dizzy, Donkey Kong, Elektra Glide, Express Raider, Eye Spy, F15 Strike Eagle, Fighter Pilot, Football (Codemasters), Frankie Goes Hollywood, Freddy Hardest, Fruit Machine Simulator (Main Program), Galactic Games (Main Program), Galvan, Game Over (Both Parts), Ghostbusters, Goonies, Grand Prix Simulator, Green Beret, Gryzor (Main Program), Gynfight, Gyroscope, Hacker, Head Over Heels, Highlander, Highway Encounter, Hunchback II, Hypersports (Main Program), I Spy, Impossible Mission, Its A Knockout, Jackal (Compilation Ver), Jailbreak (Compilation Version), Jet Bike Simulator (Main Program), Jet Set Willy, Juggernaut, Killed Until Dead (Main

Program), Knight Games (Main Program), Knight Rider, Konami Golf, Kong Strikes Back, Kung Fu Master, Leaderboard, Leaderboard Tournament, Leaderboard Worldclass, Legend Of Kage, Leviathan (Main Program), Madballs, Mag Max, Mario Brothers, Match Point, Matchday, Matchday II, Metrocross, Miami Vice (Ocean), Mikie, Minder, Mindshadow, Mission Jupiter, Monopoly, Nemesis The Warlock, Never Ending Story (Main Program), Nigel Mansells Grand Prix (Main Program), Nomad, Out Of This World (Main Program), Outrun (Main Program), Phantom Club, Ping Pong, Platoon, Pro Ski Simulator, Pulsator, Race Against Time, Raid, Rambo First Blood II, Renegade (Imagine) (Main

Program), Rescue On Fractalus, Return To Oz, Revolution, Road Runner (Main Program), Rocco, Sabre Wulf (Later Version), Samantha Fox Poker, Saracen, Scalextric, Scrabble, Shadow Skimmer, Shao-lins Road, Short Circuit, Silent Service, Slain, Slapfight, Space Shuttle, Spy Trek, Street Hawk, Super Cycle (Main Program), Super Hang On, Super Hero, Super Stunt Man, Tenth Frame, Terrorlinos, The Great Escape, The Race Against Time, The Way Exploding Fist, Topgun, Transmuter, Tubaruba, Uchimata, V, Vampire, Vixen, Warlock, Winter Games, World Games (Main Program), World Series Baseball, Xarq, Xevious, Ye Ar Kung Fu, Zoids (Martech), Zorro and many more.

SPEEDTRANS is, without doubt, the best Speedlock transfer utility on the market today and is capable of transferring more Speedlock games to disc than any of its competitors. **TRY IT AND SEE FOR YOURSELF** UK £15.00 -- Europe £16.25 -- Rest Of The World £17.00 Upgrade your Speedtrans Disc - send your disc together with UK £3.00 - Europe £4.25 - Rest Of The World £5.00 Upgrade your Speedtrans Tape send your tape together with UK £12.00 - Europe £13.25 - Rest Of The World £14.00

* LOW LOW PRICES * ARNOR SOFTWARE * LOW LOW PRICES *

Program	UK - Disc		Europe - Disc		Rest of World - Disc	
	Disc	Eprom	Disc	Eprom	Disc	Eprom
PROTEXT OFFICE * NEW *	27.00	N/A	28.25	N/A	29.00	N/A
PROTEXT FILER * NEW *	19.00	N/A	20.25	N/A	21.00	N/A
PROTEXT	20.00	30.00	21.25	31.25	22.00	32.00
PROSPELL	19.00	27.00	20.25	28.25	21.00	29.00
PROMERGE (ROM=PROMERGE PLUS)	19.00	27.00	20.25	28.25	21.00	29.00
MAXAM * THE BEST! *	20.00	31.00	21.25	32.25	22.00	33.00
MAXAM 1 1/2 * NEW *	N/A	23.00	N/A	24.25	N/A	25.00
UTOPIA	N/A	23.00	N/A	24.25	N/A	25.00

DMP 2000/2160 PRINTERS

The printer buffer presently in the DMP 200/3000 series is a 2K RAM. Most of this RAM is used by the printer's operating system leaving an average 1/2K as buffer space. Our upgrade kit contains a new static RAM chip which will increase the printer buffer by 6K (about 4 pages of text). This upgrade allows all Download Characters to be re-defined allowing the user to design special characters for use with scientific and other programs. The kit is supplied with full pictorial instructions to allow the amateur to carry out his own modification (the DMP2160 takes about 7 minutes). If you don't think you are up to it your local TV shop can do the job in approximately 15 minutes
UK £14.50 - EUROPE £15.75 - R. of W. £16.50

FIRETRANS

This utility will transfer a number of FIREBIRD programs from tape to disc automatically including most opening screens in full colour. FIRETRANS will work equally well from tape but will be more convenient to use if converted to disc with SAMSON/Transmat. It will transfer WILLOW PATTERN, RUNESTONE, CHIMERA, GUNSTAR, PARABOLA, REALM, SPIKY HAROLD, BOOTY, DON'T PANIC, GUNFRIHT, STARGLIDER, NINJA MASTER, HELICOPTER, and some version of THRUST, HARVEY HEADBANGER and BOMBS CARE.
TAPE:- UK £5.00 - EUROPE £6.25 R. of W. £7.00
DISC:- UK £8.50 - EUROPE £9.75 - R. of W. £10.50

COMPACTOR

COMPACTOR will allow you to load a standard 17K screen, set the mode, border and ink colours and then save it as a compressed screen containing its own mode and ink colour information. Most screens compact down to an average of 9K which is an enormous saving on disc space. Loading time of compressed screens is also proportionately reduced.
TAPE:- UK £5.00 - EUROPE £6.25 R. of W. £7.00
DISC:- UK £8.50 - EUROPE £9.75 - R. of W. £10.50

NIRVANA

Have you tried backing up your original expensive disc software and failed? Use NIRVANA before its too late! NIRVANA (meaning enlightenment) is an extremely powerful disc handling utility which has the following features: Disc to disc back-up copier which will handle most of the commercially protected discs available today. File copier for individual files. Disc formatter, much easier to use than CPM. Change file attributes. Erase files. Change filenames. Will handle all disc drive combinations
DISC:- UK £14.99 - EUROPE £16.25 - R. of W. £17.00

UTILITY DISC No. 1

This utility disc contains 5 programs, all menu driven. They are SAMSON, TRANSIT, QCLONE, VIEWTEXT and the fast disc FORMATTER.
DISC:- UK £15.50 - EUROPE £16.75 - R. of W. £17.50
ROM:- UK £17.25 - EUROPE £18.50 - R. of W. £19.25

SAMSON

SAMSON has been developed by us to transfer not only the normal programs but also many of today's where the code is much longer. SAMSON differs in many ways from other Tape-to-Disc utilities, the main differences being: * SAMSON retains original file suffixes (SAMSON.SCN will be saved as SAMSON.SCN) * Improved file relocation method * Elaborate Tape-read/Disc-write system which reduces Tape Motor, Slave Replay and Disc Drive Motor wear substantially. * A large reduction in tape transfer time is also achieved in all but a few cases * NEW "SPLIT" option for today's longer games (we will be using this option in future routines) * All file information is displayed on screen and can be echoed to your printer if needed. SAMSON also transfer itself to disc.
TAPE:- UK £7.50 - EUROPE £8.75 - R. of W. £9.50
DISC:- UK £11.50 - EUROPE £12.75 - R. of W. £13.50

CHARACTER DESIGNER

(All CPC's)

- * REDEFINE YOUR PRINTER DOWNLOAD CHARACTERS
- * REDEFINE THE COMPUTER SCREEN FONT
- * REDEFINE ANY/ALL KEYBOARD KEYS (ASWERTY)
- * DESIGN SPECIAL SCIENTIFIC CHARACTERS/FONTS

Takes all the hard work out of character designing making it a pleasure. The printer part of the program will only work if your printer is capable of DOWNLOADING and is EPSON compatible - see your printer manual. Works with 7-bit or 8-bit output (8-bit port). All the designing is done "On-Screen" so you can see exactly what you are doing. You can save your newly designed characters to disc and reload them at any time into a basic program and into most Word-Processors. The program also allows the user to redefine any or all of the keys on the keyboard. This feature will be useful for those who require an ASWERTY keyboard. The disc also contains twelve sample fonts for experimentation
TAPE:- UK £7.99 EUROPE £9.25 - R. of W. £10.00
DISC:- UK £11.99 - EUROPE £13.25 - R. of W. £14.00

Please send your cheque (£ Sterling) Eurocheque or UK P.O. to:
GOLDMARK SYSTEMS, 51 COMET ROAD, HATFIELD, HERTS
AL10 0SY ENGLAND

Please write or telephone 07072 71529
for full brochure on our many other tape to disc products

Desert island disks*

Sticking his neck right out, STEVE CAREY selects the software – games and otherwise – he'd take with him and his CPC to a desert island. (We're assuming there's mains power, by the way.)

We can't be held responsible, however, for the old fool's choices.

It's one of the classic games: pick the records, books – or people! – you'd want to accompany you to this hypothetical desert island. The CPC version is just the same, except that you're picking software. The rules are simple. You have to choose ten, which must contain four serious

* and tapes, of course. AA doesn't discriminate against 464 owners – we just thought it was a nice headline!

items, including a word processor and a database. The rest is up to you!

Cast away all your cares!

Of course this is all completely subjective, indeed that's part of the fun.

I've already got Pat and Trent looking over my shoulder and exclaiming things like, 'What! No Wizzywangers! You'd go to a desert island without Wizzywangers! You must be off your chump!' and so on. (I let them talk to me this way – it's cheaper than paying them.) ●

Games I couldn't possibly live without

1. Bobsleigh (Digital Integration; £9.95; £14.95)

This was a Mastergame (AA29), and quite deservedly so. Sickening fast, but with enough strategy involved to keep you playing even after you get totalled for the tenth time.

2. Boulderdash (Prism; £2.99)

The granddaddy of them all, and selected primarily for nostalgic reasons. Things may have moved on a bit since Rockford's debut, but still worth packing just for the memories.

3. Chuck Yeager (Electronic Arts; £8.95; £14.95)

The best flight sim there is. For sheer excitement, variety and entertainment this is it as far as I'm concerned.

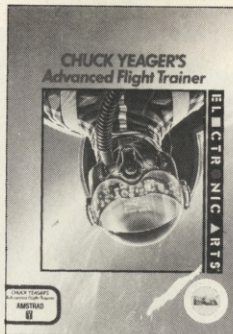

4. Cybernoid (Hewson; £9.99; £14.99)

No collection would be complete without something from the brilliant Raff Cecco, and until Stormlords appears this is the one for me.

5. Driller (Incentive; £14.95; £17.95)

I could have picked any of the three Freescape games that have appeared so far – the others, Dark Side and Total Eclipse, were also Mastergames – but I chose this one because it was the first. So irritating, though, trying to find those **** sectors!

6. Matchday II (Ocean; £8.95; £14.95)

Although there's a whole spate of soccer sims coming out soon, I doubt if anything will touch Ocean's football classic. Simply brilliant.



But seriously, folks...

1. Protext – on ROM, naturally! (Arnor = 0733 239011; £39.95 on ROM, £19.95 tape, £26.95 disk)

We use Arnor's tried and tested word processor to write AA on, so perhaps I'm biased, but then again you've got to admire a wp that's miles faster than anything even on a PC. And how often do you need a file longer than 38K (the maximum on ROM) anyway?

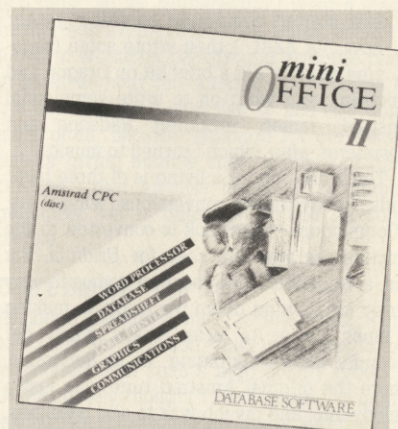

2. Mini Office II (Database = 051 357 2961; £14.95, £19.95)

As much for nostalgia reasons as anything else. This was the first piece of CPC software I ever tried out, and I've loved it ever since. So what if it's a bit rough at the corners?

3. Protext Filer (Arnor = 0733 239011; £34.95, disk only)

I've got well over a thousand books I've always wanted to sort out properly, and – assuming I can take them to this desert island! – Filer is just the job. Bit slow, agreed, but easy to use. (The alternative would be the excellent Info-Script from Brunning, but since I've already decided on Protext I'll stick with this choice, thank you very much.)

4. Advanced Art Studio (EEC = 0753 888866; £24.95)

I've always wanted to get my pathetic drawing ability up to scratch, and AAS is quite simply the best CPC art package I've used.

● And now, of course, it's your turn! We'll give a prize for the best or most amusing list. Send it to: Desert Island Disks, AA, 4 Queen St, Bath BA1 1EJ.

Sound advice

Game music soundtracks - love 'em or loathe 'em, you can't get 'em out of your head. But who writes them? And how?

DAVE ROGERS - who has programmed sound for Hewson Consultants on such games such as *Nebulus*, *Cyberoid 2* and *Stormlord* (coming soon) - tells all.

I first started computing on (*all together now...*) a ZX81. I then wrote some magazine articles, did a brief bit on Dragon and Spectrum, and went on to write commercial Amstrad games, including *Radzone* and *Biospheres*, after which I turned to music.

The work I do for a living is of three basic kinds. Firstly there's conversions, where, say, a Commodore soundtrack is converted to the Amstrad, as was the case for *Uridium*. For this, a vari-speed tape recorder comes in very handy for slowing down the original, making it much easier to hear what's going on! Secondly there's upgrading, as in *Ranarama*, where the original Amstrad tune was just a melody line, and my job was to add basslines, harmonies and other bits and pieces to make a fuller sounding

pairs:

- 231,N Use envelope number 'N' for volume, N=0 to 127
- 233,N Use envelope N for noise modulation
- 238,N Change Key (N=12 would raise key an octave)
- 241,N Play random note, duration N
- 244,N Set interval. N=0 use pitch envelope. N>0 rapidly alternate between two pitches 'N' apart. Allows 3 chans to give impression of playing up to a 6 note chord.

singles:

- 101 to 116 Add noise, pitch 0 to 30
- 128 to 228 Notes in special compressed format (!)
- 254 End of block, repeat from start
- 255 End of block, silence and stop

● Bytes with values above 100 are used to signify special functions: here's a few examples. (Hackers note: the above values vary wildly between versions!)

ST version.

Thirdly, and most often, I write my own music and sound FX from scratch, as in *Zynaps*, *Cyberoid*, etc.

High-tech, low-tech

I have a Korg DW8000 digital synthesiser, but it's rather misleading for composing

phonic-Casiotone (if it sounds good on that, it can only get better on the Amstrad!).

Despite the limitation, a good composition on the AY chip is just as valid musically as one for say the violin or guitar. The information content is comparable.

Plagiarism rules

Most readers would be surprised at how little communication there is between the game programmer and the sound person. It's usually a matter of a few 'phone calls, but in one or two cases I've neither seen, spoken to, nor heard of the bloke doing the game, and have worked from a typed list of required sounds, together with a really helpful and informative scenario such as 'it's a shoot-em-up!'

I hear of some programmers dashing things off in a few hours or so, but not me. I take weeks. I make everything ten times more difficult for myself by rejecting anything that sounds obvious or predictable, - which is totally wrong of course, because that's exactly what most software houses want, something that's instantly recognizable (plagiarism rules!).

My own style tends to sound a bit odd at first and may take a few listens to get into, but Hewson saw its potential, and the reviewers so far seem to have agreed with him (I'll probably get a really rotten review next time for saying that!).

Thanks for the memory!

For the Amstrad version of a game I'm usually given between 2 and 4k of memory to play with. However, before I so much as write a note there are overheads of 1.2K in the shape

on, since it tends to make any old handfuls of notes sound quite impressive. But transfer exactly those same notes onto the Amstrad's AY chip (whose technical spec. looks somewhat better than it actually sounds) and it usually comes out sounding pretty feeble. I find it better therefore to compose on the Amstrad itself, on a guitar, or on my little-old-mono

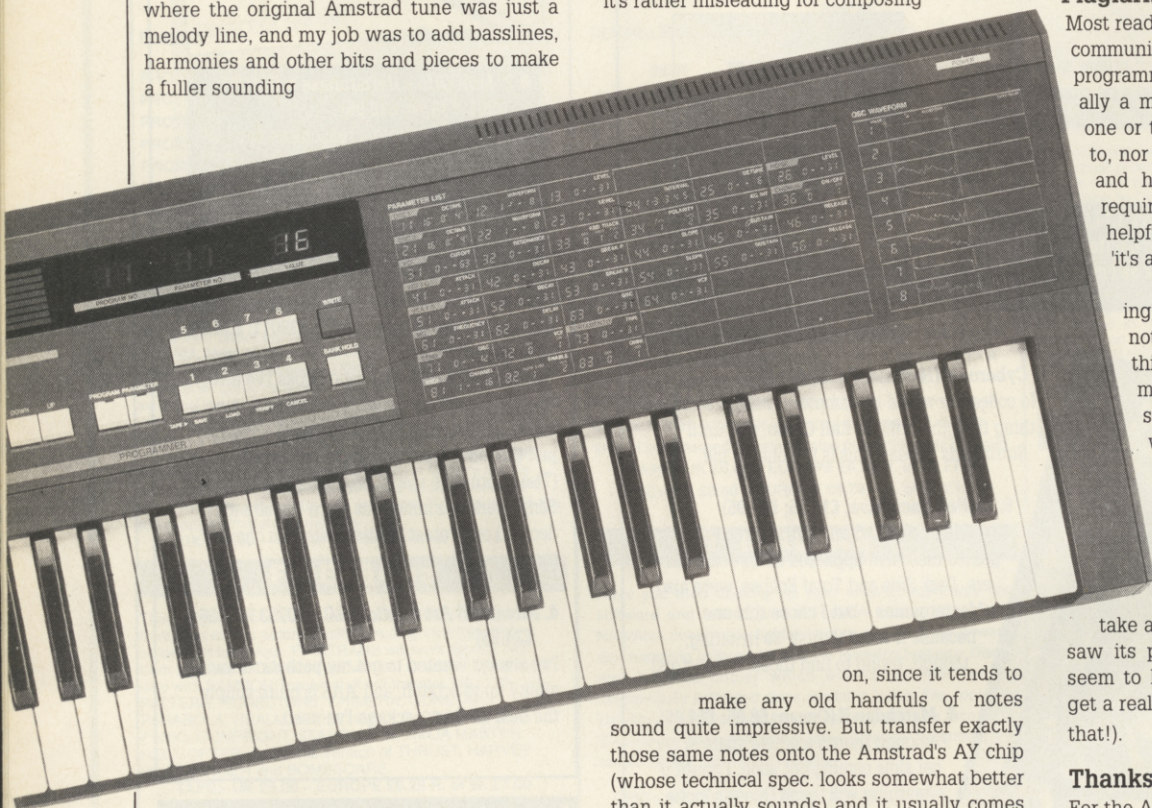

of the driver routine (900 bytes), the pitchable (200 bytes) and index tables for envelopes (work it out yourself).

The driver code is assembled using *Maxam*, and works roughly like this. Each channel has a pointer moving through data blocks. Each byte-pair it encounters is interpreted as Note plus Duration. Zero means a pause, 10 to 100 represent notes from bottom F to top C. Duration is in 1/50ths of



• Dave Rogers

a second, or 1/25ths in the case of games like *Marauder* where it is tied to the frame rate. Bytes with values above 100 are used to signify special functions, a few of which are shown in the box.

In practice of course I don't see any of these numbers, since things are entered as *Ab*, *Env10*, *Int12*, etc, and interpreted by my compiler.

For the main tune, the pointers start off in a Conductor Block which, as the name suggests, 'conducts' all the rest by calling sub-

blocks, or 'bits of tune.' This allows some parts to be repeated but with different envelopes, keys and so on, thereby adding variety and lengthening the music without eating up too much memory. Saving memory is paramount. A bass line may even be recycled elsewhere but shifted up by say an octave-and-a-fifth to form a harmony!

Sound FX and jingles share the same system, but also have channel-marker bytes at the start of their data blocks. A value of 1, 2, or 3 simply means start the effect on that channel, but 4 means 'pick alternately chan 1 or 2', and 5 means 'try and use chan 1, but if busy then use chan 2, as last resort use chan 3'. Markers 6 to 9 invoke other more intelligent algorithms. All this is to allow as many sound FX as possible to overlay at the same time.

In *Cybernoid 2* for example, if the continuous music is selected, then all FX default to channel 3, cutting off the least important component of the

tune for a while ('restarts' in the conductor block bring this back in again at appropriate times). If the music is off, however, the FX automatically spread themselves across all 3 channels to give a fuller sound.

In the amazing, everything-happening-at-once, near-chaos of *Cybernoid 2* this system is worked to its limit. In fact I'm surprised it doesn't get tied up in knots. (This game, by the way, gets my vote as best ever, and is the sort of game I would love to have written myself.)

Priority markers prevent important FX from being cut off by lesser ones. So in *Stormlord*, for example, 'pick up fairy' has a higher priority than 'player fires,' but not as high as 'Game over' which must be able to override anything that happens to be going on at the instant the game ends.

If there is going to be a continuous in-game tune then I think a music on/off option is a must, so for *Netherworld* I went a stage further and arranged that the music could be faded to whatever background level the player liked without this affecting the volume of the sound-FX. I would like to see this done more often, because although FX are essential for giving audible cues, a non-stop tune can get irritating after hours of continuous gameplay, yet is missed if turned off completely.

Don't believe the hype

Although freelance, most of my sound work has been for Hewson, and it is nice to be associated with such a high quality product. Unfortunately though, I see depressing parallels between the software charts and the pop music and TV-ratings charts, in that they consist mostly of hyped-up mediocrity, while a lot of really good stuff never makes it. I mean, if there were any justice in the world, then a) Peter Gabriel would beat (or preferably beat up) Rick Astley, b) Horizon would out-rate Brookside, and c) *Cybernoid* would out-sell *Out-run!*

Still, I do what I can to strike a blow for good taste - the rest is up to you, the customers. It's a great life and I really enjoy what I do, but I hope now you don't think it's as easy a job as it seems at first sight! ●

GENERAL

```

PUSH IX
POP HL
LD D, (IX+ENV)
LD E, (IX+ENV)
INC HL
LD A, (DE)
SUB HL, A
LD C, 128
RET NZ
LD HL, A
INC DE
LD A, (DE)
LD C, A
INC DE
INC HL
INC HL
LD A, (DE)
SUB HL, A
RET NZ
LD HL, A
INC DE
LD A, (DE)
LD E, A
LD (I,
RET

```

nextsect

BUFF

COPIES TO: Raffaele Cecco

CYBERNOID MUSIC+ SOUND FX AMSTRAD V.2.0

- SOUND = 6D48 h
- First call SOUND+3 to initialise sound system
- Interrupt must then continue every 1/50 sec. to SOUND. Registers corrupted: AF, BC, DE, HL, IX. Not corrupted: IV, alternate regs.
- To SILENCE all sound call SOUND+3

TO START ANY SOUND: LD E, NUM; CALL SOUND+10

NUM	DESCRIPTION
1	MAIN TUNE
22	Shield Active
24	Drop bomb
26	Player fires
27	Hit Enemy
28	Release Bouncebombs
29	Bounce (randomised pitch)
38	Main Explosion
31	

• Above: Dave Rogers' instruction sheet for Raffaele Cecco for *Cybernoid*. This is all the programmer needs to know how to use the sound module. Behind that is part of the original sound-driver source-code for *Netherworld*



• Two of Dave Rogers' projects, *Netherworld* and the upcoming *Stormlord*. (A few copies of *Netherworld*, by the way, have instruction sheets omitting the sound controls, so here they are: press Esc to pause game. While paused, keys 1 to 4 control music/FX volumes, keys 9,0 toggle music/FX on/off. Spacebar to resume game.)



FORUM

CPC debate rages around PAT McDONALD. But he can cope...

Welcome to *Forum*, the area of the magazine where Pat does his very best to answer your questions and pass on your hot tips on all aspects of CPC computing.

●Text, no graphics

I would be grateful if you could let me have any information, *Type-Ins* or back numbers that I may be able to use on my Amstrad CPC6128 to allow me to type italics on my monitor and to my serial printer.

I am also having printer trouble with *Mini Office 2*. It works with the word processor, but not the graphics. Do I need another plug for my printer?

J C Hodds, Leicester

ys require the control
d. The symbol is use
he control key down and
ey to be held down whi
se keys.

ys require the control
d. The symbol is use
he control key down and
ey to be held down whi
se keys.

● If you know the control codes, it's easy

For producing different font styles on your monitor, take a peek at *The Look* this month (and next month too).

Printers vary greatly in the protocols they use for printing in different type-styles, and also for graphics. What you need are the **printer control codes**, and what they do. Try the place where you bought it. Failing that, try a shop which sells it.

●Cheapo CPC books'n' stuff 4U

I recently visited my local Toys'R'Us superstore in Peterborough, and found that they were selling the following books for £1.97 each:-

Amstrad Games Book (rrp 6.95);
Ready Made Machine Language Routines for the Amstrad (rrp £7.95);
Advanced Amstrad Basic (rrp £12.95);
and *Z80 Reference Guide* (rrp £12.95).

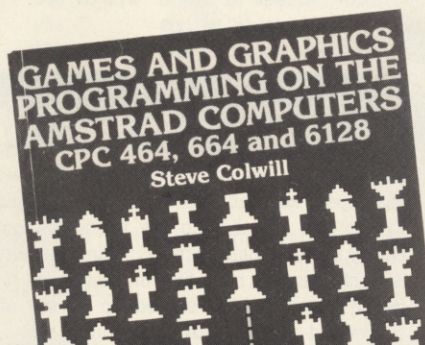

The last resort is the manufacturer. From the look of your letter it would appear that you're using a thermal printer - there is no guarantee that the maker is still in business.

Incidentally, we really can't send out information to requests such as this one. There are 38,000 of you lovely people out there who buy AA, and if even one in ten of you needed assistance and sent in an SAE and a request for personal assistance, then a) we'd be up to our necks in thousands of letters and SAEs; b) the other nine out of ten of you wouldn't get another issue, and c) we'd very soon be out of a job. Need we say more?

That's a saving of over £32!

Also, following your article on disk drives in AA42, I'll just add that you can get 3" Hitachi disk drives from J.N. Bull, 250 Portland Road, Brighton. The price was approximately £30, but I also had to buy a power supply from them to use it.

George Hyslop, Peterborough

Cheers for those tips, George, though we're informed by JN Bull that they're out of stock of Hitachi 3" drives just at the moment. But if enough of you ring 'em up and demand yours, I'm sure they'll soon find some more! ☎ 0273 734540.



●More for Midi

You've done the odd article on Midi, but I am still puzzled! I have a CPC 464, without any peripherals (except a sound amplifier). A few days ago I got a Yamaha PSS680 keyboard. Not being so hot at playing live, I was wondering if, using a Midi program, could I program the computer with a tune (say from sheet music) and play

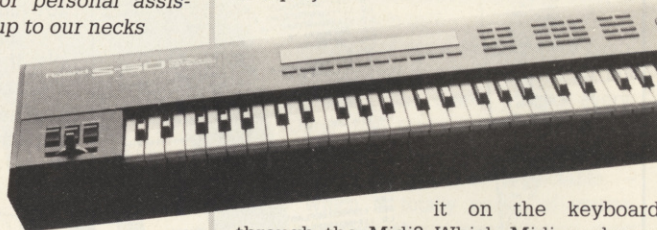

it on the keyboard through the Midi? Which Midi packages can do this, and which is the cheapest?

Shaun Garrod, Cong Moreton

If you look at the Buyers' Guide at the back of this issue, you'll find what you're looking for. The cheapest interface/software combined is the Ram Music Machine. Using this you can put tunes into the computer, although it doesn't give you the option of editing live compositions from a keyboard.

By the way, music lovers (oh no, an attack of the Alan Freemans!), look out for a major feature on music on the CPC. That's next month, provided we can get our act together...

£40 if you honour our offer!

Forum is designed to do the jobs previously done by *Words Work*, *Hot Tips* and *Problem Attic*, which always overlapped to some extent anyway. It will be as big as you want it to be - depending on your reaction and the number and quality of letters we receive.

To encourage you we're giving away £40 each and every month to the writers of the hottest tips and the best questions. So if you have a problem, or a solution, get it in writing now. Send it to: *Forum*, AA, 4 Queen St, Bath BA1 1EJ.

We're very sorry but we simply haven't the time to reply personally to your letters: so no SAEs please!

● Protection please!

I want to store information on cassette in such a way that nobody else can gain access to the information.

Paul Bradley, Plymouth

You and every government in the world, Paul! Assuming that you're looking to include a routine in one of your own programs, then there were suitable Type-Ins in AA33 and AA36.



● UPPER, lower

Just a quick note on *Tasword*. I suspect that it works on all versions. Pressing **CTRL** and ; changes all characters to upper case, and **CTRL** : puts all characters to lower case. For multiple changes just keep your fingers on the keys.

By the way, what happened to *Word s Work, Problem Attic and Hot Tips* in AA43?

G Dernley, Ipswich

Thanks for the tip. Forum covers all of the areas which Problem Attic, Hot Tips and Words Work covered before. Because all the sections have been joined together, we save half a page on the title space alone! The reason it's so short this month, by the way, is Steve's 'Fifth birthday special' you passed just a few pages back, and Trenton's extensive joystick bashing piece coming up in a couple of pages from now. Yup, looks like another McDonald sandwich!

Next month we'll be back to a decent four page Forum. And that's a promise!

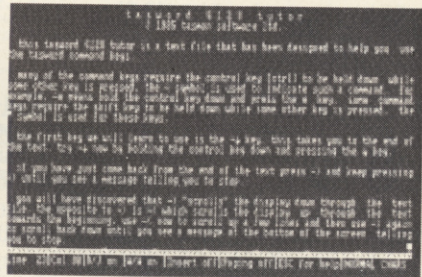
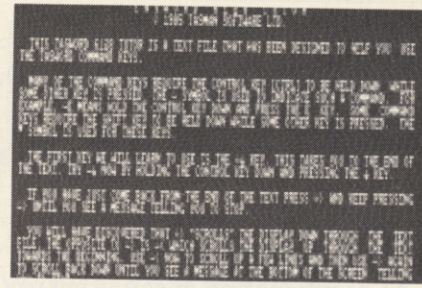

● Going up and down with *Tasword*

● Language barrier

● After reading AA39's feature on CPC languages, I feel I must correct you on a few points (smug voice). John Morrison sells Pascal on ROM. It's not complete but is suitable for most purposes.

As for compiled Basics, I know of two: BcBc basic (which is Mbasic for CPM machines), which sometimes comes without documentation, and has occasional quirks in commands: and Ebasic, which is weak as far as number handling goes but is very well documented and user friendly. The latter does unfortunately need a run time module.

There is another version of BCPL available, again Public Domain, from Wacci ☎ 01 898 1090. My favourite PD library is Clockwork Orange Software, who supply programs at just £1 per disk.

You also neglected plenty of other languages like Cobol, Lisp, Pistol, Prolog, Valgol, Sciam and Forth. I must admit though, they are really hard to understand on the CPC.

Joe Florek, Runcorn

The article was pointing beginners in the right direction for first or second languages. PD libraries aren't ideal places for this type of program (as you say, explanations can be lacking), so for lack of space they were largely left out.

Perhaps we should just point out that this letter is not being entirely frank. Clockwork Orange, Joe's 'favourite' PD Software library, is actually run by him! Still,

you can chance your arm with COS by writing to COS PD, 11 Stanley Villas, Greenway Rd, Runcorn, Cheshire WA7 4NW. If you find the service in any way 'exceptional' (!) then please do drop us a line and we'll pass on your comments.

John Morrison has so far neglected (despite requests) to send us a review copy of the Pascal ROM, so I can hardly form an opinion about it! However, one feature planned for AA is a look at some libraries, and the software they provide. It's not that we ignore PD software: it just wasn't the time or place.

We're glad that you sent us an informative letter though, and we'd love to hear about other great little PD software libraries.

● I'm interested in using my CPC6128 to learn a programming language. I plan to just learn in my own time, at my own pace. But I would hope that perhaps it would lead to a job. What would you recommend?

Matt Lawes, Somerset

Software houses, when taking on trainees, prefer academic qualifications to experience on home computers such as the CPC. However, the horrendous skill shortages you hear about on the news are very real in new technology areas. So in theory learning a 'profes-

sional' language might be a real asset.

The language of the moment is C. This isn't particularly old, but is well suited to the ever more powerful machines that industry is getting its paws on. Arnor's C costs £49.95 on disk only, and is an extensive version.

To help get you started, take a look at Learning to Program in C by N Kantaris, published by Bernard Babani at £4.95 (ISBN 0-85934-203-4).

One more thing: although it's certainly more fun than taking a structured educational course, learning a computer language on your own is very difficult, so I wish you all the best.

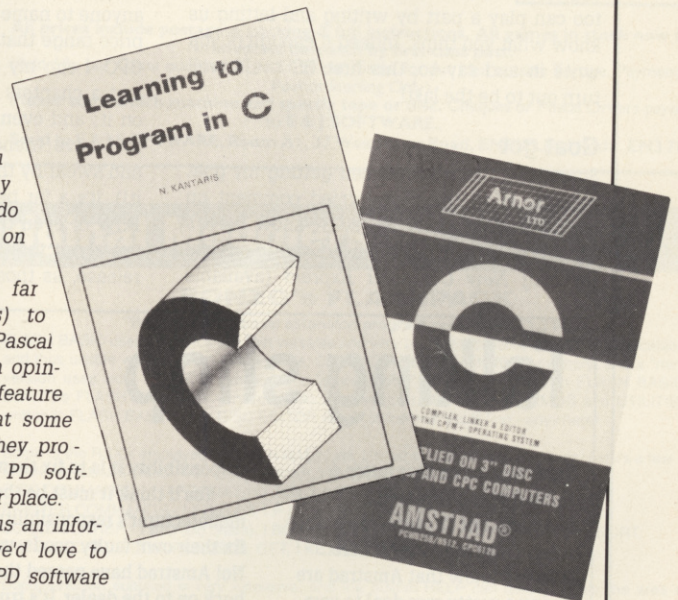

Broadley speaking

A new regular page given over to comment and observation in the company of EMMA BROADLEY.

“ Welcome to the very first instalment of 'Broadley Speaking' (not my idea of a brilliant headline, but there you go), in which I get to spout off for a whole page every month. The idea, as I understand it, is for me to comment at somewhat greater length (and, I hope, in depth) on current CPC issues and activities. Steve tells me I can say more or less what I want, though no doubt he's aware that if I say anything libellous it's he who gets sued!

But as with all of AA the point is not that you sit back and read what we've written. You too can play a part by writing and letting us know what you think. Indeed if enough of you write in and say so, this first 'BS' could well turn out to be the last!

Goat got

Something that's really been getting my goat recently is all the misinformed comment on the state of the CPC market. I know Steve's already done his bit both in AA and in our sister mag *New Computer Express* (available



every Thursday at all good newsagents, price 48p – advert ends), but as one of the many who've only come to the CPC in the past eighteen months or so, I wish to add my thrupence worth.

In my opinion you'd have to be crazy to buy any other computer. After all, I challenge anyone to name a machine in the same sort of price range that can do as much as my trusty CPC. I run my accounts on it; write articles and a chapters of my (very promising) novel on it; and even blast the occasional alien on it. I have friends who share my viewpoint, and swear by their CPCs (no, I said swear *b y* it!). It's a far better games machine than the PCW or even than the PCs, and I for one am not about to start shelling out £25 for a new release, as those poor Amiga and ST people

have to. Furthermore it's such a reliable machine – a factor we seem to take very much for granted, by the way.

No, you can keep all your flashy, fashionable and horribly expensive machines. I'll stick with my trusty CPC, thanks very much.

Who can tell?

Reading the story of the making of my favourite Arnold in this issue of AA, one thing strikes me. What would computing in Britain be like if things had been different, I wonder? There's no sense of inevitability about Amstrad's plunge in 83/84 into the maelstrom of home computers. Quite the opposite in fact: you wonder what odds you could have got from any of the experts involved against the whole thing coming off at all!

And of course, no CPC, no Amstrad – at least, not in the way you and I think of them, as the biggest in the business in Britain. ”

● If you disagree with anything that appears in this column, or would like to air your own viewpoint, write to: *Emma's Page*, AA, 4 Queen St, Bath, BA1 1EJ. You could win £25, or get completely lambasted by Emma, depending on how she feels!

Talking shop

Steve passed on this letter. I think it was addressed to Reaction, but I'm sure the author won't mind me using it here...

"Did you know that Amstrad are giving a pretty raw deal to computer dealers?

Just before Christmas they were selling the CPCs to Comet and other high street retailers at prices far below independent dealers' prices. This leads to the ridiculous situation where it was cheaper for most dealers to nip around to Comet and buy CPCs than to purchase them from Amstrad!

But that's not all. The latest brainstorm from Mr Sugar and the gang is that if your trusty CPC goes wrong within its warranty period (12 months), guess whose

responsibility it is to fix them?

You'd think it must be the manufacturer's responsibility to fix their own faulty goods, yes? No! Amstrad have passed the buck on to the dealer. It's true that Amstrad will supply the parts, but the dealer him/herself bears the cost of the labour – the expensive side of computer repairs.

So what? you might ask. As long as it gets fixed, and I can get a cheaper CPC from places like Comet, why should I, the end-user, be concerned? Just ask yourself who gives the most support for computer users. Is it: a) the high street electrical shop? or b) the independent computer shop?

If you answered (a) then either you're on a completely different



planet from me, or your surname is Dixon or Curry. What has all this to do with Amstrad giving a bad time to its dealers? The answer is that many dealers are turning their backs on Amstrad, and therefore the CPC, and are pushing other computers.

In the place previously occupied by CPC464s and 6128s there are Commodore C64s, and Amigas and Atari STs.

If that happens to a great extent, then the amount of users of CPCs in that area falls, and the dealer then starts withdrawing support, which means fewer games on the shelf, which means less interest in the computer and so on. Quite clearly this is a vicious circle.

That is why you should be concerned, because if you get dissatisfied dealers, it reflects, in the end, on support for that product. And if the situation continues you could find the CPC becomes a very cheap and very dead product. Remember the C16, the Electorn, the TI 99, the Ace, the Dragon...?"

(Name and address supplied but withheld on request)

● The views expressed in this column do not necessarily reflect those of the editor of *Amstrad Action* or its publishers

SCHOOL

FREE Catalogue Amstrad CPC, PCW, PC1512, Commodore, BBC, IBM PC
Amstrad PCW - Business Software, School Admin. PC. 24 Hr. Visa/Access Hotline. Ring UK 010353 - 614977 (Office Hours) (Irl. 061 - 27994) 010 353 - 6145399 (UK 24 Hr.)

MAXI-MATHS

Amstrad PC, IBM PC, Amstrad 464, 664, 6128.
1. Triangles, 2. Angles, 3. Sin Cos Tan, 4. Rectangles, 5. Circles.
A highly interactive program such as Basic Geometry provides a very stimulating learning environment.

MAGIC MATHS (age 4-8)

CBM 64, All Amstrads, IBM PC
Additions and Subtraction. "A serious challenger to similar BBC programs and a good example of its type."
Primary Teaching and Micros UK.

MATHS MANIA (age 8-12)

All Amstrad/CBM 64/IBM PC
Multiplication and Division. "It appeals to the age group. My son has been sneaking downstairs before breakfast to play."
BBC CEEFAX review.

BETTER SPELLING (age 8-adult)

All Amstrads/CBM 64/BBC/IBM PC
"Well Organised Lessons. Educationally it is very strong." 8000 Plus.

BETTER MATHS (age 12-16)

All Amstrads/CBM 64/BBC/IBM PC
Rated in the top five in Amstrad Action educational survey.

CHEMISTRY (age 12-16)

All Amstrads/CBM 64/BBC/IBM PC
Very ambitious in terms of the range of topics. High standard of questions." 8000 Plus.

BIOLOGY (age 12-16)

All Amstrads/CBM 64/BBC/IBM PC
"A very good excuse to play with your computer and have fun while revising." Your Computer.

Mapwork Quiz (9-Adult) CPC, BBC, CBM 64

The Three Bears (5-10) CPC & PC
Physics (12-16) CPC/PCW/PC

School Administration PC1512/IBM

CPC & PCW DISKS £16.95

PC DISKS £22.95

CASSETTES £10.95

Send Cheque Visa/Access/and Exp. Date (£1.00 P&P)

Tait Business Centre, Dept A, Dominick Street, Limerick, Ireland

Tel: (UK) 010-353-61 49477 (IRL. 061-27994)



MATHS MANIA



Biology I



SCHOOL SOFTWARE

BETTER SPELLING



Physics I

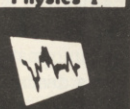

SCHOOL SOFTWARE

MAGIC MATHS



GREAT STRATEGY GAMES

From E & J Software



TREBLE CHAMPIONS

A Classic NEW Football Strategy Game - Can you Win The League, The F.A. Cup & The League Cup - 4 Divisions of 20 Teams + 1 Div. 20 Non League Teams - Details of OVER 1500 Players - Results & Leagues ALL Divisions - League Cup with 1st, 2nd Rnds + S/Finals over 2 OVER - F.A. Cup includes Non League - Transfer Market buy ANY PLAYER ANY DIVISION - 3 Skill Levels - Start ANY Division + FULL PLAY OFF COMPETITION - 2 In-Match Subs. - Coaching + Fitness Training - PLUS MUCH MORE.

EUROPEAN CHAMPIONS

Genuine European Nations Cup Simulation - Full Random Draw of 32 Teams - Fixture List, Results & League Tables ALL 8 Groups - Squad of 22 Players + Other Players Available - Qualifying Matches (Arrange Friendlies) & The Finals - FULL MATCH ACTION with Goals, Free Kicks, Penalties, Injuries, Bookings, Corners, 2 In-Match Subs. - Select Team Tactics & Style of Play PLUS MUCH MORE.

WORLD CHAMPIONS

A Complete World Cup Campaign on 7 Skill Levels - Select Friendlies - Squad of 25 Players - Qualifying Group + Tour Matches & The Finals - SUPERB TEXT MATCH SIMULATION with Bookings, Goals, Corners, Free Kicks, Penalties, Injuries, Injury Time, 2 In-Match Subs., Extra time, Penalty Shoot-Out, etc. PLUS MUCH MORE.

CRICKET MASTER

An Outstanding Simulation of One Day International/County Cricket on 3 Skill Levels - Varying Weather, Wicket & Outfield Conditions - Select Batting & Bowling Tactics - Fast, Med. & Spin Bowlers - Team Selection - 4 Types of Batsmen - Select Field Layout - Wides, Byes, No Ball, Run Outs, Misfields, Dropped Catches, Scoreboard, Batting & Bowling Analysis, + FULL MATCH OVERVIEW showing BALL BY BALL ACTION and Commentary PLUS MUCH MORE.

TEST MASTER

A Cricket Masterpiece Simulating a Full 5 Day Test Match - Includes Most of the Features of Cricket Master with FULL MATCH OVERVIEW & Commentary - Declarations, Follow-On, Nightwatchman, Light Meter, Rain/Bad Light Stops Play, Varying No. of Overs per Day - New Ball - Save Game - PLUS MUCH MORE - THE ULTIMATE CHALLENGE for all Cricket Enthusiasts.

Software Availability	Spectrum 48/128K		Commodore 64/128K		Amstrad CPC	
	Tape	Disc	Tape	Disc	Tape	Disc
Treble Champions	9.95	13.95	N/A	N/A	N/A	N/A
European Champions	8.95	12.95	N/A	N/A	8.95	12.95
World Champions	7.95	11.95	7.95	10.45	7.95	11.95
Cricket Master	7.95	11.95	7.95	10.45	7.95	11.95
Test Master	8.95	12.95	N/A	N/A	8.95	12.95

FANTASTIC DISCOUNTS

Buy 2 games deduct £3.00
Buy 3 games deduct £5.00
Buy 4 games deduct £7.00
Buy 5 games deduct £12.00

All prices include postage & packing & full instructions. All games in stock now for immediate despatch by first class post.

(Add 50p per Game outside UK or £1.50 per Game for Air Mail outside Europe. Payment in Pounds Sterling Only).

Please state which machine and specify tape or disc. Cheques or Postal Orders payable to E & J SOFTWARE.

Send to E & J SOFTWARE, Room A1, 37 Westmoor Road, ENFIELD, Middx. EN3 7LE

NEMESIS - The Original Meddlers

BONZO SUPER MEDDLER

"A REAL ALTERNATIVE to a Multiface II BLACK BOX.", A.A. JAN '89.
"The best TAPE TO DISC transfer utility available", WACC1 6/88.

THE 1989 EDITION

BONZO SUPER MEDDLER continues as the most complete TAPE TO DISC transfer utility. Recently revised, it now includes a database of all verified transfers - currently 880 TRANSFERS! GUARANTEED TO TRANSFER MORE games than any other program - POSITIVELY! BONZO does the transfer - and you play your games from DISC. Here's a few of the 880 put to disc with BSM. 464/664/6128:

ANTIRIAD, ARKANOID, ARCTIC FOX, BARBARIAN, BMX SIMULATOR I & II, BOBSLEIGH, BOBJACK I & II, BIGFOOT, CYBERNOID II, CAULDRON I & II, DANGEROUS, DARKSIDE, DRILLER, DARTS - 180, DIZZY I & II, DANDY, EQUINOX, ENDURO RACER, FERNANDEZ MUST DIE, FOOTBALLER OF THE YEAR, GREMLINS, GUADAL CANAL, GRAND PRIX SIMULATOR, 3D GRAND PRIX, HOPPING MAD, HACKER, HIJACK, IKARI WARRIORS, INVASION, JETSETWIL, JACK NIPPER I & II, JOE BLADE I & II, KUNG FU MASTER, KNIGHTMARE, LEADERBOARD, LIGHTFORCE, LIVING DAYLIGHTS, MOONBUGGY, METAL ARMY, MONOPOLY, NEXOR, NINJA SCOOTER SIM, PYJAMARAMA, PEGASUS BRIDGE, REFLEX, RED OCTOBER, REDHAWK, RED MOON, SCRABBLE, SUPER STUNTMAN, STEVE DAVIS SNOOKER, STAR RAIDERS II, SWORD SLAYER, STORMBRINGER, STAR TROOPER, SPINDIZZY, STRYFFE, TTRACER, TOPGUN, TOTAL ECLIPSE, TETRIS, TANIUM, THRUST I & II, V, VAMPIRE, WEREWOLF SIM, XOR, ZUB.

and OVER 800 others!

Isn't it time you got the BEST? Send your disc-based utility to be transformed into BSM & HACKPACK for just £8.00. If you haven't got one, then the BSM & HACKPACK with full instructions, details of over 800 transfers, and our current NEWSLETTER, £12.50 inclusive. Supplied on disc.

BONZO BLITZ - SPEEDLOCKS TO DISC

"HIGHLY RECOMMENDED" - WACC1, 12/87

BONZO SUPER MEDDLER will cope with a large number of SPEEDLOCKS, but for the enthusiast we developed BONZO BLITZ - the first to deal with all forms of SPEEDLOCK. It doesn't need an expanded CPC - works on 464/664/6128 - and still EQUALS any other utility - WITHOUT juggling or fussing. A database on this one too! A FEW: ALIEN HIGHWAY, ARMY MOVES, ATV SIMULATOR, BEACH HEAD 1 & 2, CATCH 23, DEATHSTALKER, DIZZY, ELEKTRAGLIDE, FRUIT MACHINE SIM, F15 EAGLE, GAMEOVER 1 & 2, GREAT ESCAPE, HIGHWAY ENCOUNTER, MATCHDAY I & II, MADBALLS, METROCROSS, REVOLUTION, SALAMANDER, SLAINE, SCRABBLE, SCALEXTRIC, SUPERHERO, TRANSMUTERS, WIZBALL, WEC LE MANS, etc. WORLD CLASS LEADERBOARD and ROADRUNNER although "multi-loaders" will completely transfer if you have BSM to assist! Other "multi-loaders" - main file only. BLITZ was first in with the "NEW" SPEEDLOCK variation - and there's dozens of compilation tapes using this, like MAGNIFICENT SEVEN & GAME, SET & MATCH II.

£12.50 inclusive. Supplied on disc.

APRIL
MAY ONLY

BSM & HPACK + BLITZ
TWO DISCS, all info £22.00 inclusive.

UPGRADES = BSM or BLITZ, £3.00 [return original disc!]

BONZO's FLASHPACK

"Best all round basic extension program seen" WACC1 3/88

FLASH BASIC uses 70 RSX's in a fast versatile and very powerful implementation. It is relocatable and thus usable with hardware expansions. COMPACT - it uses only 8K of memory; and a "mini" version uses only 3K! YOU can produce "stand alone" programs written in FLASH BASIC! BONZO's FLASH PACK is a very full DISC containing FLASH BASIC, DEMOS and UTILITIES written in FLASH BASIC. The DISC EDITOR is one of the best you'll find - anywhere!

Some of the RSX's employed in FLASH BASIC are almost mini-utilities themselves; here's a few MEMORY COMMANDS - I M. EDIT, (editor!), I M SEARCH, I M LIST, I M MOVE DISC COMMANDS - I D FORMAT, I D READ, I D WRITE, I DEPRO, I HEADER PRINTER COMMANDS - I POSTER, I P CDUMP, I P ON, I PDI, I PSEND, SCREEN/OTHER - I BIG (big chars), I BOX, I COLOUR, I PAUSE, I LINE, I SLEEP, I SORT, I MENU, I CALL, I SCR, PUT, ISCR, GET, I KEYS, I INFO.

Documentation supplied is very extensive, and the built-in HELP can quickly locate the area of interest and send information to the screen or printer.

BONZO's FLASHPACK £12.50 inc Disc

A SECOND DISC of other major utilities is also now available

BONZO's BIGBATCH £12.50 inc. Disc.

This contains a very fast and flexible DATABASE, a superb FOOTBALL POOLS PREDICTOR, both written in FB, plus a user-friendly and memory saving SCREEN & SPRITE DESIGNER. It is not necessary to have the FLASHPACK disc to take advantage of BIGBATCH.

BONZO's DOO-DAH

"This is the best I've seen in a long while... I recommend it"

- AMSTRAD ACTION. JUNE 1987

FEATURES BIGBONZO FORMAT

A REALLY USABLE 203K per SIDE FORMAT, with all the support files to maximise it's use PLUS - All the disc housekeeping features that you could possibly want, including "Cloning", Directory & Sector edit. Disc search, Formatting, Read sectors, Filecopy, etc ALL FUNCTIONS are effective on normal, enhanced, and the majority of "funny formats"

MANY UNIQUE FEATURES. Supplied on DISC

£12.50



NEMESIS A.A

ALL ORDERS sent by return: Cheque/P.O/Access

TEL: (0933) 623967

10, Carlow Road, Ringstead, Kettering, Northants NN14 4DW



Stock response

We worked out, using Thompson Computers' *Stock Control*, that we could just about afford to get STEVE WILLIAMS to review it.

He worked out that he just couldn't afford to refuse.

STOCK CONTROL

£15 CPM+ (requires *Prottext*)
Thompson Computers ☎ 0733 331796

It's crucial, if you're a small business person, that you have accurate information about your stock, and that it matches your requirements. That's what this new program from Thompson Computers is designed for.

The manual – eleven A4 pages and 1,400 words (in a sturdy plastic folder) – is well written and easy to understand, and once I got past the setting-up phase I found no need for it. The program is pretty straightforward and takes care of all the difficult bits.

So what's it like to use? First make a back-up copy of the supplied program disc and use

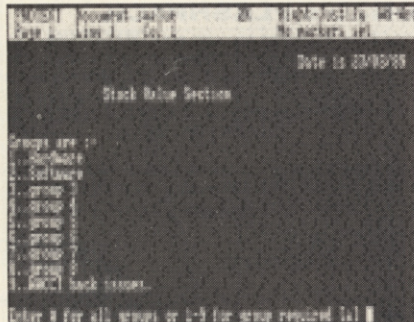

● An intermediate menu to specify stock items

it as your working disk. Then boot up CP/M+ and load in CP/M+ *Prottext*. At the **A>** prompt from the command mode, type **"x thomp"** followed by the RETURN key. You're then asked to enter the date. When all of this has been

On the other hand

SD Microsystems' *Stock Accounting System* performs not only stock control but (surprise) accounting as well. It's fast and efficient, with excellent support from the company. The only drawback is it only works on a 128K disk machine. Read the full review in AA42, and contact SD Microsystems on ☎0462 675106. *Stock Accounting System* £39.95.

safely accomplished you enter the routine by typing **x sm** from the *Prottext* command mode. When the dust settles you are greeted by the main menu. The options that this menu leads off to are self explanatory.

Signing on: the initial session

To begin the initial session you set up your opening balance and then enter details into the application. These can be transaction credits/debits or information about standing orders. The latter are particularly well catered for as the user is given the option to enter, amend or even merge the information.

You are prompted for a description (maximum of 25 characters including spaces) of the group of goods you want to itemise. You can have a maximum of nine groups covering general descriptions of the goods you are itemising, and each group can be subdivided to hold specific item titles. In my case I chose some general group titles such as software, hardware, back issues and so on. Each group can then have individual descriptions defined: for example, under 'Back Issues' I had each issue catalogued separately with the number remaining in stock.

The unit cost of each item is entered along with the expected re-order level. The total amount is then worked out and all the entries are displayed on the screen, and you're asked to confirm if the entries are correct. Made a mistake? *Stock Control* scraps the entry and takes you back to the beginning of the section. The program allows you to edit and update each stock level.

Full power ahead

It's now you start to appreciate the full power of *Stock Control*. It allows you to printout or display re-order levels, stock that currently needs re-ordering, current stock levels, and present stock values. Every one of these functions can be displayed or printed either individually, by group or in total.

There are two minor niggles. The documentation gives no clues about how to calculate 're-order' levels. Admittedly it would be impossible to incorporate this into the manual, since gargantuan tomes have already been written about how to achieve this task. What would have been nice would have been a few pointers included from Thompson Computers about where to find these books, even if it

was only a note to say 'look in your local library.'

The second quibble is that, because it is running under the *Promerge* part of CP/M+ *Prottext* and has to read certain routines and files from the disk, the routine is slow. On balance the speed (or lack of it) must be considered as an acceptable trade-off against flexibility, but one way to get around this problem is to have a Ram/Dk'Tronicks' 256K Silicon Disk set up as drive C: (or B: for you cheap-skates who haven't yet purchased a second drive) under CP/M+ giving 444K disc space.

Load CP/M+ *Prottext* and *Stock Control* onto the same Silly Disk, run the application

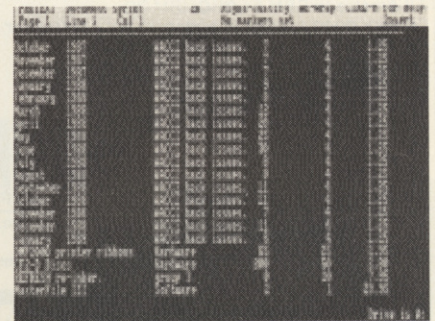

● A stock list is easy to get at any time

under *Prottext* and it then scoots along as fast as Paul Channon escaping from a press conference.

In theory, you could encounter a dramatic loss of hard entered data due to a sudden power failure, or even the dreaded edge connector wobble (hands up ZX81 owners!).

● **Stock Control works under CP/M+ and requires the full CP/M+ version of Prottext. The program is menu driven and uses the Promerge mail merge commands and the Exec file and macro facilities in a similar manner to Prottext Filer and Prottext Office.**

The fact that *Stock Control* is an application that runs under *Promerge* gives the user opportunities to 'tweak' the package to their particular requirements.

Considering that it's designed for small business use, and also that it is tax-deductable, £15 is very reasonable. ●

GOOD NEWS

- Clear and easy to follow.
- Good price for business use.
- Can be 'tweaked.'

BAD NEWS

- Requires *Prottext*.
- Slow.

Top Software at rock-bottom prices from SWIFT SOFTWARE

SWIFT SOFTWARE is a new force in top quality, low cost software. Due to our buying power we can purchase software at probably the lowest prices. In return we pass these discounts on to you - with our 10 day money back guarantee.

ever deal on their range of CPC products. Many prices have been slashed by over 30%, and you can save a massive £25 if you buy the Rombo & Protex Startup Kit!

As part of a special promotion we have teamed up with Arnor to provide the best

Remember, these prices can only be held this low for a limited period, so send in your order today!

Protex - Without doubt the most sophisticated word processor you'll find on any home micro. Its ease of use and advanced range of features are normally only found in business systems costing many times more. Protex is the number one word processor for the CPC!

- * Extra fast
- * Works with any printer
- * Flexible find and replace
- * Complete control over page layout
- * Word count
- * Many print options.

RRP	Disc £26.95	Rom £39.95
OUR PRICE	£19.50	£29.50
You Save	£7.45	£10.45

Prospell - With Prospell you can produce 100 per cent error - free documents, eliminating odd words and dubious spellings. You can also add words to create your own dictionary.

- * Can check Protex text in memory
- * Works with Tasword, Amsword, and Wordstar
- * Over 33,000 word dictionary
- * Checks at up to 2,000 words per minute
- * Finds words and anagrams

RRP	Disc £24.95	Rom £34.95
OUR PRICE	£18.50	£24.50
You save	£6.45	£10.45

Promerge - Promerge is more than just a simple mailmerger for standard letters. It includes powerful mathematical and text functions and, of course, integrates perfectly with Protex.

- * Read data from keyboard or file
- * Conditional printing
- * Microspacing
- * Typewriter mode
- * Link files at print time
- * Reformat while printing

RRP
OUR PRICE
You Save

Disc 24.95
£19.50
£5.45

* All other features retained

Promerge Plus - This rom offers all the features of the Promerge disc plus, among other features:

- * Two file editing
- * Background printing
- * Box/Column mode

RRP
OUR PRICE
You Save

Rom £34.95
£24.50
£10.45

Maxam - The standard Assembler/Monitor/Editor for developing Z80 machine code. Used by many top software houses, this is an essential utility if you want to create machine code programs.

- * Plain English error messages
- * Disassembler
- * Memory editor
- * Full screen program editor
- * Mix Basic and machine code

RRP
OUR PRICE
You Save

Disc £26.95
£19.50
£7.45

Rom £39.95
£29.50
£10.45

Maxam 1.5 - Enhanced version of the extremely successful assembler/monitor, designed to be used from Protex. The editor has therefore been removed, leaving room for many new features.

- * Assemble from within Protex
- * Comprehensive diagnostics
- * Change register contents
- * Resume from breakpoints
- * Load/save machine code directly
- * Many new assembler directives

RRP
OUR PRICE
You Save

Rom £29.95
£22.50
£7.45

BCPL - One of the fastest, most flexible programming languages for the CPC. It is the precursor to C and has been used to write many operating systems and other major programs where speed is essential.

- * Comprehensive I/O libraries
- * Create your own function libraries
- * Full control of graphics and sound
- * Example source files
- * 60 page manual
- * Full screen editor and Space Invader game supplied.

RRP
OUR PRICE
You Save

Disc £24.95
£18.50
£6.45

Rom £29.95
£22.50
£7.45

Utopia - Once you have installed Utopia you won't know how you managed without it! It gives you 50 new commands - all of which are available without having to write a single program

- * Text and graphics screen dumps
- * Disc utilities - format, copy sector editor and much more
- * Automatically set function keys
- * Virtually unlimited function key space
- * Basic programming utilities
- * Rom management commands
- * Easy access to REN and ERA on a 464

RRP
OUR PRICE
You Save

Rom £29.95
£22.50
£7.45

There's never been a cheaper way to get into rom software!

Rombo & Protex startup kit - The Rombo is a sturdy box which can hold up to eight roms. And if you run out of room, you can simply add another. It comes with a cover, so you can keep your roms safe from dust and damage. Combined with Protex, the fastest, most reliable and biggest selling Wordprocessor for the CPC, you'll have a setup to rival systems many times the price.

- * Protex instantly accessible
- * Seven free sockets
- * Select high or low bank (allowing addition of 2nd rom box)
- * On/off switch for each rom
- * In and out expansion port sockets

RRP.....	£74.90
OUR PRICE.....	£49.50
YOU SAVE.....	£25.40

ORDER FORM

Please send me the following items:
(please tick)

	Disc	Rom
Protex & Rombo	—	£49.50 ()
Protex	£19.50 ()	£29.50 ()
Promerge	£19.50 ()	—
Promerge Plus	—	£24.50 ()
Prospell	£18.50 ()	£24.50 ()
Utopia	—	£22.50 ()
Maxam	£19.50 ()	£29.50 ()
Maxam 1.5	—	£22.50 ()
BCPL	£18.50 ()	£22.50 ()

I enclose a cheque/Euro cheque/PO made payable to:
SWIFT SOFTWARE

Name _____

Address _____

Post Code _____ Tel. _____

SWIFT SOFTWARE AA5, 347 LONDON ROAD, HAZEL GROVE, STOCKPORT, SK7 6AA. 061 456 0926

Wristy business!

So you need a joystick. But with so many available how do you choose? Easy - follow **TRENTON WEBB's** Pick of the Sticks, then turn over the page for our complete Joystick Jury.

In our most recent reader survey joysticks emerged as by far the most common item of hardware, with a massive 87.7% of CPC users owning one or more. But how do you choose which to buy from the many available? Is one joystick better than another? And is the debate merely a matter of price?

In this survey we firstly outline the facts about each joystick, then follow this up by testing each joystick on three very different games to give a fair all round indication of each 'stick's capabilities and limitations. (The games used were *Bad Dudes Vs. Dragon Ninja*, *S.D.I.* and *Chuck Yeager's A.F.T.*)

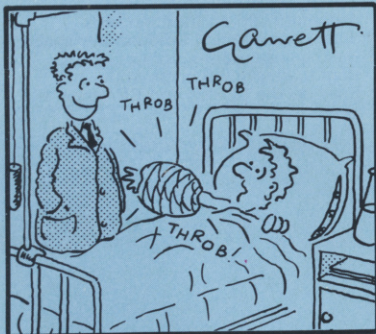

"COULD I JUST ANSWER THE READERS' LETTERS NEXT MONTH, STEVE?"

We've considered each stick carefully for its overall design, construction and look. Finally, the AA crew - present and past - have selected the best joystick for each of the price brackets.

Pick of the sticks: bargain buy

If you haven't much dosh there are two contenders: the £7 **Konix Megablaster** and the sub-fiver **Cheetah Challenger**.

The **Challenger** is the cheapest 'stick around, and makes a reasonable attempt to disguise its low price with impressive packaging and pistol grip design. The fire buttons are just too stiff, as is the 'stick itself, and for all the dressing up it is just not 'solid' enough.

The **Megablaster** makes no pretensions about price, boasting 'mega performance for micro expense'. It's hardly 'mega,' but is more

AA'S BARGAIN BUY!

than adequate, performing well in either desk-top or hand-held mode. With enough change from a tenner for a budget game, you can't do better than the **Megablaster**.

Pick of the sticks: under a tenner

As choice widens so decisions get harder. The **Ram Delta** is an excellent sims 'stick, and the **Cruiser** an ideal candidate for fast action shoot-out titles, but both are a little specialised for the all-rounder.

For superior all-round capability the real competition for the under a tenner prize is down to the **Cheetah 125+** and the **Euromax Elite**.

The **125+** is cheaper, better looking and

AA'S BEST UNDER A £10!

more flexible with four fire buttons. It lets itself down, however, on feel, appearing too light to survive a long shoot'em up session. The **Elite** design is functional, won't win innovation prizes, has only one fire button and a handle that's a touch small. But it feels as if it could take many hours of serious arcade pounding.

By a whisker, and for its true multi-role nature, the under a tenner honours go to the **125+**.

Pick of the sticks: under £15

Main choice in this category is between arcade (fire buttons on the base) and aircraft style (trigger on the stick itself). The aircraft style naturally looks the more dynamic, as even clear arcades have

AA'S BEST UNDER £15



AA'S BEST UNDER £15

AA'S WORLD BEATER!

Top row (left to right): 1 Spectravideo Quickshot turbo (AA's Best Under £15); 2 Mr. Joystick Crystal Turbo; 3 Euromax Elite; 4 Powerplay Cruiser; 5 De Gale Quickjoy Supercharger III; 6 Suncom Tac 30; 7 Konix Navigator; 8 Cheetah Starprobe. **Second row:** 9 Euromax Superpro (auto); 10 Wico Ergostick; 11 Euromax Pro; 12 Ram Electronics Ram Delta; 13 Mastertronic Magnum; 14 Dynamics Competition Pro 5000 (Clear); **15 Cheetah 125+ (AA's Best Under £10);** **Third row:** 16 Microleisure Starcursor (AA's World Beater); 17 Dynamics Competition Pro 5000 (Extra); 18 Cheetah Mach One; 19 Powerplay Cruiser (Clear); 20 Cheetah Challenger; 21 Suncom Tac 50; **Bottom row:** 22 Konix Speedking; 23 Euromax Superpro; 24 Mr Joystick Crystal; 25 Replay Microblaster; 26 Dynamics Competition Pro 5000; **27 Konix Megablaster (AA's Bargain Buy)**



The hacks' pick of the sticks

Steve Carey (Ed.): 'Give the Konix **Speedking** low marks, because it discriminates against left handers like myself. My favourite until now has been the Konix **Navigator**, because it's simple and unfussy and everything is where you expect it to be. But my new fave is the Microleisure **Star Cursor**, which is absolutely the best stick in the whole universe!'

Pat McDonald (Tech Ed.): 'My all-time fave is the **Terminator** – just because it's shaped like a hand grenade! My current favourite is the **Quickjoy Supercharger III**, because it has the daftest name!'

Gary 'Blaster' Barrett (Ex Staff writer – remember him? Oh well, doesn't matter): 'All time favourite? The **Kempston Pro** – though now I use the **Konix Speedking**.' (We all remember the times when Gary would whip into his drawers and pull out his Konix when he wanted a waggle.)

Bob 'Wagglor' Wade (Ex Ed.): 'I like the old faithful arcade style stick, but I now share my computer with a **Konix Speedking**. We are, however, just good friends.'

'Little' Dickie Monteiro (Ex Tech Ed.): 'All time fave is the **Phasor One** (too much *Star Trek* as a kid), but I'm now saving up my grossly inadequate pay to buy a **Konix Navigator**.'

Trenton 'Incredibly Handsome' Webb (highly talented Staff Writer): 'My all time favourite stick has to be the **Star Cursor**, because it's multi-purpose, highly adaptable and very, very different. Get yourself one of these and you'll be the envy of the everyday wagglor!'

little scope for variety in design.

The clear **Cruiser** is the most advanced, yet there still seems little special about it.

From the aircraft-style bunch there are three strong contenders: the **Quickjoy**, the **Starprobe** and the **Quickshot**. The best design awards goes to the **Starprobe**, with fire buttons on the base as well as the handle. It seems, however, less solid than the others.

The choice comes down to hand comfort, as they all perform almost identically. The **Quickjoy's** trigger button is not as contoured as it could be, making prolonged use uncomfortable.

The **Quickshot's** firing mechanisms allow a more relaxed grip, eventually tipping the balance in its favour.

Pick of the sticks: world beater

There are two contenders: the **Wico Ergostick** and the new **Star Cursor** from Microleisure. They are the only ones that are not just top of the range versions with added feature, but genuine products in their own right.

As Steve, a southpaw himself, points out, both Wico and Konix casually alienate at least 20% of their market by ruling out left-handers. The verdict overall therefore goes to the **Star Cursor**. It is an excellent joystick, with a flexibility that suits it to just about every kind of game – with the possible exception of simulators, because of the choice of fire buttons and your ability to switch between them. ●



TITAN

ACE
"Very fast and intense"

AMSTRAD ACTION
"Absolutely stunning, frighteningly addictive... Titan deserves some kind of award. It will have you playing time and time again until your joystick can take no more."

ST & AMIGA FORMAT
"Astonishing visuals... stunning, super fast graphics make this one so addictive your eyes'll turn into spinning kaleidoscopic squash balls."

AMIGA
ATARI ST
PC
AMSTRAD CPC
SPECTRUM
C 64/128

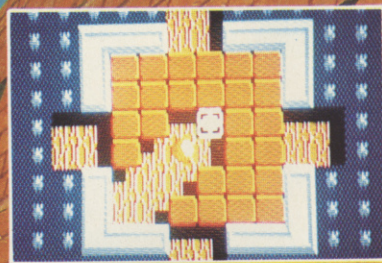
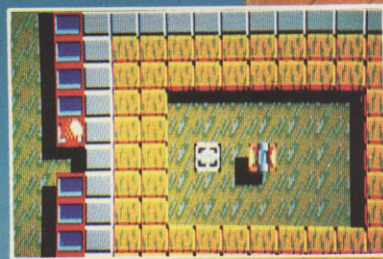
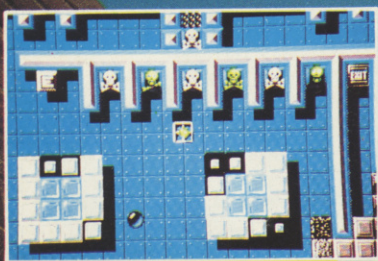

ACU 20/20
"Titan is downright original... exceedingly good, it's got that elusive spark that you never see in a mass produced conversion."



TITUS

UNIT 4 STANNETS LAINDON NORTH TRADE CENTRE BASILDON ESSEX SS15 6 DJ - PHONE : (0268) 541 126

© 1988 TITUS, TITAN, TITUS AND THE TITUS LOGO ARE REGISTERED TRADE MARKS OF TITUS L.T.D.

The great AA joystick jury

Name	Price	Hand/Desktop	Suckers Pads	Fire buttons	Comments	Special features
------	-------	--------------	--------------	--------------	----------	------------------

Amstrad JY2	£14.95	Desk	Suckers	1 trigger, 1 top	Absolutely tiny	The Sugar stick!
Cheetah Starprobe	£14.95	Desk	Suckers	2 base, 1 trigger, 1 top	Looks great	Autofire
Cheetah 125+	£8.95	Desk	Suckers	2 base, 1 trigger, 1 top	An economy version of the Star probe	Auto fire
Cheetah Challenger	£4.95	Desk	Suckers	1 base, 1top	Looks more expensive than it is	Very cheap
Cheetah Mach One	£10.95	Desk	Suckers	2 base, 1 trigger, 1 top	Leans too far forward	Auto fire
De Gale QuickJoy Supercharger	£12.95	Desk	Suckers	1 trigger, 1 top	Mean lean joystick machine	Auto fire
Dynamics Competition Pro 5000	£14.95	Desk	Pads	2 base	Bog standard arcader stick	Very sturdy indeed
Dynamics Comp. Pro 5000 (clear)	£15.95	Desk	Pads	2 base	Ditto, but clear	Ditto but prettier
Dynamics Comp. Pro 5000 (extra)	£16.49	Desk	Pads	2 base	Ditto	Rapid fire/slo mo
Euromax Elite	£9.95	Desk	Pads	1 base	Only one fire button!	Novel shape
Euromax Pro	£13.95	Desk	Pads	2 base	A dependable arcade style stick	Well built
Euromax Super Pro	£13.95	Desk	Pads	2 base	As above	Very solid
Euromax Super Pro (auto)	£15.95	Desk	Pads	2 base	As above	Auto fire
Konix Navigator	£14.99	Hand	n/a	1 base	The best handheld ever?	Unique design, autofire
Konix Mega Blaster	£6.99	Desk	Pads	2 base	Cheap but still a good performer	The price
Konix Speedking	£11.99	Hand	n/a	1 base	An old favourite, still a frontrunner	Very handy shape
Mastertronic Magnum	£12.99	Desk	n/a	1 top	Bizarre design	Thumb trigger position
Microleisure Star Cursor	£18.99	Desk	Pads	1 base	Looks odd, feels fantastic	Variable fire buttons
Mr. Joystick Crystal	£14.99	Desk	Suckers	2 base	A pretty stick but expensive	Small hand grip
Mr. Joystick Crystal Turbo	£16.99	Desk	Suckers	2 base	A pretty stick but even more expensive	Auto fire
Power Play Cruiser	£9.99	Desk	Suckers	2 base	An original shape	Variable stick stiffness
Power play Cruiser (clear)	£12.99	Desk	Suckers	2 base	A good looking arcade style stick	Variable stick stiffness
Ram Electronics Ram Delta	£9.99	Desk	Suckers	1 base, 1 top	Very good for sims.	Very long throw
Replay Microblaster	£12.95	Desk	Pads	2 base	An arcade buffs stick	Realistic arcade feel
Suncom TAC 30	£13.99	Desk	Pads	2 base, 1 top	A little too loose for some tastes	Odd colour scheme
Suncom TAC 50	£14.99	Desk	Suckers	2 base, 1 trigger, 1 top	Stiff triggers on handle	DIY Suckers
Spectravideo Quick Shot Turbo	£10.95	Desk	Suckers	1 trigger, 1 top	Looks great	Autofire
Wico Ergostick	£19.99	Hand	n/a	1 base	The rubber coating gives great grip	Ergonomic design ●

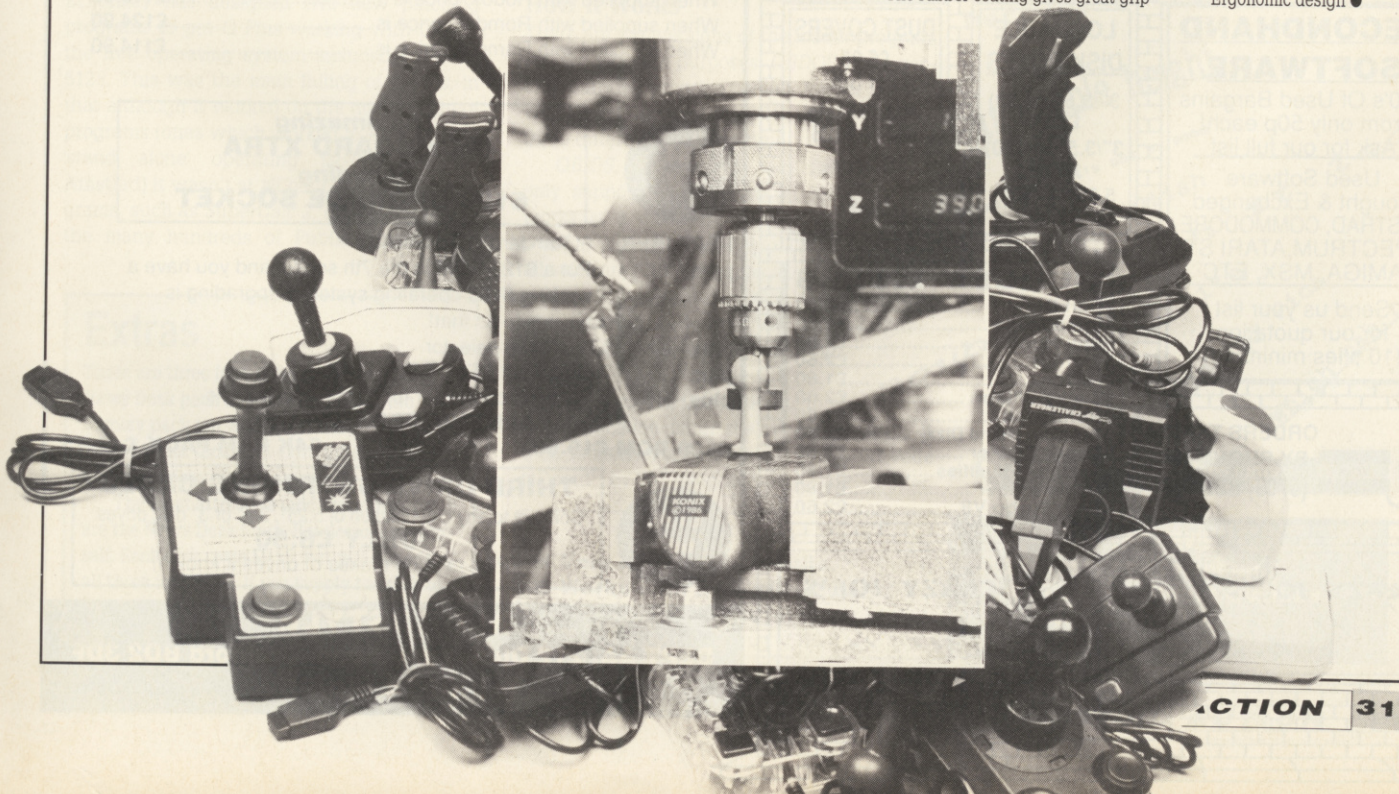

CRAZY JOE'S

145 EFFINGHAM STREET, ROTHERHAM
SOUTH YORKSHIRE S65 1BL
TEL: (0709) 829286

SPECIAL OFFERS

	Cass	Disk
H.K.M.	£7.99	£11.99
Arcade Muscle	£9.99	£14.99
The In Crowd	£10.95	£10.95
Renegade 3	£6.95	£10.95
Run The Gauntlet	£6.95	£10.95
Superman	£7.95	£11.95
Rock Star Ate My Hamster	£7.99	£11.99
The Deep	£7.99	£11.99
WEC Le Mans	£7.95	£10.95
LED Storm	£6.99	£10.99
Dynamic Duo	£6.99	£10.99
Rambo 3	£7.95	£11.95
Thunderblade	£6.99	£10.99
Bard's Tale	£6.95	£11.45
Operation Wolf	£7.95	£11.95
Chuck Yeagers A.F.T.	£6.95	£11.45
History In The Making	£14.99	£20.99
The Deep	£7.99	£11.99
Red Heat	£6.95	£10.95
Pacland	£7.99	£11.99
Command Performance	£9.99	£14.99
Munsters	£6.99	£10.99
S.D.I.	£7.99	£11.99
Tiger Road	£6.99	£10.99
Fernandez Must Die	£5.95	£9.95
Inc. Shrinking Sphere	£7.99	£11.99
Robocop	£7.45	£11.45
Last Duel	£7.99	£11.99
Heroes Of The Lance	£7.49	£11.49
Vindicators	£7.99	£11.99
Crazy Cars 2	£7.99	£11.99
Airborne Ranger	£10.99	£14.99
Dragon Ninja	£7.45	£11.45
Galactic Conqueror	£7.99	£11.99
Savage	£6.50	£10.95
Cybernoird 2	£6.99	£10.99
Dark Fusion	£7.99	£11.99
Total Eclipse	£6.99	£11.49
Victory Road	£6.99	£10.99
War In Middle Earth	£7.99	£11.99
Typhoon	£5.99	£9.99
Batman	£7.95	£10.95
Rex	£6.95	£11.95
Purple Saturn Day	£7.95	£11.95
Storm Lord	£7.99	£11.99
10 Mega Games	£9.99	£11.99
Return Of The Jedi	£6.99	£10.99

JOYSTICKS

Challenger	£4.50
125+	£7.75
Mach One +	£9.95
Star Probe	£12.95
Speedking	£9.99
Navigator	£12.99
Ram Delta	£8.99
Supercharger	£10.95
Pro 5000	£12.95
Pro 5000 (Clear)	£13.95
Crystal	£14.99
Tac 50	£12.99

BARGAIN BASEMENT

Brainstorm	£0.99
Firetrap	£1.49
How ZBA Hero	£0.99
I, Ball	£0.99
On The Run	£0.99
Saracen	£1.49
Zolyx	£0.99
Zorro	£1.49
Thingy & Doodahs	£0.99
Muggins	£0.99
Euro 5-a-side	£0.99
Gauntlet	£2.50

Postage Included In U.K.
Europe Add £1.00 Per Order
Overseas Add £1.50 Per Order

SECONDHAND SOFTWARE

100's Of Used Bargains from only 50p each!
Ask for our full list

Used Software Bought & Exchanged
AMSTRAD, COMMODORE, SPECTRUM, ATARI ST, AMIGA, MSX, ETC

Send us your list for our quotation (10 titles minimum)

LOCKABLE DISK BOXES

3" / 3.5" x (50)	£8.99
3" / 3.5" x (120)	£9.99
5.25" x (120)	£9.99

DUST COVERS

£6.95 Per Set
Please State 464 or 6128
Colour or Mono

BUDGET TITLES

Dan Dare 2	£2.60
Speedzone	£1.80
Spy Hunter	£2.60
Trantor	£2.60
Nexor	£1.80
Jocky Wilson	£2.60
Bombjack	£1.80
Treasure Island Dizzy	£2.60
Death Stalker	£2.60
Split Personalities	£1.80
Eagle's Nest	£1.80
Twin Turbo V8	£2.60

ORDERS TAKEN BY PHONE ON
VISA (0709) 829286

CRAZY JOE'S

OPEN

145

CRAZY JOE'S

STRATEGY SOFTWARE

Strategy games for the Amstrad CPC

THE FINAL CONFLICT - the game is a conflict between Nato and the Warsaw Pact in Europe. Options are either two player or solitaire against the computer, 25 different countries involved, over 160 units, infantry, corps, parachute, armoured, cities helicopters, different strengths, effects, supplies, fuel, casualties status, different seasons, city production levels, millions of troops involved, game lasts for weeks, save game, 18 page manual plus more.

SOCCER 6128 - football strategy game which lets you manage any team in the 4 divisions. Options are buy players, sell players, league programme, fixtures, opposition, play match, instructions, league table, accounts, playing staff, save game, 10 different positions, skill, form, goal scorers, injuries, up to 20 players in squad, sacking, over 2000 players, 80 English clubs, 60 European clubs, FA Cup, League Cup, European Cup, UEFA Cup, Cup Winners Cup plus much more. Reviewed in AMSTRAD ACTION July '88.

KURSK the dash of armour - was the biggest tank battle of WW2 in which the Germans had to beat the Soviet army to stand any chance of winning the war. The options are two player or solitaire against the computer. There are over 125 units which are infantry, armoured, corps, artillery, anti tank plus cities which all have different effects in combat. There are also supplies like troops, provisions and fuel. The object of the game is to capture the key cities or destroy enemy units. Also save game plus much more.

SOFTWARE HIRE CLUB - we hire out top game titles of strategy and simulation games for the Amstrad CPC. Send a large S.A.E for details.

Title	disk	tape
THE FINAL CONFLICT	£8.00	£7.00
SOCCER 6128	£8.00	£7.00
KURSK the clash of armour	£8.00	£7.00

Cheques or Postal orders Payable to STRATEGY SOFTWARE
Send to - STRATEGY SOFTWARE, 32 Albert Street, Seaham, Co Durham SR7 7LJ.

A USEFUL DISCBASE UTILITY

- ★ Discs in a muddle? Can't find that file?
- ★ Quick and simple to use, DISCBASE is the answer!

The first FAST Disc-File organiser for CPC machines -

- ★ FAST SEARCHES - any file from 1200 in under 1 second
- ★ AUTOMATIC UPDATE Insert disc, DISCBASE does the rest!
- ★ Hard copy of lists of Files or Discs; or of Disc-CATS
- ★ Unique and FAST file & disc viewing system

"Its simplicity and speed are brilliant.
99% of disk users will find DISCBASE indispensable."

"File and Forget!" Rave review on p16 in AA43, April 89

RRP £10.95, but send cheque/PO for only £8.95 direct to

GREYHOUND SOFTWARE

Kennel Cott, Hockley Lane, Wingerworth, CHESTERFIELD S42 6QQ
Telephone enquiries: 0246 235233 Mon-Sat 6pm-8pm

NEW!

3 1/2" DISC DRIVE £89.95

800K STORAGE CAPACITY

This quality TEAC drive is just 1" high and, when used with Rodos (ROM), Romdos (ROM) or Ramdos (DISC), can store 800K of files without flipping the disc. It is supplied cased. Power supply and cables are included.

Please state 464/664/6128.

When supplied with Rodos, price is	£119.90
When supplied with Romdos, price is	£124.90
When supplied with Ramdos, price is	£114.90

The amazing ROMBOARD XTRA including 6128 UPGRADE SOCKET

464 Only

- FEATURES plus - 6 Standard ROM Sockets
Put a 6128 ROM in the 7th socket and you have a working 6128 operating system. Upgrading is as simple as that!
- plus - 464/6128 selector
- plus - Cold start RESET BUTTON
- plus - Through connector for further expansions

ALL THIS FOR JUST £20

6128 ROM £19.50

64K RAM PACK £49.95

THIRD DRIVE SWITCHING CABLE

Connect to any combination of 5.25", 3.5" or 3" disc drives.

ONLY £8.50

(Please state makes of drives if known)

6128/664

MICROSTYLE

DEPT AA, 212 Dudley Hill Road, Bradford BD2 3DF
Tel: 0274 636652

Star turn

At last Seven Stars have released a CPM+ version of *Qualitas*. PAT McDONALD gazes thereon.

QUALITAS utility pack for CPM+

£9.95 disk only
Seven Stars ☎ 06284 3445

Sometimes what some printers produce leaves a lot to be desired – the NLQ on the DMP2000 springs to mind. And though you want your documents to look different, one word-processed page looks very much like another.

Qualitas is the definitive print enhancer for the CPC. The idea was that it would work on the vast majority of software, including *Protex*, *Tasword* and *Mini Office 2*. It was first reviewed in AA22, and since then has undergone a number of enhancements, most notably in *Qualitas Plus*, now the standard version. This includes a program to use the extra memory of a 6128 (or 464/664 with a RAM pack) to store more fonts at once. It also worked across a greater range of printers.

And now what? Seven Stars supremo Ray Eckersley has designed two new patching programs to get *Q Plus* working with CPM+, the free operating system included with the 6128. This was the main failing of *Q Plus*, in that although it worked on the mainstream of programs (ones which worked in Amsdos, the 'stand alone' operating system on the Amstrad) it wasn't at all happy with CPM programs, such as *SuperCalc 2*, *dBase 2* or any of the many hundreds of Public Domain pro-

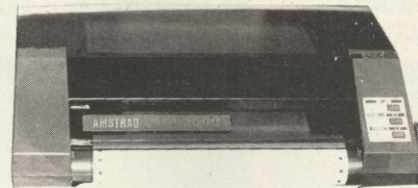

● Amstrad DMP 2000: not the prettiest of printing

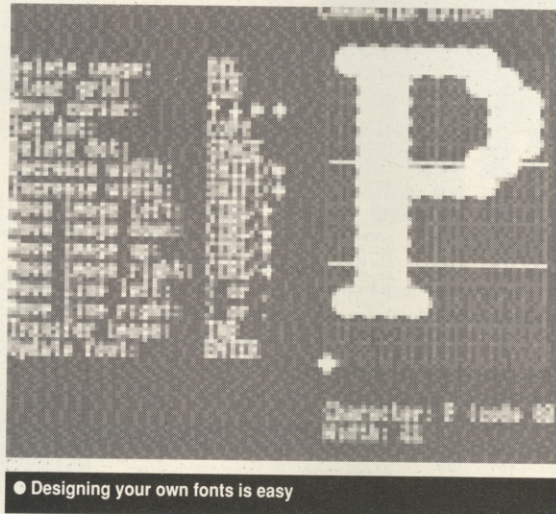

● Designing your own fonts is easy

grams. Now this has been rectified.

How it works

There are two versions of the loader program, for two different purposes. *QBDOS* is the general purpose program, which works happily with most applications. It can hold three different fonts at a time.

QBIOS, however, is less flexible, only supporting two fonts at once. It works at a much lower level than *QBDOS*, though, meaning that it works with virtually all software. The few exceptions are the ones which also work in this way. And since they would have to be written especially for the CPC, they'll be few and far between.

Q Plus moves into action before any application programs are in operation. It then remains dormant until a 'wake up' code is sent by a program into the printer.

GOOD NEWS

- Very impressive results.
- Works with a lot of software.
- Documentation is 'step by step.'

BAD NEWS

- Still tricky to set up.
- Useless without *Qualitas Plus*.

Extras

There are three font disks available: the *News Desk* pack contains four fonts, the *Display* pack ten, and the *Clarion/Pica* pack 16 (the latter though is eight different language versions of the same font).

The most attractive (and therefore useful) are the *News Desk* fonts. But decide for yourself. Each disk costs £9.95, but you can buy all three for £19.95. If you supply the disk to copy onto, they just cost £6.95.

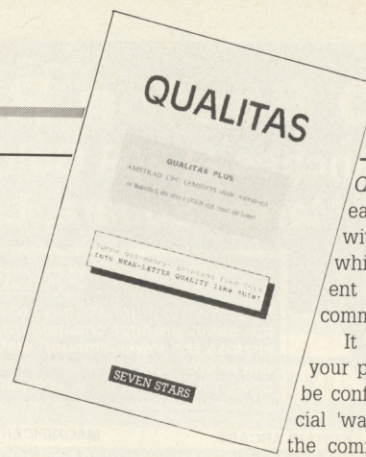

Qualitas then interrupts each code, replacing it with a complex protocol which prints out the different fonts using graphics commands.

It therefore follows that your program must be able to be configured to send the special 'wake up' codes, and also the commands to switch fonts.

Boxes can also be printed out with this utility, to make areas of text more visually striking.

Of course if your program can't be set up to send strange codes to the printer, it's going to have problems! There is a remedy, in that if files which need to be printed can be saved in ASCII, then there is a stand alone loader included called *QTYPE*. It's not as convenient as having the extra fonts invoked automatically, but *QTYPE* proves to be a useful catchall.

Flipside

The *Qualitas* code itself is not included. There are also no fonts included on the disk, and no editor to create your own. All this means that you must have *Q Plus* as well as the CPM+ loaders.

A further point to note is that a loader, *Q Plus*, and the fonts have to be on a disk. Add the application program itself: in some cases there won't be any room left for any data. On a similar note, *Qualitas* does grab some of the TPA (usable memory) for itself: 7K with one font, 11K with two and 16K with three.

Even with these drawbacks, this CPM+ patcher adds a lot more potential to an existing product. Well worth considering if you want to make an impression with some printed material produced under CPM+. ●

This is Clarion

Mercury for sharpness

And at double height

Plazza is stylish

Double width it looks like

This is Elite

Finally Pica

Which can be underlined

● Examples of *Qualitas Plus* fonts

S.D.C. 60 Boston Road, London, W7 3TR

Other branches at 309 Goldhawk Road, London W12 8EZ

18 Market Square, Leighton Buzzard, Beds.

ENQUIRIES
01 567 7621

PRICE PROMISE

If you wish to purchase any product from our list and find that you can buy the same product cheaper from another mail order company, simply enclose the lower amount, stating the name of the other company and where you saw the advert. (It must be the current issue). Price Promise does not apply to other companies "Special Offers".

BUY BY PHONE
RING 01 741 1222 or
01 995 3652 or 0525 371884

KONAMI COIN OP HITS Only £4.99

Green Beret
Mikie
Hypersports
Yie Ar Kung Fu
Ping Pong

KONAMI ARCADE COLLECTION Only £6.50 Disc £13.95

Mikie, Jackal, Nemesis, Jailbreak,
Ping Pong, Yie Ar Kung Fu 2,
Hypersports, Shao Lins Road,
Green Beret, Yie Ar Kung Fu

MAGNIFICENT 7 ONLY £6.50 DISC £13.95

Head Over Heels
Cobra & Arkanoid
Short Circuit & Wizball
Frankie Goes to
Hollywood Great Escape
& Yie Ar Kung Fu

TOP 10 COLLECTION ONLY £6.99, DISC £9.99

Sabateur, Sabateur II,
Sigma 7, Critical Mass,
Airwolf, Deep Strike,
Combat Hints, Turbo
Esprit, Chanatos,
Bombjack II.

THEY SOLD A MILLION III ONLY £4.99

Fighter Pilot
Kung Fu Master
Ghostbusters
Rambo

LIVE AMMO ONLY £5.99 DISC £12.50

Rambo
Great Escape
Top Gun
Army Moves
Green Beret

THEY SOLD A MILLION II ONLY £4.99

Bruce Lee
Knight Lor
Match Point
Matchday

GAME SET AND MATCH ONLY £6.99 (DISC £13.95)

Featuring: Basketball, Soccer,
Vault, Swimming, Shooting,
Archery, Triple Jump, Weight-
lifting, Ping Pong, Pistol
Shooting, Cycling, Springboard
Diving, Giant Slalom, Rowing,
Penalties, Ski Jump, Tug of
War, Tennis, Baseball, Boxing,
Squash Snooker/Pool.

LEADERBOARD PAR 4 ONLY £10.99 DISC £14.50

Leaderboard,
Leaderboard
Tournament,
World Class
Leaderboard

6 PACK VOL 3 ONLY £7.25 DISC £10.50

Ghost Goblins
Paperboy
Enduro Racer
Dragons Lair
Living Daylights

BEST OF ELITE VOL 1 ONLY £4.99

Bomb Jack,
F Bruno's Boxing
Commando, Airwolf

BEST OF ELITE VOL 2 ONLY £5.99

Paperboy
Ghost 'n Goblins
Space Harrier
Bombjack II

AMSTRAD	RRP	OUR	DISC
1943 Battle For Midway	9.99	8.50	12.50
4x4 Off Road Racing	9.95	8.50	12.50
Afterburner	9.99	7.25	10.50
Airbourne Ranger	9.99	10.99	13.99
Barbarian II	9.95	6.95	10.50
Batman	9.95	6.50	10.50
Blasteroids	9.95	6.99	10.50
Bomboozal	9.99	6.99	8.99
Butcher Hill	9.99	6.99	10.50
By Fair Means or Foul	9.95	6.99	10.50
Captain Blood	9.95	6.99	10.50
Crazy Cars II	9.99	6.99	10.50
Cybernoed II	9.95	7.95	10.50
Daley Thompsons Olympic Challenge	9.95	6.50	10.50
Dark Fusion	9.95	7.99	10.50
Dragon Ninja	9.99	6.99	10.50
Dynamic Duo	8.99	6.50	10.50
Echelon	12.99	10.50	12.50
Eliminator	9.99	7.25	12.50
Emlyn Hughes Int Soccer	9.95	6.95	8.99
F16 Combat Pilot	14.95	10.99	13.99
Fernandez Must Die	9.95	6.99	10.50
Football Director	8.95	6.50	
Football Director II (Disc only)	19.99		13.99
Football Manager II	9.95	5.95	10.50
Four Soccer Simulator	9.99	6.99	10.50
Galactic Conqueror	9.99	6.99	10.50
Gary Linekers Hot Shots	9.99	8.50	12.50
Guerrilla Wars	8.95	5.99	10.50
Gunship	14.95	10.50	13.99
Heroes of the Lance	9.99	8.50	12.50
Human Killing Machine	9.99	8.50	12.50
Incredible Shrinking Sphere	9.99	7.25	12.50
Last Duel	9.99	7.99	12.50
Last Ninja II	9.99	8.99	10.50
LED Storm	9.99	6.99	12.50
Microprose Soccer	14.99	10.99	13.99
Nethenworld	9.99	7.99	12.50
Night Raider	9.95	8.50	12.50
Operation Neptune	9.95	6.95	10.50
Operation Wolf	8.95	6.50	10.50
Pro Soccer Simulation	9.99	6.99	10.50
Purple Saturn Days	9.95	6.99	10.50
R-Type	9.99	7.25	10.50
Red Storm	9.95	6.99	10.50
Renegade II	9.99	6.50	10.50
Return of the Jedi	9.95	5.99	10.50
Road Blasters	9.99	8.50	10.50
Robocop	9.95	5.99	10.50
Roy of the Rovers	9.99	7.50	12.50
Savage	8.99	6.50	10.50
Storm Lord	9.95	6.99	10.50
Superman-Man of Steel	9.95	6.99	10.50
T-Wrecks	9.99	8.50	12.50
The Games Winter edition	9.99	8.50	12.50
The Munsters	9.99	6.99	10.50
Thunderblade	9.99	6.50	12.50
Tiger Road	9.99	6.50	12.50
Times of Lore	9.95	6.99	10.50
Titan	9.99	6.99	10.50
Total Eclipse	9.95	6.99	10.50
Trivial Pursuits New Beginning	14.95	10.50	13.99
Tyger Tyger	8.99	6.50	10.50
Typphoon	8.95	6.50	10.50
Vindicators	9.95	6.50	10.50
War in Middle Earth	9.99	7.50	
Wec Le Mans	9.95	6.99	10.50

SPECIAL OFFERS	RRP	OUR
Arkanoid	8.95	3.99
Arkanoid II	8.95	4.99
Army Moves	8.95	3.99
Auf Wiedersehen Monly	9.95	3.99
B. Clough F/Ball Fortunes	14.95	4.99
Baseball	9.99	4.99
Biggles	9.95	1.99
Bombjack II	9.95	2.99
Dandy	9.95	2.99
Elevator Action	9.95	1.99
Empire Strikes Back	9.95	4.99
Enlightenment Druid II	9.95	2.99
FA Cup Football	8.99	1.99
Firefly	8.95	3.99
Game Over	8.95	3.99
Gauntlet	2.99	2.99
Gryzor	8.95	3.99
Gutz	8.95	3.99
Head Over Heels	8.95	3.99
Jail Break	9.95	1.99
Jewels Of Darkness	14.95	5.99
Lee Enfield Space Ace	9.95	1.99
Mask II	8.99	2.99
Matchday II	8.95	4.99
Nemesis	8.99	1.99
Nostalgia The Vampire	8.99	1.99
Not A Penny More Not A Penny Less	14.95	3.99
Platoon	9.95	5.99
Prodigy	8.99	1.99
Project Future	8.95	1.99
Rania Rama	8.95	1.99
Renegade	8.95	1.99
Return of the Jedi	9.95	4.99
Silicon Dreams	14.95	5.99
Spitting Images	8.99	4.99
Split Personalities	9.95	4.99
Star Wars	9.95	4.99
Starglider	14.95	5.99
Super Sprint	9.95	3.99
Target Renegade	8.95	4.99
Tarzan	9.95	2.99
Thing Bounces Back	9.95	3.99
Three Weeks in Paradise	9.99	2.99
Trivial Pursuits	14.95	5.99
Vindicator	8.95	4.99
Vixen	9.95	3.99
Way of the Tiger	9.95	2.99
Wec Le Mans	8.95	5.99
Wizball	8.95	3.99

SPECIAL OFFER DISCS	RRP	OUR
Animator	19.99	7.99
Convoy Raiders	14.95	4.99
Final Matrix	14.95	4.99
IK+	14.95	5.99
Knightmare	14.95	5.99
Super Hang On	14.95	5.99
TT Racer	14.95	6.99
Way Of The Tiger	14.95	5.99
Wonderboy	14.95	5.99

BUDGET GAMES

BMX Ninja	1.99
BMX Simulator II	2.99
Commando	2.99
Dan Dare II	2.99
Footballer of the Year	2.99
Ghostbusters	2.99
League Challenge	2.99
Rock N Wrestle + BMX Kidz + Ninja Master	2.99
Rygar	2.99
World Games	2.99

MEGA GAMES VOL ONE ONLY £9.99 DISC £12.99

Northstar, Cybernoed, Deflektor,
Mask II, Triaxos, Tour De Force,
Blood Brothers, Hercules, Master
of the Universe, Blood Valley

FLIGHT ACE ONLY £9.99 DISC £13.99

Air Traffic Control, Ace, Spitfire
40, Strike Force Harrier,
Tomahawk, A.T.F.

ANY GAME NOT LISTED PLEASE CONTACT US FOR PRICES AND LIST OF SOFTWARE.

SUPREME CHALLENGE ONLY £7.99 DISC £12.50

Elite, Starglider, Tetris,
Ace II, Sentinel

TAITO COIN OPS ONLY £7.99

Rastan Flying Shark,
Bubble Bobble, Arkanoid II,
Slapfight, Legend of Kage,
Arkanoid, Renegade

IN CROWD ONLY £10.99

Barbarian, Gryzor, Crazy
Cars, Predator, Karnov,
Combat School, Target
Renegade, Platoon

GIANTS (WORLD BEATERS)

ONLY £9.99 DISC £14.50
Gauntlet II, Rolling Thunder,
California Games, 720°,
Outrun

S.D.C. ORDER FORM (AMSTRAD ACTION MAY ISSUE)

Please send the following titles. BLOCK capitals please!

Type of computer

Amount

Title:-

Name

Address

Postcode

Tel. No.

Total Enclosed £

Please make cheques or postal orders payable to S.D.C

Europe please add £1.00 per tape:

Elsewhere please add £1.50 extra per tape



PICK OF THE MONTH **STAR BUY**
10 COMPUTER HITS VOL 5
ONLY £6.99 DISC £11.99
Dark Sceptre, Tarzan, Catch 23,
Mystery of the Nile, Endurance,
Mega Apocalypse, Ninja Hampster,
Activator, The Boggit,
Druid II

ACTION TEST

He's a Human Games Reviewing Machine... He's **TRENTON WEBB!**

- **HKM** - not for pacifists! (this page)
- **MASTERGAME: BARBARIAN II** (p.38)
 - **Question of Sport** (p.36)
 - **Jinks** (p.40)
 - **SDI** (p.41)
 - **Crazy Cars II** (p.42)

**MASTERGAME
BARBARIAN II
pages 38-39**

Blasterooids 45
Crazy Cars II 42

HE'S THE MEANEST SON OF A SNAKE YOU'VE EVER SEEN!

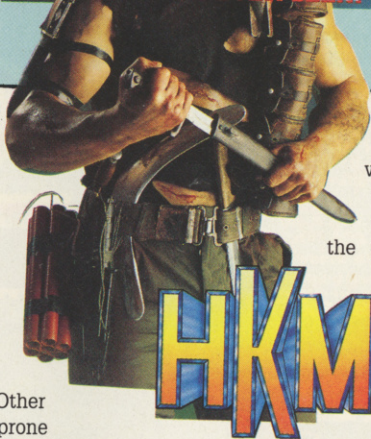

Jinks	40
Human Killing Machine	35
Pacland	45
Question of Sport	36

Competition time! 47

RAVES	
SDI	41
Crazy Cars II	42

HKM

US Gold ● £9.99 cass, £14.99 disk joystick/keys

The meanest son of a snake you've ever seen! That's how the pack describes the *HKM*, the *Human Killing Machine*. You can't help but be intrigued as to the nature of the game, how it plays and above all by the chap's odd parentage.

HKM is about running around, jumping up and down and hitting people. You visit five countries and beat the living daylights out of two Arabs, two Germans, two Dutch women,



● Kwon fights anything - dogs, bulls, guerillas!

a Russian, a Spaniard, a bull and a dog. I think that offends just about everyone, don't you?

The graphics feature cartoon-style warriors fighting in famous parts of the world: a Spanish bull ring, war-torn streets of Beirut, the red light district of Amsterdam. As each blow lands on target 'POW!' or 'ZAP!' appears in the colours of the successful fighter.

As the fighting begins you battle Igor in Red Square, Moscow. He's your everyday trendy Russian soldier, with furry boots, furry hat and an oversized rifle. You need to knock him down three times to defeat him, whereas you can survive five knockouts - a knockout occurring after three clean punches.

Igor, like the others, has a special ability and a specific weakness. He uses his rifle to

bat your poor little Kwon sprite around in a seriously damaging fashion. But this selfsame weaponry slows him down, making him vulnerable to flying and sweep kicks. Other adversaries are prone to punches or somersault kicks. It's a case of learning the hard way, though, because the packaging gives no clues whatsoever.

No sooner do you beat one villain than up pops their sidekick to do unto you as you did unto his pal. In the bullring, for example, Miguel is easy to fight - compared with his supporting act, Brutus the bull.

You must beat these people and animals convincingly, because your future state of health depends on how you fare against your current opponent. If you manage to thrash them keeping all your lives, Kwon's healthy state determines a favourable ratio of knockdowns needed to win vs. knockdowns withstood for the next stage. If you only just survive, however, Kwon is tired and needs as many, if not more, knockdowns than his opponent to win through. Life's tough, ain't it?

So with many roads to travel and people

SECOND OPINION

"I disagree entirely with Trent on this one! The sprites are really well done, even to having anatomically incorrect but very convincing legs (they're too long). If you enjoyed Target Renegade and Bad Dudes vs. Dragon Ninja you'll love HKM. Mindless fun!" SC

GREEN SCREEN
you 'kwon' see clearly!

to beat, this fightseeing tour with various villains and their odd little ways is good fun. But just kicking and punching shows limitations in the gameplay - let alone a seriously impoverished moral sense. The cartoon nature of the graphics gives Kwon and adversaries a superhero touch, and even the stately pace of sprite movement cannot detract from the satisfaction felt when you finally work out how to beat each nastie, and can proceed to your next port of call and more scenic violence. I reckon you'll enjoy *HKM* a whole lot to begin with, but the interest may tail off after a few hours.

TW

FIRST DAY TARGET SCORE

Get to Amsterdam

The Verdict

GRAPHICS 72%

- Great sprites and settings.
- Movement is rather slow.

SONICS 63%

- Punchy tune.
- Limited sound effects.

GRAB FACTOR 66%

- Has some knockout characters.
- Lack of pace is offputting.

STAYING POWER ... 72%

- Lots of opponents to fight.
- Needs a 'continue' option to prevent frustration.

AA RATING 65%

- Violence among the jet set.
- Good graphics offset a slow-paced game.

QUESTION OF SPORT

Elite ● £14.99 cass, £19.99 disk joystick/keys

Cue David. Cue blooming David! 'Am I on now? And. Yes, er, here we, ah... At long, ummmm, last, the official, well, the er, *Question of Sport*, the game they're calling. Er, *Question of Sport*. Errrm, absolutely extrornery!'

Well is it, or isn't it? Can a mere computer game capture the subtle blend of tack and sporting trivia that keeps the nation engrossed once a week? Would they want to emulate this if they could? True fans of the show were well impressed with the way it was transformed into a board game, so there have been high hopes (not to mention a long wait) for the CPC version.

The first thing to strike you is that that all time musical classic, the *Question of Sport* theme tune, is missing. Heads will roll at Elite, surely (don't call me Shirley). If one is denied the pleasure of watching a TV professional like David Coleman at work, the least you can expect is a chance to hear the music.

Play kicks off with the choice of being of Bill or Ian (what a decision!) and whether you play your CPC or a friend. Then you pick one of the ten specialist sports and the people

in showbiz just to bring *QOS* to life.

Then it's down to the nitty gritty of showing off your immense sporting intelligence. The first round, as usual, is the 'There goes Emlyn's Knighthood' picture board. Here another 'adaptation' rears its ugly head. There are no pictures, instead you get an in depth (12 word!) description of a sporting star or event, with four answers to choose from. Even in questions about phenomenally dull sports such as show jumping (whoops there goes *my* Knighthood) you don't get a chance to humiliate yourself with a completely wrong answer. Not really in the *Question of Sport*

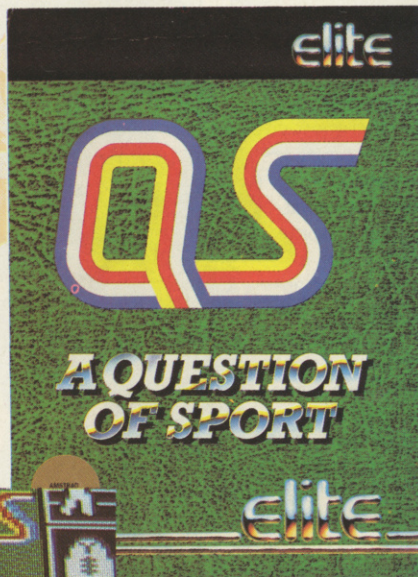

● 'Er-r-r, truly remarkable... Over to Bill for a bonus?

who make up your team. These are presented in the form of the infamous 'It's either Princess Anne or Viv Richards, David' picture board, though naturally the names have been changed to protect the innocent. Ahr ould mite Noigel Mansell, for instance, becomes Gary. Fair enough, they can't pay everyone

SECOND OPINION

"Elite have taken on a tricky task, converting quite a visual and immensely popular game. And I think they've done as well as can be expected. We certainly had fun with it here in AA Mansions." SC

GREEN SCREEN
good on yer, sport!

vein is it? 'Who won the F.A. Cup in 1942?' - 'Er, was it Shergar, David?'

David 'our hero' Coleman then guides the teams through the rest of the traditional *QOS* sections: mystery personality; home or away; the quick fire round; and what happened next. All are faithfully reproduced, except that words replace pictures. This, however, doesn't dampen

the *QOS* spark, for even in this very static form it is an enjoyable quiz format. The programme and the game are both fragmented enough to avoid boring too many people for too long, with enough continuity to ensure that when the other team do get ahead on points, it does matter. I mean, being beaten by *Bill Beaumont*? This is *major league shame* we're talking here!

QOS scores over all its rival triv. games simply because it has a tired, er *tried* and tested formula, and is based on a two team principle. Playing on your own leaves you sneering at the opposing captain's errors - or fuming when they start to get all the easy questions! Playing in a group soon elicits strong loyalties to your beloved leader, be it Ian or Bill.

If you like sport and/or cheap TV shows you are in for a treat. The structure is a mite constricting, and there are features which



● Ooh, ooh, I know this one...

would make the game more playable but less like the Telly. A 'Could you please say that again David, I was slurping me coffee?' feature would be very useful, for instance, but would ruin the authenticity. Similarly the speed of the game varies vastly from snail's pace in the home and away round, to ridiculously fast in the quick fire round. This lifts the game, even if it's a bit annoying at times, especially since you only have six rounds to prove you're a sports trivia Einstein and not a complete Billy Beaumont.

Question of Sport has an obvious target public, but will confirmed *Quezzie* addicts get enough for their 15 or 20 quid? (Scandalous pricing, incidentally.) Initially yes: it's remarkable how a little picky of our Dave jabbering away will satisfy and entertain the die-hard fan for a while.

Yet even the most fanatical viewer only has to enjoy/endure (delete as applicable) thirty minutes every week. But with the CPC game this can become every thirty minutes, and even David 'Charmer' Coleman can't take that kind of exposure and remain fresh and fun. **TW**

FIRST DAY TARGET SCORE

Not applicable

The Verdict

GRAPHICS64%

- Detailed portraits of David, Bill and Ian.
- Incredibly static visuals.

SONICS32%

- The audience claps. The clock ticks. The buzzer buzzes. And that's it - no theme tune!

GRAB FACTOR72%

- Surely you can't lose to *Bill*?

STAYING POWER 61%

- Play sparingly and interest will last.
- Overdo it and you'll get very bored.

AA RATING60%

- Loved the show? You'll love this!

ROMANTIC ROBOT present

THE ULTIMATE PERSONAL COPIER

£5 OFF!

RESET **Multiface two** STOP

If you wish to **FREEZE** any program any time and **COPY** it to **disk/tape**, *fully automatically, at a touch of a button*, then the **MULTIFACE TWO** is the **ONE and ONLY** answer! It is *extremely* simple to use, idiot-proof, *menu driven* with *on-screen instructions*, 100% reliable - **PURE MAGIC...**

Just **RUN** any program, **STOP** it by the **FREEZE BUTTON**, **SAVE PROGRAM** or **SCREEN** to **disk/tape** or use built-in **MULTI-TOOLKIT** to study, **POKE** infinite lives, ammo, etc. When you **RETURN** to the program or **RELOAD** it next time, it will *automatically* **CONTINUE** from where frozen. You **DON'T** need to do **ANYTHING** - just *push* the button, *name* the program, *insert* disk/tape and *press* a few keys.

MULTIFACE works on **ANY CPC**, needs **NOTHING** extra, and *pays for itself*: by buying 10 tapes instead of disks you can save some £50 - and **MULTIFACE** is only ~~£47.95~~ NOW ON **SPECIAL MAIL ORDER SALE** at just ~~£42.95~~!

Tape-to-disk at the touch of a button. Ridiculous, you may say, but it works every time. *Multiface* can stop any program in its tracks and save the program from memory to either tape or disk. It's completely fool-proof. Similar products have had problems with screen size, colour and even sound; *Multiface* can handle all these without a second thought.

That alone would have satisfied many people, but Romantic Robot has gone one step further, incorporating a memory editor. No program is safe with this everything is out in the open, including the Z80 registers, CRT data and any part of memory.

Don't be fooled into thinking this will result in mass piracy, however. The *Multiface* unit itself must be plugged into your Amstrad to allow reloading of a program it saved.

Multiface II must be the cleverest hardware device at present - a necessity for disk owners who thought they were stuck with loading from tape every time.

AMSTRAD ACTION

**£5 OFF
MULTIFACE,
RODOS & INSIDER**

THE
RODOS
SYSTEM

Would you like to be able to attach additional disk drives - 40/80 track, single/double sided, 5.25 or 3.5 or 3 inch - and store up to 800K per disk? All controlled by a powerful DOS? Have **RANDOM ACCESS** to your files? Get a **PRINTER BUFFER** and **SILICON DISK** and a ROM manager and over 50 new bar commands! All this on a single ROM.

Now also available: **RODOS EXTRA** on disk for only £9.95. Any **RODOS** owner will find **RODOS EXTRA** indispensable: it offers nearly 200K of valuable information how to get the most out of **RODOS**, with examples of **RODOS** applications ranging from simple to complex such as a **DISK DOCTOR** or **IBM MSDOS DISK READER**. The indispensable **EXTRA!**

£5 OFF

£5 OFF only with the coupon below received 1.4 - 15.5.1989

INSIDER needs MULTIFACE. RODOS needs a romboard.
- RODOS EXTRA needs RODOS. We all need a holiday.

Do you wish to know **ALL** the **INSIDES** of any CPC program? Get **INSIDE INFORMATION!** Install **INSIDER** into **MULTIFACE 2**, **RUN ANY** program, **FREEZE** it and the **INSIDER** reveals **everything**: it fully *disassembles*, *finds* text or code, *shows/alters* RAM and Z80 registers, *dumps* to printer, etc. All this and more for ~~£14.95~~. Now on **SALE** for just ~~£9.95~~! Invaluable for m/code users and hackers!

ROMANTIC ROBOT
£5 OFF
THE INSIDER

MAKE YOUR CPC HAPPY: BUY IT A MULTIFACE!

I Order: MULTIFACE 2 £42.95 RODOS £24.95 Plus p&p UK £1, EUROPE £2
INSIDER £9.95 RODOS EXTRA £9.95 Overseas £3

I enclose a cheque PO for £ or debit my No Card exp.....

Name & address

ROMANTIC ROBOT LTD 54 Deanscroft Ave, London NW9 8EN 24 hrs 01-200 8870 AA

BARBARIAN II

Palace ● £9.99 cass, £14.99 disk
joystick/keys

The story so far: the Barbarian has just rescued the fair Princess Mariana from Drax, an evil wizard with a Maria Whitaker fixation. During the melee Drax does a runner leaving the *Barbarian* with the girl but no-one to chop into little pieces.

The escape of such a dangerous and generally nasty character causes much consternation, and the increase in insurance premiums, in the land of the jewelled. He must be stopped before he gets a chance to lay waste to them all with black magic, incredible monsters and exploitative posters. It's decided that the only reasonably entertaining course of action is to hunt Drax down and slap his wrist once and for all.

The job will be difficult, involving an arduous journey to the lair of the wizard and defeating hordes of his hideous creations. Only two people are skilled (and psychotic) enough in the arts of war to stand any chance of success: Barbie and the Princess Mariana. Yes, it seems as well as wearing skimpy tin



diki-
nis, she's also hot stuff
with the sword, which proves she's not just a
pretty... uh... face.

So as the adventure starts you choose who you play as: meathead or bimbo? There is no difference between them, except that she wields a sword and parades semi-naked while he uses an axe and sports designer furry trunks, but both hack and slash like good'uns. These star characters are drawn brilliantly as comic book warriors, and their movements instantly catch the eye. They move as real human beings and not games sprites, especially when you fall foul of some creature and go to meet your maker. After being pushed to the edge of a pit by some monster, even these hardened homici-



dal maniacs flail their arms in a vain attempt to gain balance before plummeting to their doom.

The game takes place over four levels, three of which are mazes and the fourth of which is the inner sanctum of the Drax's bolt-hole. You start in a wasteland with your threefold task. First you must find the entrance to the next level; secondly, collect certain magical artifacts needed later on; and thirdly, kill as many monsters as you can lay your axe on.

The creatures, who want to give your life insurance man an ulcer, are the main feature of the game. They provide not only the opposition, but also the black humour that gives the game its edge. Each level has a different menagerie of beasties, and each one has different a mode of attack and real comic quality.

In the Wasteland you meet red apes who swing at you with oversized feet, mutant chickens who try to peck you to death (and very good at it they are too!) and a purple something with a whiplash tongue. The stars, though, are the cavemen and the dragons. The Neanderthals come at you swinging clubs and when successful in taking one of your five lives, they look at the screen and laugh, revealing their prehistoric gnashers. The dragons also gloat at your demise; after your head is bitten off you watch it being swallowed, a snack followed by a hearty belch. Similar gory jokers appear on each level, but perhaps the best of them all is the lion type thingy, which knocking you to the ground proceeds to munch the parts that other beasties cannot reach. Grotesque, but great fun.

The *Monty Python* style of bloodletting is not the sole domain of the creatures, because Babs and Mariana have a go too. If you manage to get your sword strokes right, you can send heads flying from the shoulders of cavemen (that'll learn 'em!), mutant chickens can be carved up and dungeon guardians can witness a quick bit of open heart surgery courtesy of your ever trusty sword.

Barbarian II sports great peripheral graphics to help the game (and your axe) go with a

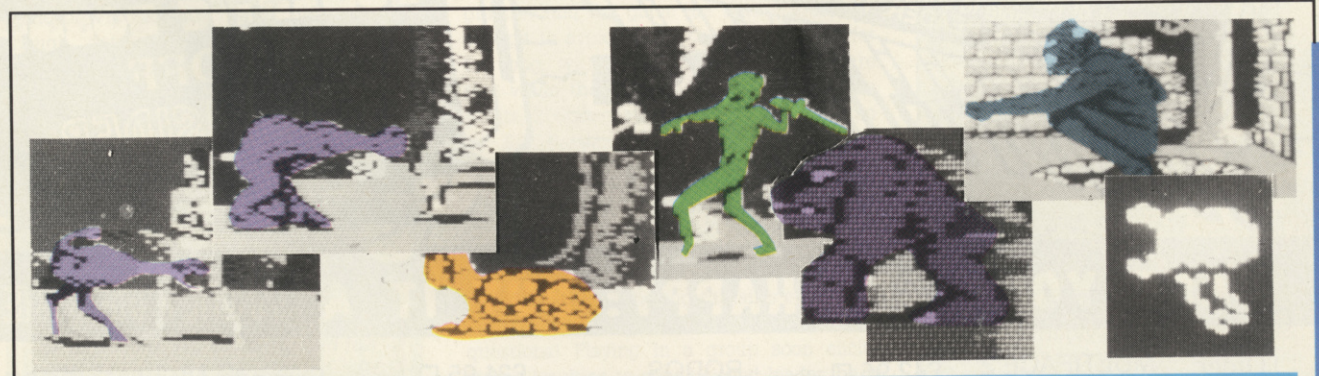
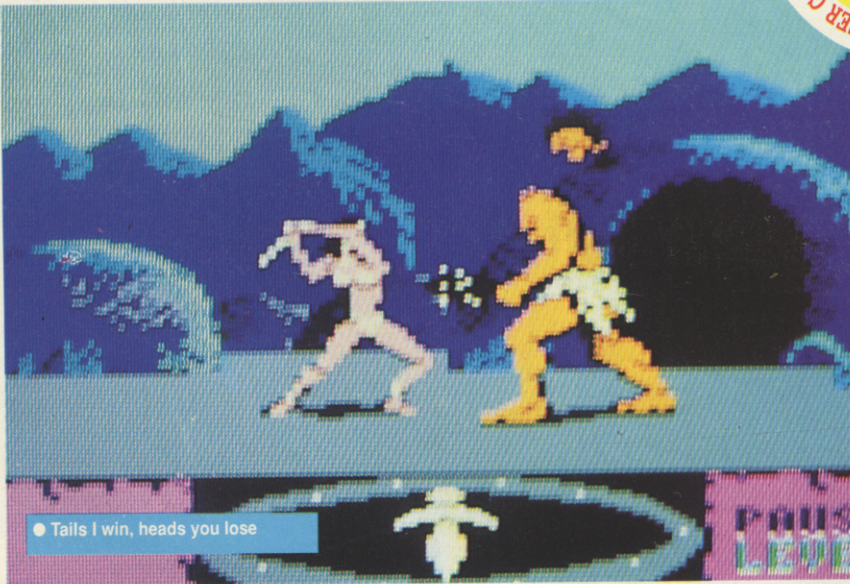

● The ugly mugs' ball - from left to right: sword swallowing turkeys, purple punchers, lopsided crabs, malnourished orcs, boot-boy baboons, giant red beggars and a flying sheep!

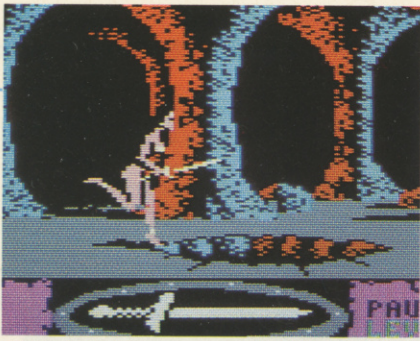

● Watch the first step, it's a big one....

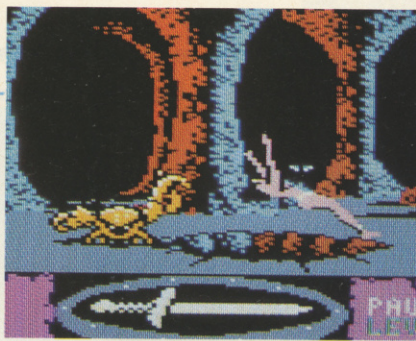

● Enjoy this trip

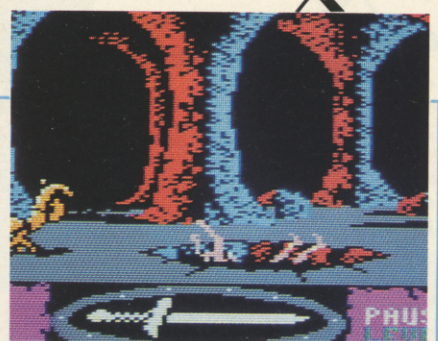

● It's the pits, man (or woman)

swing. Your energy and that of the nearest opponent is indicated clearly by bars at the top of the screen, while shining jewels tell you how many lives you have left. A sword that always points north helps you find your way through the wasteland, caverns and dungeon. Your current total of points is also shown in the bottom corner - but let's face it, who cares about points? Just send in the orcs!

Hack'em up fans will love the swordplay element of *Barbarian II*. Your hero despatches

SECOND OPINION

"It's been a long, long wait for Barbarian II, and now that we've seen the finished result it's pretty obvious why. Palace have really put everything into this one, and while the scenario is still a little dim-witted - meet a monster, kill it or be killed - it's all done with such enthusiasm, skill and style that I found myself itching to play it again and again.

Any game that makes me laugh out loud as my character gets killed must be worth buying!" SC

GREEN SCREEN
looks well mean even in green!

enemies in a multitude of ways, including a spinning neck chop which breaks the ice (amongst other things) at any of Drax's parties. But those who prefer a little more brains with their blood will also find the game great fun, with mazes tricky enough to have you going round in circles for days. The collection of the artifacts adds a greater level of gameplay to the slaughter, for while they are not necessary to get to the next level, they just might save your life.

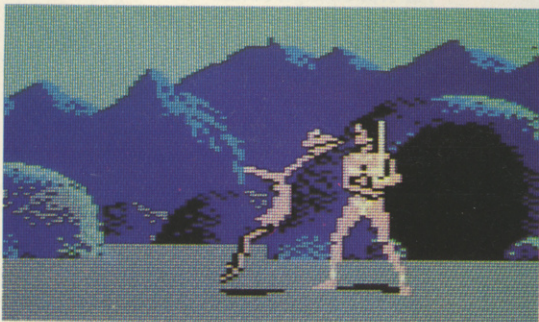

● Feeling a bit peckish, were we?

Barbarian II is both highly playable and infuriatingly difficult at the same time. It blends extreme violence, black humour and the puzzling mazes so well you can hardly see the joins. The sight of a sword-wielding woman getting eaten by a lion may upset certain people (including the lady herself, no doubt) but the humorous tone taken, even when the blood starts to spurt out of your neck, offsets most of the offensive elements. There will no doubt still be an outcry about the gratuitous violence in the game. But what are those people who are easily offended doing buying a game called *Barbarian II* anyway? TW

FIRST DAY TARGET SCORE
Get to the second level

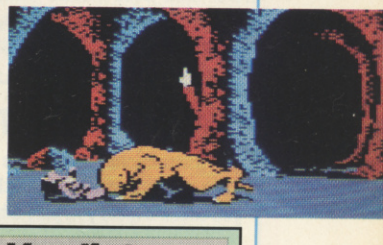
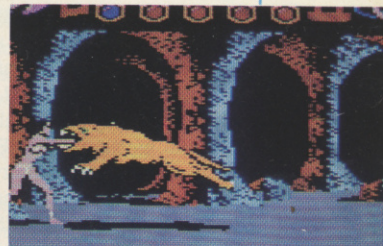
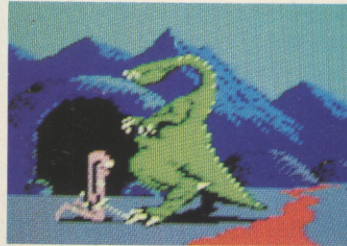
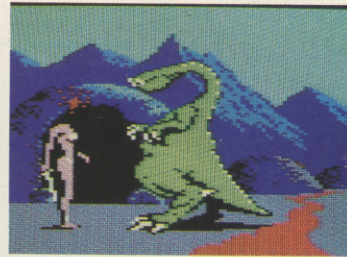

The Verdict

GRAPHICS 93%

- Outstanding realistic character movement.
- Amazing, amusing array of monsters.

SONICS 88%

- No tunes.
- Witty extra effects such as laughter and pitfalls.

GRAB FACTOR 94%

- Instant swordplay fun.
- Plenty to explore.

STAYING POWER .. 89%

- Multitude of monsters to find and kill.
- Mazes may be too irritating for prolonged play.

AA RATING 92%

- Sharpen that axe! Polish that sword! Let's get hacking!
- A fun game to play and watch.

JINKS

Go! ● £9.99 cass, £14.99 disk joystick



Never judge a game by its cover. There you are in the shop, reading the *Jinks* inlay and hoping for a game based on surveying the planet Atavi. Load it up, and you're faced with something suspiciously like *Breakout*.

Jinks is the latest offering from Rainbow Arts, a German software house of some repute, marketed by Go! The idea is to use a bat to hit a ball down a corridor from left to right and through a teleporter, marked by a set of orbiting stars. The bat can be flipped

over: one side is flat, the other curved. The bat also apparently has a hole in it, leading to the most appalling misses (*I've got a squash racquet like that - ed.*)

Obstacles are the usual *Breakout* style bricks, but there are others. Extra lives can be culled from one pyramidal type - the drawback is that a bat-smashing monster looks exactly the same, except that it moves! A green blob uses similar tactics. The ball can go through moving monsters, but a stationary mouth gobbles it up in an instant.

Boxing clever

The instructions for *Jinks* are misleading. They allege that there is a title tune; that if you finish a level you play a bonus level, and then choose which level you play; that you can play on keys; and that the ball can shrink. None of this is true in the Amstrad version.

The game elements which really leave you screaming are the bumpers, of which there are two types, one tall and thin and the other short and fat. When the ball hits one of these it ricochets, usually predictably but sometimes in an extraordinary, random direction.

Before you start you can alter both the speed of the ball and the 'gravitation' - how high it bounces - though the speed of bouncing remains constant. That's unlike real gravity, but the game is more playable as a result.



● It's bouncy, bouncy, it's very very bouncy...



● Level three - on the dull side

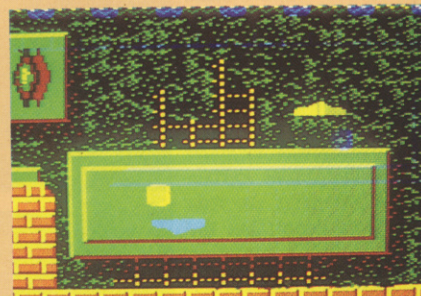

● Boris Becker couldn't hit that one!

The thing you need to know about *Jinks* is that it's fast. Even at the slow levels, control of the ball is very difficult. Sooner or later you master the first level (as the ball can't 'die' you just keep whacking it to the right), and then the fun really starts. Because level two is seriously difficult.

Level three by contrast is a cinch. All that

SECOND OPINION

"Getting the difficulty level right for any Breakout-type game is always a bit of a nightmare, and here I'm afraid Rainbow/Arts - Go! have just got it wrong. Sure the real champ waggles out there will wonder why the fuss, but for those of us who haven't passed our Advanced Wagglers Test Jinks is just going to prove too much.

Looks great, though." SC

GREEN SCREEN
playable - but dull

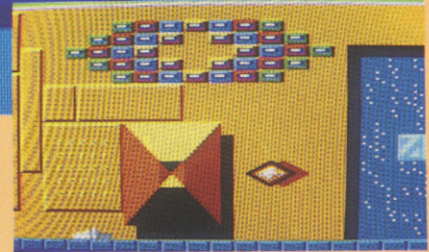

● It does look a little like Breakout

remains is level four, which I haven't even come close to completing. And that's it: four levels. There is no more. Because of the lack of game, Go! make it incredibly difficult to play.

Graphics, though very colourful, lack definition. There aren't enough clean edges: most of what's on the screen is just so much pretty background. *Jinks* looks impressive, but you soon appreciate that the majority of the screen doesn't do anything!

One thing *Jinks* does well is scroll, right from one edge of the monitor to the other. The movement of the bat and the ball are similarly fast. There is a slight problem when the latter can become stuck to the roof, but you have to do it deliberately. And when the speed is set too high, the bat occasionally shudders in mid-flight.

Apart from those two things, game movement is really slick. So if you want a tough test of your joystick prowess - and your patience - *Jinks* will suit you down to the ground.

Otherwise, avoid it.

PbM

FIRST DAY TARGET SCORE

Complete the second level

The Verdict

GRAPHICS 74%

- Very bright.
- Not enough detail.

SONICS 30%

- Just jingles.

GRAB FACTOR 52%

- At first you really want to play.

STAYING POWER ... 24%

- Bo-o-oring.

AA RATING 53%

- Small and too tricky.

SDI

Activision ● £9.99 cass, £14.99 disk joystick/keys

THREE MINUTE WARNING! The Russians have launched a pre-emptive strike. Make your way to the shelters, collect what you need for the next two months, and say goodbye to loved ones allocated different shelters. Our only hope lies in our Strategic Defence Initiative, SDI... Let's just hope it's a better defence than painting the windows and hiding under the stairs with a paper bag on your head.

Activision have brought the US Senate's Strategic Defence Initiative to life for the CPC. The scenario is much the same - only it works. You pilot a satellite trying to destroy Russian missiles before they get affect Beverly Hills property prices. If any get through you have to defend cities individualy.

Your ship would win no prizes as *Vogue* starship of the month, let alone *Vogon*. You have only one laser to begin with (the cheek of it!), aimed with a

roving cursor. Land the cursor on or near an enemy and blast away: accuracy is not of paramount importance when dealing with megaton missiles.

In the first offensive half you get used to the cursor/fire control - OK with a joystick, but awkward with keys. To move the cursor the fire button must be depressed, crowding the keyboard. This can be a little distracting when you've a ten megaton missile breathing down your neck.

The number of nukes you intercept is revealed at the end of each section by bar graphs showing the proportion of each type of craft destroyed. If you destroy 100% of incoming weapons you get bonus points, announced right in the middle of armageddon by dancing ducks!

Logic suggests you sit things out when life gets confused (we are talking Victoria station, rush hour). This play has one major drawback: let too many missiles through and earth goes up in a flash of yellow, and it's game over, how many lives you have left. Moral: keep an eye on the damage meter, and time your stints of cowardice and bravery.

Each level only lasts a short time, and then along poddles a shuttle to re-arm you and give you a lift to the next stage. On higher levels during battle, aid and assistance come as supply satellites which drop weapons pods when shot. This comes as a welcome lay-by on the rocky road to victory.

That's all there is, a straightforward shoot-the-evil-empire's-missiles-before-they-shoot-you game. Speed is needed as the fighter ships desperately try to corner you. The choice is simple: fight or flight.

The space illusion is enhanced by the drift and slight delay in response to your guidance. Overall graphic presentation is excellent, if limited in colour. But then, in space it must still pay to be camouflaged, and olive green is going to stick out a bit.

Satellites spin smoothly and the enemy's attack craft are wonderfully done, with just the right blend of sci-fi and fact to

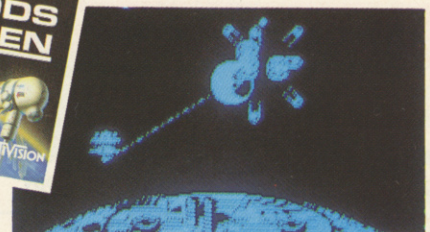

● What a spectacular Ray-gun (geddit)



● Meanwhile, up in the outer reaches of space, hanging there just the way bricks don't...

give the game fantasy menace, with a reality base. 'Star Wars' may go ahead as a project, and while the system will not work in exactly this way, it is easy to see how NASA sold the idea to a 70 year old man with a jellybean fixation.

Until the time comes when such a system is in operation, don that spacesuit and let's play global thermo-nuclear war. Remember the fate of the world is in your hands. Someone's got to stop this conflict before something serious happens... **TW**

FIRST DAY TARGET SCORE
75,000 points

The Verdict

GRAPHICS **76%**
 Great sprites.
 Not enough colour.

SONICS **55%**
 In space no-one can hear you scream.
 They can only hear you blow up.
Where's the music?

GRAB FACTOR **84%**
 Controls take some getting used to.
 Simple to play, but almost impossible to remain unrattled.

STAYING POWER .. **76%**
 Trying to score 100% draws you back again and again. And again!
 Too easy for hardened spaceshooters?

AA RATING **82%**
 Based on reality, set in fantasy.
 It almost makes the whole SDI thing seem feasible! (I did say almost.)

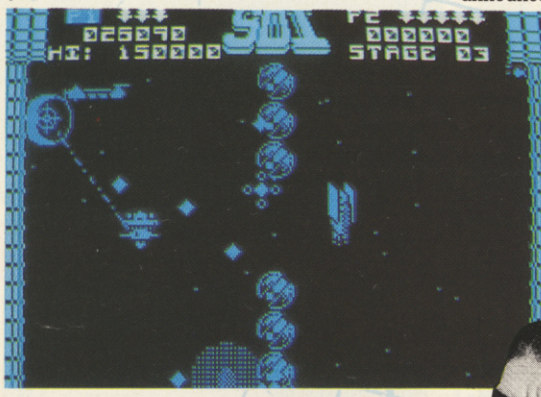

● Armageddon outta here, pal!



SPECIAL GUEST SECOND OPINION

RON, NANCY - DON'T
 Ex-PRES. RPT HOME
 MIAMI, FLORIDA
 U.S. # of A.

DEER A.A.
 My fellow americans,
 Hiya boys, how did you get Avid of
 Military Info so Secret I've forgotten it. So
 realistic, just like a movie I was in last year,
 I played the part of the president and ... hey
 don...

The real thing didnt work
 Tho' Nancy said the stars were ALL RING.
 Liked the Graffiti, especially the Ships Shaped (uh!)
 Like JELLY BEANS Good enough to eat
 I always knew World war could
 be enjoyable but THIS IS MORE FUN + NOT AS
 messy

Yours
 -ANNIE- RONNIE REAGAN

CRAZY CARS II

Titus ● £9.99 cass, £14.99 disk
joystick/keys

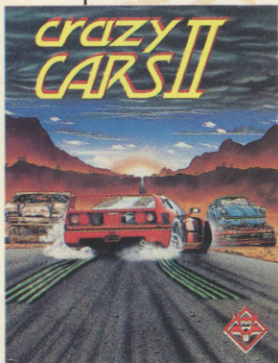

Ferrari have built some rather nippy motors down the years, but without a doubt the F40, a hunk of metal that travels from 0-60 in 3.9 seconds, produces 478 bhp and is yours for a mere £350,000 (plus VAT and p&p, plates and delivery extra), is the most awesome of them all. And now's

your chance to drive, crash or thrash one for as long as you like in *Crazy Cars II*.

The plot: a stolen car racket is plaguing America. Problem is, the perpetrators are police officers. To stop them you must cross four states without being caught. You do have the advantage, however, of a brand spanking new Ferrari F40, all fitted out with go faster extras (as if it needs them) such as radar detection devices.

Your car squeals away in a cloud of tyre smoke and the speedo busts through the magical 100kph (60mph) mark in even fewer seconds than the real thing. It bucks from side to side to gain traction, and despite its huge tyres if you get things wrong you spin out, Mansell style. As the car picks up speed it starts to misbehave, becoming harder and harder to line up for corners – and more importantly to overtake bent coppers you come

The Ferrari F40 file

- Built to celebrate Ferrari's 40th birthday
- Arguably the fastest production car ever built
- Current market value: in excess of £325,000 (estimate)
- Colour: Italian Racing Red
- Designed and built: Maranello, Italy
- Maximum speed: 203mph (estimate)
- 0-60 = 3.9 seconds; 0-120 = 10.3 seconds
- V8, twin Ihi turbos, Weber-Marelli timed injection, 2,936 cc engine: produces 478 bhp at 7000rpm
- When tested by *Fast Lane* mag insurance cost £2,500 – and that was just for one hour!

across on the road.

Speed is enhanced with some neat sound sonics: approaching and then passing a jam-jar, you hear his siren change tone (so you know when to hurl abuse safely), and the engine tone varies with revs rather than the boring monotone growl often associated with car sims. The visuals are great too, with panoramic sweeps to take you back on the road after a smash, grass spewing from your wheel arches when a short cut is taken and very neat explosions when all has failed and you've managed to target a lamppost. (Listen buddie, if you want to learn to drive I won't stand in your way, but when you crash that car of yours don't come crawling to me – ed.)

SECOND OPINION

"It's not often fights break out in the AA office, but we came pretty close this time. I tried telling Trent that as editor I should get a go at Crazy Cars II whenever I wanted.

I can't repeat his reply. I didn't understand most of it.

So I told him to go off and work on his joystick survey..." SC

GREEN SCREEN

looks fine, but Ferraris should always be red!

Gameplay is inevitably strictly limited but with a dream car to drive, a solid chase scenario and realistic routes to chase across, any CPC driver is bound to have his/her hands full. Crashing is far too easy, and this interrupts the flow of the game, but it doesn't cost you a life (who are they trying to kid, a head to head with a lamppost at 170mph and it doesn't even cost you a life?) – only time, the Big Enemy.

Sometimes you feel more as if you're driving in London than the Arizona desert, especially if you crash behind a police vehicle. They want to arrest you (but I thought they were the bad guys!), and if they get in front of you at low speed, you're nicked mate! But often after a crash, the police just wait up the road ready to pounce, and then there's no way out.

Oddly, crashing on a sliproad sometimes results in a similar no-win situation, where your shiny new motor just repeatedly explodes for no apparent reason. This has to be put down as a bug, however, rather than a feature.

Crazy Cars II is an excellent car chase game, with graphics that leave many sims standing (such as Codemasters' *Twin Turbo V8*, which stars the same car). It's not stunningly fast but it's fast enough. Play it at your peril, for while it's fun and is instantly appealing it is also

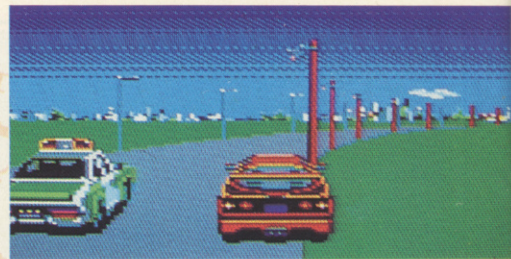

● I just hate backscreen drivers!



● Real wheel squeal!



● What a state to get yourself into! (Utah, New Mexico, Colorado and Arizona, actually)

annoyingly hard to beat. Hours will be sent crashing into trees, bollards and law enforcers. It ain't that crazy, but the car is something else. TW

FIRST DAY TARGET SCORE
get into another state

The Verdict

GRAPHICS 84%

- A really smooth ride.
- Just a teeny weeny bit slow, perhaps?

SONICS 73%

- Great title music.
- Smashing doppler effect sirens.

GRAB FACTOR 79%

- Simple to pick up and play.

STAYING POWER ..67%

- Whole lot of road to ride.
- Too many police, and too narrow roads.

AA RATING 82%

- Test drive the F40 today!

Bargain basement

Of course you're short of readies – who isn't? But you don't have to go without all the best games, though you may have to wait awhile. TRENTON WEBB, muscles a-rippling, tears the cellophane off *The In Crowd* and the other latest offerings.

ARCADE MUSCLE

US Gold ● £12.99 tape, £17.99 disk

'Assault your computer with five action packed arcade smashes,' the blurb proudly boasts. Better rephrase that as 'Insult your computer...' because this box (the illustration on which is the best thing about the whole deal) just doesn't come close to making the grade. They're all dull arcade conversions that lacking the original magic that made them a success.

● Title; followed by issue of AA in which it was reviewed; and % score. (M=Mastergame, R=Rave.)

<i>Street Fighter</i>	34; 51%
<i>Bionic Commando</i>	37; 39%
<i>Road Blasters</i>	38; 69%
<i>1943</i>	39; 72%
<i>Side Arms</i>	32; 68%

The best of a bad lot is *1943*, which is at least diverting, but there are some real donkeys to drag it down. *Bionic Commando* is colourless and characterless, *Street Fighter* was overrated at 51%, and even *1943* didn't rate a Rave, let alone a Mastergame.



AA VALUE RATING 37%

- Lots of gloss and a nice cover.
- Desperately short on class.

THE IN CROWD

Ocean ● £14.95 cass

Not so much the *In Crowd* as the Extremely Violent Gang. Ocean's collection will have blood running in the streets if Wm. A.C. Smith is any judge, as eight of the fastest and most destructive games known to the CPC gather together for your pleasure.

Star has to be *Barbarian*, a good indication of the quality of the games included in the package. These are not just a few warmed up leftovers, but some of the best games pro-

● Title; followed by issue of AA in which it was reviewed; and % score. (M=Mastergame, R=Rave.)

<i>Gryzor</i>	29; 82; R
<i>Barbarian</i>	23; 87%; R
<i>Crazy Cars</i>	33; 59%
<i>Predator</i>	32; 43%
<i>Karnov</i>	34; 50%
<i>Combat School</i>	28; 84%; R
<i>Target Renegade</i>	35; 86%; M
<i>Platoon</i>	32; 82%

duced over the past year and a bit. You can choose between beating someone senseless as *Karnov* or learn how to do it properly at the *Combat School*. Admittedly there are two turkeys in the form of *Predator* and *Karnov* but even these are fun to play for a while.

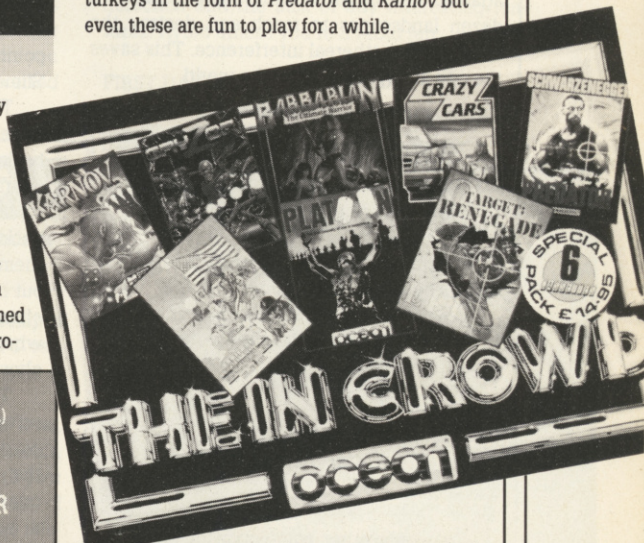

AA RATING 88%

- A great collection for any serious blaster and basher.
- Eight quality games for under fifteen pounds – brilliant value!

GARGOYLE CLASSICS

Virgin ● £9.99 tape, £14.99 disk

Back in the mists of time when Acid house was still a semi-detached, a whole batch of games came out that were head and shoulders above the competition. *Sweevo's World*, simple but great fun, features a cartoon cross between Stan Laruel and ET in an attempt to clean up a planet. *Marsport* takes place on a hostile Mars trying to save the Earth (well it was a long time ago, and sounded original). Others included: *Tir Na Nog*, *Dun Darach* and my personal favourite *Heavy on the*

● Title; followed by issue of AA in which it was reviewed; and % score. (M=Mastergame, R=Rave.)

<i>Sweevo's World</i>	5; 90; R
<i>Tir Na Nog</i>	
<i>Dun Darach</i>	1; 90%; M
<i>Marsport</i>	3; 95; M
<i>Heavy on the Magick</i>	10; 92; M

Magik, a great blend of arcade action and adventure puzzles.

A must for games players who missed these the first time round, each is a solid, well thought out game. Some of them look a little dated, but they all have an undisguisable quality. Two Raves and two Mastergames from four reviews ain't bad by anyone's reckoning!

AA VALUE RATING 85%

- Once a classic, always a classic.
- Time's dated these – just a little.

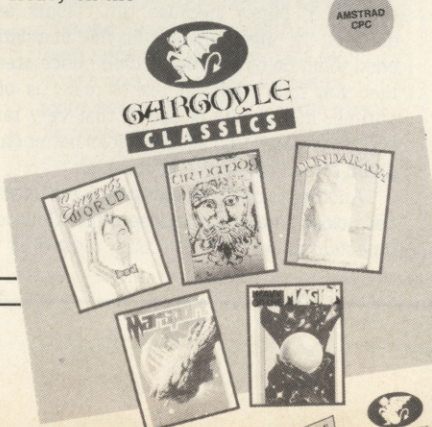

REAL GHOSTBUSTERS

producer ● £9.99 cass, £14.99 disk joystick (keys for second player only)

Just when you thought it was safe to open the fridge... The situation: your city (*what, Bath? - ed*) is overrun with ghosties and ghoulies of all descriptions. You - and a friend in the two player version - have to battle against the other worldly forces across a dozen landscapes to reach and destroy the source of the ethereal interference. This saves the city and (presumably) the world.

SECOND OPINION

"Great music, and I appreciate the opportunity to meet Mr Slimer in person.

But oh dear! RGB is let down badly by its drab appearance. I guess it's so dark for atmosphere, but frankly I'd rather see what I was doing. Not my fave of '89."

SC

GREEN SCREEN better than colour!

Your only other companion is 'Slimer,' an ectoplasmic joker with an affection for humans. One touch of the slippery sidekick sends any ghost running for cover. Problem is, 'Slimer' is a fickle friend who needs some proof of your need for help: hence you need to bust some ghosts on your own, trap the essence in your backpack and show the colloidal companion that you need aid!

Players are armed with the standard streamer guns so necessary to catch discorpo-

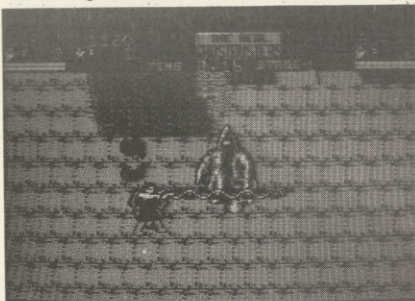

● The portal's guardian: destroy it to continue

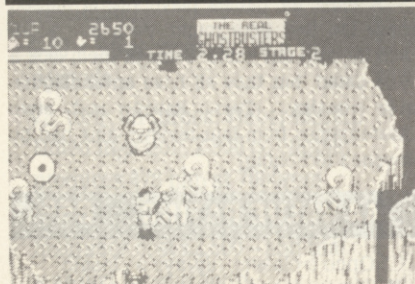

● Second level, and things are getting tough

real beings and store them. These fire two different ways: a single press of the button releases a bolt that reduces your opponents into so much extra-dimensional energy (translation: a ghost sprite). A long burst releases a stream which sucks this ghost essence into your backpack, giving you extra points and sometimes a 'Slimer.'

There is, however, a price to be paid, in that the backpacks need energy to operate. This energy can be replaced by touching energy packs: some objects release them when shot. Running out of energy doesn't happen often, but it's bad news when you do because the ghosts swarm all over you.

The idea is to go up the screen avoiding ghosts and picking up extra points. At the end of each level is a guardian and a portal. When a guardian is destroyed, it drops a key, which lets you pass under the portal. *Under?* It's only a graphic quirk, but it could have been avoided.

Each level is more than one screen wide, so that the playing area scrolls to keep up with you. There are different routes to the end, so that after playing a level a couple of times, you find out which ways are best for points or progressing in the game.

Starting on a series of skyscrapers, you travel through a series of strange swamps and graveyards. Each level has different nasties attacking you, and the variety of sudden death is quite extensive enough for me, thank you very much: mummies, monks, things with teeth, acid drops, zombies... and that's just the first level!

There's a really good rendition of Ray Parker Jnr's Ghostbusters theme tune when you load up, but as you start to play it takes about a second for that appealing touch to evaporate, purely because the colours are desperately, dreadfully *dull*. Playing in a darkened room helps somewhat (you notice areas that you didn't before) but it really is off-putting. In fact this is one of that very rare species of game that actually looks better on a green screen monitor than in colour.

Another annoying factor: you have only to pass close to a ghost to lose a life. Collision detection is way off. The only remedy is to

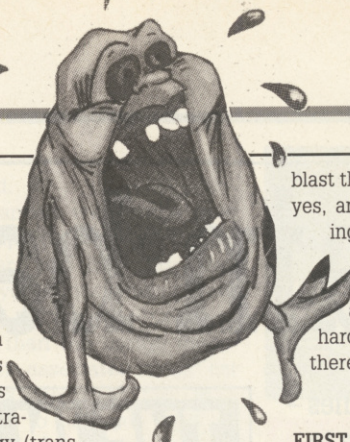

blast those ghosts as far away as possible. Oh yes, and the game crashed once, necessitating a reload. Each level is loaded individually.

That apart, I rather enjoyed it, although it's really a little easy for a hardened game player. Looks fairly naff but there's some fun there if you're patient.

PbM

FIRST DAY TARGET SCORE

Reach the guardian on level three

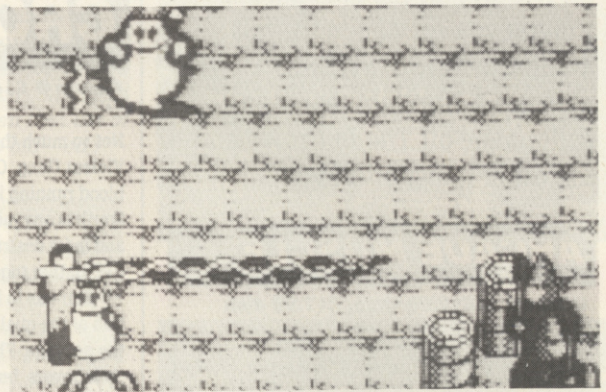

● All together now: who you gonna call?

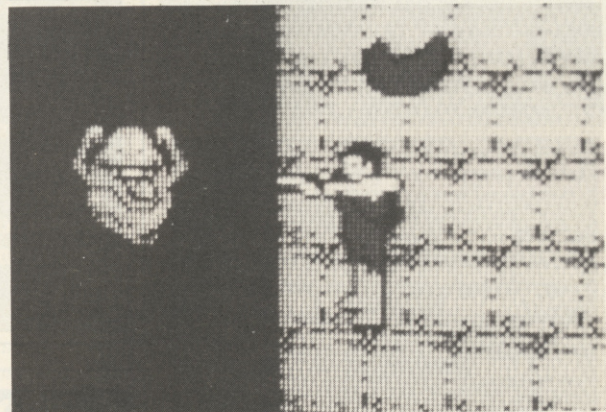

● Without 'Slimer' you won't last long

The Verdict

GRAPHICS50%

Scrolling, sprites and movement are fine.

But truly awful, muddy colours.

SONICS72%

Brill theme tune and decent spot effects.

GRAB FACTOR49%

Looks a big let down.

STAYING POWER...61%

Needs skill to complete.

AA RATING57%

Very average arcade conversion.

PACLAND

Grandslam ● £8.95 cass, £14.95 disk joystick/keys

Pacman, Pacmania and now this – is there no end to the tiresome Pac cult? In this hyped arcade conversion you are pitted yet again against Blinky, Inky and Pinky (what became of Clyde?). Your task is to journey through a town eating fruit and power pills as you go, across a desert and up some mountains in order to direct a fairy who's lost. A sillier scenario I have yet to see...

The screen is viewed from the side: you have to travel from one edge to the other without hitting one of the three ghosts before doing the next screen, and so on until the end of the level. One ghost drives a car and another pilots an aeroplane. I dunno, ghosts of today, they're gadget mad.

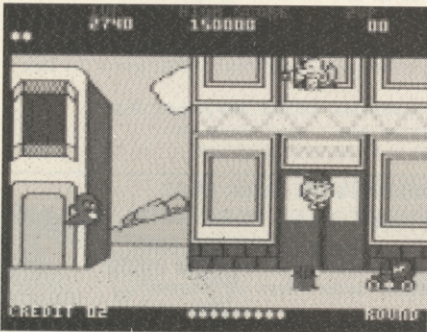

● What became of Clyde, then?

A few obstacles are placed along the path – fire hydrants, cacti and tree stumps. But get this: rather than just walking into them, you can jump over them! This is slightly dangerous, though, because the aeroplane cruises across the screen at different altitudes, dropping bricks as it goes. A little luck is involved in avoiding all the hazards.

This is what lets down a simple but fun game. The movement of the Pacman is that of a snail. He takes so long to slow down, and

The Verdict

GRAPHICS **45%**

- Faithful to the original...
- – but that was a long time ago!

SONICS **43%**

- Infuriating tune.
- You can't turn it off!

GRAB FACTOR **55%**

- Simple to play.
- And fun too.

STAYING POWER .. **47%**

- You get stuck sooner or later.
- Five lives aren't enough.

AA RATING **48%**

- Not addictive enough.



then start moving in the opposite direction. Meanwhile the ghosts catch you up and kill you, and luck rather than skill saves your skin.

There's a time limit on the bottom of the screen, which counts down fast. When it's gone the ghosts speed up, and sooner or later another life is lost. Any spare time which you might have at the end of a level is converted into bonus points.

BLASTEROIDS

Imageworks ● £8.99 cass, £14.99 disk joystick/keys

Already a classic arcade game, a revamped Asteroids with colour, guess what the CPC version of Blasteroids looks like? Correct: not a lot of colour!

The idea is simple. Choose your skill level, and face screens of alien nasties and asteroids, which you have to reduce to space dust with your trusty laser. After all the screens are clear of debris, you are then whisked away by a huge teleporter into hyperspace: from here you choose the next sector to clear, and also what's in it. Once the sectors are cleaned up, you face Mukor, the bog standard 'end of level guardian' that must be destroyed in order to go on to the next difficulty level.

A nice feature is that two people can play simultaneously – loadsafun! Controlling a spaceship is very easy: you have the standard rotate left and right, fire and thrust key (gives you a shove forwards). The nonstandard feature is the transformer which flips the ship between three different sizes. The smaller the ship, the more agile it is, but the larger the ship, the more firepower it can bring to bear. Adroit control is vital to success, and the difficulty level is just right for improvement.

Hitting asteroids or aliens (or having them shoot you) decreases your energy – zero energy equals death. Gems can be mined from certain asteroids to give you more energy.

Sometimes aliens drop extra equipment for you: firepower, shields, fuel cells (let you store

SECOND OPINION

"Looks flashy – though it could do with splashier colour – and two years ago it would've knocked your socks off. But it's a well-worn formula, and I think Pat's overestimated its Staying Power." SC

GREEN SCREEN
just as fun

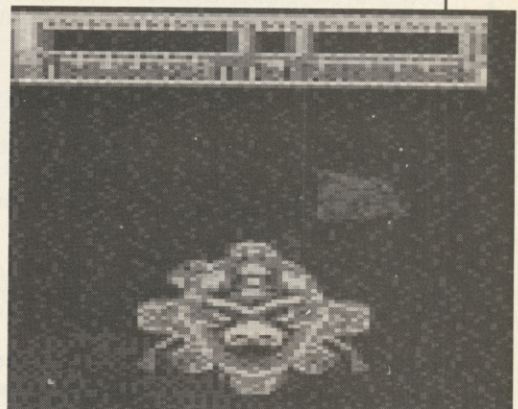

● Mashing Mukor

more energy) and more range. Problem is, other aliens coming onto the screen can pick these up too!

Deceptively easy, Blasteroids is a good (if plain looking) shoot-em-up that's like the arcade but different. PbM

FIRST DAY TARGET SCORE

Complete the easy level

The Verdict

GRAPHICS **62%**

- Well animated.
- – but colour is scarce.

SONICS **57%**

- Nice spooky title tune.
- Game effects are good too.

GRAB FACTOR **71%**

- Very hard to put down.
- Winning is very hard.

STAYING POWER .. **65%**

- Even easy is challenging.
- Once mastered, interest will wane.

AA RATING **68%**

- Good for an involved blast!

ATTENTION AMSTRAD USERS

BBD Professional Dust Covers offer an exclusive range of stylish, top quality protective covers for your computing equipment

Manufactured from top quality washable nylon, BBD Dust Covers have stylish, contrasting piping on all seams.

- NON-FADE
- NON-SHRINK
- NON-CRACK
- MACHINE WASHABLE
- EASY IRON
- FLAME-RETARDANT FINISH
- ANTI-STATIC TREATED
- FULLY GUARANTEED

Covers for the Amstrad CPC 464 £7.50
 Covers for the Amstrad CPC 6128 £7.50
 Dark grey with red piping
 (Please state monitor type)
(COST INCLUDES VAT AND P&P)

A wide range of printer covers is also available, at prices starting from **ONLY £5.00!** Money-back guarantee if not completely satisfied!

BBD DUST COVERS
 Sheer Perfection In Computer Protection

DEPT 353
 The Standish Centre,
 Cross Street,
 Standish,
 Wigan WNG 0HQ



TEL: 0257 425839 EXT NO. 353 FAX: 0257 423909

Personal Callers and Dealers Enquiries Welcome

SPRING SALE BARGAINS

DEMON DEVELOPMENT CARTRIDGE Was £24.95 **Now £19.95**
 The Ultimate machine code tool. Suitable for 464/664 and 6128 machines. Demon will give you full control of your Amstrad. Stop any program anytime by a press of a button, the memory remains intact and can be saved to Tape/Disc, debugged, traced, moved, disassembled etc. Inline Z80 assembler, Bank switching for 6128 machines etc etc More functions than ANY other unit of this type on the market. Demon Cartridge with user manual Sale price £19.95 (note no through connector).

EPROM PROGRAMMER was £31.25 **Now £25.00**
 Transfer your favourite programs onto Eprom.
 Suitable for 464/664 and 6128 machines.

- * Programs 2764 and 27128 type Eproms. * Full screen Editing for BIN files
 - * Switchable for 12.5 or 21 volt types.
 - * Normal or Fast algorithmn programming. * Powerful but easy to use software.
 - * Rom to Rom copy, Editing, Verification, Single or block programming.
- Eprom Programmer kit with through edge connector and software, Sale price £25.00

EPROM EXPANSION BOARD Was £16.75 **Now £12.75**

Holds 4 Eproms. Suitable for Maxam, Protex, Utopia etc etc. Top Quality silk screen printed PCB measures 7cm x 12cm approx with through edge connector to allow the use of disc (464) or other peripherals. Complete kit of parts with instructions to build it yourself, £12.75

PASCAL COMPILER ROM Was £19.95 **Now £10.00**

Our Pascal compiler is easy to use, suitable for the absolute beginner and produces stand alone Machine code. Does NOT require CPM. A built in text editor and combined compiler makes the program easy to use. The user manual supplied will teach you how to write programs and contains many examples, these include games and useful utilities. The compiler produces very fast machine code for example:- BASIC PLOT x,y (10000 times) 12.46 secs Pascal Plotxy (10000 times) 2.1 secs (Integer only arithmetic)

Supplied on Eprom with user manual sale price £10.00
 All prices shown include Post/Packing etc
 Items only available while stocks last

JOHN MORRISON Dept (AA)

4 REIN GARDENS, TINGLEY, WEST YORKSHIRE, WF3 1JR



Telephone (0532) 537 507
 Return of post service on Access or POs.
 Please allow 7 days for cheques.

WHAT?!!

YOU HAVEN'T BOUGHT THE MICRO-MUSIC CREATOR?

The Micro-Music Creator, for all Amstrad CPC computers, lets you produce startling three-track musical compositions and digitised sound effects. The results can be incorporated into your own programs with the minimum of fuss. Can you afford not to get hold of a copy?

Tape £9.95, Disk £14.95, Rom £24.95

CAN ALL THESE PEOPLE BE WRONG?

THE REVIEWERS:

Friendly, packed with options... wonderfully priced.
 Amstrad Computer User
 User-friendly, fast.. easy to use. Amstrad Action
 Value for money... 10 out of 10.
 Computing With The Amstrad

THE USERS:

I am delighted with it. Peter Asbury-Smith, London
 Very good value for money. G Waite, Leeds
 Very pleased with the programs. The youngsters enjoy playing Empty Tummy.
 GL Palmer, Rotherhithe



**71 Barn Glebe, Trowbridge,
 Wiltshire, BA14 7JZ**

☎ 0225 765086

Please make cheques/PO's payable to First Byte Software. All prices include VAT & P&P.

Take to the skies!

We've really got a great prize for you this time! Yes, you could win the EP CHAMPION electric powered radio-controlled airplane kit in our (fairly) simple to enter OPERATION HORMUZ competition!

Actually we're pretty cheesed off here in the AA office. One morning this week a huge parcel arrived. Imagine our excitement when we opened it up and found this lot! 'Great!' we said, and then: 'Quick, where's the nearest park Where There Is Plenty Of Room To Fly This Radio Controlled Airplane, Being Alert Of Course To Ensure That Safety Is Maintained At All Times?'

Then we found the letter. 'Here's the prize for the Operation Hormuz comp.' it read: 'you will be extra careful not to accidentally take it out of its box and give it a try-out, won't you chaps?'

So that put paid to that. It's no fun at all sometimes, this job.

Still, when you win this beast you will let us come round to your house sometimes and have a go, won't you? You won't? Honestly, you can be so mean sometimes! ●



How to enter

All you have to do is to answer these slightly tricky questions – preferably correctly – on the back of an envelope or a postcard (no letters opened), and post it off pronto to: Operation Hormuz, AA, 4 Queen St, Bath BA1 1EJ. You've got until 31st May.

1. Where are the straits of Hormuz?
2. What's the US's largest aircraft carrier called?
3. What British plane is the McDonald Douglas VTOL based on?
4. Which ocean flows through the Straits of Hormuz?

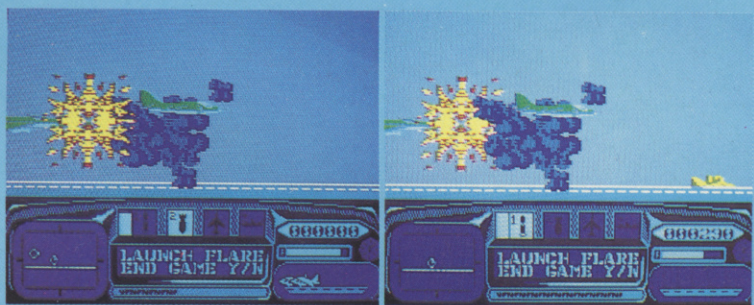

● Bang, crash, wallop – some easy lessons in what *not* to do with the EP CHAMPION!



Operation Hormuz – the game

When we reviewed *Operation Hormuz* (AA41) we said: 'The scrolling is fast and smooth. You can do some pretty impressive manoeuvres with the plane and the explosions are crude but effective... It does its job as a shoot-'em-up very well... a solid, playable game.' We rated it 70% and concluded that it's 'ideal for gratuitous blasting.'

● *Operation Hormuz* is published by Again Again at £9.99 cassette and £14.99 disk. (Again Again's first release was *The Munsters*: coming up next month is *Gilbert the Alien*.)

Your mission

The aliens are coming! In a sneak attack they've seized the Straits of Hormuz and captured the essential military bases and naval shipping. Why? Why? Don't you ever listen to what your geography teacher says? They want to cripple the world's oil supply, that's why!

Our only hope is the United States naval airforce. In *Operation Hormuz* it's all down to you. An aircraft carrier is the only friendly base for three McDonald Douglas VTOL ground attack jets. Their mission: to destroy seven enemy missile bases.

Armed with cannon, bombs, air-to-air and air-to-ship missiles, each plane takes its turn to run the gauntlet of hostile aliens to reach the heavily defended bases and destroy the missile silos by accurate dive-bombing.

But as if the destruction of the seven bases wasn't enough to be going on with, you've got to cope with the Exocets trained on the carrier. So you must protect the carrier at all costs: lose the flat-top and when it comes time to refuel and re-arm you're in *big* trouble!

THE LOOK

That spritely PAT McDONALD puts you in the picture

Look at any computer program and you will notice that most of the screen remains immobile most of the time. This background serves no particular purpose, and the only way to stop it looking boring is to paint pretty graphics on it.

Designing large screen areas is no doddle, though. These days, especially for games, much

time and effort is spent on these static displays, because they are (relatively) easy to get looking good compared to sprites or gameplay.

There are three ways to design graphics. The easiest for a beginner is to start with squared paper; take a photograph of what you want to be in the background; photocopy it to the correct size; and copy it on to the graph

paper – making sure you allow for the different shapes of pixel in the different screen modes.

This is laborious, but successful using just a few colours. The real problem comes when you use lots of colours at once. You can use different coloured pens, but they won't all match the colours on your Amstrad, making a nonsense of your best laid plans.

Draw back

What you end up doing is creating backgrounds directly on a CPC. That way all the colours are right to start with, but it demands a fair eye for shape and form. Don't think this is beyond you: practice perfects your skills.

You could use an art program like *Advanced Art Studio* or *Smart 2*. They're easy to use, and *The Gallery* proves good results are possible. The drawback is that because the backgrounds can be very detailed, data is stored in a longhand, raw form. A conventional screen can take 16K – on a 464, more than a third of available memory, leaving too little for sprites and program.



● French utilities are often très belle: ici sont *Ultra Sound* et *Discology*

THE GALLERY



● Fancy yourself as an artist? Then get cracking! Let us have your very best work at the AA office, and you could earn yourself £20! Send entries – together with a short note telling us which art package you used, and an SAE if you want the pictures back – on disk or tape to:

Pat McDonald's *The Look*
Amstrad Action
Future Publishing
4 Queen St
Bath BA1 1EJ



● Tom Higgins of Glasgow, wins £20 with 'Wiz' (AMX Art). Count Duckula (right) comes a close second (SMART 2)



● A loading screen? No, but Tom Higgins' work would grace any game (AMX Art)

Rows by any other name

Locomotive Basic has a function specially for setting up graphics modules. The **SYMBOL** command redesigns the standard characters into different patterns. You designate certain characters as surplus to requirements – **SYMBOL AFTER 240** allow you to alter the character shapes from 240-255.

To alter character patterns, use the **SYMBOL** command like this:
SYMBOL n,line1,line2...line8

But how, you're asking, does this connect with what goes on the screen? Every time character number **n** is printed by the computer, rather than use the old symbol (a list of the different characters and their symbols is printed in the manual) it uses the new data in the **line1**, **line2** statements.

Each character is made up of eight rows, each of which is made of eight pixels. **line1** refers to the top row of pixels, **line2** to the second and so on. If a pixel is set to 'on,' that particular pixel is set to the current **PEN** value. Otherwise it's set to the current **PAPER** value.

For instance the line:-
SYMBOL AFTER 32:SYMBOL
32,1,2,4,8,16,32,64,128
 sets the space character to produce a slash, '/'.

One largely unexploited way of designing backgrounds is to get the computer itself to draw them. Needless to say this takes a program with some clever coding, mainly because writing a computer program to do anything creative is harder than

doing it yourself!

Two notable exceptions are Brian James' *Landscape Creator* and Jeff Minter's *Psychedelia*. Both still required some user input to start drawing (Scottish landscapes in the case of *Landscape Creator*, and strange patterns in the case of *Psychedelia*.)

A popular way to get backgrounds moving is colour switching. Set certain parts of a picture to a neutral, unused pen. Change the colour of this ink to first the background, then another colour, and you create a simple moving effect.

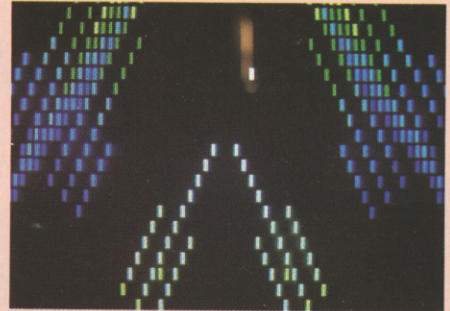

● *Psychedelia* – ahead of its time?

Uses range from the perspective movement in games like *Outrun* to the planet explosion on *Captain Blood*. Lots of *Type-Ins* use it too, spinning a bouncing ball or scrolling a shape across a landscape. In fact, overall colour switching is the most clichéd effect of all computer time.

There are ways to compact screen data into, say, 7K. Even so, this isn't good enough. So graphics are often produced on a modular basis instead. Small components are made of the complex area of graphics, and they can then be fitted together to produce the overall background. Repeated

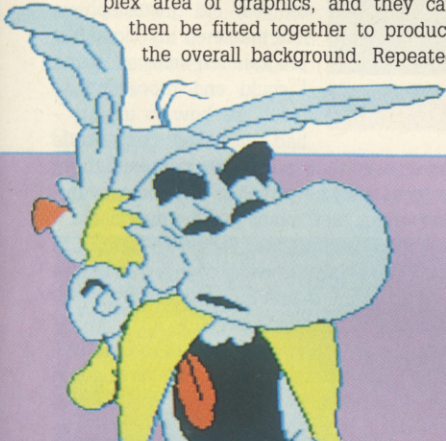

● 'Send in ze LOOK entries', says Asterix, courtesy of J A Linsey from Ross-on-Wye. (AMX Art)

patterns within backgrounds are very easy to do, just by using the same modules in different areas.

For this approach you'll need a program like Goldmark Systems' *Character Designer* (tape £7.99; disk £11.99 ☎ 07072 71529). This handy package lets you try out various designs on screen, creating simple yet effective backgrounds quickly. It also makes using hand-

drawn graph paperwork easier to use than entering using the **SYMBOL** commands. ●

● Next month in *The Look* we proudly present a program enabling you to edit characters quickly, and without recourse to all those nasty **SYMBOL** commands!



● Tom Higgins again! But it can't be a loading screen: this one isn't even released yet! (AMX Art)



● Ben Cowell of Folkestone has a light touch when it comes to pictures (SMART 2)

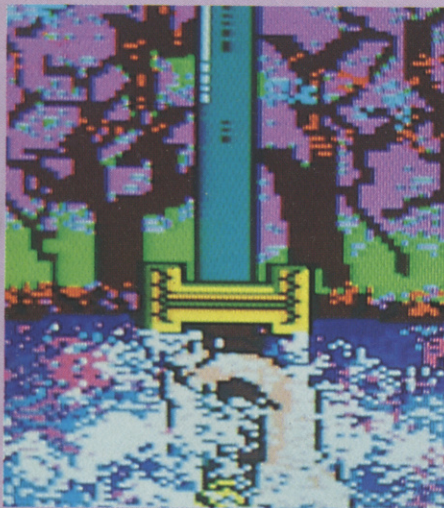

● Ben Cowell again, with another brilliantly atmospheric entry (SMART 2)



● Kiwi Andre Nieuwenhuile is crazy about Def Leppard: a picture tells 1000 words...(AMX Art)



● Thundersley resident Robert Sinclair has a peculiar form of transport! (SMART 2)

DAY IN THE LIFE

The language some CPC users use!

You're never too old to acquire a CPC, learn the world's second international language and get your story into *Day in the Life*. Just ask **BERTRAM RUSSELL, 75** year-old CPC owning fluent Esperantist...

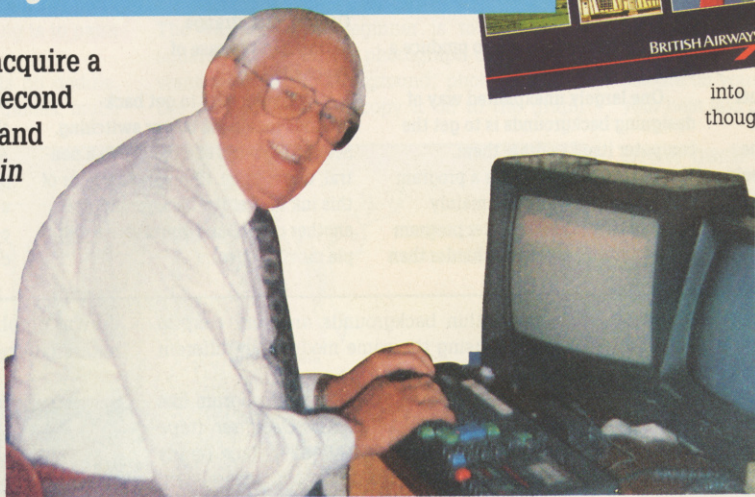

● Bertram Russell, 75 years young and making plans for 35 years hence!

I wasn't expecting a 464 as a present. After all, I was 70. Still, that was four years ago. Starting like everyone else from total ignorance, I soon acquired *Protexit* and eventually upgraded early this year to a 6128.

Games aren't my scene at all – though I have been known on occasion to indulge in a fight with my CPC in a chess match. And I found it was a little late in life (though I plan

might expect, a new computer language; in fact, it was the international second language Esperanto. There are hundreds of thousands of youngsters using the language in over 90 countries, and I had planned an article for an international Esperanto youth magazine.

But since I had now given away my trusty typewriter and transferred to a word-processor, I had to customise my 6128 for the accented letters in Esperanto. This article and another published in a second magazine circulating in over 100 countries was to lead to yet more Esperanto correspondents from abroad.

Shortly afterwards I was due to give a

talk about the English way of life to around twenty Esperantists in the Roumanian city of Brasov and my CPC went into action to systemise my thoughts and produce the notes for this talk.

While these events were going on, I was teaching Esperanto to a group of ten people of all ages, and it occurred to me that perhaps more youngsters might like to stretch their minds and undertake a ten-lesson course. Conversations with many youngsters – one, a ten-year old great-nephew, had mastered my Light Pen program ten times as fast as I could and proceeded to teach me how to use it! – had disclosed that while

they enjoyed their games programs, and quite rightly so, they nevertheless sometimes wanted to stretch their minds in other directions.

During the next two years, working on it from time to time, I slowly produced an aid-to-study program (others are in the pipeline) for the beginner in Esperanto.

Many of AA's whizz-kid readers would no doubt have produced it ten times as fast as I did – if only they had known the language! It's a group of programs of briefings and self-tests which back up the ten-lesson booklet. You may have spotted my advertisement in the small ads of AA over the summer months last year.

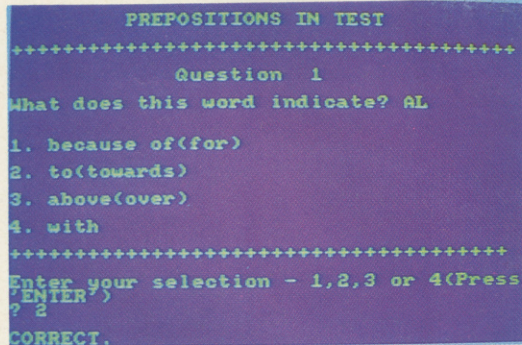

● A menu from Bertram's *The Voice for the World* – an Esperanto study aid

to live to be 130) for me to come to grips with the technical depths of machine language and the specialist jargon inevitably scattered throughout magazines and manuals. I have primarily used my 6128 for, initially, the study of Basic and then for the preparation of lecture notes and in fairly extensive correspondence.

Slow trainer coming

But where was my 6128 going to lead me? Already I was knee-deep in correspondence and lecture-note preparation, yet me and my CPC were soon to find ourselves plunged into a 'foreign' language. This was not, as you



● Issue 12 of *Voko* – de la marborda kaj ose vala Esperanto asocio



Doing anything interesting?

If like Bertram Russell you use your CPC for something a little more interesting than playing *Psycho Pigs UXB* – and, let's face it, that probably includes most of us! – why not tell AA, and in turn 35,000 people, all about it?

We pay you, too, somewhere between £35 and £70, depending on what mood we're in. Write to: *Day in the Life, Amstrad Action*, 4 Queen St, Bath BA1 1EJ.

During my courtship with my 6128 I had become Chairman of the Coastal & Ouse Valley Esperanto Association with its centre near Brighton, and the group decided to produce a small gazette in Esperanto. The articles for it were to be written by their members and guest writers, whether fully experienced Esperantists or those who were still studying the language.

Resources were limited, so two other members of the Association acquired 6128s, customised their *Protext* for the Esperanto accents and we went ahead with our first issue. It is produced fortnightly and we have now reached issue number 12 of *Voko*. Articles have so far arrived from Australia, Brazil and Czechoslovakia for preparation on the 6128.

Under pressure

During the first few months of '88 my CPC was daily under pressure producing publicity

● To purchase *The Voice for the World*, Mr Russell's Esperanto tutorial (£8.50 disk, includes booklet), or if you'd simply like to contact him, write to: Mr Bertram Russell, 103 South Coast Rd, Peacehaven, East Sussex BN9 8QU. Tell him AA sent you.

Alternatively you can receive more information and a free introductory first lesson in Esperanto (enclose large sae) from: The Esperanto Centre, 140 Holland Park Avenue, London W11 4UF ☎ 01 727 7821

Esperanto spreads...

- Radio Peking broadcasts three half-hourly programmes each day in Esperanto;
- the Russian Government has begun using it for anti-nuclear war propaganda;
- the Wales Tourist Board produces leaflets for Esperanto-speaking tourists;
- Norwegian Railways uses it in timetables;
- Hungary, Switzerland, Brazil and Belgium, among others, have issued commemorative postage stamps in its favour;
- Philips, Agfa-Gevaert and Fiat use it to sell their products;
- Manchester University provides courses in linguistics, biology, etc. with Esperanto as the language of instruction;
- *Amstrad Action* featured a *Day in the Life* about an Esperanto user in May 1989 (and you're reading it *right now!*)

Ciam savu vian laboron!

Kvantam mi lernis ke mi devus savi ĉiam mian laboron mi, bedaŭrinde, baldaŭ akiris ŝvelitan kapon kaj opiniis ke ne plu necesas ke mi daŭrigus la praktikon.

Mi baldaŭ lernis! Mi jam finis trikvaronojn de la plej longa de miaj Esperanto-programoj kiam mi subite perdis ĝin – post horoj da laboro. La praktika signifo estas: neniam akiru ŝvelitan kapon, sed ĉiam savu vian laboron!

Always save your work!

Although I learned that I should always save my work I regretfully soon acquired a swollen head and thought that it was no longer necessary for me to continue the practice.

I soon learned! I had finished three-quarters of the longest of my Esperanto programs when I suddenly lost it – after hours of work! The moral is: never acquire a swollen head, but always save your work!

● Free with this issue of AA: your first lesson in Esperanto

for a get-together of Esperantists for a long weekend conference in Kent at which eight different nationalities were present and sharing entertainments, lectures and debates. Letters, leaflets and press releases were produced by my CPC in two languages to be sent across Europe and into China.

I believe that one of the sad things about life is that the young rarely realise how young the old are and the old rarely realise how old the young are. Indeed, take



● PM Thatcher is ignored while President Mitterand and Chancellor Kohl solve the language problem. Esperantists claim that the European Parliament spends £10 per word on interpretation and translation!

Esperanto

First published in 1887 by Dr L.L. Zamenhof, of Poland. Now a thriving common language used by people throughout the world.

Politically and culturally neutral – it favours no one nation.

Many times easier to learn than national languages.

Has a sizeable literature – greater than that of many small nations.

Regular broadcasts from radio stations in over ten countries from Switzerland to China.



Dr. L.L. Zamenhof, author of Esperanto

● Esperanto, written by Dr L.L. Zamenhof, recently celebrated its centenary

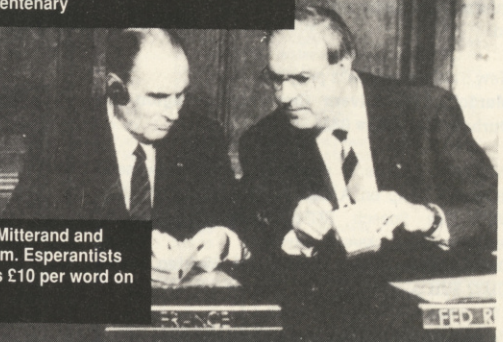

esperanto lobby
100 p
th.

to is catching on



CIRCULAR - 1A

JECTIVES



form/aligilo

Esperanto at a Glance

The Alphabet of Esperanto
A B C D E F G H I J K L M N O P Q R S T U V W X Y Z

ESPERANTO FOR BEGINNERS

the word of one who has been both that the difference between being 15 years of age and 75 is around the length of a sneeze. The key to solving the generation gap is the sharing of experience – whatever one's age.

We should play our CPC games: they're great fun. But perhaps too we should seek to stretch our minds, and share as much of this experience as we can.

I'm doing my bit. How about you? ●

AA helpline



NEW ENTRIES

Did you ever wonder if putting your name on *Helpline* works? Here's some proof that it certainly does...

Stuart Locock is withdrawing his penpal request because he's had 'literally tonnes'! Best of luck with the AA-levels mate, and I look forward to receiving your horror/fantasy novel when you finish it - Steve

Many thanks to kind and generous AA readers from a grateful *Debbie Bainbridge*, who now has a copy of AA18!

Desperately seeking penpals! Help on the Advanced Music System
Mark Turner, 7 Campsey Rd, Southery, Downham Market, Norfolk PE38 ONG

Penpal wanted to swap games &c. I have 6128 & Cannon PW-1080a printer. Interested in wp; games (Target Renegade, Ikari Warriors, Driller, Total Eclipse & others)
Christopher Bowler, 318a Wrythe Lane, Carshalton, Surrey SM5 1AF

Help with Bonze, Meddler, Blitz and Doo Dah. Enclose disk inlay as proof of ownership (alright Colin?). Also help with Heroes of Khan and Forest at Worlds End
Mick Hopewell, 55 Hawthorn Cres, Arnold, Nottingham NG5 8BE

Eproms are expensive! Backup of your Eprom: £7.95 or £13.95 2 Roms, including p&p. Send original Rom(s) & cheque/po (or sae for details) to B. Pendrick, 40 Homestead, Galleywood, Essex CM2 8SW

Through the Trap Door - anyone got it on tape? I can't find it anywhere
Kevin Murphy, 136 Main St, Lennoxton, Glasgow, G65 7DA

Please please please (*that's enough please* - ed.) anyone interested in games & reading AA. I'm 14 and anyone will do
Simon Williams, 24 Chalcot Drive, Hednesford, Staffs WS12 4SF

Help on disk drives, printers, Protect, disk backup, tape to disk Multiface and tape loading problems
Someone from Thanet who forgot a vital bit of information: name and address! Wake up matey! - ed.

New 6128 owner seeks penpals
Murdok, 149 Malvern Crescent, Darlington, Co Durham DL3 9UN ☎ 0325 359911

Will print listings & screens 10p per page, send tape/disk. Help on AA Studio, Tasword, DMP2000, DKTronics Speech ROM, customising cassette recorders/ joysticks/computers etc.
David Carter, 28 Mt Hermon Rd, Woking Surrey GU22 7UH

Penpal wanted to share tips and pokes
Iain Thomson, 13 Millhill Ave, Kilmaurs, Kil-

Need help bad on Army Moves, Green Beret, Last Ninja II, Platoon, Frank Bruno's Boxing (yup, Frank Bruno's boxing need help bad alright! - Steve)
Brian Mays, 81 Hollyfield, Harlow, Essex, CM19 4NB

Maps for copying - over 60 including Dizzy, Thrust, Driller, Dark Side, Exolon, Trantor & others. Send 15p per map for photocopying. Penpals wanted too!
Anthony Treacy, 60 Ruskin Rd, Kingsthorpe, Northampton, NN2 7SY ☎ 0604 716057 (hey Anthony can we have copies of your Driller & Dark Side maps for our 'Incentive Special'? - Steve)

All the help you could want - printouts, tips, pokes, advice on CPM2.2. Send 20p per help required (phone help free)
Christopher Street (another long letter - cheers mate!), 43 Ridgedale Rd, Bolsover Derbyshire S44 6TX ☎ 0246 827135 after 5pm

Hints, tips, pokes & maps for every game under the sun! Send SAE & 20p per game to
Nick Henshall, 'Falconwood', 44 Badger Rd, Tytherington, Macclesfield, Cheshire SK10 2EP

Basic programs written (price on application). Basic & Pascal programs debugged: send disk or tape stating program. (10p per K of program tape; 15p per K disk)
Craig Willcocks, 105 Kent Avenue, Minster, Sheerness, Sheppey, Kent ME12 2DX

Help! I need a picture digitised ready to use on Stop Press. I'll send the picture to you with an SAE
Stephen Thompson, 5 Pendragon, Great Lumley, Chester-le-Street, County Durham, DH3 4NA

Will supply any help for Mirage Imager and supply any digitized video picture for Advanced Studio. Loads games/utilities
Matthew Clover, 10 Lacon Rd, Bramford, Ipswich, Suffolk ☎ 0473 43811

Loads of maps, pokes and tips for games
Mark Watson, 106 Mountain Rd, Thornhill, Dewsbury, West Yorkshire, WF12 0BP

marnock, Ayrshire, Scotland KA3 2TA
Maps, tips, codes, pokes on over 250 games, AMX Stop Press. Penpals wanted!
Jay Redfern, 10 Oaktree Close, Mansfield, Notts NG18 3EN

Feeling helpful? Just send your name, address, phone number (say if you don't want it printed) and subjects on which you're offering help to: *Helpline*, Amstrad Action, 4 Queen Street, Bath, BA1 1EJ. Please write on a postcard or the back of a stuck down envelope and keep it short or you won't get in (or you'll get cut to 'load-sagames').

If you want help contact the appropriate

Tips & cheats (no pokes) on Asphalt, Get Dexter I&II, Dizzy, Wizball, Ghosthunters, Super Stuntman, Grand Prix Sim, Super Robin Hood, Sorcery +, Green Beret, Driller. SAE & 10p per game
Alistair London, Maryfield, Strath-martine, Dundee, DD3 0PW

19yo 6128 owner wants penpal who can program M/C so he can learn
John Mullen, 62 Lonsdale St, Workington, Cumbria, CA14 2YD

Ireland only: utilities: disassembler, real time clock, disk search, 6128 extra memory commands. All m/c. Send tape/disk & padded SAE to
D.J.Daly, 'Amber Pines', Annmount, Glounthaune, Cork, Eire

Tape to disk, 464 loading problems, CPC firmware and hardware, disk drive problems, Multiface Two, Hackit (Siren), 6128 tape recorders, Epson compatible printers, simple M/C, computer repairs. And penpals, m/f, over 15 please for 19yo
Rob Scott, 22 North St, Leatherhead, Surrey, KT 227AT ☎ 0372 377443 6.30-11pm except Sunday

Penpal wanted, all letters answered
John Mullen, 62 Lonsdale St, Workington, Cumbria CA14 2YD

Listings printed for just 25p per page. Send tape (no disks) containing listing and SAE
Nicholas Butcher, 116 Upper Hale Rd, Farnham, Surrey GU9 0JH

Hints, tips on most games & various pokes. Send 30p per game, 45p if you want it typed in ready. Enclose SAE
Keith Meakings and WW (who's WW? - ed.), Corner Cottage, 15 Old St, Hill Head, Fareham, Hants PO14 3HT

Text adventure, CPM. Send formatted disk & SAE for free copy & instructions
K. Bond, 17 Adel Park Gardens, Adel, Leeds LS16 8BN ☎ 0532 672278

Help with programming machine code & Basic
David French, 36 Shakespeare Ave, Rayleigh, SS6 8YA

Pokes, tips & maps for any game
Martin Dillon, 176 Coal Clough Lane, Burnley Lancs, BB11 4NJ ☎ Burnley 22197

Free tips & hints for Green Beret, 3D Grand Prix, Manic Miner & Jet Set Willy.
Thomas Howlett, Providence Cottage, Kemerton, Nr Tewkesbury GL20 7HP

Help with Rambo, Super Stunt Man, Radzone, Ghostbusters & Conquest
James Griffiths, Passby House, Lysonnen Rd, Carmarthen ☎ 026782 443, 4.15pm-7pm Mon-Fri

Penpal required. 16yo, interests GAC & hacking
Sigurjon Ingolfsson, Digranesvegur 52, 200 Kupaogur, Iceland

Helpliner - not us. By post include a self-addressed, stamped envelope for the reply - or you won't get one. And phone only in decent hours!

Piracy is not welcome: don't try it, you'll get booted off. Keep it legal. And if you receive SAE's, for heaven's sake return them with some acknowledgement. If you want to come off *Helpline* just write and say so.

All comments are the editor's.

Matrix Software Hire

The cheapest way to play them all.

Top games titles for Amstrad, Commodore, Spectrum and Amiga.

Please state system

Please send large SAE for details to

**Matrix Leisure Club, Dept AA,
271 Stansted Road, Bishops Stortford
Herts CM23 2BT**

WOMBAT V2.0

The Hackers Disc Utility
DISC CLONER

Back up that expensive disc software. Handles all normal and the majority of 'funny' formats.

DISC EDITOR

Examine, change disc contents with ease. Enables you to find pokes, text, hi-score tables etc, and alter them.

TAPE SPOOLER

Back up any number of disc files to tape at the touch of a button. Choice of 3 save speeds.

TAPE TO DISC

Copy your tape based software to disc. Handles a variety of tape protection systems.

Available only from: E. Prattley BSc., 30 Mellor Brow, Mellor, Blackburn, Lancs. BB2 7EX
Supplied on disc at only £10. Includes P&P. Send cheques, postal orders or cash for return delivery. Or send a SAE for more details. Owners of previous issues of WOMBAT can upgrade to the new version by sending £1.00 to cover the cost of P&P.

WOPS

Disc Manager and Copier

Now with NEW 'Simulated ROM' option. Fast & easy to use, WOPS includes ICON control, BACKUP almost any disc, MULTI-FILE copy, disc EDIT, extended FORMATS, SCREEN dumps, ARCHIVE to tape, extra RSX commands and much more.

Price: £14.95 inc. postage. (all CPC)

NEW

GM CHESS

Chess Game & Tutor

Learn about openings, mid-game and end game tactics, play the computer at fast or normal chess, solve chess problems or just watch the machine play itself. All the options you need including recap, swap sides 0,1 or 2 players, 7 levels etc.

Price: £14.95 (Disc Only). (all CPC)

NEW

INTERCEPTOR

SUPERCHARGE your MINI OFFICE 2! This ingenious program gives over 14 functions available INSTANTLY from any point inside MO2. Afterwards MO2 is resumed from where it left off. Create 'pro-forma' documents, spreadsheets etc. (complete with parameters) & save to disc using Save Image. Transfer data from ANY program (e.g. Spreadsheet) into the word processor. Use complete disc functions (format, disc & file copy, erase/rename/list files). You can even call up a calculator or note-pad, or convert any text file into MO2 format. All without leaving MO2.

IMPORTANT: Requires disc version of Mini-Office 2 and CPC6128 or 464/664 plus 64K expansion.

Price £14.95 inc postage.

Mini-Office 2 is a trademark of Database Publications



CAMEL MICROS

Wellpark, Willeys Ave., EXETER EX2 8BE
Telephone: 0392 421105



PRE-SCHOOL, PRIMARY, JUNIOR

Education

Designed by
Experienced Teachers
For use in School and Home

Wide range of programs
For AMSTRAD CPC - PCW - PC1512
- ATARI ST

CASSETTE £9.50 - DISC £12.00
Send SAE for list. Stating Amstrad
model and child's age.

**ARC (ACT5), 51 Coniston Crescent, HUMBERSTON,
SOUTH HUMBERSIDE DN36 4BA. (0472) 812226.**

VSE Technical Services

High Quality Repairs
Low Inclusive Prices
The Logical choice!

REPAIRS

Amstrad CPC 464...£21.90
Amstrad CPC 6128..£24.90

UPGRADES

AM40025 Rom.....£16.90
64K Ram Pack.....£43.90
CP/M Plus Disk.....£18.90

All repairs guaranteed 4 months, prices quoted apply to any single fault ★ and are inclusive of parts, labour and VAT. Free return carriage for UK mail order customers. AM40025 Rom installation service available, only £8.00.
★ Excludes cabinet damage and replacement of complete keyboard or disk drive assemblies (free estimate given).

**VSE Technical Services (Dept 104), Unit 6,
8 Nursery Road, London SW9 8BP. Tel 01-737-0234**

MODE - ONE

21 ORCHARD DRIVE
BURTON - UPON - STATHER
SCUNTHORPE DN15 9EF
SOUTH HUMBERSIDE
0724 721204

TITLE	CASS	DISC
Game Over II	£6.80	£10.80
1943-Midway	£7.90	£11.80
Cyberoid II	£7.90	£10.80
Savage	£7.40	£10.80
Fern. Must Die	£7.40	£10.80
Live & Let Die	£7.40	£10.80
Double Dragon (NR)	£7.40	£10.80
Dragon Ninja (NR)	£7.40	£10.80
Operation Wolf	£6.80	£10.80
Barbarian (new) (NR)	£7.40	£10.80
Total Eclipse	£7.40	£10.80
Victory Road	£6.80	£10.80
Thunderblade	£7.90	£11.80
4 Soc. Simulators	£7.40	—
Roy of the Rovers	£7.90	£11.80
Netherworld	£7.40	£11.80
Afterburner	£7.40	£10.80
Return of the Jedi	£7.40	£10.80
Galactic Conqueror	£7.40	£10.80
Batman (new)	£7.40	£10.80
Chuck Yeager's AFT	£7.40	£11.80
Titan	£7.40	£10.80
Rambo III	£7.40	£10.80
WEC Le Mans	£7.40	£10.80
R-Type	£7.40	£10.80
War in Middle Earth	£7.40	—
Typhoon	£6.80	£10.80
Robocop	£7.40	£10.80
Tyger Tyger (NR)	£7.90	£11.80
Spitting Image	£6.80	£10.80
Motor Massacre	£7.90	£11.80
Guerrilla War	£7.40	£10.80
Skate or Die	£7.90	£11.80
Sunship	£10.80	£14.05
Echelon	£10.90	£12.99

TITLE	CASS	DISC
Airborne Ranger	£10.80	£14.05
Road Blasters	£7.40	£10.80
The Train	£6.80	£10.80
Vindicators (NR)	£7.40	£10.80
4x4 Road Racing	£7.40	£10.80
Eliminator (NR)	£7.90	£11.80
Bubble Ghost (NR)	£7.40	£10.80
S.D.I.	£7.40	£10.80
Soldier of Light (NR)	£7.40	£10.80
Supreme Challenge	£9.80	£12.99
Taito Coin-ops	£9.80	—
Fist n Throttles	£9.80	£13.00
Giants	£10.40	£15.90

BUDGET	RRP	OUR
Game, Set & Match II	£9.80	£12.99
Gauntlet	£2.99	£2.75
Super Stuntman	£2.99	£2.75
World Games	£2.99	£2.75
Int. Rugby	£2.99	£2.75
Fruit Machine Sim	£2.99	£2.75
Grand Prix Sim	£2.99	£2.75
Big Foot	£2.99	£2.75
SAS Combat	£2.99	£2.75
Adv Pinball Sim	£2.99	£2.75
BMX Freestyle	£2.99	£2.75
Footballer o.t Year	£2.99	£2.75
Werewolf of London	£1.99	£1.80
Joe Blade II	£1.99	£1.80
Ghostbusters	£1.99	£1.80
Knightmare	£1.99	£1.80
Streetgang	£1.99	£1.80
Int. Nat. Speedway	£1.99	£1.80
Motorbike Madness	£1.99	£1.80
Yogi Bear	£1.99	£1.80

This is only a small selection of the titles we can offer. Please phone or write for your choice if it is not shown. Our competitive prices still apply

All our prices include P&P within the UK. Eire & Europe please add £1.20 per item. Elsewhere add £1.75
NR = New release: Phone for availability

Please make cheques and postal orders payable to 'MODE ONE'

TYPE-INS

Programs to edify, educate and entertain – PAT McDDONALD'S in charge

Life

```
1 REM Amstrad 'life'
2 REM Version by J.Fitzpatrick
3 REM AA May 1989
1000 MEMORY &3FFF:MODE 2
1010 PRINT"Ready in a sec.":GOSUB 1650:'m/c code
1020 CLS:GOSUB 2160:'demo
1030 cox=80:coy=45:block=&F397:nibble=1
1040 WINDOW#1,1,80,1,24
1050 LOCATE 6,25:PRINT"(SPACE_draw){DEL_undraw}
      .{TAB_clear}.{RETURN_start}.{ANYKEY_stop}"
1060 '
1070 'main loop
1080 a$=INKEY$:GOSUB 1550:IF a$="" THEN 1080
1090 a=ASC(a$)
1100 IF a>239 AND a<244 THEN GOSUB 1190:'move cursor
1110 IF a=32 THEN GOSUB 1450:'draw block
1120 IF a=9 THEN CLS#1
1130 IF a=127 THEN GOSUB 1490:a=242:GOSUB 1190:'del
1140 IF a=13 THEN GOSUB 1530:'call life
1150 GOTO 1080:'end of main loop
1160 '
1170 '
1180 'move cursor
1190 a=a-239:x=0
1200 ON a GOSUB 1250,1300,1350,1400
1210 block=block+x
1220 RETURN:'back to main loop
1230 '
1240 'move cursor up
1250 IF coy-1=0 THEN 1270 ELSE coy=coy-1
1260 IF block<&CFFF THEN x=&2FB0 ELSE x=&F000
1270 RETURN:'back to move cursor
1280 '
1290 'move cursor down
1300 IF coy+1=91 THEN 1320 ELSE coy=coy+1
1310 IF block>&EFFF THEN x=&D050 ELSE x=&1000
1320 RETURN:'back to move cursor
1330 '
1340 'move cursor left
1350 IF cox-1=0 THEN 1370 ELSE cox=cox-1
1360 IF nibble THEN nibble=0 ELSE x=-1:nibble=1
1370 RETURN:'back to move cursor
1380 '
1390 'move cursor right
1400 IF cox+1=161 THEN 1420 ELSE cox=cox+1
1410 IF nibble=0 THEN nibble=1 ELSE x=1:nibble=0
1420 RETURN:'back to move cursor
1430 '
1440 'draw block
1450 IF nibble=1 THEN POKE block,PEEK(block) OR
      &F ELSE POKE block,PEEK(block) OR &F0
1460 GOSUB 1570: RETURN
1470 '
1480 'undraw block
1490 IF nibble=1 THEN POKE block,PEEK(block) AND
      &F0 ELSE POKE block,PEEK(block) AND &F
1500 GOSUB 1570:RETURN
1510 '
1520 'm/c life
```

A fast version of that old but ever popular microcomputer game, *Life*, courtesy of JOHN FITZPATRICK of Navan. The idea is to create a life form that can survive for as long as possible, evolving constantly. On the screen are a series of cells, each capable of living if the following rules are satisfied:-

- 1) Cells with fewer than two neighbours die.
- 2) Cells with two or three neighbours survive.
- 3) Cells with more than three neighbours die.
- 4) When three cells surround an empty space a cell is born.

```
1530 CALL &8000
1540 RETURN
1550 '
1560 'cursor blink
1570 IF nibble THEN t=&F ELSE t=&F0
1580 k=t XOR PEEK(block)
1590 FOR j=1 TO 2
1600 POKE block,k:POKE block+&800,k
1610 k=t XOR PEEK(block)
1620 NEXT:RETURN
1630 '
1640 'm/c life..loader+data
1650 p=&8000:lin=1750
1660 FOR j=1 TO 40:FOR j1=1 TO 10
1670 GOSUB 1740
1680 s=s+a:POKE p,a:p=p+1
1690 NEXT
1700 GOSUB 1740
1710 IF s<>a THEN PRINT"error in line";lin:STOP
1720 s=0:lin=lin+10:NEXT
1730 RETURN
1740 READ a$:a=VAL("&"a$):RETURN
1750 DATA 21,00,C0,11,00,40,01,ff,3f,ED,35e
1760 DATA B0,21,B0,37,22,8B,81,21,50,D8,42F
1770 DATA 22,8D,81,21,50,40,22,89,81,21,32E
1780 DATA 50,C0,22,87,81,CD,76,80,21,00,41E
1790 DATA F8,22,8B,81,21,00,18,22,8D,81,38F
1800 DATA 21,50,50,22,89,81,21,50,D0,22,350
1810 DATA 87,81,CD,76,80,21,50,60,22,89,447
1820 DATA 81,21,50,E0,22,87,81,CD,76,80,4BF
1830 DATA 21,50,D8,22,8D,81,21,50,70,22,37C
1840 DATA 89,81,21,50,F0,22,87,81,CD,76,4D8
1850 DATA 80,21,00,40,11,00,C0,01,00,40,1F3
1860 DATA ED,B0,CD,1B,BB,30,96,C9,01,E0,5B0
1870 DATA 06,C5,7E,87,20,20,2B,ED,5B,8B,40E
1880 DATA 81,19,7E,87,20,16,23,7E,87,20,31D
1890 DATA 11,23,7E,87,20,0C,ED,5B,8D,81,3BB
1900 DATA 19,2B,7E,87,20,02,18,0C,CD,C3,31F
1910 DATA 80,2A,89,81,77,11,00,08,19,77,2D4
1920 DATA 2A,89,81,23,22,89,81,2A,87,81,3B5
```

The program first displays a demo screen which happily gets on with *Life*. Pressing any key halts the program in its tracks. A menu is displayed, and these controls become active:-

- SPACE plots a cell
- DEL removes a cell
- TAB clears the screen (use cautiously!)

● RETURN starts the game
Use cursor keys to move around the screen. One further variation which can be added is to remove all the PRINT commands and change the MODE command in line 1000 to either 0 or 1. The rules for the different environment are different from those above, the colour of the cells being as crucial as their position!

Hacker extra

Many of you typed in last month's *Hacker*, and then discovered that you didn't have the foggiest idea of how to use it. That was our fault, so, better late than never, here goes:-

Hacker needs a game to operate on. This game must be in an unprotected form - so forget all those with fancy flashing loaders etc. **CAT** the tape or disk you want to hack: a full list of files must appear (eg a loader program, to load in the other parts and get them working; a loading screen (a picture to relieve the monotony); and the game program itself).

It's the last program that you're after (usually the biggest). Contained within it are the routines which run the game, including the life or time counter. It is the counters that *Hacker* looks for: and it gives a list of pokes to disable them.

Once you have this list, how do you put it in? There are two ways. If the loader program (sometimes called the header program) is written in Basic, then it's a simple matter to alter it, eg:-

```
10 LOAD "SCREEN", &C000
20 LOAD "MAIN", &800
30 CALL &800
might become:-
10 LOAD "SCREEN", &C000
20 LOAD "MAIN", &800
25 POKE &4E80, 0
30 CALL &800
```

If the header is written in machine code (ie if it's a .BIN file) then it's better to load in the main code and put in the poke 'by hand.' You can then resave the main code onto a fresh cassette, which saves retyping the poke again and again. You will need to know how long the code is, and where it goes: you can use the *Binary Loader* for this. For example:-

```
LOAD "MAIN.BIN", &800
POKE &4E80, 0
SAVE "MAIN.BIN", b, &800, &34000 ●
```



```
1930 DATA 23, 22, 87, 81, C1, 0B, 3E, 00, B8, 20, 32F
1940 DATA BA, B9, 20, B7, C9, 2A, 87, 81, 06, 00, 44B
1950 DATA 0E, 00, CB, 7E, 28, 01, 0C, CB, 5E, 28, 2DD
1960 DATA 01, 04, 2B, CB, 46, 28, 01, 04, ED, 5B, 2B6
1970 DATA 8B, 81, 19, CB, 46, 28, 01, 04, 23, CB, 351
1980 DATA 7E, 28, 05, 04, CB, 50, 20, 3A, CB, 5E, 34D
1990 DATA 28, 05, 04, CB, 50, 20, 31, ED, 5B, 8D, 372
2000 DATA 81, 19, CB, 5E, 28, 05, 04, CB, 50, 20, 32F
2010 DATA 23, CB, 66, 28, 05, 04, CB, 50, 20, 1A, 2DA
2020 DATA 2B, CB, 46, 28, 05, 04, CB, 50, 20, 10, 2B8
2030 DATA CB, 48, 28, 0C, CB, 40, 20, 04, CB, 19, 35A
2040 DATA 30, 04, 3E, F0, 18, 02, 3E, 00, 2A, 87, 26B
2050 DATA 81, 06, 00, 0E, 00, CB, 46, 28, 01, 0C, 1DB
2060 DATA CB, 66, 28, 01, 04, 23, CB, 7E, 28, 01, 2F3
```

```
2070 DATA 04, ED, 5B, 8B, 81, 19, CB, 7E, 28, 01, 3E3
2080 DATA 04, 2B, CB, 46, 28, 04, 04, CB, 50, C0, 34B
2090 DATA CB, 66, 28, 04, 04, CB, 50, C0, ED, 5B, 484
2100 DATA 8D, 81, 19, CB, 66, 28, 04, 04, CB, 50, 3A3
2110 DATA C0, CB, 5E, 28, 04, 04, CB, 50, C0, 23, 417
2120 DATA CB, 7E, 28, 04, 04, CB, 50, C0, CB, 48, 467
2130 DATA C8, CB, 40, 20, 03, CB, 19, D0, F6, 0F, 4AF
2140 DATA C9, 00, 00, 00, 00, 00, 00, 00, 00, 00, c9
2150 'demo..
2160 PRINT "Demo":FOR j=1 TO 24
2170 LOCATE 40, j:PRINT CHR$(133);CHR$(133):NEXT
2180 CALL &8000
2190 RETURN ●
```

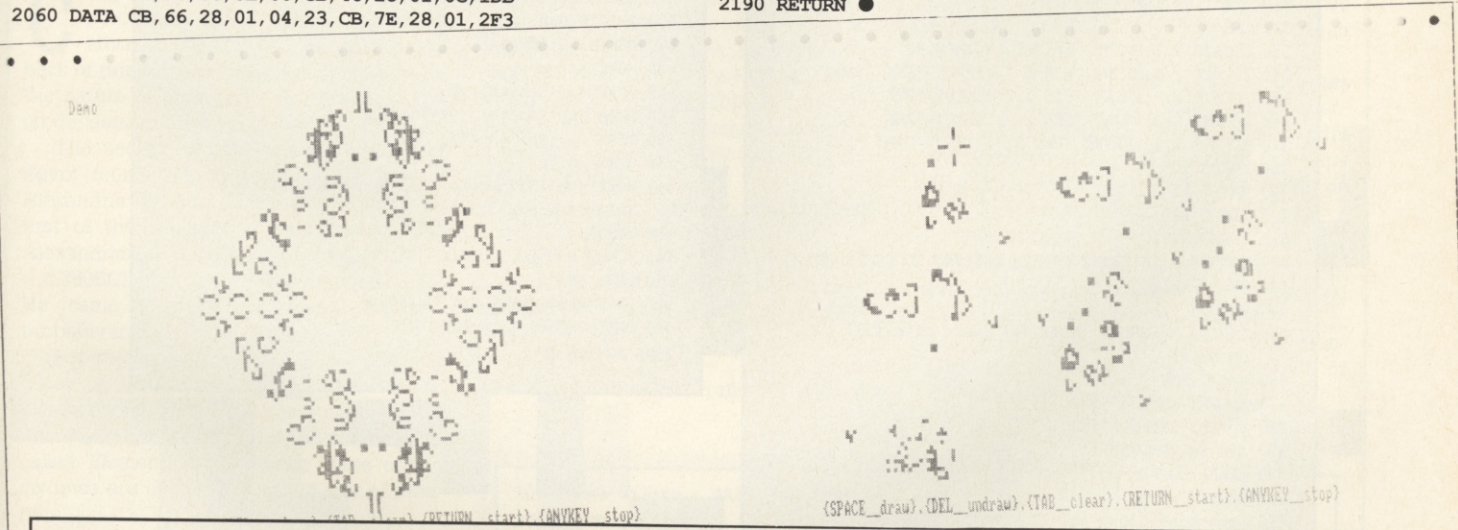

Binary loader

A short'n'sweet program from **Shabaz Yousaf** that can load in any binary file, at any address (only works from tape). After you've done this, by typing `PRINT HEX$(PEEK(&B030)+PEEK(&B031)*256)` you can find out just where the code is trying to go.

If you've ever tried exploring code without being sure just where it's supposed to go, you should find this very useful, especially for low loading programs that are tricky to handle from Basic.

```
1 ' Binary Loader
2 ' By Shabaz Yousaf
3 ' For Amstrad Action 27 September 1988
4 ' Press TAB to load any binary file.
5 ' Type PRINT HEX$(PEEK(&B030)+PEEK(&B031)*256)
6 ' to find LOAD address.
7 '
10 FOR i=&B000 TO &B02F:READ a$:POKE i,VAL("&"+a$)
: NEXT:CALL &B000
20 DATA 01, ff, 81, 11, 0c, b0, 21, 32, b0, c3, e0, bc, 3e, 44,
, cd, 1e
30 DATA bb, c8, 21, 00, 00, 06, 00, 11, 00, 40, cd, 77, bc, ed,
, 53, 30
40 DATA b0, 62, 6b, cd, 83, bc, cd, 7a, bc, c9, a4, 53, 6b, 79,
, 38, 38 ●
```

Abstract

```

10 'ABSTRACT
20 'By Chris Marlow
30 'Public Domain - Amstrad Action May 1989
40 MODE 1
50 INK 1,26
60 INK 0,0
70 LOCATE 2,3:PEN 2:PRINT "ABSTRACT SOUNDS , SHAPES
& COLOURS"
80 PEN 1
90 LOCATE 15,10:PRINT "ABSTRACT"
100 LOCATE 15,11:PRINT "-----"
110 LOCATE 1,13:PRINT "While program is working ,
press ;"
120 LOCATE 2,15:PRINT "C to draw a circle"
130 LOCATE 2,17:PRINT "T to draw a triangle"
140 LOCATE 2,19:PRINT "S to draw a square"
150 LOCATE 2,21:PRINT "O to dump screen to disc"
160 PRINT " as ABSTSCR.bin"
170 LOCATE 10,25:PRINT "PRESS ANY KEY TO CONTINUE"
180 CALL &BB18
190 GOSUB 310
200 CLS
210 vol=5:ton=56
220 ENV 1,10,1,5
230 ENT 1,10,20,5
240 oldyp=200:oldxp=320
250 a$=INKEY$
260 IF a$="c" THEN GOSUB 960
270 IF a$="t" THEN GOSUB 450
280 IF a$="s" THEN GOSUB 610
290 IF a$="o" THEN GOSUB 780
300 GOTO 250
310 ' SET UP INKS
320 CLS
330 LOCATE 2,3:PRINT "## SET UP INKS ##"
340 LOCATE 2,5:PRINT "PEN 0 ";;INPUT "INK ";i0
350 LOCATE 2,7:PRINT "PEN 1 ";;INPUT "INK ";i1
360 LOCATE 2,9:PRINT "PEN 2 ";;INPUT "INK ";i2
370 LOCATE 2,11:PRINT "PEN 3 ";;INPUT "INK ";i3
380 INK 0,i0
390 INK 1,i1
400 INK 2,i2
410 INK 3,i3
420 LOCATE 3,25:PRINT "PRESS ANY KEY TO CONTINUE"
430 CALL &BB18
440 RETURN
450 ' PLOT A CIRCLE (NOTE 464 users omit fill
command)
460 p=INT (RND*3)+1
470 xp=INT (RND*540)+50
480 yp=INT (RND*300)+50
490 dia=INT (RND*45)+1
500 GRAPHICS PEN p
510 ORIGIN xp,yp
520 tone=ton+(oldxp-xp):IF tone<10 THEN LET
tone=100
530 volume=vol+INT (oldyp/15)-INT (yp/15):IF volume
<3 OR volume>15 THEN LET volume=12
540 SOUND 1,tone,50,volume,1,1
550 FOR a=1 TO 360
560 PLOT dia*COS (a),dia*SIN (a)
570 NEXT
580 MOVE 0,0:FILL (INT (RND*3)+1)
590 LET oldxp=xp:LET oldyp=yp
600 RETURN
610 ' DRAW A TRIANGLE (NOTE 464 users omit fill
command)
620 p=INT (RND*3)+1
630 xp=INT (RND*540)+50
640 yp=INT (RND*300)+50
650 length=INT (RND*45)+1

```

Ever wanted to do some abstract art on your CPC? This program actually produces it for you! Just sit down and press C, T or S to create shapes in random locations around the screen. Weird sounds emanate from your computer, and at the end you have a result that would have Picasso revolving in his grave. CHRIS MARLOW of Formby is the artist responsible.

```

660 GRAPHICS PEN p
670 ORIGIN 0,0
680 tone=ton+(oldxp-xp):IF tone<10 THEN LET
tone=100
690 volume=vol+INT (oldyp/15)-INT (yp/15):IF volume
<3 OR volume>15 THEN LET volume=12
700 SOUND 1,tone,50,volume,1,1
710 MOVE xp,yp
720 DRAW (xp+length),yp
730 ypa=SQR (INT (length^2)-INT ((length/2)^2))
740 DRAW (xp+INT (length/2)),yp+ypa
750 DRAW xp,yp
760 MOVE (xp+INT (length/2)),(yp+INT (length/2)):
FILL (INT (RND*3)+1)
770 RETURN
780 ' DRAW A SQUARE (NOTE 464 users omit fill
command)
790 p=INT (RND*3)+1
800 xp=INT (RND*540)+50
810 yp=INT (RND*300)+50
820 length=INT (RND*45)+1
830 GRAPHICS PEN p
840 tone=ton+(oldxp-xp):IF tone<10 THEN LET
tone=100
850 volume=vol+INT (oldyp/15)-INT (yp/15):IF volume<3
OR volume>15 THEN LET volume=12
860 SOUND 1,tone,50,volume,1,1
870 ORIGIN 0,0
880 GRAPHICS PEN p
890 MOVE xp,yp
900 DRAW (xp+length),yp
910 DRAW (xp+length),(yp+length)
920 DRAW xp,(yp+length)
930 DRAW xp,yp
940 MOVE (xp+INT (length/2)),(yp+INT (length/2)):
FILL (INT (RND*3)+1)
950 RETURN
960 'DUMP SCREEN TO DISC
970 CALL &BB18
980 SAVE"abstscr",b,&C000,&4000
990 CALL &BB18
1000 RETURN ●

```

Next month

We proudly present 'Type Righter' (ouch), a program exclusive to AA (and so it should be, since it'll be Pat writing it!) to help you check that you've typed in a listing correctly.

38,456 PEOPLE DEMAND TO SEE YOUR PROGRAM!

Send us your program, share it with 38,456 people – and earn up to £100 into the bargain! (£10 is the very very least we pay.) Send your listing, together with name, address and SAE (for return) to: *Type-Ins, Amstrad Action*, 4 Queen St, Bath, BA1 1EJ. Here's a few tips:

- We like shorties very much!
- Send only your own original, unpublished work
- Enclose a covering letter with an explanation
- REMs make the program easier to understand
- Use lower-case, not capitals, for variable names

- Do not use as variable names letters that look like numbers (O and 0, for instance, or I and 1)
- Divide it into sensible procedures
- Short lines make debugging easier
- Test your program thoroughly. When you think it's completely foolproof and perfect, try it out on a friend. Offer them 10p for every bug they find!
- Make sure your name and address is on *every single* disk, cassette or slip of paper you send us!
- We also invite *Type-Ins* contributors to write about their program and/or themselves. So a phone number and an indication that you'd be interested in this

would be useful – after all, we pay to allow you to tell us how wonderful your listing is!

Hopeless programmers can help too!

Even if you don't have a wonderful listing for us, you can still play your part in *Type-Ins*. Sometimes a good idea for a program can be just what is needed to set one of our readers off. So if you have a particular problem or idea for an application, share it with us. Send it to the address above – after all, we know thousands and thousands of the best Amstrad programmers around!

Discourse

You may already realise that many techniques used in computing are not that new at all. But did you know that some of them are more than 2,000 years old? JAMES WILSON demonstrates.

Calculating was originally an activity performed by priests, and its advance, in early times, sat on the back of priestly philosophical discussions on the nature of their gods, on perfection and on the general shape of things.

The second of the Ptolemaic rulers of Egypt founded a library and museum at Alexandria in about 300 B.C. Amongst the first of the scholars to be called to this Alexandrian Academy was Euclid (c.330BC – c.260BC), that illustrious mathematician. He came from Athens where he had probably trained under Plato.

For the next 22 centuries, the first six books of his thirteen volume *Elements of Geometry* were the customary school introduction to geometry. Although the work is called *Elements of Geometry* three of the volumes are devoted to the theory of numbers.

In Book 9, Proposition 20 is the proof that there is no 'highest' Prime Number, a remarkable deduction in an area that has exercised great minds ever since.

In his tenth book he explored the irrational quantities, first discussed by Pythagoras, and to this day the subject of deep research by eminent mathematicians under dreaming spires.

Getting things in proportion

The theory of proportion is a geometric commonality that is discussed in his fifth book and gives rise to the theory of irrational numbers which was eventually developed by Rene Descartes (1596-1650).

Euclid also wrote a mathematical treatise on Optics. He believed that light moved in straight lines and that vision was something that went forth from the eye. Many of his other works on astronomy and music are lost to us though some survive in Arabic translations of dubious accuracy.

The algorithm method

One especial loss is his work entitled *On Fallacies* which dealt with the causes of error in geometrical research. However, one remarkable legacy of this ancient sage is his algorithm, expounded in Proposition 2 of Book 7, for calculating the Highest Common Factor of two numbers. This algorithm is an excellent example of a mathematical process which only works correctly with integers (ie. whole numbers).

Let us choose any two whole numbers *a* and *b*, and suppose that *a* > *b*. If *a* is not divisible by *b* then we can express *a* as a multiple of *b* together with a remainder which is less than *b*, that is

$$xa = kb + c \text{ where } 0 < c < b$$

eg. $38 = 3 \times 12 + 2$

Any common divisor of *b* and *c* is also a divi-

sor of *a*. Also, any common divisor of *a* and *b* is also a divisor of *c*. And this is the crux of Euclid's Algorithm.

An example best illustrates this algorithm.

Take the numbers 4862 and 1793.

The algorithm runs as follows -

$$\begin{aligned} 4862 &= 2 \times 1793 + 1276 \\ 1793 &= 1 \times 1276 + 517 \\ 1276 &= 2 \times 517 + 242 \\ 517 &= 2 \times 242 + 33 \\ 242 &= 7 \times 33 + 11 \\ 33 &= 3 \times 11 + 0 \end{aligned}$$

and the H.C.F. is the 11, the last remainder. (For the aficionados, if, and only if, the last remainder of Euclid's algorithm when applied to two numbers is 1, then these two numbers are relatively prime and their H.C.F. is 1.)

The following program illustrates Euclid's Algorithm and was used to calculate the above result. If you want to print the result on your printer change the value of *a* in Line 60 to 8. I will be expanding on this algorithm later in this series.

Interestingly, the reasoning behind this algorithm can also be used to prove Proposition 30 of Book 7, the proposition often referred to as Euclid's Theorem:

If a prime divides the product of two numbers, then it must divide at least one of these two numbers. ●

```

10 'James Wilson : AA1: May '88
20 DEFINT a-z:a=0
30 CLS:PRINT #a,"EUCLID'S ALGORITHM TO CALCULATE THE H.C.F. OF TWO NUMBERS"
40 PRINT #a:PRINT #a
50 INPUT " Enter first number -";n1
60 INPUT " Enter second number -";n2
70 PRINT #a:PRINT #a:s1=n1:s2=n2
80 k1=n1\n2
90 k2=n1-(k1*n2)
100 PRINT #a,n1="k1"x"n2"+"k2
110 n1=n2
120 n2=k2
130 IF n2>0 THEN GOTO 120
140 PRINT #a:PRINT #a:PRINT #a,"The H.C.F. of"s1"and"s2"is "n1
150 PRINT #a:PRINT #a:PRINT #a:END ●

```

ABBA – the drive-in mover

If a drive switcher seems such a good idea, why don't you make your own?

PHIL CRAVEN, who unlike **ABBA** has never won the Eurovision Song Contest, shows how.

Not so long ago I came across an unfortunate 6128 user who had a *Multiface II* and a 3.5" disk drive with 800k storage capacity. His idea was to store lots of games, captured by the *Multiface II*, on each 3.5" disk.

The reason he is unfortunate is that the *Multiface II* only recognises drive A – and the 3.5", of course, is drive B. That's one good reason for a device to switch drive B into the drive A position and vice versa, and there are others. My solution is the ABBA modification described here. I am pleased to report that all is now well, though he did have to fork out another 30p for a switch.

So there you have it: a project to provide a switch to change drives A to B and B to A. Hence ABBA (geddit?). Be honest, you thought I was going to sing a song, didn't you? (If you even try, Craven, you're out-ed.)

Take a chance on me

Because the CPC never expected to have to perform this change, we are forced to get inside the machine to make two cuts and a few connections. Chapter 7, page 40 of the computer manual shows the pinouts of the Drive B socket. The only difference between

Don't mess DOS

To use the full 800K capacity of an 80-track double-sided drive it's essential to have a different disk operating system. Both Romantic Robot's RODOS ROM (#29.95; ☎ 01 200 8870) and KDS's ROMDOS ROM (RAMDOS on disk) will do the job. But only RODOS will do it on Drive A.

This is not a judgment on either system – in fact, both are excellent – but it is necessary to know this for the ABBA project.

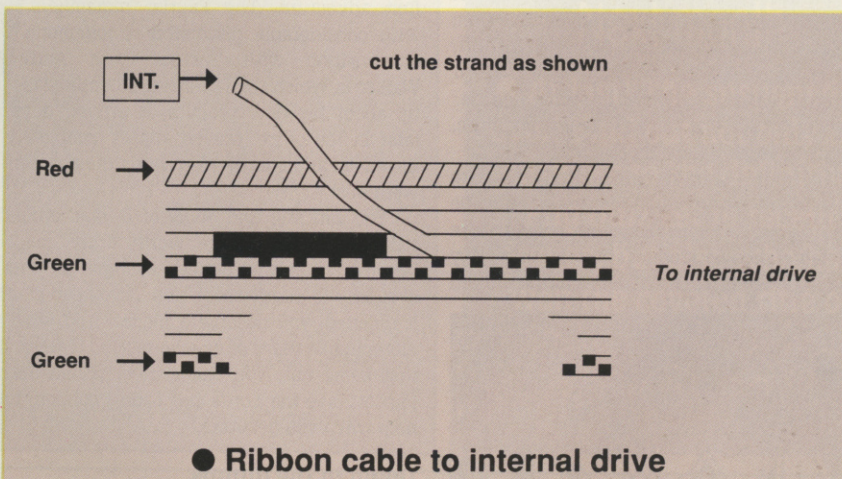
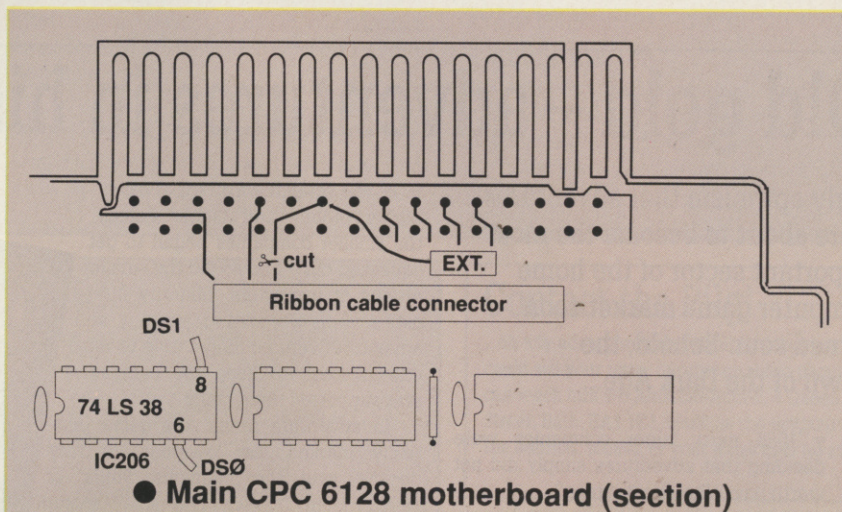
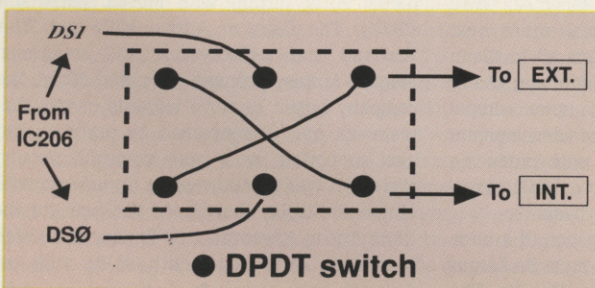

these connections and those of drive A is pin 23 – Drive Select 1 (DS1) which is not fed to drive A. Similarly drive A's Drive Select 0 (DS0) is not fed to drive B. The rest of the connections are fed to, and operate on, both drives simultaneously. All we are going to do is intercept DS0, direct it to whichever drive we want to be drive A and the opposite with DS1. Then, whenever drive A is accessed by the computer, the drive we have selected to receive DS0 is used, and the same with DS1.

We need one double pole double throw (DPDT) switch, available at any Tandy or Maplin store; a bit of wire; a sharp knife; a soldering iron; and a supply of anti-squeamish tablets. The switch should be panel mounting so that it can be easily fixed to the computer's casing.

The motherboard dia-

gram doesn't show every jot and tittle but has more than enough to do the job accurately. The ribbon cable diagram represents part of the internal disk drive cable and the red edge is indicated.

The 4th (grey) strand should be cut as indicated, and the end nearest the internal drive [INT] should be connected to the switch as shown. Opposite corners of the switch should be connected together and a wire, taken from the pin marked [EXT], should be soldered to the hole indicated on the motherboard diagram.

The existing printed circuit track from that hole should be cut. The centre pins on the switch connect to pin 6 (DS0) and pin 8 (DS1) of IC206. Wires can be soldered straight onto the IC's pins but don't take more than about five seconds with the iron on each pin.

And that's all there is to it. Follow the diagrams carefully, eat up all your greens and allow plenty of wire inside the computer to the switch, so that it can be opened freely. ●

PILGRIM

This month: Adventures in History Part II, plus Lords and Ladies of Adventure!

Old gold - adventures in history, part II

Early optimism that adventures were about to become the most important sector of the home computer game market soon turned sour. Behold, the Dawn of the Dark Age...

By 1985 most larger companies were deciding that adventures simply did not worth pay. What went wrong?

Looking at today's software catalogues, you'd find it hard to believe that once almost all major companies produced adventures from time to time. Melbourne House's *Hobbit*, Activision's *Mindshadow*, Bug Byte's *Twin Kingdom Valley*, Software Project's *Legion*: however 'arcade-y' a software house might be, the odd adventure kept slipping out.

The trouble started, paradoxically, because the software industry suddenly seemed to be doing so well. Companies were selling more and more arcade product, and in turn they began spending more and more on promoting

it. In the scramble for bigger sales, bigger profits, and bigger games, the smaller companies began to get squeezed out - and so did the smaller groups of gamers. Minority interests such as wargaming, strategy, and adventure were no longer able to raise enough cash to keep the companies that supported them going.

In adventure terms, the game that really marked the low-point of this decline was the infamous *Souls of Darkon* from Taskset. This small arcade company decided, in 1985, to release their first adventure. The Pilgrim remembers with considerable discomfort a telephone conversation with Taskset boss Andy Walker in which the latter waxed enthusiastic about his new product. It arrived days later in the office, proved almost completely insoluble, and shortly afterwards the company went bust.

You can still find *Souls of Darkon* around today second-hand. It's worth a try simply because it is the perfect example of total obscurity in puzzle technique. If you can crack it unaided, you deserve a medal. And what's more, unlike those of us who tackled it when it first came out, you can always phone Joan Pancott (see the *Lords and Ladies* column) for help when you get stuck!

Down in the dumps

If *The Hobbit* marked the high-water of early adventuring, *Souls of Darkon* marked the beginning of a new Dark Age. As always, however, this Dark Age was illumined by numerous twinkles of light, thanks to... *The Quill*. Just as the big boys stepped out, the little boys stepped in, armed with Gilsoft's utility, converted for the Amstrad and proving, together with the *Illustrator* add-on, a powerful tool for self-expression.

Quillsters followed two paths. Some remained enthusiastic amateurs, selling their games by mail-order through fanzines. (We'll be looking at them in a special article next month as they deserve a column all to themselves.) Others followed a more aggressive route, placing their games with larger companies who, by saving on the development expenses normally associated with producing a new game, were prepared to publish adventures on a 'low-cost, low-return' basis.

This period saw the emergence of a number of unique talents. The first must be Fergus McNeill, whose satire on *The Hobbit*, *The*

● An early effort, Taskset's 1985 virtually insoluble *Souls of Darkon*, marked a low-point of the decline of adventures. It was their first - and, alas, only release; while collectors' item *The Secret of St Bride's* really got the Pilg going!

Boggit, really sums up this period of adventure history. It's amusing, well-programmed, and Quill-based. You can still get a lot of enjoyment out of the misadventures of Bimbo Faggins, released through CRL in 1986.

Even weirder were the girls from St Bride's School in Co Donegal, Ireland. This place, believe it or not (the Pilgrim didn't start with) is a pretend girls' school where grown up women can go and live out their fantasies of days gone by. Their first game, *The Secret of St Brides*, was published under their own label, and but later on they issued *The Snow Queen* through Mosaic. Both these Quilled games are still available second-hand and worth looking out for. The Pilg still cherishes a fantasy about applying for a job as a gardener at this house of 'further' education (*keep your mind on the job, Pilg! - ed.*).

Meanwhile Level 9 continued to support us through thick and thin, but this period saw some strange goings-on, even by Level 9 standards. After flirting with Mosaic (*Erik the Viking*, *The Diary of Adrian Mole* and *The Archers*) and rediscovering the traditional magical fantasy scenario with *Red Moon*, the company began to move towards games that were not only accompanied by graphics, but also supported by a more powerful parsing system. It was this movement, in tandem with Magnetic Scrolls, that paved the way for the Third Age of Adventure, the Renaissance. We'll be looking at it next month, along with the 'home-brew' masters... ●



● Set in a particularly retarded area of western middle earth at the time of the third age 'or thereabouts,' Fergus McNeill's witty and barbed satire on *The Hobbit* typifies this era of adventuring history. For some, McNeill's more recent work has never really matched the verve and sheer fun of this 1986 effort

The four ages of adventure

Here are four distinct 'ages' of adventure, together with dates, landmarks, and when you can read about them in this series. Perhaps you disagree with them? Or can think of some others we haven't mentioned? Let the Pilgrim know...

1983-1984 The Grand Romance

Graphics, interaction, music, and magic. Sparked off by *The Knight's Tale* and *The Hobbit*, this period saw adventures in the Top 20. Read about it in last month's issue.

1985-1986 The Dark Ages

The disappearance of software houses like Carnell and Richard Shepherd, and the beginning of the home-brew movement that was to force adventure topics in different directions. Check out this month for details.

1986-1987 The Renaissance

Level 9 and Magnetic Scrolls begin to work towards a new age of Adventure, featuring more advanced

techniques and bigger games. Read about it all next month...

1988-1989 The Age of Transformation

RPG, icon graphics, bigger memories, disk access...all these have arrived and mean a whole new direction for adventurers.

To find out more, stay tuned to 'Adventures in History'!

Lords and Ladies of Adventure

An old friend reappears, and two new ones join us. Welcome to Cathy Thrower and William Conlon, and welcome back to Joan Pancott...

● The Fourth Protocol, Scary Tales, DAA, Gems of Stradus, Return to Eden, Colour of Magik Part 1
William Conlon, 171 Mulvey Park, Dundrum, Dublin 14, Ireland

● The Quest for the Golden Egg-Cup, Rigels Revenge Part 1, The Big Sleaze, plus limited help on Seas of Blood...

Cathy Thrower, 35 Sunningdale Ave, Barking, Essex, IG11 7QF (Don't worry about the short list, Cathy - I'm sure it will get longer. Pilg.)

● Acheton, Adventure Quest, Aftershock, Apache Gold, Arnold Goes to Somewhere Else, Boggit, Bored of the Rings, Brawn Free, Classic Adventure, Castle Blackstar, Castle of Skull Lord, Colossal Adventure, Colour Of Magic, Crystal Theft, Cursed by the City, Dodgy Geezers, Dracula, Dungeon Adventure, DAA, Emerald Isle, Enchanter, Erik the Viking, Escape from Khosima, Espionage Island, Fantasia Diamond, Forest at Worlds End, Gnome Ranger, Guild of Thieves, Heavy on the Magik, Heroes of Karn, Hitchhikers Guide to The Galaxy, Hobbit, Hunchback, Imagination, Inca Curse, Jewels of Babylon, Kentilla, Knight Orc, Kobyashi Naru, Lords of Time, Lost Phirious (1 & 3), Message from Andromeda, Mindshadow, Mordon's Quest, Necris Dome, Never Ending Story, Planet of Death, Price of Magik, Project Volcano, Qor, Questprobe III, Red Moon, Return to Eden, Robocide, Scary Tales, Seabase Delta, Seas of Blood, Shymer, Smashed, Smuggler's Cove, Snowball, Sorcerer, Souls of Darkon, Spellbreaker, Spytrek, Star Wreck, Subsunk, Terrormolinos, The Pawn, The Trial of Arnold Blackwood, The Sydney Affair, The Vera Cruz Affair, Very Big Cave Adventure, Warlord, Wise and Fool of Arnold Blackwood, Worm in Paradise, Zork 1

Joan Pancott, 78 Radipole Lane, Weymouth, Dorset, DT4 9RS (0305) 784155 1pm to 10pm only.

Contact the Pilg!

...on any adventure-related subject and you could see your letter in print on these pages. You can reach him c/o *Amstrad Action*, 4 Queen Street, Bath, BA1 1EJ. Mention the magazine in the address, please, or your letter may go astray.

Next month

● At last! The suspense is over! Find out not only the answers to the definitive Pilg quiz set in recent issues, but also who has won the coveted title of *Amstrad Adventurer of 1989!* Don't miss it!

The Pilgrim's post bag

What about Genesis?

Whenever you mention game writing utilities you only ever include *GAC*, *the Quill*, and *PAW*, but never Camel Micro's *Genesis* systems. Why not? I know you reviewed *Genesis* back in Christmas '85 and you didn't find it a good utility - mainly thanks to the manual, but I don't think you realise the there are two *Genesis* systems (*Genesis I* and *II*). Without wanting to plug, I own the *Quill* and *Genesis*, have used *GAC* and read about *PAW*, but I find in general *Genesis* a really good option, and at least worth a mention or even a re-review on the grounds that there is an

updated version. For example, both systems can create either disk or tape-based games, and *Genesis II* is much more user friendly...

Clark Campbell
Wishaw

Thanks for letting us know, Carl. I don't remember seeing the second version so perhaps an article is due. I'll see what I can do, especially if Camel can send me a copy...With regard to other points in your letter, I must say I am fascinated by the sound of game featuring a 400 ft tall pink tree planning to pollinate the highly attractive and slightly cute tree in the opposite field. Please let me know what develops...

Buy those games!

I, like the Pilgrim, am angry that adventure titles for the Amstrad are decreasing (AA40 page 77). Of all those adventure publishers like Adventure International, Interceptor, Global Software, CRL etc, only Level 9 and Magnetic Scrolls still produce titles that are of acceptable quality. If we CPC owners want to keep playing adventures, we must make sure that we don't lose them as well!

After seeing Infocom leave we have learnt one important lesson: the only thing that counts for software companies is profit. In other words, no profit, no further support. As simple as that! So buy those good games (*Ingrid's Back*, *The Pawn*, *Guild of Thieves* etc) and don't get into piracy! But remember always to ask for high quality games and not just fancy packaging and names.

Jaehee Lee
Netherlands

What can I say? 100% agreement...

CHEAT MODE

Fair play counts for nothing with TRENTON WEBB!

Ninja Scooter

NINJA
Scooter Simulator



MICHAEL GLEDHILL has been tinkering away with his *Ninja Scooter* and has really souped it up. The speed clock is set (1 = fast, 3 = normal, 7 = slow) and it allows green screeners to see the potholes. (Tape. Method 1)

```
1 'Ninja scooter poke
2 'Michael Gledhill
3 ' 12.2.89
10 FOR n=&BE00 TO &BE2A:READ a$
11 POKE n,VAL("&"+a$):NEXT
12 DATA 2a,5b,bb,22,38,bd,2a
13 DATA 0f,bc,22,29,be,21,0e
14 DATA bc,36,c3,23,36,1a,23
15 DATA 36,be,c3,00,3e,b7,20
16 DATA 0b,3e,07,32,74,69,3e
17 DATA 01,32,c5,6a,af,cf,00,00
20 MEMORY &2FFF:LOAD"scooter1"
21 INK 2,7:INK 3,13:MODE 1
22 WINDOW#1,14,26,10,10
23 WINDOW#2,14,26,13,13
24 INPUT"Clock speed (1,3 or 7) ";a
25 POKE &BE1E,a
26 INPUT"Green screen (Y/N) ";a$
27 IF a$="n" THEN 29
28 POKE &BE23,7
29 CLS:CALL &BE00
```

Send your dirty work – pokes, cheats, hints, tips, playing guides or maps – to
Cheat Mode, Amstrad Action,
4 Queen St, Bath BA1 1EJ.

Each month at least three contributors receive a voucher to spend on the superb Special Offers Mail Order section at the back of the magazine!

HEROES OF THE LANCE

In a land where magic and wizardry still reigns is there any one greater than the Great Mage MIKE WONG? His great magic allows those *Heroes of the Lance* infinite hit points and lets them fall into pits without trouble. (Disk).

```
10 MODE 2:l=170
20 FOR n=&BE80 TO &BEF1 STEP 6
30 FOR p=0 TO 5:READ a$
40 a=VAL("&"+a$):c=c+a
50 POKE n+p,a:NEXT
60 READ d$:ch=VAL("&"+d$)
70 IF c<>ch THEN 160
80 l=l+10:c=0:NEXT
90 PRINT"Do you want the char";
100 INPUT"acter screens (y/n)";a$
110 IF a$="n" THEN 140
120 FOR n=&BE9F TO &BEA9
130 POKE n,0:NEXT
140 PRINT"INSERT HEROES DISC..."
150 CALL &BB18:CALL &BE80
160 PRINT"Error line";l:END
170 DATA 21,00,01,11,00,00,033
180 DATA 0e,41,df,e8,be,21,2f5
190 DATA 94,be,22,1a,01,c3,252
200 DATA 00,01,21,ad,be,22,1af
210 DATA a0,16,3e,c9,32,20,20f
220 DATA 2e,21,83,16,36,00,11e
230 DATA 23,36,00,23,36,00,0b2
240 DATA c3,00,16,21,00,00,0fa
250 DATA 22,37,a8,22,88,a8,253
260 DATA 22,8a,a8,22,8c,a8,2aa
270 DATA 22,8e,a8,22,fd,a9,320
280 DATA 22,98,ab,22,c6,8e,2db
290 DATA 22,18,8f,22,d0,93,24e
300 DATA 22,ab,92,22,ad,92,2c0
310 DATA 22,af,92,22,b1,92,2c8
320 DATA 22,93,92,22,94,92,28f
330 DATA 21,aa,92,36,be,c3,314
340 DATA 00,80,3c,c0,07,00,183
350 DATA 00,53,50,00,00,00,0a3
```

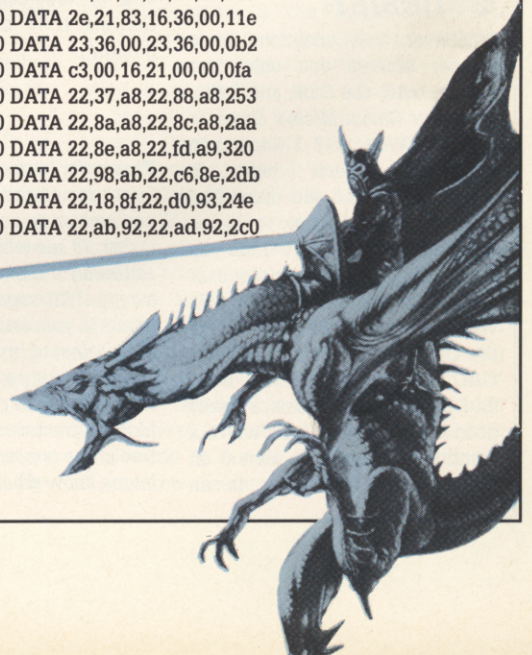
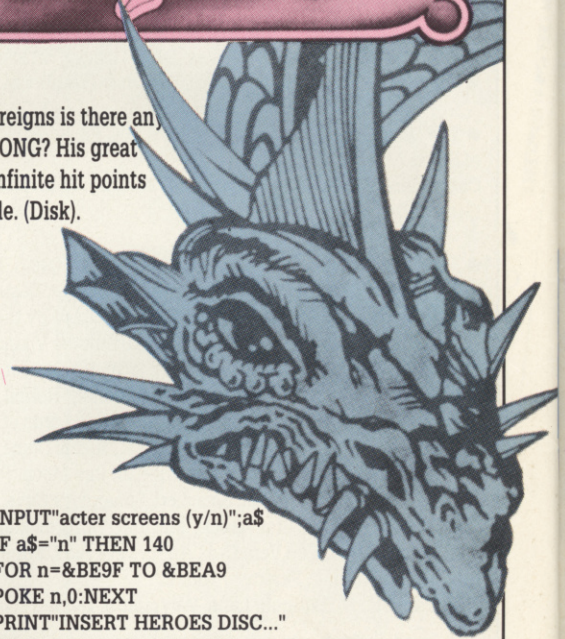

THE VINDICATOR

War is hell – and so, if we're honest, are long pokes. But if you want to get even, don't get mad get typing. MIKE WONG of Sale, who's got more pokes than you've had wet Sundays, has devised a hunky pokette to allow each Vindicator out there Infinite lives and oxygen in part one, Infinite lives in part two and inf. lives and time in part three. Get cracking!-(Disk)

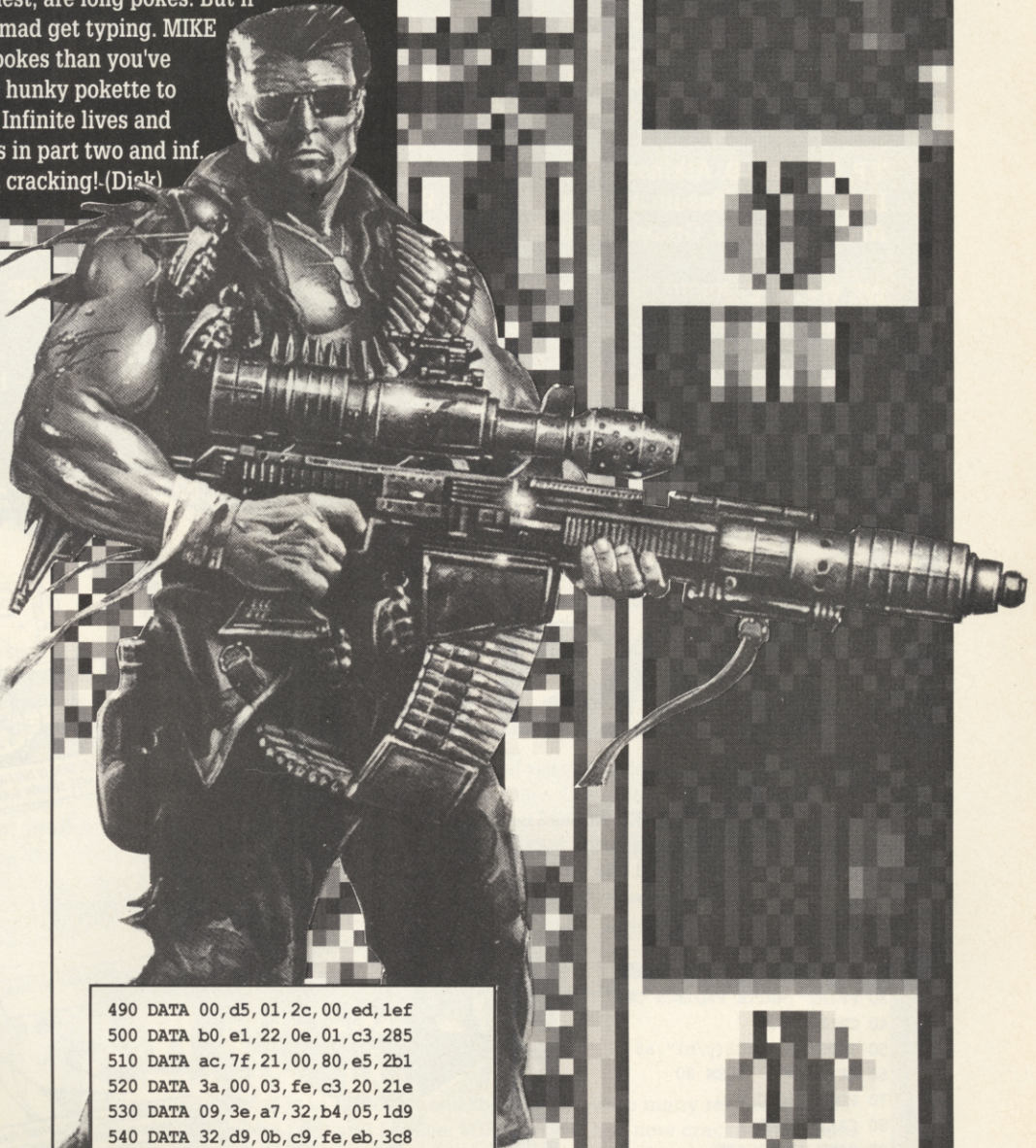

```

10 MODE 2:MEMORY &9FFF:l=140
20 FOR n=&A000 TO &A140 STEP 6
30 FOR p=0 TO 5:READ a$
40 a=VAL("&"a$):POKE n+p,a
50 c=c+a:NEXT:READ c$
60 ch=VAL("&"c$)
70 IF c<>ch THEN 130
80 l=l+10:c=0:NEXT
90 PRINT"Insert VINDI";
100 PRINT"CATOR disc..."
110 CALL &BB18
120 CALL &A000
130 PRINT"Error in line":l:END
140 DATA cd,32,a1,21,0c,a0,26d
150 DATA 22,11,01,c3,00,01,0f8
160 DATA 01,7e,fa,af,ed,79,38e
170 DATA cd,0f,a1,21,18,a1,257
180 DATA 36,00,21,9e,1d,0e,120
190 DATA 23,cd,1c,a1,3e,4d,238
200 DATA 32,bb,4d,32,be,4d,277
210 DATA 3e,c3,32,fd,4f,21,2a0
220 DATA 35,a0,c3,26,a1,21,280
230 DATA c1,1d,0e,13,cd,1c,1e8
240 DATA a1,3e,4d,32,d3,4d,27e
250 DATA 21,48,a0,c3,26,a1,293
260 DATA 21,d4,1d,0e,0e,cd,1fb
270 DATA 1c,a1,3e,4d,32,e0,25a
280 DATA 4d,21,5b,a0,c3,26,252
290 DATA a1,21,69,a0,22,00,1ed
300 DATA 1e,3e,14,21,ee,1d,19c
310 DATA c3,2f,a1,21,77,a0,2cb
320 DATA 22,47,1e,3e,2e,21,114
330 DATA 27,1e,c3,2f,a1,21,1f9
340 DATA 85,a0,22,77,1e,3e,21a
350 DATA 29,21,57,1e,c3,2f,1b1
360 DATA a1,21,7c,1e,0e,0d,177
370 DATA cd,1c,a1,3e,4e,32,248
380 DATA 87,4e,21,9e,a0,22,256
390 DATA fe,4f,21,98,21,c3,2ea
400 DATA 7c,4e,21,95,1e,0e,1ac
410 DATA 11,cd,1c,a1,3e,4e,227
420 DATA 32,a5,4e,21,b9,a0,29f
430 DATA 22,fe,4f,3e,61,21,22f
440 DATA 95,4e,c3,2f,a1,21,297
450 DATA c3,1e,11,00,a4,01,197
460 DATA d5,02,ed,b0,21,cd,362
470 DATA a0,22,e9,a4,c3,55,367
480 DATA a4,21,e0,a0,11,c0,316

```

```

490 DATA 00,d5,01,2c,00,ed,1ef
500 DATA b0,e1,22,0e,01,c3,285
510 DATA ac,7f,21,00,80,e5,2b1
520 DATA 3a,00,03,fe,c3,20,21e
530 DATA 09,3e,a7,32,b4,05,1d9
540 DATA 32,d9,0b,c9,fe,eb,3c8
550 DATA 20,06,3e,a7,32,21,15e
560 DATA 1d,c9,3e,a7,32,f9,2f6
570 DATA 12,af,32,0e,06,32,139
580 DATA 15,06,c9,53,50,38,1bf
590 DATA 39,21,9e,6d,11,9e,214
600 DATA 1d,01,fa,03,eb,ed,2f3
610 DATA b0,c9,06,00,7c,c6,2c1
620 DATA 30,57,5d,ed,b0,c9,34a
630 DATA 22,fe,4f,cd,0f,a1,2ec
640 DATA c3,9e,4d,ed,4f,e9,3d3
650 DATA 21,00,01,11,00,00,033
660 DATA 0e,41,df,3e,a1,c9,2d6
670 DATA 3c,c0,07,00,00,00,103

```

GAME

THE LIVING DAYLIGHTS

To help you kick the living daylight's out of *The Living Daylights* here's a quick resume of how survive being shaken without being stirred. These tips came from NEIL HACKNEY and DANIEL HAMMON.

● LEVEL 1 - GIBRALTAR

Forget about the SAS. Just run to the end and change your weapon to a Walther PPK. When the screen won't scroll any further, shoot the first man who appears. Your score will increase by 50, at which point you should run off the right hand side of the screen.

● LEVEL 2 - MUSIC CONSERVATORY

On this level too there is no need to worry about the men who pop up and shoot at you. All you need to do is keep running, jumping and rolling to the end of the level.

► weapon: night vision glasses

● LEVEL 3 - THE PIPELINE

Just run through this level, jumping the pipes on the floor. To get past the high pipe, roll just as they are about to hit Bond's head. The falling pipes usually miss, so don't pay too much regard to them.

► weapon: hard hat

● LEVEL 4 - THE MANSION HOUSE

Forget the helicopter and the people who shoot at you. Just shoot at the first Milkman, selecting the bazooka means you only have to shoot him once. As soon as milkmen appear on the edge of the screen shoot them. When the three milkmen have been killed run to the end of the level.

► weapon: bazooka

● LEVEL 5 - THE FAIRGROUND

Quickly get the weapon you have selected, then wait until the target is about half way along the screen at Bonds head height. Shoot the balloons when they come into the target, then shoot the man. Alternatively, if you are high on energy, shoot the man using your PPK straight away and then run through the balloons.

► weapon: crossbow

● LEVEL 6 - TANGIERS

Shoot the men who throw long grenades at you and jump the gaps. Ignore the men who shoot at you.

► weapon: dart gun

● LEVEL 7 - THE MILITARY COMPLEX

Shoot the first man with the PPK and then change to the bazooka. When the helicopter makes holes, just jump. Do not try to run and jump.

► weapon: bazooka

● LEVEL 8 - WHITTAKER'S HOUSE

Leave the weapon on bazooka, and as soon as the man comes on screen, shoot him and the game is finished.

► weapon: bazooka ●

Bond is back and this time he can't die. This poke by Julian Collins of London gives 007 infinite lives and allows you to choose which level of the game to start on. It's a Method 1 poke.

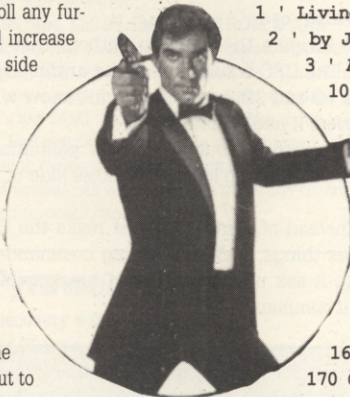

```

1 ' Living Daylights - tape
2 ' by Julian Collins
3 ' Amstrad Action Nov 87
10 PRINT "Infinite energy? (Y/N)";
20 a$="":WHILE a$="":a$=UPPER$
(INKEY$):WEND
30 IF a$<>"Y" AND a$<>"N" THEN 20
40 IF a$="Y" THEN RESTORE 200 ELSE
RESTORE 220
130 MEMORY &A5FF:LOAD "bond", &A600
140 addr=&A627
150 READ a$:IF a$="BOND" THEN GOTO 180
ELSE POKE addr,VAL("&"a$)
160 addr=addr+1
170 GOTO 150
180 CALL &A619
190 ' infinite energy
200 DATA 21,ed,2c,36,00
210 ' start level
220 DATA 21,27,7,36,1: 'last number in this line
is start level
230 ' number of lives (only use ful if infinite
energy not used)
240 DATA 21,1c,07,36,8: '1st num ber in this line is
number of lives
250 ' leave last line how it is
260 DATA c3,00,06,BOND ●

```



LIVE AND LET DIE

Commander Bond is in high demand this month, with many requests for us to print a poke for *Live and Let Die*. MIKE WONG has now cracked the codes of International Exports and has taken Q's job, giving James infinite fuel and made the game ultra fast. (Tape. Method 1)

```

10 MODE 1:LOAD"!tape"
20 POKE &A457,&80
30 POKE &A458,&BE
40 FOR n=&BE80 TO &BE9B
50 READ a$
60 POKE n,VAL("&"a$)
70 NEXT
80 INPUT "Fast game (y/n)";a$
90 IF a$="y" THEN 110
100 POKE &BE95,3
110 CALL &A410
120 DATA 3e,09,32,07
130 DATA 74,3e,ff,32
140 DATA 0a,74,3e,28
150 DATA 32,0b,74,3e
160 DATA a7,32,17,74
170 DATA 3e,00,32,ef
180 DATA 55,c3,fd,05 ●

```

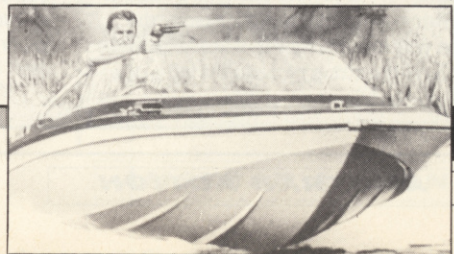

ABSOLUTE BEGINNERS

It's the beginning of the end for ANDY WILTON

In the first instalment of *Absolute Beginners* we learned how to use the **PRINT** command to make an Amstrad display messages on its screen. Since then we've seen how **PRINT** can also tell us the value of variables and expressions while a program is running.

Commands like **PRINT** which make the CPC tell us or show us things are called *output commands*. They are vital to our programs; without them we wouldn't know whether the programs had done what we wanted, or even if they'd done anything at all. Look at this program:

```
10 a = 12: b = 8
20 c = a+b: d = a-b
30 PRINT c*d
```

See? Imagine the program without that last line. The CPC would still do the arithmetic in lines 10 and 20, but you wouldn't know what answers it had come up with.

So much for output. In this penultimate AB we're going to look at the other side of the coin.

Instead of commands that make the CPC tell us things, we'll be meeting commands to make it ask us things – what are known as *input commands*.

String: something simple

Type in this listing – you probably won't need to run it to see what it does:

```
10 PRINT "This is an Amstrad CPC"
20 PRINT "Amstrad CPCs are useful
things"
30 PRINT "I use my Amstrad CPC a lot"
Nothing dazzling, you'll agree. Now edit and add lines until the program looks like this:
5 a$ = "Amstrad CPC"
10 PRINT "This is an "; a$
20 PRINT a$; "s are useful things."
30 PRINT "I use my "; a$; " a lot."
Run that to see what it does, and then edit line 5 to read:
5 a$ = "Arnold"
```

Run it again, and notice the difference in the output – the messages your CPC prints on the screen. 'a\$' is acting like a variable. It's just a name taking the place of an operand. In each of lines 10–30 'a\$' takes the place of part of the printlist. What's new here is that 'a\$' is taking the place of a piece of text, rather than a number.

Things that stand in for numbers are called *numeric variables* or simply variables. Things that stand in for pieces of text are called *string variables*, or *strings* for short. Their names can be letters or words, but they're always followed by a dollar-sign (\$) to distinguish them from numeric variables. (Pronounce the dollar-sign 'string', so if you saw a string-name written elephant\$ you'd call it 'elephant-string'.)

Line 5 of our program assigns a value to a\$. String assignments work exactly the same way as numeric variable assignments: you have the string name to the left of the

equals-sign and the value you're assigning to it on the right. The value is a piece of text enclosed in double quotes, like this: a\$ = "Arnold"

Notes on quotes

The quotes aren't part of the value, and won't show up when you do a 'PRINT a\$'. They're only there to show where the value starts and finishes.

The value of a string can include spaces, mathematical symbols or punctuation marks as well as the more normal letters and digits. Don't try using double-quotes in a value, like this:

```
a$ = "Say "BOO" to a goose"
```

The CPC will mistake the second double-quote for the end of the value, and give you a syntax error message when he tries making sense of "BOO" to a goose". Single quotes are OK in string values, though, so you can use those instead.

You can assign from one string to another – try this new line 5 out:

```
5 b$ = "Amstrad " : c$ = "CPC": a$ = b$+c$
```

This isn't really adding; 'b\$+c\$' means 'b\$ joined to c\$'. When you're joining strings like this, order is important; b\$ + c\$ has the value "Amstrad CPC" but c\$ + b\$ is the less useful "CPC Amstrad". (Spaces typed in the right places within the double-quotes can be useful!) Joining strings together is properly known as concatenation. Most people still say 'joining' or 'adding', but it's as well to know the proper term even if you never use it!

The command INPUT

The most important input command is simply **INPUT**. It makes the CPC ask what value we want a variable to have. Type this program in and run it:

```
10 PRINT "Enter a number"
20 INPUT a
30 PRINT "The variable 'a'
now has the value"; a
```

After the message from line 10, the CPC puts up a question mark and a flashing cursor. The program hasn't finished yet – the CPC has reached the **INPUT** command in line 20 and is asking you what value it should give to the variable a.

Just type in a number, 15 say, and hit **Return** (or **Enter** on a 464). That tells the CPC you're finished entering the number, and it can carry on with the rest of the program.

Line 30 prints out a message telling you what the value of the variable a now is. It is in fact the number you typed in at the '?' prompt – 15 or whatever. That's because the moment you hit **Return** after typing the number 15, line 20 acts from then on as if it were:

```
20 a = 15
```

The difference is that with a simple a=15 assignment you have to choose the value of 'a' at the time you write your program. **INPUT** on the other hand lets you make that decision when you run the program, and that can be very useful indeed.

As a demonstration, try this little times-table program out. It's very like one we tried earlier on in the series, when we were looking at loops:

```
10 a = 1
20 WHILE a<>0
30 PRINT "What times-table do you want";
40 INPUT a: PRINT: PRINT a; "Times Table"
50 FOR b = 1 TO 10
60 PRINT b; " Times "; a; " "; a*b
70 NEXT b
80 WEND
```

This prints out a times-table for whatever number you enter at the line 40 input. It then prompts you for another number, print out the times-table of that and so on, until you enter the number 0. Then it prints out the 0-times table and stop.

Notice how the **WHILE-WEND** loop checks to see whether or not a has the value of 0. Notice also the assignment a = 1 in line 10. This is to make sure a isn't 0 when the CPC reaches the **WHILE** in line 20 for the first time. If a was 0 at the point, the CPC wouldn't go through the loop at all and the program would finish.

There are lots of other uses, such as asking you what size the program should draw a shape, for example, or the number of times it should draw it. ●

Last month we told you this was going to be the final instalment of *Absolute Beginners*? Well, we ran out of room. So hang on for next month's real final episode!

AA Buyers Guide

So you want to spend some money on your CPC? Well, first of all you need to know what's available. And here's the place to find it. We've listed the best and best known programs in each category, and given you the producer; the phone number; the price; the issue in which the item was reviewed; and last but not least, a brief description of the program's features and, where appropriate, shortcomings.

Don't take our word for it, though: we recommend you read the original review before you splash out, and, even better, ask the person from whom you're buying if it meets your particular needs. Best of all would be a try-out, if you can find a friend who already has what you're thinking of buying.

WORD PROCESSING

Brunword 6128

Brunning Software ☎ 0245 252854
 £16.50 tape, £25 disk ● reviewed AA24
 40 or 80 column mode; spell checker loaded into extra memory. Suitable for expanded 128K machines. Superscript/subscript effects on-screen. Includes Datafile. Available as 'Junior Brunword' at £12.95 in slightly cut-down version.

Mini Office II

Database Software ☎ 051 357 2961
 £14.95 tape, £19.95 disk ● AA6
 If you don't need full specification *Mini Office II* is the one to buy. Remarkably cheap for word-processor, database and spreadsheet, plus comms software and more. Packaging and documentation good, and programs work in a menu environment.

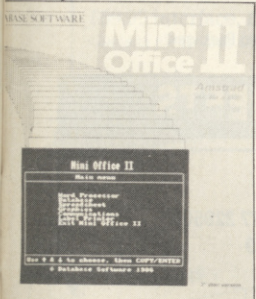

Pendown

Logotron ☎ 0223 323656
 £19.95 disk only ● AA18
 A complete tutorial in the theory and practice of word processing - it's great fun, too. Open system, owing much to expensive DTP packages.

Protex

Arnor ☎ 0733 68909
 £19.95 tape, £26.95 disk, £39.95 ROM ● AA3
 Lightning fast on all tasks involving screen. True merging from separate files and disks to the cursor position is easy, and *Protex* supports standard CPC RSX's like DISC, TAPE, CAT etc. ROM version is excellent. Bad points: maximum file space limited to machine memory - about 22K on disk, 38K for the ROM version. As used by AA, if that's any recommendation (probably not, actually!).

Pyraword

Discovery ☎ 0742 753423
 £14.95 tape, £17.95 disk ● AA18
 Similar in use to Discovery's *Pyradev*. It loads a profile of inks, printer codes and character set. Word counting, changing disk drives etc - 'house-keeping' tasks - are handily located. Uses extra memory of 128K machines for spooling printed documents and storing text. True file merging is impossible, and control keys are odd. Margins cannot be set further apart than 80 columns, although placing a printer control character at the right hand side allows wider documents to be printed.

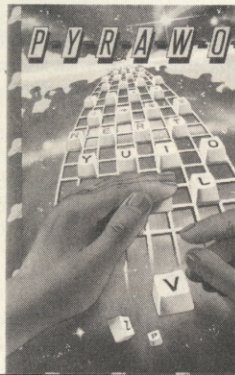

Tasword

Tasman Software ● 0532 4388301
 464, 464D, 6128 ● £19.95 tape/£24.95 disk ● AA1
 464 is the tape based version (the same as *Amsword*). 464D has enhancements for a disk drive. 6128 makes full use of a 6128's extra memory. The latter pair include mailmerge facility. Easy to get to know: comprehensive help screens. Screen operations are slow, and text is reformatted a word at a time.

Wordstar

Micropro/Cumana ☎ 0483 571666 £49.95 disk only (CPM) ● AA1
 Files can be as big as the space available. A professional program, with huge manual and a layout like mission control. If you want a function, it is in there... somewhere. Not fast.

Manufacturers' recommended retail prices are listed as guidelines, but heavy discounts are offered by retailers.

PRINTERS

Amstrad DMP/2160

Amstrad ☎ 0277 230222
 £159.95 ● AA6
 Load through front: printer must be above paper; but loading continuous stationery is easy. Poor NLQ mode. £5 for ribbons. Low priced, rather than a bargain.

Amstrad DMP3160

Amstrad
 £228.85 ● AA29
 Similar to but faster than DMP2160. Accepts all IBM and Epson printing codes. NLQ is front loading system. Good buy.

Amstrad DMP4000

☎ 0277 230222
 £401.35 ● AA20
 A real text cruncher. Wide carriage, and really flies across the paper, up to about 200 cps (in NLQ about 50 cps). Fonts available: standard 9 pin Pica, Elite, condensed etc. - but they are different, rather than just adjusted spacing for the same characters.

Amstrad LQ3500

☎ 0277 230222
 £401.35 rrp ● AA31
 Cheapest 24-pin printer. Paper loaded from the rear - more time consuming. 30 cps in letter quality mode, and 62 cps in draft. Print quality excellent: plenty of different type-styles built in. Not ultra fast.

Citizen 120D

Citizen ☎ 0800 282692
 £159 ● AA43
 Dimensions: 3.7 kgs, and 370mm x 90mm x 238mm. Draft quality is 'dott,' and poor, but NLQ is sharp and simple. A quiet beast, with cable to the computer connected on the side. Manual includes a complete written breakdown of all the printer control commands, and their effects.

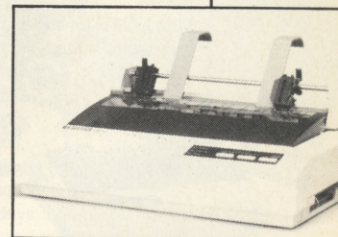

Epson LX800

Epson ☎ 01 902 8892
 £320.85 ● AA29
 Very fast for 9 pin. Control panel for style selection, and Epson compatible. Reverse winding sheets requires care, though.

Epson EX800

☎ 01 902 8892
 £458.85 ● AA29
 Upgradable in 101 ways - cut sheet feeds, serial ports, longer life ribbons. Quiet, with respectable printing speed. Sans Serif/Roman NLQ fonts incorporated. Control panel to select fonts - just the same font with different spacings.

Epson LQ500

Epson ● £803 rrp ● AA29
 Features galore and price to match. Handles both Sans Serif and Roman styles of NLQ, for instance. Colour-

printing upgrade kit available. 24 pin printer, offering excellent quality printing. Control panel to select from many available fonts (ie. the same font at different widths).

Mannesmann Tally MT81

Mannesmann Tally ☎ 0734 788711 ● £149 ● AA43

Dimensions: 70mm X 100mm X 265mm; weight, 4.5 kgs. Draft quality is 'dott,' and poor, but NLO is sharp and simple. Prints Epson and IBM graphics. Draft mode print quality is good; square printhead pins put ink onto greater areas. The printed output is more ornate than the Citizen. Manual is superb, but falls down in failing to explain control codes: for that you have to buy the applications manual. Certainly a very good buy.

Panasonic KXP3131U

Panasonic ☎ 0753 73181 ● £335.25 (discont.) ● AA29
Daisywheel therefore superb quality – but can't print bit graphics (no trendy screen dumps), and if you want different fonts, you have to plug in a different Diablo-compatible one. Not quiet.

Panasonic KXP1081

Panasonic ● £245 rrp ● AA29
Similar to DMP2000/2160: chunky, 9 pins, 10 inch carriage and compatible with Epson codes. Thorough A4 manual, good NLO mode – better than DMP – and condensed, draft and NLO modes.

Star LC10

Star ☎ 01 840 1800 ● £263.35/£297.85 rrp ● AA32

First price is for standard dot matrix printer. Fonts selected by button, rather than typing in fiddly control code. Second price is for relatively inexpensive colour model. Uses multi-colour ribbon to produce different mixes. Plastic paper feeder on both models.



INTEGRATED PACKAGES

Info-Script

Brunning ☎ 0245 252854
£46 disk only ● 128K/256K only ● AA35
Billed as the 'complete database with word-processor and spelling checker', it's best with 256K. Well set up, easy to use and allows for changes in layout and content. Manual could be clearer.

Protex Filer/Office

Arnor ☎ 0733 68909
£24.95/£34.95 disk only ● AA34
Database that works comfortably with Protex, has powerful sorting options and comprehensive invoice printer. Can be slow, but good value.

Arc Education Master Pack

Arc Education ☎ 0472 812226

£48 disk ● AA32

A massive pack of 70 programs: Junior; Primary; a parent/child adventure; DR Logo and word games. Each set available at £9 tape and £12 disk. Well presented with good graphics, reasonable musical ditties and plenty of options.

Mini Office II

Database ☎ 051 357 2961
£14.95 tape, £19.95

disk ● AA6
Astonishingly cheap word processor, database, spreadsheet, graphics, comms and label printer all-in-one, it's continued to sell, and sell, and sell... Not full specification, but at this price who's complaining?

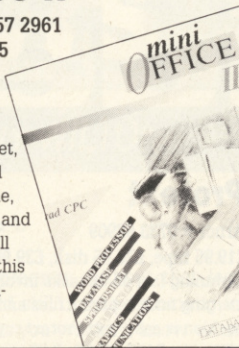

EDUCATIONAL PROGRAMS

Amstrad Selection

Fernleaf Education ☎ 0474 359037
£12.50 tape, £17.50 disk ● AA32
For age range 7 to 12+: seven programs – Fletcher's Castle, Market Stall, The Perfume Hunter, The Raiders, Ferry Captain, Treasure, and Thorn Sea.

Kosmos

Kosmos ☎ 05255 3942 ● £xx disk ● AA32
Answer Back Junior Quiz, which began life on the BBC micro, is just what it sounds like: a 750 question quiz, in which you can choose to answer the question, make a choice from a number of options; or say whether something is true or false. There's also Factfile 500, sets of additional questions for the program: arithmetic, spelling, sport and natural history. Kosmos' other range is a foreign language vocabulary tutor in French, Spanish, German and Italian.

LCL

LCL ☎ 0491 57345
Range of Amstrad educational software. Leave message on answerphone and they won't send you a catalogue. At least, they didn't send me one. Still, I'm sure they do really terrific stuff, whatever it is.

School Software

School Software ☎ 010353 6145399 (Ireland) ● AA32
Decent software, though a little too dependent for some tastes on a fairly rigidly structured 'school syllabus'-type presentation. Still, that may be precisely what appeals to some users.

Wordhang

Bourne Education ☎ 0794 523301
£9.95 cassette; £14.95 ● AA32
Just one of Bourne's range of ten programs. Others include Happy Letters, Numbers and Writing (all Infant); Timeman One/Two, Animal Vegetable Mineral, World-Wise and Map Rally (all Junior); and the excellent Chemistry and Physics Revision (Senior).

● See also Pendown in 'Word Processing'

BUSINESS/ACCOUNTS

Protex Office

Arnor ☎ 0733 68909
£34.95 ● CPM+, 6128 only ● AA34
Requires Protex and Prömerge to run. Information inputted using Protex. Mail merge templates included, and very well implemented invoice printing feature. A genuinely useful business system.

SD Microsystems range

☎ 056681 511
General Ledger ● £19.95 ● AA32
Sales Invoicer Pack ● £14.95 ● AA26
Small Traders Pack ● £24.95 ● AA26
Stock Control ● £39.95 ● CPM+, 6128 only ● AA32
SD Microsystems are to be congratulated for their range and quality of small business systems. Consult original reviews for in-depth explanations of what each does and how it differs from the others.

DATABASES

AtLast Plus

Rational Solutions ☎ 056681 511
£39.95 ● CPM+, 6128 only ● AA30
Powerful: developed into user's requirements. Data capacity restricted only by disk size, and splitting fields into smaller elements possible. Printed output impressive. Beefy processing.

Masterfile III

Campbell systems ☎ 0378 77762
£39.95 CPM+ ● AA30
With parent/child records – enabling tying together of records, saving space and time. Screen layouts and reports menu selected; not for faint hearts, but good results.

Random Access Database

Minerva Systems ☎ 0392 37756
£29.95 disk only ● reviewed AA6
40 or 80 column screen. Good mathematical and string operations. Random disk accessing gives speed and power.

● See also Info-Script in 'Integrated Packages'

SPREADSHEETS

Cracker

Newstar Software ☎ 0277 229509
£49.95 disk CPM+ ● AA9
Spreadsheets must be created from scratch. Documentation good, command sequences soon learned. Mathematical functions well done, with random numbers catered for. Files limited to 17K – and formulae programming not well implemented.

The Cracker
user's manual

Mastercalc 128

Campbell Systems ☎ 0378 77762
£33 disk ● 128K machines ● AA4

Can show two parts of spreadsheet at once. Includes notepad and calculator. Easy to use, but the mathematical formulae can only consist of the four basic arithmetic options. Slows down as more data is entered.

Matrix

Audiogenic Software ☎ 0734 303663
£34.95 disk ● AA18

Uses disk to store data – so good capacity on the plus side, but poor speed on the minus side. Graphic options excellent. Onscreen prompts rare, making it hard at first. Calculating power good.

Supercalc II

Amsoft/Sorcim ☎ 0277 230222
£49.95 CPM+ ● AA4

First class documentation. Calculations can be deterministic – performed on whether or not cell's contents match given value. Excellent help prompts and arithmetic functions.

■ SOUND

Amdrum

Cheetah ☎ 0222 555525
£34.95 ● AA13

Digital drum machine. Editor comprehensive. Not Midi compatible: to hear output you plug it into amplifier.

DHCP Midi Interface

DHCP ☎ 0440 61207
£69.95 interface, £34.95+ disk s'ware ● AA33
DHCP produce Midi software for various Midi interfaces for CPC, which are incompatible with each other.

Micro Music Creator

First Byte Software ☎ 0225 765086
£14.95 disk, £24.95 ROM ● AA38

A music composer that lets you put staves and notes onscreen and play tune back. Accents can't be inserted, though. Other side is sampler to capture sounds from tape and play them through CPC. Excellent.

Midi Interface

Silicon Systems ☎ 061 848 8959
£59.95 interface, £59.95 software ● AA26

Useless alone, but software you can use with it – DX7, FB01, MT32, D50 and CZ101 – is diverse. Software prices vary, and lack presentation of EMR sequencer. High performance.

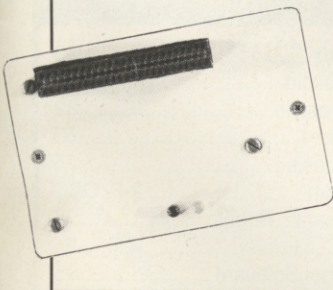

Miditrack Performer

EMR ☎ 0702 335747
£92.50 cass/disk ● AA13

Midi interface plus sequencing software to drive Midi

equipped instruments. Records each instrument then plays them all at once. Onscreen layout similar to multi-track recorder. Excellent.

Ram Music Machine

RAM Electronics ☎ 0252 850085
£49.95 disk, £59.95 disk ● AA17

All in one music package: Midi interface, sound sampler and music editor. Sampler can handle one sample of just over a second. Midi controller software and music editor comprehensive. No through port, though, so 464 users must use tape version. And you can't edit live played Midi compositions.



Sound Blaster

Siren Software ☎ 061 848 8959
£29.99 ● AA23

Amplifier and pair of loudspeakers that plug into CPC for maximum 2 watts sound effects.

Speech Synthesizer

DK/RAM Electronics ☎ 0252 850085
£35, £40 ROM

Add-on producing speech by RSX's: loudspeakers supplied. Cannot include speech in program for someone else's CPC, though. Even so, excellent speech quality and value.

■ VISION

Advanced Art Studio

EEC ☎ 0753 888866
£19.95 disk ● AA21

Recently revitalised, this is the user-friendly, best and most powerful art package: works in all three modes. Can cycle through inks, and cut and paste different areas, transformations and reflections. Fill routines in coloured patterns. Available as a standard version for £15.95.



AMX Art

Advanced Memory Systems ☎ 0925 413501
£69.95 disk only (includes mouse) ● AA7

User friendly, if little unsophisticated compared to *Advanced Art Studio*, but mouse helps greatly. Colour, sprayscans, textures, circles and host of other features.

AMX 3D Zicon

Advanced Memory Systems
£39.95 disk only ● AA24

Best with mouse, produces wire frame constructions: design in 3D and view from all angles. Slow when calculating heavy maths. Note supplies are scarce, and AMS don't plan more.

Cherry Paint

Siren Software ☎ 061 228 1831
£9.99 disk only ● AA20

WIMP controlled – ie mouse moves pointer to various icons to pull-down menus. B/W mode 2 only, but fun. Curves are difficult, but a bargain.

CRL Image System

CRL ☎ 01 533 2918
£14.95 disk/tape ● AA12

Boasts range of picture manipulations and distortions, but lacks art options. Best on finished pictures – like a mini Quantel box.

DART Scanner

Dart Electronics ☎ 0502 513707
£79.95 ● AA22

Attach reading device to your DMP2000, 3000 or 3160. Feed in picture to printer: device reads in picture as B/W image. Quality onscreen isn't amazing, but it works and it's fun.

Electric Studio Light Pen

Electric Studio ☎ 0462 420222
£19.95 tape, £29.95 disk ● AA1

Excellent drawing software, including rubber-banding shapes and lines, filling areas, spray-can etc. Accepts software written for it.



The Informer

Treasure Island Software ☎ 0492 593549
£29 disk only ● AA33

For creating animated displays, suitable for classroom and shop window: takes text, graphics and animated displays and produces slide show. Works best but not only with *Parrotty Plus* (see below).

Parrotty Plus

Treasure Island Software ☎ 0492 593549 ●
£19.95 disk only ● AA30

Rather than lots of effects used anywhere and at any time, *Parrotty Plus* 'remembers' every alteration and plays through the list to create animation. Note: can't dump pictures to printer without external program.

Vidi Digitizer

Rombo Productions ☎ 0506 39046
£89.95 ● AA15

Grabs picture from video recorder or camera and puts it on CPC screen, allowing you to alter it with an package. Easy to use. Software on tape, disk or ROM includes superb printer dump routine. ●

● Corrections, additions or ideas for sections you think should be here are very welcome. Drop a line to: AA Buyers, Amstrad Action, 4 Queen St, Bath BA1 1EJ

Don't miss the next **AMSTRAD ACTION**-packed issue – out on Thursday May 11th!

AAfterthought

Happy birthday dear CPC, happy fifth birthday to you!

The CPC character set

5. The serious programmer



Living in his 'study' (the cupboard under the stairs), the Serious Programmer spends every second from getting home from work to leaving again the following morning (frequently falling asleep in front of the VDU) in this cramped and stuffy little hole in the wall. For this is where The Machine lives, its keys barely accessible beneath a pile of regrettably unlabelled disks, the screen covered in several inches of dust (who needs a glare screen?). Hanging bizarrely from the back is a madcap assortment of roms, romboards and mysterious attachments.

The serious programmer is a master of most computer languages: he knows Pascal and Cobol, and speaks C-Basic like a native. The one language he appears to have

difficulty with is English. Worried queries and offers of food are met with a Stallone-like series of grunts. Eat? Eat? There's no time to eat when you're exploring the boundaries of 8-bit technology!

The SP writes letters to Pat McDonald that begin: 'I have a 6128, a colour monitor, an Epson printer, Maxam on rom, *Protex*, *Promerge*, *Prospell*, *Utopia*, *BCPL* and *Devpac 80...*' and end four pages later with a request for Romantic Robot's phone number.

The SP's children are warned away from 'Daddy's Important Work.' But the shameful truth is that he's trying to prevent them from discovering *Groanin The Psychopathic Accountant*, *Blobheads 6* and other disturbed fantasies of urban vio-

lence. Games are the secret vice that sent the SP to the CPC rather than the PC (or 'Proper Computer,' as its snobbish users call it). For the fact is, rather than plotting the orbit of Jupiter, the SP is in truth plotting to destroy its inhabitants.

The SP buys AA every month, but of course he only reads the serious bits. He doesn't so much as glance at anything else – and as for *Action Test*, God forbid! But that was a funny old score Trent gave *Space Whooshers!* last month, and surely *Blasterboing* is underrated, and...

● Could the author of the above please get in touch and let us know where to send the cheque?

Get yuh own AA, pardner!

To the newsagent: Amstrad Action is distributed by Seymour Press

Dear newsagent,

Please reserve me one copy of the June Amstrad Action, due out on 11 May

Name:

Address:

Telephone number:

If you're under 16, please get your parent or guardian to sign here:



The fifth anniversary of the CPC, can you believe it?

Anyway, to celebrate five years and one month of the CPC, next month we have a positively *comprehensive* round up from Trenton of soccer sims – undergoing a strangely vigorous renaissance all of a sudden; a review of what we strongly suspect is the best ever DTP package for the CPC (and it's very cheap too!); Phil Howard kicks off a major series on hacking; and Stuart McColl explains just what's inside a computer. All this and more in June's AA!

MAKE YOUR **AMIGA** EARN

Yes making money becomes incidental when you know how. Your micro is, if only you knew it, a gold mine. The size and make is irrelevant. Make the initial effort **NOW** by starting your own

HOME BASED BUSINESS

This may be the most important move you will ever make!

REMEMBER: You'll never get rich by digging someone else's "ditch". Anyone in the country including YOU, can become very rich in a relatively short period of time just by doing a few basic things! It's more rewarding than playing games. The benefits are many and varied. Full or part time.

For **FREE** details send S.A.E. to:



HOME BASED BUSINESS

31 PILTON PLACE (AA 1)
KING AND QUEEN STREET
WALWORTH, LONDON SE17 1DR

ADVERTISERS INDEX

ARC	53	Matrix	53
BBD Dust Covers.....	46	McQuoid	32
Camel Micros	53	Microstyle.....	32
Crazy Joe's	32	Mode 1	53
E. Prattley	53	Nemesis.....	25
E&J Software	25	Ocean	2-3, OBC
Entertainments International.....	30	Romantic Robot	37
First Byte Software	46	SDC	34
Goldmark	18	School Software.....	25
Greyhound Computers	32	Swift Software.....	27
Home Based Business	70	US Gold	IBC
John Morrison	46	VSE	53
K&M Computers	14	WACCI.....	10
MJC Supplies.....	6		

SPECIAL OFFERS

Excellent reasons for subscribing to AA Now!!

- Receive your magazine before it hits the shops - and SELLS OUT!
- And get £20 worth of Amstrad Action Special Offer Vouchers
- Subscribe to Amstrad Action for £16.50 and you will receive 12 issues plus £20 worth of vouchers!

See page 74 for details of Voucher scheme.
Order Code AA396

T-SHIRT Just £3.99

The amazing AA T-shirt is here! The sparky red and blue AA logo is printed on a white cotton T-shirt which you can buy for £3.99 in either medium or extra large sizes. Get this and you'll have AA even nearer your heart than ever before!



Order Code
A361 (medium)
A362 (extra large)

HIGHLIGHTER PENS

Three for £1.50

For bringing out those key phrases, there's nothing like these AA-embossed pens in red, yellow and green.
Order Code AA266



AA DUST COVERS

2-piece set only £6.95

A set of dust covers provides a neat solution to dust, tea and other potential computer disasters.

These specially-commissioned Amstrad Action covers are made from high-quality, water (and coffee) proof PVC. They're coloured a gentle beige with smart blue trimming and matching AA logo.

You can order a 2-piece set tailor-made for your CPC system - just choose the correct order code from the list below.

Order Codes

- | | |
|-------------------|--------------------|
| 464 mono - A208 | 664 colour - A211 |
| 464 colour - A209 | 6128 mono - A212 |
| 664 mono - A210 | 6128 colour - A213 |

AA BINDERS

Just £4.95 each

The fabbo AA binder is the ideal item in which to store your growing collection of the world's most popular CPC magazine! Holds 12 issues, this royal blue binder with gold embossed logo on side and front is an essential purchase for even half-serious readers.

Order Code AA217

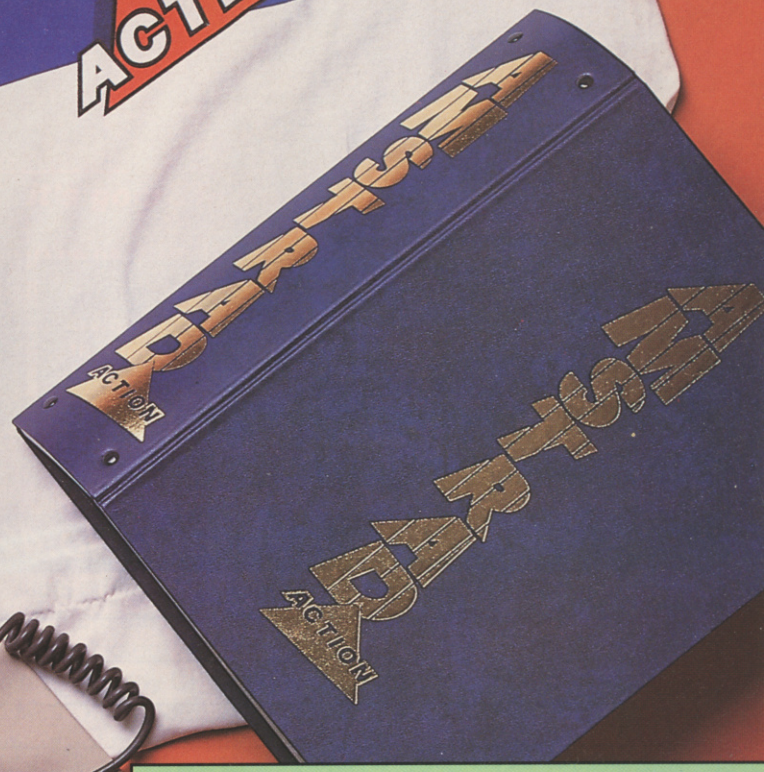

AA Back Issues are just £1.25! See page 74 for details

SPECIAL OFFERS

**THE REPLAY
"MICRO-BLASTER" JOY-STICK**

RRP £12.95 AA PRICE £10.95

The best joystick around for smooth, accurate and comfortable playing action and arcade playing and quality. *Non slip rubber feet on base for secure table mounted operation.

*Large, dual-fire micro-switched fire buttons for left or right hand operation.

*Extra long 1.4 metre cable allows more choice of player position.

*12 month guarantee

*Switchable normal/rapid fire options for extra control and higher scores.

Order Code AA399



THE ADVANCED OCP ART STUDIO FORM EEC

RRP £24.95

AA Price £19.95

For CPC6128 users (or 464 users with disc drive and 64Krapak)

The ultimate in computer art and design for your CPC — no budding artist should be without. Operates from mouse, keyboard or joystick control. Includes 16 drawing pens, 8 random spray cans and 15 user-definable brushes.

- Three levels of magnification with pixel edit, pan and zoom
- Full range of colours
- Windows can be cleared, inverted, cut and pasted, enlarged, reduced, squashed, stretched, flipped and rotated.
- Full-feature font editor allows the design of complete character sets

Order Code AA410

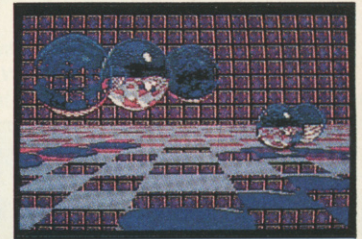
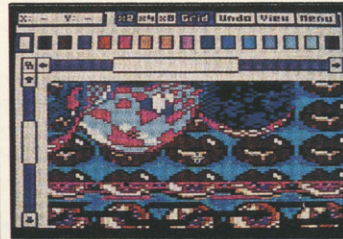

HOW TO ORDER

Just fill in the order form below. Use the order numbers listed with the product, OR, for a subscription, look at the Subscriber Code box above.

Or phone us with your credit card details on 0458 74192

(24-hour answerphone).

● **ORDER FORM No.42** ●

Name _____

Address _____

Please remember the post-code, it is essential! _____

Tel Number (If possible) _____ Date of Order _____

Please send me the following item(s) from the Amstrad Action Special offer pages:

CODE	DESCRIPTION	PRICE

Total Payable

Make cheques & postal orders payable to FUTURE PUBLISHING LTD. If paying by credit card, please enter details

CREDIT CARD NUMBER

EXP. DATE

Send this form plus payment to **SPECIAL OFFERS, AMSTRAD ACTION, THE OLD BARN, SOMERTON, SOMERSET TA117PY**

**SAVE
£20**

**LOOK
OVER
PAGE
FOR
DETAILS**

SPECIAL OFFERS

WEC LE MANS

This is Le Mans,

one of the greatest of motor races and WEC Le Mans, an excellent endurance car game, is worthy of its illustrious name.

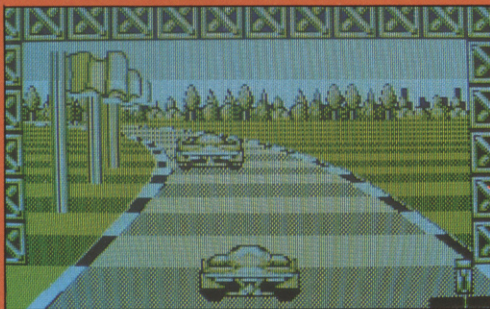

A first-rate race game with enough tricky little corners and mad drivers to keep you going round in circles for days: -

Twenty four hours of blood sweat and gears. The throb of the engine The wind in your helmet The car wrapped round a lampost!

AA rating (March '89) 82%



"It's fast, it's good. In fact it's brilliant."

Order Codes

Cassette	RRP £9.95	OUR PRICE £8.95	AA 392C
Disc	RRP £14.95	OUR PRICE £13.95	AA392D

**HOTLINE
PHONE
0458 74011**

BARBARIAN II From Palace Software The Dungeon of Drax

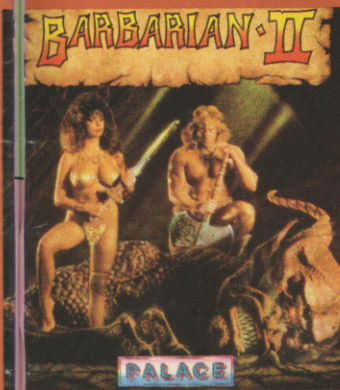

It is decided that there is only one way to stop Drax from wrecking the Jewelled Kingdom. The Barbarian and Mariana — herself an accomplished swordswoman, are the only two warriors skilled enough to survive the perilous journey to Drax's lair. They must stop him before it's too late!!

Choose to play either Barbarian or Mariana and fight your way through three levels:- the Wastelands, the Caverns and the Dungeons before arriving at the fourth level, the Inner Sanctum of Drax!!

Each level has six different types of monster from Saurian beasts to Giant Grubbs. Collect four magical objects from each level to reach your quest..

Start the game with five lives and fight your way to his sanctum for your final conquest.

Ams Cass RRP £9.95 AA Price £6.95 Order Code AA411AC

AmsDis RRP £14.95 AA Price £9.95 Order Code £9.95

MINI OFFICE II

**£12.95 tape £17.95 disk
(RRP £14.95/£19.95)**

Database's combined word processor, database, spreadsheet, label printer, communications and graphics package and offers the best value for money in any eight-bit integrated package.

Suitable for any CPC (it doesn't run under CP/M), AA called Mini Office 'good enough to fulfil the entire software needs of many a small business!'. That is borne out by the sales figures

- more than 400,000 users across the country.

The figures testify to the features. You can build a verstaile card index, produce pie charts, access Prestel and other comms networks and run off personalised letters. Altogether, you may never need any other program once you've got Mini Office II. Time to get serious?

Order Code AA388C
Order Code AA388D



SPECIAL OFFERS

SUBSCRIPTIONS

New subscribers welcome! As well as getting your 12 issues posted directly to you from the printers, we have a new Subscriber Scheme. This is how it works: immediately after you subscribe we send you £20 worth of vouchers for our mail order section. This offers you a £20 saving on mail order products from these pages over the next 12 months. For every £10 spent you save £1. Plus by subscribing look out for our up-to-the-minute super duper exclusive .ed to you in the next few weeks.

Order Code AA396

OVERSEAS SUBSCRIPTIONS

Air Mail-Europe £31.50 -Order Code AA397

Surface Europe and Rest of World £21.50-Order Code AA398



AMSTRADS AND ARTIFICIAL INTELLIGENCE

by Patrick Hall
Just £1.95 (RRP £8.95)

This book looks in detail at one of the most talked-about topics of our generation - artificial intelligence. The book discusses the requirements of AI and offers several program listings that allow you to start tackling the issues at the practical level. Didn't think you could get AI on your CPC? Well think again. Topics include expert systems, computer vision, robots and learning, game playing and knowledge representation. All this for just £1.95. An excellent book for anyone who owns a CPC and wants to take it further than ever before.

Order Code A895

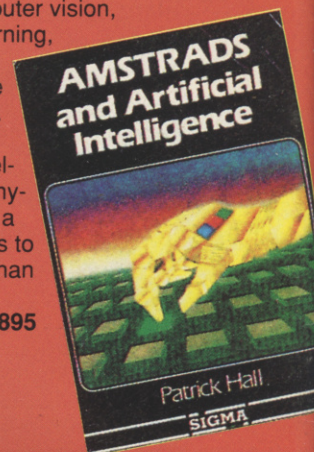

BACK ISSUES

Expand your Amstrad Action collection!

If you're one of the thousands of readers who've joined *Amstrad Action* only recently, you'll want to catch up on some of the good things you've missed. Here's how to do it. We have limited numbers of the back issues listed below, which we're selling at cover price with post and packing free.

All issues contain numerous game reviews, Type-Ins and Pokes, all making up the best in Amstrad Action past and present.

- | | |
|-------------|---|
| ISSUE 1-22 | SOLD OUT !!! - S O R R Y !! |
| ISSUE 23 | £1.25 • Launch of Word-Processing series. Utility Type-ins. |
| ISSUE 24 | Two years of AA! Exolon. Word processors. Tas-Sign. More WIMPs. |
| ISSUE 25-28 | SOLD OUT! |
| ISSUE 29 | £1.25 • Six top printers reviewed. Spreadsheets. |
| ISSUE 30 | £1.25 • Discovering databases. How to upgrade a 464 to a 6128. |
| ISSUE 31 | £1.25 • CP/M software section starts. Basic programming reaches part five. |
| ISSUE 32 | £1.25 • Educational software survey. CP/M on ROM. Word processing. |
| ISSUE 33 | £1.25 • Loads of hardware projects! - joystick, splitter, I/O port etc. Comms. |
| ISSUE 34 | £1.25 • Simulation software from space shuttles to bikes. Small business? |
| ISSUE 35 | £1.25 • Joy of hacking scrutinised! Buyers guide to computer books. |
| ISSUE 36 | £1.25 • Micronet - worth it? Code Masters? Printer selection. |
| ISSUE 37 | £1.25 • 3rd birthday cover tape includes <i>Dizzy</i> . D & Der's get <i>Heroes of the Lance</i> . |
| ISSUE 38 | £1.25 • Fleet Street Editor arrives. Micro Music. Empire Strikes Back. |
| ISSUE 39 | £1.25 • Language guide - from C to Basic. 14 pages of Xmas games. Gambling with Coursemaster |
| ISSUE 40 | £1.25 • Cover Cassette • <i>Total Eclipse</i> demo • 1988 Games Awards. Turkeys '88. Preview 1989. Comms special. Nemesis. |
| ISSUE 41 | £1.25 • Databases for all Hard drives • Pilgrim special Batman, Jedi |
| ISSUE 42 | £1.25 WEC Le Mans & Airbourne Ranger reviewed-How to write a best seller!- Loads of Hot Tips!! |

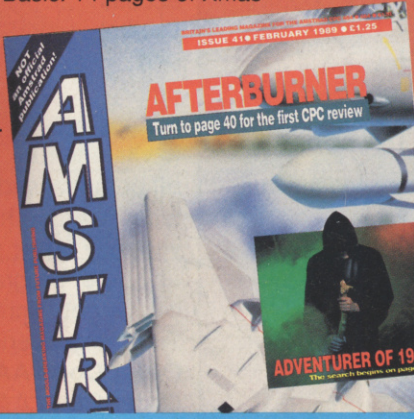

24 HOUR CREDIT CARD ORDERS
0458 74192

ATLAST PLUS CPC6128 CP/M database now £29.95 (RRP £39.95)

"Superb value for money and hard to pick holes in" we called the first version of *AtLast*. Now, with the release of *AtLast Plus* by Rational Solutions, you have the chance of buying one of the best (and probably *the* best for the 6128) databases for £29 - £10 less than the full retail price!

AtLast Plus handles up to 32,000 records, ten files per database, 20 fields per record, 99 elements per field and up to 79 characters per element. User-definable report and screen layouts, full on-screen control of data entry, impressive indexing/sorting facilities and automatic data re-organisation are all included in this latest version.

The package includes disk and full 120 page manual - altogether one of the most suitable programs for organising club-type membership lists, and unbeatable value for money - only through *Amstrad Action*.

Order Code AA360

BRINGING HOME THE CHALLENGE OF THE ARCADE

LAST DUEL™



Atari ST
£14.99 Disk

Amstrad
£9.99 Cassette
£14.99 Disk

CBM 64/128
£9.99 Cassette
£14.99 Disk

CAPCOM™

IBM PC
£19.99 Disk

Spectrum 48/128K
£8.99 Cassette
£12.99 Disk

CBM Amiga
£14.99 Disk

Screen shots from Atari ST version.



LAST DUEL™ The golden tribe of BACULA have over run the twin planet IMU and taken captive the beautiful Princess SHETA. Few warriors survive and only one retains the courage and willpower to face the awesome task ahead. Battle your way through six enemy occupied territories laden with traps, terror and gargantuan defenders, the like of which no earthly body has ever set eyes upon. Your neutron powered car and galactic hoverplane provide speed and firepower, your nerve and skill offer the only hope of freedom for your beloved Princess.



ILLUSTRATION: PETER ANDREW JONES.
COPYRIGHT: SOLARWIND LIMITED

Sort out the  MEN from the  BOYS!

RUN THE GAUNTLET



"... What a brilliant game!... all the action, thrills and spills. This is an excellent game, so good Run The Gauntlet, NOW!" - Go and
 "... apart from technical excellence it's the sheer range of playable sections that makes Run The Gauntlet one of the best multi-event games..." - Crash

JETSKIS

HOVERS

SPEEDBOATS

METEORS

BUGGYS

Inflatables

SUPERCATS

QUADS

THE HILL

9
EXPLOSIVE EVENTS

SPECTRUM 8.99
 COMMODORE 9.99
 AMSTRAD 9.99

ocean

ATARI 19.99
 AMIGA 24.99

Also available on DISK.

6 Central Street · Manchester · M2 5NS
 Telephone: 061 832 6633
 Telex: 669977 OCEANS G · Fax: 061 834 0650