

**NOT
an official
Amstrad
publication!**

**AMSTRAD
ACTION**

FROM FUTURE PUBLISHING - THE WORLD'S VERY BEST MAGAZINE DEDICATED TO THE CPC!

ON TRIAL

The Magnum lightgun:

charged with
revolutionising
the CPC game
as we know it
- AA delivers its
verdict on p.42



Competitions, reviews, games tips, technical help, hacking, type ins, buyers guide, readers letters, news and more..

**HOW TO WRITE A
BEST SELLER**

Pandora opens the box

GET CRUCIAL - GET GOLD!



£9.99 cassette
£14.99 disk.



VIGILANTE™ 1994 New York... The police dare not patrol the streets. The army cannot control the city. Law and order no longer exists... When street gangs dominate a city, your last chance is Vigilante. This time it's war.



Screen shot from Street Fighter.



Screen shot from Road Blasters.



ARCADE MUSCLE™
The ultimate collection in death and devastation. The supreme challenge of skill and determination that only champions of skill, strength and stamina should ever consider.

ROAD BLASTERS™ • **BIONIC COMMANDO™** • 1943™
• **SIDE ARMS™** • **STREET FIGHTER™**

£12.99 cassette £19.99 disk.



£9.99 cassette
£14.99 disk.

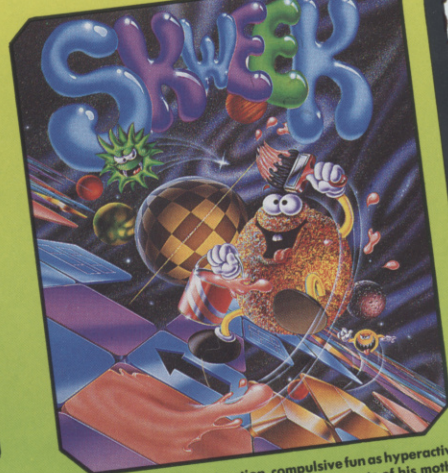

SKWEEK™ Manic action, compulsive fun as hyperactive Skweek sweeps through the 99 contingents of his mother planet decontaminating them on his way. Skweek is fun. Skweek is action. Skweek will last forever.

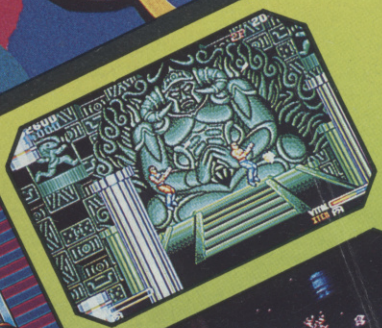

£9.99 cassette
£14.99 disk.

FORGOTTEN WORLDS™
Two cool dudes - One hot situation - Eight megalithic Adversaries. It adds up to a whole lotta trouble.

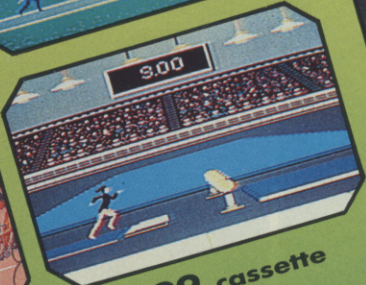
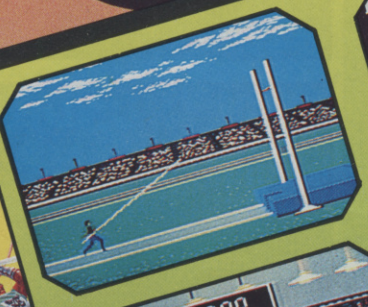

£9.99 cassette
£14.99 disk.

THE GAMES SUMMER COLLECTION™
Body co-ordination, muscle power and speed. Exhaust your limbs on the wildest events ever compiled for Human competition.



£9.99 cassette
£14.99 disk.

HKM™
From Holland to Spain, from Germany to Palestine, no matter the odds, no matter the scene - He's tough, he's mean, he's the Human Killing Machine.



SCREEN SHOTS FROM VARIOUS FORMATS.

THE STREETWISER'S GUIDE TO ESSENTIAL EQUIPMENT!
U.S. Gold Ltd., Units 2/3 Holford Way, Holford, Birmingham, B6 7AX. Tel: 021 356 3388.

THE LINE UP

AMSTRAD ACTION ● AUGUST 1989

FRONT END

NEWS●LETTERS

- 7 AMSCENE**
The CPC news: essential reading
- 11 REACTION**
Another AA postbag bursts open and spills all over Steve
- 14 EMMA BROADLEY**
It's That Woman Again!

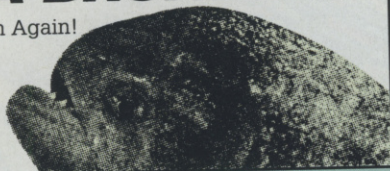

SERIOUS SIDE

SOFTWARE●HARDWARE●PROGRAMMING

- 16 COULD YOU WRITE GAMES?**

You'd be astonished what you can do with Pandora, a brand new games writing utility from Swift Software.
PAT McDONALD gives it a try
- and we give twenty copies away!



- 20 HELPLINE**

The best way to meet friends and get CPC Aid

- 22 PRINTER HEAD TO HEAD**

We pit two more top printers against each other - which gets the AA seal of approval?

COMPETITION



- 19 STOCK CONTROL - UPDATE**

We handed over SD Microsystems' small business aid to STEVE PALMER for in-depth testing and evaluation

THE ACTION BEGINS ON 40!

THE VERY BEST IN CPC ENTERTAINMENT

- 40 3D POOL**

More interestin' than Steve Davies certainly - but is it as fast as Hurricane Higgins?



- 48 THUNDERBIRDS**

Calling International Rescue...

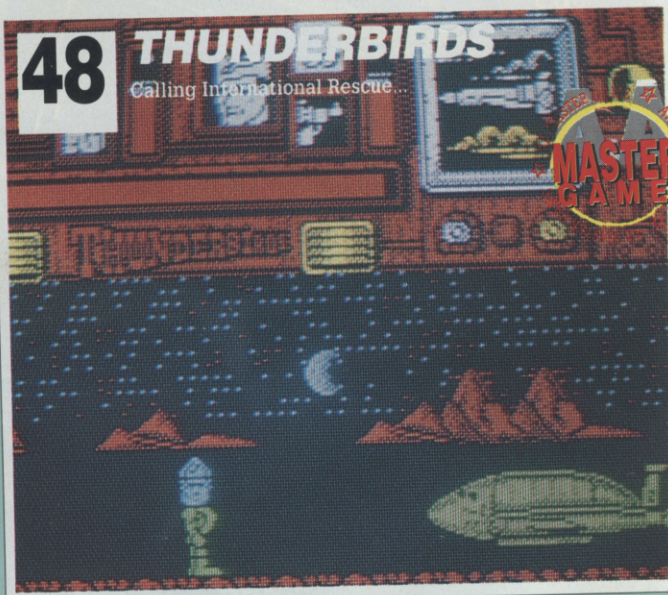

- 25 SMALL ADS**

Buy cheap, sell dear - that's how Al Sugar started!

- 36 STAR WARTS**

Yet another spiffing PHIL CRAVEN hardware project

- 30 FORUM**

Three pages of technical hips, tints and other spoonerisms

- 36 THE LOOK**

Graphics programming made plain

- 58 INSIDE OUT**

Secrets of the CPC with STUART McCOLL

**ACTION TEST:
page 40!**

All this! ▶ 3D Pool, p.40 ▶ Thunderbirds, p.48 ▶ Silkworm, p.50 ▶ Xybots, p.55 ▶ Skweek, p.46 ▶ Time Scanner, p.47 ▶ Skate or Die, p.53 ▶ Rick Dangerous, p.57 ▶ The Games, p.55 ▶ The Games, Summer Edition, p.57 ▶ and that's where we run right out of room...

Write a bestseller

Cover feature this month on the serious side is Swift Software's games writing utility *Pandora* – see pages 16-17. It's something everyone who programs on the CPC will need to know about. The idea of a games writing utility that does rather more of the work, allowing you to put your brilliant games concept into operation, is infinitely appealing.

Writing software is a hell of a difficult task, as anyone who's ever tried will know. It takes real genius – and genius, after all, is 99% perspiration and 1% inspiration.

But the hardest part of writing a game, I'd suggest, is not the coding itself, tricky, time-consuming and perspiration-inducing though that is. No, the really elusive part is the inspiration. For every hundred run-of-the-mill shoot-'em-ups, vigilante punch ups, simulators and tie-ins there's maybe four or five truly innovative ideas in there.

So now, with our *Pandora* competition (see the review) is your chance. You don't even have to go to the trouble of writing the game – all you have to do is to provide that spark of genius. Twenty lucky winners each receive a copy of *Pandora*, and the best ideas will be published. And who knows, maybe one of the big software houses, who are always looking out for good games concepts, may take you up on it...



Steve

42 MAGNUM LIGHTGUN

The most powerful light gun in the world?



47 TIMESCANNER

Tilting in your direction...



61 SKATE OR DIE – THE COMPETITION!



"Woo, yeah!" "Go for it!" ... and other things an ancient *Line Up* writer fondly and falsely imagines are "with it" phrases. In any case, "pop pickers," now is your chance to win this "hip cool trendy" ice-skating "gear" (er, that's skateboard equipment, we think you'll find).

78 AFTERTHOUGHT

Exclusive pictures of the Ed's scariest adventure



62 TYPE INS

Let your fingers do the typing...

68 CHEAT MODE

Live forever, and never run out of firepower!

72 INSIDER DEALING

Hacker's heaven – the secret's out!

75 BUYERS GUIDE

Spend spend spend – but look here first!

75 SPECIAL OFFERS

Don't miss out on the best CPC deals around!

Future Publishing Limited
4 Queen Street, Bath BA1 1EJ

☎ 0225 446034 ● Fax 0225 446011 ● Editor Steve Carey
● Technical editor Pat McDonald ● Games editor Trenton Webb
● Art editor Ollie Alderton ● Additional design Martin Parfitt
● Contributors Emma Broadley, Super Phil Craven, Phil Howard,
Stuart McColl, James Wil son, Steve Palmer
● Publisher Greg Ingham ● Production Diane Tavener ● Subscriptions
Christine Stacey ☎ 0458 74011 ● Mail Order Clare Bates ☎ 0458 74011 ●
Advertisements Elaine Brooks ☎ 0225 446034

ABC

MEMBER OF
THE AUDIT
BUREAU OF
CIRCULATIONS

38,457

July-
December
1988

© FUTURE PUBLISHING LTD 1989 *Amstrad Action* is an independent publication. The company producing it – Future Publishing Ltd – has no connection with Amstrad plc. We cannot guarantee to return material submitted to us, nor can we enter into personal correspondence. We take great care to ensure that what we publish is accurate, but cannot be liable for any mistakes or misprints. No part of this publication may be reproduced in any form without our explicit written permission.

HE'S THE HERO OF THE GALAXY – PAINT POTS AWAY ...

SKWEEK

IS HERE TO SAVE THE DAY!

SKWEEK RULES OK!

SKWEEK FOR PRESIDENT!

Have you ever wanted to paint the town red?
 Well, now you can paint it PINK instead!
 A fast-moving arcade game that's a bundle of fun,
 Our hero Skweek keeps you on the run!
 Go through 99 levels – get that winning score –
 It'll drive you crazy, but you'll be back for more.
 A game that's a winner, without a doubt.
WATCH OUT, WATCH OUT – THERE'S A SKWEEK ABOUT!



AMSTRAD CASSETTE
 £9.99
 DISK £14.99

loriciels
 © Loriciels 1989. All rights reserved. Manufactured and distributed under licence by U.S. Gold Ltd., Units 2-3 Holford Way, Holford, Birmingham B6 7AX. Tel: 021 356 3388

ATARI ST
 IBM PC
 CBM AMIGA
 £19.99



Screenshots from Atari ST version.

AMSCENE

releases... updates... previews... new releases... updates... previews... new

Bad day for "black box" brigade

The Multiface, a device owned by thousands of CPC users for breaking into games, is dead. That is the sad news as of August 1st 1989, when the 1988 Patents, Design and Copyright Act comes into force. Established, amongst other things, to protect the software industry against professional pirates who make copies of software and sell them, the Act aims to define what you can and can't do with your software.

Hard Act to follow

Alex Goldscheider, boss of Romantic Robot, decided some time ago that he would stop selling the device on July 31. "At the moment, we're still seeking legal advice as to what our options are," he told AA. "Ideally we'd like to keep selling the product in the UK. But because it was probable that we couldn't actually do that, we ran several adverts to tell people that pretty soon it wouldn't be available.

"It could be that we'll manufacture it here and sell it abroad," he went on. "We've had differing legal opinions from barristers over just what we can and can't do. At the end of the day, though, we don't want to do anything illegal - we'll take the most honorable course of action."

Economical with the truth

Goldscheider claims that the only complaints Romantic Robot have ever had came from Dave Marshall of Digital Integration: back in AA38 there was a memorable bust-up between the two, both accusing the other of distorting facts and misleading the public.

Yet despite the advertisements that Romantic Robot have been placing for the past few months stating that the end of the Multiface is nigh, it is by no means clear whether a successful prosecution could be brought. Legal eagles will

recall that there was a hell of a fuss some years ago over an Amstrad twin-cassette unit advertised as able to copy tapes. In the end the judgment was that if a device has legitimate, legal purposes, and is not advertised as a piracy device, then it remains a legal unit, despite its copyright infringing capacity.

The plot thickens. Watch this space!

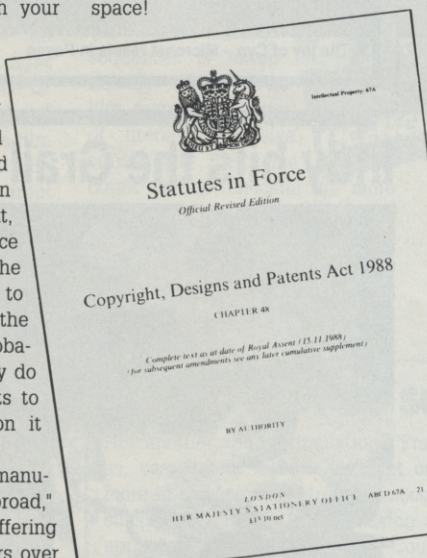

Frantic Robot

So just what is in this big bad legislation? As always with Parliamentary Acts it's a mass of byzantine jargon wholly incomprehensible to the layman. But buried amidst the legal chicanery is the phrase "designed or adapted to circumvent copyright while being used in the course of a business." This is solely designed to guard against piracy.

The question remains though: do Multiface backups - for which a Multiface must be connected to the computer in order for them to work - constitute copies under the new law? Until a test case has been brought no-one can answer that question. Neither the man behind the Multiface, Alex Goldscheider, nor the man whose job it is to catch software pirates, Bob Hay, is in a position to act confidently.

It seems highly improbable, however, that owners of the device need fear arrest or imprisonment, for the Act is likely only to affect the mass sale of "black boxes" by companies such as Romantic Robot.

Meanwhile Romantic Robot's boss was keen to reassure his customers: "Of course existing owners will continue to receive support for faulty devices. If they're out of guarantee then these must be paid for, but we will honour our commitments to our customers."



● Goldscheider: whither Romantic Robot?

The hunter and the hunted

Bob Hay of the Federation Against Software Theft (FAST) is a man in two minds. The Act that received its Royal Assent on 15th November of last year is excellent news in that his job catching the pirates will be more clearcut. On the other hand, he has a massive task on his

hands. No-one is expecting the pirates simply to shut up shop and turn to more legitimate ways of turning a buck simply because there's now a law to stop them.

Hay is cautious about the whole Multiface issue: "I've heard about it," he said. "I also saw the advert saying that they were withdrawing it from the market. Now offhand I can't say whether it's illegal under the new legislation or not, but I can describe the conditions for that sort of status.

"The key phrase," he went on, "is 'specifically designed or adapted to infringe copyright.' If a device falls within that, then as of August 1st it is outside the law to make, sell, hire, import into the UK or use as part of a business any 'black box.' The criminal code for that is section 107/1D, and indictment carries a two year gaol sentence plus an unlimited fine."

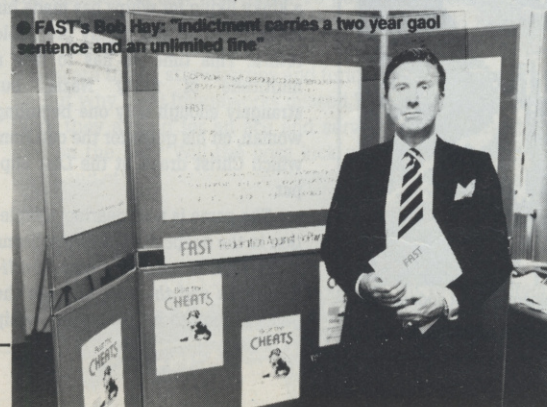

VAT man robs Micronet

Chancellor Nigel Lawson has ignored the efforts of Micronet to overturn his Budget imposition of VAT on online information services.

Despite a petition (submitted by modem, naturally) of over 3,000 "signatures" presented to the Chancellor protesting over the imposition of VAT, Micronet now appear to have little chance of reversing the decision.

The new tax came about after the Economic Secretary to the Treasury, Peter Lilley MP, had pointed out in the House of Commons that businesses that use online services to gain information charge VAT on transactions, so why shouldn't the charge apply to operations such as Micronet and Prestel?

After the online charge was implemented (7p a minute on

peak rate) many fans left the system, claiming that the cost was unjustifiable.

Micronet's view is that the Government's decision represents the thin end of the wedge, and that general taxation of the press will follow.

"There is no excuse for this," stormed Micronet's Product Manager David Rosenbaum: "Either the Government is preparing the ground for the general imposition of VAT on the press, or they have made a serious error. We're taking a stand because we don't believe there should be a tax on information and we don't believe there should be different rules for electronic media."

One wonders whether Micronet would be quite so swollen with righteous indignation if paper publications were

VAT rated and electronic ones not. Still, perhaps the blow will

not be quite as damaging as Mr Rosenbaum fears.

Den of Cyn

Cynthia Payne, celebrity, ex-prostitute and broth... er, well, the party hostess to top them all, is now offering advice and solutions to personal problems via Micronet. Key *82855 for Madame Cyn's Boudoir. The cost of reading all those juicy details is 20p per problem and 15p for the reply. The replies take up several pages, and if agony aunt Payne is receiving cash for each of them, she should be onto a nice little earner.

Perhaps she can give Dave Rosenbaum some advice on how to stop that nasty Chancellor running off with 15% of his takings.

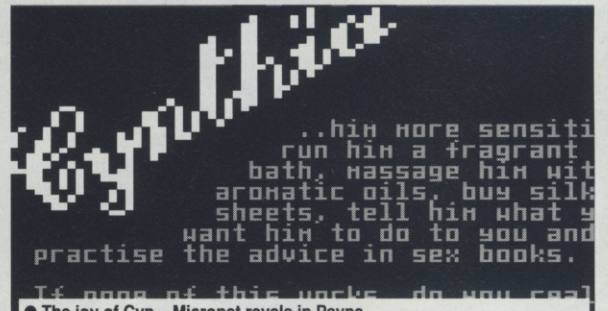

● The joy of Cyn - Micronet revels in Payne

Die, mutant alien scum!

Tecmo arcade shoot'em up *Gemini Wing* is getting the Virgin Games treatment even at this very moment.

It would appear that we the human race have grossly insulted the aliens of the galaxies with headlines in the *Someday Spurt* like "DIE MUTANT ALIEN SCUM."

They are now winging their way across the vastness of space to teach us some respect and let gutter press journo

s know how it feels to have their livers sucked out with a straw.

But they haven't counted on the famous *Gemini Wing* spacecraft. They think they're going to play "Fry the carbon kids," while we are just waiting to get into some serious vertical shoot'em up action.

As everyone knows we *homo saps* are real good at that stuff, so we'll bring you a war report as soon as our *Gemini* fighter arrives from Virgin HQ.

Indy hits the Grail trail



Dr Jones the famous archaeologist and his son 'Indy' (named after the dog - not many people don't know that) are on the Grail trail. The guy with the nice line in hats, jackets and a kinky liking for whips has made his much heralded and highly profitable return. This time he has to face a multitude of nasty Nazis, but strangely enough only one beguiling woman, on his quest for the cup from which Christ drank at the Last Supper.

The game is now nearing completion in the deepest, darkest dungeons of US Gold. Based on the movie *Indiana Jones and the Last Crusade* the game is soon to hit the streets, whip

and all. In order to get everything ready for a near simultaneous release with the film the 'Gold team have had access to the original script. But the Lucasfilm boys were so keen to stop script leaks that US Gold have been forbidden to say what happens in the game.

The action-packed movie should be a very fertile ground for computer games, so things are looking good. As soon the game is unleashed AA will rush you the review. But until then here's the theme tune, as hummed by the team: Dum da dum dum, dadada. Dum da dum dum da da da da (sounds like "Love Story" to me - ed.).

THE SALES BUDDIE PRESENTS

GEMINI WING

● Gemini Wing - coming in to land on your CPC imminently, if not sooner

Domark grab Bond's licence to print money

After years working on Her Majesty's Secret Service, 007 has turned in his badge and gone solo. Why? Why would anyone walk out on a well-paid job with good promotion prospects, nice staff canteen and a decent pension (if you live to collect it)? Answer: revenge. Some dimwitted drug smuggler has gone and crippled Jimmy's pal Felix (you remember, the plot mechanism for close escapes) – and on his wedding day too!

Licence to thrill

Now you can follow the vengeance trail and help J.B. right wrongs with the new *Licence to Kill* game from Domark, scheduled to hit the small screen as the film hits the big one. As with most film licences it takes key scenes from the movie and recreates the part for you to decide the outcome –



● It's Timmy as Jimmy in *Licence to Kill*

and with James Bond as the source the ground for games sequences is exceptionally fertile. The film features a series of literally explosive stunts, and the game ought to be chockful of more action than you can wave a dry, shaken but not stirred Martini at.

Your mission, Meesta Bond, is to track down Mr Leiter's assailant. *Thrill* to the action as

you swoop through cities in helicopters, swim in sharks infested water and even steal a crop duster for one final action-patched, stomach-churning attempt to stop that nasty Sanchez – you can tell he's a baddie, he's ugly – from reaching the border and freedom.

Look in these very pages next month for the fullest CPC review of Domark's *Licence* licence.

Amazing: now Flippo takes on Skweek!

There'll be tears. No sooner has *Skweek* established his pink patch in the hearts of umpteen CPC owners than arch-rival Flippo threatens to knock him off his perch (or tile, as the case may be).

Mazemania from Hewson will be with us before you can say "flip me." Hero Flippo has to negotiate his way around a maze of tubular bells turning tiles as he goes.

If he manages with the aid of power icons to escape the black holes then a visit to the vegetable garden is next.

Meet us there for the next thrilling instalment of "the cutesy wars" in next month's twee *Action Test* for the under fives. (Only kidding: if it's half as much fun as *Skweek* it'll be worth playing. Emma Broadley tells us she's hardly left the little fella alone, much to his exhaustion.)

You cannot be served

Not another sports simulation? 'Fraid so, yes. But at least it ain't yet one more in the constant stream of soccer sims. This time it's tennis making an appearance on the Centre Play Court, or CPC as it's known, in the form of the Imageworks full price conversion of the Sega coin-op *Passing Shot*. The arcade features all kinds of shots available to the player who knows what they actually do: slice, lob, spin, smash and that funny shot that shoots off in a completely unexpected direction and hits the umpire.

You follow the players on the Grand Slam tour playing singles and doubles on clay and grass. To pep up the realism all the usual crew are there – ball boys, line and net judges to help enforce the rules and give you someone to shout at. If this is real tennis, though, where are the £1 strawberries and furious thunderstorms?

But why have Imageworks missed Wimbledon by such a margin? Were they aiming for an ace and serving a double fault? Are their jobs on the line? Will the boss kick up a racquet? The answers to these and other questions will be revealed just as soon as we can get our hands on the game. However, hold your breath...

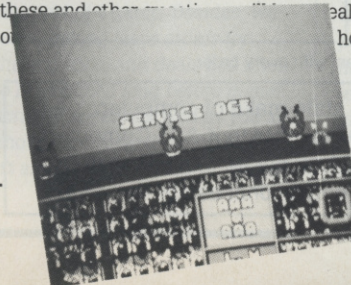

● Anyone for tennis? Yes, say Imageworks: above and left, two shots from the Sega coin-op. CPC version soon...

Competitions: the winners

We're all off to Wembley! Well, that's not quite true, but certainly JOHN GORDON of *Blackheath in London* is. His entry to the Audio-genic *Emlyn Hughes International Soccer* competition back in AA45 was by far and away the worst collection of bad footie puns it has ever been our excruciating duty to suffer. Here's a taste: "... Jones is on the ball. He falls off and passes to Sanderson, who shoots. The ref tells him to put the gun away. Sanderson hits the bar and knocks the drinks off..." (that's enough *John Gordon* – ed.). John and a friend, who get the AA VIP treatment for the Charity Shield between Liverpool and Arsenal, will be submitting their match report for your punishment shortly.

● And our teeny weeny oh-so-inconspicuous-we-didn't-think-anyone-would-notice *Little Filler Comp* attracted a surprisingly large number of entries, too – close on 50, in fact. We wanted to know how many times the word Cecco appeared in last month's issue. You came up with various answers from four to 13 – and one genius who pointed out that "Cecco" doesn't appear in "this month's AA" (geddit?). Anyway, the lucky winner of the crisp, slightly salted, cheese'n' onion flavoured AA tenners is Paul Papathomas of Barnet in Herts.

● This month's *Filler Comp* offers you another chance to win a tenners, provided you've read the issue pretty closely.

Tell us, on a postcard or the back of an envelope, who tidied up the AA office this month:

AA Filler Comp # 2,
4 Queen St, Bath BA1 1EJ.

AEM2 is here

Number two of the *Amstrad Enthusiast's Magazine* is out now, with the fastest and most packed issue they've ever done (think about it). Send a mere 60p (cheque to Neil Selwyn) to AEM, Highfield, Coombe Keynes, Near Wareham, Dorset BH20 5PS.

Contributors, reviewers and other budding journo types are once again welcome, but don't expect huge fees.

● If you run a CPC fanzine, send us a copy immediately with all relevant details and we'll do our level best to fit you into next month's special on the Amstrad fanzine scene.

K & M COMPUTERS

THE LEADING AMSTRAD MAIL ORDER SPECIALISTS

ADVENTURE CASS DISC

Time and Magik	£11.25	£11.25
Gnome II: Ingrid's back	£11.25	£14.75
Lancelot	£11.25	£14.75
Jinxter (6128)	£14.75	
Corruption (6128)	£14.75	
Return to Doom	£12.50	

COMPILATIONS

The In Crowd	£11.25	-
History in the Making	£15.95	£21.50
Taito Coin-op (inc. Rastan)	£9.90	
Supreme Challenger (Inc Elite)	£9.90	£13.10
Gold Silver & Bronze	£11.25	£21.50
Giants	£10.50	£15.95
Flight Ace	£11.25	£13.95
Arcade Muscle	£10.50	£Phone
Command Performance	£9.90	£15.95
Frank Brunos Big Box	£9.90	£13.10
We are the Champions	£7.75	£13.10
Fists N Throttles	£9.90	£13.10
Supreme Challenge (inc. Elite)	£9.90	£13.10
Computer Hits 5	£9.90	£13.10
Game Set & Match II	£9.90	£13.10
Space Ace	£10.50	£11.25

STRATEGY / SIMULATION

Football Manager II	£7.75	£11.25
Fball Man.II Expansion Kit	£6.25	£7.25
Football Director II		£14.75
Gunship	£11.25	£14.75
Ancient Battles	£11.25	
Micropose Soccer	£11.25	£14.75
Times of Lore	£7.75	£11.25
Chuck Yeagers Ad Trainer	£7.75	£11.25
3D Pool	£7.75	£11.25
Bards Tale	£2.75	£6.25
Question of Sport	£9.99	£14.75
Football Director (464)	£7.75	
Roy of the Rovers	£7.75	£11.25
KidsPlay	£2.99	
War in Middle Earth	£7.75	£11.25
Heroes of The Lance	£7.75	£15.90
Airborne Ranger	£11.25	£14.75
Trivial Pursuit (New Edition)	£11.25	£14.75
Emlyn Hughes Soccer	£7.75	£11.25
Track-Suit Manager	£7.75	£11.25
Laser Squad	£7.75	£11.25
4 Soccer Simulator	£7.75	£11.25
Archon Collection	£2.75	£6.25
Classic Games 4	£7.75	£11.25
Carrier Command	£Phone	

EDUCATIONAL

Answer Back Jnr	£7.95	£11.95
Factfile 500s	£3.75	£6.75
Fun School (Us, 5-8, 8-12)	£5.50	£7.95
Maxi Maths (Geometry)	£8.50	£13.95
The Three Bears (6128)		£15.95
Giant Killer (9-14)		£12.95
Magic Maths (4-8)	£8.50	£12.95
Maths Mania (8-12)	£8.50	£12.95
Chemistry GCSE	£11.90	£14.95
Physics GCSE	£11.90	£14.95
Biology 1 (12-16)	£8.50	£12.95
Wordhang	£7.50	£11.95
Happy Writing	£7.50	£11.95
Physics 1 12-16	£8.50	£13.95
Mapwork Geography Quiz	£8.50	£13.95
Spanish Tutor	£12.95	£15.95
French Mistress	£12.95	£15.95
German Master	£12.95	£15.95
lankey Crash Course (6128.PCW)	£19.90	
lankey Two Finger (6128.PCW)	£19.90	
Fun School 2 (U6's, 6-8, 8+)	£7.99	£9.99

ARCADE CASS DISC

Operation Wolf	£7.75	£11.25
All New Ghostbusters	£8.99	£12.25
Run The Gauntlet	£7.75	£11.25
Double Dragon	£7.75	£11.25
Vigilante	£7.75	£11.25
H.K.M.	£7.75	£11.25
Robocop	£7.75	£11.25
Skweek	£7.75	£11.25
Storm Lord	£7.75	£11.25
4 x 4 Off Road Racing	£7.75	£11.25
Dark Fusion	£7.75	£11.25
Super Scramble	£7.75	£11.25
Barbarian II	£7.75	£11.25
Forgotten Worlds	£7.75	£11.25
Red Heat	£7.75	£11.25
Crazy Cars II	£7.75	£11.25
1943 (Midway)	£7.75	£11.25
Afterburner	£7.75	£11.25
Navy Moves	£7.75	£11.25
Munsters	£7.75	£11.25
WEC Le Mans	£7.75	£11.25
Silkworm	£7.75	£11.25
Vindicators	£7.75	£11.25
Wanderer 3D	£7.75	£11.25
Purple Satin Day	£7.75	£11.25
Operation Neptune	£7.75	£11.25
Victory Road	£7.75	£11.25
Blasteroids	£7.75	£11.25
Batman (New)	£7.75	£11.25
Dragon Ninja	£7.75	£11.25
Superman	£7.75	£11.25
Chicago 30's	£7.75	£11.25
Inc. Shrinking Sphere	£7.75	£11.25
Butcher Hill	£7.75	£11.25
Titan (SPECIAL PRICE)	£6.99	£10.25
Renegade III	£7.75	£11.25
Spitting Image	£7.75	£11.25
Dynamic Duo	£7.75	£11.25

BUDGET CASS ONLY

Spy Hunter	£2.75
Battleships	£1.80
Quest / Golden Eggcup	£1.80
Split Personalities	£1.80
Frank Bruno Boxing	£1.80
Super Trolley	£1.80
Trantor	£2.75
Turbo Esprit	£1.80
BMX Simulator II	£2.75
Ghostbusters	£1.80
Academy	£2.75
Formula Grand Prix	£1.80
A.T.V. Simulator	£2.75
Peter Pack Rat	£1.80
Scuba Kidz	£1.80
Moto X Sim	£2.75
Ace II	£2.75
Bombjack	£1.80
Twin Turbo V8	£2.75
Shockway Rider	£2.75
B.M.X. Freestyle	£2.75
Roadrunner	£2.75
Kickstart II	£1.80
Rocky Horror Show	£1.80
Postman Pat	£1.80
Jockey Wilson Darts	£2.75
Grand Prix Sim 2	£2.75
Skateboard Kidz	£1.80
Treasure Island Dizzy	£2.75
Fast Food	£2.75
Adv. Pinball Sim	£2.75
Gauntlet II	£2.75
1942	£2.75
Blackbeard	£2.75

464 Upgrade Rom
Now available
ONLY £16.99 from us

Special prices on A.M.S. Software

StopPress	£39.95
StopPress & Mouse	£72.95
Mouse & Art	£61.95
Mouse Mats	£4.95
Max	£16.95
Extra Extra	£21.95

KDS Electronics Special Offers

Rombox	£24.95
5 1/2 Second Drive	£158.95
8 Bit Pr. Port	£18.75
Serial Int + Rom	£44.95
Printer T Switch	£24.95
Screen Master	£14.95
Ramdos (Disc)	£23.95
Ramdos (Rom)	£27.95

KDS Modems are no longer available

Mini Office II

Still our No1 Seller
Cass £11.25 Disc £14.75

Amsoft/Maxwell 3" Discs

One	£2.50
Five	£12.50
Ten	£24.95
5 1/2 Discs TEN	£3.90
3 1/2 Discs TEN	£9.50

Romantic Robot Quality Products at Discount Prices

Insider	£13.95
Multiface II +	£44.95
Rodos (on rom)	£25.95
Rodos extra	£8.75

All our prices include VAT + P&P.
Nothing extra to pay
In stock items sent by return of post. No minimum order

SPECIAL OFFER
ORDER ANY FIVE
£1.80 Budget games
and pay only £8.00

DMP 2000/2160/3000
Ribbons
£3.99 each
£6.99 for Two
£15.50 for Five

ACCESSORIES

Rombo Rombox	£34.95
464 Keyboard Ext Leads	£6.99
6128 Keyboard Ext Leads	£7.99
Cover Set 464 or 6128	£7.50
Cover Set DMP 2000/2160	£4.50
3" Drive Cleaner	£4.99
Cassette Player & Leads	£19.99
6128 Cassette Leads	£3.50
Lockable 3" Disc Boxes (60)	£9.99
3" Disc Cabinet (Holds 10)	£5.95

JOYSTICKS

Superboard	£18.95
Cheetah Starfighter	£13.95
Konix Navigator	£13.95
Gunshot	£5.75
Quickjoy II Turbo	£10.50
Cheetah 125+	£7.95
Supercharger	£12.95
Cheetah Challenger	£4.75
Konix Autofire	£11.95
Konix Speedking	£9.99
Cruiser (Microswitch)	£9.50

BUS/UTIL

Mastercalc 128	£27.95
Qualitas+	£12.99
Masterfile III	£32.95
Plan-It	£14.75
Professional Adv. Writer	£24.95
Tasspell	£13.95
Adv. Art Studio	£19.99
Protext	£20.95
Prospell	£20.95
Promerge	£20.95
Protext Filer	£22.95
Protext CPM (Spell & Merge)	£50.95
Tasword 6128	£20.95
Personal Banking System	£23.95
Protext (on Rom)	£32.50
Promerge+ (on Rom)	£29.95
Prospell (on Rom)	£29.95

HARDWARE ETC

2160 Printer	£159.95
DDI Disc Drive	£159.95
MP2 Modulator (Phone)	£29.95
FD1 Second Drive	£99.95
64K Memory Expansion	£47.95
Screen Filter	£19.99
Continuous Paper 2000	£16.50
C15 Cassettes	£45
Fanfold Labels (1000)	£5.90
CPM+ (disc) Phone	£18.95
CPC6128 Manual	£14.95
Printer Cable	£9.99

NEW LINES AT LOWEST PRICES

Atari ST Super Pack	£360.00
Amiga A500 Inc Mod.	£370.00
PCW8256 (Inc VAT)	£389.00
PCW8512 (Inc. VAT)	£499.00
PCW9512 (Inc VAT)	£510.00
PPCS12 (Inc VAT)	£449.00
PC1512 (Inc VAT)	from £449.00
PC1640 (Inc VAT)	from £550.00
PC2086 (Inc VAT)	from £675.00
Utah GRP, 3 fax (Inc VAT)	£999.00
DMP 4000 Printer	£375.00
DMP 3250 Printer	£220.95
LQ 3500 Printer	£375.00
Equon LX800 Printer	£299.00
Commodore PC 1	from £349.00
80 C Printer Muffler	£85.00

PCW Owners
write or phone for
new catalogue.
PC200 Software available.
Prices in this advert
are for Amstrad 464/6128

PLEASE NOTE OUR NEW ADDRESS

Due to the growth of our business we have had to move to much larger premises. Shop Open 9 till 6 Mon-Sat.
We cater for most computers. HUGE DISCOUNTS ON ALL PRODUCTS

K & M Computers (AA)
140, Sandy Lane Centre
Skelmersdale,
Lancs, WN8 8LH

24 Hrs Phone 0695 29046

50p Voucher sent with every order

When ordering please state make of computer.
Please make cheques & P.O. payable to K & M Computers.
Overseas inc. Eire add £1.00 per item of software.
We supply government & educational establishments.

Access orders by phone or Mail
N = New releases
Please Phone for availability
and other new releases



REACTION

You read the best – and the daftest – letters in AA!

Another month has come round – so soon? – and once again the ed rips open your latest missives on matters CPC.

We do receive far more letters than we can print each month, but rest assured that every single letter is read and its contents taken into account.

Remember too there's a £15 SOFTWARE VOUCHER for one lucky winner every month. So don't forget it or just let it pass. Write now to:

REACTION, AA, 4 QUEEN ST, BATH BA1 1EJ.

But please don't send SAEs or expect a personal reply to your letter, because we are just too busy with the next issue of AA!

Address all mail order and subscription enquiries to: *Special Offers, Amstrad Action, The Old Barn, Somerton, Somerset TA11 7PY.* We can only pass on your letters, changes of address and so on, to them. **Steve**

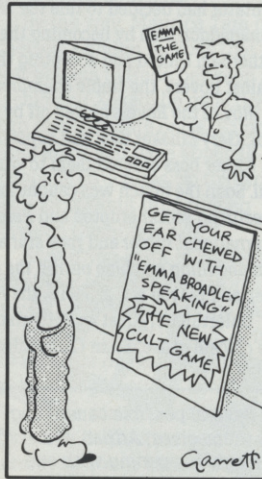

"IT'S GREAT – GIVES YOU A CHANCE TO SHOOT HER DOWN IN FLAMES..."

● **Broadley lets fly once again on p.14 – and features too in Sugarman overleaf!**

●Subscribe and protest

Your mail order pages promise a: "great AA £20 subscription vouchers offer."

Am I thick, or do I have to spend £200 over a year to get £20 in discounts?

Now I'm not mean, and although I don't have a lot of money I probably do spend £200 a year on soft/hardware, but I don't see much of an offer when a lot of mail-order houses can beat your prices anyway, vouchers or not.

I was going to subscribe, but as far as I, and a few friends, are concerned, there is no incentive! At least when there were free games or a joystick on offer you did feel you got something for your subscription.

Steve McClay, Wallasey, Merseyside

● Please, please, please tell me: what is the subscription rate for AA to Australia?

**Paul Petersen
Brisbane, Australia**

AA: To take Paul's enquiry first: the cost of a subscription down under – and indeed by surface mail anywhere outside Europe – is £23.50.

Ask at your bank for a sterling cheque made out to Future Publishing Ltd and send it off with the order form you'll find in the back pages of every issue to our Somerton address (it's in the PS above). We can quote for air-mail rates for Australia or wherever if you write to us, but the postal charge is so horrendous we aren't publish the price. (Jack Dekker, whose letter is up next, must be a real fan!)

Your letter is a bit more tricky, Steve, and I'm afraid what it comes down to is that we just can't please all the people all the time, however hard we try.

We certainly do like to give people something extra for making the commitment of subscribing. The free gift that we used to offer was never entirely satisfactory, since not every potential subscriber was enticed by the prospect of a game. Besides, we were making large orders for these games, and deals had often to be clinched long before games actually appeared. And as you all know, the finished product doesn't always arrive when promised!

The same is true of any free gift we might offer. Joystick? No thanks, I've got one. Mini Office II? Had it for two years already... and so on.

Hence the offer of a 10% discount, which should in theory be equally attractive to everyone.

And I must say, Steve, I'd challenge your assertion that our prices can always be beaten. To take a random example, I couldn't find anyone in last month's AA offering Stormlord any cheaper than we are – and when you send off your voucher you'll actually be getting it for under £9 on disk!

Finally, let's look at the actual price of a year's subscription to AA. Before the long overdue price rise a subscription was costing £16.50, which makes by my reckoning a mere 137.5p per copy, including post, packing and delivery to your doormat. Excellent value.

Now that AA costs £1.45, however, a subscription costs £17.95 – or less than 150p an issue. Don't tell the post office, but we're letting you have 19p worth of postage (not to mention packing) for just 5p! I would maintain that even without the extra 10% discount you get off any Mail Order purchases you may make during the year, at £17.95 there's never been a better

time to subscribe to AA. Turn to the back pages of this issue for further details.

●CPC dies down under?

When I received the May issue of AA here down under (cost a fair bit by airmail but it's worth it) and read your editorial about the five more years I nearly started to cry. When you write that the CPC has never had it so good that hurts us here: you see the Arnolds are just about finished here thanks to Alan Sugar taking the dealership from AWA and starting up as Amstrad Australia.

I am a member of the Southside Amstrad Users Group in Brisbane and when Amstrad took over early in the year and we saw the CPCs disappearing from the shops we started to wonder what was going on. Amstrad are only pushing the PCs and damn the people who made it possible for Amstrad to establish a base here in Australia. That the demand is

●Spellbrowned off

To: *The Masters Of AA*
Can the Oliver Twins spell? The reason I ask is because in a lot of their games there are spelling mistakes. This makes them look sloppy and not very professional, which the Olivers are supposed to be.

For instance, *Infra red detonator* and *Snorkle* in *Dizzy 2*. There are a number of others in *Dizzy 1*. Do I consult my Greek dictionary for the English equivalent? Perhaps these are meant to say *Infra red detonator* and *Snorkel*?

From: *The Revealer, Goole*

AA: We have to be careful how we answer this one, O Revealer, since we ourselves are occasionally guilty of the odd mistake or two in the spelling department. But we agree that these little things do detract from games.

This very morning we received a copy of *Storm Warrior* from *Elite* which proclaimed on the cover that it was "from the author's (sic) of *Forgotten Worlds*." Doesn't really inspire confidence, does it?

not so strong as it used to be is quite normal: if you don't advertise and there is no software on the shelves then don't expect to sell your product.

Our club has about 150 members, there are another four clubs here in Brisbane alone and there are many more clubs all over Australia so it is not a case that the CPC is not supported by Arnold fans.

Last week I went all over town and phoned all over the place trying to buy a program (*At Last Plus*) but no luck: all that was available were some dusty old games.

So Steve maybe you understand why we are drooling when we read all the ads in AA, maybe one day I might migrate to the old country (when you do something about the weather!).

Well that is it for now, keep the good work up with AA so that will keep us going and informed about Arnold (don't tell us about Sugar, we are not interested!). Thanks for reading the letter.

Jack Dekker, Alberton, Australia

PS I don't think my next computer will be an Amstrad. I don't like firms who don't support their product.

AA: This is nothing less than a disgrace, Jack, and I can quite understand why you should be so angry about it. Still, we'd be kidding ourselves if we really expected anything different, wouldn't we?

● A turkey never forgets

I've got some turkeys on cassette like *Sultan's Maze* and *Water Grand Prix* but they won't load. When I try, about half way through, it just says, "Memory full," and it's deterring me from buying better games. Is it just the games or can I do something about it?

**Adrian James
Deeside, Clwyd**

● Leave us alone, will you, just leave us alone!

(Last month we were daft enough to offer £10 to the person who sent in the most game-intensive football report. Can you stop now please?)

The football director of Rovers had just sacked Brian Clough because of his football fortunes and instead installed Kenny Dalglish as soccer manager. It was the matchday. Emyln Hughes, the international soccer commentator had decided to rule the world by becoming the Armageddon Man by becoming the track suit manager of Rotherham United and accepting the league challenge against Rovers, the treble champions.

Roxy of the Rovers kicked off by savaging the hot-shot, Gary Lineker who had superskills. This is because his soccer boss ordered them to win by fair means or foul. Soon the match was caught in a catch 22 when streetgang soccer erupted and Peter Beardsley, the international soccer and rock star also known as the human killing machine outrun the gauntlet into the deep and played a 1, 2, 3 with the Robocop.

Unfortunately, just as Rotherham were about to stop the chickin chase, Brian Clough decides to take rigel's

revenge on the football manager and landed his starglider and embarked on a course at star wars giving a command performance with the help of the in crowd and the arcade muscle of the Aliens. Emyln Hughes declared Operation Wolf and decided to repel the vindicators with the help of Jack the Ripper.

There was a revolution in the national stadium which lasted until nearly everybody was killed until dead. The game was over and the footballer of the year was the sole survivor. He had survived because he had been through a rigorous combat school which taught him army moves and that every second counts. The stormlord had survived the 720' firetrap.

**Matthew Cooper
Leatherhead, Surrey**

AA: I suppose we've only got ourselves to blame, Matt, but suddenly I feel very, very tired. Excuse me if I just go and lie down in a darkened room for a while...



AA: Several possible causes suggest themselves, Adrian. If it were only happening with one game I'd suggest that it was caused by a loading error or the program not reserving enough buffer space. If it's the latter you could always do a `openout "d":memory 800:close-out` before running the game. But since it appears to be happening to lots of your games, the cause could be at your end. Do you have external ROMs connected, by any chance? Try unplugging 'em.

Why not get in touch with one of the Help Liners? Matthew Cawley lives in your neck of the woods - at 42 Hamilton Av, Sandycroft, Deeside, Clwyd, CH5 2PB, to be precise.

● Time for a moan

After three years of buying *Amstrad Action*, I think it's time to have a moan. Your magazine is better than the rest, because you don't bore people to death, except for boring bits like serious stuff, ie.

if you connect this bit to this bit you make your Arnold into a microwave.

Please print something everyone can understand, like adding speakers to your sound thingy. I am a computer trainee, so I am not totally brain dead, but I bet a lot of people cannot be bothered to fiddle with long jobs. (I can't). Also, talking about long jobs, how about making *Type Ins* smaller? You must receive smaller ones.

Cheat Mode is probably the thing that sells AA, also reviews, so why don't you make your Cheat Mode bigger? Recently it's got a lot smaller. Also, if you get a poke for a game, why don't you print both tape and disk? It would make a lot of people happy.

Also, if all magazine are going up, does this mean fewer trees are being chopped down for the paper? If not, is someone making a packet? Like British Telecom (I think) they make a hell of a profit £200,000,000, but they still put up the bill!

Sorry for moaning, maybe it's

because I am going to the dentist?
Mark Watson, Dewsbury, West Yorkshire

AA: If only our readers agreed on what sells AA! You reckon it's Cheat Mode and *Type Ins*, Mark, but we get just as many letters asking us to scrap them as we do asking us to expand them. I can only conclude that in a magazine with so many different kinds of reader - and thank heavens for that, I say! - all we can hope to do is satisfy as many of you as possible at one time. On the other hand, I do appreciate your letters, because if it's only a certain kind of reader writing in - asking us to drop Action Test, say - then I'd have to start paying attention...

Hope your visit to the dentist wasn't too painful an experience!

● Model question

I'm taking a GCSE electronics course and I need to design circuit boards and test them while they are being designed on the computer. Do you know of any programs for the Amstrad (+ disk drive) that would suit me? I also need to design the shapes or the containers which the boards will go into. So what I need is a program that will allow me to create drawings in 2D, and then let the computer turn them into 3D images which I will be able to rotate and finally dump to a printer. Any ideas?

Andrew Manning, Manchester

AA: Try Arnor's £20 Model Universe (☎ 0733 68909) - let us know what you think, Andrew.

● A real classic

When was *Starglider* reviewed? What did it get?

J.Gordon, Blackheath, London

AA: The excellent space game got the AA treatment in issue 17 and was quite deservedly Mastergame.

Even now ex-ed Bob Wade, who's a bit of a classic himself, still enjoys the odd game of *Starglider* - when he's not too busy counting his money, that is.



● *Starglider* - a real blast from the past!

● Elite – the fan club starts here?

We've had a veritable storm of letters in reply to 'Dangerous' Mark Gibson's plea for help in last month's AA. Mark, you may recall, found himself stuck on Coriolis space station without fuel and apparently with no prospect of acquiring any.

We haven't room to print all of your solutions, offers of assistance and *Elite* anecdotes, but here's a selection. (It seems to me we should start up some kind of *Elite* fan club for all you dangerous, deadly and *Elite* commanders! Send your name and 'phone number and we'll see if we get enough to make it worthwhile.)

The simple solution to Mark's problem seems to go something like this:

What he has is a mission: you get four of them, one after the other, when you get enough "kills." It doesn't matter, apparently, which planet you Hyperspace to. You get the same thing happening to you.

What you must do is get the

most recently saved file and make sure you try an Intergalactic Hyperspace (from a planet with a tech level of 11 or higher) and don't use it until you get the sun going

When you arrive at the space station you will find that you lose all your fuel (as you said), what you have to do is this:

- 1 Dock with the space station.
- 2 When you receive the message from the station "The sun is going to nova, will you help us?", type 'y' for yes.
- 3 Now look at your cargo hold, and you should see that you are now carrying refugees.
- 4 Exit from the space station and as quickly as possible use your Galactic Hyperspace, as it requires no fuel!
- 5 When you arrive in the next galaxy dock with the space station which you are near.
- 6 When at the space station press key '3' as though you were going to sell some cargo.
- 7 You will now have released the

refugees, and they should pay you a reward for your trouble. You have now completed your first mission!

That comes from **Andrew Manning of Manchester** (thanks too to **Bruce Sanchez**).

By the way, **Maurice Tam of Chelsea, London** reckons that the best planets to trade between are Laenin and Xexedi on galactic map one. They are only 0.8 light years apart and have opposite economic structures, so that you get a lot of profit from trading between them.

Also, if you want to get into what space that's slanted or hyped space, then pause the game and press F. Doing it again gets you out. You do have to type space after pressing F as well.

A more complex solution is offered by **D. Woofindin of Barnley in South Yorkshire**. Once in Solaega's airspace, proceed towards the sun to regain lost fuel.

Find the nearest planet to

your local chart and press ' ' to ensure that planet is in your hyperspace system.

Now, with overflowing fuel tanks make your way to the space station blasting every ship in your path. Then dock and continue as before, carrying off the refugees.

John Girvin of Belfast in Northern Ireland writes that he was given this mission first when he was only "above average." He's now made *Elite* status three times, but keeps losing the games files!

That charming chappie **Adrian Forbes** writes that he has the poke we published in AA20, as well as the instant hyperspace addition, on disk.

If you write to him, sending an SAE and a disk he'll give you a copy free of charge with same day delivery. Can't say fairer than that mate to **Adrian Forbes, 37 Victoria Rd, Gourcock, Scotland PA19 1DF** and say Steve sent you.

Entries to the *Elite Club* at the usual address, folks...

Sugarman

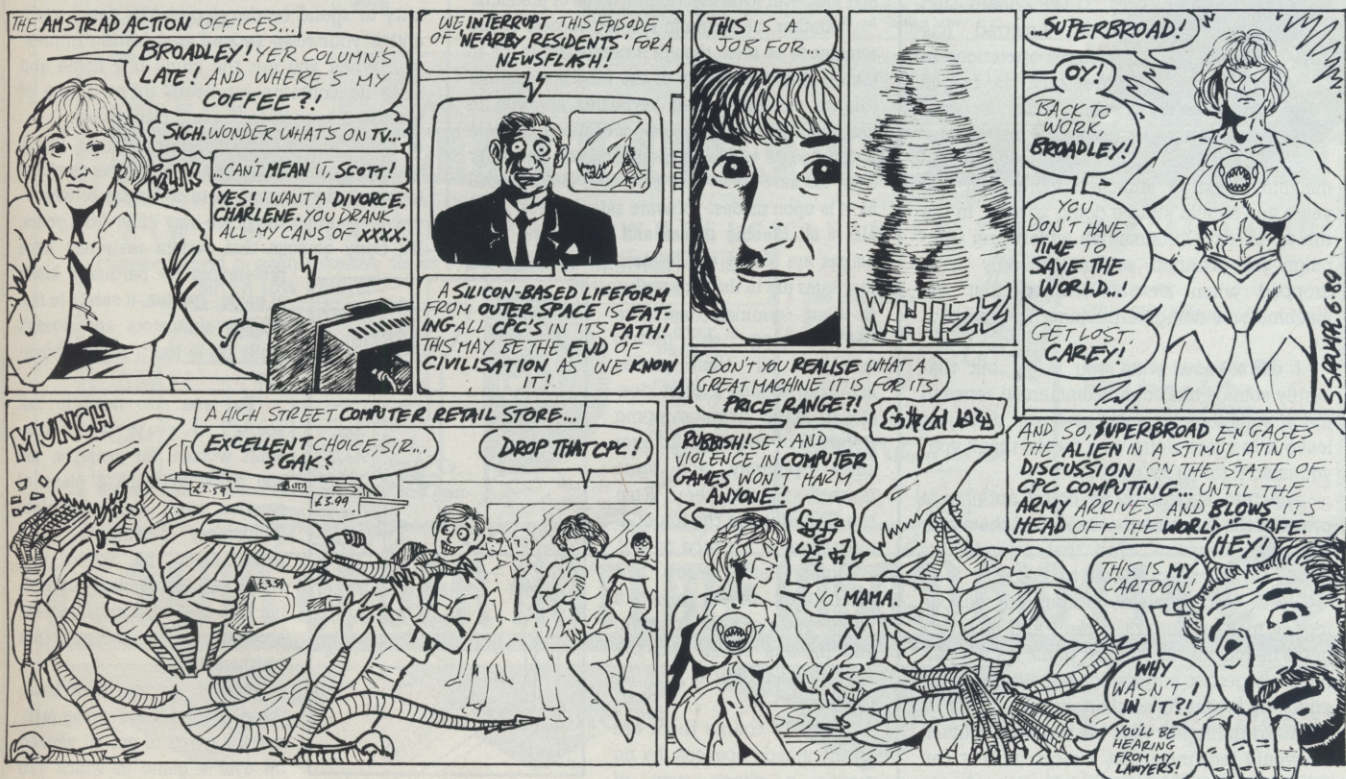

BROADLEY SPEAKING

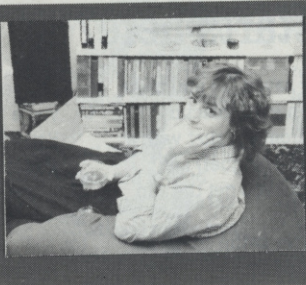

As outrageous and bizarre as it's possible to get without being sued.

**We hope.
EMMA BROADLEY dons combat gear for another assault.**

I'm not a happy woman. No indeed, not happy at all. It's all to do with this latest Spectrum sales promotion Amstrad have launched.

Now I'm not complaining about the fact that the Spectrum is getting a big boost up the bundle - though my own opinion is that the punters could do themselves a favour and opt for the CPC instead.

What gets my goat, dear reader, is that in their infinite wisdom Amstrad have left the CPC to its own devices. No special bundle and no advertising campaign in the autumn.

I've heard too that Amstrad has ceased operations in Australia as far as the CPC is concerned.

It's all the more remarkable, then, that the machine Amstrad launched more than five years ago should still be doing so well. In the run-up to last Christmas an advertising campaign was planned, so I'm told, only to be dropped when it was realised that the machine was doing surprisingly well without it!

I don't know what you think, but that hardly sounds like sound commercial sense to me. If something is doing well you don't just leave it to coast along very nicely, thank you: you push it for all it's worth.

Amstrad appear to be doing nothing to promote the machine that launched them as a computer company. With that attitude, it's hardly surprising profits are tumbling.

We're the people who first put serious money in Alan Sugar's pocket, and now he's got it he has lost all interest in us. It's not perhaps altogether surprising, but what's really annoying is that it's so shortsighted.

You'd think that with his business acumen he would recognise that a machine that can keep selling in such huge quantities for so long must have something going for it.

The biggest expenses in the business of creating and flogging a computer, I'd have thought, are in the development and tooling-up stages. Once it's up and running these costs must surely drop to almost nothing.

Always eager to be of assistance, I hereby offer Amstrad this simple three point plan. If they follow it, I'm certain they will then be able to watch the CPC's profits soar:

- 1) cut prices officially: take £100 off the 6128;
- 2) advertise heavily;
- 3) and last but not least, *get the firmware manual back into print immediately!*

I'm no technical bod myself, but it does seem absolutely insane to me that the information so vital to serious CPC owners should be unobtainable. In fact, it's stupid.

● Still, at least we are getting the *Magnum Virgin/Mastertronic* lightgun, which is something. Be grateful for small Murphies, as the man said. I must be honest and admit that I haven't seen it yet - Steve tells me it has arrived (*yes: review on page 42 - ed.*).

It may be too little too late, of course, but it's better than nothing at all. In fact it's the best news we've had since Dattel burst onto the scene and took over RAM Electronics' range of products.

Whether the *Magnum* is a big success or not remains to be seen, though it seems odd to me to launch it in the middle of the long hot summer (fingers crossed!), when keyboards are said to gather dust and games collections remain untouched for weeks on end. (Mind you, I've never been too sure about that particular cliché, based as it is upon modest software sales figures. After all, if all the big games and advertising campaigns are aimed at Christmas, is it surprising that sales dip in the summer?)

● That reminds me, I've been trying to decide whether all this games licensing is such a good idea. Ocean have been shipping *Robocop* by the skipload ever since Epiphany, and more recently there's been *Run the Gauntlet* and the impending arrival of *Licence to Kill*, *Postman Pat*, *Gilbert the Alien* (he's taken rather a while getting here, though) and *Indiana Jones and the Last Crusade* (bet it isn't, by the way!).

Then of course there are all the arcade licences, by no means a cheap way of acquiring a title and concept

for your latest project.

On the one hand it's undoubtedly fun to find yourself involved in your celluloid hero's adventures - and I'll accompany Harrison Ford, sorry Indiana Jones, on any adventure. If you've seen the latest James Bond you'll actually have a better idea of what's expected from you in the game, and I dare say the same will be true of *Indy*, though it hasn't got around to my local Odeon yet.

On the other hand, isn't it true that vast amounts of money are spent on acquiring the licences in the first place? I know the rights to *Robocop* were acquired before the "property," as these people rather unpleasantly refer to films in the making, was anything more than a script. But apparently a top film licence could cost in the hundreds of thousands.

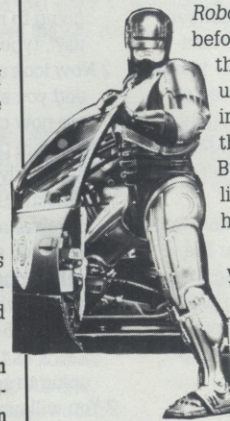

And when you're spending that kind of money you can't afford to leave a game's success to chance. Oh dear me no, there's advertising, point of sales promotion and 101

other things neither you nor I ever think of when we part with a brownie and a bluey for the latest blockbuster in Smiths, Menzies or Boots.

So it isn't surprising if sometimes there isn't more than about thrupence left in the kitty to spend on developing the game itself, and if your first, second and lasting impression when you get the shiny box home and slide its contents into your drive is one of intense disappointment and bitterness.

● There is a solution, though. At least, in my opinion it's a solution. Read the reviews carefully. Of course the personal taste of Trenton or whoever is evaluating the game may differ from yours. It's fairly obvious that certain reviewers have

preferences for particular kinds of game: Trenton, it seems to me, favours simulators and doesn't really go in much for shoot-'em-ups.

But you also need to ask yourself if you're a sensible, adult woman, for example, are you going to reach a plane of emotion much above complete indifference playing a game based upon the notion that you're a violent vigilante upholding the law blasting hundreds upon hundreds of bad guys into smithereens?

And if, on the other hand, you're a 14 year old young man, are you going to get all worked up over a game in which you attempt to save the osprey? ●

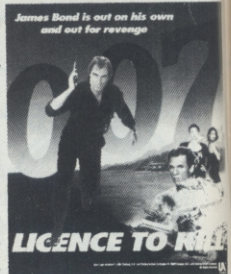

"BUT I ONLY SAID I DISAGREED WITH YOU"

Compumart

A Great Deal More
For a Good
Deal Less!

-Free-
FAST
DELIVERY

Amsoft
3" CF2 DISKS



Don't risk losing
your valuable data

- ▶ Genuine Amsoft
- ▶ Guaranteed Quality and Reliability
- ▶ Buy from the UK's largest supplier

BOX OF FIVE Only **£10.39** Ex.VAT

BOX OF TEN Only **£19.99** Ex.VAT

AMSCASE

FROM
AMSTRAD

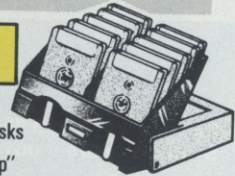

- ▶ Holds 10 uncased 3" Disks
- ▶ Unique "pop-up" feature to display your disks
- ▶ High quality, neat compact design

Only **£5.90** EX.VAT

PCW SOFTWARE

Only Compumart offers you LOW PRICES on these excellent software packages, AND we will give you an AMSCASE 3" disk storage box (worth almost £7!) FREE with every software package you buy! Why not phone and ask about other great deals on a huge range of Software.

WORDPROCESSORS

PROTEXT £46.90
ARNDR
Excellent features including powerful spellchecker and mailmerge.
LOCOSCRIPT 2 £19.90
LOCOMOTIVE SOFTWARE
Many improvements on the original

DATABASES

LOCOFILE £23.90
LOCOMOTIVE SOFTWARE
Flexible, very easy to use. Also works with Locomail.
MASTERFILE 8000 £39.90
CAMPBELL SYSTEMS
Very flexible, fast and easy to use.

SPREADSHEETS

CRACKER TURBO £39.90
PAPERBACK SOFTWARE
Very powerful for complex calculations. Easy to use graph/chart production.

SUPERCALC 2 £53.90
AMSOFT
Very popular, excellent manual. Host of useful features.

ACCOUNTS PACKAGES

DIGITA BUSINESS CONTROLLER £54.90
DIGITA INTERNATIONAL
Easy to use for small business, not VAT registered, Excellent manual.

SAGE POPULAR ACCOUNTS £79.90
SAGESOFT
Excellent integrated package. Very popular, easy to set up.

DESK TOP PUBLISHING

NEWSDESK INTERNATIONAL £39.90
ELECTRIC STUDIO
Powerful graphics and font editor. Excellent features.

STOP PRESS £39.90
DATABASE SOFTWARE
Superb graphics. Easy to use. Well designed with good fonts.

THE DESKTOP PUBLISHER £22.90
DATABASE SOFTWARE
Good range of graphics and fonts. Clear layout. Excellent value.

GRAPHICS PACKAGES

MASTER PAINT £16.90
DATABASE SOFTWARE
Wide range of facilities. Excellent zoom function and effects.

THE DESKTOP PUBLISHER £22.90
Not only for DTP, this package has excellent graphics abilities in its own right.

GAMES SOFTWARE

THE PAWN £19.90
RAINBIRD
Intriguing adventure. Great graphics.

COLOSSUS CHESS 4.0 £12.90
CDS SOFTWARE
Powerful, packed with features.

GENERAL

MINI OFFICE PROFESSIONAL £23.90
DATABASE SOFTWARE
Database, Word Processor, Graphics, Communications and Spreadsheet. All in one value package.

MISCELLANEOUS

PRINTER RIBBONS

Genuine Amstrad or quality compatible ribbons at
SUPER LOW PRICES!

	GENUINE AMSTRAD		QUALITY COMPATIBLE	
	FABRIC	CARBON	FABRIC	CARBON
PCW 8 SERIES	£4.25	£4.60	£2.90	£3.50
PCW 9 SERIES		BLACK £2.95		MULTISTRIKE £2.40
		BLUE £3.95		
		BROWN £3.95		

Minimum Order - 2 ribbons unless ordered with other items.
Prices are per ribbon and ex. VAT.

PRINTWHEELS

GENUINE AMSTRAD PCW 9512 PRINTWHEELS



LETTER GOTHIC
MINI GOTHIC 15
THESIS PS
RECTA 10
ORATOR 10
SCRIPT 12
COURIER 10
PRESTIGE 12
PRESTIGE PICA 10

£5.90 EA EX.VAT

CLEANING KITS

CLEARHEAD (3" Drives)
▶ Safer data storage
▶ Easy to use
▶ Prolongs disk and drive life

£5.90

CLEANPRINT (PCW Printers)
▶ Removes ink deposits
▶ Maintains print quality
▶ Protects and lubricates print head

8 SERIES **£5.90** 9 SERIES **£5.20**

MISCELLANEOUS

LISTING PAPER
2000 sheets,
11" x 9 1/2" 60gsm, **£13.00**

DUST COVERS
High quality transparent PVC
PCW 8 Series - 2 Piece **£7.80**
- 3 Piece **£8.60**
PCW 9 Series - 2 Piece **£7.80**

SCREEN FILTERS
PCW 8/9 Series **£14.95**
CPC Mono/Colour **£10.39**

24HR ORDER HOTLINE (0509) 610444



Superb Service

Great Guarantees

Better Back-up

Compumart

A Great Deal More, For a Good Deal Less

COMPUMART LTD
FREEPOST (AMA)
LOUGHBOROUGH
LEICS LE11 0BR
TEL: 0509 610444
FAX: 0509 610235

- ▶ Usually same day despatch on most items
- ▶ FREE, next working day delivery on all hardware, allow 2-5 days for other items
- ▶ Large stocks for immediate despatch
- ▶ FAST, efficient service

- ▶ If any item proves to have a manufacturing fault within 30 days we will replace free of charge or refund in full
- ▶ After 30 days and within the warranty period, we will repair at our expense

- ▶ Friendly advice and after sales support
- ▶ Any problems quickly resolved to your complete satisfaction
- ▶ Special offers to existing customers. We aim to please... and usually do!

All prices exclusive of VAT

Prices/delivery subject to availability and only applicable to UK mainland, N. Ireland and BFPO's. E&OE
Compumart are licensed credit brokers. Simply ask for written details.

Open the box!

So you can't write Machine Code. Suddenly that's not the barrier it used to be: PAT McDONALD takes the wraps off a new package.

PANDORA

£24.95 tape • £29.95 disk
Swift Software ☎ 061 456 0926

Bored with Basic, you sit there, drumming your fingers on the desk and wishing the programs you've spent half a lifetime perfecting didn't take the other half to run.

Very sad. There must be many with this problem of programs that just don't get a look in because they're in Basic. "You could always write in machine code," some clever dick says. "Ha!" you reply: "I'm not a megagalactic Skol drinking alien. And even if I was then I *still* probably couldn't understand assembly language."

What would be really good is if you could take all your Basic games and convert them to machine code without messing about re-writing them. It probably wouldn't be that easy, but there's got to be a better way than pure binary gibberish...

Enter the dragon

Pandora is a compiled version of Basic designed to take the sweat out

of programming.

To write a program using it you first type out the relevant code into an Ascii word processor (*Brunword* - late version - and *Protex* are fine, *Tasword* isn't). If you don't have a suitable word processor, Swift have thoughtfully included a small program that stores the data as Ascii.

The *Pandora* Basic language is not the standard Locomotive variety built into the CPCs. Instead it's a sawn-off version lacking in certain areas (such as string and text handling) and built up in sprite graphics handling.

Sprites, of course, are an integral to almost every computer game, but as the manual says, you can ignore them if you all you want is a faster version of Basic.

The sprite handling is of a reasonable standard, though, and certainly offers exciting possibilities to the games writer.

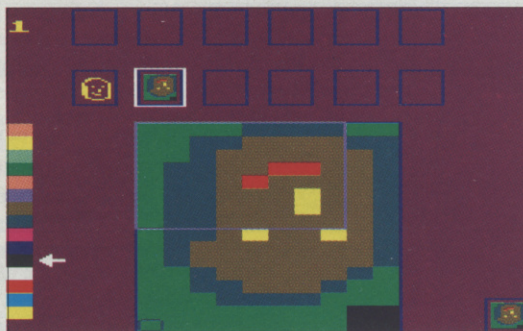

• All sprites are edited on this grid

How it works

What makes compiled programs faster than ordinary interpreted ones? One of the main reasons is that all of the jumps to the various routines are precalculated.

Take the command GOTO 1000. A compiled program already knows exactly where line 1000 is, and can go there straight away.

An interpreted program has to sit down and calculate where to go. An immense waster of time is a looping routine.

If the program has to work out where to go each time, time is wasted unnecessarily. Compiled programs don't have that problem.

Pandora has a memory map that starts at £3000. Thus you can utilize from £0200 to £2FFF for your own purposes - data, perhaps, or a Basic program.

The compiled program can be 8K long, a fair but not overly generous allowance. You can however always use overlays - sub-programs loaded individually if a program is too big to fit in memory complete.

Screen output streams are all disallowed - so no text windows. In fact, in version 1.00 text handling is a little primitive, relying on printing characters one at a time, though increased speed partially makes up for this.

If, as intended, Swift release an updated version of *Pandora* able to run independent machine code routines - possibly stored in memory below the compiled program - this product can be transformed.

A routine that needs speed, such as a new longer lasting graphic FRAME command (see *The Look*, AA41) could be added without fuss.

Extra text, disk and sound handling could be added too. Perhaps a user club may be born to keep track of all the different patches, tweaks and short cuts, as happened with Incentive's *Graphic Adventure Creator*.

You can have up to 32 sprites driven along independent courses at the same time. 48 different frames can be held in memory at once, and different banks of sprites can be loaded when required.

One drawback is that sprites can't overlap very well - onscreen flicker is quite horrendous when this happens - and they also can't go in front of any background graphics. Still, it's early days yet, with this being only version 1.00...

Arcade action

When you have your Ascii file you must run it through the compiler program. This goes through the code looking for errors, and if it doesn't find any it turns all the Basic commands into a machine code file that can be run independently of *Pandora*.

Although not as fast as 'the real McCoy', a compiled Basic effort is faster to write in order to get programs finished quickly.

So what sort of program could you write with it? Well, nearly anything is the disap-

```

PANDORA BASIC V1.00
*****
* Attack of the Mutant Buggies *
*****

ren Note the use of subroutines to force RND to return values within
ren desired limits.

mode 0:ink 0,0;border 0:5:0

if setup
  call rnd%:ypos s:1:call rnd%:ypos s:y:call rnd%:vdtr s:d:call rnd%:DIR
  sdir s:d:call rnd%:animate s:0,6,7,2:speed s,s:box s,2,72,0,140
  on s:55%:if s:0:goto setup:endif:max 90

loop
  drive:inkey 86,1:if 1:1ink 1,28:mode 2:endif:goto loop
rndX
  rnd x:if x:70:goto rnd%:endif:if x:3:goto rnd%:endif:return
rndY
  rnd y:if y:120:goto rnd%:endif:if y:40:goto rnd%:endif:return
rndDIR
  rnd d:if d:2:goto rnd%:endif:d:4-1:if d:0:goto rnd%:endif:return
rndFRAME
  rnd f:if f:5:goto rnd%:endif:return
ifop
  
```

• Entering programs is a cinch with a word processor

NOW THE FIRST EVER UTILITY TO TRANSFER "GO!" LOADERS TO DISC

This type of loader has previously been considered impossible to transfer to disc with an automatic utility but now we have developed a

**** FULLY AUTOMATIC PROGRAM ****

to transfer the game and loading screen with a massive saving in disc space used, due to compressing not only the screen but also the game code.

Among those tested are:- 720 DEGREES, ATF, HEROES OF THE LANCE (main file & screen), INDIANA JONES (Main file & screen), TRANTOR (main file & screen), BLACK BEARD, COLOSSEUM, WIZARD WARZ (main file), SIDE ARMS, CHICAGO 30's, RAMPARTS, LAZER TAG, ECHELON (main file), JACKAL, SOLOMONS KEY and HERCULES (main file).

** This utility is written to only work in a CPC6128. It will not work in a CPC464 or CPC664 even with memory expansion unless fitted with a 6128 ROM as it uses direct ROM addresses. However, the transferred game will run on your 464/664.

With Indiana Jones, Trantor, Heroes of the Lance, Hercules, Wizard Warz and Echelon we supply details of how to complete the transfer of the remaining game code.

Added Utility To Dump Any Screen Saved With Goldtrans To Four Different Types of Printers

GOLDTRANS" PRICES: UK - £15.00 EUROPE - £16.25 REST OF WORLD - £17.00

! SPEEDTRANS PLUS - NOW EVEN FURTHER AHEAD OF ITS RIVALS! SPEEDTRANS PLUS - 3

For CPC6128 (or 464/664 with DK Tronics 64K (or larger) Memory)

Once the program has been transferred to disc it will run on your 464/664

Fully automatic - Just One Keypress * Only One Program To Run Which Finds The Speedlock Type Automatically * Transfers Many Original And Today's Speedlock Programs * No Meddling - Written With The Amateur In Mind * Automatic Disc Filenames * No Wasted Disc Space - Saves The Correct Amount Of Game Code * Saves 99% Of Opening Screens * Screens Saved In Their Correct Colours * Compresses Screen Code To Save Even More Disc Space * A Normal Data Format Disk Will Hold Six Standard Games. * Faster Loading Times From Disc Because Of Shorter File Lengths *

SPEEDTRANS handles all Speedlock types **Automatically**. No need to hold a key down at anytime during loading. **SPEEDTRANS** has only one program to run - no time wasting running several alternatives making transfers that do not work. **SPEEDTRANS** makes all transfers direct to your destination disc - does not need the **SPEEDTRANS** disc whilst working. **SPEEDTRANS** transfers more Speedlock protected programs to disc than any of its competitors. It also transfers ALL the speedlock protected programs we say it will - we make no unsubstantiated claims.

SPEEDTRANS transfers over 200 programs to Disc, some of the latest it will do are MADBALLS, FREDDY HARDEST (both games) BASKET MASTER, MATCHDAY II, PHANTOM CLUB, GRYZOR (main program) OUT RUN (main prog) SUPER HANG ON, ATV SIMULATOR, R TYPE, REVOLUTION (Including screen) in only 43K, SUPERHERO in only 48K and Wizzball in only 55K compared with 61K when transferred with another Speedlock utility.

SPEEDTRANS is the only utility that will transfer Mutants 64K. **SPEEDTRANS** is the only utility that will transfer Revolution automatically without meddling.

Added Utility To Dump Any Screen Saved With Speedtrans To Four Different Types of Printers.

SPEEDTRANS will transfer many other titles - some better known ones are:

All Titles From Konami's Coin-Op. Hits From Konami Arcade Collection: Nemesis - Jackal - Jailbreak

Summer Gold By US Gold: Dambusters - Beach Head II - 10th Frame - Bruce Lee - Impossible Mission. From They Sold A Million: Sabrewulf - Beach Head - Jet Set Willy - Daley Thompsons Decathlon. From They Sold A Million 3: Fighter Pilot - Ghostbusters - Daley Thompsons Decathlon

3D Starfighter, Ace Of Aces (Main Program), Acrojet, Advanced Pinball, Alien Highway, Arkanoïd, Arkanoïd 2, Revenge Of Doh (Main Program), Armageddon Man, Army Moves (1 & 2), ATV Simulator, Brain Clough's Fortunes, Barry McGuigans Boxing, Basket Master, Batman, Beach Head, Beach Head II, Black Magic-Both Parts, BMX Simulator, Bounty Bob, Bounty Bob Strikes Back, Brain Ache, Breakthru, Bruce Lee, Catch 23, Crystal Castles, Cluedo, Cobra (Stallone), Combat School, Copout, Cosmic Shock, Daley Thompsons Decathlon, Daley Thompsons Olympic Challenge (Main Program), Daley Thompsons Super Test, Dambusters, Dan Dare 2,

Desert Fox, Dizzy, Donkey Kong, Elektra Glide, Express Raider, Eye Spy, F15 Strike Eagle, Fighter Pilot, Football (Codemasters), Frankie Goes Hollywood, Freddy Hardest, Fruit Machine Simulator (Main Program), Galactic Games (Main Program), Galvan, Game Over (Both Parts), Ghostbusters, Goonies, Grand Prix Simulator, Green Beret, Gryzor (Main Program), Gunfight, Gyroscope, Hacker, Head Over Heels, Highlander, Highway Encounter, Hunchback II, Hypersports (Main Program), I Spy, Impossible Mission, Its A Knockout, Jackal (Compilation Ver), Jailbreak (Compilation Version), Jet Bike Simulator (Main Program), Jet Set Willy, Juggernaut, Killed Until Dead (Main

Program), Knight Games (Main Program), Knight Rider, Konami Golf, Kong Strikes Back, Kung Fu Master, Leaderboard, Leaderboard Tournament, Leaderboard Worldclass, Legend Of Kage, Leviathan (Main Program), Madballs, Mag Max, Mario Brothers, Match Point, Matchday, Matchday II, Metrocross, Miami Vice (Ocean), Mikie, Minder, Mindshadow, Mission Jupiter, Monopoly, Nemesis The Warlock, Never Ending Story (Main Program), Nigel Mansells Grand Prix (Main Program), Nomad, Out Of This World (Main Program), Outrun (Main Program), Phantom Club, Ping Pong, Platoon, Pro Ski Simulator, Pulsator, Race Against Time, Raid, Rambo First Blood II, Renegade (Imagine) (Main

Program), Rescue On Fractalus, Return To Oz, Revolution, Road Runner (Main Program), Rocco, Sabre Wulf (Later Version), Samantha Fox Poker, Saracen, Scalextric, Scrabble, Shadow Skimmer, Shao-lins Road, Short Circuit, Silent Service, Slain, Slapfight, Space Shuttle, Spy Trek, Street Hawk, Super Cycle (Main Program), Super Hang On, Super Hero, Super Stunt Man, Tenth Frame, Terrormolinos, The Great Escape, The Race Against Time, The Way Exploding Fist, Topgun, Transmuter, Tubaruba, Uchimata, V, Vampire, Vixen, Warlock, Winter Games, World Games (Main Program), World Series Baseball, Xarq, Xevious, Yie Ar Kung Fu, Zoids (Martech), Zorro and many more.

SPEEDTRANS is, without doubt, the best Speedlock transfer utility on the market today and is capable of transferring more Speedlock games to disc than any of its competitors.

TRY IT AND SEE FOR YOURSELF UK £15.00 -- Europe £16.25 -- Rest Of The World £17.00 Upgrade your Speedtrans Disc - send your disc together with UK £3.00 - Europe £4.25 - Rest Of The World £5.00 Upgrade your Speedtrans Tape send your tape together with UK £12.00 - Europe £13.25 - Rest Of The World £14.00

DMP 2000/2160 PRINTERS

The printer buffer presently in the DMP 2000 series is a 2K RAM. Most of this RAM is used by the printer's operating system leaving an average 1/2K as buffer space. Our upgrade kit contains a new static RAM chip which will increase the printer buffer by 6K (about 4 pages of text). This upgrade allows all Download Characters to be re-defined allowing the user to design special characters for use with scientific and other programs. The kit is supplied with full pictorial instructions to allow the amateur to carry out his own modification (the DMP2160 takes about 7 minutes). If you don't think you are up to it your local TV shop can do the job in approximately 15 minutes

UK £14.50 - EUROPE £15.75 - R. of W. £16.50

COMPACTOR

COMPACTOR will allow you to load a standard 17K screen, set the mode, border and ink colours and then save it as a compressed screen containing its own mode and ink colour information. Most screens compact down to an average of 9K which is an enormous saving on disc space. Loading time of compressed screens is also proportionately reduced.

TAPE:- UK £5.00 - EUROPE £6.25 R. of W. £7.00
DISC:- UK £8.50 - EUROPE £9.75 - R. of W. £10.50

UTILITIES DISC NO. 1

This utility disc contains 5 programs, all menu driven. They are SAMSON, TRANSIT, QCLONE, VIEWTEXT and the fast disc FORMATTER.

DISC:- UK £15.50 - EUROPE £16.75 - R. of W. £17.50
ROM:- UK £17.25 - EUROPE £18.50 - R. of W. £19.25

UTILITIES DISC No. 2

This utility disc contains nine programs. They are Samson, Dallah, Playtrans, Firetrans, Screen Compactor, Address Label Printer, Epscreen Screen Dump, Schinwa Screen Dump, Cith Screen Dump.

DISC:- UK £20.00 - EUROPE £21.25 - R. of W. £22.00
ROM:- UK £25.00 - EUROPE £26.25 - R. of W. £27.00

NIRVANA

Have you tried backing up your original expensive disc software and failed? Use NIRVANA before its too late! NIRVANA (meaning enlightenment) is an extremely powerful disc handling utility which has the following features: Disc to disc back-up copier which will handle most of the commercially protected discs available today. File copier for individual files. Disc formatter, much easier to use than CPM. Change file attributes. Erase files. Change filenames. Will handle all disc drive combinations

DISC:- UK £15.00 - EUROPE £16.25 - R. of W. £17.00

CHARACTER DESIGNER

(All CPC's)

- * REDEFINE YOUR PRINTER DOWNLOAD CHARACTERS
- * REDEFINE THE COMPUTER SCREEN FONT
- * REDEFINE ANY/ALL KEYBOARD KEYS (ASWERTY)
- * DESIGN SPECIAL SCIENTIFIC CHARACTERS/FONTS

Takes all the hard work out of character designing making it a pleasure. The printer part of the program will only work if your printer is capable of DOWNLOADING and is EPSON compatible - see your printer manual. Works with 7-bit or 8-bit output (8-bit port). All the designing is done "On-Screen" so you can see exactly what you are doing. You can save your newly designed characters to disc and reload them at any time into a basic program and into most Word-Processors. The program also allows the user to redefine any or all of the keys on the keyboard. This feature will be useful for those who require an ASWERTY keyboard. The disc also contains twelve sample fonts for experimentation

TAPE:- UK £7.99 EUROPE £9.25 - R. of W. £10.00
DISC:- UK £12.00 - EUROPE £13.25 - R. of W. £14.00

Please send your cheque (£ Sterling) Eurocheque or UK P.O. to:
GOLDMARK SYSTEMS, 51 COMET ROAD, HATFIELD, HERTS
AL10 0SY ENGLAND

Please write or telephone 07072 71529
for full brochure on our many other tape to disc products

SAS ENCORE!

We gave the *Stock Accounting System* a thorough going over in AA42. But the only way to find out whether it is really up to the mark, you might think, is to hand it over to someone such as STEVE PALMER, who uses it to run his computer supplies shop.

Funnily enough, that's just what we did...

STOCK ACCOUNTING SYSTEM
£39.95 ● 128K disk only
SD Micros ☎ 0462 675106

Oh, ooh! I was as excited as any piece of business orientated software could make me. Was this truly the answer to all my prayers? I wondered. As the months unfolded, if that's what months do, I would find out...

The *Stock Accounting System* includes sales ledger, stock invoicing, statements and stock control, with disk utilities and a mini calculator. Impressive, I thought: just about everything I'm looking for to make invoicing, statements and stock control easy!

Limited - liability?

Scanning through the manual I gleaned the following information:

- Credit accounts: 99 credit customers plus unlimited cash customers
- Suppliers: 40 suppliers
- Analysis groups: 10 groups i.e. hardware,

games, education or nails, screws, brackets, wallpaper these groups are used for Analysis or break down of sales

- Stock: 750 different items of stock can be accommodated
- Max stock sale price £9,999.99
- Max stock level for any one item 99,999

So I could use this program to help run my business with its invoicing, statement and stock control facilities. The only drawback was the 750 items of stock restriction.

I decided to use the stock control to keep track of hardware and peripherals such as joysticks, disk boxes, leads and so on. However, the invoicing and accounting side of the programme was ideal.

Getting down to business

The next thing was to get stuck in. But what does one do with a 22 page naff manual printed on dayglow orange paper? After three attempts to get going using it I quite simply threw it away in disgust and set about getting into the program by trial and error.

Soon it all clicked into place. What the manual is *trying* in its own sweet way to get across is that you have to set up several files and input information *before* you can start to use it. Oh, I *see!* If only they had put an example in the manual guiding you through the set-up procedure - i.e. a hardware business! Then, when you set up the package for your own business it would have been a lot easier.

First I had to enter my credit customers' details. Each is given a number 01-99 (00 is reserved for cash customers). Then I had to input my 10 product analysis from 0-9: for instance, 0 nails, 1 screws, 2 brackets, etc. These two inputs are done from the sales ledger. Next I entered the Stock control menu

and input my products 1-750, like this: 1, six inch nails; 2, four inch nails; 3, two inch nails... well, you get the idea.

Now this seems straightforward enough; And so it is. But the manual leaps from one page to another, and soon had me in a right old two and eight (*er, state? - ed.*). This, together with the wearing of sunglasses to read the manual set me off on the wrong foot.

Bad news

All in all user friendliness is not *Stock Control System's* strong point. Make a mistake in parts of the program and there is no way out. Try to save a file and select load instead or visa versa (easily done) and there's just no way of knowing until it's too late. Bang goes a day's work.

Finally the general display of the program lacks the professional look and feel that *Plan It*, *Mini Office* or *Tasword* have. And an option to customise the colours of the display would help - I absolutely *hate* orange on black!

Happy days are here again

Now for the good points. The package is a genuinely useful addition to any small business needing to generate invoices and statements. And if your stock fits into this program then you'll find that the stock control features are excellent.

The stock control keeps track of stock reference number (part number); Description; Unit quantity (eg 10 disks per box); Supplier reference number (whom bought from); Cost price (how much you paid for it, ex VAT); Sale price (how much you sell it for, ex VAT); Minimum stock level (gives you stock low warning); Stock level (how many you have in stock); and Location (where the item is, bin number, shelf and so on).

On balance

All in all this package is an invaluable asset to my business, and congratulations are in order to SD Microsystems for producing it. My only reservations are the manual and the general look of the program, which could have been more professional.

The way in which all this useful software has been made to work on the 6128 is a feat in itself. It's a must for any business using Amstrad CPCs. ●

Order, order!

Let's run through a fictitious order from a customer for 1,000 X 6 inch nails and 4 bags of cement.

First boot the program and enter stock invoicing. This customer has a credit account with us, so we select credit sales.

The program asks for the date, customer's account number, invoice number (automatic), brief description of sale, VAT code (3 options: 0%, standard 15% (alterable), and exempt) and analysis code. After confirming the data you are put into the invoice mode. The preserved address of the customer is put in automatically. The delivery address is assumed to be the

same but you can change that.

Then you can put in a customer order number, if any. Next you're asked to input the items bought and price. Here is where the stock file comes into play. The first item is 1000 X 6 inch nails (100 per box) The programme asks for the qty: you put in 10.

Next input is item number. Let's say six inch nails are item one on the stock list. Enter 1. The item is now displayed. You are then asked if there is any discount.

The program then works out the price, ex vat. This process can be continued up to 20 items per invoice. When all items are

on the invoice it will then add them all up, work out the VAT and be ready to print out the hard copy (as many copies as you require). Then, when you have finished invoicing for the day, you save a batch file and add it to the sales ledger file.

When payment is received it is a simple matter to adjust the sales ledger in auto or manual mode. The program keeps track of payments - and more important non-payment - so that you can simply generate statements.

The sales ledger also keeps track of financial totals, receivable accounts, VAT and analysis of sales, all of which can be output to printer.

- Do you know a piece of software inside out? Would you like to share what you've learned? We aim to make *Encore* - the AA update, a regular section. Write an assessment like this one and you could earn yourself £50 or more! Send us your *Encore* on a disk (we prefer *Protext*, but any word processed or ASCII file will do) and a printed copy to:
Encore, AA, 4 Queen St, Bath BA1 1EJ

HELPLINE

NEW ENTRIES

Murdok signing off. Thanks for the kind letter, mate, and all the best - Steve

Over a hundred pokes, tips and mega-maps.
Martin Dillon 176 Coal Clough Lane, Burnley, Lancs BB114NJ Nominated as 'Number One Helpliner' by Sarah Drummond of Ayr in Scotland. Well done Martin, keep up the good work!

Matchday II, Buggy Boy, Tetris, Nigel Mansell's Grand Prix, Soccer Boss, Jet Bike Simulator, Super Stunt Man.

Craig Thomson. ☎ (0698) 51177. And Sarah thanks you for your help too, Craig

Help wanted on Cybernoid, Eidolon, Mystery of the Nile and ooh heaps of other games.
Nagina Begum, 90 Glebe St, Walsall, West Midlands WS1 3NU

Anyone got a copy of The Boggit on tape to sell?
Paul Bird, 25 Castlefields Lane, Crossflatts, Bingley BD16 2AB

Help wanted for Football Frenzy & Roy of the Rovers
RJ Gullen, 24 Liddesdale Rd, Hawick, Rux Scotland, TD9 OES

Help available for problems with Dr Logo, comms (in Ireland), Amsprite or Basic sprite making. Also posters made out using AMX Stop Press, greeting cards or banners. Standard 20p, draft 10p, NLO £1.

Help with Basic programs, music. Send listing of program and SAE. Also penpals willing to exchange letters on mini office - send cassettes
Desmond Coughlan, 7 Abbotsford Place, Cumbernauld, Glasgow G67 4BJ

Desperately seeking penpals, overseas contacts welcome. Send SAE if overseas
F. Rutterford, 77 Howdale Rd, Downham Market, Norfolk PE38 9AH

Lots of Multiface pokes up for grabs! Send large SAE
N. Howell, 1 Turner Rd, Biggin Hill, Kent

Help with Basic and m/code, debugging Basic progs (send tape and enough stamps for return: no discs). 464 tape problems, Rams & romboards, joysticks, ram Music machine, Midi, General CPC problems (hardware/software)
Peter Harrison, 38 Lynmouth Drive, Wigston Fields, Leicester LE8 1BP

Desperately seeking penpals! Help on the Advanced Music System
Mark Turner, 7 Campsey Rd, Southery, Downham Market, Norfolk PE38 ONG

Penpal wanted to swap games &c. I have 6128 & Cannon PW-1080a printer. Interested in wp; games (Target Renegade, Ikari Warriors, Driller, Total Eclipse & others)
Christopher Bowler, 318a Wrythe Lane, Carshalton, Surrey SM5 1AF

Help with Bonze, Meddler, Blitz and Doo Dah.

Screen dumps 20p a page/per screen dump. Send SAE with disk or letter to
Morgan Fitzgibbon, 97 Greenwood Estate, Togher, Co Cork, Ireland

Basic & M/code - debugging, routines, hacking (games since '85), loading problems, ROMS & MFII. In fact, just about anything really...
John Girvin, 25 Moorgate St, Belfast BT5 5BZ, N. Ireland. ☎ 658939

Pokes, hints & maps. Send middle-sized SAE for list
Jeffrey Almond, 183 St Helens Rd, Eccleston Park, Prescott, Merseyside L34 2QB

Help with almost loadsagames; tons of keypress cheats. Can also help with adventures. Phone first & if I have a long poke &c I'll send it on.
James Griffiths, Passby House, Lysonnen Rd, Carmarthen SA33 5DX ☎ 026782 443, 4.15pm-7pm Mon-Fri

Penpals wanted. More than 1,000 titles both on tape & disk including most new titles. Reply promised
Mustafa Dag, Eski Osmanli SK 8-8, 80310 Mecidiyekoy, Istanbul, Turkey

Loads of games. Send SAE
Kevin Poast, 147 Monks Park, Wembley, Middx HA9 6JP

Enclose disk inlay as proof of ownership (alright Colin?). Also help with Heroes of Khan and Forest at Worlds End
Mick Hopewell, 55 Hawthorn Cres, Arnold, Nottingham NG5 8BE

Through the Trap Door - anyone got it on tape? I can't find it anywhere
Kevin Murphy, 136 Main St, Lennoxton, Glasgow, G65 7DA

Need help bad on Army Moves, Green Beret, Last Ninja II, Platoon, Frank Bruno's Boxing (yup, Frank Bruno's boxing need help bad alright! - Steve)
Brian Mays, 81 Hollyfield, Harlow, Essex, CM19 4NB

Please please please (*that's enough please* - ed.) anyone interested in games & reading AA. I'm 14 and anyone will do
Simon Williams, 24 Chalcot Drive, Hednesford, Staffs WS12 4SF

Maps for copying - over 60 including Dizzy, Thrust, Driller, Dark Side, Exolon, Trantor & others. Send 15p per map for photocopying. Penpals wanted too!
Anthony Treacy, 60 Ruskin Rd, Kingsthorpe, Northampton, NN2 7SY ☎ 0604 71605

Basic programs written (price on application). Basic & Pascal programs debugged: send disk or tape stating program. (10p per K of program tape; 15p per K disk)
Craig Willcocks, 105 Kent Avenue, Minster, Sheerness, Sheppey, Kent ME12 2DX

Help! I need a picture digitised ready to use on Stop Press. I'll send the picture to you with an SAE
Stephen Thompson, 5 Pendragon, Great Lumley, Chester-le-Street, County Durham, DH3 4NA

Will supply any help for Mirage Imager and supply any digitized video picture for Advanced Studio. Loads of games/utilities
Matthew Clover, 10 Lacon Rd, Bramford, Ipswich, Suffolk ☎ 0473 43811

Loads of maps, pokes and tips for new and old computer games
Mark Watson, 106 Mountain Rd, Thornhill, Dewsbury, West Yorkshire, WF12 0BP

Help on disk drives, printers, Protect, disk backup, tape to disk Multiface and tape loading problems
Someone from Thanet who forgot a vital bit of information: name and address! Wake up matey! - ed.

Will print listings & screens 10p per page, send tape/disk. Help on AA Studio, Tasword, DMP2000, DKTronics Speech ROM, customising cassette recorders/ joysticks/computers etc.
David Carter, 28 Mt Hermon Rd, Woking Surrey GU22 7UH

Penpal wanted to share tips and pokes
Iain Thomson, 13 Millhill Ave, Kilmours, Kilmarnock, Ayrshire, Scotland KA3 2TA

Maps, tips, codes, pokes on over 250 games, AMX Stop Press. Penpals wanted!
Jay Redfern, 10 Oaktree Close, Mansfield, Notts NG18 3EN

Tips & cheats (no pokes) on Asphalt, Get Dexter I&II, Dizzy, Wizball, Ghosthunters, Super Stuntman, Grand Prix Sim, Super Robin Hood, Sorcery +, Green Beret, Driller. SAE & 10p per game
Alistair London, Maryfield, Strath-martine, Dundee, DD3 0PW

19yo 6128 owner wants penpal who can program M/C so he can learn
John Mullen, 62 Lonsdale St, Workington, Cumbria, CA14 2YD

Ireland only: utilities: disassembler, real time clock, disk search, 6128 extra memory commands. All m/c. Send tape/disk & padded SAE to
D.J.Daly, 'Amber Pines', Annmount, Glounthaune, Cork, Eire

Feeling helpful? Just send your name, address, phone number (say if you don't want it printed) and subjects on which you're offering help to: *Helpline*, Amstrad Action, 4 Queen Street, Bath, BA1 1EJ. Please write on a postcard or the back of a stuck down envelope and keep it short or you won't get in (or you'll get cut to 'load-sagames').

If you want help contact the appropriate Helpliner - not us. By post include a self-addressed, stamped envelope for the reply - or you won't get one. And phone only in decent hours!

Piracy is not welcome: don't try it, you'll get booted off. Keep it legal. And if you receive SAE's, for heaven's sake return them with some acknowledgement. If you want to come off *Helpline* just write and say so. All comments are the editor's.



ROCK STAR



Could you manage this
Rock Star ?



CodeMasters Software Company Ltd., PO Box 6, LEAMINGTON SPA, CV33 0SH

SCREENVISION
TURNS YOUR
MONITOR INTO
A COLOUR TV!

AT THE AMAZING OFFER PRICE OF **£64.95**
Door to Door Insured delivery add £6 INC VAT

USE YOUR AMSTRAD CPC464, CPC664 &
CPC6128 MONITOR AS A COLOUR TV SET!

Screenvision is a modern 'State-of-the-Art' TV Tuner which simply connects to your monitor, using the existing lead and converts it to an outstanding colour television.

Screenvision has more features than any other TV Tuner and costs less! Each tuner has seven pre-select push button channel selectors, separate controls for brightness, colour, tone and volume and has built in Speaker, Colour and Automatic gain control.

Unlike other products, Screenvision also connects to a host of other Monitors should you change your system.

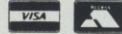

DEALER & EXPORT ENQUIRIES WELCOME

SCREENS

MICROCOMPUTERS &
ELECTRONICS

MAIN AVENUE · MOOR PARK
SALES 09274 20527 EXPORT 09274 20664

MIDDLESEX · HA6 2HJ · ENGLAND
TELEX: 929224 SCREEN G FAX: 0923 835421

ROMANTIC ROBOT *regrets*

Because of possible implications of the coming new Copyright Act
we will NOT sell the MULTIFACE in the UK after 01/08/1989.

This is our **LAST ADVERT** and your **LAST CHANCE** to buy!

To help EVERYBODY to get THE ESSENTIAL CPC ADD-ON whilst still possible,
we offer a massive **£10 OFF the MULTIFACE TWO.**

We also offer **£5 off INSIDER** and a **FREE Rodos Xtra** with each **Rodos.**
Please **DO** realize that this is more than an absolutely unique offer:

this is the LAST CHANCE you have!

All sales
will end on
July 25

BUY NOW - or NEVER...

All offers apply only to MAIL ORDERS received with the coupon below 15.6.-25.7.1989

Is there life after Multiface? Maybe... But not without one!

1 Order: MULTIFACE 2	£37.95 <input type="checkbox"/>	RODOS ^{Plus} RODOS EXTRA	£29.95 <input type="checkbox"/>	Plus p&p UK £1, EUROPE £2
INSIDER	£9.95 <input type="checkbox"/>	RODOS EXTRA	£9.95 <input type="checkbox"/>	Overseas £3

I enclose a cheque PO for £..... or debit my No Card exp.....

Name & address

ROMANTIC ROBOT UK LTD 54 Deanscroft Ave, London NW9 6EN 24 hrs 01-200 8870

24 pin ups

Thinking of upgrading to a 24 pin printer? PAT McDONALD gets his paws on a pair.

SEIKOSHA SL-80A1

£299.99 + VAT
☎ 0753 685873

If you find it reassuring to have your printer weigh in on the heavy side this hefty Seikosha beast – at about seven and a half kilograms – should put your mind at rest.

It is not too wide or deep, but is taller than the Star. The printer cable goes to the rear of the printer, making it conventional in operation.

Continuous stationery goes through the printer with the aid of the tractor feed attachment. This is easily removed, but putting it back is more fiddly.

Strangely enough, the feeders themselves cannot be locked in place: if the printer is on an uneven surface, or the paper not quite aligned, the printer soon chews up the sprocket holes on the paper. Another danger for the unwary is the distressing habit the printer has of feeding the top of the paper into itself again...

This last problem is easily remedied with the paper separator, which apparently doubles as a cut sheet feeder. As noted in the Star review, these are handy gadgets that hold magazines of cut sheets.

When you first start printing, you can't help but notice the slow, smooth speed at which the paper feeds through. This isn't very helpful if you're after a quick print, but there is a good reason. The Seikosha is set up to feed slowly

Pinning down the difference

A few years ago, the only dot matrix printers that you could buy were nine pin efforts. This meant that the actual printing process was carried out by a column of nine pins. When printing a line, the print head moves across the page, and the dots are produced or not according to what your computer tells the printer to print.

24 pin printers are much the same, except that the print head has a column of 24 pins, improving the resolution of the characters and producing much better quality print.



● With a bigger buffer than the Star the Seikosha has more themes (you can do more with it)

and carefully: this means that it's very good at printing on cut sheets, simply because it takes its time to match them up. If you want to regress to the usual slapdash approach, there's a button on the front panel to return you to the normal speed of 70 characters per second in draft pica.

The front control panel is not nearly as impressive as the Star, featuring just the usual on/offline button, formfeed, linefeed and speed controls. The reason for this is that it doesn't have any extra fonts, just the usual pica and elite, plus emphasised, condensed, proportional and so on. Examples of all the effects are included in the manual, which lists all 128 possibilities.

Instead, the printer has an impressive 16K of space to upload extra fonts to. As each font

takes up perhaps 6K-8K, the space isn't there to emulate the extra fonts of the Star. However, the Seikosha has the flexibility (assuming you have a program to redefine the printer characters) to give you more control over what finally appears.

The Seikosha's graphics printing is of the same high standard as the Star LC24-10. (If it appears slightly darker it's simply because the ribbon was fresher.) However, it must be said that the Seikosha is a second or two faster at printing the same picture.

The SL80A1 has fewer features than the Star. To be fair it is cheaper and has more versatility, so really it's a question of whether you're prepared to put some effort into creating fonts or you're prepared to pay for an easier life.

● JD Cunningham of Bessbrook didn't quite make it into this month's *Look*, but here's what the SL-80 makes of his picture of Garfield, together with some samples of text printout

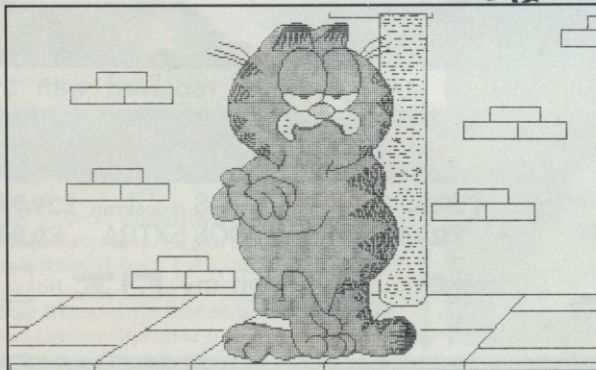

different widths
There are 127 variations on this
with every effect on
ting of the SL-80

STAR LC24-10

List price: £399.99 + VAT
(but Action for example - ☎ 0800 333 333 - sell it for £100 less)
☎ 01 759 0005

Similar in appearance to the LC10 (available with colour printing ability - see the *Colourdump* review over the page) the LC24-10's cable connects at the side, meaning that you don't get the cable mixed up with the paper feed, a not uncommon problem with certain other printers I could mention.

The Star is a page eater and no mistake. It prints at around 150 characters in draft pica per second, significantly faster than all 9 pin printers.

Loading single sheet stationery is routine - a cut sheet feeder is included, as with the Seikosha. This means that a magazine of sheets is available to be printed on: good news as it means that a lot of the labour of document printing is now gone.

Continuous stationery is slightly less orthodox. At the back of the printer is a plastic spring-loaded cover. This must be removed in order to load said paper, which is a bit of a bind. It doesn't look particularly pretty either. It is, on the whole, a good thing though, because you can load either kind of paper without fiddling about fitting different feed systems. The height of the printer is also kept down as a result.

The front panel of the Star is worthy of special mention. From here you can control the



● ... but the Star's built-in fonts are more varied

number of characters per inch, whether or not proportional or condensed mode is in use, and various fonts and timesteps. The bleeper on the printer sounds as each move is made, which together with the Christmas tree of lights, reassures you of just what you're doing.

Each of the fonts looks excellent - there's less need to resort to *Qualitas* any more! Characters can also be printed up to four times their usual size, so that decent-sized headlines

can be produced quite easily.

Extra fonts can be plugged in on a memory card. If blank memory is used instead, then the Star can have new character designs uploaded to it from a font designer, or alternatively it can be used to increase the size of the printer buffer, which means that your CPC won't spend so much of its time waiting for the printer.

There is little to choose between the Star and the Seikosha as far as graphics printing is concerned.

All in all the LC24-10 is a very sound design, easily capable of out-performing any 9 pin printer, and indeed the Seikosha, on most points. The only shortcoming is in the size of the printer buffer - 7K compared to the SL80's 16K. However, with the superb front panel, the printer taking up less space, and the extra built in fonts, the Star is the superior printer. Not that I would expect anything else, considering the price difference.

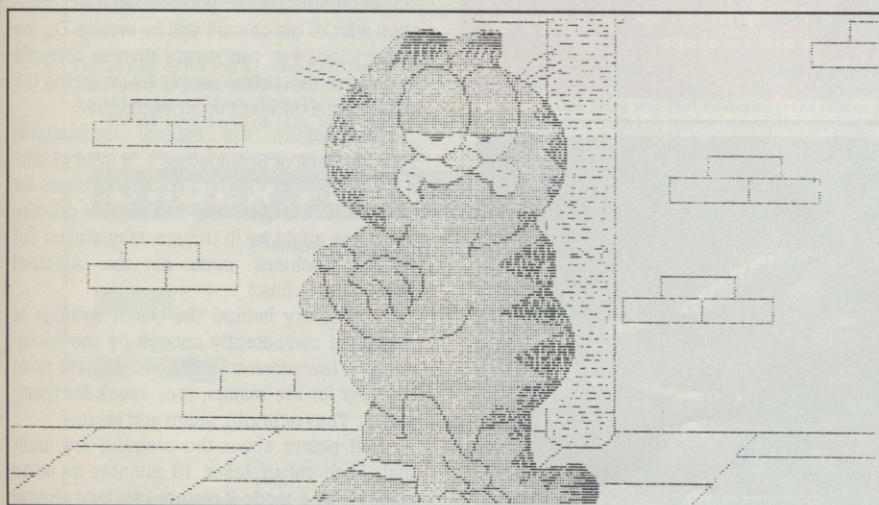

● Here's Star's attempt at Garfield and some sample text printouts - very little in it

GRATOR IS OK I SUPPOSE
ITALICS? GETTING GOOD!
oops! Back to standard size
Script italics are a bit much though
Script for the bookish type
Courier is the standard font

Verdict

So which 24 pin printer should you buy? There's really nothing in it as far as print quality goes: it would take a very discerning eye indeed to tell the difference. The chief thing that distinguishes them is speed, with the Star performing about twice as fast as the SL-80.

The choice comes down to font usage. If you just want standard pica and elite, or don't mind designing fonts yourself, plump for the SL80.

If, however, like me, you want a few special effects and an easy life, the Star is the better buy. The front panel display means that you don't have to fiddle with printer control codes, and the different fonts themselves should be sufficient for most needs.

Prints charming

One day, they said, your colour prints will come. That day has arrived, as PAT McDONALD reveals.

COLOURDUMP

**R.J. Moss, 15 Heyworth Avenue, Romiley, Stockport SK6 4NF
£9.50 disk - £7 if disk supplied:
all CPCs**

The display of an Amstrad CPC is far superior in terms of colour and resolution to its 8-bit cousins: you need only turn as far as *The Look* on page 36 to see examples of the impressive range of subtle depth, highlighting and shade you can create on a picture.

There are programs to let your artistic bent flood out - *Advanced Art Studio*, *Melbourne Draw* and of course Robert Buckley's *Smart 2* from AA37. But there is one underlying problem to all this art: how do you

keep a permanent record of it? You can't really keep your monitor turned on all the time.

Most printers available on the market can handle small dots and so on: the problem is that they can't really handle the colours. Until now. With *Colourdump* you can produce mode 0 or 1 hard copies of screens in glorious colour, on virtually any printer that is Epson compatible.

Star maker

For the Star LC10 four colour printer (reviewed in AA32) *Colourdump* has a set of routines to take advantage of its capabilities. The examples on this page were mostly done using this printer.

Such routines aren't commercially available - though your on-the-ball, topical, user-



friendly *Type Ins* just happens to have a listing this month for that very purpose!

The way the program extracts colour performance from a black and white printer is quite clever: you run a sheet of paper through the printer with a particular coloured ribbon or piece of carbon paper. At the end of the page, the printer reverse feeds back to the beginning, and requests you to change the colour medium.

The program works down through the picture, splashing a colour mix that has been set up to your own specifications (there is a default setting) and eventually the whole screen area is covered.

Of course, if you get the colour mix wrong for the different ribbons - say you put a blue ribbon in when when you needed a red one - then a lot of the colours will be wrong. On the other hand, you can create diverse coloured variations on a theme simply by swapping the ribbons in a different order each time.

(Incidentally, the manual recommends HSV Supplies of Basingstoke - ☎ 0256 463507 - for supplies of different coloured ribbons for printers. Although owners of slightly obscure machines might be in trouble, mainstream dot matrix machines such as the Amstrad DMP2000 are fine.)

The theory behind the colour settings is explained competently enough by the manual, but a few more examples would have been nice. As for the results, they speak for themselves. They're bright, sharp and clean.

Bad points about the program are minimal. Each colour takes 10 minutes or so to achieve, so a mode 0 picture can take around three hours to print out. Another niggling point is the small size of the screen dump: it's approximately A5 size, and not really suitable for a poster.

Colourdump is a good, competent program that fills a hole in the CPC market. Upgrades - such as for a larger screen dump for instance - would be warmly welcomed, but *Colourdump* is nonetheless a worthwhile expenditure on its own. ●

GOOD NEWS

- Produces good effects on an 'ordinary' printer...
- and even better ones on an LC10.
- Price is nice, too!

BAD NEWS

- Small dumps only.
- More cost on ribbons or carbon paper.
- Fiddly to set up - the manual lists 12 steps.

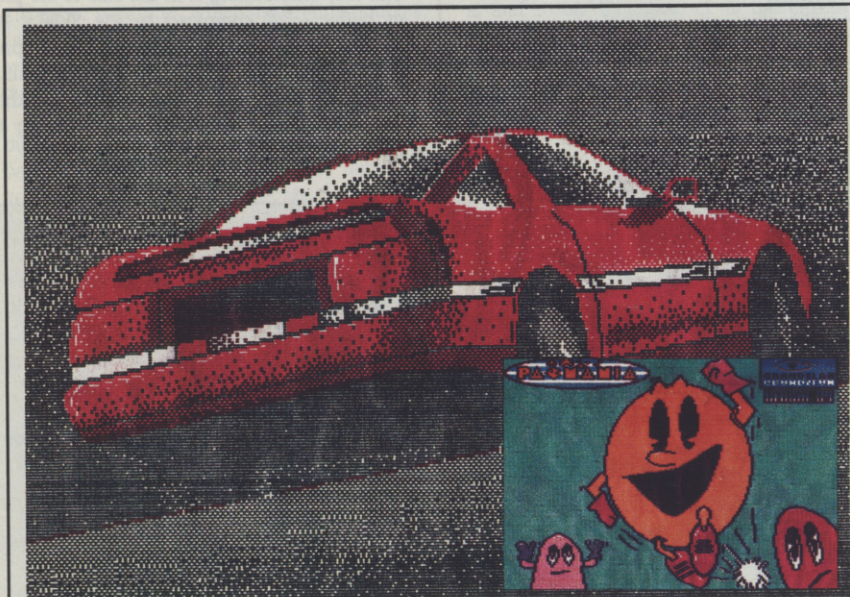

● Pacman (by David Knight) and The Car (Marcus Jones) came from last month's *The Look*. The print outs are clear and bright, though at anything up to three hours per composition you'd better not be in a hurry!

AA SMALL ADS

FOR SALE

CPC464 colour monitor, software, magazines, books desk. £200 ono Telephone 01-866-1004.

Premier Pack. A suite of quality productivity tools for CPC's. Includes word-processor, database, and art package. £9.95 cassette, £14.95 disc. Send money to Archer software, 9 Pembley Avenue, Bedford MK40 2LQ.

Amstrad C464 cassette colour monitor, excellent condition £400. Eleven well known games included in price. Telephone Yvonne on 0276 66521.

The new reach out collection! Speech, brilliant graphics! 18 great programmes +3 games free! Only an incredible £2.49 tape, £4.99 disc! Over 150K! Art studio 2, Coffee Shop, Diary, Database, Barchart, Ghostmania, Treasure + more! Add 40p (p & p). R D Griffin, 6 Charles Road, Frome, Somerset BA11 1NT. (0373) 63389.

Sexy Games' Adult Trivia game on cassette only. Contains language suitable for persons over sixteen only. Will only accept cheques for £5. David Shaw, 21 Balfour Court, Kilmarnock, Ayrshire KA3 7TD.

DDI-1, floppy disc drive with interface for CPC464, complete with CPM 2.2 only £60. Tel (0235) 22043. (Oxford area). Ask for Robert (after 6pm).

Excellent Modeo Art program. Supplied on

disc at only £6.00, 6128 only. Includes free disc manager program. Buy now! Postal orders to: James Davidson, 73 James Nisbet Street, Glasgow G21 2QL.

Would you like to learn more about Logo? More about the different aspects of Logo? For more information send letters to: Morgan Fitzgibbon, 97 Greenwood Estate, Together, Co Cork, Ireland.

CPC464 colour monitor DD-I disk drive, joystick, manuals, lots of games, magazines, PAW, Assembler Tutor. Good condition. £275.00. Tel (0952) 812112 ask for Tim.

CPC6128, colour monitor, built-in d/drive, tape deck, joystick, books, over £100 software, misc games etc excellent condition, worth over £600 asking £295 a great buy. Telephone 0271-77741 Barnstable Devon.

Amstrad CPC464, colour monitor, DMP-1 printer, Light pen, and games including Operation Wolf, Microprose Soccer, Afterburner, Target Renegade, Dragon Ninja, Crazy Cars 2. Sell for £495. 0280 813759.

CPC464 colour monitor, disk drive, printer all in excellent condition, hardly used. Also software on cassette and disc. Send SAE for list to Ian Stewart, 58 Whinbank, Ladywell, Livingston, Scotland.

Wish you could run multiface files without multiface? You can with Autonomy! £9.95 on disc 6128 only. Cheques/POs to Electronic Innovation, 11 Sermon Road, Winchester, SO22 5NU (SAE for details).

Use Ransacker with your Multiface! Stop any game any time and search for pokes for any counter- infinite lives, ammo, fuel, you name it. Also changes counters in mid game! No programming knowledge needed. Easy to follow instructions. Printers supported. Incredibly fast only £9.95 on disc. Cheques/POs to Electronic Innovation, 11 Sermon Road, Winchester, SO22 5NU (SAE for details).

Manipulator - the highly integrated hacking/debugging system for 6128 and Multiface users. Fast previewing disassembler. Conditional search. Any file to/ from any address. List disassemble to file/printer. Edit, view or print ALL information on state of computer. No memory corruption. £9.95 on disc. Cheques/POs to Electronic Innovation, 11 Sermon Road, Winchester, SO22 5NU (much much more SAE for details).

Football program with all results for divisions 1-4 season 88-89 including team colours, league tables etc. fully menu driven (250K) only £1.99. Tahir Ghani, East Tarbert, Isle of Harris PA85 3DB.

Brain teasers. Four games to make you think! + Scoop! and Klondike. Play cards against human, computer or solo. Over 52K. Transferable to disc. £2. Paul Robson, 23 Park Lane, Middlesbrough TS1 3LQ.

CPC Home Executive! Personal accounts, card filer, shopper, diary/calendar utilities. Prints on standard or organiser paper. Summer offer price £14.95 (tape/disc). SD Micros (AA) PO Box 24, Hitchin, Herts. Tel (0462) 675106 SAE for details.

Stock clearance! Dr Who and Mines of Terror CPC cassette, absolutely free! Just send £2.00 to cover P&P Cheques/PO to Software bargains, Northwood House, North Street, Leeds LS7 2AA tel 0532 436300.

Turn your DMP2000 into a colour printer with COLOURDUMP. See AA45 page 8. Send £9.50 to R Moss, 15 Heyworth Ave, Romiley, Stockport SK6 4NF tel 061 4303917.

Screen Dump for Star LC10 Colour printer.

Send £9.50 to R Moss, 15 Heyworth Ave, Romiley, Stockport SK6 4NF. Tel 061 430 3917.

SERVICES

Programmer's utility! Obtain over 300 expansion/function key characters. M/C + Basic program users less than 0.3K send cheque for £5.00 (p&p inc) to Trixibelle Software, 7 Abbotsford Place, Cumbernauld, Glasgow G67 4BJ.

Phoenix the original tape to disc specialists. 100% transfer rate, state 464.6128. 85p/game, compilations, 80p/game, Multiloaders £3.50, add 30p if tape(s) are to be returned, enclose disc, tape, instructions when ordering. Not the cheapest but the best. Eprom programming prices from £8.00. Send for catalogue. Phoenix, 10 Walter Street, Draycott, Derby DE7 3DE. Tel: 03317 4490 after 7pm.

Slip-disc tape to disc specialists. From now until 30 November 1989 all games transfers are free, state 464 or 6128 send tape(s), disc(s) and game instructions. Also enclose return postage & recorded delivery costs. This is a free service until 30.11.89 make cheques payable to: D R Hudson, 13 Cromwell Road, ST Austell, Cornwall PL25 4PR (0726-66640).

Would you like to earn £3.50 per hour mailing envelopes for a publishing company? SAE to May Parkes, 35 Lorne Street, Reading Berkshire RG1 7YW.

Phoenix the original tape to disc specialists. 100% transfer rate state 464/6128. 85p/game, compilations 80p/game, Multiloaders £3.50, add 30p if tape(s) are to be returned. Enclose disc, tape, instructions when ordering. Not the cheapest but the best. EPROM PROGRAMMING prices from £8.00. Send for catalogue, Phoenix, 10 Walter Street, Draycott, Derby DE7 3DE. Tel 03317 4490 after 7pm.

AA SMALL ADS

This section offers you a really cheap and effective opportunity to speak direct to 38,000 CPC owners - or would be owners. Users report excellent results. You can place an ad up of up to 30 words for just £5.

So you could use it to sell a printer, launch a user group or advertise a piece of software you've written. One thing you can't advertise is the sale or swap of software. Such ads can be misused by pirates.

Fill in the application form and send it to us together with payment. We'll place the ad in the next available issue (published 2-7 weeks after we receive your order).

ORDER FORM

SEND TO AA SMALL ADS, FUTURE PUBLISHING LTD, 4 QUEEN STREET, BATH BA1 1EJ

Please place the following advertisement in the next available issue of *Amstrad Action*

Name _____

Address _____

Telephone _____

I enclose payment of £5.00 by Cheque/ P.O./ Access/ Visa

Credit Card number _____

Credit Card expiry date _____

Classification. Tick For sale Wanted Services User Groups Other

Write your advertisement here, one word per box. Include your name and phone number if you want them

SOFT EXCHANGE

Special Offers Discs £4.99

Eye
Movie
Never Ending Story
Baseball
GFL Football
Championship Sprint
Galactic Games
Karnov
Rampage
Super Hang On
Volleyball Sim
Madballs
Computer Hits 5
Computer Hits 6

£1.75
Black Beard
Oink
Who Dares II
Ace II
Seuck
Treasure Island
Elevator Action
Trantor
Joe Blade 2
Street Gang
BMX Sim 2
Bomb Jack
Gun Boat
Yogi Bear

Title	Cass	Disc	Title	Cass	Disc
Fun School 2-5	4.50	6.99	Colossus Chess 4	8.95	12.99
Fun School 5-8	4.50	6.99	Motor Massacre	8.49	11.49
Fun School 8-12	4.50	6.99	Netherworld	6.50	N/A
Fun School 2 (Un 6)	7.75	9.25	Blasteroids	7.99	12.99
Fun School 2 (6-8)	7.75	9.25	10 Great Games 2	7.99	N/A
Fun School 2 (8+)	7.75	9.25	Command Performance	10.99	12.99
Mini Office	12.49	14.95	Run the Gauntlet	6.99	N/A
Stop Press DTP	36.99		Top Ten Collection	6.99	10.99
Extra Extra	17.99		Last Dual	7.99	10.99
Stop Press Inc Mouse	62.99		Barbarian 2	6.99	10.99
Art Inc Mouse	60.99		Crazy Cars 2	7.99	11.99
Tasword 6128	18.99		Renegade 3	6.99	10.99
Taspell	11.99		Wec le Mans	6.99	10.99
Tasprint	9.99		War in Middle Earth	6.99	11.99
Tascopy	9.99		History in Making	14.45	18.49
Tasdiary	9.99		H.K.M.	6.99	9.99
Tassign	19.99		Dragon Ninja	7.49	9.99
Iankey 2 Finger Typing	17.99		Chartbusters 20	7.99	N/A
Iankey Crash Course	17.99		Pacmania	6.50	12.95
Supercalc 2	36.99		After Burner	6.99	8.99
Hisoft Devpac 80	36.99		Operation Wolf	6.99	N/A
Hisoft Pascal 80	36.99		Football Man II	6.99	9.99
At Last Plus	26.95		HARDWARE		
Multiface II	39.99		CPC 464 Mono	185.00	
Mastercalc 6128	23.99		CPC 464 Colour	275.00	
Matrix Spreadsheet +	26.99		CPC 6128 Mono	265.00	
Protext	16.95		CPC 6128 Colour	360.00	
Prospell	16.95		Star LC10	180.00	
Promerge	16.95		Star LC10 Colour	236.99	
Fleet St. Editor	35.99		Star LC24-10	299.99	
			Amstrad DD1 Drive	154.99	

Blank Discs at £2.20 each or 10 for £19.95

All Recent Budget Titles at Discount £1.99 = £1.60 or £2.99 = £2.49

To Order send Cheque/P.O. to:

SOFT EXCHANGE LTD
101 CLIFTON ROAD
SOUTH NORWOOD LONDON SE25 6QA

Orders from Govt. or Educational Depts. are Welcome Please Write

STOP PRESS NEWS from NEMESIS CPC PROCOPY Now available

The long-awaited **CPC PROCOPY**, developed by Kevin McCaughey is available **EXCLUSIVELY** from NEMESIS.

You will have noticed that your present disc-copier is becoming less efficient, due to the extensive protection now employed on many commercial discs. This is particularly apparent on "Speedlocked" discs. **CPC PROCOPY** can "clone" these, and other heavily protected discs. By employing semi-Z80 EMULATOR techniques **CPC PROCOPY** can reach sectors that other copiers cannot cope with! **CPC PROCOPY** will "out-ology" your present "cloner" - whatever it is!

**PROBABLY the BEST "cloner" in Europe ?
NO ! CPC PROCOPY IS the BEST !!**

FEATURES :-

- (1) FULL A/B DRIVE CAPABILITY.
- (2) CAN ALSO ARCHIVE TO TAPE.
- (3) MAPPING & GAP 3 ANALYSIS.

And there's more ! **CPC PROCOPY** includes,

MINIDOS

You can now forget the cumbersome CPM for routine disc functions. **MINIDOS** also includes some useful non-standard routines, and can be readily copied to VENDOR format discs. **MINIDOS** commands are friendly, useful and **POWERFUL**.

- 1 CAT - full catalogue of ALL files on a disc - including "hidden" files.
- 2 CAT any file for type and parameters.
- 3 FORMAT RENAME, and COPY files
- 4 Make files READ/WRITE, READ ONLY, SYSTEM.
- 5 An intelligent UNERASE facility!

All this sounds pretty expensive, but **NEMESIS** are able to offer this professional utility at their regular price - whilst they can legally do so.

CPC PROCOPY just £12.50 on DISC

**PLEASE REFER TO OUR MAIN ADVERTISEMENT
ON THIS PAGE FOR ORDERING DETAILS.
NEMESIS 1989**

NEMESIS - The Original Meddlers

BONZO SUPER MEDDLER

"A REAL ALTERNATIVE to a Multiface II BLACK BOX.", A.A JAN '89.

"The best TAPE TO DISC transfer utility available", WACC1 6/88.

THE 1989 EDITION

BONZO SUPER MEDDLER continues as the most complete TAPE TO DISC transfer utility. Recently revised, it now includes a database of all verified transfers - currently 880 TRANSFERS ! **GUARANTEED TO TRANSFER MORE** games than any other program - POSITIVELY!

BONZO does the transfer - and you play your games from DISC. Here's a few of the 880 put to disc with BSM, 464/664/6128:

ANTIRIAD, ARKANOID, ARCTIC FOX, BARBARIAN, BMX SIMULATOR I & II, BOBSLEIGH, BOBJACK I & II, BIGFOOT, CYBERNOID II, CAULDRON I & II, DANGERMUSE, DARKSIDE, DRILLER, DARTS - 180, DIZZY I & II, DANDY, EQUINOX, ENDURO RACER, FERNANDEZ MUST DIE, FOOTBALLER OF T' YEAR, GREMLINS, GUADAL CANAL, GRAND PRIX SIMULATOR, 3D GRAND PRIX, HOPPING MAD, HACKER, HIJACK, IKARI WARRIORS, INVASION, JETSETWIL, JACK NIPPER I & II, JOE BLADE I & II, KUNG FU MASTER, KNIGHTMARE, LEADERBOARD, LIGHTFORCE, LIVING DAYLIGHTS, MOONBUGGY, META L ARMY, MONOPOLY, NEXOR, NINJA SCOOTER SIM, PYJAMARAMA, PEGASUS BRIDGE, REFLEX, RED OCTOBER, REDHAWK, RED MOON, SCRABBLE, SUPER STUNTMAN, STEVE DAVIS SNOOKER, STAR RAIDERS II, SWORD SLAYER, STORMBRINGER, STAR TROOPER, SPINDIZZY, STRYFFE, TTRACER, TOPGUN, TOTAL ECLIPSE, TETRIS, TANIUM, THRUST I & II, V, VAMPIRE, WEREWOLF SIM, XOR, ZUB.

and OVER 800 others!

Isn't it time you got the BEST? Send your disc-based utility to be transformed into BSM & HACKPACK for just £8.00. If you haven't got one, then the BSM & HACKPACK with full instructions, details of over 800 transfers, and our current NEWSLETTER,

£12.50 inclusive. Supplied on disc.

BONZO BLITZ - SPEEDLOCKS TO DISC "HIGHLY RECOMMENDED" - WACCI, 12/87

BONZO SUPER MEDDLER will cope with a large number of SPEEDLOCKS, but for the enthusiast we developed **BONZO BLITZ** - the first to deal with all forms of SPEEDLOCK. It doesn't need an expanded CPC - works on 464/664/6128 - and still EQUALS any other utility - WITHOUT juggling or fussing. A database on this one too! A FEW: ALIEN HIGHWAY, ARMY MOVES, ATV SIMULATOR, BEACH HEAD 1 & 2, CATCH 23, DEATHSTALKER, DIZZY, ELEKTRAGLIDE, FRUIT MACHINE SIM, F15 EAGLE, GAMEOVER 1 & 2, GREAT ESCAPE, HIGHWAY ENCOUNTER, MATCHDAY I & II, MADBALLS, METROCROSS, REVOLUTION, SALAMANDER, SLAINS, SCRABBLE, SCALEXTRIC, SUPERHERO, TRANSMUTERS, WIZBALL, WEC LE MANS, etc. **WORLD CLASS LEADERBOARD** and **ROADRUNNER** although "multi-loaders" will completely transfer if you have BSM to assist! Other "multi-loaders" - main file only. **BLITZ** was first in with the "NEW" SPEEDLOCK variation - and there's dozens of compilation tapes using this, like **MAGNIFICENT SEVEN & GAME, SET & MATCH II**.

£12.50 inclusive. Supplied on disc.

JUNE
JULY ONLY

**BSM & HPACK + BLITZ
TWO DISCS, all info £22.00 inclusive.**

UPGRADES = BSM or BLITZ, £3.00 [return original disc!]

BONZO ANSWERS - "GO" LOADERS AND OTHERS

Q If I buy **BONZO SUPER MEDDLER** and **HACKPACK** for £12.50 will I need yet another disc [£15 !] from another advertiser in order to cope with "GO" loaders?

A NO! The current version of BSM & HP has OPTION 10 specifically to deal with these! Older BSM's without an OPTION 8 & 9 can be updated to include all the new options for just £3. If your BSM has got OPTION 9 on it - then it will cost just £1 handling to add OPTION 10.

Q The same advertiser has a disc [£8.50] to cope with SOME FIREBIRD loaders. Will I need this?

A NO! BSM & HPACK has long been able to cope with the majority of FIREBIRD loaders.

Q So what about "ordinary" files, I suppose I have to buy yet another disc [UTILITIES £15.50 to include the utility I need] to deal with those?

A NO! And no more questions either! BSM copes with all so called "normal files", and the majority of heavily protected games - see the list on the left of this advertisement!! The total number of tape to disc transfers by **BONZO SUPER MEDDLER & HACKPACK** is NEARLY 1000!

Q It is suggested that **BLITZ** can't do as many SPEEDLOCKS as another heavily advertised product - is it true?

A NO! The strike rate is even - one game that "theirs" doesn't do is **WIZBALL** - **BLITZ** does! Neatly balances **MUTANTS** we'd say. **BLITZ** is cheaper, works on all machines and is easy for us to keep up-to-date.

Q Can I buy BSM & HACKPACK, and **BONZO BLITZ** please?

A CERTAINLY! It'll cost you **£22.00** for the two discs whilst we feel generous.

BONZO's DOO-DAH

"This is the best I've seen in a long while... I recommend it"

- AMSTRAD ACTION. JUNE 1987

FEATURES **BIGBONZO** FORMAT

A REALLY USABLE 203K per SIDE FORMAT, with all the support files to maximise it's use PLUS - All the disc housekeeping features that you could possibly want, including "Cloning". Directory & Sector edit. Disc search, Formatting, Read sectors, Filecopy, etc ALL FUNCTIONS are effective on normal, enhanced, and the majority of "funny formats"

MANY UNIQUE FEATURES. Supplied on DISC

£12.50



NEMESIS A.A

ALL ORDERS sent by return: Cheque/P.O/Access

TEL: (0933) 623967

10, Carlow Road, Ringstead, Kettering, Northants NN14 4DW



AA in virus spoof!

Well, not AA as such. More PHIL CRAVEN, W.A.R.T.S. and all, with a piece evidently written under the influence of too much cough mixture.

In recent months there's been a lot of publicity about computer viruses. What with the April Fool's day bomb types, the general purpose screw-up-your-programs types and the dangerous invasion of the NASA computers, all working on other kinds of machines, we CPC owners have led a charmed existence. So far none of these pesky little viruses has seen fit to infect Amstrad's finest.

Until now, that is. For your correspondent has uncovered what is possibly the most insid-

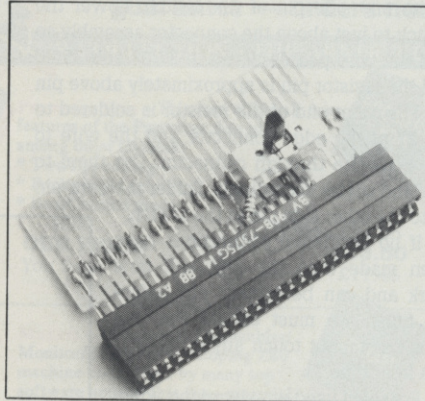

● This is what you end up with – or should do!

ious and deadly virus of them all... WARTS. This lethal menace kills all external ROMs – dead. Fortunately no virus, including WARTS, is invincible. After much brainstorming, many sleepless nights and the ed's signature on a commissions contract (*news to me -ed.*), I can announce that a 12 month subscription to *Amstrad Action* works as the perfect antidote to WARTS.

Seriously though, folks

Since most external roms allocate an area of memory for their own use, some more than others, and reduce the free memory pool, some software is prevented from running when too

many of them are attached. Often the software checks the space available and, if there isn't enough, it comes back with a pesky "Turn some ROMs off" type message. Others simply crash. Either way it becomes necessary to either switch the ROMs off or unplug the board.

Only the Microgenic board has a switch to do this. Some of the others have tiny individual switches for each ROM which are not exactly easy to flick off, especially if the board is boxed, while the rest have no switches at all.

Unplugging the board is just as inconvenient. Hence WARTS, which is clearly a tortuous acronym for "Whizzo All ROMs Toggle Switch." It allows you to turn off all external ROMs however many boards are connected –

The boards that like to say "YES!"

WARTS is known to work with the following ROMboards: Rombo, KDS, Circuit, Super Power, Micro Power, Maplins, Morrison, and Britannia. It works with the Romboard Xtra but, alas, it also knocks out the 6128 ROM. Other extinct boards will almost certainly be disabled by the switch but haven't been tested.

Parts

The two 50 way connectors, wire wrap edge and through, the 2K2 resistor, the switch and wire are available as an AA exclusive WARTS Project kit from my own Microstyle, 212 Dudley Hill Road, Bradford, W. Yorkshire, BD2 3DF ☎ 0274 636652.

The kit costs £4 including postage, packing and a whacking great profit for yours truly, oh what a giveaway. (*You won't be wanting payment for this article then, will you Craven? – a tightfisted ed.*)

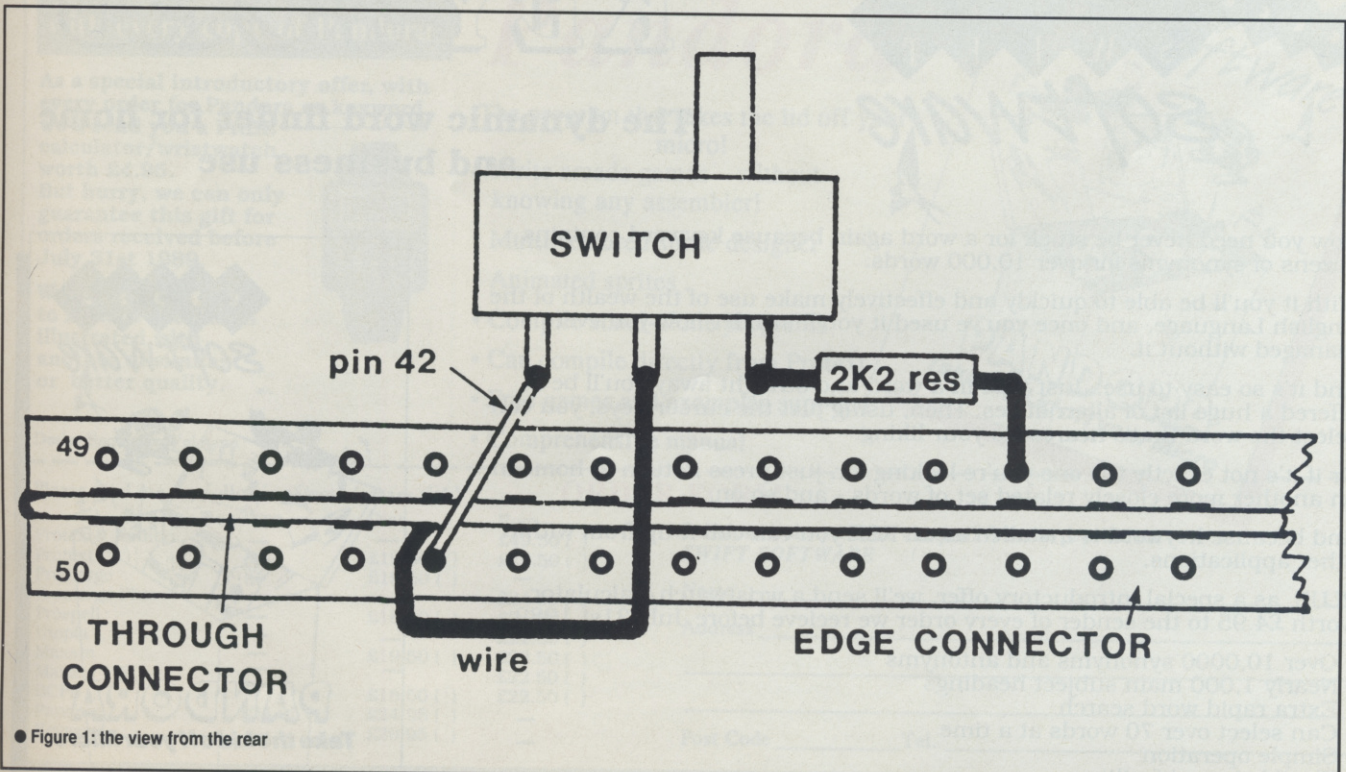

● Figure 1: the view from the rear

but it won't affect the internal system ROM. The parts cost a mere £4 and the project takes just a few minutes to make.

And this is what you do...

Whenever the CPC accesses any ROM it sends the ROMEN signal, pin 42 of the 50 way expansion connector, low. All ROMboards use this signal to determine whether or not the address and data on the buses are intended for a ROM.

If they are, then the particular ROM is enabled. It follows that no ROM can be enabled where ROMEN is not allowed to go. If we prevent it from going past the WARTS and out to any ROMboards then the external ROMs cannot be enabled.

And that's precisely what we do. ROMEN is intercepted and fed to the pole or centre of the switch while the switch position feeds it on out to the ROMboards or leaves it hanging in the air. A pull up resistor is included to improve reliability.

Making it

The 50 way edge connector has a locating key and only fits the CPC one way round. Be sure to get it the right way. In your User Instructions, chapter 7 page 40, you will find the pin connections of the expansion socket. Bend the ROMEN pin 42 of the edge connector right down flat between pins 41 and 39 so that it touches neither. Squeeze the rest of the two rows close together. Put the through connector between them, making sure that its locating 'slot' is also the right way round, and solder the rest of the edge connector's pins to it. Don't sol-

der the pin you have bent down. Leave about a 3/16" gap between the edge and through connectors.

Strip about 3/16" of the insulation from each end of the wire, solder one end to the centre pin of the switch and bend the two outer pins slightly away from the centre.

Now solder the resistor as closely as possible to one side pin of the switch. Lower the switch to just above the connector assembly so that the wire passes between 37/38 and 35/36 and the resistor pin is approximately above pin 33. The other end of the resistor is soldered to pin 27 of the edge connector and the wire to pin 42 of the through connector. Cut them to size and solder accordingly. Solder the bent pin 42 to the other side pin of the switch.

If no accidental connections have been made then the unit will now work and can be tested: but before we finish we must ensure that the bent pin cannot touch any other pins at a later time.

For this I used woodworking adhesive which I squeezed between the pins having made sure they were correctly positioned.

It has the advantage of drying rigid, and also adds to the stability of the switch. Further stability can be gained, after testing, by adding more adhesive.

Bits

ROMs reserve their memory on power up or reset and simply switching

them off does not release the memory. A reset must also be performed.

Similarly, switching them on doesn't cause them to grab what memory they need. Again it must be a reset after switching. Any ROMs that are closer to the computer than the switch will not be affected so, if you want to leave the silicon disk working, for instance, put the switch outside it.

All ROMs outside the switch will be affected and this includes the disk drive ROM in the 464's disc interface unit.

Sorry folks, it's not my fault they didn't put a through connector on it and it has to be the last one out! ●

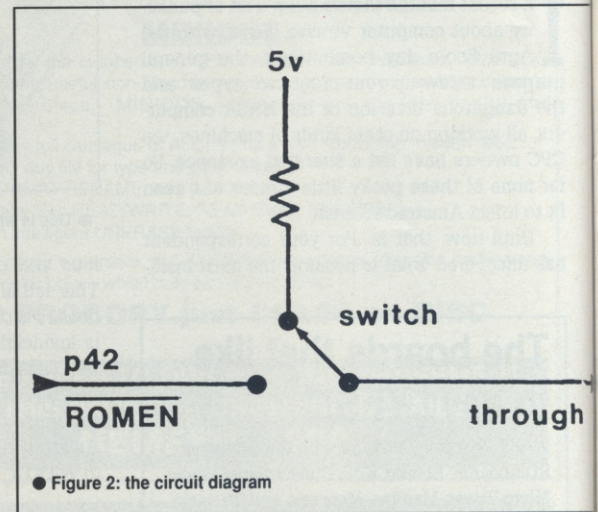

● Figure 2: the circuit diagram

Another Powerful new program from



KEYWORD

The dynamic word finder for home and business use

Now you need never be stuck for a word again because keyword contains dozens of synonyms for over 10,000 words.

With it you'll be able to quickly and effectively make use of the wealth of the English Language, and once you've used it you'll wonder how you ever managed without it.

And it's so easy to use. Just type in a word and straight away you'll be offered a huge list of alternatives. Then, using just the cursor keys, you can select the word that's nearest to your liking.

Or if it's not exactly the one you're looking for, just press Return to home in on another more closely related set of words - and so on.

And because keyword is installed as an RSX you can call it up from within other applications.

PLUS, as a special introductory offer, we'll send a wristwatch/calculator worth £4.95 to the sender of every order we receive before July 31st 1989.

- Over 10,000 synonyms and antonyms
- Nearly 1,000 main subject headings
- Extra rapid word search
- Can select over 70 words at a time
- Simple operation
- Flexible 'roam' facility
- Can be used as a Thesaurus

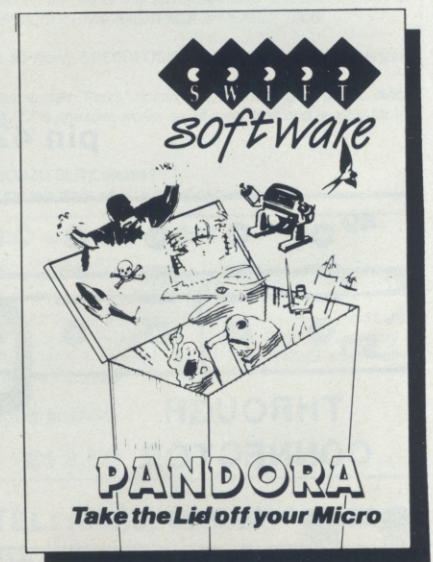

To order your copy please use the form on the right

SWIFT Software

TOP SOFTWARE AT ROCK-BOTTOM PRICES

Buy with confidence with our 10-day money back guarantee — orders normally despatched the same day

NEW LOW PRICES

THE ARNOR COLLECTION • THE ARNOR COLLECTION • THE ARNOR COLLECTION • THE ARNOR COLLECTION

PROTEXT

Protect – Without doubt the most sophisticated word processor you'll find on any home micro. Its ease of use and advanced range of features are normally only found in business systems costing many times more. Protect is the number one wordprocessor for the CPC!

RRP	Disc	£26.95	Rom	£39.95
OUR PRICE		£18.50		£28.50
You Save		£8.45		£11.45

PROMERGE Plus

Promerge Plus – This rom offers all the features of the Promerge disc plus, among other features:

- * Two file editing
- * Background printing
- * Box/Column mode

RRP	Disc	£26.95	Rom	£34.95
OUR PRICE		£18.50		£23.50
You Save		£8.45		£11.45

ROMBO & PROTEXT

- * Protect instantly accessible
- * Seven free sockets
- * Select high or low bank (allowing addition of 2nd rom box)
- * On/off switch for each rom
- * In and out expansion port sockets

RRP	OUR PRICE	SAVE
£74.90	£49.50	£25.40

PROSPELL

Prospell – With Prospell you can produce 100 per cent error-free documents, eliminating odd words and dubious spellings. You can also add words to create your own dictionary.

RRP	Disc	£24.95	Rom	£34.95
OUR PRICE		£17.50		£23.50
You Save		£7.45		£11.45

MAXAM

Maxam – The standard Assembler/Monitor/Editor for developing Z80 machine code. Used by many top software houses, this is an essential utility if you want to create machine code programs.

RRP	Disc	£26.95	Rom	£39.95
OUR PRICE		£18.50		£28.50
You Save		£8.45		£11.45

UTOPIA

Utopia – Once you have installed Utopia you won't know how you managed without it! It gives you 50 new commands – all of which are available without having to write a single program.

RRP	Disc	£24.95	Rom	£29.95
OUR PRICE		£18.50		£21.50
You Save		£6.45		£8.45

PROMERGE

Promerge – Promerge is more than just a simple mailmerger for standard letters. It includes powerful mathematical and text functions and, of course, integrates perfectly with Protect.

RRP	Disc	£24.95
OUR PRICE		£17.50
You Save		£7.45

MAXAM 1.5

Maxam 1.5 – Enhanced version of the extremely successful assembler/monitor, designed to be used from Protect. The editor has therefore been removed, leaving room for many new features.

RRP	Disc	£24.95	Rom	£29.95
OUR PRICE		£17.50		£21.50
You Save		£7.45		£8.45

BCPL

BCPL – One of the fastest, most flexible programming languages for the CPC. It is the precursor to C and has been used to write many operating systems and other major programs where speed is essential.

RRP	Disc	£24.95	Rom	£29.95
OUR PRICE		£18.50		£22.50
You Save		£6.45		£7.45

NEW • NEW • NEW • NEW • NEW • NEW • NEW • NEW • NEW • NEW • NEW • NEW • NEW • NEW • NEW

**SAVE £4.95
FREE**
with every copy of Pandora

As a special introductory offer, with every order for Pandora or keyword we'll send you a FREE calculator/wristwatch worth £4.95. But hurry, we can only guarantee this gift for orders received before July 31st 1989.



We reserve the right to replace the watch illustrated with another of similar or better quality.

Dealer Enquiries Welcome

OUT NOW! Pandora

- The program that takes the lid off your micro!
- Write arcade games – without knowing any assembler!
 - Multi-featured sprite designer
 - Animated sprites
 - Compile stand-alone programs
 - Can compile directly from Protect
 - Free games and examples supplied
 - Comprehensive manual



Please send me the following items (please tick)

	Tape	Disc	Rom
Protect& Rombo	—	—	£49.50 ()
Protect	—	£19.50 ()	£29.50 ()
Promerge	—	£19.50 ()	—
Promerge Plus	—	—	£24.50 ()
Prospell	—	£18.50 ()	£24.50 ()
Utopia	—	—	£22.50 ()
Maxam	—	£19.50 ()	£29.50 ()
Maxam 1.5	—	—	£22.50 ()
BCPL	—	£18.50 ()	£22.50 ()
Pandora	£24.95 ()	£24.95 ()	—
Keyword	—	£29.95 ()	—

ORDER FORM

I enclose a cheque/Euro cheque/PO made payable to:
SWIFT SOFTWARE

Name _____

Address _____

Post Code _____ Tel. _____

FORUM

Gather ye tips while ye may – with PAT McDONALD

Welcome once again to *Forum*, where Pat does his level best to answer your questions and pass on your hot tips on all aspects of CPC use.

● Say cheese

This program can be used in conjunction with Phillip Butler's AMX screen format creator in AA25. If you want to convert a headerless file screen picture to a standard file then this little listing does it for you. The program runs the firmware routines in memory location &BCA1 which will load the headerless file. When the picture has been loaded insert a tape, press record and play then hit any key. The pictures will be saved as standard binary files.



● AMX Mouse – rodent still going strong!

```
70 POKE &2000+a, VAL("&"a$)
80 NEXT a:CALL &2000
90 CALL &BB18
100 SPEED WRITE s:SAVE
"!picture",b,&C000,&4000
110 DATA 11,00,90
120 DATA 21,00,C0
130 DATA 11,00,40
140 DATA 3E,16,CD
150 DATA A1,BC,C9
```

Troy Krajancic, New Zealand

Excellent, Troy – here, have a tenner!

```
1 'Headerless Screen file converter
2 ' By Troy Krajancic
3 ' Amstrad Action August 1989
10 CLS: INPUT "Mode";m
20 INPUT "Speed Write";s
30 IF s<0 OR s>1 THEN 20
40 FOR a=1 TO 15
50 MODE m
60 READ a$
```

● Amcharge – now the truth can be told

You are confused about the Amcharge program at the end of *Wec Le Mans*? Here is your answer for you! The online service Minitel (it is French, something like your Prestel) offers users the chance to buy software over the telephone. You need a Minitel terminal, a cable, a CPC and the Amcharge e program.

You dial Minitel and enter 3615 AMSTRAD. From here you can get information, tips etc on the CPC, and also the chance to load up, play and if you like perhaps buy software. It is cheap too, I think: about £4 for Arkanoid 2, plus the online time.

Pascal Brocat, Southampton

Thank you Pascal, and also the others who explained what the mysterious program was



● Minitel, one of the great European inventions

from *Forum*, AA46. For those who haven't heard of Minitel, it's a videotex system from Telecom France, and there are almost five million of them in homes and offices throughout that beautiful country.

It's a pity that we don't get Minitel over here, though what with the Channel tunnel, 1992 and all that we may not have to wait too much longer. Indeed, I understand that Kays International Teleservices (you know, Kays the home shopping catalogue people) has just been introduced to Belgium, and is now being offered, via Minitel, in France. It

would appear that all the European advances are being made on the other side of the water.

Isn't it about time that we on this side grew up a bit?

● Foresight saga

I own a 464 which I use with a DDI-1 disk drive and printer. *Mini Office I* and *Easi-Amword* have similar difficulties running with this setup, all I get is the following error messages:–

Rewind the tape and try again: your computer has incorrect value of HIMEM (Word processor)

Drive A: Disk missing (Spreadsheet)

Easi-Amword loads OK, but on attempting to save a file to disk the program comes up with:–

Fault in Line 990

The programs work fine with the disk drive turned off, but I would prefer them to be disk compatible.

A.J. Kirk, Stevanage

It's a case of redundancy, I'm sorry to say. Those programs were written before disk drives were readily available, and due to lack of foresight they just won't work with a disk. Unfortunately such programs are still available today: so buyers beware! Of course, if there are any friendly people out there who know how to get said programs working, then let me know.

● Hard software problem

I want to sell some of my old software. I wrote to a firm called Crazy Joe's, who wrote back saying that due to some problems they had decided to stop dealing in secondhand software. Where can I sell it?

J Exell, Portsmouth

I'm not surprised that Crazy Joe's had problems – I certainly wouldn't like to sell 100,000 copies of Roland Goes Somewhere Completely Different.

A jolly good question, though, and by no means an easy one to answer...

When I sold some hardware to a computer shop for them to flog off as a secondhand



● Poor J. Exell of Portsmouth – up to his neck in old software which no-one seems willing to risk buying from him!

machine, they wouldn't touch my software collection. Apparently there is lots of confusion at present, because some software (mainly commercial business packages) are licensed to run on only one computer system. Nobody is terribly sure of the resale rights of software purchases.

It is to be hoped that the planned reforms of law on copyright make clear the situation on software and include this information. The big problem with secondhand software is that it's virtually worthless, due to the huge numbers of pirate copies available.

Given that that's the case, how about knocking up a few Brownie points by taking it down to your local Oxfam? They're running a big effort to sell software, and you know it's going to a good cause.

● No pleasing all the people

Your Typewriter checksum program seems to work very well, but I have one major moan to make about it: it's too accurate! If a line has an extra embedded space in it, then the checksum will be wrong. For instance:-

100 This line has an extra space {ArBj}
100 This line has an extra space {IrBi}

The second line does not have an extra space, and the checksum is different! I don't want to sound too critical - it's a big help. But there are going to be lots of people driven mad trying to find out what they're typing wrong!

One more thing: can you please try and avoid using the character 1 in listings, and similar easily mistaken characters? It's very hard work for us old codgers.

AA Cooper, Lisburn

I take your point, but of course the purpose of Typewriter is to give people an indication of any typing errors. Listings don't have to be exactly the same as in the magazine to RUN. The idea is that if you get a dodgy line and the program doesn't work, then you'll know exactly where the problem is.

As for the mistaken characters, we do ask people not to use them. Unfortunately if they do then it's more than a little time consuming to change them all and then debug the program. I try only to include such programs if they have something special to offer.

● Advanced?

I have a 464 with a memory upgrade plus a DDI-1 disk drive. I also have an external ROM board with the 6128 ROM fitted. I have purchased the Advanced Art Studio from your Mail Order service. With the 6128 ROM fitted it loads OK but crashes after a few minutes, and without the ROM it crashes even sooner. I gradually get less and less into the program before it crashes, and eventually it can't get past the security screen.

A friend of mine checked the disk on her 6128 and found it to be fine. I've tried changing the position of my drive and using the keyboard instead of a joystick. Neither have any effect.

Do I have too many connections to the drive port (the ROM board, the disk drive and the



● Advanced Art Studio - giving one user headaches

memory upgrade)? Or does the program need to run under CPM+?

A Gilson, St Albans

It does sound to me as though you have too many connectors on the user port. You don't really need the ROM board connected, so I suggest that you disconnect it and try it then - the program doesn't need a 6128 ROM in order to work.

Failing that, there's probably a fault somewhere inside your CPC. To repair it try, for instance, VSE Technical Services on 01 737 0234.

● Wobbly turn off

My computer has developed two faults. When you press record and play together, the computer switches off - it sometimes does this while loading games. Also, the screen wobbles rather badly. I have fitted an anti-surge plug to try and cure these, but to no avail.

Can you tell me what's the best Centronics interface available for the CPCs? I want to connect mine to a Olympia Carrera typewriter.

Jonathan Stewart, Dundee

You most likely have a loose connection inside your computer if it's physically switching off. The wobble is probably just the horizontal or vertical hold being slightly wrong. But I suggest you talk to VSE (01 737 0234) anyway. (Incidentally, we mention VSE as repair specialists for the CPC because we hear good things about them. We welcome recommendations - and warnings! - about repair people you've come into contact with.)

As to your final question: your computer's already got a Centronics interface! It's on the back, labelled printer port. I'm assuming here that you want to use the typewriter exactly as you'd use a printer. What you want is a cable to connect it to the typewriter. I suggest you take the manuals for the two machines into an electronics shop, and ask them to build one.

Alternatively you can buy ready made up cables from places like Dixons or John Menzies. When it's built, either mask off or cut pin 14, to prevent extra line feeds chopping up your printing.



● (Not) labour saving - update

Thanks for publishing my problem in AA46 ("(Not) labour saving"). I think I've isolated some of the knottier points, which is why I'm writing this. Basically, SuperCalc2 and DR Graph work quite well together except for the following points.

- You can use INTDIR on your disks (both system and data files) without much trouble. Date-stamping may be needed on data files to keep track of a series of DR Graph/SuperCalc2 for security reasons. But both of these were made in the heady days of CPM 2.2, and the SuperCalc2 system data interchange (SDI.COM) cannot handle date-stamped files without the unpleasant possibility of corrupting them.
- PIP.COM itself subtly corrupts filenames and filetypes (seen on the filetypes more readily than on the filename part of the directory label) shown by a disfigured letter.

■ Ample samples for DJ Bpm

I am at present trying to get started as a club DJ. I spend most of my time locked away in my room with my two turntables and mixer, mixing it up to the early hours of the morning (much to the annoyance of my neighbours).

I have longed to own a mixer with a built in sampler, but for one with a four second sample rate an £800 price tag comes free! Then I saw an advert in AA46 for the Ram Music Machine by Datel Electronics.

Is this the answer to my dreams? Will the sampler allow:-

- Sampling from a record via a mixer, and then playback using one of the Amstrad's buttons while the record is still playing?
- Can the other facilities - echo chamber, drum machine and so on - be used without the use of a Midi keyboard?
- Are there any other software packages that might be worth considering? Perhaps allowing a little longer sampling time?

I own a 464 plus colour monitor.

Bpm, Shepherds Bush

Well, it's all certainly possible with the Music Machine. Rather than sampling live, you'd have to prepare your samples earlier and load them in for each record - this would allow you to get the quality up to its best. Even the best isn't great though: a filter to suppress the hiss on samples would be a sound idea.

As for other bits of software, the Micro Music Creator does virtually the same job, but contains no hardware. On tape it's available for £9.95 from First Byte Software (0225 765086: take a look at the advert they've been running).

Best of luck experimenting, and let us know how it goes.

DISCOUNT SOFTWARE



from M.J.C. SUPPLIES

DISC GAMES

Chicago 30's	12.95
Colossus 4 Chess	11.95
Corruption	15.95
Crazy Cars II	11.95
Dark Side	11.95
Dark Fusion	12.95
Driller	14.95
F15 Strike Eagle	11.95
Flight Ace	13.95
Forgotten Worlds	12.95
Game Set and Match II	13.95
Gunship	14.95
H.A.T.E.	11.95
Emlyn Hughes International Soccer	11.95
Lancelot	15.95
Monopoly	11.95
Microprose Soccer	15.95
Nightraider	11.95
Operation Wolf	11.95
Pacland	11.95
Pirates	14.95
Renegade 3	11.95
Real Ghostbusters	11.95
Robocop	11.95
Run The Gauntlet	12.95
Scrabble Deluxe	12.95
Storm Lords	14.95
Six Pack III	11.95
Superman	11.95
Supreme Challenge	12.95
Time and Magik	11.95
Times of Lore	11.95
Titan	11.95
Total Eclipse	11.95
Tank Attack	11.95
Vindicators "Domark"	12.95
War in Middle Earth	11.95
WEC Le Mans	11.95
Wanderer 3D	11.95
Chuck Yeager AFT	11.95

MJC SPECIAL:

3D Pool
RRP 14.95 OURS 9.95
OFFER ENDS 31st JULY

EDUCATION

Animal Veg, Mineral	11.95
Answerback Junior Quiz	11.95
Factfile Arithmetic	7.95
Factfile Spelling	7.95
Factfile Sports	7.95
Fun School for 2-5 years	7.95
Fun School for 5-8 years	7.95
Fun School for 8-12	7.95
Fun School 2 for under 6 yrs	9.95
Fun School 2 for 6-8 yrs	9.95
Fun School 2 for over 8 yrs	9.95
World Wise	11.95
German Master (12 to adult)	14.95
French Mistress (12 to adult)	14.95
Spanish Tutor (12 to adult)	14.95

Note: Factfiles are question packs only and require the Answerback Junior Quiz.

DISC SERIOUS

Protex	18.95
Prospell	17.95
Promerge	17.95
Arnor File	18.95
Arnor Office Suite	26.95
Tasword 6128	19.50
Taspell	12.95
Tasprint	10.95
Tascopy	10.95
Tasdiary	10.95
Tassign 6128	23.95
Qualitas Plus	12.95
Qualitas Pica Font Pack	8.95
Qualitas Clarion Font Pack	8.95
Qualitas Newsroom Font Pack	8.95
Qualitas CPM + Utilities Disk	8.95
French Mistress	16.95
German Master	16.95
Spanish Tutor	16.95
Masterfile III Database	29.95
Mastercalc 128	25.95
Matrix Spreadsheet Plus	29.95
Stop Press Desktop Publishing	38.95
Extra Extra	19.95
Maxam (Assembler/Diss)	18.95
Poke Easy Plus	14.95
Mini Office II	15.95
Rodos Extra Disk	8.95
Advanced Art Studio	19.95

CPM BASED

At Last Plus	29.95
Supercalc 2	44.95
Arnor C Compiler	39.95
Maxam II	39.95
Fortran	39.95
Nevada Cobol	39.95
Hisoft Devpac 80	39.95
Hisoft Pascal 80	39.95
Hisoft C Compiler	39.95
lankey 2 Finger Typing	19.95
lankey Crash Course	19.95

MJC SPECIAL

Protex CPM: including
Spellchecker & Mailmerge
RRP £59.95 OURS £41.95

CASSETTE BASED

Maxam 464	15.95
Protex 464	15.95
Tasword 464	15.95
Answerback JNR Quiz	8.95
Italian Tutor	14.95

**ALL ABOVE PRICES INCLUDE VAT, POSTAGE & PACKING IN THE U.K.
THE ABOVE SOFTWARE IS ONLY FOR THE AMSTRAD CPC RANGE**

ACCESSORIES

Multiface II Plus	42.95
Printer Lead 1M	8.95
Printer Lead 1.5M	9.95
Printer Lead 2.0M	10.95
3" Disc Cleaner	6.95
Amstrad R232 Interface	55.95
Mono Screen filter	12.95
Colour Screen Filter	14.95
Comp Pro 5000 joystick	13.95
Quickshot Turbo joystick	11.95
Cruiser joystick	9.95
464 Monitor ext Leads	6.95
6128 Monitor ext Leads	7.95
1000 Fanfold Labels	5.95
Second Drive Lead	7.95
AMX Mouse + Art Software	59.95
AMX Mouse + Stop Press	69.95
464 Dust Cover (mono/col)	7.95
6128 Dust Cover (mono/col)	7.95
KDS 5 1/4" 800K disc drive (state 464/6128)	159.95
KDS 8 Bit Print Port	18.95
DK64 Memories Expansion	45.95

RIBBONS

Printer	Quantity	
	1	2 5
DMP 2000/2160	3.50	6.00 14.00
Panasonic 1080/1081	3.95	7.00 16.00
Citizen 120D	3.95	7.00 15.00
Star LC10 (Black)	3.95	7.00 15.00
Micro-P165/200	4.95	8.00 18.00
Star LC10 Colour	5.95	11.00 -
CF2 Disc (Amsoft/Maxell)		10
PLEASE CALL FOR AVAILABILITY		for £25.95

BOOKS/MANUALS

Adv Amstrad Graphics	7.95
Mastering Machine Code	8.95
The Amstrad CPM + Book	12.95
Programming the Z80	19.95

ROM BASED

Protex	28.95
Prospell	23.95
Promerge +	23.95
Maxam	28.95
Maxam 1.5	21.95
Utopia	21.95
BCPL	22.95
Rodos	28.95
Cage Rom (state which I/Face)	31.95
Rombo (if purchased with Rom)	28.95
KDS Rom Board (Holds 6)	24.95

Quali Pack

The Print Enhancement Package
Qualitas Plus, KDS 8 Bit Port
Display Font Pack
R.R.P £44.45
Package Price £34.95

Quali Pack Extra

Plus Clarion, Pica, Newsroom, Font Packs,
R.R.P £54.95
Package Price £44.50

CORNIX SOFTWARE

CARD INDEX: Easy to use filing system
CASS: 19.95
DISC: 24.95

SIMPLE ACCOUNTS: easy to use accounts ideal for small business includes VAT. **CASS:** 34.95
DISC: 39.95

JOB ESTIMATOR: useful tool for contractors. **DISC:** 39.95

PRODUCT COSTING: DISC: 39.95 Full specifications on all of the above programs on request.

PRINTERS

All printers listed have a ten inch (A4) carriage, are Epson compatible, and feature friction and tractor feed mechanisms for continuous or single sheet paper. All prices include the necessary cable

PANASONIC KXP - 1081

Offers all the draft mode text sizes of the D.M.P. 2160, but is better built, more reliable, and offers N.L.Q. in all sizes and effects, for only £10.00 extra! Highly recommended.
£169.95

STAR LC-10

As well built and reliable as the Panasonic. Has four N.L.Q. fonts (typefaces), in combination with all sizes and effects. New low prices makes it well worth considering
£195.95

STAR LC-10 COLOUR

All the features of the LC-10, but with a seven colour option for colourful text. If you want colour graphics please call first for advice.
£245.95

STAR LC 24-10

24 pin version of the LC-10. Has 5 excellent letter quality fonts available with all sizes and effects. Two extra effect, outline and shadow are also featured. Good value.
£339.95

Overseas Orders Welcome - Please write for details

WE ARE NOW IN OUR FIFTH YEAR OF SPECIALISING IN AMSTRAD MAIL ORDER, OUR POLICY IS TO PROVIDE THE WIDEST RANGE AT DISCOUNT PRICES WITH A FAST TURN AROUND TIME - TRY OUR SERVICES WITH CONFIDENCE

CALLERS WELCOME: Mon-Fri 9 to 5 Sat 10 to 4

PLEASE SEND CHEQUES/POs TO:

M.J.C SUPPLIES, (AA)

40a Queen Street, Hitchin, Herts. SG4 9TS.

Tel: (0462) 32897/420847 or 421415 for enquiries/Credit Card orders

Proprietor M J Cooper



This is what happened in my case – and *DR Graph* refused the *SDI.COM* imported data as a result.

Therefore, the only answer with a) is to simply not date-stamp any of the *DR Graph/SuperCalc2* files at all, or at least use separate date-stamped disks if it's imperative to have security backups.

The snag is, you are only allowed to make three copies from your *SuperCalc2* disk, using the command **SUBMIT MAKE6128**, and don't **PIP** the disk contents over to another disk. (No, I didn't **PIP** the *SuperCalc2* data in quite that way, but it's surprising how many people do!). After that, you're on your own.

With regard to b) if **PIP.COM** itself is corrupting data/system files, then the only answer (you'll love this...) is to remove all **PIP.COM** and separate files from disks after inspection.

Then replace them with good copies taken from the CPM+ master disk. The problems are then – hopefully – cured. Unless, of course, your readers know otherwise...

James Haswell, Camberley

Thanks Mr Haswell. Well, at least you got it sorted – eventually! Why is doing something

●Cut'n'paste

Before I started writing in machine code, when I tried to copy a screen and save it in another part of the memory for later redisplay, the routine took about 25 seconds.

This was because I kept on poking the values of the inks pixel by pixel.

Below is the machine code effort. It sets up two RSXs: **|COPY** and **|PLACE**.

```

10 REM Copy and Restore Screen
20 REM By Andrew Price
25 REM Amstrad Action August 1989
30 PRINT "|COPY TO COPY SCREEN"
40 PRINT "|PLACE TO POP IT BACK UP"
50 FOR addr=&BE00 TO &BE31
60 READ pok$:pok=VAL("&"+POK$)
70 POKE addr,pok:NEXT
80 CALL &BE00
90 REM Machine Code Data
100 DATA 00,01,0B,BE,21
110 DATA 13,BE,CD,D1,BC
120 DATA C9,17,BE,C3,21
130 DATA BE,C3,29,BE,00
140 DATA 00,00,00,43,4F
150 DATA 50,D9,50,4C,41
160 DATA 43,C5,00,00,3E
170 DATA 40,CD,06,BC,00
180 DATA C9,CD,14,BC,3E
190 DATA C0,CD,06,BC,C9

```

Andrew Price, Dunstable

Thank you for that, Andrew. I'm sure many readers will find it useful.

relatively simple but slightly non-standard in computing always so dashed complicated?

●Nearly Last Question?

I have just recently purchased an Amstrad 6128, and am really interested in getting a printer for it. I noticed that in the March edition of *AA* that you compared two printers. One thing puzzles me: what does NLQ mean? Also, what word processor and combined database would you recommend?

Ian McCallum, Saltgate



● Yes yes, I know it's a printer – but what does "NLQ" stand for?

NLQ stands for Near Letter Quality – that is, the best type that the printer can produce, suitable for correspondence. As for printers, word processors and so on, have a good read of the Buyers Guide on page 75.

●Bug squasher

Help is at hand for RJ Stevens (*Forum*, AA45)! He says that there's a bug in the printer dump for CRL's *Image System*: Indeed there is but it can be easily rectified.

If **PDUMP** has been loaded into memory using **LOAD**, then **LIST** the program. The problem is on line 60. It needs to be edited so that it only consists of data as follows:

```
60 DATA 1,2,3,4,5,6,7,8,9,10,12,13,14,15
```

Then enter the following lines.

```
61 DIM k%(15)
62 DIM tone%(16,4)
63 RESTORE 50
```

Then save the modified program and it should work. When the program is run, you enter the required filename and the required picture is loaded

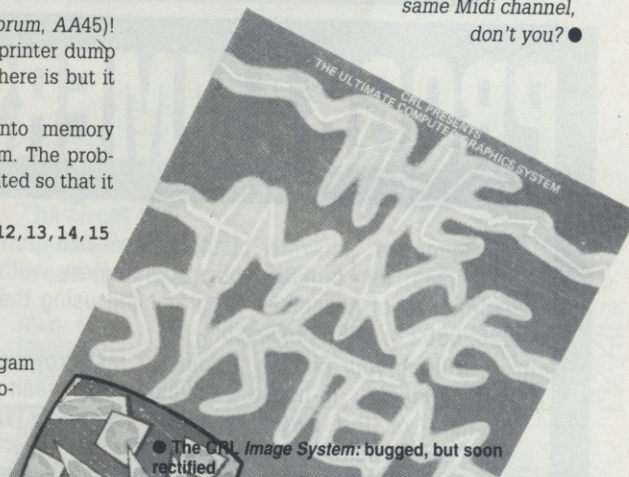

● The CRL *Image System*: bugged, but soon rectified.

●Quick filler

If you own a 664 or 6128, and want to use the fast **FILL** command of *Amsdos* in the *Smart 2* art program, type in the following few commands:–

```
LOAD "SMRTPROG"
1180 FILL pe
DELETE 1190-1260
SAVE "SMRTPROG"
```

Torben Jensen, Denmark

Nice one Torben – a real time saver!

onto the screen.

If the colours are completely different from what you expected, don't panic. The end result is not affected: it takes about 20 minutes.

Anyone wanting more information on the *Image System* should write to: CRL Group PLC, CRL House, 9 Kings Yard, Carpenters Road, London E15 2HD.

Now for a question of my own. Is the *RAM Music Machine* Midi compatible with the *Yamaha DD-10* drum machine? I have followed instructions for both the *Music Machine* and *DD-10* but I still can't get any joy.

S.D. Green, Woking

Thanks for the solution to the printer problem. Can any valiant reader tell the truth about the Midi connection?

I've got most things working together – including a *Yamaha* drum machine. You do have the interface and *DD-10* talking on the same Midi channel, don't you? ●

£40 if you honour our offer!

Forum is designed to do the jobs previously done by *Words Work*, *Hot Tips* and *Problem Attic*, which always overlapped to some extent anyway. It will be as big as you want it to be – depending on your reaction and the number and quality of letters we receive.

To encourage you we're giving away £40 each and every month to the writers of the hottest tips and the best questions. So if you have a problem, or a solution, get it in writing now. Send it to: *Forum*, AA, 4 Queen St, Bath BA1 1EJ.

We're very sorry but we simply haven't the time to reply personally to your letters: so no SAEs please!



Guns: cool?

Microprose's *Gunship* is one heck of a simulation (AA40, 82%). But there's much more to it than flying about in an Apache attack helicopter, as STEVE CAREY discovers...

Playing *Gunship* is like watching boxing: pleasure is compromised by guilt. After all, it's only a computer simulation, and no-one suffers. But then, the AH-64A would never have been developed in a truly peaceful world. And as Pat pointed out when he reviewed it back in October, the ghost of Vietnam wanders through this training in violence, despite its total absence from the manual (and indeed from the book).

There is an introductory chapter in jerky, American journalese on the development and design of the AH-64A Apache, the result of a dogfight between Bell and Hughes (as in Howard, legendary nutcase). On September 30, 1975 the Hughes YAH-64 flew for the first time; the Bell YAH-63 made its maiden flight the following day. By December the army had chosen the Hughes design, and there only

remained the squabbling between Jimmy Carter and Congress over the extent of funding for the next stage of development, eventually settled at \$165 million. In April 1982 approval was given for full-scale production.

So much for historical fact. Sheffield, having set up the machine, is now cleared for flight. And fly he does, constantly blurring the distinction between a real-life, full-size weapon of war and its simulated computer counterpart. His introduction to a chapter devoted to "Ten Rules to Live By," for instance, begins with a disconcerting account of the posthumous award of a Distinguished Service Cross to one Warrant Officer Buzzsaw "for extraordinary heroism in connection with military operations involving an armed Soviet force near the East German border." Huh? Relax, it's only Sheffield exercising his fertile martial imagination. Still, the rules themselves - "Avoid Target Area Overflight," "Always Positively Identify Targets Before Attack" - should get you through.

Finally, here's a heartstopping sample tip from Sheffield on losing altitude quickly to avoid enemy fire: "Shut down both engines,

leaving the rotor engaged. With no lift being generated, you'll fall like a stone. Once you pass through 150 feet, start the engines again, and you should bottom out at about 80 feet." I tell you, there are times when you're playing *Gunship* you are glad it's only a simulation!

It doesn't occur to Sheffield that there might be an argument about the ethics of *Gunship*. But then, it's only a game, isn't it? ●

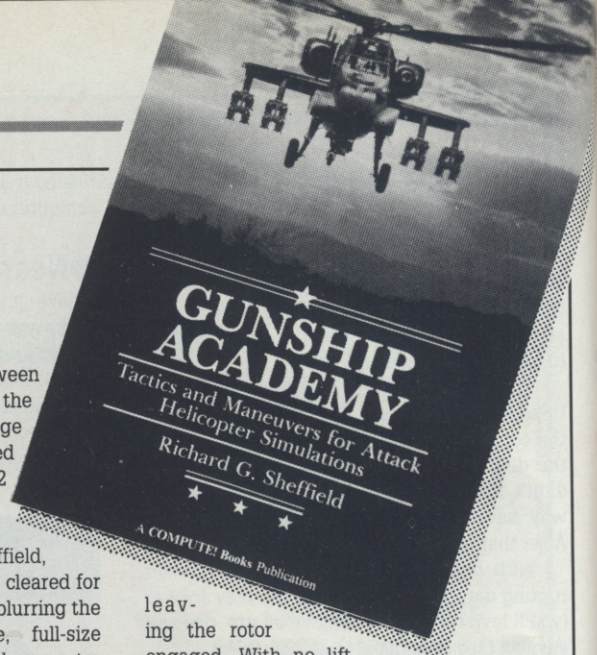

Gunship Academy: Tips and Maneuvers for Attack Helicopter Simulations, by Richard G. Sheffield. Published by Compute! 1988; ISBN 0-87455-153-6. Available from Computer Manuals Ltd (☎ 021 706 6000) at £12.95.

PROGRAMMERS

Incentive Software Limited have two new vacancies for professional programmers with experience of assembler programming using the Z80, 6502 or 8086 processors.

This is your chance to join our fast growing and friendly in-house development team, creators of the award winning **FREESCAPE®** Solid 3D System, to work on exciting new entertainment, demonstration and television software projects.

The successful applicants will enjoy an excellent salary with bonuses and other benefits.

Incentive Software Limited has been established for 6 years now and is committed to innovation, originality and quality.

Please send details of your experience and/or CV to:-

Ian Andrew, Managing Director,
Incentive Software Ltd, Zephyr One,
Calleva Park, Aldermaston, Berks. RG7 4QW.
Telephone: (0734) 817288.

incentive
SOFTWARE LTD

STRATEGY SOFTWARE

Strategy games for the Amstrad CPC

THE FINAL CONFLICT - the game is a conflict between Nato and the Warsaw Pact in Europe. Options are either two player or solitaire against the computer, 25 different countries involved, over 160 units, infantry, corps, parachute, armoured, cities helicopters, different strengths, effects, supplies, fuel, casualties status, different seasons, city production levels, millions of troops involved, game lasts for weeks, save game, 18 page manual plus more.

SOCCER 6128 - football programme, fixtures, opposition, play match, instructions, league table, accounts, playing staff, save game, 10 different positions, skill, form, goal scorers, injuries, up to 20 players in squad, sacking, over 2000 players, 80 English clubs, 60 European clubs, FA Cup, League Cup, European Cup, UEFA Cup, Cup Winners Cup plus much more. Reviewed in AMSTRAD ACTION July '88. (For 6128 only, on disk only).

KURSK the clash of armour - was the biggest tank battle of WW2 in which the Germans had to beat the Soviet army to stand any chance of winning the war. The options are two player or solitaire against the computer. There are over 125 units which are infantry, armoured, corps, artillery, anti tank plus cities which all have different effects in combat. There are also supplies like troops, provisions and fuel. The object of the game is to capture the key cities or destroy enemy units. Also save game plus much more.

SOFTWARE HIRE CLUB - we hire out top game titles of strategy and simulation games for the Amstrad CPC. Send a large S.A.E for details.

Title	disk	tape
THE FINAL CONFLICT	£8.00	£7.00
SOCCER 6128	£8.00	£7.00
KURSK the clash of armour	£8.00	£7.00

Cheques or Postal orders Payable to **STRATEGY SOFTWARE**
Send to - **STRATEGY SOFTWARE, 32 Albert Street, Seaham, Co Durham SR7 7LJ.**

COMPUTER SALE

464's from £119.00
Kirk modems £69.00
Speech Synthesizers (SSA1) £14.95
Serial Interfaces (RS232C) 464,664, 6128 £39.95
1512 (SDMM) £325.00
1512 (DDMM) £425.00

Software Bargains

Pack One - 5 games Scrabble, Cluedo, Scalextric, Trivial Pursuits, Monopoly etc. £2.00
Pack 2 - 10 games £3.50 Pack 3 - 20 games £6.00

Many other bargains in stock

Prices include VAT. Add £1.50 P&P. Cheques, PO's, Access or Visa

RDS Ltd
157-161 Kingston Road,
Portsmouth
(0705) 812478

Techno Trade
167 West Street
Fareham, Hampshire
(0329) 234199



COMPUTER SHOPPER SHOW '89



NOVEMBER 24 - 26, ALEXANDRA PALACE

THE ULTIMATE VENUE
FOR A SHOPPING SPREE

Enter the brand new Computer Shopper Show – the world's largest shopping spree for you, the computer user.

The first Christmas event to embrace all popular machine formats, it will boast 250 stands, transforming London's Alexandra Palace for three days in November into the ultimate hypermarket offering computer products.

Though designed in part to replace such established seasonal computer events as the Amstrad Computer Show, the Atari Christmas Show and The Micro User Show – the Computer Shopper Show will offer much more.

Whether you are a long time Spectrum owner or a new PC user, you'll find everything you are looking for under one roof. The choice has never been greater – nor will be the number of special offers.

There's only one show for computer users in the run up to the festive season – the Computer Shopper Show. Order your tickets today by returning the coupon with your payment or telephone 051-357 2961 for credit card bookings.

The Great Hall,
Alexandra Palace,
Wood Green, London N22

10am - 6pm Friday, November 24
10am - 6pm Saturday, November 25
10am - 4pm Sunday, November 26

Sponsored by
Computer Shopper

Organised by
DATABASE EXHIBITIONS

Please supply:

- Adult tickets at £3 (save £1)..... £.....
- Under 16s tickets at £2 (save £1)..... £.....
- Family tickets at £9 (save £5) £.....

Total £.....

- Cheque payable to Database Exhibitions
- Please debit my Access/Visa card no.

Expiry date: _____ / _____

Admission at door: £4 (adults) Advance ticket orders must be received by £3 (under 16s) Wednesday, November 15

Name.....

Address.....

Postcode Signed

PHONE ORDERS: RING Show Hotline: 051-357 2961
PRESTEL ORDERS: KEY *89, THEN 614568383
MICROLINK: 72:MAG001

Please quote credit card number and full address

POST TO: Computer Shopper Show Tickets, Database Exhibitions,
PO Box 2, Ellesmere Port, South Wirral L65 3EA.

THE LOOK

More fun in pixel land with PAT McDONALD (for it is he)

Last month, as no doubt you recall, we went over the operations of *Symbolizer*, Shabaz Yousaf's excellent *Type-In* for altering the inbuilt CPC character set.

Now let's take a look what sort of program is needed to store and print out character modules wherever you may need them, and also some of the principles behind game backgrounds.



● *Saboteur* – large playing area, but not a great deal of colour.

The first thing to remember about modules (which are collections of characters redefined to taste) is to avoid thinking of them in terms of grids. A better way is first to decide on a maximum width for the module. If you store the characters as one long list, the computer can quite happily chop out the correct widths and arrange them in vertical order.

The CPC is happier keeping track of one list of data with a width at the beginning than trying to remember grids. One further pitfall of using grids is that you must specify the length along both axes, therefore using up – slightly – more memory.

It's worth going over some of the fundamental mathematics of printing characters. If each character is in the normal range of 0-255, and if no module is wider than 255 characters then 10K of memory can hold up to 21 mode 0 screens (albeit in two colours only) or approximately 5 mode 2 screens.

Think of it like this: a mode 0 screen measures just 20 X 25 characters, or 500 bytes

worth of data. A mode 2 screen is 80 X 25 characters, or 2000 bytes of information.

Memory munching

Two colours isn't really a lot for mode 0, though – after all, it does have 16. How can this be remedied? The best way is to create each individual object that you're making out of several different coloured modules. The amount of information needed to store the colour of each module is one byte (a choice of 16 colours for foreground, 16 for background = 16 X 16 = 256).

Alternatively you could store a colour indicator for each individual character used in a module. The problem with this approach is that each module is twice as big as it should be, because the extra colour information takes up exactly the same size as the module data. And that's why I advocate the first approach, as used in games like *Saboteur* and *Thanatos*.

One more possibility that doesn't make too great a demand on memory is to use one more

THE GALLERY



● Fancy yourself as an artist? Then get cracking! Let us have your very best work at the AA office, and you could earn yourself £20! Send entries – together with a short note telling us which art package you used, and an SAE if you want the pictures back – on disk or tape to:

Pat McDonald's *The Look*
Amstrad Action
Future Publishing
4 Queen St
Bath BA1 1EJ



● Simon Fitcher from *Crash* is sure knows how to use *Smart 2*

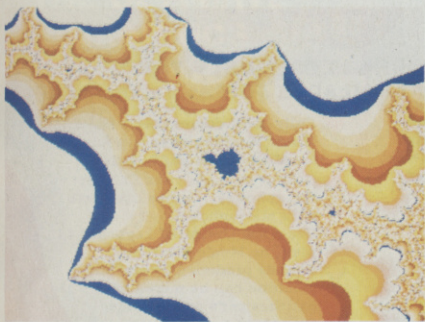

● The immensely irrational Mandelbrot set

byte at the beginning of module data for printing effects. That is, if the first bit of the effect byte is set, it would indicate to the printing program to switch to XOR, AND or similar effects. You can then overlay modules on top of one another, creating diverse different onscreen variations.

This overcomes one of the handicaps of character modules – screens tend to look very similar to each other, which in some games is tolerable and sometimes not.

Background theory

There are three different ways to store the data for a program's background screens. The first is simply to store it, in unmodified form, as a series of 20 X 25 'rooms.' As a rule (as mentioned above) around 20 or so screens can be stored by using this method, which is why

games like *Manic Miner* had only 20 screens.

The second way is more complex, and is also mentioned above. By storing the onscreen co-ordinates of various modules, and changing the colours/printing arrangements, an area perhaps 50 or more times as large as the screen is possible (by incorporating scrolling routines into the game, a player can move the screen window over the whole playing area). ●

● Next month in *The Look* we examine 'Chaos' programming in more depth. Plus the AA Module Designer. Miss it at your peril!

Elementary

It wouldn't take a Sherlock Holmes to deduce that the AA Sprites animation routines have so far singularly failed to put in an appearance. The reason? Elementary my dear Whatsize: their bigness (and don't believe anyone who says size doesn't matter). It has been estimated that they'd take up approximately, er, loads of pages if we just printed them.

So we're going one better. Look out for them on the next cover tape – coming soon! – and save yourself hours and hours *and hours* of laborious typing...

It's utter chaos round here, it really is...

The third modus operandi places more of a strain on the programmer than the other methods, but is superior in terms of storage areas.

Rather than storing simple co-ordinates of where modules should go, equations are written to 'decide' where all the different modules should go. The processor takes all of these equations and applies them to the screen area, 'placing' the graphics.

This is a 'random' area designer, and so is most suitable for games where the playing area is a jungle or a wilderness. Alien environments are also good vehicles for this method, as they're supposed to look wacky.

Sounds complicated? There's a good reason for that. The main advantage of using 'Chaos' programming to position blocks of characters is that it can incorporate an area as big or as small as you want. Two byte co-ordinates per object gives 65536 X 65536 area in character terms – or over 4 million screens!

Just try and imagine the playing areas if four or five bytes per co-ordinate per module type. By incorporating equations to cover different climates, it is theoretically possible to model an entire planet inside a CPC!



● This is another from Simon – the art package was actually a Type-In in AA16

● Queenie, right, by M.S. Browning of Blackpool, uses CRL's Image System. Nice one, your Majesty!

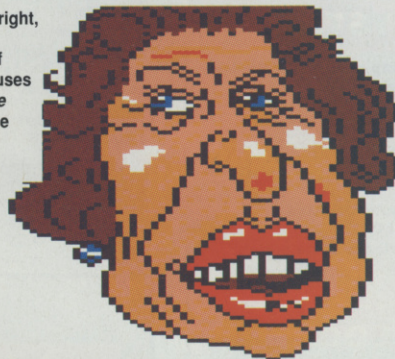

● Aubrey Berwick of Liss sent a whole disk full of pictures drawn with *Advanced Art Studio*. Left: his winning entry. Below: his perspective landscape. £20 is on its way, Mr B!



● James Davidson from Glasgow has been featured before. But no more Garfields, OK? Even if you do write your own art programs

DATEL ELECTRONICS

MIDI COMPATIBLE

music machine

THE RAM MUSIC MACHINE IS PROBABLY THE MOST EXCITING MUSIC ADD-ON AVAILABLE FOR ANY COMPUTER.

- ▼ It's a full sound sampling system allowing any sound to be recorded digitally into computer RAM. Once stored the sound can be replayed at different pitches with many varying effects.
- ▼ It's an echo chamber & digital delay line. Create very interesting effects.
- ▼ Various sampled sounds are provided to get you going.
- ▼ The Music Machine can be used as a drum machine - eight drum sounds are provided, but you can easily produce more of your own.
- ▼ The powerful software allows you to compose tunes from individual bars of music. You can edit on screen & Save/Load sounds, instruments & rhythms.
- ▼ It's a two voice music/sound synth.
- ▼ Fully MIDI compatible. The Ram Music Machine supports full MIDI In, MIDI Out & MIDI Thru.
- ▼ Output through your Hi-Fi or Headphones. Comes complete with Microphone.
- ▼ Use a full size MIDI keyboard to play the Music Machine.
- ▼ Sounds produced by the Music Machine can be mixed with a MIDI Synthesiser's own sounds.
- ▼ On screen Sound Editor can produce MIDI data from your own compositions.
- ▼ No other product can offer so much in one unit - it's the total solution!!

ONLY £49.99 (Cassette)
ADD £5 IF DISK REQUIRED

FREE MICROPHONE AND HEADPHONES!



LIGHTPEN/GRAPHICS SYSTEM

- ▼ Complete Lightpen and graphics system lets you create a whole range of effects on screen.
- ▼ It can magnify, shrink, colour fill and create circles, rectangles, lines and curves.
- ▼ Pictures can be edited at pixel level using a scratch pad which is magnified to full screen.
- ▼ Picture storage and retrieval, and a pen calibration feature.
- ▼ Printer dump utilities for Epson/Amstrad printers supplied (on cassette).

ONLY £14.99 CASSETTE

OR £24.99 WITH SOFTWARE ON ROM - NOTHING TO LOAD
464 or 6128 (Please state which)

MEMORY EXPANSION

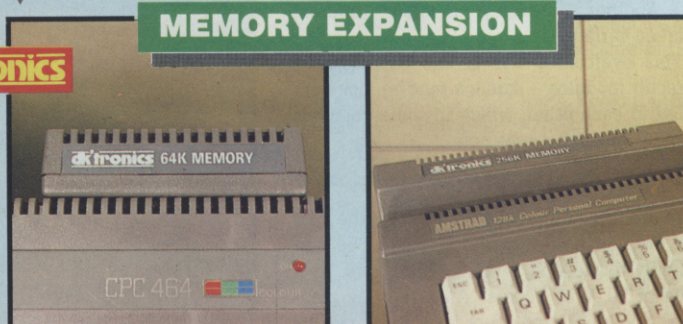

64K AND 256K MEMORY EXPANSION

- ▼ Simple plug in memory expansion gives instant extra memory.
- ▼ Features bank switching software for easy use by the programmer or for use as a data storage area.
- ▼ Ideal for use with the CPM 2.2 etc.
- ▼ The software also features some extra BASIC commands.
- ▼ 64K unit brings 464 up to CPC 6128 memory configuration making a much larger software base available. Will work straight off with many programs designed for this unit (including OCP Art Studio - see Ad.).
- ▼ 64K unit expands 464 to 128K. The 256K unit takes your 6128 to a massive 320K!!
- ▼ All bank switching done automatically by supplied software (cassette 464 - disk 6128).

ONLY £49.99

64K for 464
ONLY £99.99
256K for 464 or 6128 (Please State)

REALTIME CLOCK

- ▼ A simple but highly useful device.
- ▼ Easy to use realtime clock - battery backed to give the correct time and date always.
- ▼ Also features extra 8bit I/O port for external control applications - very useful.
- ▼ Comes complete with full instructions and set-up software.

ONLY £19.99

464 or 6128 (Please state which)

SPEECH SYNTHESISER & STEREO SOUND BOOSTER

- ▼ This easy to use Speech Synthesiser includes a powerful Stereo Amplifier and two Pod Speakers which is a great improvement on the sound of the internal mono speaker.
- ▼ Using the SPO/256 Speech Chip the unit has an almost infinite vocabulary.
- ▼ Text to speech software is provided in ROM to make speech output simplicity itself.
- ▼ Voicing is transparent to the user and the computer can carry on with other program tasks.
- ▼ Speech output is mono directed to both speakers. Booster gives stereo to internal sound output.



ONLY £29.99

464 or 6128 (Please state which)

SILICON DISK 464/6128

- ▼ This is the fastest storage system available for the Amstrad CPC computers and is compatible with CPM 2.2, CPM+ and all DK'Tronics peripherals.
- ▼ The 2516K Silicon Disk is designed to be used in conjunction with at least one normal Disk Drive attached to the system.
- ▼ When the 2516K Silicon Disk is fitted only 2K is used for the Silicon Disk directory, leaving 254K for storage - that's 70K more than a normal Disk Drive.
- ▼ Data and programs can be exchanged between Silicon Disk and normal Disk, application programs can then work on their data at vastly increased speeds.
- ▼ Software is on ROM (nothing to load) and can be used in two modes - Basic under AMDOS with normal LOAD, SAVE CAT MERGE commands etc. and within CPM 2.2 CPM+ where commercial programs are designed to run on multi-drive systems.

ONLY £129.99

464 or 6128 (Please state which)

DATTEL ELECTRONICS

THE ULTIMATE GRAPHICS PACKAGE...



SPECIAL OFFER PACK!



INCLUDES FREE MOUSE MAT/HOLDER WORTH £12.99

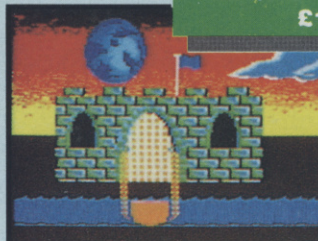
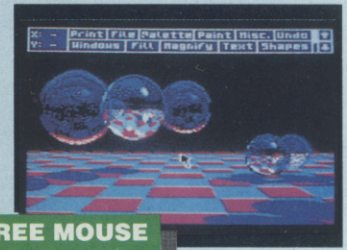

Genius Mouse

COMPLETE WITH

OCP ART STUDIO™

- ▼ Genius Mouse is a high resolution two button mouse featuring optical counting, teflon guides, microswitches, rubber coated ball and high quality interface.
- ▼ When combined with OCP Art Studio this graphics package is quite simply the best system available. The features are unmatched...
 - ▼ Create an image - shrink it, expand it, move it, rotate it, copy it, colour it etc., etc.
 - ▼ Spray patterns or shades, make elastic lines - stretch and manipulate shapes.
 - ▼ Zoom in to add detail in fine mode.
 - ▼ Pulldown/Icon driven menus for ease of use.
 - ▼ Mouse operation, plus joystick and keyboard control.
 - ▼ 16 pens, 8 sprays, 16 brushes - so flexible anyone can create superb graphics easily.
 - ▼ Full cut and paste facilities plus excellent printer support.
- ▼ Pixel edit, font editor, flip, invert, rotate, solid or textured fill and professional manual make Art Studio simply the best graphics package for the Amstrad CPC.

TAPE OR DISK FOR 464 OR 6128 (PLEASE STATE WHICH REQUIRED) N.B. 464 NEEDS DK' 64K RAM PACK

ONLY £49.99 TOTAL PACKAGE INCLUDING GENIUS MOUSE/INTERFACE MOUSE MAT/HOLDER AND OCP ART STUDIO

NEW SLIMLINE DRIVE

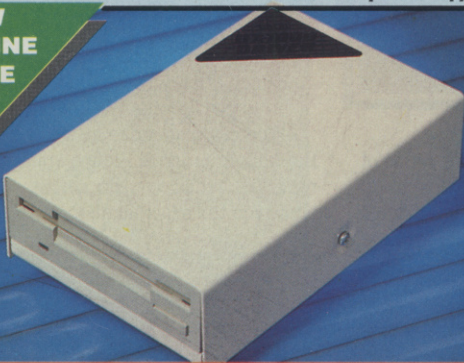

800K 3.5" DISK DRIVE

- ▼ Now you can add a superb top quality 3.5" drive to your CPC Amstrad.
- ▼ 800K of data storage on disks that cost less than £1.00.
- ▼ No need to flip disks.
- ▼ 3.5" disks are fast becoming industry standard.
- ▼ Comes complete with power supply and cables.
- ▼ We supply our drive with the RODOS operating system, giving

not only this vast disk capacity but also over 50 new bar commands plus a printer buffer, etc. Easily fitted - full instructions.

464 owners must already have at least one Amstrad drive.

Only £119.99 for Drive and RODOS including PSU/Cables

- ▼ Turn your Amstrad Monitor into a full feature TV set with our TV Tuner System.
- ▼ Latest chip technology gives crystal clear reception on all channels.
- ▼ Built-in speaker.
- ▼ On/Off volume controls.
- ▼ Brightness and colour controls.
- ▼ Channel selector.
- ▼ Attractively styled to match your computer.
- ▼ Why not realise the full potential of your monitor?

ONLY £69.99

PCW 8256/8512

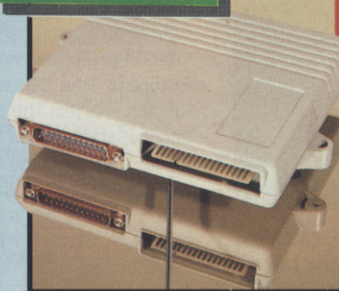

PCW 8256/8512 COMMUNICATOR

- ▼ Complete RS232 and Centronics/Parallel interface for the PCW Amstrad.
- ▼ Simply plugs into rear expansion slot.
- ▼ Attractively styled in computer colours.
- ▼ Full instructions supplied.

Only £49.99 complete

ALL ORDERS NORMALLY DESPATCHED WITHIN 48 HRS

HOW TO ORDER ...

<p>BY PHONE</p> <p>0782 744707 24hr Credit Card Line</p>	<p>BY POST</p> <p>Send cheques/POs made payable to "Datel Electronics"</p>	<p>FAX</p> <p>0782 744292</p> <p>UK ORDERS POST FREE EUROPE ADD £1 OVERSEAS ADD £3</p>
--	---	--

PRICES AND SPECIFICATIONS CORRECT AT TIME OF PRESS AND SUBJECT TO CHANGE WITHOUT NOTICE

CALLERS WELCOME - Please reserve goods by telephone prior to visit.



DATTEL ELECTRONICS LTD., FENTON INDUSTRIAL ESTATE GOVAN ROAD, FENTON, STOKE-ON-TRENT, ENGLAND.

SALES ONLY
0782 744707

TECHNICAL ONLY
0782 744324

ACTION TEST

It's **TRENTON WEBB** time again, folks!

This month's centre spread, traditionally the preserve of the *Mastergame*, is occupied instead by the Virgin/Mastertronic *Magnum* lightgun: will it transform games playing on the CPC?

Meanwhile it's a busy time on the reviews front, with *Timescanner*, *Silkworm*, *Xybots*, *Skate or Die* and *3D Pool* all clamouring for your attention. Star of the issue, though, is *Grandslam's Thunderbirds* – quite possibly the year's best value. Two quid tape/disk differential? Like it!

MASTERGAME

Thunderbirds 48

RAVES

3D Pool	40
Silkworm	50
Sweek	46
Timescanner	47

Also reviewed this month

Games, The (Summer Edition)	57
Magnum Lightgun	42
Skate or Die	53
Rick Dangerous	57
Xybots	55

3D POOL

Firebird ● £9.95 cass, £14.95 disk
joystick/keys

It has been observed many times that pool, snooker and billiards could be played efficiently by an idiot equipped with a book on ballistics.

This can't be quite true – as I recall, the book never helped me one single bit. Yet there's a good case for thinking that computers, with their totally logical and accurate calculating processors, could really get into pool in a big way.

I can't see it myself. Can you imagine walk-

ing into a pool hall to be hustled by a plastic'n'steel Paul Newman android? Still, looking at *3D Pool* you could believe that one day machines will rule the green baize. And when you consider that an android has been world snooker champ more often than anyone else...

Firebird's *3D Pool* – in which you compete against a variety of opponents, and finally European Pool Champion Maltese Joe himself – is just the latest in a whole series of snooker-style games that have been appearing since they become popular in the arcades around 1984. They include such classics as robotics expert *Steve Davis' Snooker* and *CDS Pool*, but they have all suffered from a shortcoming – they were

all viewed from the same vantage point above the table.

As the whole table had to be viewed at once, the scale of the table wasn't very big and the games become predictable. It wasn't that you could always pot the balls, but you could nearly always say that you'd miss and by what margin.

The advantage of *3D Pool* is that you can walk around the table, viewing the cue ball from every angle.

You can also strike at the bottom or top of the ball, in order to induce spin. That's not so new, but when you do so, the table tilts to show you the exact angle that you're aiming at.

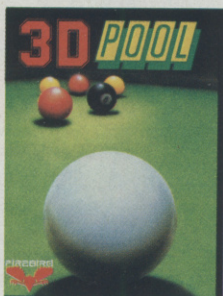

Game for a break

The game offers a wide variety of options for serious addicts. There is the practice feature, which lets you get on with the serious job of potting balls. Then again you might want to try some trick shots. These are very difficult to get right, but make for some great practice – taking the same trick shot with even a slight difference causes a wide range of variation in how the table finally looks.

The tournament itself is fairly easy to understand: it starts out with eight players; who produce four winners; who produce two winners; who produce one overall winner; who then takes on Maltese Joe (and loses). My own personal feeling on Maltese Joe's ability is that the reason you always start first is because he's so good – you can only beat him if you start first and have a perfect, white-washing break.

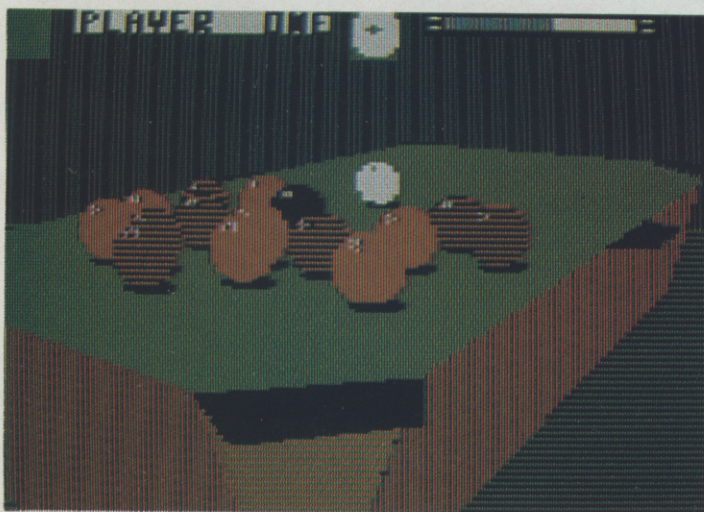
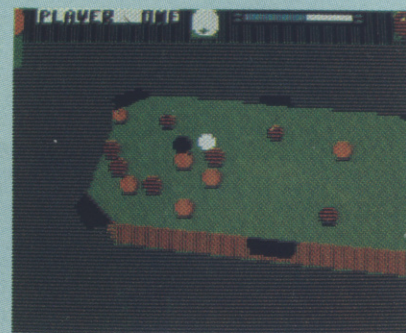

● Got to take the white off two pockets

● Even 'Fast Eddie' would struggle on this one

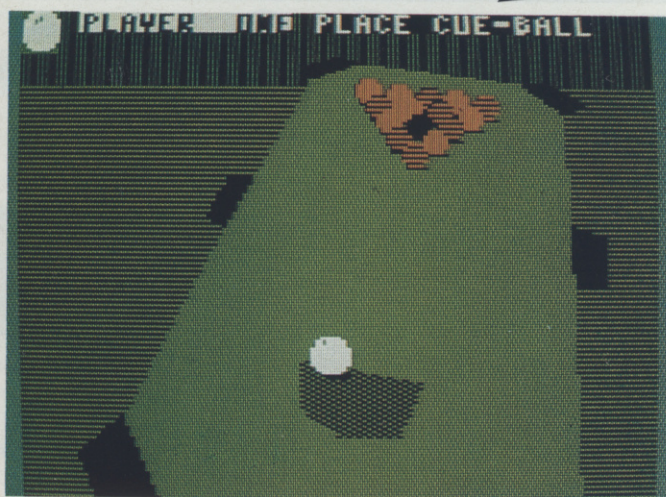

● A ball that just refuses to go down

● Make or break

The great Orlando

On the starting screen of 3D Pool notice the name of the designer, Orlando of Aardvark Software, a legend in his own lunchtime. Orlando has been writing games since at least 1983 (yup, before the CPC was invented) and has won awards for game design and innovation.

It's quite remarkable that such a big name should reappear on what is basically a strategy-with-action game. One of his earlier classics was called *Frak*, and although detailed to be converted to the Amstrad it never, as far as I know, made it.

That game involved a caveman who had to travel across a series of platforms (*oh wow -ed*) knocking off monsters called scrubbies with a hand held yo-yo (*pardon? -ed*). One supple flick of the wrist and another brightly coloured hairy nasty was sent screaming down the screen.

It remains to be seen if more games are released by Orlando, and if his current style is set rigidly. If it is, it won't be a bad thing. Except for those who love caveman simulators!

All the balls are shaded, as is the table and background. The big let down is that, although the screen is in the chunky 16 colour display mode, only 4 are actually used! Considering the way the game appears on screen (in fact it's pretty good) it could have been amazingly good. Another lost opportunity...

SECOND OPINION

"Agonisingly slow, agonisingly difficult, and still a game to return to time after time."

TW

GREEN SCREEN

no easier - but no hassle

One final point about the display: the speed at which it rotates and moves is so fast you can dip and spin enough to make you seasick. But when the computer is thinking about its shot the action is frozen.

The game theory is easy enough. You have to line up the white ball to make a fair shot. The white always travels vertically up the table away from the viewpoint. This means it is easy enough to judge angles when the cue ball and object ball are close, but much trickier when they're touching or fairly distant.

Progression in the game is much as by the rules. The game is based around a tournament, with various computer controlled opponents. These range from No Hope Nik to Mighty Mike, and they've all got their own individual styles.

There are a few differences from the real game. The human always breaks in the first and last frame, with the computer taking the middle one. When a foul stroke occurs, a free ball is automatically awarded to the

other player. Most disturbing of all is that there are no cushions, the balls simply bouncing back from the edge of the table.

All of the computer opponents play extremely well. It's very disheartening to lose game after game, especially to the same player. I must have lost about fifty games to Mighty Mike alone! You soon understand though, that although the different players have different styles, the only real change between them is that if you play an easy player, *the pockets are larger!*

You start playing, and you just can't stop. Eventually things can get serious, with a demented gamer demanding the right to play various players, and taking several hours to lose frames that should take a few minutes.

My only objection to this hugely addictive game is its difficulty. It's not as devious a game as the real thing, but compared to your average shoot-em-up there is no comparison. Give me lots of *3D Pool*, and I'll be happy. **PbM**

First day target score
win a match - any match!

The Verdict

GRAPHICS 74%

- Very good moving 3D graphics.
- But mode 1 would offer better resolution.

SONICS 8%

- Two good sound effects.
- That's all.

GRAB FACTOR 90%

- Fabulously addictive.
- I'm still not cured.

STAYING POWER ... 69%

- You can become skillful.
- But it takes a long time.

AA RATING 80%

- Definitely worth cueing for!

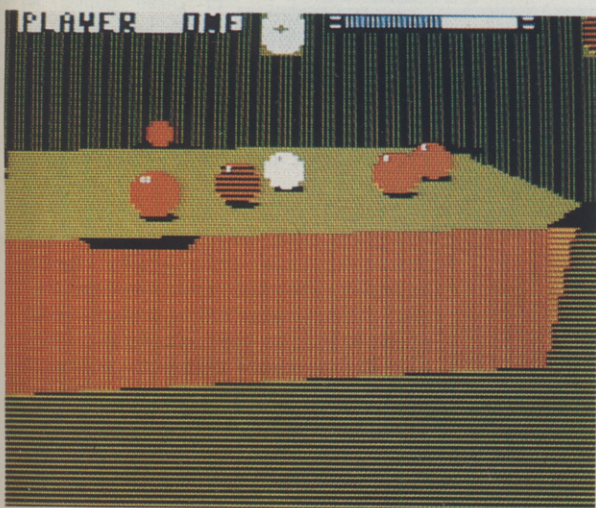

● The computer gets lost in thought

TRIGGER HAPPY?

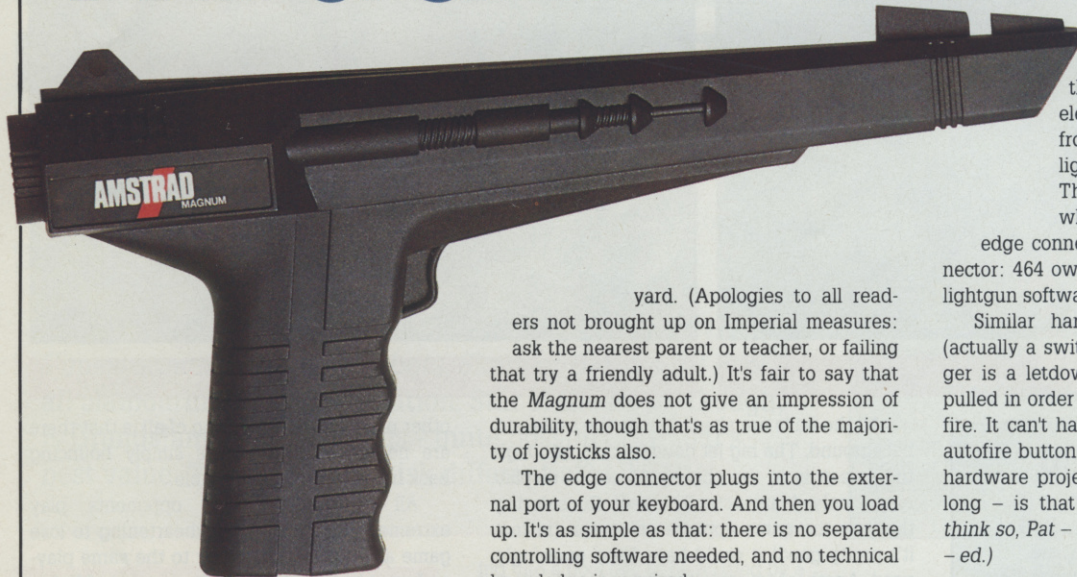

Is this the most powerful lightgun in the

world? We put the Virgin/Mastertronic £34.95 Magnum to the test

At last we've got our grubby (but nonetheless exclusive) little pinkies on the brand new CPC lightgun from Virgin/Mastertronic, due in the shops any moment now.

It's been a long time coming, but the question is: has it been worth the wait?

The black vacuum formed plastic gun – appropriately enough a lightweight at less than half a pound – is a mere foot long (300cms in new money) and comes with 48" of wire. This may sound ungenerous, but of course since you plug into your keyboard you can sit as far away from your monitor as that will allow – though to be frank the practical maximum firing distance is no more than a

yard. (Apologies to all readers not brought up on Imperial measures: ask the nearest parent or teacher, or failing that try a friendly adult.) It's fair to say that the *Magnum* does not give an impression of durability, though that's as true of the majority of joysticks also.

The edge connector plugs into the external port of your keyboard. And then you load up. It's as simple as that: there is no separate controlling software needed, and no technical knowledge is required.

What is required, however, is software to run it on. As you'll appreciate you can't simply start firing at your old copy of *Operation Wolf* or whatever and expect it to make any difference. That's why you can't buy the gun on its own. The six games bundled with it are *Missile Ground Zero*, *Rookie*, *Solar Invasion*, *Robot Attack*, *Bullseye* and *Operation Wolf* (see the box "The score so far: 5 – 1" on the right).

Electric gimmickry

What's the difference between the *Magnum* and a joystick? What are its advantages? How does it work? Well, for one thing the lightgun can be pointed at any point on the screen all the time. Moving a joystick means that the aiming point, the "point of animation," has to move through the intervening points.

Under the flimsy casing of the *Magnum* there's a fair bit of electronic gimmickry. At the front is a lens which focuses the light for the gun onto a light cell. The signal is "cleaned" somewhat and sent down to the CPC edge connector (there is no through connector: 464 owners won't be able to use disk lightgun software).

Similar hardware connects the trigger (actually a switch) to the computer. The trigger is a letdown: it needs to be repeatedly pulled in order to give a continuous stream of fire. It can't have been that difficult to fit an autofire button, can it? (Expect to see an A A hardware project for the lightgun before too long – is that myserious enough, Steve? *I think so, Pat – I certainly don't understand it – ed.*)

Stand and deliver

The message to the software houses who had pledged their support for the *Magnum* lightgun must be: stand and deliver! The gun, no matter how technically superb it may be, is worse than useless if there are no decent opportunities to snatch it out of your shoulder holster and get popping things.



● No cursor, but the *Magnum's* just as lethal

Only *Bullseye* and *Op Wolf* manage to steer clear of the trap so common to new games hardware. And *Bullseye* is a dreadfully tame version of the dull Jim "Magic magic fine great super" Bowen quiz-game-with-darts.

It's abundantly clear that the function of these games is purely and simply to justify the existence of the *Magnum* rather than to exploit its strengths. With the honorable exception of you-know-what all they do is prove that your £35 was spent on something that actually works.

The purpose of the lightgun should be to enhance a game concept and not be one. Instead of games being adapted merely because they can take advantage of the technology, programmers should be aware of its existence and use it accordingly. Instead of, "Hey, this clapped out old dog of a game could get a new lease of life if we adapt it for the lightgun," software project managers must take the line that, "Wow! We've got a brilliant concept for a game here. And it will be even better if we can take advantage of what the lightgun can do!"

Credit where credit is due

The credit for bringing the lightgun into the world should go not to Amstrad, under whose name the *Magnum* is being sold, nor even to Virgin/Mastertronic, who are marketing it, but to Trojan Developments, who designed, built and manufacture the thing. Swansea-based Trojan developed the lightgun for vari-

ous machines – one each for the Commodore 64, the Amiga and the Atari and three for the various Spectrums. (Incidentally, there are two *Magnums* for the CPCs – one for the 464 and one for the 6128.)

They then interested Amstrad in badging the 'gun and Virgin/Mastertronic in mar-

keting it.

As far as the software is concerned, Trojan licences the software driver out to whichever houses are interested, who then write it into any games they choose pay a royalty for using it. And it's only the work of a couple of days to convert a game to be compatible with the *Magnum*.

The score so far: 5 - 1

There are six games bundled with the Magnum: *Missile Ground Zero*, *Rookie*, *Solar Invasion*, *Robot Attack*, *Bullseye* and *Operation Wolf*.

- *Robot Attack* is just a matter of shooting small droids as they attempt to build a larger and more deadly parent. Here the gun performs as little more than a cork-firing airgun at the local fete, the robots becoming the plastic ducks everybody loves to waste. Fun for a few minutes, but hardly the technological breakthrough we've been waiting for.

- *Solar Invasion* fits the bill as the standard asteroids game with every form of alien life floating briskly across the screen and into your gun sights. Again it is little more than a tame demonstration of the lightgun's function and falls well short of the required mark to be called a game.

- *Rookie* is a straight out rifle range simulator with authentic sounds and small plate targets you blast to qualify for the next round of target practice. *Missile Ground Zero* takes you to one of those ever so familiar "last surviving bases" where you save the world by shooting anything that threatens the base.

In all four games your supply of ammunition is limited in an attempt to stop you just going crazy and peppering the screen.

The remaining two games are the only one to have seen the light (pardon the pun) of day before.

- The dreadful Bowen-inspired (if that the word, which it ain't) *Bullseye* deserves to have been allowed rest in peace (AA7, 34%), and its resurrection is hardly welcome.

- That leaves just one game: *Operation Wolf*, without doubt the star of the collection. A superb game, it scored an extremely healthy 89% (AA40; Mike Wong poked it in AA43). If you have played it - in the arcades or at home - you'll know exactly why it's been attracting all the attention. It's a very fast-moving horizontally scrolling all-action, do-or-die (usually the latter) shooting game with thousands of soldiers doing their best to prevent you rescuing the hostages. Helicopters, patrol boats, machine guns, grenades and turkeys - this one's got everything!

Op Wolf provoked a resurgence in the

It will require a considered and concerted effort on the part of those in software houses to make use full of it. From their point of view it is an ideal opportunity once again to flog off software (modified to suit the Magnum) long since left for dead.

That's exactly what's happened with *Bullseye*. This new device requires long term support from software houses if it is to be more than a temporary toy. ●

age-old debate about violence in computer games, and may even ultimately be responsible for the notorious correspondence in *A A* featuring one Mr Wm A.A. Smith of Windsor.

It's a brilliant conversion in "cursor" mode with the potential to become the first CPC "authentic arcade" game - complete right down to the sore trigger finger! And it's in a completely different league from the other dreadful old makeweights in the collection. For a start, of course, it helps to have a superb game to begin with.

But more than that, the lightgun brings back to the CPC version something that the arcade game had all along. There is, after all, something artificial about a joystick as a gun, since its origins are obviously as a steering device.

Now, with the Magnum, you feel that *Op Wolf* has come home. It was always an addictive, just-one-more-go game: now it's an addictive, just-one-more-go game that *feels* right. The only problem is that impacts aren't registered, so when you're missing you don't exactly know whether you're shooting left, right, high or low.

Suffice to say, however, that *Op Wolf* was up and loaded within 30 seconds of its arrival, after which the silence in the office was broken only by the ping of the game.

Is it or isn't it?

Op Wolf apart, though, will the light gun make enough difference to warrant forking out £35 for a couple of hundred grams of plastic and wires?

The gun offers a variety of gameplay additions to the state of play in current CPC

software.

It moves as fast as you do and does not rely on microswitches to tell it where the shot has landed, so the rate of fire is improved, as is the number of different directions you may shoot in the same brief moment.

The sense of involvement is greater because (despite the complex moral argument, neither side of which is completely convincing) it is fun to actually hold a gun and shoot your CPC.

Most importantly though it gives writers of software the opportunity to use any of three methods of control - joystick, keys or lightgun - for the best and most exciting games.

It is conceivable that a combination of two could operate simultaneously. What about all three together for seriously heavy gameplay such as that in *Gunship*?

The future of the lightgun depends solely on programmers finding innovative ways of implementing its use. *Operation Wolf* clones won't keep the anyone happy forever. Good shoot'em ups need not only fast paced action but a little more control of their fate.

The Magnum may be used, say, in connection with a joystick to remove the static nature it so readily suggests. If this is the case then gaming on the CPC may never be quite the same again. If it isn't... we may yet be left with the world's most expensive item for stirring tea.

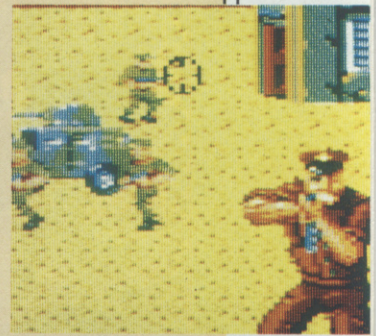

● Too many - and I'm dead again!



Shoot into a new dimension - for free!

To celebrate the arrival of the Magnum, Amstrad Action and Virgin/Mastertronic are combining to bring you not one but ten opportunities to win the lightgun itself and the six games with which it comes bundled. That means you could be one of the first to experience this new way of playing games - not to mention saving yourself a neat £34.95 into the bargain!

What we want is for you to use your skill and judgment to name the three games that you'd most like adapted to run with the lightgun. So

if, for example, you honestly imagine that WEC Le Mans would be even better if you could steer

using the lightgun, then by all means put that down if you don't really want to win.

Got the idea? Just jot down your three suggestions for the lightgun, together with your name and address, on a postcard or the back of an envelope, and send it to: Magnum, AA, 4 Queen St, Bath BA1 1EJ.

Entries must arrive before the end of August to qualify.



→ → PLAYFUL

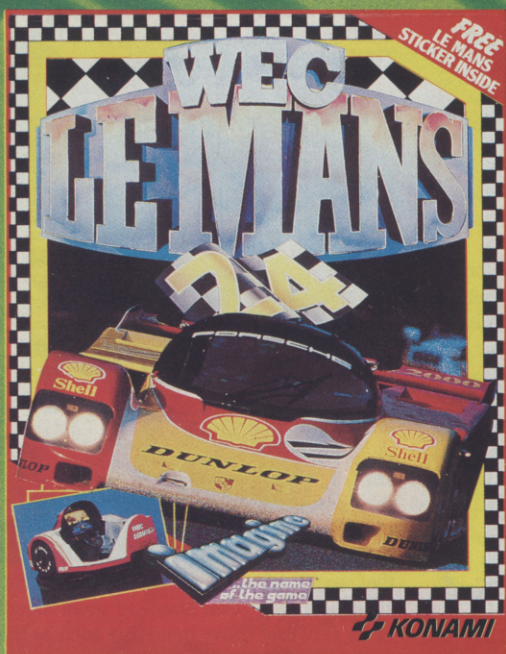

WEC LE MANS
 "Wec Le Mans has many things going for it... I reckon it will be the definitive racing conversion for 8-bit machines."
 Wec Le Mans is not a game – it is the ultimate driving experience.

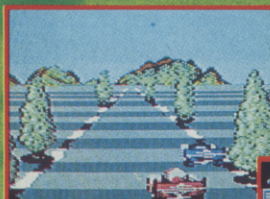

ROBOCOP
 "This is definitely the tie-in to date, it is a superb game. It's not just a game, it's a computer-aided..."



BAD DUDES VS DRAGON NINJA
 "A sure winner with the official conversion to the home computer."
COMPUTER GAMESWEEK
 "A very enjoyable and addictive game... The best conversion I have seen on the Amstrad."
AMSTRAD ACTION
 "There is more than enough action in this one to keep you coming back for more."
ACE

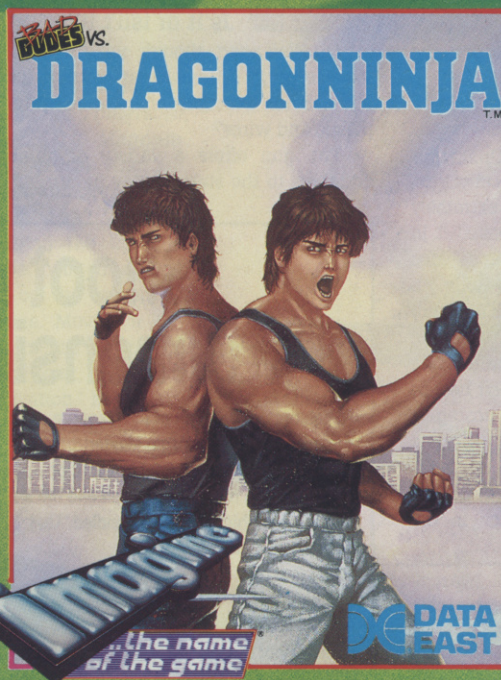

ATARI ST AMIGA
BATMAN
OPERATION WOLF
19.95 24.95

ATARI ST AMIGA
ROBOCOP
DRAGONNINJA
19.99 24.99



INTELLIGENCE

ROBOCOP
 "The best film
 and is an utterly
 in its own right-
 rges it."
OF THE MONTH
VIDEO GAMES



BATMAN
 "Incredible presentation... Just the
 right way to capture the comic book
 feel."

ZZAP SIZZLER ZZAP 64

"Batman The Caped Crusader will
 suit riddlers of all ages."
 ACU STAR GAME AMSTRAD
 COMPUTER USER

"Ocean have made a fantastic job on
 Batman and being in two parts you
 get excellent value for money.
 Brilliant!"

A CRASH SMASH CRASH

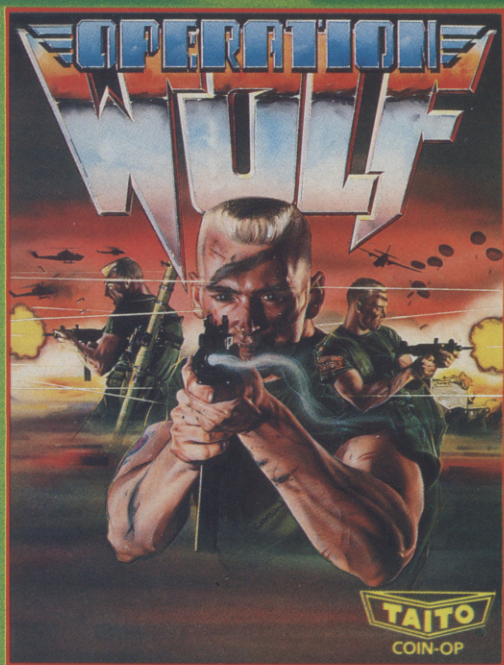
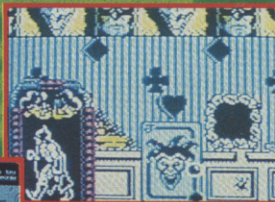
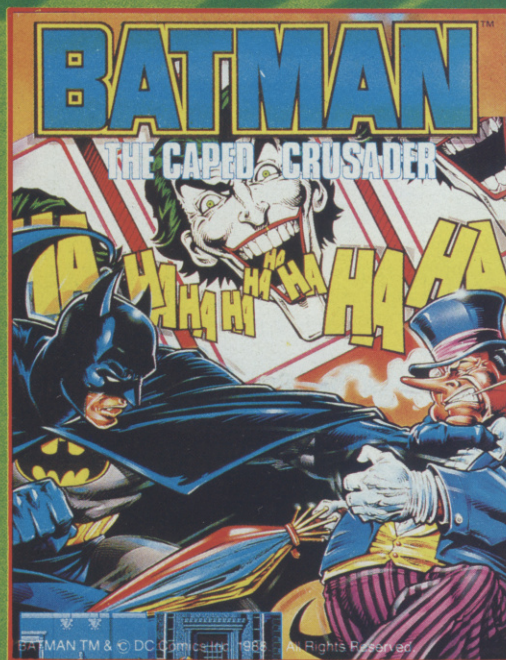

OPERATION WOLF
 Voted "Game of the year." The
 world's No. 1 arcade game.
 "Super-smooth scrolling and
 excellent graphics... Without
 doubt this is a first class
 shoot em up."

A CRASH SMASH CRASH

"Definitely the coin-op of the
 year... Buy Operation Wolf
 it's a brilliant conversion."
 C+VG GAME OF THE MONTH
 COMPUTER + VIDEO GAMES



BATMAN
 ROBOCOP
 WEC LE MANS

SPEC/AMS
9.95
 COMM

OPERATION
 WOLF
 DRAGON NINJA

SPEC
8.95
 AMS
9.95
 COMM

SKWEEK

US Gold ● £9.99 cass, £14.99 disk joystick/keys

Everybody's conservation minded these days, and now you too can do your bit by helping to save the lesser spotted, yellow crested, pink toed *Skweek* - or *Gamus Ratus Addicitivus* as they say in Latin (and remember, when in Rome do as the Romanians). *Skweek* is a creature who needs to reclaim his environment which has become polluted with horrible blue (boo!) tiles. They must all be painted pink if the little rodent is to be able to pursue life, liberty and the *skweekian* way.

To make tiles change colour all *Skweek* has to do is run over the top of them (where does he keep his paintbrush?). Naturally things are never straightforward, and our furry friend is pursued by a whole host of strange and curious beasties. Everybody, it seems, wants a piece of the yellow peril - ghosts, fireballs, purple people eaters, even gun-toting octopuses! Green star fish demolish walls to reveal blue tiles just to make life difficult, while the purple gang occasionally start laying new blue tiles to add to the challenge.

Skweek materialises (in a normal game) on a series of increasingly tough levels. The first one you visit, more of a warm up than anything else, has no tricks or traps apart from large holes in the floor. Don't let this lure you into a false sense of security, though: it's real dangerous out there for a young *Skweek* who's not used to the turf. Floors decay, manholes allow monsters to pop up and get you and self-destruct squares blow up all the tiles in the immediate area leaving *Skweek* stranded in mid-air making like Jerry the mouse scrambling for solid ground.

On the plus side for serious *Skweekists* are a multitude of goodies to collect and keep:

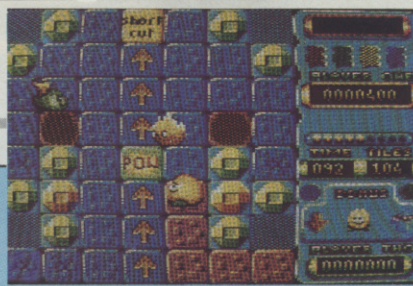

● Skweek when you're skwoken to!

laser fire, turbo speed, baby *skweek* bonus lives, ice cream (!) and the Teds, the single greatest gift ever to the *Skweeklanders*. It's not that they've never grown up, nor that they need something to snuggle up with at night. But collect four teddy bears and you get five extra lives.

Skweek himself is a small ball of fur in a sea of blue, his four way movement suiting the rightangled tile-world in which he lives. You send him scurrying around, painting his heart out when a beastie glides onto the screen. Like *Pacman*, each creature has a particular style of attack. The onion shape boys are the worst, endlessly jumping around the place as if they've drank too much coffee, and as fast as *Skweek* with the turbos on full blast!

Octopuses fire rebounding shots that seem to track *Skweek* even when he tries to hide. It's outrageous! Why can't these monsters act like normal people and stand on chairs when mice-like animals enter the room?

In normal game mode, you meet new dangers at the rate of two or three a level as you progress. In random mode you can find the mouseketeer *Skweek* transported to any level from the

pushovers up until levels where you don't even know how to start.

On the more ridiculously tough settings self-destruct 'POW' tiles actually trap you in a corner as your path disintegrates leaving you scrambling for floor (or just plain dead!). Other times you come face to face with arrow tiles that drag you along a long and winding path only to deposit you into a hole, or onto slippery slidy tiles that quite defeat any kind of direction. Once on these it's a case of trusting to luck and hoping that great *Skweek* in the sky is smiling - a rare event indeed.

The whole look of the game with the

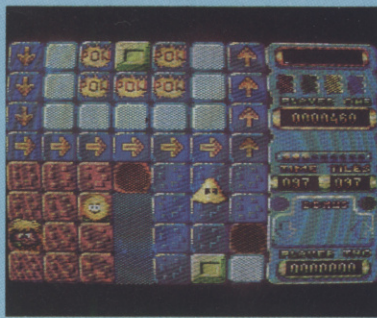
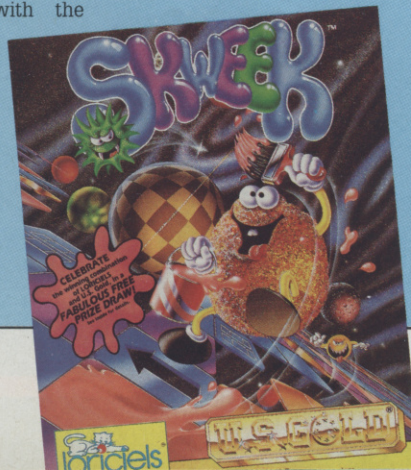

● Painting the town pink



French connection

Skweek is the first fruits of a new US Gold/Loricels tie-up, and the French connection goes some way to explaining the 'cute' spelling of the title.

It's just the first of an expected ten games coming across the channel over the next year. And it is certainly about time that we were granted access to Gallic software, which has a reputation for being well-crafted and sophisticated. And while *Skweek* can claim to be the one, it can hardly be called the other.



cutesy characters seems directed at the lower end of the age range. Yet anyone of any age will immediately be seduced by *Skweek's* subtle charms, simply because it's fun and quite different. There is only one question that must be answered: why doesn't the little geezer actually ever make a noise, let alone a squeak? Still, I suppose a game called *Mute* wouldn't do too well, would it? **TW**

FIRST DAY TARGET SCORE

two sets of Teds in succession

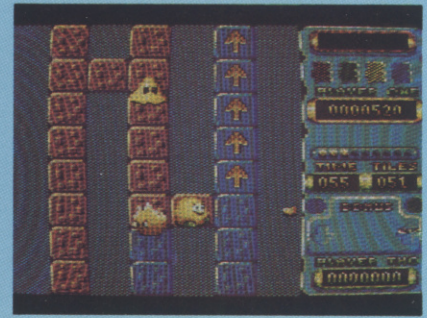

● A night on the tiles

The Verdict

GRAPHICS 84%

Pretty in pink - tough luck if you don't like the colour!

Invisible in green.

SONICS 82%

A jolly, happy tune..

you'll grow to loathe.

GRAB FACTOR 92%

Instant addiction.

STAYING POWER .. 72%

Trillions of levels!

Some areas are simply unplayable.

AA RATING 82%

Enjoyable entertainment that could become an obsession. Dizzy look out!

SECOND OPINION

"You'd have thought that Codemasters had the furry cuddly bunch all covered with Dizzy - but you'd be wrong.

"Skweek is daft, but great fun - try it!"

SC

GREEN SCREEN

Impossible, since the game is based on colours. Not recommended

TIMESCANNER

Activision ● £9.99 cass, £14.99 disk keys

Could you cope with a magical mystery tour of pyramids, ruins, alien desert landscapes – even time itself and play pinball at the same time? With *Timescanner* on your CPC it's just a walk in the park as four different tables, two screens high, await you in your very own arcade.

Now pinball on a computer sounds a bit lame. Tell the truth, it sounds very lame as a game concept. Surely pinball died a natural death years ago when *Space Invaders* burst onto the scene? Wrong! It's back with a vengeance, and will have you beating your keyboard into submission for hours to come.

The game opens with the Volcano, an ordinary looking everyday pinball table, but all is not what it seems. You fire your first ball into play. Flippers at the ready, it's a waiting game as you ball ricochets around the pins and bumpers. Lights flash as your score



dead! The screen scrolls down to reveal the bottom half of the table. Again all the trimmings are there, but this time there are also clear tubes that provide access back up to the top part of the screen.

Firing a ball up from the bottom half also triggers one of the many bonus features, and the word volcano starts to light up. When the word is complete an eruption occurs, and to your surprise out shoot not one, not two but three balls for simultaneous play. This is supposed to be to your advantage (who are they trying to fool?). One ball is bad enough, three over the top: you just can't concentrate on three places at once and the flippers take a bashing as you desperately try to keep every ball in play.

Other such tasks must be completed, apart from notching up a gargantuan score, before you can shoot for the 'time tunnel' and get transported to the next table. Saqqara is next – a deserted, desolate table with fewer pins and more traps. Shooting the ball back up to the top of the table here is nigh on impossible, while keeping up there in the first place is even more troublesome.

After Saqqara comes the ruins table – possibly the best – and here things really start to get out of hand. One feature starts to collect your balls and display them in the lower section. This just looks showy, until the 'Xtra ball' feature lights up. Suddenly all your collected spheres smash their glass casing and once again there are multiple balls shooting around in play. Survive this baby and if your nerves are not too shot or fingers too sore it's special level time.

The final level of *Timescanner* features a *Breakout*-style game, so as well as scoring oodles of points you've now got to wipe out blocks as well. This once and for all kills any idea that pinball is a simple game, for in *Timescanner* technique and feel in the way you play are everything. Understanding of how the ball rolls and bounces is vital to employ the tilt feature to full effect. – Yup, you heard right, the game is designed to incorporate a simulation the thumps desperately administered to real tables to stop the ball going out of play. Press the right key at the right time and the whole screen shakes as you tilt the table to encourage that tiny motion that will save the day.

Timescanner is a simple concept laced

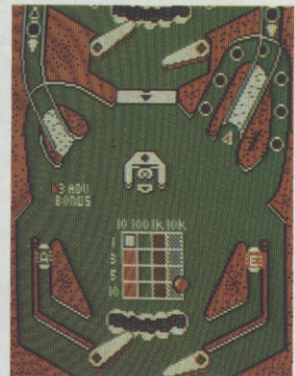

● Flipper 'eck! *Timescanner's* lays the table

SECOND OPINION

"This game has no right to be so good. I mean, pinball? Come on you guys!

Yet *Timescanner* has that elusive something that drags you back for more, just when you'd decided to switch off. Trent's got the hi-score – 1,208,400 at last count – but I'm only a coupla hundred thou. behind.

Aargh! He's just beaten his own record. 'Scuse me, catch you later..."

SC

GREEN SCREEN
no hassle

starts to build up. You notice that when certain pins go down the bumpers score more points and a strategy starts to evolve.

The speed is a bit daunting at first, you just don't expect a computer game ball to move so sharpish. Flexing flippers, a feel soon develops for the way to get the ball where you want it, when you want it there. Eventually a mistake is inevitable and the ball trickles past your guard. Yet the ball is not

● A table for two...

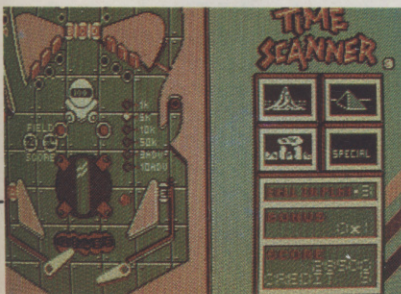

with an unexpected level of complex game strategy – the goals soon become clear, while achieving them requires the deftest of touches. The situation is made even more fun with the cranked up pace and myriad methods of scoring. It won't take much time to see all the levels, but that's not the point. With pinball it's scoring more points than anyone else ever in the history of history itself that matters. Let's roll...!

TW

FIRST DAY TARGET SCORE
200,000 points

The Verdict

GRAPHICS 84%

- Smooth fast balls.
- Big playing area.

SONICS 89%

- Authentic effects build atmosphere.

GRAB FACTOR 86%

- Instant addiction.
- Impressive audio-visuals.

STAYING POWER ... 84%

- The real challenge is to get to the top of the hi-score table – like real pinball.
- Are four tables enough?

AA RATING 83%

- Great game for veterans and novices alike.

THUNDERBIRDS

Grandslam ● £12.95 double cassette; £14.95 double disk (free audio tape with tape/disk) joystick/keys

Tracy Island, playground of the rich and famous. This oasis in the sea is the domain of the fabulously wealthy Tracy clan and home of the mighty Thunderbirds – known to the world as International Rescue.

John sends an urgent message from Thunderbird 5: some miners are trapped miles below the surface of the earth. The mine is flooding and the workers look sure to perish. Only a miracle can save them now. 'And that's just what you might get,' as Scott Tracy is fond of saying.

Brains is stationed in the mole – I.R.'s super tunnelling vehicle – and Alan flies TB2 carrying it to the scene. Before you can say 'OK father' the mission begins. Brains has tunnelled his way to the bottom of the shaft, while Alan is topside. The plan is to rendezvous with the miners, Alan Tracy bringing the winch

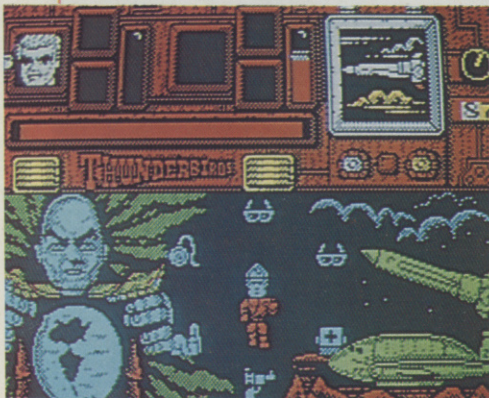

● Calling International Rescue

winch down from TB2, while Brains tries to avert flooding by repairing the pumping equipment. It's a tough task, with the clock to beat as well as the dangers of the mine itself.

As they prepare to go in, they have the choice of two pieces of equipment that will help the rescue – a choice of everything from flash lights to guns (grease guns that is!). Each IR member is only able to hold two items at any one time, so success is dependent upon knowing where to 'dump' items for Ron (=later on). The mine is very dangerous, though, pitfalls (literally) awaiting Alan or Brains if you let them charge into the darkened (heavy playing hint) tunnels.

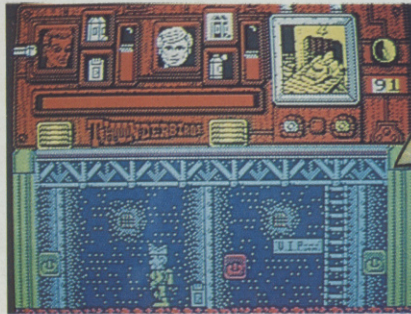

● Like a puppet on a string...

Brains is in the most immediate danger as he tries to stop the mine becoming an underground pool. He's forced to negotiate old and very rickety lifts and blocked passageways before he gets a chance to stop the water. Take too long and the guy with the specs takes an early bath – embarrassing as the whole IR team abort their mission and save him. Alan's main task is making his way quickly down to the miners. There are some helpful devices to speed him along – but again it's finding where they are and how to use them.

You control both characters at the same time toggling between pictures of them in action individually, which works like a 'cut' on TV. The game manages to retain the authentic *Thunderbirds* flavour: heads are too big, lip movements have nothing whatsoever to do with the message screen, and to see them swim is classic Anderson. It's with wobbly heads and silly walk the woodentops carry out their missions – just like the real (real?) thing but without the strings.

There are three further increasingly complex adventures for the *Thunderbirds* to complete if the world is to be saved. Alan and Gordon are dispatched with TB2 and TB4 to the aid of the *Oceanic Star*, a submarine crippled by the Hood's sabotage. This time the main danger is not falling rocks, but radiation and water flowing through the vessel. The

water needs to be evacuated, but most importantly the nuclear reactor

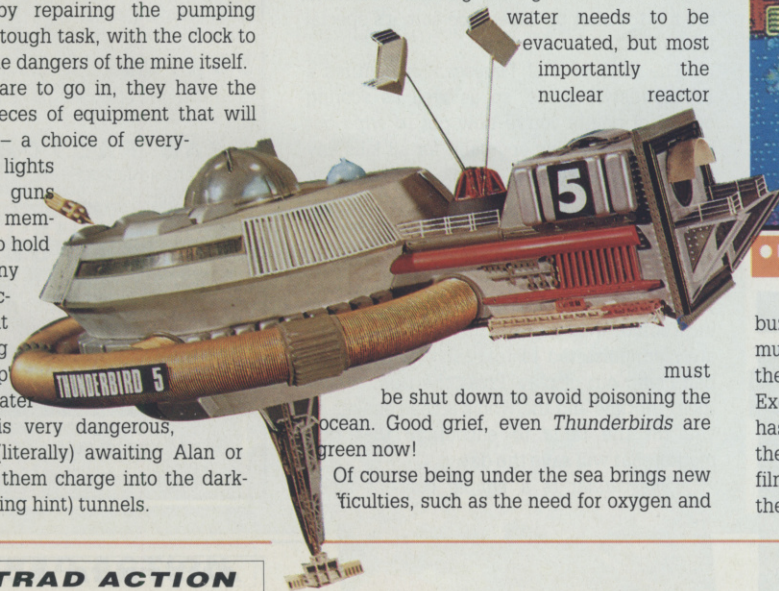

must be shut down to avoid poisoning the ocean. Good grief, even *Thunderbirds* are green now! Of course being under the sea brings new 'facilities, such as the need for oxygen and

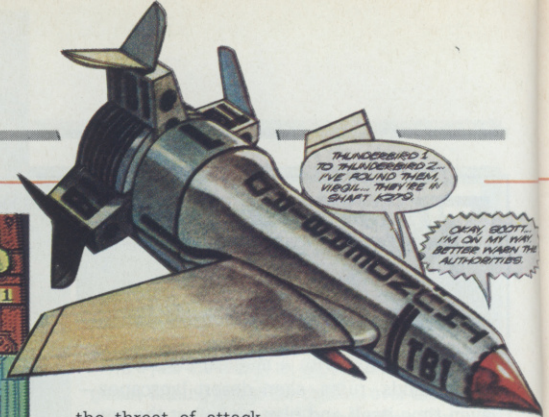

THUNDERBIRD 1 TO THUNDERBIRD 2... I'VE FOUND THEM... WE'LL... THEY'RE IN SHAFT 107D.
GREAT SCOTT... YOU BETTER WARN THE AUTHORITIES.

the threat of attack from sharks, who strike before you can say F.A.B. Life is made all the more strenuous by a tighter time limit. TB4 stands by as a means of escape if things turn nasty, but the sub (and the environment) must be salvaged if you are to get the third and best stage...

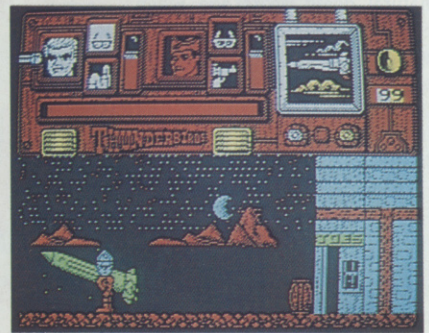

● Great Scott!

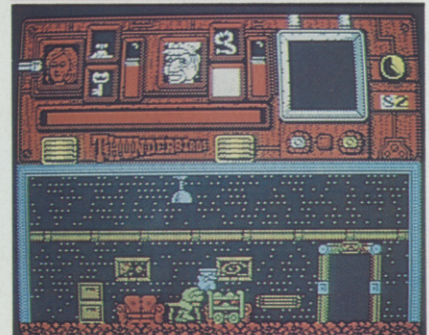

● Yes, M'lady?



● Ever get that sinking feeling?

The coffee pot communicator starts to buzz. Lady Penelope answers the secret communication from Jeff Tracy, head honcho on the Tracy ranch. The World Intelligence Executive accident report on the *Oceanic Star* has identified the culprit behind the mining of the sub. Whoever planted the mine also filmed TB2 at the scene, but red tape stops them giving IR the Hood's name. In order to



INTERNATIONAL RESCUE CREW ROSTER

Jeff Tracy – Founder and father of the Thunderbirds.
Multi-millionaire owner of Tracy Island.

Scott Tracy – Eldest brother and pilot of TB1.

Educated at Oxford, but don't hold that against him.

Virgil Tracy – Technical expert and pilot of TB2. Highly musical.

Alan Tracy – Trained astronaut and pilot of TB3. Also a grand prix champion driver. In love with Tintin.

Gordon Tracy – Ex member of WASP (see your Stingray annuals), pilot of TB4.

John Tracy – Pilot of TB5, spends long missions alone in space due to excessive ugliness.

Brains – Real name Horatio Hackenbacker. Child prodigy and genius, designer of the Thunderbirds.

Kyran – Long time friend of Jeff, does the cooking (right on) and looks after the decor on Tracy Island.

Tintin – Only daughter of Kyran, deeply in love with Alan. Technical Expert.

Lady Penelope – Aristocratic ex-secret agent: rides a six-wheeled pink Rolls Royce, FAB 1, chauffeured by Parker.

Parker – Aloysius Parker, reformed burglar recruited as chauffeur by Lady P when caught robbing her house.

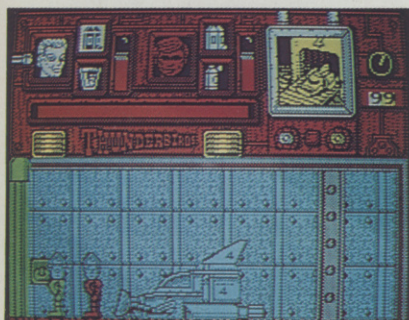

act effectively all IR operations must be top secret, so Parker and Lady P. are asked to break into the bank and steal the file. Later other Thunderbirds can regain the tape.

As well as the guards and the security systems that are set to delay and capture the intrepid pair, there are also a number of puzzles that require action from both characters to solve. The tension reaches hair-tearing stage when, deep inside the vault with the clocking ebbing away, you're forced to try various combinations of switches to open doors or get tools.



It's well worth investing time doing some biographical research on the characters, because special personal skills are required to complete the mission. Can you work out how to rob one of the safest banks in the world? If you do including part of the

Thunderbirds drama is yours to attempt.

Having established that it was your arch enemy The Hood who's been causing you all this grief, it's time to go and sort him out once and for all. You're not out to blow him limb from limb, however for Thunderbirds are far too nice to go around killing people. After all, it's impolite – and bad for the ratings. The Hood, though, has no such moral problems, and is preparing to blackmail the world with a fiendishly evil plan. International Rescue are the world's only hope, but that hope is fading fast as time runs out.

SECOND OPINION

"Although it's not as instantly attractive as some games I've seen, Thunderbirds has the kind of depth and longterm appeal that I find really rewarding. It seems like a game you won't tire of after a couple of days.

"And it's unlikely that any game this year will provide better value for money!"

SC

GREEN SCREEN

OK, father!

The graphics are a Spectrum upgrade, as the programmers at Slam HQ decided that it would be more appropriate to have comic cartoon style than block mode 0. The screens are detailed and pleasing with great depth of field – with, for example, the Tracys apparently walking between pillars of pillars. The humorous elements are very strong, entirely replacing the need for violent action. Just select the yo-yo as an item on level four to find out what I mean!

Thunderbirds cannot be called action packed – and neither are the very obvious Speccy style. But the game plays brilliantly, and has enough problems and puzzles to keep even Brains busy for weeks. Coming in a two cassette/disk pack with a free audio tape of all your favourite T'birds tunes it's a real value. When you've got Wolfed until you can barely touch a joystick, get out your Thunderbirds and give your brain a thorough (and, for the older ones among us, a nostalgic) workout.

TW

FIRST DAY TARGET SCORE

finish Mine Menace (level one)

The Verdict

GRAPHICS **72%**

- Souped-up Speccy.
- Great detail and variety.

SONICS **90%**

- Fun effects.
- Audio fun with the theme.

GRAB FACTOR **89%**

- Everyone loves the Thunderbirds.
- Mine menace is survivable and solvable.

STAYING POWER ... **95%**

- Four vastly complex and huge levels.
- Time limits make life very awkward.

AA RATING **90%**

- Outrageously good value for money.
- Infuriatingly addictive fun!

SILKWORM

Virgin Games ● £9.99 cass, £14.99 disk joystick/keys

Peace through superior firepower – a motto that will serve you well in the world of *Silkworm*. Forget subtlety, forget style, just thrash and trash. Missiles are in unlimited supply, and as luck would have it so are the enemy.

The world has been ravaged by two small(!) nuclear wars. The politicians of the world finally see sense and scrap their apocalyptic arsenals in favour of conventional weapons. Naturally the generals wanted something in exchange for the ability to vaporise a planet. They demanded thousands of tanks, planes and assault helicopters until their bullets and bomb power matched that of their fission heyday.

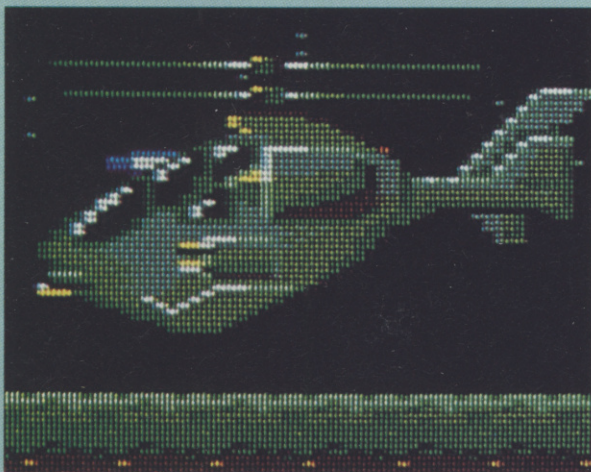

● Floats like a butterfly, stings like an Apache AH-64A!

After years of relative peace, however, those lovable chaps in green got bored of just 'playing' soldiers and have launched a coup to topple one of the major alliances. Thing is, if they take power they will give themselves back the bomb which could prove to be a pretty terminal situation for everybody.

These dogs of war must be stopped. Fortunately a few weapons scientists have escaped from the army bringing with them a small number of experimental helicopters and war jeeps. All that's required now is one or more volunteers to take the battle to the enemy and try to kill the top brass before they have a chance to toast us all.

Your mission is simple, you're to fly through enemy lines to attack the command 'copter, in which the generals reside. The first few waves are easily dispatched with fancy flying/driving and continued use of the trigger: just so much missile fodder. Each general though has a variety of special defences that must be avoided or killed to get to him.

Every level features plasma mines intended to destroy the jeep, but this is something that actually plays into your hands. If shot these mines release a cloud of gas which can

protect either vehicle from oncoming foes. If two of these mines are exploded and both clouds caught, then the chemicals react together and create an explosion effectively smart bombing the whole screen.

Some generals have large 'deathstar' satellites that take repeated shots before blowing up, others have tanks parachuted in just to add to the fun. Most levels though share one chief nasty – a gooseneck battle chopper. These helicopters fly onto the screen as six component parts and are invulnerable until they assemble – and are still virtually indestructible when joined together! They only have one weak spot, the eponymous goose neck, where the cabin joins the main body. Heavy duty blasting is required to get that one lucky shot and life is an awful lot easier in two player mode where more angles and more shots means more chances.

When a gooseneck chopper is finally shot down in flames (roast goose – lovely!) you can gain double firepower, strictly necessary if you are to survive the whole level. After picking up the extra blasting potential it soon becomes apparent why it's needed as onto the screen scrolls the biggest helicopter you ever did see. This is the generals' hide away, and the thing is not only hard to kill but has a mean selection of armaments to back up its threatening visage. Huge 'exocet' missiles are sent after the chopper, ball-mines are dispatched to bounce the jeep to death and homing missiles are sent launched to mop up anything they miss.

With the special weaponry and two players the first few command choppers aren't too tough, but lose your extra firepower and/or your partner and the whole thing becomes a nightmare. Having finally killed the enemy in a series of blinding white flashes you are transported to the next level where the whole sequence is repeated in faster, more densely packed form. Tooled up as you are with double shots, you start to think, is this as hard as it gets? Just wait, no sooner do you start to feel cocky than jets literally scream in on kamikaze runs. These boys really move and quick wagging



● Bang goes the peace plan!

SECOND OPINION

"Though ultimately it's a very limited kind of a game, Silkworm has enough going for it – especially in two player mode – to make it worth a try. It's no classic, but it's no dog either." SC

GREEN SCREEN
smooth as silk

becomes a matter of the utmost importance just to survive, let alone amass points!

The screen is always action packed, and the graphics are bright and move real fast. In two player mode the suppressing fire you can lay down is truly glorious, the helicopter best for attacking ground targets and the jeep airborne. It is also a shoot'em up that's very easy to get into, the first few levels being reasonably easy to survive, if not beat. It makes no claims to be innovative, just good clean blasting fun, a claim it lives up to admirably. TW

FIRST DAY TARGET SCORE

reach level three solo/
reach level six as a pair

The Verdict

GRAPHICS 83%

- Detailed and speedy sprites.
- Huge end of level 'chopper.

SONICS 64%

- OK explosions...
- and more fizz than fire for the gunshots.

GRAB FACTOR 79%

- Easy to get going.

STAYING POWER ... 65%

- Gets repetitive.
- Little level variation, just more enemies.

AA RATING 72%

- Simple but splendid.
- With a little more complexity *Silkworm* could have been even stronger.

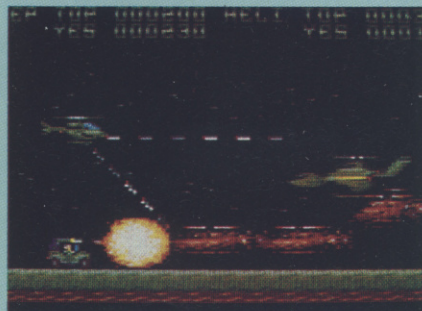

● Hang onto your hat, chaps, we're going in!



High Quality Repairs
Low Inclusive Prices
The Logical choice!

Technical Services

REPAIRS

Amstrad CPC 464.....£21.90
Amstrad CPC 6128.....£24.90

ACCESSORIES

CPC 6128 Rom£16.90
64K Ram Pack.....£43.90
MP2 Modulator.....£27.90
Printer Cable.....£8.80

All repairs guaranteed 4 months, prices quoted apply to any single fault ★ and are inclusive of parts, labour and VAT. Free return carriage for UK mail order customers. CPC 6128 Rom installation service available, only £8.00.

★ Excludes replacement of complete keyboard or disk drive assemblies (free estimate given).

VSE Technical Services (Dept 104), Unit 6,
8 Nursery Road, London SW9 8BP. Tel 01-737-0234

MAKE YOUR AMSTRAD EARN

Yes making money with your Amstrad becomes incidental when you know how. Your micro is, if only you knew it, a gold mine. The size and make is irrelevant. Make the initial effort **NOW** by starting your own

HOME BASED BUSINESS

This may be the most important move you will ever make!

REMEMBER: You'll never get rich by digging someone else's "ditch". Anyone in the country, including YOU, can become very rich in a relatively short period of time just by doing a few basic things! It's more rewarding than playing games. The benefits are many and varied. Full or part time. For **FREE** details send S.A.E. to:

HOME BASED BUSINESS

31, PILTON PLACE (AA3)
KING AND QUEEN STREET,
WALWORTH, LONDON SE17 1DR



ROCK STAR



Stiff Pickard ★

Could you manage this
Rock Star ?



CodeMasters Software Company Ltd., PO Box 6, LEAMINGTON SPA, CV33 0SH



GREAT STRATEGY GAMES

A superb range of Football & Cricket games for the Spectrum, Commodore & Amstrad
From E & J Software

TREBLE CHAMPIONS £9-95 Spec 48/128 : Ams CPC

A STUNNINGLY REALISTIC FOOTBALL STRATEGY GAME - Can you Win The League, The F.A. Cup & The League Cup - 4 Divisions of 20 Teams + 1 Div. 20 Non League Teams - Details of OVER 1500 Players - Results & Leagues ALL Divisions - League Cup with 1st, 2nd Rnds +S/Finals over 2 Legs - F.A. Cup includes Non League - Transfer Market buy ANY PLAYER ANY DIVISION - 3 Skill Levels -Start ANY Division - SAVE GAME - Time Management - Reserves - 2 In-Match Subs - Coaching + Fitness Training - PLUS MUCH MORE.

EUROPEAN CHAMPIONS £8-95 Spec 48/128 : Ams CPC

THE INTERNATIONAL CHALLENGE OF THE EUROPEAN NATIONS CUP - Genuine Nations Cup Format with full Random Draw of 32 Seeded Teams - Fixture List, Results and League Tables of ALL 8 Groups - Discipline & Medical Reports - Squad of 22 Players plus Other Players - 17 Month Itinerary of Qualifying Group, (Arrange Friendlies) and Finals - Plus many more Superb Features and Options. EUROPEAN CHAMPIONS includes E & J's MATCH PLAY SYSTEM which captures all the ACTION, DRAMA & TENSION of International Football.

WORLD CHAMPIONS £7-95 Spec 48/128 : Com 64/128 : Ams CPC

A COMPLETE WORLD CUP SIMULATION - Select Friendlies - 25 Players - Qualifying Group - 2 In-Match Subs - Discipline Table - Select Tour Opponents - Extra Time - final Rounds - Players Gain Experience - 7 Skill Levels - TEXT MATCH SIMULATION including: Bookings, Goal Times, Named & Recorded Goal Scorers, Injury Time, Corners, Free Kicks, Match Clock, Penalties - PLUS many more Features.

CRICKET MASTER £7-95 Spec 48/128 : Com 64/128 : Ams CPC

A SUPERB SIMULATION OF ONE DAY INTERNATIONAL/COUNTRY CRICKET - Weather, Wicket & Outfield Conditions - Batting & Bowling Tactics - Team Selection - Fast, Medium & Spin Bowlers - 4 Types of Batsmen - Select Field Layout - 3 Skill Levels - Wides - Byes - No Ball - Run Out - Misfield - Dropped Catches - Scoreboard - Batting & Bowling Analysis - Run Rate - Single Option - 3 Game Speeds - STARFEATURE a complete MATCH OVERVIEW showing Ball by Ball Action and Commentary and MUCH MORE!

TEST MASTER £8-95 Spec 48/128 : Ams CPC

A COMPREHENSIVE SIMULATION OF A 5 DAY TEST MATCH - Includes most of the Features of CRICKET MASTER and MATCH OVERVIEW plus Declaratons - Nightwatchmen - Light Meter - Rain Stops Play - Varying Number of Overs per Day - Follow On - Save Game - New Ball - Bad Light Interruptions - TEST MASTER is a True representation of a Complete Test Match and offers the ULTIMATE CHALLENGE to All Cricket Enthusiasts.

Above games available on disc @ Plus £4.00 Spec & Ams or Plus £2.50 Com PER GAME

ALL GAMES are available by MAIL ORDER for IMMEDIATE despatch by 1st class post and include Full Instructions. State which Machine & Tape or Disc.

(Add 50p per Game outside UK or £1-50 per Game for AIRMAIL outside Europe. Payment in Pounds Sterling Only)

Cheques or Postal Orders payable to E & J Software, SEND TO:

E & J SOFTWARE, Room A1, 37 Westmoor Road, ENFIELD, Middlesex, EN3 7LE

FANTASTIC DISCOUNTS

FULL PRICE GAMES ONLY
Buy 2 games deduct £3.00
Buy 3 games deduct £5.00
Buy 4 games deduct £7.00
Buy 5 games deduct £12.00

MODE-ONE

21 Orchard Drive
Burton-upon-Stather
Scunthorpe DN15 9EF
South Humberside.

☎ 0724 721204

Amstrad
CPC

Amstrad
CPC

★★★ LOOK!! NEW LOW PRICES ★★★

TITLE	CASS	DISC	TITLE	CASS	DISC
Airborne Ranger	10.80	14.05	Return of the Jedi	6.90	10.65
Arcade Muscle	9.99	12.99	Rambo III	6.90	10.65
Afterburner	7.40	10.65	R-Type	6.90	10.65
Barbarian II	7.40	10.65	Robocop	7.40	10.65
Batman (new)	7.40	10.65	Real Ghostbusters	7.40	10.65
Blastroids	7.40	10.65	Renegade III	6.90	10.65
Bubble Ghost	7.40	10.65	Red Heat	7.40	10.65
Butcher Hill	NR	7.40	Rock Star	NR	7.40
Cyberoid II	7.40	10.65	Running Man	NR	7.40
Chuck Yeagers AFT	6.90	11.80	Stormlord	7.40	10.60
Crazy Cars II	6.90	10.65	Savage	6.90	10.65
Command Perf.	9.99	10.65	Seek	7.40	10.65
Dragon Ninja	7.40	10.65	Silkworm	6.90	10.95
Dark Fusion	7.40	10.65	Spitting Image	6.80	10.65
Dominator	NR	6.90	Supreme Challenge	8.50	12.50
Echelon	10.60	12.99	S/D	7.40	10.65
Emelyn Hughes	7.40	10.65	Tatto Coin-ops	8.50	10.65
Fernandez Must Die	6.90	10.65	Thunderblade	7.40	10.65
Fist in Throats	9.00	12.99	Titan	7.40	10.65
Forgotten Worlds	6.90	10.65	Timescanner	NR	7.40
Game Over II (+1)	6.80	10.65	Total Eclipse	6.90	10.65
Galactic Conqueror	6.90	10.65	Typhoon	6.80	10.65
Guerrilla War	6.80	10.65	The Deep	6.90	10.65
Gunship	9.80	14.05	Victory Road	6.80	10.65
Giants	9.95	15.90	Vigilante	NR	7.40
Game Set & Match II	9.80	12.99	Vindicators	7.40	10.65
H.A.T.E	7.40	10.65	Wanderer (+3D Specs)	7.40	10.65
H.K Machine	7.40	10.65	War in Middle Earth	6.90	10.65
I.S Sphere	7.40	10.65	Wec Le-Mans	6.90	10.65
Jinks	7.40	10.65	Hit Squad	7.40	10.65
Live and Let Die	6.80	10.65	International Rugby	1.99	1.75
Last Duel	7.40	10.65	SAS Combat	1.99	1.75
Led Storm	7.40	10.65	Run the Gauntlet	7.40	10.65
Microprose Soccer	10.80	14.30	Roy of the Rovers	6.80	10.65
Netherworld	6.90	11.80			
Obitator	7.40	10.65			
Operation Wolf	6.80	10.65			
Outrun Europa	NR	7.40			
Pacland	6.90	10.65			
Pacmania	6.90	10.65			
Purple Saturn Day	7.40	10.65			
Question of Sport	10.80	14.30			
Run the Gauntlet	7.40	10.65			
Roy of the Rovers	6.80	10.65			

★ BUDGET-CASS ONLY ★ RRP OUR

BMX Free Style	2.99	2.60
Bomb Jack I or II (each)	2.99	2.60
Death Stalker	2.99	2.60
Ghost Busters	2.99	2.60
Hit Squad	2.99	2.60
International Rugby	1.99	1.75
SAS Combat	1.99	1.75
Twin Turbo V.8	1.99	1.75

★ LOOK!! ALL £2.99 BUDGETS NOW £2.60 - ALL £1.99 BUDGETS NOW £1.75!! ★★

This is only a small selection of titles we can supply (especially budgets!) Please write or phone for your choice if not shown.

All our prices include P&P & VAT within the UK. Eire & Europe please add £1.20 per item. NR = New release: Phone for availability

Please make cheques and postal orders payable to 'MODE ONE'



AMSTRAD SPECIAL OFFERS

AMSTRAD SPECIAL OFFERS

CASSETTE

CASSETTE

CASSETTE

DISKS

Artura.....3.99	Convoy Raider.....1.99	ISS.....3.95	Road Blasters.....6.50	Trivial Pursuit (Standard) ..4.95	Ballyhoo6.00
Action Force1.99	Chall. Gobots......99	IK+.....1.99	Rolling Thunder.....3.95	Trivial Pur. (Baby Boomer) 4.95	Station Fall.....6.00
Afterburner5.99	The Centurions......99	The Inheritance......99	Runestone......99	Trivial Pur. (Young Plays) 4.95	Cut Throat.....6.00
Austerlitz.....3.99	Dan Dare II.....2.79	Jackal.....1.99	Ramparts.....1.00	Thunderblade.....5.95	Suspect.....6.00
Aufweidersein Monty ..2.99	Dandy......50	Johnny Reb 2.....2.99	Return of the Jedi.....3.99	Target Renegade.....5.95	Hollywood Hijinx.....6.00
Andy Capp.....1.99	Dragon's Lair.....1.99	Karnov.....1.99	Roy of the Rovers.....3.99	Tobrook.....3.95	Sorceror.....6.00
Army Moves.....2.79	Dragon's Lair II.....1.99	Knightmare.....1.99	Red Scorpion......99	Venom Strikes Back2.95	Microprose Soccer12.99
Batman.....6.99	Dambusters.....1.99	Kinetik......99	Spy V Spy Trilogy.....3.99	View to a Kill.....1.99	R-Type.....8.95
Battlefield Germany...5.99	Dark Sceptre.....1.99	Killed Until Dead.....1.99	Strip Poker II+.....3.99	Wonderboy.....4.95	Rampage.....4.95
Blasteroids.....6.99	Emlyn Hughes Soccer...6.99	Krypton Factor.....3.99	Super Hang On.....3.99	West Bank.....2.99	Karnov.....4.95
Ball Blazer......99	Empire Strikes Back...3.99	Leaderboard.....2.99	720°.....2.99	Xarq......50	Predator.....4.95
Black Magik......99	Eidolon......50	Lazer Tag.....1.00	Super Sprint.....1.99	Yogi Bear.....1.50	Cholo.....2.99
Bedlam.....1.99	Every Second Counts...3.99	Mega Apocolypse.....1.99	Star Raiders II.....1.99	Zynaps.....2.99	Terror of the Deep.....2.99
Bride of Frankenstein...99	Flunky......50	Mutants.....1.99	Street Machine.....1.99	Xeolon.....2.99	Sai Combat.....2.99
Bubler......99	Fernandez Must Die...2.99	G.G. Match Cricket.....1.99	Scaletric.....3.99	Cybernoid.....3.99	Dynamite Dan 2.....2.99
Blood Brothers.....3.99	Future Knite.....1.99	Monopoly.....3.95	Slane.....1.99	Garfield.....3.99	Football Director II....5.95
Baseball.....1.99	G.F.L. Football.....2.99	Nebulus.....2.99	Spy Hunter.....2.79	Skate Crazy.....3.99	Wonderboy.....6.95
The Big Sneeze.....1.99	F.Ball Manager II.....4.99	1942.....2.79	Survivor......99	Gnome Ranger.....3.99	Waterloo.....5.95
Bionic Commando.....4.99	The Fury.....2.99	Nomad......99	Sea Base Delta......50	Tali Ceti.....2.99	Mario Bros.....4.95
Blockbusters.....3.99	G.B. Air Rally.....1.99	Nexor......50	Star Wars.....3.95	Waterloo.....3.99	Afterburner.....9.95
Bullseye.....3.99	GreyFell......99	North Star.....1.99	4 Soccer Simulators...4.95	Rex.....3.99
Battle of Britain.....2.99	Gliderider.....1.99	Nosferatu. The Vampire...1.99	Starglider.....3.95	Typhoon.....5.99	JOYSTICKS
Battle for Midway.....2.99	Gothik.....1.99	Nemesis (Final Challenge)..1.99	Sorceror Lord.....5.95	Thing Bounces Back...1.99	Ram Delta.....9.95
Cylu......50	Gauntlet II.....2.99	Nemesis Warlock.....1.99	Spitfire 40.....3.95	Thing on a Spring.....50	Speed King.....9.95
The Colour of Magik...1.99	Gladiator......99	Out Run.....6.50	Techno Cop.....5.95	Gunship.....9.50	BMX Sim. 2.....2.99
Crazy Cars II.....6.99	Guadal Canal......99	Out of this World.....50	Total Eclipse.....3.95	Equinox......99	Mega Blaster.....5.95
California Games.....2.99	Gunsnoke.....2.99	Premier II.....2.99	Through the Trap Door 1.99	Caves of Doom......99	Navigator.....9.95
Cluedo.....3.99	Heroes of the Lance...5.95	Pulsator......99	Terramex.....1.99	Chicken Chase......99	Cheta 125+.....7.50
Clever & Smart......99	Hercules.....3.99	Prodegy......50	Thundercats.....3.95	Finders Keepers.....75	Challenger.....7.95
Champ Sprint.....2.99	Hijack......50	Pegasus Bridge.....5.99	Throne of Fire......99		
Captain America.....1.00	Hive......50	Predator.....3.95			
		Paperboy.....3.95			
		Quartet.....2.99			
		Road Runner.....1.99			
		Rygar.....1.99			

All orders under £5 please add 50p towards Postage & Packing.

All orders over £5, Postage & Packing FREE

No Overseas orders please.

All in stock items despatched by return

CASSETTE COMPILATIONS

BEST OF ELITE VOL 2

Paperboy,
Ghosts & Goblins,
Battleships,
Bombjack 2

ONLY £4.99

GIANTS

Rolling Thunder,
Gauntlet II,
Outrun,
720°,
California Games

ONLY £5.95

GOLD, SILVER, BRONZE.

Summer Games 1,
Summer Games 2,
Winter Games

ONLY £7.95

CASSETTE COMPILATIONS

1,2,3.

BMX Kidz,
Ninja Master,
Rock & Wrestle

ONLY £2.99

SUPREME CHALLENGE

Elite, Ace II,
Tetris,
Starglider,
Sentinel

ONLY £5.95

CASSETTE COMPILATIONS

4 SMASH HITS

Zynaps,
Exelon,
Rana Rama,
Euridium +

ONLY £4.99

TEN GREAT GAMES VOL 2

Auf Weidersehen Monty,
Samurai Trilogy,
The Duet, Mask,
Convoy Raider,
Jack Nipper II,
Deathwish III,
Basil Mouse Det,
The Final Matrix,
Thing Bounces Back

ONLY £5.95

CASSETTE COMPILATIONS

KNIGHTORK

Loosed Orc,
Hordes of Mountain Kings,
A Kind of Magik

ONLY £3.95

COMPUTER CLASSICS

Into the Eagle's Nest,
Dynamite Dan,
Zynaps,
Alien,
Culdron II

ONLY £2.99

MAGNIFICENT SEVEN

The Great Escape,
Wizball, Arkanoid,
Short Circuit, Frankie,
Stalone Cobra,
Head Over Heels,
Yie Ar Kung Fu

ONLY £5.95

SKATE OR DIE

Electronic Arts • £8.95 cass, £14.95 disk joystick/keys

Let's meet and greet, folks, surf punk Lester, a man born to ride the sidewalks on his customised day-glo board. His worldview is simple: *Skate, or Die*. Middle ground is not a phrase in his vocabulary.

Decked in luminous jams, baggy T-shirt and mohawk haircut, the guy *lives* the part. The question is, dare you join him on his crazy downhill charges, jousting in an empty pool and performing ridiculous tricks on a ramp?

SOD offers boarders five ways of living on the knife-edge between wild fun and serious physical damage. Show out on the ramp, doing freestyle or hi-jumps, race through back streets fighting with Les, or sort out who's the boss in a face to face showdown in the joust. You can even, if you're really sick, opt for a downhill race with jumps, hurdles and tunnels. A novel way to cripple yourself permanently.

The freestyle arena, with the high jump and tricks option, is the most exhilarating on offer. You build up momentum and start to fly. All manner of stunts can be introduced to the routine to gain points. Hurtle off the screen - hey... Why not? - into the sky spinning like a top, arms casually flung above your head. Grab the lip of the ramp as you shoot past and pivot, doing a 360, or simply balance on the



● 'Seasy, this - anyone could do it!

strip and you sprawl to the centre, your deck smashing into your knees. No permanent injury is ever sustained, this being software an'all, so you're soon back on four wheels.

You use joystick/keys to tell your guy what to do. But only in the loosest fashion, as he invariably does what he wants anyway. Having only a certain repertoire of moves your skater is never going to pull off any great mould-breaking jumps.

The same applies to the high jump, set in the same arena but lacks the fun of throwing yourself upside down. All that's involved here is repeated rolling and then launching for the stars.

Get bored of air sickness and progress to other stages and the schizo nature of the game soon reveals itself. Continuity? Forget it! The switch to racing against Lester is accom-

panied with a change to monochrome. Downhill requires a great degree of luck (to get obstacles lined up) as well good judgment to avoid the many dangers. Jax - fighting on skateboards while rolling through a deserted alleyway - is much the same with different backgrounds. But you do at least get a better class of crash, such as the wire fence which neatly slices you into bite-size chunks.

The final stage - though stages can be played in any old order - is The Joust, in which you face Our Boy Les and a coupla friends, guy (know whaddamean?), in a head to head. Ultra violence on wheels is what it should be, but it ends up (or down) as a rather confused game of pass the baton/follow the leader.

On some levels there's a "goofy foot" feature, which - hey, get this - *inverts the direction/control relationship!* Quite what this is supposed to represent is unclear: it's no fun at all to be completely out of control on and off your board, and the only result is the inevitable crash. It's frustrating and

by no means a

Wild Bunch

The characters responsible (if that's the word) for *Skate or Die* - Michael Kosaka, Stephen Landrum and David Bunch - are a self-confessed "wild bunch," about whom nothing is known beyond a few strange and worrying facts. They list their hobbies, wackily, as "bare-handed jackal hunting" and "sculpting rodents out of ceramics."

Oh dear. You should remain in your homes until the apprehension of these people has been announced. Emergency services have been alerted.

SECOND OPINION

"Oh for what might have been! At times SOD really does get off the ground and become airborne, only to be brought down hard by mono graphics, poor sound or the bizarre lack of consistency in appearance and gameplay. And what's with this 'Goofy Foot' stuff anyway?"

"I've long been one of EA's biggest fans, but this one never gets above the mediocre. It looks like a troubled project, and plays like one." SC

GREEN SCREEN

you're not missing out on colour!

edge using exquisite balance to defy gravity for a couple of seconds.

These manoeuvres have their perils though, as your kneecaps all too soon discover when a trick backfires. Try to use the wrong part of the ramp, cut too sharply or forget to line your board up with the landing

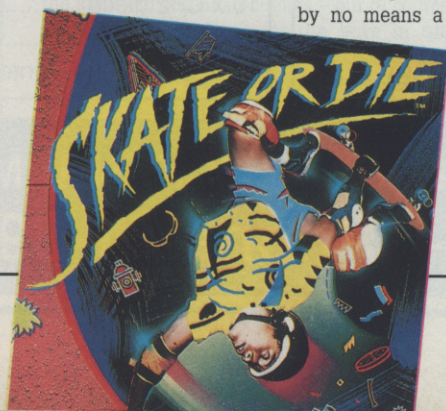

challenging modification.

Skate or Die is chockful with good ideas, but obstinately fails to deliver on all but one of them, namely the freestyle. Ultimately what it lacks is a coherent personality to bring out the humour that's so obviously there. It could have captured (and on the tricks section does capture) skateboarding's going-for-broke spirit. Bitty structure erodes this fast, and while the game is bound to sell in droves because EA have cashed in on the current skate craze, the conceptual effort could have been more fruitfully implemented.

TW

FIRST DAY TARGET SCORE

10,000 points on tricks



● Skateboards away!

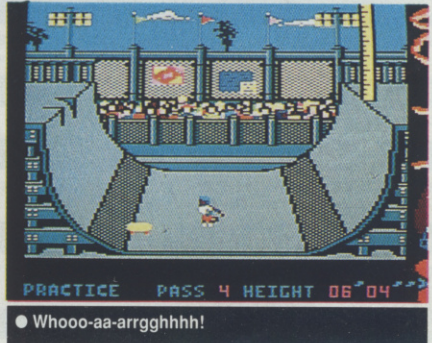

● Whooo-aa-arrgghhhh!

The Verdict

GRAPHICS 47%
 ■ A pick'n'mix of graphic styles.

SONICS 37%
 ■ Underwhelming.

GRAB FACTOR 64%
 ■ Great idea, and fun for a while.

STAYING POWER .. 27%
 ■ No depth for repeated play.
 ■ Many stages, but little variety.
 ■ Unlikely to be a favourite.

AA RATING 48%

■ If this is skating I'd rather die!

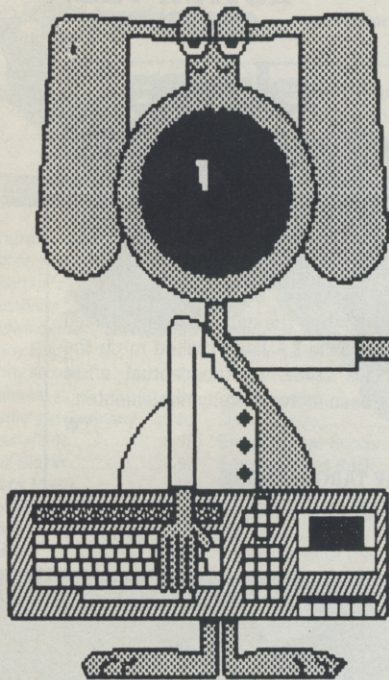

WACCED

unbeatable prices, unbeatable service

THE FANZINE

ANNUAL SUBSCRIPTION RATES

UK.....	£15.00
Europe	£22.50
Overseas	£30.00
Current issue	£1.25

- * Fully illustrated
- * Over 20,000 words per month
- * Proper A4 format

Letters, Basic, Comms, Mcode, Hardware projects and much more.

A truly
Alternative
Fanzine

CASPELL RIBBON REFRESHER
An 8oz can does up to 30 ribbons
ONLY £7.95 PER CAN

THE SPECIAL OFFERS



Advanced OCP Art Studio — £18.95

OCP Art Studio — £15.95

The Advanced Art Studio, bundled together with the Genius Mouse, Interface and Mouse Mat — £49.95

THE PUBLIC DOMAIN SOFTWARE

CPM DISC 1 – MACHINE CODE TOOLS Price £5.50

Z80 and 8080 assemblers, Z80 to 8080 to Z80 code translator, Debugging monitor and assembler, Reverse assembler, Binary file comparer, plus NewSweep and more.

CPM DISC 2 – COMPUTER LANGUAGES Price £5.50

Small-C, Prolog, Lisp, EBasic, Small-C-Interpreter plus NewSweep.

CPM DISC 3 – FILE AND DISC MANAGEMENT Price £5.50

Library utilities, Disc quality checker, Unix GREP command, PCW disc reader, Disc sector editor, Text file sorter, Word counter, plus NewSweep and more.

CPM DISC 4 – AT YOUR LEISURE Price £5.50

Cave Adventure, Chess, Othello, Golf, Word search, Biorhythms, Maze generator, On-screen calculator, Prolog, Comms utility, plus NewSweep and more.

CPM DISC 5 – THE BUSINESS Price £5.50

Scrivener spreadsheet, Inventory database, Powerful text editor, Spelling checker with dictionary, Sorter, Word counter, Comms utility, plus NewSweep and more.

CPM DISC 6 and 7 – PASCAL PLUS (Two Discs) Price £9.00

Pascal, SCI, Cobol, EBasic, Powerful text editor, plus NewSweep.

CPM DISC 8 – MORE COMPUTER LANGUAGES Price £5.50

Forth, Stoic, Cobol, Expert 86, Powerful text editor, plus NewSweep

CPM DISC 9 – COMMUNICATIONS Price £5.50

Mex, Kermit, Kermode, Interface and Smart-Modem, overlays, source code, plus NewSweep and more.

PLUS * PLUS * PLUS * PLUS * PLUS

Public Domain software support available to WACCI subscribers.

Mega-big homegrown library

Send a large SAE for details (E and OE).

Micro Music Creator Rom	19.95
Micro Music Creator Disc	11.95
Ram Delta Joystick	8.50
Kador Seal 'n' Type covers.....	7.95

MasterCalc 128	24.95
MasterFile III.....	29.95
MasterCalc AND MasterFile	49.95

Prottext (CP/M+)	47.00
Pocket Prottext (CP/M+)	23.25
Prottext Filer	19.50
BCPL (CP/M+)	19.50
Arnor C (CP/M+)	39.00

Rombo Rom Box.....	27.00
VIDI-CPC digitiser	68.00
5 x CF2 discs (yes we've got them!)	11.95
10 x CF2 discs	22.95
20 x CF2 discs	44.95
DMP 2000/3000 Printer Ribbons (each).....	£2.95

WACCI UK, 9 SOUTH CLOSE, TWICKENHAM, MIDDX TW2 5JE
Est. 1986 — Phone 01-898 1090

XYBOTS

Domark/Tengen ● £9.99 cass, £14.99 disk joystick/keys

The air is charged with burnt ozone, the blaster cannon is red hot in your hands, while in front of you lies a twisted smouldering xybot. Major Hardy casts a wry smile at you: "The only good xybot is a dead xybot," he mutters. No time to rest though, there's too much metal to melt. And so off you charge into the smoke filled corridor. "Do you feel lucky 'bot? Go ahead, make our day!"

Captain Ace Gunn and Major Rock Hardy – daft names, or what? – are raiding a xybot base. The mission is to kill the master xybot, and wreak as much havoc as possible along the way. A straight firefight is out of the question, since xybotland is a confused mass of mazes and teleport systems. Stealth and tactics are more effective than brute force, but you've got to be ready to stand and blast in critical situations.

The first few levels of xybotville are mapped out for you at the top of the screen to help you find the tin men and the exit. Later this map is drawn as you venture around vapourizing 'bots, which only really helps in retreat. Alongside sit status boxes constantly flashing news to you of imminent demise and weapons info.

The maze feel is enhanced by using splitscreen perspective graphics. Your guy chases off down the corridor and the whole room moves past him. He can easily (except

in combat) be turned to look around corners and on unknown levels both parties can split up and share their information. It's really confusing to watch as your mate steams past and you catch a glimpse of yourself from his angle. Remember, you too can be hurt by the other guys shots and not just the 'bots.

Xybots does have a few twists to justify wholesale destruction. Firstly you've got to collect the various items left lying around the place to improve your chances of a long and happy life, secondly to beat increasingly nasty Master Xybots every three or four levels. Most importantly you need to find the energy capsules vital to life. The energy limit (effectively your time and hits counter) runs down real quick, and it's neces-

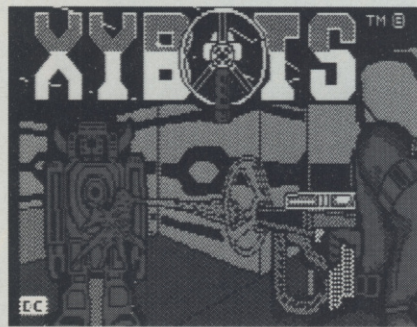

● Major Rock and roll

sary to pick up supplies along the way on the larger levels just to cover the ground.

Some 'bots are more difficult to kill than others, armoured up and only exposing themselves (?) when shooting you. Huge blue 'bots roam about and while easily killed they've powerful cannon. Some xybots come at you on suicide runs wiping out vast amounts of life energy if successful. Sundry other surprises include walls which open when unlocked to reveal large numbers of trigger-happy androids breathing oil fumes in your face.

As usual in this sort of war zone someone's out to make a quick buck and yet more weapons shops have been opened to tool up nutters on the rampage. There's money to be made in supplying the bloodbath trade, first *Vindicators*, then *Forgotten Worlds* and now *Xybot Central*. Everything can be bought for a price. Enormous coins are left around by zapped xybots for you to pop into your piggy bank and save toward a stronger shield, guard mapper or what you will.

The two player option confuses matters but also adds a new dimension to play with the ability to outflank enemies – but of course the same is also true for the boys in tin. Things get mean out there in 'bot country and you can never just take things easy. Lasers are always screaming in from distant 'bots and new style machines constantly rear their ugly bonces, forcing you to discover how on earth to go blow it to pieces!

An exceptional arcade conversion in its accuracy *Xybots* falls short of the mark. No

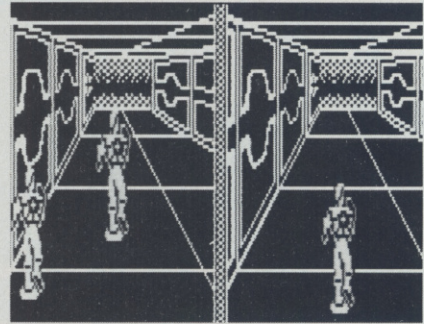

● Kicking 'bot!

programmer can convert a coin-op and make it brilliant if the coin-op falls short in the originality department. *Xybots* in either form – CPC or arcade – is exciting for twenty minutes but dull after an hour. Running round and roasting robots is passable fun, but it doesn't hold up well for long, even with tight time/energy limits to inject tension. *Xybots* does have one saving grace: when the game gets dull you can always turn rogue and surprise your partner with a few stray shots!

TW

FIRST DAY TARGET SCORE
70,000

SECOND OPINION

"These guys walk like they've spent the week on a horse – which is true to the arcade. In fact everything about this game is as arcade-like as possible on the CPC. Which is a pity, because I never was that crazy about it."

SC

GREEN SCREEN
still smart

The Tengen connection

Domark's much-vaunted Tengen label is proclaimed as "the new name in coin-op conversions." First out of the starting blocks a few months ago was *Vindicators* (AA43), which was deservedly Mastergame. Other projects on the boil for later this year include *APB* (which stands for *All Points Bulletin*) and *Toobin'*. With two excellent conversions – *Xybots* limited only by the mediocrity of the original – we look to be in for a real treat if the Domark boys can keep up the good work!



● *Vindicators* – the first Tengen/Domark release

The Verdict

GRAPHICS 82%

- They keep that original flavour.
- Games screen complex but clear.

SONICS 75%

- Eerie atmospheric tune.

GRAB FACTOR 61%

- Controls are strange to use...
- ... but the best solution to a tricky problem.

STAYING POWER .. 69%

- Loads of levels to hunt around.
- Kill and collect is all there is to do.

AA RATING 76%

- Quality conversion of an average coin-op.
- Only as good as its parentage allows.

GERRY ANDERSON'S

THUNDERBIRDS

ARE GO!



©1989 ITC ENT. LTD. Licensed by ABP Ltd.

THUNDERBIRDS - THE COMPUTER GAME - You have joined the world famous International Rescue. In four, 'race against time' graphic adventures, you must prove your abilities to Mr. Jeff Tracey.

These include **MINE MENACE**, **SUB CRASH**, The **BANK JOB** and a final climatic meeting with your arch-enemy 'THE HOOD' in **ATOMIC TERROR**.

Can you solve the puzzles in time? Can you help **BRAINS**, **PARKER**, **LADY PENELOPE** and all the International Rescue team in four dangerous missions? The World is waiting for International Rescue, 5...4...3...2...1... **THUNDERBIRDS** are **GO!**

©1989 GRANDSLAM
ENTERTAINMENTS LTD.
12-18 PAUL STREET,
LONDON EC2A 4JS
TEL: 01-247 6434



AVAILABLE ON:

ATARI ST & AMIGA	£24.95
C64, AMS & SPEC DISK	£14.95
C64, AMS & SPEC CASS	£12.95

THE GAMES – SUMMER EDITION

Epyx ● £9.99 cass, £14.99 disk joystick/keys

Tension mounts as athletes crowd the arena. Bang! They're off, with the deafening roar of the crowd ringing in your ears. Then the TV packs in and the excitement is gone. "Not so!" I hear you cry: "what about *Summer Games*, *Winter Games* and now *The Games* by Epyx available now from all good software shops?"

This latest edition is lightly and somewhat belatedly based on Korea 88, and bears perhaps not unexpectedly a remarkable likeness to the other Epyx sports sims. There are eight events and nice opening and option screens. The events include archery, velodrome cycling (don't worry, I had never heard of it either), diving, hammer throwing, hurdles, pole vault, rings and uneven parallel bars.

The options include practice (disk only), review world records or go right in and compete with up to seven other players. The opening ceremony shows a map of Korea and pictures of its culture, while A Sickening Tune plays throughout.

- Diving is great fun, especially trying out the different variations. The diver can be made to spin, swan dive, belly flop or indeed do all three – and more. The only problem is that it is difficult to see where you ought to land, which can make for an interesting landing.

- Next is the velodrome, a sort of cycling up the wall against an invisible opponent (yes, really). It requires a good deal of waggling and a great deal of patience. It's rubbish.

● Alisdair Swanney, 14, wrote this review while with us on a week's work experience, in between giving the AA office the best tidy-up it's had since Trent lost a disk with a whole month's games reviews on it.

- The uneven parallel bars are like diving, with numerous easily mastered moves. Having said that, all I could manage was to push the joystick and hope I didn't fall off.

I fell off.

- The rings are the hardest event, and I did some more falling off before I could get properly started. But you can perform several moves, at least that's what the instructions say.

- Hammer throwing requires technique or the hammer wraps itself around your head.

- Hurdles is good but hard. You don't have to

SECOND OPINION

"Undoubted good value in that you get eight different events in one (multiloading) game. Worth it if you don't already have any similar compilations." SC

GREEN SCREEN
no bother

waggle too fast: it's more a case of accuracy. This probably explains why I can only do two before somersaulting and looking dizzy.

- Although the pole vault has been done numerous times before, this version is as good as they get. You build up speed by waggling rhythmically as the man runs towards you, and then you see him vaulting sideways on.

- Archery is my favourite. First you pull back the bow by pressing fire, then you take aim – a great deal of experimenting is needed at this stage. Finally you let fly by pressing the fire button again. Then it's time to see how you did, and to work out what went wrong.

Having competed in all these events it's time for you to receive the medals and listen to The Sickening Tune again.

This is only the second Epyx sports sim I've played, and I must say I enjoyed it. The instructions are well set out, and the diagrams and chalk talk (as the playing tips are rather cleverly called) are especially good. Inevitably there are bad points – the odd duff event, in

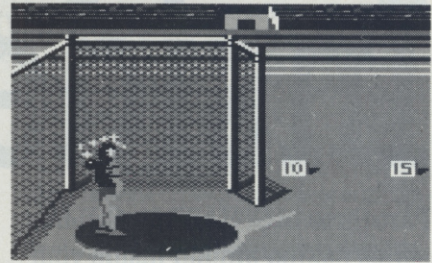

● There must be easier ways to get hammered...

this case velodrome cycling, and the fact that it's a multiloader. Overall, though, *The Games* is well worth investing in if you like this format or you're just beginning to build up a software collection. It may not occupy your screen for ever, but it's fun while it lasts. AS

FIRST DAY TARGET SCORE

Try not to fault when you vault!

The Verdict

GRAPHICS 82%

- Lots of colour.
- Very detailed, too.

SONICS 45%

- The odd hardly realistic beep.
- A Sickening Tune.

GRAB FACTOR 68%

- You have to wade through the instructions.

After that you can't stop!

STAYING POWER ... 73%

- You can continue to improve.

AA RATING 71%

- To be kept for a long afternoon.

SUPER SCRAMBLE SIMULATOR

Gremlin ● £9.99 cass, £14.99 disk joystick/keys

"Never, never, under any circumstances trust a game with the words Super and Simulator in the title" my old grandad used to say to me. He would never have been taken for a ride by SSS.

The race against the clock is split into five sections, each containing three different courses to test your skill as a rider leaping massive obstacles in a single bound. Trenches, though only six inches deep, throw you completely: go too fast and you're in the grass; too few revs and the engine dies between your legs leaving you literally over a barrel.

But disappointingly no bodies fly, and no machinery is smashed. If you can't be a rubber neck what's the point of motor sport?

Gameplay is tricky and slow, with controls too closely grouped. Everything is done on the joystick and since simultaneous actions are often required life is not easy.

Graphics are functional and unimaginative. As usual Ben Daglish, who did the marvellous music for *HATE*, has put together a great audio track, but £9.95 for an audio tape is just too much to ask. TW

FIRST DAY TARGET SCORE

clear five stages

SECOND OPINION

"Neither an original theme, nor imaginatively handled. Full price? Forget it." SC

GREEN SCREEN
suppose so

The Verdict

GRAPHICS 46%

- Unexciting.

SONICS 84%

- Superb tune, as you'd expect from Ben D.
- Dull sound effects.

GRAB FACTOR 22%

- Far too fiddly.

STAYING POWER ... 43%

- Plenty of stages.
- But that's not enough to grab anyone.

AA RATING 39%

- ... I've had more interesting headaches.

Inside out

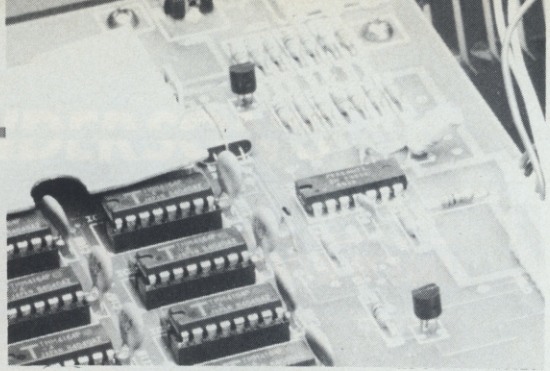

Part three of STUART McCOLL's series poking around inside your CPC.

We identified a microcomputer earlier in this series, you may recall, as a bus organised structure consisting of a processor and various peripheral devices. The choice of input/output devices is clearly flexible, depending on the application - but every system must have a central co-ordinating processor unit (CPU) which can fetch and execute user programs.

So the CPU is the most important single device in any microcomputer - which is why it's necessary to switch our attention to the consideration of a simplified but typical microprocessor architecture.

Without further ado, then, let's crack open that omnipotent (and big) black chip housing the CPU.

What is a CPU, then? Well, in this context, it's that part of a digital computer which implements the system operations. It has a number of internal storage registers - as opposed to external memory, only available to the CPU over the conventional system buses; a combinatoric circuits which perform all the arithmetic and logic micro-operations (see below); and finally a control unit which supervises the sequence of micro-operations.

Figure 1 illustrates a simple CPU configuration. Bear in mind that a processor, like everything in a digital system, is constructed from simple devices such as logic gates.

The control unit

It is well known that the lowest level of computer programming is machine-code. But it ain't!

It ain't, because for every machine instruction - the lowest level a computer user can access - there is a corresponding sequence of micro-instructions or a micro-program stored within the CPU control unit.

micro-program, and each micro-program represents a series of discrete steps which must be followed to execute a machine level instruction. Such steps are necessarily very simple in their nature (see ALU below) and it is only by convoluted combinations that relatively complicated machine instructions may be provided in the processor instruction set.

The format of micro-instructions is highly

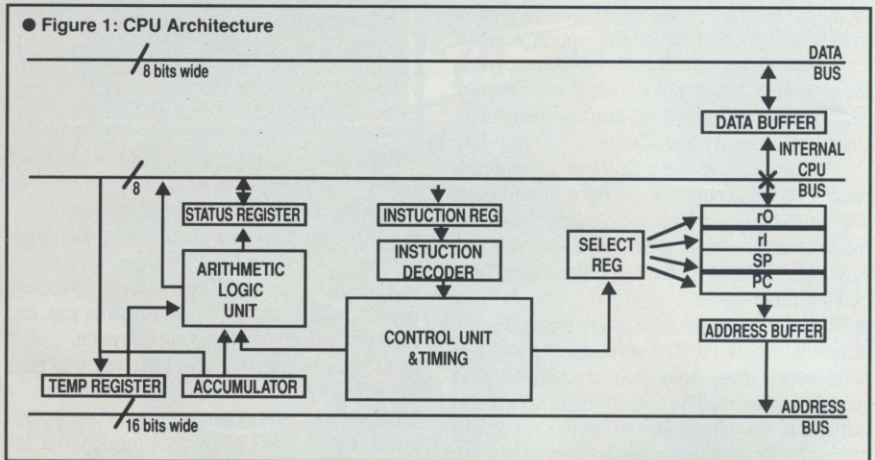

When the CPU is started (usually by a RESET control input) it begins executing a microprogram which fetches an instruction from memory and stores it in the Instruction Register (IR). This machine instruction is then decoded by some sequential circuitry and the address in control memory at which the corresponding micro-program resides is generated. This micro-instruction is then executed on the next clock cycle. A control unit such as this is illustrated in Figure 2, and is commonly referred to as a Microprogrammed Control Unit.

variable, but it must contain fields which can be used to generate the address (in control memory) of the next micro-instruction to be executed, as well as a control field which specifies the required registers and ALU operation. Normally there will be a choice of at least four "next" addresses fed into the control unit:-

- 1) the next sequential address
- 2) current address + relative offset stored in BRANCH field
- 3) address stored on internal control stack
- 4) an external address specified by the decoded machine instruction.

The control unit simply selects one of these inputs as the next control address.

Figure 2 illustrates how the various fields of a generalised micro-instruction may be used. The control fields are the source of, for example, the inputs to the ALU function and register select.

The Arithmetic Logic Unit (ALU)

As its name implies, the ALU performs arithmetic operations such as ADD, SUBtract, INCrement and DECrement, and logic operations such as AND, OR, XOR on the data selected as input. These are examples of the elementary operations which can be executed by a single micro-instruction. More complicated instructions such as multiply and divide are performed by repeated addition and subtraction, which must be accomplished by software: the Z80 can't do those without help.

● Figure 2: Microprogrammed control unit

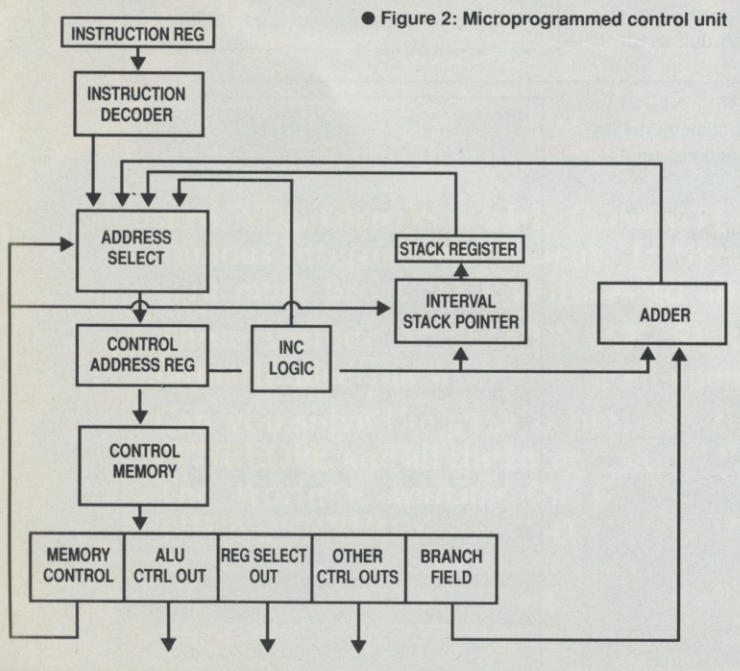

Don't confuse the control memory with external memory, or indeed the internal CPU registers. It is a completely separate Read Only Memory (ROM) which is built into and accessed solely by the control unit. Each word of this memory stores a micro-instruction, whereas each word of external memory holds either a machine instruction or data.

A sequence of micro-instructions is called a

Internal Registers

Most modern processors have a collection of general internal storage registers which are used as inputs and receivers of information from/to the ALU. For example the Z80 processor (as used by your very own CPC) has an ample collection of 16 general registers, labelled A, F, B, C, D, E, H, L, and their dashed alternates (*watch your language McColl - ed.*)

- A few specialised registers are also necessary to enable the CPU to operate smoothly:-
- 1) The Stack Pointer (SP), which holds the next available address in a LIFO data structure.
 - 2) The Program Counter (PC), which holds the address of the next instruction to be retrieved from external memory.
 - 3) The Instruction Register (IR), which holds the machine instruction currently being executed.
 - 4) A Memory Buffer Register (MBR) which is used to hold data transmitted over the data bus, until the processor is ready for it.
 - 5) A Memory Address Register (MAR) which buffers the external addresses supplied by the PC or SP.

Each micro-instruction of the control unit contains a field which specifies the registers it will work with. For example when each word is transferred from main memory by the "fetch" micro-program (Figure 3), a micro-instruction is executed to update the PC. The register select field of this microinstruction selects the program counter as a data input to the ALU, and the control field specifies an INCRement operation.

In our discussion of the CPU, I have used the terms Processor and Central Processor Unit (CPU) interchangeably, and indeed you'll find that the normally precise computer boffins do the same.

There is, however, a fine distinction. A Processor is comprised of a number of registers and the digital functions that implement arithmetic, logic and shift operations. A Central Processor Unit on the other hand is the name given to a Processor which incorporates a Control Unit.

You'll find too, when reading computer literature, that it is riddled with the terms "Machine Cycle," "Clock Cycle" and "Instruction Cycle," and it is important to understand the distinction.

A Clock Cycle is the amount of time it takes to execute a single microinstruction.

Some nasty language

A Machine Cycle (or memory cycle) is the length of time it takes to

transfer a word between the CPU and memory, or vice versa. A machine cycle is comprised of several clock cycles.

An Instruction Cycle is the length of time it takes to execute the instruction stored in the IR. It is composed of at least one machine cycle - the opcode fetch, and perhaps several other data transfers.

Can you work out why, for example, a micro-programmed multiply or divide routine invariably executes many times faster than the corresponding machine code program - however efficient? No? Well, look at Figure 3. Every micro-instruction (such as ADD and SUB) is executed in a single clock cycle, which is many times shorter than the time it takes to execute an equivalent machine level instruction.

Decoders

Have you noticed how the word *selected* kept cropping up in our discussion of the CPU? Well, you may have already guessed that there are special devices which facilitate activities such as selection, and it is to them that we now turn our attention...

No, it's nothing to do with cryptography. A decoder is a combinatoric device (which, as you will of course remember, means we can predict its outputs from its inputs) with n-inputs and 2n enable outputs. At any given time, only one of the 2n outputs will be logically TRUE - the other 2n-1 outputs being FALSE. It is convenient to consider the

n-inputs as a binary number, enabling one of the 2n outputs.

Figure 4 illustrates a simple one input to two output, or 1-2 decoder, and the corresponding truth table. The logic circuitry - a simple NOT gate - is trivial, and I'm sure you can see how it works quite clearly. If I0 is FALSE (which we will consider to represent binary 0), the top output, E1 will be TRUE, while E2 is FALSE. Similarly, when I0 is TRUE, E1 is FALSE, and E2 is TRUE, or enabled. Thus only one enable output is true at any given time.

Figure 5 illustrates a more practical 2-4 decoder such as that which may be found as part of the CPU register select circuitry of Figure 1. In this case, the logic expressions for each of the outputs E1 - E4 is illustrated next to the corresponding line of the truth table. These expressions introduce the more usual (or succinct) symbols for the logical operators. You should corroborate for yourself that these are correct, and that the logic diagram is simply a schematic representation of the expressions.

Rather than repeatedly drawing the constituent gates of a decoder (it becomes laborious even for a small 2-4), simple boxes such as those illustrated in Figures 4 and 5 are used as schematic representations.

From Figure 1 how do you think we could use a decoder's outputs to route the selected register through to the internal bus? Or perhaps you can see how decoders might be used in conjunction with a micro's address bus?

As you can see, I've only covered half of the selection story, so let's see if you can puzzle out the rest before next month. As a hint, I don't think I would be giving too much away by suggesting you investigate the properties of the ever modest AND gate... ●

And Stuart McColl will be giving much more away about the ever modest AND gate in next month's Inside Out

● Figure 3: an instruction cycle

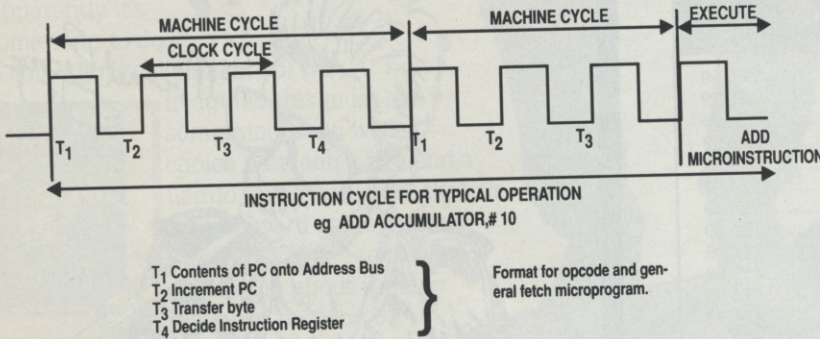

● Figure 4: 1-2 Decoder

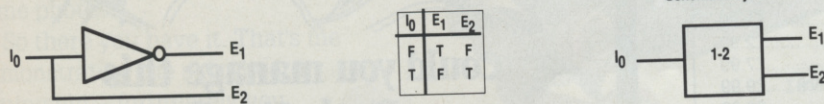

● Figure 5: 1-2 Decoder

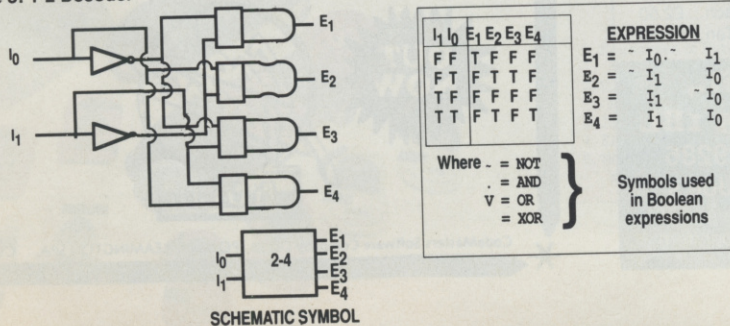

IRENE SOFTWARE

ADD AN 800K DISC DRIVE TO YOUR CPC

Our 80 track double sided 3.5 inch disc drive will allow you to store 800K on a single 3.5 inch disc. The drive is a slimline 1 inch high citizen mechanism (as used on the Amiga and ST) and comes complete in a steel casing and with a power supply and cable to connect to the computer (please specify 464/664/6128). We have three different software packages that complete the system, RAMDOS & ROMDOS by KDS software (ROMDOS is a ROM version of RAMDOS) or RODOS by ROMANTIC ROBOT. 464 owners must already own a first drive and interface before they can use our drive.

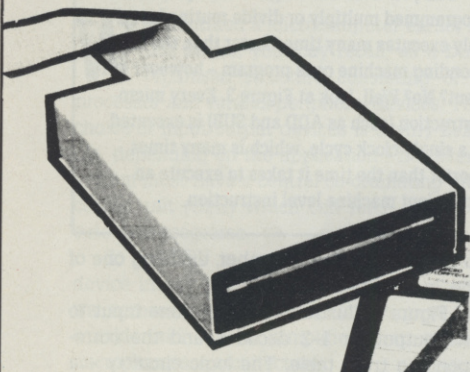

NEW LOW PRICES! SAVE £15.00 ON ALL DRIVES

Disc drive with RAMDOS	£109.99
Disc drive with ROMDOS	£119.99
Disc drive with RODOS.....	£119.99
Blank 3.5 inch disc.....	£1.00
ROMBOARD (holds 6 ROMS).....	£24.99

All prices include VAT and postage



TELEPHONE
061 228 1831



84-86 PRINCESS ST. MANCHESTER M1 6NG.

50 GOOD REASONS TO SHOP AT CRAZY JOE'S

10 Computer Hits 5.....	£6.99	Prodigy	£1.99
10 Great Games 3	£6.99	Real Ghostbusters.....	£6.99
1942.....	£2.99	Red Heat	£6.99
3D Pool.....	£6.99	Renegade 3.....	£6.99
720'	£2.99	Return of the Jedi	£4.99
Army Moves.....	£2.99	Silicon Dreams	£4.99
Barbarian 2	£6.99	Skweek	£6.99
Blasteroids.....	£6.99	Split Personalities	£1.99
Bombjack 2.....	£1.99	Spy Hunter.....	£2.99
Chuck Yeager A.F.T.....	£6.99	Storm Lord.....	£6.99
Dynamic Duo.....	£4.99	Superman.....	£5.99
Emlyn Hughes Int. Soccer.....	£6.99	Supreme Challenge.....	£6.99
Fernandez Must Die	£4.99	Tetris (Disc).....	£5.99
Firetrap	£1.99	Tiger Road.....	£4.99
Forgotten Worlds	£6.99	Time Scanner	£6.99
Game Over	£2.99	Typhoon.....	£4.99
Gauntlet 2	£2.99	Victory Road.....	£4.99
H.A.T.E.....	£6.99	Vixen.....	£2.99
Heroes of the Lance	£5.99	Cheetah 125+ Joystick.....	£7.99
History in the Making.....	£12.99	Cheetah Mach One Joystick.....	£9.99
Human Killing Machine.....	£5.99	Konix Megablaster.....	£6.99
Inc. Shrinking Sphere (Disc).....	£6.99	Konix Speedking.....	£9.99
Leaderboard	£2.99	Konix Navigator	£12.99
Marauder	£4.99	CF2 3" Discs	Each.....£2.50
Pacmania (Disc).....	£7.99	CF2 3" Discs	For Ten.....£22.50

Crazy Joe's, 145 Effingham St., Rotherham, South Yorkshire S65 1BL

Visa and Access Orders Taken on (0709) 829286
Please make Cheque/P.O. Payable to "Crazy Joe's"
P&P FREE in U.K. on orders of £5 or over. Under £5 please add 50p.
Europe please add £1 per item. Rest of World add £1.50 per item.

ROCK STAR

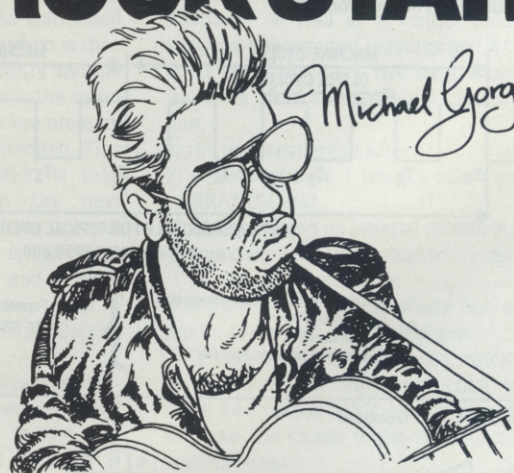

Could you manage this Rock Star ?



CodeMasters Software Company Ltd., PO Box 6, LEAMINGTON SPA, CV33 0SH

GO SKATE OR GO HOME

Note: This competition was devised in the absence of the AA team, who are all off practising falling off skateboards without doing permanent damage...

Bit of a nuisance, this, writes Ollie Alderton (AA art editor). Normally I spend my time trying to tidy up the awful mess Steve, Pat and Trent make of their pages. Frankly this job's more trouble than it's worth... However, I'm sure you don't want to hear about my problems. As I say, that's my usual job. But now the lads have actually gone off and left me to write this page all by myself.

Apparently it's all something to do with something called *Skate or Die*. At first I imagined this must be something to do with a choice between a fish and a hairdo, but it turns out that it's a skateboard game from Electronic Arts. Steve said something about it being reviewed on page 53.

The last thing he said before he disappeared was to take some photos.

So there you have it. That's me demonstrating the skateboard equipment – fortunately you can't see the



bruises from this angle.

There's two sets of this complete "Pacer" skateboarding kit – and that includes a skateboard (well, you'd look pretty silly trying to do it without one!), elbow pads, knee pads, helmet and hooded sweatshirt.

Large people, however, should be

aware that the helmet and protective

gear are a little on the

small size. And for ten unlucky losers there'll be an EA T-shirt – er, I mean one each: you won't be expected to share one between you!

Get your entries on a scenic postcard or the back of a sealed envelope before 31st August to: AA's *Gone Skateboarding*, Future Publishing, 4 Queen St, Bath BA1 1EJ.

And I suppose that's it. Is that all there is to it? Blimey, it's easy this... Oops! Hang on a minute, I forgot to tell

you how to enter. I'll make it dead easy, if you've read the

review. Just tell me who are the three guys who wrote the game... ●

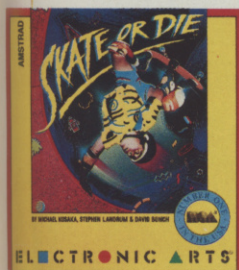

Conditions of entry

1. Employees of Future Publishing Ltd and Electronic Arts and their relatives are not eligible to enter this competition. Sorry bro.
2. Entries, to be received before 31st August, become the property of Future Publishing.
3. Judges' decision is final, and no correspondence will be entered into.
4. Entry implies acceptance of these rules.
5. We can't be held responsible if you win the competition, fall off the skateboard and brain yourself. Take care!

TYPE-INS

More nail-breaking typing practice with PAT McDONALD

COLOUR DUMP

It had to happen sooner or later! **Jens Skinnerup** from Denmark has answered the cry for help from **Mrs RL Neal** of Romsey.

Mrs Neal asked for a program that would let her print out mode 0 screens in glorious technocolour on her **Star LC10** colour printer.

The program (as written) produces perfect copies of *Smart II* pictures – **Robert Buckley's Smart II** being the art program included on the AA37 cover tape.

The filename in line 370 must be edited to the name of the picture, and the program does take a few hours to finish.

```
{ItAq} 100 'Star LC10 Colour Dump
{BvAq} 110 'By Jens Skinnerup
{IxAw} 120 'Amstrad Action August 1989
{LuBi} 170 DIM shade(26,2),
      inks(15),passes(26)
{NkAo} 180 FOR i=0 TO 26
{DrAm} 190 READ a
{NkAo} 200 FOR j=1 TO 2
{EjAq} 210 READ shade(i,j)
{OxAl} 220 NEXT j
{BjAl} 230 NEXT i
{CjAw} 240 DATA 0,0,0,1,2,2,2,2,2,3,5,0,4,3,3
{JqBj} 250 DATA 5,1,1,6,5,5,7,1,1,8,3,1,9,6,6
{FrBj} 260 DATA 10,0,7,11,2,7,12,4,0,13,0,7
{IjBj} 270 DATA 14,2,7,15,5,4,16,1,7,17,3,7
{NpBi} 280 DATA 18,6,6,19,6,6,20,0,7,21,6,7
{AqBk} 290 DATA 22,6,7,23,0,7,24,4,4,25,4,7
{LxAo} 300 DATA 26,7,7
{JqAp} 310 FOR i=0 TO 26
{EsAr} 320 READ passes(i)
{CuAk} 330 NEXT
{JiBj} 340 DATA 2,2,1,2,2,1,1,1,1,2,1,1,1,1
{PwBj} 350 DATA 1,1,1,1,1,1,1,1,1,1,1,1,1,1
{CxAr} 360 ' Load in picture
{XXXX} 370 MODE 0:MEMORY &3F00:LOAD "!"+"
      "picture",&3F00
{OpAq} 380 CALL &BC06,&40
{InAp} 390 FOR f=0 TO 15
{LvAs} 400 INK f,PEEK(&3F00+f)
{InAt} 410 inks(f)=PEEK(&3F00+f)
{JjAk} 420 NEXT f
{FjAt} 430 PLOT 0,398,0:PLOT 4,398
{AkAu} 440 ' Find colours not used
{HrAr} 450 FOR gink=1 TO 15
{DnAm} 460 used=0
{JjAt} 470 FOR x=0 TO 636 STEP 4
{DkAs} 480 FOR y=0 TO 398 STEP 2
{CwBm} 490 IF TEST(x,y)=gink
      THEN used=1:GOTO 520
{GtAk} 500 NEXT y
{CiAl} 510 NEXT x
{CLAx} 520 IF used=0 THEN inks(gink)=26
{DoAn} 530 NEXT gink
{HsAq} 540 ' Set up printer
{KlAm} 550 WIDTH 255
{MqBv} 560 PRINT #8,CHR$(27);"1";CHR$(5); ' Set
      left margin to 5
{FqBv} 570 PRINT #8,CHR$(27);"A";CHR$(4); ' Line
      spacing to 4/72 inch
{IrAo} 580 ' Main loop
{DqAr} 590 FOR gink=0 TO 15
{ItBi} 600 FOR pass1=1 TO passes(inks(gink))
{NsAn} 610 FOR pass=1 TO 2
{PpBn} 620 IF shade(inks(gink),pass)=7 THEN 770
{PlBv} 630 PRINT #8,CHR$(27);"r";CHR$(shade(inks
      (gink),pass)); ' Set colour
{AuAt} 640 FOR x=0 TO 636 STEP 4
{OnAo} 650 FOR s=0 TO 3
{OqCj} 660 PRINT #8,CHR$(27);"*";CHR$(0);"d";CHR$(
      0); ' Select single density
{OjAr} 670 FOR y=0 TO 99 STEP 2
{EjBs} 680 IF TEST(x,y+s*100)=gink THEN c1=80:c2=
      40 ELSE c1=0:c2=0
{NqBi} 690 IF pass=2 AND c1=80 THEN c1=40:c2=80
{NLAu} 700 PRINT #8,CHR$(c1);CHR$(c2);
{InAl} 710 NEXT y
{CuAp} 720 PRINT #8,"";
{CxAl} 730 NEXT s
{JlAm} 740 PRINT #8
{MnAl} 750 N EXT x
{KqBq} 760 PRINT #8,CHR$(27);
      CHR$(12); ' Return to top of page
{GqAm} 770 NEXT pass
{FoAm} 780 NEXT pass1
{AwAn} 790 NEXT gink ●
```

If you don't know what those funny bits in brackets at the beginning of each line are for, look at *Type Writer in AA45's Type Ins*. Hint: you're not supposed to type them in!

● By altering the following lines, any conventional 17K screen can be printed out. You must alter the DATA values in lines 410-430 to suit the screen ink values (as set out it's just white on black)

```
{NpAw} 370 MODE 0:LOAD "!"+"FILENAME",&C000
{KpBp} 380 FOR f=0 TO 15:READ inks(f):INK f,inks(f):NEXT f
{PqAw} 390 READ inks(f):INK f,inks(f)
{EpAl} 400 NEXT f
{HpAp} 410 DATA 0,26,0,0,0
{JqAo} 420 DATA 0,0,0,0,0
{LvAo} 430 DATA 0,0,0,0,0 ●
```

DISCOURSE IV

This month Hero's engine gets a demonstration at the capable hands of JAMES WILSON.

In 50 BC Egypt fell into the hands of the Roman Empire and the decline of Alexandria as a centre of intellectual innovation and excellence got well under way. But the great school still had a genius or two left from whom we inherit some useful algorithms.

In *Discourse II* Diophantus was mentioned in connection with his implicit use of the idea of a limit. Such a method was also used by Hero to estimate square roots of numbers which were not perfect squares.

Hero of Alexandria (ca.62 AD) was a practical man rather than a philosophical mathematician. In his book *Pneumatica* he describes the famous *Hero's Engine* where by a small tank of water mounted on an axle is made to spin by heating the tank and allowing the steam to escape through two opposing holes – the first suggestion of a steam engine.

In his *Mechanica* he discusses gear trains, worm wheels, pulleys and levers in various combinations. His surveyor's *Dioptra* a form of theodolite, used screws and worm gears for fine adjustments.

Hero also advanced Euclid's optical work. He was the first to demonstrate the Law of Reflection of light – that the angle at which light is reflected from a surface is equal the angle at which it strikes – and he designed other surveying instruments which depended upon this.

He also investigated refraction and he mused on the effect of refraction on astronomical observations made near the horizon. But like the rest he also spent some time studying numbers.

The square roots of many integers are not only themselves not integers, but cannot even be represented properly and completely as a fraction.

For instance, 2, the square root of 4, can be equally well written as 2/1 or 36/18. However, $\sqrt{2}$ cannot be represented as a fraction no matter how large the numerator (top number) or denominator (bottom number) and therefore is called an *irrational number*.

Hero developed an algorithm that makes it possible to create a fraction which is as close as we wish to get to the actual value of the square root of any integer.

The Heronian Algorithm depends on the

● We apologise for the three errors that crept into June's *Discourse*.

$x^2 - p = y^2$ and thus $p = x^2 - y^2 = (x+y)(x-y)$
should have read

$x^2 - p = y^2$ and thus $p = x^2 - y^2 = (x+y)(x-y)$

series is $2n = m$ where m is 1,3,5... as the
should have read

series is $2n + m$ where m is 1,3,5... as the

and

from above, $P = (x+y)(x-y), 9271 = 123 \times 73$
should have read

from above, $P = (x+y)(x-y), 9271 = 127 \times 73$

Thanks to those readers who wrote or phoned to question or correct these errors!

fact that if we have any two numbers which, when multiplied together, form a third, then the average of these two numbers is closer to the square root of the third than either of them.

For example, $4 \times 9 = 36$. One could say that either 4 or 9 are approximations of $\sqrt{36}$, but their average $(6 \frac{1}{2})$ is closer still. This is clearly true. If we can find a number n so that $n \times 6 \frac{1}{2} = 36$, then the average of n and $6 \frac{1}{2}$ will be even closer still!

This number n is known as the inverse of the approximation ($6 \frac{1}{2}$ in this instance). By schoolboy algebra this must be $72/13$.

Interestingly, the values of the approximation approach the square root from 'above', whereas the inverse approaches it from 'below', the two converging on the actual limiting value. The gap between them narrows quickly and the values of both the numerator and denominators of these fractions increase very rapidly.

For this reason, though we are dealing with integers, their values so quickly exceed 32676 that we have had to use Real numbers to represent them and, even then, after a couple of iterations we exceed the real top limit of $1.7E+38$. This restriction of the CPC means the algorithm loses too much accuracy after about $\sqrt{36}$ to be of real use, but it is a very fine example of a convergent algorithm. ●

● Keep tuned into *Discourse* next month, folks!

```

10 '*****
20 '*
30 '* James Wilson : Program No.4 : August 1988 *
40 '*
50 '*****
60 DEFINT a,i,f:DEFREAL g-y:a=0:f=0:i=1:MODE 2
70 CLS:PRINT +a, "HERO'S ALGORITHM
   TO APPROXIMATE THE SQUARE ROOT OF A NUMBER"
80 PRINT +a:PRINT +a
90 INPUT " Enter the number -";s
100 PRINT +a, "
110 rn=s+1:rd=s
120 PRINT +a, "Iteration No. = 1":GOTO 140
130 PRINT +a, " is"i
140 PRINT +a, "Approximation = "rn"/"rd
150 rin=rd*s: PRINT +a, "Inverse = "rin"/"rn
160 rmn=(rn^2) + (rd*rin):rmd=2*rn*rd:PRINT +a, "Mean = "rmn"/"rmd
170 rdd=rmd/2: PRINT +a, "Difference = 1/"rdd
180 rsn=rn:rn=rmn:rd=rmd:IF rd>1E+18 THEN GOTO 200
190 INPUT "Next Iteration";z$:IF UPPER$(z$)<>"N" THEN i=i+1:GOTO 130
200 PRINT +a:PRINT +a, "Current Approximation gives"rn/rd
210 PRINT +a, "Current Inverse gives"rin/rsn
220 PRINT +a, "Amstrad's Algorithm gives"SQR(s)
230 PRINT +a, "Error against Amstrad is
   "( ( rn/rd - SQR(s) ) * 100) / SQR(s) "%":END ●

```

12

★
Only £17.95 for a 12 month subscription to the Worlds very best magazine dedicated to the Amstrad CPC!

ACTION packed issues...

- ★ Our guarantee: if you are not completely satisfied, we will refund the cost of the unmailed copies. You can't say fairer than that!
- ★ Receive your quarterly update — with extra special savings for "AA subs-club" members only.
- ★ Overseas subscribers welcome.



- ★ Hottest news and reviews.
- ★ £20 worth of vouchers for our Special Offer pages.
- ★ Don't bother queuing in the newsagent, receive your copies through your door.

...for only **17.95**

Ring 0458 74192 Now, or see the order form on page 80.

TYPE-INDEX

Name/type/description Issue

1988 (P) (nearly) eternal calendar	28
3D CHARACTERS (F) Colour-edged chars	36
3D CUBE (F)	18
3D HIDDEN LINE REMOVAL GRAPH (P)	33
3D LOOPS (F)	17
3D PICTURE DESIGNER (U)	20
3D SHAPE ROTATOR (F)	19
3D WORLD (F)	17
A LITTER OF CATS (U) Multi disc printout	43
ABSTRACT (F) Graphics art	44
ADVANCED HEADER READER (P) Tape header	36
AGRAL86 (P) Language	17
ALIEN LANGUAGES (F)	42
ALPHA8ET (E) 5 to 7 year olds	41
AMSTRAD ABSTRACTS (F)	30
AMSTRAD DRUMKIT (P)	6 (9)
ANAGRAMS (G)	33
ARTIST (P) Graphics	16
AUTOMATIC MENU (U)	34
BARLOGO (U) Sawn off LOGO, Basic	25
BINARY LOADER (U) Tape: find load addr.	44
BLITTER (F)	10
BLOCK SAVE(U) Bas/bin progs	29
BOUNCERS (G)	11
BRAINBOX(G) Adaptable quiz	42
BUDIE (F) Chirp chirp	17
BYTE SEARCH (R)	34
CALENDAR (P) 1800-2500 AD	16
CARD TRICK (G)	21
CASE CONVERTER (U) Upper/lower/upper	26
CAT #8 (U)	10 (11)
CATALOGUE TO VARIABLES (R)	23
CELESTIAL BODIES (P) Demo gravity2 bodies	27
CENTITHIEF (G)	29
CHARACTER DEFINER (U)	19
CHARACTERBYCHAR. PRINT (R)	23
CHIMES (F) Grandfather clock	19
CIRCLES (P)	36
CODEBREAKER (G)	7
COLOUR DUMP (U) for Star LC10	47
CONTROLLING PATTERNS (F)	21
CONVEYOR BELT (F)	8
CURVE (F)	20
CUSTOM BEEP (R) Alter error beep	32
DARTS SCOREBOARD (P)	35
DATA MAKER (R) Bin to Bas DATA	27
DEAD END (G)	24
DECOMPRESS PICTURES (U)	23
DEGREES CONVERSION(R) Fahr/Cent	23
DESERT ATTACK (G)	34
DESIGN YOUR OWN GRAPHICS (U)	4
DEVIANT (P) Standard/mean vars	32
DIONYSIAN SPIRAL (F)	3
DISC COMPACTOR (U)	32
DISC INLAY (P) Prints inlay cards	20
DISC MAP (U)	27
DISC MENU (U) Select by number	6
DISC MENU(U) Select by cursor	18
DISC SECTOR EDITOR (U)	36
DISCOURSE SERIES (E)	45 onwards
DISCUTIL (U) Inc echo to printer	28
DISINTEGRATOR (R) Screen clearance	29

E=educational, (F)=fun graphics, (G)=game, (P)=Standalone program, (R)=routine, (U)=Utility.
A few of these updates are corrections necessary to the smooth operation of the Type In.

DISKEDIT (U)	26
DOTTY (F)	19
DOUBLE HEIGHT CHARS (U)	15
DOUBLE HEIGHT CHARS (U)	16
DOUBLECOLUMN PRINT (R)	30
DROPOUT (G)	30
EARS FOR ARNOLD (P) Sound digitizer	15
EASIBASE (P) Database pgm	41
ELECTRONIC RAINBOW (F)	17
ENCODE/DECODE (P)	36
ENCRYPTER (P) Protection system	33
ENTERTAINER (F)	31
ETCHASKETCH (F)	9
FANCY TEXT GENERATOR (R)	22
FILECOPY (R)	21 (22)
FORMULAE (E) Areas and volumes	32
FREEZE (U) Pause game	24
FUZZY (F)	21
GAUSS (E) Solves simultaneous equations	31
GIGO (F) Garbage conversation generator	13
GRAPH MASTER (E)	35
GRAPHIC PATTERNS (F)	6
GUITAR TRAINER (P)	42
HACKER (P)	43 (44)
HANGMAN (C)	19
HEXTYPE (P) Enter hex digits	24
HOME ACCOUNTANT (U)	27 (29)
HYPNO/COLOUR FADER (F)	45

● Thanks to the archivist extraordinaire who compiled this mammoth index. Your handsome reward, to the tune of £50 (sweet music indeed) awaits you. Unfortunately (*oh the embarrassment*) we've lost both your name and address...

Well, look on the bright side: at least we're not responsible for transporting nuclear devices around the country. Which is just as well, really. Whoever you are, get in touch so we know where to send the moolah.

By the way, if anyone else is thinking of undertaking any kind of AA index, get in touch with us first. We'll tell you whether it's worth doing, and if so how we'd like it done.

HYPNOTIC (F)	15
INVADERS (G) practice addition included	18
INTERLACE DEMO (P)	45
ISOTOPES (G)	40
KALEIDOSCOPE (F)	15
KEYRSX (U)	9
KEYSAVE (U) Key defs as binary file	31
KEYWORDS (U) Abbreviations	31
LANDSCAPES (F)	17
LEAGUE FIXTURES (P) Calculate fixtures	26
LEAN LETTERS (R)	30

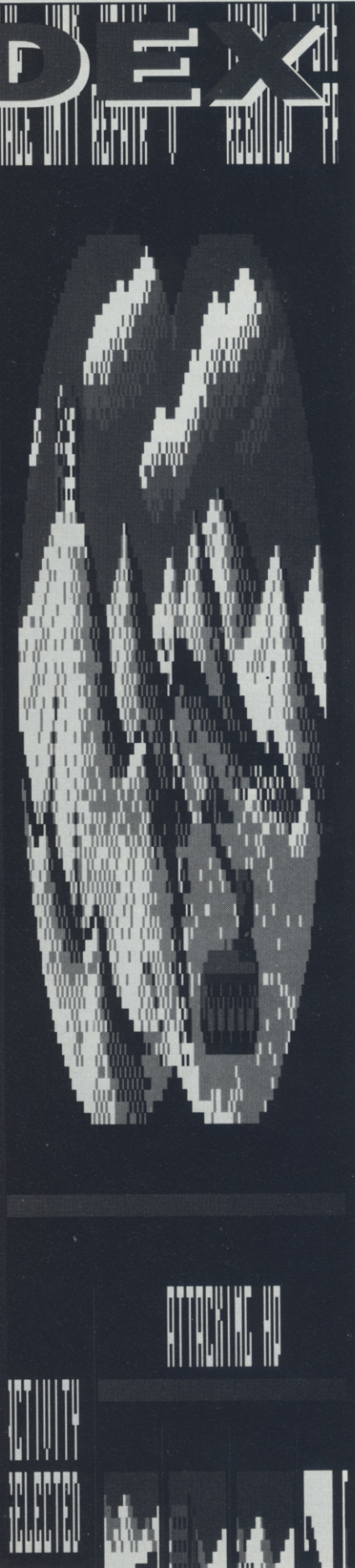

TYPE-INDEX CONT'D

LETTER PUZZLER (G)	12	ROTATING TRIANGLE (F)	17
LIFE (G)	44	RSXSORT (R) Sort arrays	28
LISSAJOUX FIGURES (F)	3	SCREEN FLIP (F)	17
LOAN AMORTIZATION TABLE (P)	28	SCREEN GRABBER (P)	36
LOGO PATTERN (F)	29	SCREEN SQUASH (U)	16
MACHINE CODE MANDELBROT (P)	25	SCROLLING MESSAGE (P)	20
MAGAZINE EDITOR (U)	33 (36)	SEARCHANDREPLACE (U)	18
MAGIC (U) RSX for scrn mem byte	37	SERPEN (F)	21
MANDELBROT GENERATOR (P)	23 (24)	SHADY DUMP (U)	16
MANUSCRIPT (P) Print music manuscript	12	SHAPEMAKER (F)	20
MAPPING (P) Wargame map designer	40	SHOOTEMUP SIM ADV (P) Prog made plain	31
MATRIX (F)	25	SIMON (G)	14
MAZE (R) Generator	26	SINEWAVE WRITING (F) Message scrolling	22
MEGADUMP (P) Screen dumpposter size	22	SNOWSTORM (F)	16
MEMKIT (U) New RSXs to Basic	38	SOLAR SYSTEM (P)	40
MEMORY (G)	24	SOLITAIRE (G)	39
MESSAGE SCROLLER (R)	25	SOUND SAMPLER (P) Rec play load save	15
MIXING HASH AND POUND (R)	23	SOUND TO LIGHT (P)	42
MONKEYMATE (P) Personal cash accounting	30	SOUND TO LIGHT (P) Strobe effects	18
MORE PATTERNS(F)	33	SPACE HOCKEY (G)	42
MORE THAN FOUR (F) 4 col's appear more	18	SPACE TUNNEL (F)	18
MOTOR CONTROL(U)	15	SPEED 3K (U) Increase cassette speed	10
MULTI FONTS (R)	42	SPHERISCREEN (P) Video effects made plain	27
MULTI PROG (U) RSXs for 464	37	SPINNING DIAMOND (F)	24
MULTICOLOURED MODES (F)	17	SPIRALU/SPIRALD (F)	15
MULTICOLOURED MODES AND BORDER (F)	20	SPIROGRAPH (F)	20
MULTIUTIL (U) Extra Basic commands	29	SPRITE EDITOR (P)	43
MUSIC COMPOSER (P)	5 (11)	STAINED GLASS (P)	15
NEAR/NEAR LETTER QUALITY (U)	42	STARDODGING (G)	21
NEUTRON MAZE (G)	22	STIPPLE (F) Colour combinations	30
NEW CHARACTER SETS (R)	37	STREAMER (U) Discotape	28 (30)
NEW MODE (R) Double height characters	35	SWIRL (F)	8
NUMBER GAME (G)	23	SYMBLAID (U) SYMBOL made plain	26 (27)
PAPER CHANGE (R) Paper colour RSX	27	SYMBOLIZER (U) Character editor	45
PATTERN GENERATOR (F)	39	SYNTH (P) 3Channel synthesizer	18
PATTERN PLOTTER (R) Requires a plotter	24	SmART (F)	29 (31)
PATTERNS (F)	15	TESTER (U) Assembler breakpoints	31
PATTERNS (F)	38	TEXT DUMP (U)	21
PATTERNS MK II (F)	19	TEXT EDITOR (U) Word processor	24
PERSONAL SPENDING (U)	36	THINK AHEAD (G) 2 Players	27
POLY STARS (F)	34	TORUS (F)	14
POSTER MAKER (P)	14	TRAIN SIMULATOR (F) makes choo noise	43
PRINTER BUFFER (U) Memory resident	26	TRANSFORM (E) figures to written numbers	32
PRINTER DUMP (P) Screen dump	35	TRAPPER (G)	37
PRINTER TYPEFACES (U)	19	TREASURE HUNT (G)	36 (37)
PSYCHEDELIC PLOT (F)	6	TRIANGLES (F)	21
PSYCHEDELIC STROBE (F)	20	TRIVIA QUIZ (G) Program made plain	25
PULLDOWN MENUS (U)	38	TRIX (F)	9
PYRAMID (F)	16	TUNNEL (F)	34
QUADSOLVER (E) Solve quadratic equations	32	TURNING WHEEL (F)	35
RALLY (G) Car racing	21 (23)	TYPEWRITER (P) Typed input debugging aid	45
RANDOM LINES (F)	22	UNERASE (U)	9 (11)
RANDOM SYMMETRICAL PATTERNS (F)	21	UNERASE (U)	41
REACTION TESTER (G)	23	UNSCRAMBLE (R)	24
REAL TIME CLOCK (R)	37	VARIABLE HEIGHT CHARACTERS (U)	17
RECTANGLE (F)	19	VARIABLE LIST (R) Debugging aid Basic 35	26
RESET (R) Inks/modes to defaults	30	WANDERING THROUGH SPACE (F)	16
REVERSE PRINT (R) Print righttoleft	25	WAVE (P) Spheriscreen for 464	29
REVOLVING MESSAGE (F)	24	WAVY (P) Spheriscreen speeded up	32
RGB MOSAIC (F)	45	WEAVING (F)	24
ROCKIMNG CPC (P) Rock music	33	WEEKDAY (P) Date/day:program made plain	22
ROCKY 2 (P) Enhancement to rock your CPC	35	WINDOW SAVER	17
RODOS CATALOGUE (P)	34	ZEBRA WINDMILLS (F)	3
ROTATING POLYGO (F)	40	ZYCLOID (F) Pattern creator	22 ●
ROTATING SPHERE (F)	8		

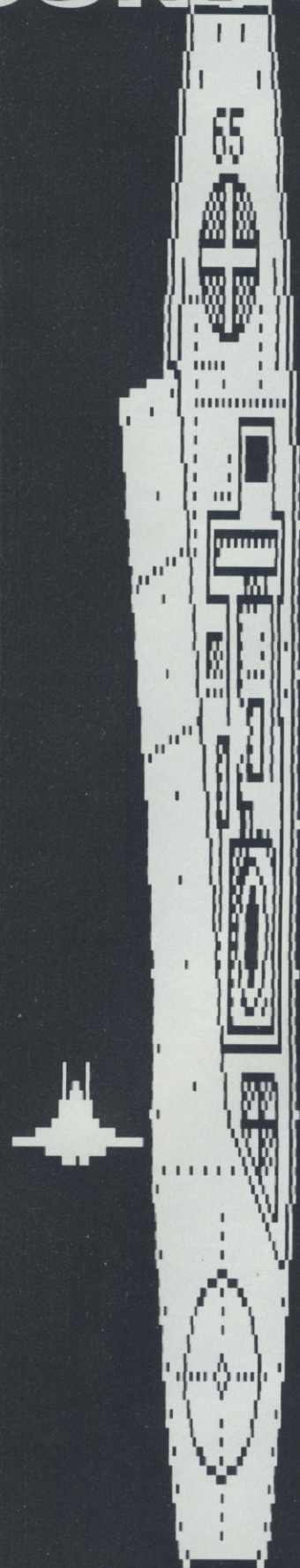

AT LEAST

25%

off all non-budget software RRP

1st choice for fast **FRIENDLY** service

CHOICE CHEATS

Complete those games that have defeated you so far!! Choice Cheats lets you play games much more easily by giving you options such as infinite lives and immunity.

TAPE £2.99
DISC £4.99

Choice Cheats 1

Choice Cheats 1 contains cheats for: By Fair Means or Foul, Cybernoid, Karnov, Operation Wolf, Flying Shark, Radius, Titanium, Advanced Pinball Simulator, Joe Blade 2, Star Trooper, Reflex and Shanghai Karate.

Choice Cheats 2

Choice Cheats 2 contains cheats for: BB vs Dragoninja, Hopper Copper, Arkonoid, Arkonoid 2, Dynamite Dan, Solomon's Key, Dizzy 2, ATV Simulator, Empire Strikes Back, Pro Ski Simulator, Batman and Head over Heals.

BUDGET

	Tape	Disc
Air Wolf	1.99	
Barry McGuigan's Boxing	1.99	
Bomb Jack	1.99	
Bubble Bobble	1.99	
Dun Darach	1.99	
Dynamite Dan	1.99	
European 5 a side	1.99	
Ghostbusters	1.99	
Gun Boat	1.99	
Joe Blade 2	1.99	
Shanghai Karate	1.99	
Star Trooper	1.99	
Steve Davis Snooker	1.99	
Thing	1.99	
Yabba Dabba Doo	1.99	
Yogi Bear	1.99	
Xeno	1.99	
Choice Cheats 1	2.99	4.99
Choice Cheats 2	2.99	4.99
ATV Simulator	2.99	
Big Foot	2.99	
Commando	2.99	
Football Manager	2.99	
Footballer of the Year	2.99	
Gauntlet	2.99	
Leader Board	2.99	
Moto Cross Simulator	2.99	
Pro Snooker	2.99	
SAS Combat	2.99	
Street Gang Football	2.99	
The Hit Squad	2.99	
Treasure Island Dizzy	2.99	
Twin Turbo V8	2.99	
Zorro	2.99	

CONTACT US

if you have written any **QUALITY** programs or have ideas we could develop. You may earn **£££s**

ADVENTURE

	Tape	Disc
Corruption (6128 only)	10.95	14.95
Gnome Ranger	10.95	10.95
Ingrid's Back	6.70	14.95
Lancelot	7.45	14.95
Mind Stone	7.45	9.70
Realm of the Trolls	10.95	9.70
S.D.I.	7.45	9.70
Time and Magic	10.95	10.95

LEISURE & SPORT

	Tape	Disc
By Fair Means or Foul	7.45	10.95
Emlyn Hughes Int. Socc.	7.45	10.95
Football Manager 2	7.45	10.95
Game Set and Match 2	9.70	13.45
Gary Lineker Hot Shots	7.45	10.95
Gold Silver Bronze	10.95	18.70
Question of Sport	10.95	14.95
Super Sports	7.45	10.95
Tour de Force	7.45	
WEC le Mans	7.45	10.95

EDUCATION

	Tape	Disc
Answer Back Quiz (6-11)	7.45	10.45
Facfiles (extra questions for above):		
Arithmetic (6-11)	3.70	6.70
English Words (12+)	3.70	6.70
Gen. Knowledge (6-11)	3.70	6.70
Gen. Knowledge (12+)	3.70	6.70
Natural History (10+)	3.70	6.70
Spelling (6-11)	3.70	6.70
Better Spelling (8+)	8.20	12.70
Better Maths (12-16)	8.20	12.70
Biology (12-16)	8.20	12.70
Chemistry (12-16)	8.20	12.70
Fun School (2-5)	4.45	6.70
Fun School (5-8)	4.45	6.70
Fun School (8-12)	4.45	6.70
Fun School 2 (under 6)	7.45	9.70
Fun School 2 (6-8)	7.45	9.70
Fun School 2 (over 8)	7.45	9.70
Giant Killer (over 10)		10.95
Magic Maths (4-8)	8.20	12.70
Mapwork Quiz (9+)	8.20	12.70
Maths Mania (8-12)	8.20	12.70
Maxi Maths (9-15)	8.20	12.70
Physics (12-16)	8.20	12.70
Playschool (3-7)	8.20	12.70

ARCADE

	Tape	Disc
4x4 Off Road Racing	7.45	10.95
Action Force	7.45	
After Burner	7.45	10.95
Arkanoid 2	6.70	10.95
Barbarian 2	7.45	10.95
Batman Caped crus.	7.45	10.95
Command Perf.	9.70	10.95
CrazyCars 2	7.45	10.95
Cybernoid	7.45	
Cybernoid 2	7.45	10.95
Dan Dare 2	5.95	
Dark Side	7.45	10.95
Driller	10.95	13.45
Echelon	9.70	10.95
Empire Strikes Back	7.45	10.95
Fire Trap	7.45	
Gothic		10.95
Giants	9.70	14.95
Karnov	7.45	10.95
Magnificent Seven	7.45	13.45
Marauder	7.45	
Netherworld	7.45	10.95
Operation Wolf	7.45	10.95
Pacland	7.45	10.95
Robocop	7.45	10.95
Rockstar	7.45	10.95
Running Man	7.45	10.95
Run The Gauntlet	7.45	10.95
Samurai Warrior	6.70	10.95
Thunderbirds	7.45	10.95
Thunder Blade	7.45	10.95
Venom Strikes Back	7.45	

DISCS & JOYSTICKS

Maxell Blank 3" discs each	2.60
Cruiser Joystick	8.95
Clear "Seal 'n type" keyboard protectors. State 464 or 6128	7.95

BUSINESS

	Tape	Disc
Home Budget	1.75	
Mastercalc 128 (6128)		24.70
Masterfile 3		29.95
Matrix Spreadsheet		25.95
Maxam	14.95	19.95
Maxam 2 (6128)		37.45
Mini Office 2	10.95	14.95
Plan It		14.95
Promerge		18.70
Prospell		22.45
Protect	14.95	19.95
Tasspell		14.95
Tasword 464	18.70	22.45
Tasword 6128		22.45
Write Hand Man		22.45

THIS MONTH'S SPECIAL OFFERS

SCHOOL HOLIDAYS
Keep your children occupied with funschool and funschool 2

Buy any 2 of the funschool range and get a £1 voucher to use with your next order. Buy 3 and get 2 £1 vouchers
offer ends 15.8.89

SAVE OVER £1 WITH EVERY ORDER ON BUDGET SOFTWARE

Buy 3 priced at £1.99 for only £4.95
or 2 priced at £2.99 for only £4.95

2 for the price of 1

(While stocks last)
Any 2 for £1.99
Dun Darach
Euro 5 a Side
Thing
Xeno
Zorro
Any 2 for £7.45
Dark Side
Fire Trap
Marauder
Tour de Force
Venom Strikes Back

To avoid disappointment, feel free to quote a reserve title(s)

IF YOU DON'T SEE THE ITEM YOU REQUIRE, JUST PHONE (0706) 72728



All prices are inclusive of VAT, postage & packing in the UK. Overseas orders please write for details

Please send me the following:
Title _____ Price _____ Disc/Case _____
Total price _____



To order, fill in the coupon and send it with a cheque/postal order to
1st Choice Software Ltd
Dept ACU8
4 Paul Row, Temple Lane
Littleborough, Lancs, OL15 9QG

Name _____
Address _____
Post code _____

If like us you'd spent many happy yet frustrating hours with the Oliver Twins' *Treasure Island Dizzy*, you'll appreciate some help. And here it is.

We've had dozens of letters offering maps, tips, hints, playing guides and warnings, so rather than giving all the credit to one person we've gathered them all together and commissioned an artist to turn your work into the rather tasty map you see before you and the additional assistance over the page.

Good luck, me hearties, and if you can't escape now you never will!

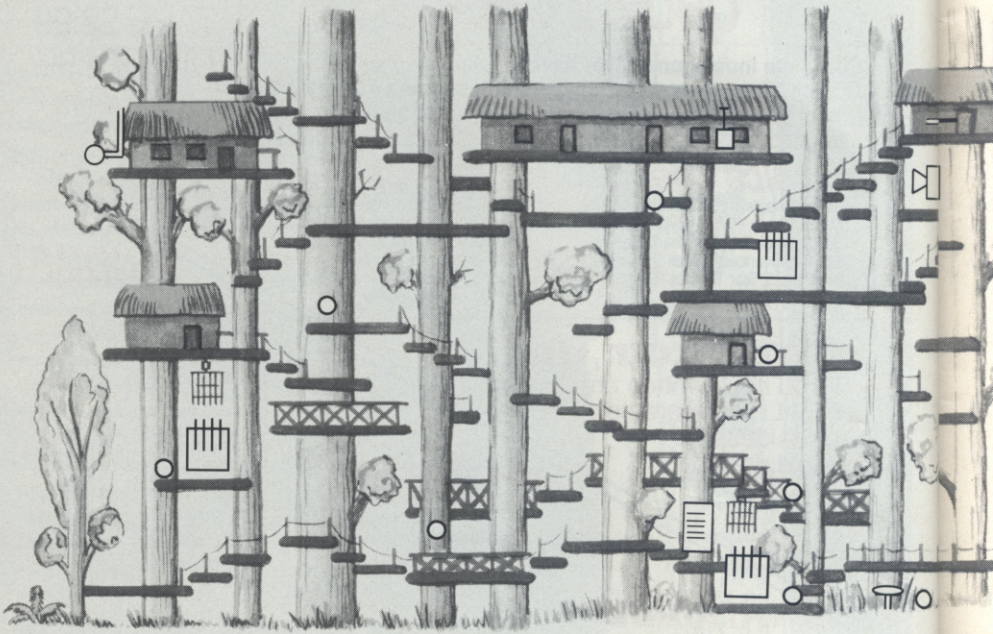
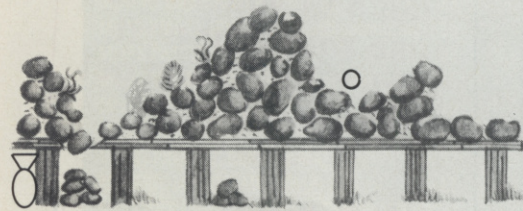

THE MAP

TREASURE ISLAND

DIZZY

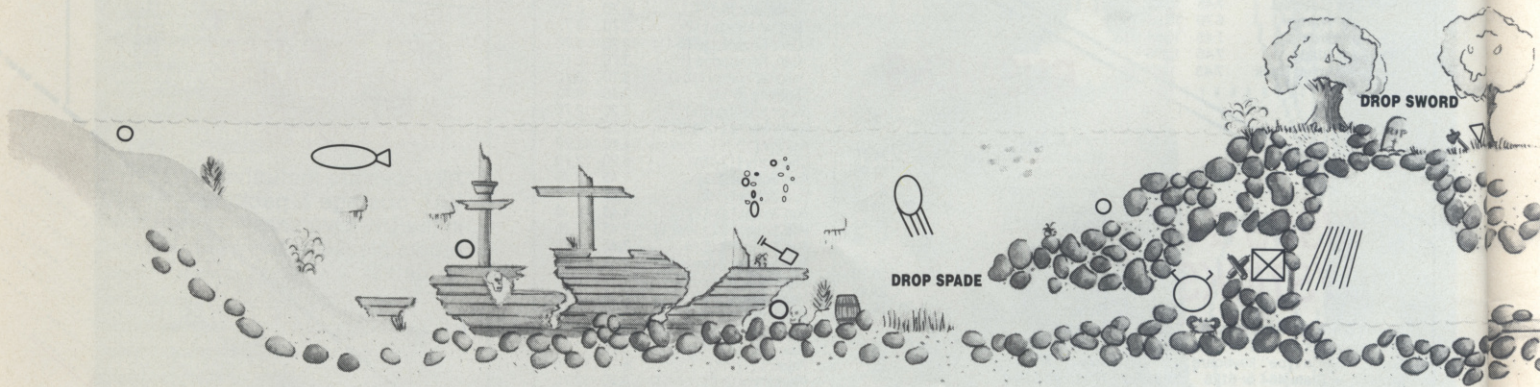

KEY

SNORKEL	ROCK	BAG OF GOLD	COIN (there are 30)	STEP	AXE
GLASS SWORD	BUCKET	TRAP	FIRE	SALT WATER	MUSHROOMS
VIDEO CAMERA	MICROWAVE	FISH	SINCLAIR ABUSER MAG	DYNAMITE	JELLYFISH
WINDOW	KEY	CRAB	TUBE OF TOOTHPASTE	SPADE	LIGHTNING BOLT WITH CURSED TREASURE
CHEST	DETONATOR	SCROLL	BIBLE	MAGIC WALL OF WATER	

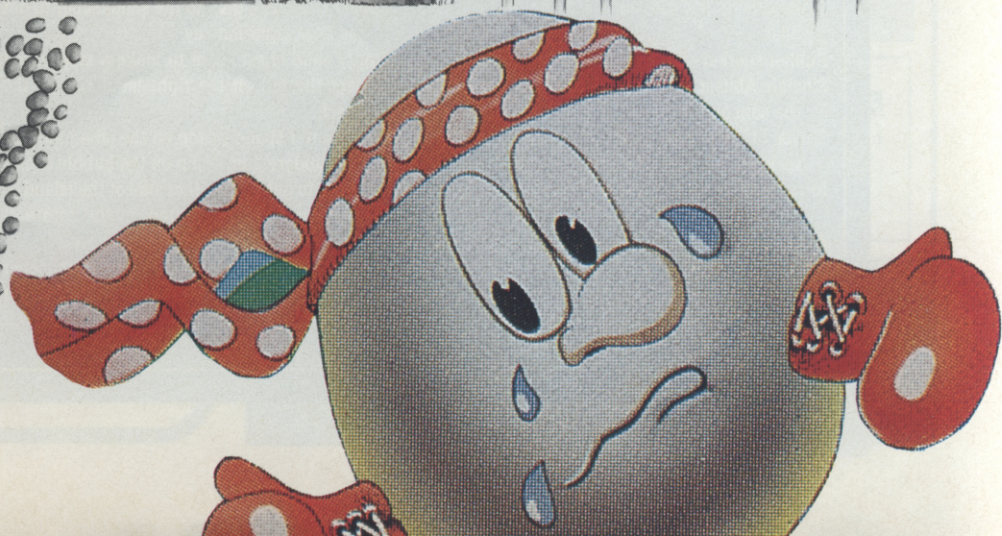
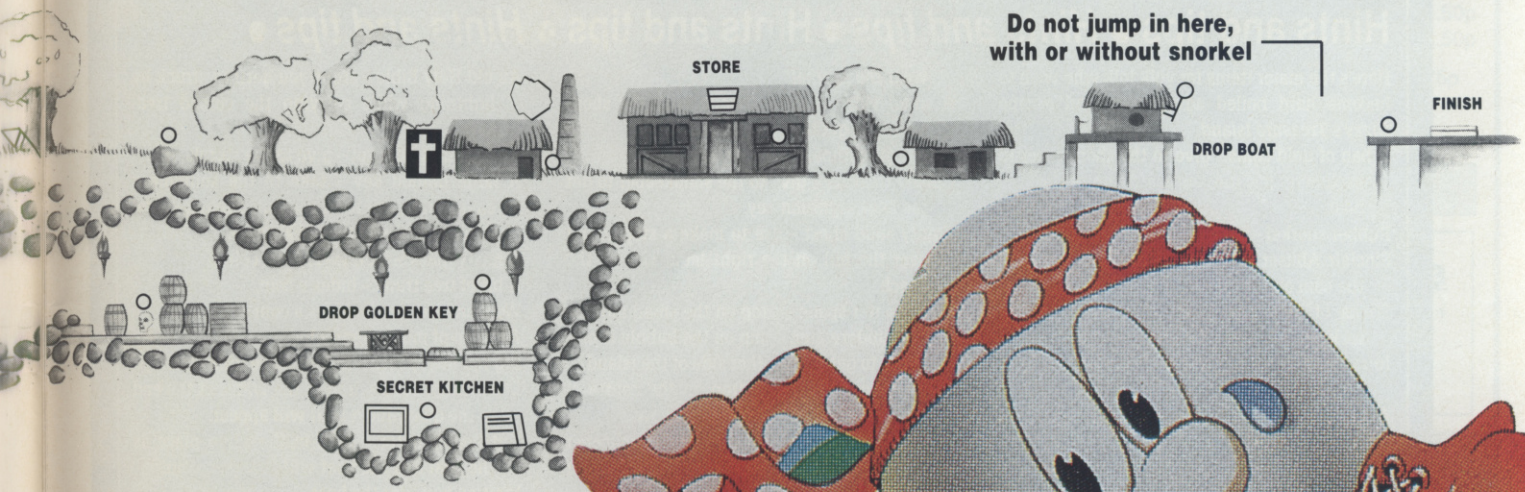
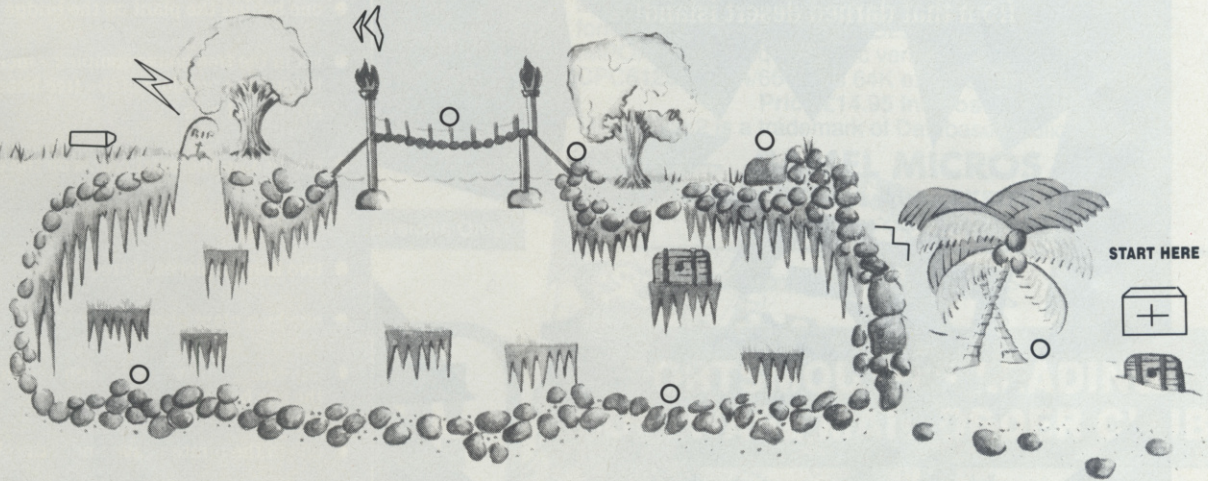

CHEAT MODE

Ooh aargh me hearties and all that nonsense – *Dizzy* tips galore!

Our indis-, indes-, in- er... our terrific *Desert Island Dizzy* guide continues with this collection of playing tips gathered together by TRENTON WEBB from your numerous letters and maps. Thanks for all your help, and your reward is to know you've helped all those other captive *Dizzy* fans escape from that darned desert island!



Riches beyond the dreams of wildest avarice, matey!

To complete the game fully you need to collect 30 coins in total. 17 are in plain view: the remainder are hidden as follows:

- one behind the plant on the beach
- one behind the plant on the bridge
- six in the tree house complex – including one behind the window of the tree house on the far right hand side
- one behind the mushrooms on the ground
- two behind parts of the wooden railings
- two behind pieces of tree trunk
- one by a plant above the mine
- one under the water, hidden behind the skull on the sea bed
- one in the pirate's cave under the skull
- finally near the shop there are two coins, one behind the rock to screen left of the store and a second on the right hand screen obscured by a plant

Hints and tips ● Hints and tips ● Hints and tips ● Hints and tips ●

Here's the major items for yolk folk who wish to become hard boiled adventurers and escape *Dizzy's Treasure Island*.

A bag of gold coins - give to the shopkeeper in exchange for the outboard motor for the boat.

Rubber snorkel - wear whenever underwater.

Sinclair Abuser Mag - drop in the water near the coin on the beach.

Sticks of dynamite - use to clear away the rocks in the mine that block your path.

Infra red detonator - use with the dynamite in the mine.

A sharp glass sword - use in the graveyard on the right hand side of the large lake. Drop the sword on the gravestone to open the entrance to the smugglers cave - *be sure to*

wear the snorkel!

A small video camera - trade with the shopkeeper to get the Dehydrated boat.

A tube of toothpaste - *oo, er, um, ahm...*

Cursed treasure - give to the shopkeeper to get the boat's ignition key.

Empty solid chest - use to make a step to get over the hill on the right hand side of the beach.

A salt water spade - drop on the small moving rock underwater. Jump on the bubble it produces to get to the other side of the island.

The woodcutter's axe - drop on the centre of the bridge to get to the caves below.

A microwave oven - take to the storekeeper who will swap it for a gallon of petrol for the boat.

An old Holy Bible - stops you getting struck by lightning while carrying the cursed treasure.

An old empty bucket - give to the storekeeper.

A large golden key - take to the smugglers' caves and drop it on the half sunken barrel to gain access to the old kitchen.

A misty glass window - hides a coin.

A bit of tree trunk - hides a coin.

Wooden safety rail - hides a coin.

A clump of mushrooms - hides a coin.

Big red heavy rock - hiding place for a coin.

Dehydrated boat - drop in the water at the end of the quay, and a boat will appear.

Out board motor - drop in the same place as the boat and the boat will change colour.

Ignition key - for the boat.

ZEDASM ROM**£19.95**

The professional Z80 Text Editor/Assembler and System monitor. Superfast Z80 assembler (200 lines second). Supports page switching on 6128 machines, up to 80k of text source in memory at the same time.

DEMON DEVELOPMENT CARTRIDGE**£19.95**

The Ultimate machine code tool. Stop *Any* program *Anytime* by a press of a button, the memory remains intact and can be saved to Tape/Disc, debugged, traced, moved, disassembled etc.

EPROM PROGRAMMER KIT**£27.50**

Transfer your favourite programs (Basic/Machine Code) onto Eprom. Programs 2764/27128 12.5 or 21 volt Eproms. Powerful but easy to use software, Rom to Rom copy, Editing, Verification, Single or block programming.

PCB DESIGNER CARTRIDGE**£59.95**

Design double sided printed circuit boards quickly and easily. Output to standard printer 1:1 or 2:1 scale. Predefined DILS & IDC connectors. Auto Routing. Zoom Editing etc. Too many functions to list here.

PASCAL COMPILER ROM**£15.00**

Our pascal compiler is easy to use, suitable for the absolute beginner and produces stand alone Machine code. Does NOT require CPM.

(Note cartridges have no through connector for 464 with Disk Drive)



John Morrison Dept (AA)
4 Rein Gardens, Tingley, West Yorkshire, WF3 1JR
Telephone (0532) 537 507 S.A.E for further information

G-TEN LIMITED**The Mail Order Software House**

AMSTRAD	TAPE	DISK	AMSTRAD	TAPE	DISK
Action Service.....	7.75	12.50	Football Manager II.....	7.75	12.50
Bangkok Knights.....	7.75	12.50	G.I. Heroes.....	6.75	12.50
Arkanoid II.....	6.75	12.50	NATO Assault Course...7.75	12.50	12.50
Chartbusters.....	7.75	12.50	Quandam.....	6.75	12.50
Cosmic Pirates.....	7.75	12.50	Robocop.....	6.75	12.50
Dark Fusion.....	7.75	12.50	Street Fighter.....	7.75	12.50
Eliminator.....	7.75	12.50	Vigilante.....	7.75	12.50

Strictly Mail Order. Do Not Send Cash by Post. Postal Order and Credit Cards Order Despatched within 48 hours. Otherwise allow 14-28 Days Delivery. Add £1.00 per item P&P, Inland, EC, B.F.P.O. Elsewhere add £3.00 per item. Make cheques payable to G-Ten Limited. Send your order to:

G-TEN LIMITED
Dept AA, 5a Edgeware Road,
London. NW9 5DL
24 Hour Telesales No: 01 200 4858

Buy 2 Games, Get One Mystery Game FREE!! (Tape Versions Only)

WOPS**Disc Manager and Copier**

Now with NEW 'Simulated ROM' option. Fast & easy to use, WOPS includes ICON control, BACKUP almost any disc, MULTI-FILE copy, disc EDIT, extended FORMATS, SCREEN dumps, ARCHIVE to tape, extra RSX commands and much more.

Price: £14.95 inc. postage. (all CPC)

**GM CHESS****Chess Game & Tutor**

Learn about openings, mid-game and end game tactics, play the computer at fast or normal chess, solve chess problems or just watch the machine play itself. All the options you need including recap, swap sides 0,1 or 2 players, 7 levels etc.

Price: £14.95 (Disc Only). (all CPC)

**INTERCEPTOR**

SUPERCHARGE your MINI OFFICE 2! This ingenious program gives over 14 functions available INSTANTLY from any point inside MO2. Afterwards MO2 is resumed from where it left off. Create 'pro-forma' documents, spreadsheets etc. (complete with parameters) & save to disc using Save Image. Transfer data from ANY program (e.g. Spreadsheet) into the word processor. Use complete disc functions (format, disc & file copy, erase/rename/list files). You can even call up a calculator or note-pad, or convert any text file into MO2 format. All without leaving MO2.

IMPORTANT: Requires disc version of Mini-Office 2 and CPC6128 or 464/664 plus 64K expansion.

Price £14.95 inc postage.

Mini-Office 2 is a trademark of Database Publications

**CAMEL MICROS**

Wellpark, Willeys Ave., EXETER EX2 8BE
Telephone: 0392 421105

WANTED!

YOUR PROGRAMS

- Have you written any commercial-quality games or utilities?
- Are you competent at Z80, 6502 or 68000?
- Do you want to make money?

If the answer to the above is yes, then First Byte Software wants to hear from you.

Write now to:

First Byte Software

71 Barn Glebe
Trowbridge
Wiltshire
BA14 7JZ
Tel: 0225 765086

PORTSMOUTH'S LEADING SOFTWARE/MAIL ORDER CLUB

SUPER SOFTWARE SALE

AMSTRAD BARGAINS

Monopoly.....	50p	} PACK 1	3D Chess.....	50p
Trivial Pursuit...50p	} 75p		3D Boxing.....	50p
Scrabble.....			Daley Thompson Day 1	
Scalectrix.....			Daley Thompson Day 2	
Cluedo.....			50p	Plus Many Others @ 50p

SPECIAL OFFER PACKS

PACK 1
£2

PACK 2
15 games
£5

PACK 3
17 games +
joystick
£6.50

Prices include VAT. Please add £1.50 Post & Packing. Cheques PO Cash to

PARKER ASSOCIATES

Dept M, 272 Grafton Street,
Buckland, Portsmouth.
Tel: 0705 831538

Insider dealing

Even though he was on holiday, sun-addled PHIL HOWARD still somehow managed to file the third part of his hacking series

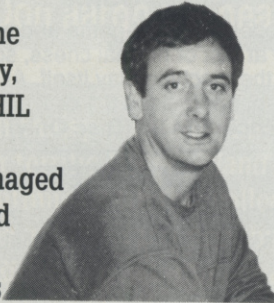

So there I was, liloed out by the pool, sipping my Rondel Semi-Seco, and wondering what I could tell you about protection systems which would be useful and interesting, and yet at the same time not compromise the magazine's anti-piracy position, nor get myself into deep water. Meanwhile, in deep water, some teenage revellers were playing a ludicrous ball game and sending sprays of cold water down my bronzed (er, lobster pink) back. I never knew journalism was so tough.

Anyway, back to reality. Something that many systems use, and that is ideal for the protection of data, is one of computing's fundamental building blocks.

The logical operator, XOR, is widely used in the encryption of programs and program loaders. Not only is it one of the prime tools avail-

able to the protection writer, but it can also be used by the amateur to encode their own data and programs: so it is well worth looking at. To understand XOR's application it is necessary to have an idea of the way it works.

Boole's rush in

Mathematically (groan) it belongs to a system of symbolic logic known as Boolean Algebra. Formulated over 100 years ago, it was created to deal with digital calculations and manipulations.

It operates at binary level, and compares the individual bits from two numbers. Other



```

0574 CD D8 07
0577 C1
0578 10 B1
057A 3E C8
057C 32 19 0D
057F C3 3E 04
0582 3E 39
0584 22 A3 06
0587 32 07 06
058A 3E B7
058C 32 7F 0A
058F 21 FC 05
0592 3E 30
0594 06 08
0596 77

CALL 07D8H
POP BC
DJNZ 052BH
LD A, 0C8H
LD (0D19H), A
JP 043EH
LD A, 39H
LD (06A3H), HL
LD (0607H), A
LD A, 0B7H
LD (0A7FH), A
LD HL, 05FCH
LD A, 30H
LD B, 8
LD (HL), A
    
```

● The lives in *Space Harrier* are stored as an ASCII representation in memory location &0607. Nine lives=&39 ASCII and 57 decimal (try PRINT CHR\$(57))

Extracting Black Box pokes

More and more these days Black Boxes are becoming the hacking/copying utilities.

One drawback, however, as far as the beginner is concerned, is that once transferred onto disk, cheat routines published in *Cheat Mode* are no longer useable.

You can use the cheat to load a tape game, and then save the whole lot with the poke in place to disk, but this means two disk copies a heck of a lot of wasted disk space.

What you need are the poke numbers and the addresses which need altering (see the 'Black Box' pokes often featured in *Cheat Mode*). These can then be put into the game once it has loaded.

Now there is a snag, as there always is. Cheat routines load the program from tape/disk, insert the poke, and then jump into the game, and they are written to work on the code in its initial location.

If a Black Box is used to stop a program while it is running, the code may have been shuffled about.

If it has, then the poke won't work. Still, there's no harm in trying. If you look at the *Cheat Mode* pages you'll find that there are basically

two types of routine.

The first type are mostly Basic (and are often disk pokes). They set the colours, load the code, poke the alterations in, and normally take the place of the loader itself: an example is the *Arctic Fox* poke by Tony Jones in AA40 (poke &A300, 0). The poke is &00 and the address is &A300: this can be used directly as a Black Box poke.

The second type usually has a lump of m/c code in the form of a few data lines, used to deprotect the loader and then poke the alteration in. Generally most of this code is merely for deprotection and is of no use here.

The other part is the actual poke and is mostly only a few bytes long. Thankfully routines are usually written logically, with the deprotector first followed by the poke, followed by a jump into the game.

If they are documented, such as the *Dark Side* poke by Mike Wong in AA45, so much the better.

If not, then begin by looking at the last couple of data lines. Usually the sequence &3E, XX (1d A, poke) - &32, XX, XX (1d location XXXX, A) is used to change single bytes.

The number after the &3E is the poke and the

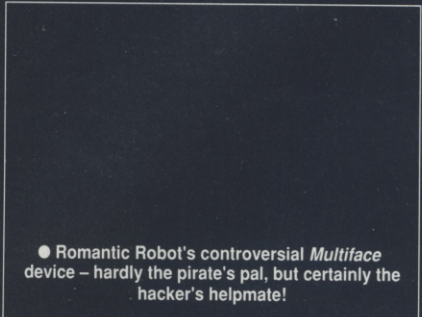

● Romantic Robot's controversial *Multiface* device - hardly the pirate's pal, but certainly the hacker's helpmate!

number after the &32 is the address - and you must remember to reverse it! An example is *Robocop* in AA43, where 3E, C9, 32, F2, 3E - POKE &C9 into ADDRESS &3EF2.

To save on space, programmers often use the single byte instruction &AF (xor A) in place of the two byte instruction &3E, &00 (1d A, 00). It has the same effect - ie *Uridium*, by Peter Featherstone in AA41.

Finally remember that there may well be more than one poke per game, such as in *Tanium* by Graham Smith in AA40

Desperate for a poke? Try this!

You may recall from last month that the first type of system you might come across to decrease the number of lives/energy/time uses the "A" register, which loads a memory location with the amount of lives at the start of the game.

It then reduces that number, again using the "A" register, when a life is lost, by loading A, (LIVES) - decreasing A - and loading (LIVES), A. The second type is very nearly the same, except that it has one or two subtle differences that make it more difficult to detect (wouldn't you know it, you learn the rules and then they get changed).

What you find is that there are a number of programs, perhaps one in five, that work like this. They either load the lives into a memory location using &3E - &03 (say), followed by &32, XX, XX (as before) but then decrease the amount using a different method.

Alternatively, they decrease the lives using &3D (as before)

but load the number into the memory location at the start differently. (Who said this stuff was confusing?!)

So, what do you look for? Well, if you can find the location where the lives are stored there are only a limited number of ways that they can be decreased.

One method uses the HL register pair, which points to and decreases the memory location holding the lives. The instruction &21 XX XX (1d HL, XX XX) tells HL the 1memory location to look at, and then &35 (dec (memory location in HL)) decreases that memory location by one.

This acts without lifting the number out and then putting it back. It's faster, but must be accompanied by a separate routine to check if lives have run out. In this case replace &35 with &00.

A second, slightly rarer method, is to decrease the lives using &D6 &01 (sub 01), which takes 1 away from the A regis-

ter, using a sequence similar to &3D (dec A). This method is often used to count down clocks or timers. Change &01 to &00 making it &D6, &00 (sub 00).

A few others like &0E (dec C), &05 (dec B), or even &2B (dec HL) can, and are, used very occasionally.

However, as the number of lives is generally small you would expect their manipulation to be in single byte registers, and, because "A" is the main single byte register affecting the flags, its use is generally favoured somewhere along the way.

Finding the place where the lives are stored initially is generally the difficult bit, and it's true to say that once found the rest is fairly straightforward.

We shall discuss this further next month. Meanwhile a few things which might prove useful are:

- Always check for one more, and one fewer lives than are displayed, just in case the life checking system operates

differently from usual.

- And if the lives are displayed numerically, it's worth looking for the numbers' ASCII representation (ie. &3E, &33 (1d A, &33) for 3 lives), which is done so that the number can be displayed directly on the screen.

Without the lives' location things start to look black, since the program will be full of &3Ds, performing all sorts of functions.

It is possible, in the last resort, to use the byte search, to go through the entire program selecting likely sequences of &32, XX, XX - &3D - &32, XX, XX, and then running the game with one &3D replaced by &00 or &A7 just to see what it does.

This, however, needless to say, is best reserved for desperate cases!

Try everything else you know first, or it could be a very long night! If you do find yourself trying this method, however, keep track of which part of the game is affected.

```

0D69 C1      POP BC
0D6A 10 F1   DJNZ 0D5Dh
0D6C 21 07 06 LD HL, 0607h
0D6F 7E     LD A, (HL)
0D70 FE 30   CP 30h
0D72 28 3C   JR Z, 0DB0h
0D74 35     DEC (HL)
0D75 32 C8 05 LD (05C8h), A
0D78 3E FC   LD A, 0FCh
0D7A 32 2F 12 LD (12Fh), A
0D7D 06 14   LD B, 14h
0D7F C5     PUSH BC
    
```

● (Space Harrier again) Lives are decreased using &35 (dec (HL)) at &80D74. Note that the program is forced to check for the number reaching &30 rather than zero at &0D70

```

1346 50      RET Z
1343 7E     LD A, (HL)
1344 D6 01   SUB 1
1346 27     DAA
1347 77     LD (HL), A
1348 23     INC HL
1349 7E     LD A, (HL)
134A DE 00   SBC A, 0
134C 27     DAA
134D 77     LD (HL), A
134E 21 E3 08 LD HL, 08E3h
1351 3E 01   LD A, 1
1353 86     ADD A, (HL)
1354 27     DAA
1355 77     LD (HL), A
    
```

● This one's from WEC Le Mans. The HL register is loaded with the memory location &08F2, then &D6, &01 (sub &01) at &1344 is used to count down the timer

operators performing similar functions are AND, OR, NOT and so on (for a summary of these see *Inside Out* in AA45). The operations performed by all of these are implemented in Locomotive Basic, so you can experiment with them without having to resort to m/c code. The CPC User Manual does attempt an explanation, but, predictably, leaves XOR vague.

XOR (=Exclusive Or) compares the corresponding bits of two numbers and produces a third number comprising of the resultant bits. There are three possible outcomes from the operation:

- 1) The resultant bit is 1 if either of the initial bits is 1 (either one or the other);
- 2) but is 0 if both bits are 1;
- 3) and is 0 if both bits are 0.

The difference between OR and XOR is that XOR is exclusive of both bits being 1 (one and the other).

Normally we are used to dealing with 8 bit numbers (0-255). The process is carried out by comparing each of the 8 bits of the two numbers, forming a third 8 bit number.

What, though, has all this got to do with de-coding protection systems? Well, when a number is XORed with a second, the elements

of both are locked up in a third newly created number. Then at some later date the first number can be unlocked by XORing the third once again with the second number (shades of ENIGMA, code-breaking fans!). If you run through a program (which is after all a series of numbers) XORing each number with, say your age, house number, birthday, whatever, the resultant bunch of coded numbers will be meaningless until re-XORED with that same number.

But there's more (oh dear). This is just the start of a 101 ways to implement the feature. Suppose you take your block of code (series of numbers) and your birthday. You XOR the first number with your birthday to create a new number, then instead of using your birthday to XOR the second, you use the result of the first XOR. Then on the third, you use the result from the second XOR, and so on until the end.

Now you have an infinitely more sophisticated system, something like the type used in protections. This sequential method has the advantage that if one number along the way is altered before decoding, then everything from that point will be wrong.

Confused? Ah well, back to the pool, now where's that sun-cream gone...? ●

Stay tuned for more Hacking secrets in next month's *Insider Dealing*, featuring Phil's amusing sun-tan

3 1/2" DISC DRIVE £89.95

800K STORAGE CAPACITY

This quality drive is just 1" high and, when used with Rodos (ROM), Romdos (ROM) or Ramdos (DISC), can store 800K of files without flipping the disc. It is supplied cased. Power supply and cables are included. Please state 464/664/6128.

When supplied with Rodos, price is£119.90
 When supplied with Romdos, price is£124.90
 When supplied with Ramdos, price is£114.90

464 Only

The amazing ROMBOARD XTRA including 6128 UPGRADE SOCKET

FEATURES plus - 6 Standard ROM Sockets
 Put a 6128 ROM in the 7th socket and you have a working 6128 operating system. Upgrading is as simple as that!
plus - 464/6128 selector
plus - Cold start RESET BUTTON
plus - Through connector for further expansions

ALL THIS FOR JUST £20

6128 ROM £19.50 64K RAM PACK £49.95

6128/664

THIRD DRIVE SWITCHING CABLE

Connect to any combination of 5.25", 3.5" or 3" disc drives.

ONLY £8.50

(Please state makes of drives if known)

We buy and sell quality used computers and peripherals. Give us a ring and we might have it.

MICROSTYLE

DEPT AA, 212 Dudley Hill Road, Bradford BD2 3DF

Tel: 0274 636652

A SMALL SELECTION FROM OUR WAREHOUSE

Hardware & Peripherals (Offers while stocks last)

	RRP	WAVE
Amstrad CPC6128 Green with Joystick & Software	299.99	254.99 ANC
Amstrad PCW8512 Computer/Word Processor	516.35	427.80 ANC
••• Amstrad Service Exchange Spares Available - Phone for Prices •••		
DDI-1 1st 3" Drive Inc, Interface & Cable - CPC464	159.95	126.36 B
FD-1 2nd 3" Drive - CPC/+3 (6128/+3 Also Reqs. DL-2)	99.95	85.14 C
DL-2 Cable - FD-1 to CPC6128/+3	6.95	5.56 E
PL-1 Lead, Printer Centronics Parallel - CPC/+3/+2A	14.95	7.48 F
Star LC10 Parallel F&T NLQ Printer	297.85	184.35 A
Panasonic KXP1081 Parallel F&T NLQ Printer	281.75	162.00 A
Citizen 120D Parallel F&T NLQ Printer	228.85	131.59 A
2228RN Ribbon Re-inking Nylon - Panasonic KXP1081, PKT2	18.28	3.92 F
Fabric Ribbon Re-inking Fluid (Aerosol)	8.95	7.16 E
Trojan Light Pen & Graphics Software - CPC464 Colour	19.95	14.96 E
Trojan Light Pen & Graphics Software - CPC6128 Colour	23.95	17.96 E
Dust Cover Set 2 Piece Set - CPC (state model)	8.63	5.61 D
Amstrad Videomatic Camcorder (as advertised on TV)	499.99	449.99 B
Amstrad Carrying Case for Videomatic	14.95	12.71 D
Amstrad Extra Power pack Rechargeable for Videomatic	29.95	25.46 E
Scotch EXG EC30 VHS-C Format Video Tape	5.99	4.91 F

DO YOU WANT TO SAVE MONEY, THEN SEND FOR OUR TRADE PRICE LIST

(State for which products and enclose 3 x 19p stamps)

Blank Discs & Software

The following disc software titles RRP 12.99/14.99 Our price only 3.99 E Strike Force Cobra, Movie, Ping Pong, Through The Trap Door, Yogi Bear, Mr Weems & The She Vampires, Deactivators, Druid.

Amstrad Amscase Library Case Holds 10 x 3"	7.95	3.98 E
Amsoft 3" Discs DS/ALL 3" Drives	Box 10	20.93 E
Maxell 3" Discs DS/ALL 3" Drives	Box 10	19.44 E
JVC 3.5" DS/DD 135TPI Bulk Discs	Pkt 25	20.63 E
Verbatim 5.25" DS/DD 40/80T Bulk Discs	Pkt 25	6.82 D
D.B. Lockable Storage Box Holds 50 x 3"	23.77	7.13 D

CAPTAIN CAVEMAN BBS NOW ON LINE 4PM TO 9AM 0229-43609

Eng. Mainland post & ins.: (A) £5.75 (B) £4.60 (C) £3.45 (D) £2.30 (E) £1.15 (F) 58p (ANC) 3 Day £10.35 Next Day £13.00, COD+ £2.30, Max UK post chg. £6.90 per 20kg/£500. All Prices Include VAT. All sales subject to our Trade Terms of Trading.

W.A.V.E. (Trade Dept. AA 889)

Walney Audio Visual & Electrical Distribution
 1 Buccleuch Street, Barrow-in-Furness, Cumbria, LA14 1SR
 Tel: 0229-870000 (6 lines) Hours: Mon - Fri 10.00-5.00

ROCK STAR

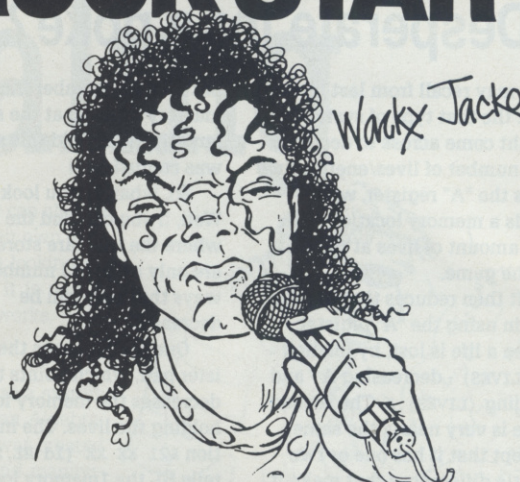

Could you manage this Rock Star?

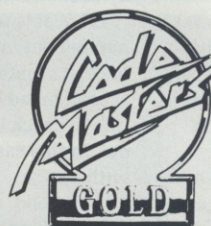

CodeMasters Software Company Ltd., PO Box 6, LEAMINGTON SPA, CV33 0SH

POOLSWINNER II

THE ULTIMATE POOLS PREDICTION PROGRAM

- **MASSIVE DATABASE** Poolswinner is a sophisticated Pools prediction aid. It comes complete with the largest database available - 22000 matches over 10 years.
- **PREDICTS** Not just SCOREDRAWS, but ALWAYS, HOMES and NO SCORES.
- **SUCCESSFUL SELEC guarantee** that Poolswinner performs significantly better than chance.
- **ADAPTABLE** Probabilities are given on every fixture - choose as many selections as you need for your bet. The precise prediction formula can be set by the user - you can develop and test your own unique method.
- **SIMPLE DATA ENTRY** All team names are in the program. Simply type in the reference numbers from the screen. Or use FIXGEN to produce fixture list automatically (see below).
- **LEAGUE AND NON-LEAGUE** All English and Scottish League teams are supported, and also the non-league sides often used on pools coupons.
- **PRINTER SUPPORT** Full hard copy printout of data if you have a printer.

PRICE £24.00 (all inclusive)

FIXGEN 89/90 AT LAST! No more struggling for hours to get the fixture list into the computer. FIXGEN has been programmed with all English and Scottish League fixtures for 1989/90. Simply type in the date, and the full fixture list is generated in seconds. Fully compatible with Poolswinner. Yearly updates available.

POOLSWINNER with FIXGEN £26.50 (for both)



COURSEWINNER V3

NOT JUST A TIPSTER PROGRAM, Coursewinner V3 can be used by experts and occasional punters alike. You can develop and test your own unique winning system by adjusting the analysis formula, or use the program in simple mode. Coursewinner V3 uses statistical analysis of major factors including past form, speed ratings, course statistics, prize money, weight, going, trainer and jockey form etc. etc. It outputs most likely winners, good long odds bets, forecasts, tricast etc. The database includes vital course statistics for all British courses. You can update the database - never goes out of date. **FULL PRINTER SUPPORT.**

PRICE £24.00 (all inclusive) includes Flat AND National Hunt versions.

AVAILABLE FOR AMSTRAD CPCs BICs COMMODORE 64/128 SPECTRUM AMSTRAD PCW IBM Format COMMODORE AMIGA ATARI ST **Please state tape or disc (add £2.00 for disc).**

Send Cheques/POs for return of post service to ...

selec
SOFTWARE

VISA Access
phone 24 hrs

62 ALTRINCHAM RD, GATLEY, CHEADLE, CHESHIRE SK8 4DP. ☎ 061-428 7425
 (Send for full list of our software)

AA Buyers Guide

So you want to spend some money on your CPC? Well, first of all you need to know what's available. And here's the place to find it. We've listed the best and best known programs in each category, and given you the producer; the phone number; the price; the issue in which the item was reviewed; and last but not least, a brief description of the program's features and, where appropriate, shortcomings.

Don't take our word for it, though: we recommend you read the original review before you splash out, and, even better, ask the person from whom you're buying if it meets your particular needs. Best of all would be a try-out, if you can find a friend who already has what you're thinking of buying.

WORD PROCESSING

Brunword 6128

Brunning Software ☎ 0245 252854
 £16.50 tape, £25 disk ● reviewed AA24
 40 or 80 column mode; spell checker loaded into extra memory. Suitable for expanded 128K machines. Superscript/subscript effects on-screen. Includes Datafile. Available as 'Junior Brunword' at £12.95 in slightly cut-down version.

Mini Office II

Database Software ☎ 051 357 2961
 £14.95 tape, £19.95 disk ● AA6
 If you don't need full specification *Mini Office II* is the one to buy. Remarkably cheap for word-processor, database and spreadsheet, plus comms software and more. Packaging and documentation good, and programs work in a menu environment.

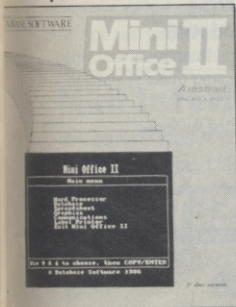

Pendown

Logotron ☎ 0223 323656
 £19.95 disk only ● AA18
 A complete tutorial in the theory and practice of word processing - it's great fun, too. Open system, owing much to expensive DTP packages.

Protex

Arnor ☎ 0733 68909
 £19.95 tape, £26.95 disk, £39.95 ROM ● AA3
 Lightning fast on all tasks involving screen. True merging from separate files and disks to the cursor position is easy, and *Protex* supports standard CPC RSX's like DISC, TAPE, CAT etc. ROM version is excellent. Bad points: maximum file space limited to machine memory - about 22K on disk, 38K for the ROM version. As used by AA, if that's any recommendation (don't answer that).

Pyraword

Discovery ☎ 0742 753423
 £14.95 tape, £17.95 disk ● AA18
 Similar in use to Discovery's *Pyradev*. It loads a profile of inks, printer codes and character set. Word counting, changing disk drives etc - 'house-keeping' tasks - are handily located. Uses extra memory of 128K machines for spooling printed documents and storing text. True file merging is impossible, and control keys are odd. Margins cannot be set further apart than 80 columns, although placing a printer control character at the right hand side allows wider documents to be printed

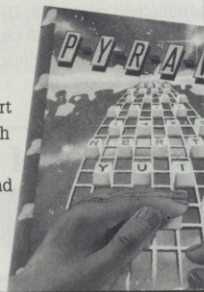

Tasword

Tasman Software ● 0532 4388301
 464, 464D, 6128 ● £19.95 tape/£24.95 disk ● AA1
 464 is the tape based version (the same as *Amsword*). 464D has enhancements for a disk drive. 6128 makes full use of a 6128's extra memory. The latter pair include mailmerge facility. Easy to get to know: comprehensive help screens. Screen operations are slow, and *text* is reformatted a word at a time.

Wordstar

Micropro/Cumana ☎ 0483 571666 £49.95 disk only (CPM) ● AA1
 Files can be as big as the space available. A professional program, with huge manual and a layout like mission control. If you want a function, it is in there... somewhere. Not fast.

PRINTERS

Manufacturers' recommended retail prices are listed as guidelines, but heavy discounts are offered by retailers.

Amstrad DMP/2160

Amstrad ☎ 0277 230222
 £159.95 ● AA6
 Load through front: printer must be above paper; but loading continuous stationery is easy. Poor NLQ mode. £5 for ribbons. Low priced, rather than a bargain.

Amstrad DMP3160

Amstrad
 £228.85 ● AA29
 Similar to but faster than DMP2160. Accepts all IBM and Epson printing codes. NLQ is front loading system. Good buy.

Amstrad DMP4000

☎ 0277 230222
 £401.35 ● AA20
 A real text cruncher. Wide carriage, and really flies across the paper, up to about 200 cps (in NLQ about 50 cps). Fonts available: standard 9 pin Pica, Elite, condensed etc. - but they are different, rather than just adjusted spacing for the same characters.

Amstrad LQ3500

☎ 0277 230222
 £401.35 rrp ● AA31
 Cheapest 24-pin printer. Paper loaded from the rear - more time consuming. 30 cps in letter quality mode, and 62 cps in draft. Print quality excellent: plenty of different type-styles built in. Not ultra fast.

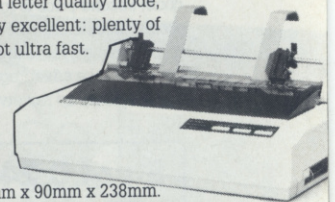

Citizen 120D

Citizen ☎ 0800 282692
 £159 ● AA43
 Dimensions: 3.7 kgs, and 370mm x 90mm x 238mm. Draft quality is 'dott,' and poor, but NLQ is sharp and simple. A quiet beast, with cable to the computer connected on the side. Manual includes a complete written breakdown of all the printer control commands, and their effects.

Epson LX800

Epson ☎ 01 902 8892
 £320.85 ● AA29
 Very fast for 9 pin. Control panel for style selection, and Epson compatible. Reverse winding sheets requires care, though.

Epson EX800

☎ 01 902 8892
 £458.85 ● AA29
 Upgradable in 101 ways - cut sheet feeds, serial ports, longer life ribbons. Quiet, with respectable printing speed. Sans Serif/Roman NLQ fonts incorporated. Control panel to select fonts - just the same font with different spacings.

Epson LQ500

Epson ● £803 rrp ● AA29
 Features galore and price to match. Handles both Sans Serif and Roman styles of NLQ, for instance. Colour-printing upgrade kit available. 24 pin printer, offering excellent quality printing. Control panel to select from many available fonts (ie. the same font at different widths).

Panasonic KXP3131U

Panasonic ☎ 0753 73181 ● £335.25 (discont.) ● AA29
 Daisywheel therefore superb quality - but can't print bit graphics (no trendy screen dumps), and if you want

different fonts, you have to plug in a different Diablo-compatible one. Not quiet.

Mannesmann Tally MT81

Mannesmann Tally ☎ 0734 788711 ● £149 ● AA43

Dimensions: 70mm X 100mm X 265mm; weight, 4.5 kgs. Draft quality is 'dott,' and poor, but NLQ is sharp and simple. Prints Epson and IBM graphics. Draft mode print quality is good: square printhead pins put ink onto greater areas. The printed output is more ornate than the Citizen. Manual is superb, but falls down in failing to explain control codes: for that you have to buy the applications manual. Certainly a very good buy.

Panasonic KXP1081

Panasonic ● £245 rrp ● AA29

Similar to DMP2000/2160: chunky, 9 pins, 10 inch carriage and compatible with Epson codes. Thorough A4 manual, good NLQ mode – better than DMP – and condensed, draft and NLQ modes.

Star LC-10

Star ☎ 01 840 1800 ● £263.35/£343.85 rrp ● AA32

First price is for standard dot matrix printer. Fonts selected by button, rather than typing in fiddly control code. Second price is for relatively inexpensive colour model. Uses multi-colour ribbon to produce different mixes, though there are currently no commercial programs to take advantage of this capability (but see the *Colourdump* review in this issue, page 24).

Star LC 24-10

£458.85 rrp ● AA47

A low-cost 24 pin, 10 inch, 80 column Letter Quality printer: 8 resident fonts, all operable from the front control panel and 3 print variations. See the review in this issue, page 22.

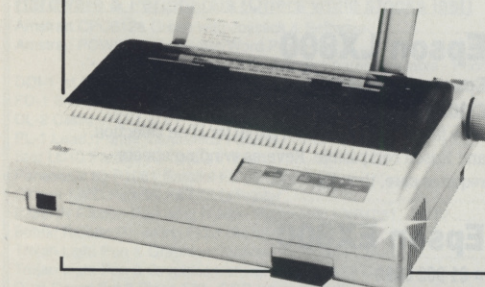

INTEGRATED PACKAGES

Info-Script

Brunning ☎ 0245 252854

£46 disk only ● 128K/256K only ● AA35

Billed as the 'complete database with word-processor and spelling checker', it's best with 256K. Well set up, easy to use and allows for changes in layout and content. Manual could be clearer.

Protex Filer/Office

Arnor ☎ 0733 68909

£24.95/£34.95 disk only ● AA34

Database that works comfortably with *Protex*, has powerful sorting options and comprehensive invoice printer. Can be slow, but good value.

Mini Office II

Database ☎ 051 357 2961

£14.95 tape, £19.95 disk ● AA6

Astonishingly cheap word processor, database, spreadsheet, graphics, comms and label printer all-in-one, it's continued to sell, and sell... Not full specification, but at this price who's complaining?

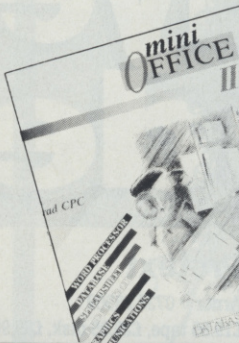

EDUCATIONAL PROGRAMS

Amstrad Selection

Fernleaf Education ☎ 0474 359037

£12.50 tape, £17.50 disk ● AA32

For age range 7 to 12+: seven programs – *Fletcher's Castle*, *Market Stall*, *The Perfume Hunter*, *The Raiders*, *Ferry Captain*, *Treasure*, and *Thorn Sea*.

Arc Master Pack

Arc Education ☎ 0472 812226

£48 disk ● AA32

A massive pack of 70 programs: Junior; Primary; a parent/child adventure; DR Logo and word games. Each set available at £9 tape and £12 disk. Well presented with good graphics, reasonable musical ditties and plenty of options.

Funschool 2

Database Software ☎ 0625 878888 ● AA43

So rare is it that educational software gets into the charts that it made the news pages of the weekly computer press. Actually there are three great packages here: under sixes, six to eights and over eights.

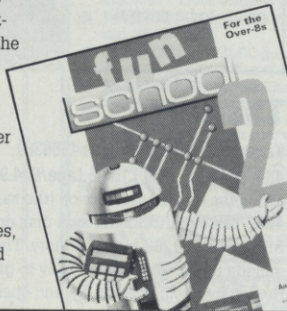

Kosmos

Kosmos ☎ 05255 3942 ● £9.95/£13.95 ● AA32

Answer Back Junior Quiz lets you either answer the question; make a choice from a number of options; or say whether something is true or false. There's also *Factfile 500*, sets of additional questions for the program: arithmetic, spelling, sport and natural history.

The other range from Kosmos: vocabulary tutors in French, Spanish, German and Italian.

Wordhang

Bourne Education ☎ 0794 523301

£9.95 cassette; £14.95 ● AA32

One of Bourne's range of ten programs. Others include

Happy Letters, *Numbers and Writing* (all Infant); *Timeman One/Two* and *Map Rally* (all Junior); and the excellent *Chemistry and Physics Revision* (Senior).

● See also Pendown in 'Word Processing'

BUSINESS/ACCOUNTS

Protex Office

Arnor ☎ 0733 68909

£34.95 ● CPM+, 6128 only ● AA34

Requires *Protex* and *Promerge* to run. Information inputted using *Protex*. Mail merge templates included, and very well implemented invoice printing feature. A genuinely useful business system.

SD Microsystems range

☎ 0462 675106

General Ledger ● £19.95 ● AA32

Sales Invoicer Pack ● £14.95 ● AA26

Small Traders Pack ● £24.95 ● AA26

Stock Control ● £39.95 ● CPM+, 6128 only ● AA32

SD Microsystems have a range of quality small business systems. Consult original reviews for in-depth explanations of what each does and how it differs from the others – or better still, ring them and ask.

DATABASES

AtLast Plus

Rational Solutions ☎ 056681 511

£39.95 ● CPM+, 6128 only ● AA30

Powerful: developed into user's requirements. Data capacity restricted only by disk size, and splitting fields into smaller elements possible. Printed output impressive. Beefy processing.

Masterfile III

Campbell systems ☎ 0378 77762

£39.95 CPM+ ● AA30

With parent/child records – enabling tying together of records, saving space and time. Screen layouts and reports menu selected; not for faint hearts, but good results.

Random Access Database

Minerva Systems ☎ 0392 37756

£29.95 disk only ● reviewed AA6

40 or 80 column screen. Good mathematical and string operations. Random disk accessing gives speed and power.

● See also Info-Script in '4. Integrated Packages'

SPREADSHEETS

Mastercalc 128

Campbell Systems ☎ 0378 77762

£33 disk ● 128K machines ● AA4

Can show two parts of spreadsheet at once. Includes notepad and calculator. Easy to use, but the mathematical formulae can only consist of the four basic arithmetic options. Slows down as more data is entered.

Cracker

Newstar Software ☎ 0277 229509
£49.95 disk CPM+ ● AA9
 Spreadsheets must be created from scratch. Documentation good, command sequences soon learned. Mathematical functions well done, with random numbers catered for. Files limited to 17K – and formulae programming not well implemented.

The Cracker
 user's manual

Matrix

Audiogenic Software ☎ 0734 303663
£34.95 disk ● AA18
 Uses disk to store data – so good capacity on the plus side, but poor speed on the minus side. Graphic options excellent. Onscreen prompts rare, making it hard at first. Calculating power good.

Supercalc II

Amsoft/Sorcim ☎ 0277 230222
£49.95 CPM+ ● AA4
 First class documentation. Calculations can be determinative – performed on whether or not cell's contents match given value. Excellent help prompts and arithmetic functions.

SOUND

Amdrum

Cheetah ☎ 0222 555525
£34.95 ● AA13
 Digital drum machine. Editor comprehensive. Not Midi compatible: to hear output you plug it into amplifier.

DHCP Midi Interface

DHCP ☎ 0440 61207
£69.95 interface, £34.95+ disk s'ware ● AA33
 DHCP produce Midi software for various Midi interfaces for CPC, which are incompatible with each other.

Micro Music Creator

First Byte Software ☎ 0225 765086
£14.95 disk, £24.95 ROM ● AA38
 A music composer that lets you put staves and notes onscreen and play tune back. Accents can't be inserted, though. Other side is sampler to capture sounds from tape and play them through CPC. Excellent.

Midi Interface

Silicon Systems ☎ 061 848 8959
£59.95 interface, £59.95 software ● AA26
 Useless alone, but software you can use with it – DX7, FB01, MT32, D50 and CZ101 – is diverse. Software prices vary, and lack presentation of EMR sequencer. High performance.

Ram Music Machine

RAM Electronics ☎ 0252 850085
£49.95 disk, £59.95 disk ● AA17
 All in one music package: Midi interface, sound sampler and music editor. Sampler can handle one sample of just over a second. Midi controller software and music editor comprehensive. No through port, though, so 464 users must use tape version. And you can't edit live played Midi compositions.

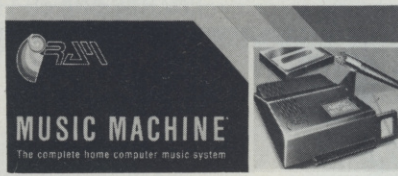

Miditrack Performer

EMR ☎ 0702 335747
£92.50 cass/disk ● AA13
 Midi interface plus sequencing software to drive Midi equipped instruments. Records each instrument then plays them all at once. Onscreen layout similar to multi-track recorder. Excellent.

Sound Blaster

Siren Software ☎ 061 848 8959
£29.99 ● AA23
 Amplifier and pair of loudspeakers that plug into CPC for maximum 2 watts sound effects.

Speech Synthesizer

DK/RAM Electronics ☎ 0252 850085
£35, £40 ROM
 Add-on producing speech by RSX's: loudspeakers supplied. Cannot include speech in program for someone else's CPC, though. Even so, excellent speech quality and value.

VISION

Advanced Art Studio

EEC ☎ 0753 888866
£24.95 disk ● AA21
 Recently revitalised, this is the user-friendly, best and most powerful art package: works in all three modes. Can cycle through inks, and cut and paste different areas, transformations and reflections. Fill routines in coloured patterns. Available as a standard version for £15.95.

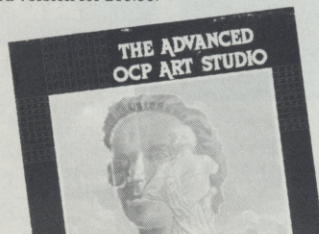

AMX Art

Advanced Memory Systems ☎ 0925 413501
£69.95 disk only (includes mouse) ● AA7
 User friendly, if little unsophisticated compared to Advanced Art Studio, but mouse helps greatly. Colour, sprays, textures, circles and host of other features.

Cherry Paint

Siren Software ☎ 061 228 1831
£9.99 disk only ● AA20
 WIMP controlled – ie mouse moves pointer to various icons to pull-down menus. B/W mode 2 only, but fun. Curves are difficult, but this is a bargain.

CRL Image System

CRL ☎ 01 533 2918
£14.95 disk/tape ● AA12
 Boasts range of picture manipulations and distortions, but lacks art options. Best on finished pictures – like a mini Quantel box.

DART Scanner

Dart Electronics ☎ 0502 513707
£79.95 ● AA22
 Attach reading device to your DMP2000, 3000 or 3160. Feed in picture to printer: device reads in picture as B/W image. Quality onscreen isn't amazing, but it works and it's fun.

Electric Studio Light Pen

Electric Studio ☎ 0462 420222
£19.95 tape, £29.95 disk ● AA1
 Excellent drawing software, including rubber-banding shapes and lines, filling areas, spray-can etc. Accepts software written for it.

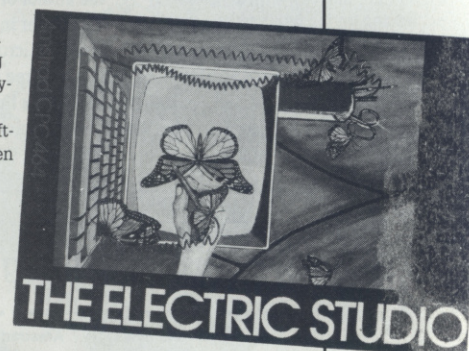

The Informer

Treasure Island Software ☎ 0492 593549
£29 disk only ● AA33
 For creating animated displays, suitable for classroom and shop window: takes text, graphics and animated displays and produces slide show. Works best but not only with Parrotty Plus (see below).

Parrotty Plus

Treasure Island Software ☎ 0492 593549 ●
£19.95 disk only ● AA30
 Rather than lots of effects used anywhere and at any time, Parrotty Plus 'remembers' every alteration and plays through the list to create animation. Note: can't dump pictures to printer without external program.

Vidi Digitizer

Rombo Productions ☎ 0506 39046
£89.95 ● AA15
 Grabs picture from video recorder or camera and puts it on CPC screen, allowing you to alter it with a package. Easy to use. Software on tape, disk or ROM includes superb printer dump routine. ●

● Corrections, additions or ideas for sections you think should be here are very welcome. Drop a line to: AA Buyers, Amstrad Action, 4 Queen St, Bath BA1 1EJ

You mustn't miss
AA's scorching hot
and still steaming
September issue out
on Thursday 10th
August!

Afterthought

Is it a bird? Is it that corny old headline everyone always uses? Well, yes it is actually

A while back, eagle-eyed readers will recall, we were privileged to review Microprose's *Airborne Ranger*. It merited a massive 90% on the old AA Ratingsometer. And to celebrate we teamed up with the Tetbury terrors to bring you the chance to win a day out to remember – including a flight in the Microprose Piper Cherokee!

Tons of entries flooded in, and when the time came first out of the AA competition dustbin was

KRYSZYNA GIBBONS from Bargoed. She brought CARL HARRISON with her – who by a strange but genuine coincidence was the author of the prize-winning letter in *Reaction* last month. Microprose PR

person Martin Moth, 23 (young, free and single and you can see why), took them around HQ and allowed them to plunder the massive warehouse (just wait till



● I hope Carey's better at these controls than he is at *Airborne Ranger*

Wild Bill hears about that). Staggering under the weight of every CPC game Microprose have ever done (*Soccer*, *3D Pool* (see this issue), *Gunship*, *Times of Lore* and many more), t-shirts, mugs and

posters they were led to a waiting car and chauffeur Clare Gardener (who took these pictures too, by the way) to be driven off to G-OMPS, the



● Krystyna and Carl, keeping their heads when all about them are losing theirs

Microprose Piper Cherokee. Neither was the petrified ed allowed to get away...

After a flight that took in some spectacular and lunch repeating views of Bath, Home of the Stars (and also of AA), Krystyna said that it had been

"Terrific. Everyone at Microprose was really great and went out of their way to be helpful." And the flight? "Spectacular view, but I'm not keen to repeat the experience soon!"

Still using that boring old cowboy picture? Yup!

To the newsagent: Amstrad Action is distributed by COMAG

Dear newsagent,
Please reserve me a copy of the fabbo September *Amstrad Action*, due out on Thursday 10 August

Name:

Address:

Telephone number:

If you're under 16, please get your parent or guardian to sign here:



Save shoe leather and subscribe to AA!

That's right, sole fans! Now's your chance to cut down on the old footslogging by taking out a subscription to your favourite read – and while you're at it, why not subscribe to AA, too?

Let your fingers do the walking back to page 29 for this wonderful opportunity. And remember, an AA in the postbox is worth two in the newsagent's!

Matrix Software Hire

The cheapest way to play them all.

Top games titles for Amstrad, Commodore, Spectrum and Amiga.

Please state system

Please send large SAE for details to

Matrix Leisure Club, Dept AA,
271 Stansted Road, Bishops Stortford
Herts CM23 2BT

ADVERTISERS INDEX

1st Choice.....	67	Microstyle	74
Camel Micros.....	71	MJC	32
Castle Computers.....	52	Mode One.....	51
Codemasters	21, 51, 60, 74	Nemesis.....	26
Compumart.....	15	Ocean	IBC, OBC, 44, 45
Crazy Joe's.....	60	Parker Associates.....	71
Database	35	RDS Techno	34
Datel	38, 39	Romantic Robot.....	21
E & J Software.....	51	Screen Vision	21
First Byte	71	Selec.....	74
Grand Slam	56	Siren Software	60
Goldmark	18	Soft Exchange	26
G-Ten	71	Strategy Software	34
Home Based	51	Swift	28, 29
Incentive Software	34	US Gold	IFC, 3, 6
John Morrison	71	VSE	51
K & M Computers	10	Wacci UK	54
Matrix.....	78	W.A.V.E.....	74

Excellent reasons for subscribing to AA **Now!!**

- Make sure you get your issue, the shop may sell out !!
- Get your quarterly update of extra special savings on goodies
- Subscribe to Amstrad Action for £17.95 and you will receive 12 issues plus £20 worth of vouchers

See page 74 for details of our Voucher scheme.

Order Code AA396

HIGHLIGHTER PENS

Three for £1.50

For bringing out those key phrases, there's nothing like these AA-embossed pens in red, yellow and green.

Order Code AA266

AA DUST COVERS

2-piece set only £6.95

A set of dust covers provides a neat solution to dust, tea and other potential computer disasters.

These specially-commissioned Amstrad Action covers are made from high-quality, water (and coffee) proof PVC. They're coloured a gentle beige with smart blue trimming and matching AA logo.

You can order a 2-piece set tailor-made for your CPC system – just choose the correct order code from the list below.

Order Codes

464 mono -	A208	664 colour -	A211
464 colour -	A209	6128 mono -	A212
664 mono -	A210	6128 colour -	A213

T-SHIRT

Just £3.99

The amazing AA T-shirt is here! The sparky red and blue AA logo is printed on a white cotton T-shirt which you can buy for £4.99 in either medium or extra large sizes. Get this and you'll have AA even nearer your heart than ever before!

Order Code

A361 (medium)

A362 (extra large)

AA BINDERS

Just £4.95 each

The fabbo AA binder is the ideal item in which to store your growing collection of the world's most popular CPC magazine! Holds 12 issues, this royal blue binder with gold embossed logo on side and front is an essential purchase for even half-serious readers.

Order Code AA217

(Or buy two for £9.00

Order Code AA2172)

AA Back Issues are just £1.25! or £1.50! See page 74 for details

See over page for order form

THE ADVANCED OCP ART STUDIO ● From EEC

RRP £24.95 AA Price £19.95

For CPC6128 users (or 464 users with disc drive and 64 rampak)

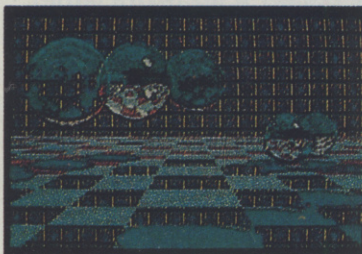
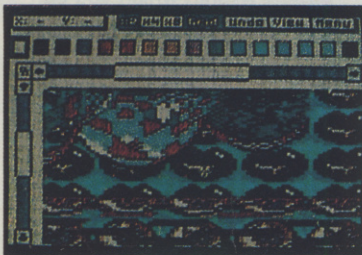

The ultimate in computer art and design for your CPC — no budding artist should be without. Operates from mouse, keyboard or joystick control. Includes 16 drawing pens, 8 random spray cans and 15 user-definable brushes.

- Three levels of magnification with pixel edit, pan and zoom
- Full range of colours
- Windows can be cleared, inverted, cut and pasted, enlarged, reduced, squashed, stretched, flipped and rotated.
- Full-feature font editor allows the design of complete character sets

Order Code AA410



● ORDER FORM No.47

Name _____

Address _____

Please remember the post-code, it is essential!

Tel Number (if possible) _____ Date of Order _____

Please send me the following item(s) from the Amstrad Action Special offer pages:

CODE	DESCRIPTION	PRICE

Total Payable

Make cheques & postal orders payable to FUTURE PUBLISHING LTD. If paying by credit card, please enter details

CREDIT CARD NUMBER

EXP. DATE

Send this form plus payment to SPECIAL OFFERS, AMSTRAD ACTION, THE OLD BARN, SOMERTON, SOMERSET TA117PY

MONEY MANAGER ● From Connect Systems

RRP £29.95 AA PRICE £18.95

Money Manager is an easy-to-use system for recording all financial transactions, and for analysing them in a number of very powerful ways in order to facilitate sound financial management. Ideal for controlling small businesses, or for users wishing to control their personal finances in a business like way.

- Full detailed statements, showing each transaction for any month or for the whole year.

- Bar graphs, pie charts etc.
 - Standing order facility
 - Full telephone support
- CPC 464 (with disk drive) / 6128

Order Code AA291AD

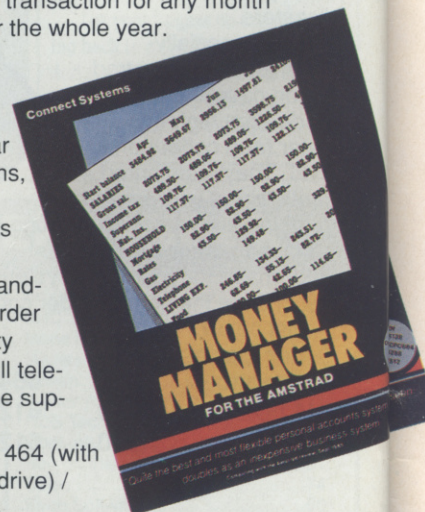

HOW TO ORDER

Just fill in the order form above and use the order numbers listed with the product, Or phone us with your credit card details on 0458 74192 (24-hour answerphone).



EMLYN HUGHES INTERNATIONAL SOCCER

● From Audiogenic

AmsCass RRP £9.95 AA Price £6.95 Order Code AA233AC

AmsDis RRP £14.95 AA Price £9.95 Order Code AA233AD

The best soccer game since Matchday II and Football Manager. With diving headers, free-kicks, throw-ins, goalkicks, corners, penalties and even barging: how more realistic can you get?

Enter your teams and set their skills, then manage them through the season.



"Your ain't played
Footie on your CPC till
you've mastered Emlyn!"

AA June 89

AA CUP WINNER RATING 93%



HOTLINE • PHONE 0458 74011

FUN SCHOOL 2

● From Database/Mandarin

**£6.95 tape £8.95 disk
(RRP £9.95/£12.95)**

Bumper packages of educational software for infant and primary school age children. Fun School 2 comprises of three complete suites of eight programs.

"TEDDY BEAR" For Under-6's

Teddy Count, Teddy Bear Picnic, Colour Train, Find the Mole, Pick a Letter, Spell the Word, Shape Snap and Write a Letter.

"FROG" For 6-8 Year Olds

Number Train, Maths Maze, Caterpillar, Shopping, Packing, Treasure Hunt, Number Jump and Bounce.

"ROBOT" For Over-8's

Logic Doors, Build a Bridge, Passage of Guardians, Unicorn, Escape, Souvenirs, Code Boxes and Mystery Machine

"Fun School 2 lives up to both parts of its title. It is fun, and your child will almost certainly learn too."

AA Issue 43.

Teddy	AmsCass	Order Code AA292AC
Teddy	Ams Disk	Order Code AA292AD
Frog	Ams Cass	Order Code AA293AC
Frog	Ams Disk	Order Code AA293AD
Robot	Ams Cass	Order Code AA294AC
Robot	Ams Disk	Order Code AA294AD



Gerry Anderson's THUNDERBIRDS

● From Grandslam

"Calling International Rescue, calling International Rescue!"

Play the game and listen to the theme on the audio tape. Taken from the Gerry Anderson classic TV series you must attempt to save some miners that have fallen to the bottom of a shaft. Using your superb Thunderbird range of aircraft and machinery, send the Tracy clan on this dangerous mission. With three more adventures including clashes with the infamous "Hood". All the characters are here, including Lady Penelope with her pink Rolls Royce and loyal chauffeur, Parker.

"Thunderbirds has the kind of depth and long term appeal that I find really rewarding"

Steve Carey,
AA Issue 47.



**SAVE
£20**

**Ams Cass RRP £12.95
AA Price £8.95
Order Code AA295AC
Ams Dis RRP £14.95
AA Price £9.95
Order Code AA295AD**

Look over page for details

SAVE
£20

SUBSCRIPTIONS

New subscribers welcome! As well as getting your 12 issues posted directly to you from the printers, we have a unique Subscriber Scheme. This is how it works: immediately you subscribe we send you £20 worth of vouchers for our mail order section. This offer entitles you to a £20 saving on mail order products from these pages over the next 12 months. For every £10 spent you save £1. Plus by subscribing look out for our up-to-the-minute super duper exclusive AA Mail Order Update, which will be posted to you in the next few weeks. Order Code AA396

Only **£17.95**

OVERSEAS SUBSCRIPTIONS

Air-mail Europe £33.95 Order Code AA397

Surface Europe and Rest of World £23.50

Order Code AA398

STORMLORD

1 From Hewson

Free the imprisoned fairy folk before they are obliterated by an evil Queen. She stoops to conquer the land and Stormlord inhabitants, destroying the peaceful euphoria with each annihilation.

Stormlords mission, free the captured and defend the peace and tranquility of his realm. Unfortunately, he must repel the wicked monarch, but should he fail, the evil Queen and her dark sovereignty will reign forever...



"The best looking game so far this year! Looks, sounds and is brilliant." AA Issue 46.

Ams Cass RRP £9.95

AA Price £6.95

Order Code AA412AC

Ams Dis RRP £14.99

AA Price £9.95

Order Code AA413AD

24 HOUR CREDIT CARD ORDERS 1 0458 74192

BACK ISSUES

Expand your Amstrad Action Collection!

If you're one of the thousands of readers who've joined *Amstrad Action* only recently, you'll want to catch up on some of the good things you've missed. Here's how to do it. We have limited numbers of the back issues listed below, which we're selling at cover price with post and packing free.

- | | |
|-------------|---|
| ISSUES 1-22 | SOLD OUT! |
| ISSUE 23 | £1.25 • Launch of Word-Processing series. Utility Type-ins. |
| ISSUE 24 | Two years of AA! Exolon. Word processors. Tas-Sign. More WIMPs. |
| ISSUE 25-28 | SOLD OUT! |
| ISSUE 29 | £1.25 • Six top printers reviewed. Spreadsheets. |
| ISSUE 30 | £1.25 • Discovering databases. How to upgrade a 464 to a 6128. |
| ISSUE 31 | £1.25 • CP/M software section starts. Basic programming reaches part five. |
| ISSUE 32 | £1.25 • Educational software survey. CP/M on ROM. Word processing. |
| ISSUE 33 | £1.25 • Loads of hardware projects! - joystick, splitter, I/O port etc. Comms. |
| ISSUE 34 | £1.25 • Simulation software from space shuttles to bike.. |
| ISSUE 35 | £1.25 • Joy of hacking scrutinised! Buyers guide to computer books. |
| ISSUE 36 | £1.25 • Micronet - worth it? Code Masters? Printer selection. |
| ISSUE 37 | £1.25 • 3rd birthday cover tape includes <i>Dizzy</i> . D & Der's get <i>Heroes of the Lance</i> . |
| ISSUE 38 | £1.25 • Fleet Street Editor arrives. Micro Music. Empire Strikes Back. |
| ISSUE 39 | £1.25 • Language guide - from C to Basic. 14 pages of Xmas games. Gambling with Coursemaster |
| ISSUE 40 | £1.50 • Cover Cassette • <i>Total Eclipse</i> demo • 1988 Games Awards. Turkeys '88. Preview 1989. Comms special. Nemesis. |
| ISSUE 41 | £1.50 • Databases for all, Hard drives • Pilgrim special, Batman, Jedi |
| ISSUE 42 | £1.25 • Wec Le Mans and Airbourne Ranger reviewed
How to write a best seller! Loads of Hot tips!! |
| ISSUE 43 | £1.25 • The Amstrad Entertainment Centre. Citizen v Mannesman Tally Printers. Educational Software, the latest offer |
| ISSUE 44 | £1.25 Joystick Jury. Barbarians II. Professional music programmers, interviewed. |
| ISSUE 45 | £1.25 • DTP a new, cheap package reviewed. Massic AA Soccer Spectacular. Guide on Midi Systems. |
| ISSUE 46 | £1.45 • Forgotten Worlds and Stormlord, two brilliant games! Your best book guide. Whats really inside the CPC? |

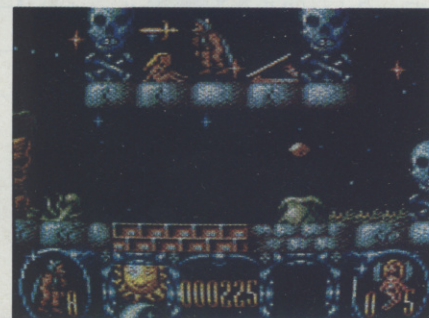

See previous page for order form

**NOW IS THE
TIME TO
TAKE ...**

SPECIAL ACTION

DRILLER

**DALEY THOMPSON'S
CHALLENGE**

S.D.I.
NOW
THE ODDS
ARE EVEN

ocean

5

**ALL-ACTION
CHART-BUSTERS
JAMMED INTO
ONE SPECIAL PACK**

DRILLER

SOLID 3 Dimensional Landscapes like you've never seen before. Thanks to Freespace - it feels like you're actually there. Interact with weird alien mechanisms, avoiding the Ketars Defences and gain access to the many sections of the Moon, Mitral. Experience Driller and Freespace in action ... "A NEW 3 DIMENSIONAL REALITY!" CRASH.

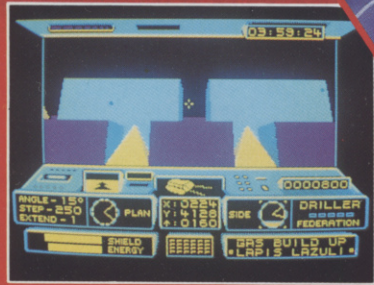

S.D.I.

"The graphics are great with fast flowing backgrounds and smooth, speedy sprites. I now know what I would do if the five minute warning went off ... I would play S.D.I." F.A.B - COMPUTER GAMES WEEK.

THE VINDICATOR

"If you've spent hours developing your trigger finger here's a game to put it to the test ... it's all action" CPC SILVER AWARD - CPC COMPUTING "each level has a high standard of graphics ... The Vindicator is an excellent game." CRASH.

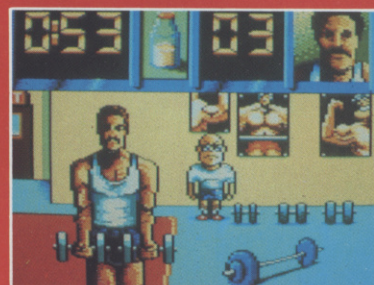

DALEY THOMPSON'S OLYMPIC CHALLENGE

"Excellently animated with some great back-drops ... Daley Thompson's Olympic Challenge is first rate ... another gold medal winner from Ocean." A CRASH SMASH - CRASH.



CAPTAIN BLOOD

"To sum up - Bloody excellent." "The graphics and sound are excellent ... an intelligent strategy game." YOUR SINCLAIR

Special Action from...

ocean

A M S T R A D
C O M M O D O R E
S P E C T R U M

£ 1 7 . 9 9
D I S K

A M S T R A D
C O M M O D O R E
S P E C T R U M

£ 1 2 . 9 9
C A S S E T T E

Ocean Software Limited · 6 Central Street · Manchester · M2 5NS
Telephone: 061 832 6633 · Telex: 669977 OCEANS G · Fax: 061 834 0650

**FUN FROM DOWN UNDER
THAT WILL HAVE YOU STANDING
ON YOUR HEAD**

Taito

**THE
NEWZEALAND
STORY**



**C+VG
HIT!**

**SPECTRUM
8.99
CBM/AMSTRAD
9.99
ATARI ST
19.99
AMIGA
24.99**

TAITO'S ARCADE HIT POUNCES
ONTO YOUR MICRO SCREEN WITH
A BURST OF ZANY ACTION.

Wally Walrus has captured his tea - 20 of Joey Kiwi's friends from the New Zealand zoo, and if Joey doesn't rescue them all by tea-time they'll be stuffed, served and swallowed at Wally's table. Joey has to search Wally's domain which is just how you would expect it to be - FAT with danger!
Armed only with a bow and arrow, Joey can accumulate more weapons along the way. Beware of the malicious rabbits, boomerang throwers, deadly frogs, blood-sucking bats and many, many more villainous creatures.

ocean

Ocean Software Limited · 6 Central Street · Manchester · M2 5NS
Telephone: 061 832 6633 · Telex: 669977 OCEANS G · Fax: 061 834 0650