

NOT
an official
Amstrad publication!

BRITAIN'S BEST-SELLING MAGAZINE FOR THE AMSTRAD



GX4000



ISSUE No. 75
DECEMBER 1991
£2.50

AMSTRAD

SMASH TV!

Will this game drive you to destruction?
Find out on page 38...

Amstrad reviews, tips, letters, help, info and fun than any other mag!

EXCLUSIVE!

Ubi Soft's amazing new music program, only in AA

BUYERS GUIDE

This month: the best in CPC peripherals

BARGAIN OF A LIFETIME?

Siren Software's all-in-one 3.5-inch disk drive pack under the microscope see page 58

ACTION!

WHAT,
no covertape?

Check with your newsagent!

Future
PUBLISHING

Your guarantee of value



ALSO ON DISK!

Want a disk version of the covertape?
(6128 Plus owners take note) Check out the tape pages for details on how to order your copy.

MAD! BA & IN YOUR FACE

WF WRESTLEMANIA

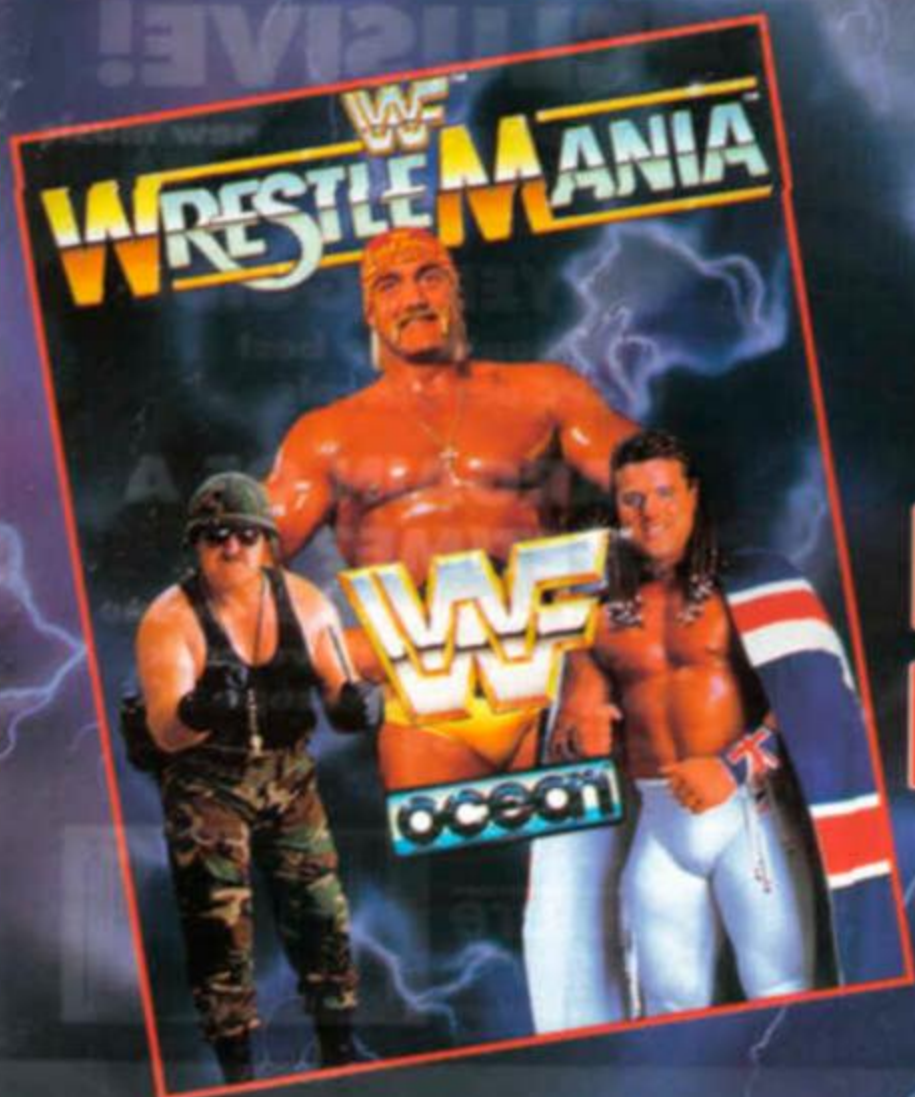

SET
Slaughter

Ed Slaughter

ENTER THE RING FROM YOUR HOME



AD!

AND THAT'S A PROMISE!

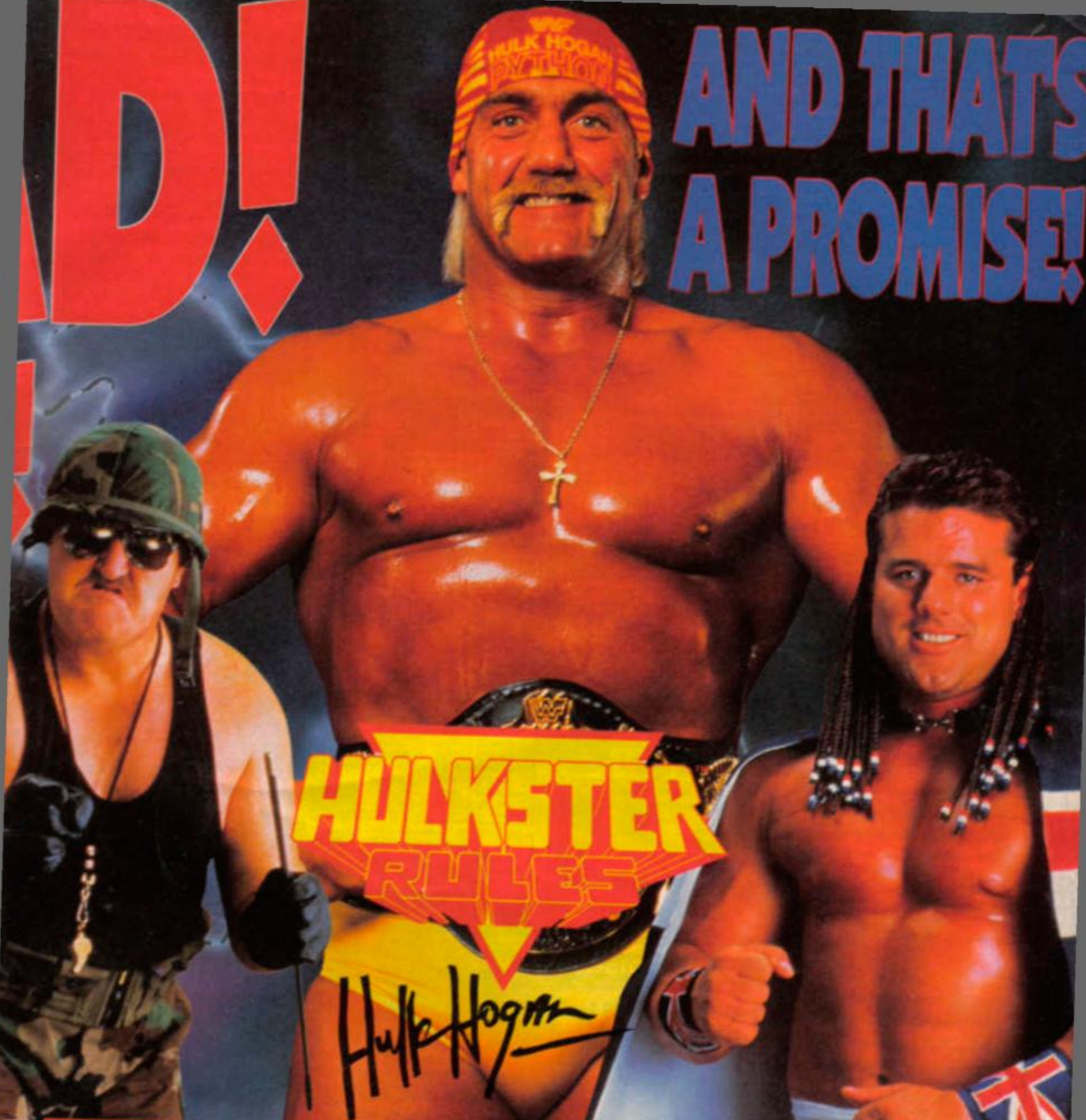

HULKSTER RULES

Hulk Hogan



SPECTRUM - AMSTRAD
 COMMODORE
 ATARI ST - AMIGA
 IBM PC & COMPATIBLES

*The
 British
 Bulldog*



BRITISH

BULLDOG

OCEAN SOFTWARE LTD, 6 CENTRAL STREET, MANCHESTER, M20 5NS. TEL: 061 832 6633 FAX: 061 834 0650

AMSOFT CF2 DISKS

5 for£8.95
10 for£15.95
20 for£29.95

DESKTOP PUBLISHING

STOP PRESS SOFTWARE

A superb page layout program allowing text and graphics to be printed on the same page. Contains a number of text fonts & clip art. Create leaflets, posters etc
ONLY £34.95

STOP PRESS & AMX MOUSE

As above but is supplied complete with the AMX mouse making the program a lot quicker and easier to use.

CALL

EXTRA! EXTRA!

Two disks of extra fonts and clip art for use with Stop Press.
ONLY £14.95

★★ SPECIAL OFFER ★★

**STOP PRESS SOFTWARE AND EXTRA! EXTRA!
ONLY £44.95**

AMSTRAD 6128 PLUS COMPUTERS

With COLOUR stereo sound monitor, disk drive, and 128K RAM. Takes GX4000 type cartridge games as well as most CPC disk programs. New connectors for printer, expansion and disk drive ports, but no tape option.
£249.95

RIBBONS

Quantity

Printer	1	2	5
DMP 2000/3250	3.00	5.50	12.00
Panasonic KXP1081	3.95	7.00	15.00
Citizen 120-D	3.95	7.00	15.00
Star LC10 Black	3.95	7.00	15.00
Star LC24-10	4.95	9.00	18.00
Panasonic KXP-1124	5.95	11.00	—
Star LC10 Colour	5.95	11.00	—
Star LC200 Mono	5.50	10.00	—
Star LC200 Colour	10.95	19.95	—
Star LC24-200 Mono	4.95	9.00	—

Heat Transfer Ribbons

	x1	x2
Citizen 120-D	6.95	13.00
Panasonic KXP 1081	7.95	15.00
Star LC-10 Black	6.95	13.00
Star LC-10 Colour	11.95	23.00

SERIOUS DISKS

PROTYPE

Amor's excellent print enhancer is a must for all Protex users
MJC PRICE £21.95

Protex	18.95
Prospell	16.95
Promerge	16.95
Matrix Spreadsheet	29.95
Tasword 6128	23.95
Tasprint	11.95
TasSign (6128)	23.95
Qualitas Plus v2	14.95
Qualitas Font Library	11.95
Qualitas CPM+ disk	8.95
Masterfile 3 (Database)	29.95
Mastercalc 128 (Spreadsheet)	25.95

★★ LET'S GET SERIOUS ★★

A monthly look at serious software
This Month: Mini Office 2
Over the last three months we have looked at spreadsheets, word processors and databases. This month we take a look at a package containing all three of these.
Mini Office 2 is the ideal introduction to serious software. For the price of a game you get a basic **Word Processor**, capable of using any Epson compatible printer, a **Spreadsheet**, which can be used for all kinds of numerical work, a **Graphics** section for producing pie charts, line graphs and bar charts from the spreadsheet data, **Database** for keeping a card-index of names and addresses, which links up with the **Label Printer** for address labels.
MINI OFFICE 2 DISK £13.95
cassette version £9.95

Stockmarket (share analysis)	29.95
Money Manager (home accounts)	21.95
X-Press v2.0	18.95
Sprites Alive!	17.95
Sprites Alive! Compiler	22.95
Maxam Assembler	18.95
Mini Office 2	13.95
Advanced Art Studio	19.95
ColourDump 2	12.95

**3D CONSTRUCTION KIT
£19.95**

GAMES DISKS

MJC SPECIAL FINAL FIGHT

RRP £16.99 Ours £11.95
Offer runs from 1/12/91 to 31/01/92

Back to the Future 3	10.95
Capcom Collection	19.95
Chips Challenge	11.95
Darkman	11.95
E.S.W.A.T.	11.95
F-16 Combat Pilot	14.95
Gazza 2	10.95
Grandstand	14.95
Hydra	13.95
James Bond Collection	14.95
Jehangir Khan's Squash	10.95
Lone Wolf	10.95
Lotus Esprit Turbo Challenge	10.95
Mercs	12.95
N.A.R.C.	11.95
Nightshift	12.95
North & South	12.95
Predator 2	11.95
Prince of Persia	10.95
RBI 2 Baseball	13.95
Sim City	12.95
Sim City (6128 & Plus)	12.95
System 3	14.95
Virtual Worlds	14.95

EDUCATIONAL DISKS

SEND SAE FOR THE M.J.C. SUPPLIES "EDUCATIONAL SUPPLEMENT" FOR MORE INFORMATION ON ALL EDUCATIONAL PROGRAMS

Learn to Read with Prof

Part 1: Prof Plays A New Game (4-9)14.95
Part 2: Prof Looks at Words (4-9)14.95
LCL Primary Maths (3-12) ...19.95
LCL Micro Maths (11-GCSE)19.95
LCL Micro English (8-GCSE)19.95
LCL Mega Maths (A-Level)19.95

KEYS TO PLEASE

Young children don't understand CAPITAL LETTERS, but that's all your computer keyboard shows. **Keys to Please** is a complete set of laminated keyboard stickers showing lower case and UPPER CASE. £1 off if total order value exceeds £10.
Keys to Please £3.95

French Mistress 12 to adult15.95
German Master 12 to adult15.95
Spanish Tutor 12 to adult15.95
Italian Tutor 12 to adult15.95
Answerback Junior Quiz10.95
Factfiles (require Answerback Quiz)
Arithmetic (6 to 11 years)7.95
Spelling (6 to 11 years)7.95
Sports (12 to adult)7.95

Fun School 1 10 programs per disk

For 2 to 5 years6.95
For 5 to 7 years6.95
For 8 to 12 years6.95
Fun School 2 8 programs per disk
For 2 to 6 years8.95
For 6 to 8 years8.95
For 8 to 12 years8.95
Fun School 3 6 programs per disk
For 2 to 5 years11.95
For 5 to 7 years11.95
For 7 to 12 years11.95

COURIER DELIVERY

Available on all orders. Prices start from £3. Please ask for details when ordering.

ACCESSORIES

Programming the Z80 book23.95
DKT 64K Memory Expansion45.95
Multiface 2 Plus (for CPC's)39.95
Multiface 2 Plus (for Plus models)42.95
CPC to Parallel Printer Lead9.95
Plus to Parallel Print Lead6.95
464 Keyboard-Monitor Ext Lead6.95
6128 Keyboard-Monitor Ext Lead7.95
FD1 Disk Drive Lead (664/6128)7.95
Monitor & Keyboard Dust Covers7.95
(state colour or mono & whether 464/6128/plus)
Quickshot 2 Turbo Joystick9.95
Competition Pro 5000 Joystick13.95
Topstar19.95
Programming the Z80£23.95
100 Programs for the CPC (type in)£9.95

CPM BASED

Protex CPM39.95
At Last Plus24.95
SuperCalc 242.95
Amor C Compiler36.95
Hisoft C Compiler36.95
Maxam 236.95
Nevada Devpac 80 version 236.95
Nevada Fortran Compiler36.95
Nevada Cobol Compiler36.95
Hisoft Pascal 8036.95
lankey Crash Course18.95
lankey Two Finger Typing18.95

PRINTERS

All prices include cable, ribbon, VAT, postage & packing. Courier service available, add £5.
FEEL FREE TO CALL FOR ADVICE

9 PIN PRINTERS

CITIZEN 120-D PLUS

A cheap Epson FX compatible, with a range of text styles and sizes in draft mode, limited in Near Letter Quality.
£139.95

STAR LC-20

Star's new replacement for the popular LC-10 is sure to be a winner
£169.95

PANASONIC KXP-1170

Replacement for the very popular KXP-1180. Still Offers 4 NLQ fonts, and fast printing. Very good quality text for a 9 pin printer.
£159.95

STAR LC-200

The latest colour printer from Star. Not only very fast but offers new paper handling features. Best value for money. NB: Printing colour graphics requires extra software. Please call before ordering.
£219.95

24 PIN PRINTERS

When printing graphics from 24 pin printers results will be distorted without some extra software. Please call before ordering.

STAR LC24-10

Excellent value budget 24-pin printer, offering 5 letter quality fonts, and additional effects such as quad size, outline and shadow.
£209.95

PANASONIC KXP-1123

Panasonic's entry level 24-pin, giving a better print quality than the Star models, but with 4 LQ fonts and fewer effects
£219.95

STAR LC24-200

The replacement for the popular LC24-10, with the same 5 letter quality fonts, shadow and outline effects. Much quicker than the 24-10 and has improved paper handling.
£259.95

PANASONIC KXP-1124i

Replacement for the excellent 1124, offering excellent text quality, build quality, paper handling and control panel. Now offers shadow & outline effects, 7 LQ fonts and a new super LQ font.
£279.95

COLOURDUMP 2

This program prints Advanced Art Studio files in up to 16 colours on the Star LC-200 Colour printer or compatible
COLOURDUMP 2 £12.95

CASSETTE SOFTWARE

Fun School 1 (2-5)	4.95
Fun School 1 (5-7)	4.95
Fun School 1 (8-12)	4.95
Fun School 2 (2-6)	7.95
Fun School 2 (6-8)	7.95
Fun School 2 (over 8)	7.95
Fun School 3 (2-5)	9.95
Fun School 3 (5-7)	9.95
Fun School 3 (over 7)	9.95

Mini Office 29.95

Maxam 464	15.95
Protex 464	15.95
Tasword 464	15.95
French Mistress	12.95
German Master	12.95
Spanish Tutor	12.95
Answerback Junior Quiz	7.95

AMSTRAD ACTION

SERIOUS

- 10 **AMSCENE** Amstrad stops making 3-inch disks... Is it the beginning of the end?
- 22 **MACHINE CODE TUTORIAL** Part IV of Andy Price's introduction to coding
- 24 **EQUINOXE** Ubi Soft's fascinating new music program for the CPC
- 54 **FORUM** Adam W comes back from his hols with no suntan and no money...
- 58 **DISK DRIVE BARGAIN PACK** Siren Software's 3.5-inch disk package
- 59 **SOUNDBLASTER** Stereo output from your CPC... and it's LOUD!
- 60 **GALLERY** A fine selection of readers' art - and there are prizes too!
- 68 **TYPE-INS** A Shabaz Yousaf special, including a mini hardware project...
- 70 **BUYER'S GUIDE** All the best CPC peripherals. Part II next month

ACTION TEST

- 27 **ALIEN STORM** Aaargh! The Earth's been invaded! (That's twice this week.)
- 28 **MANCHESTER UNITED EUROPE** Top of the charts, yes, but top of the league?
- 30 **SUPER SEGA** US Gold's coin-op compilation
- 38 **SMASH TV** Sale of the Century was never like this...
- 40 **TURTLES 2 - THE COIN-OP** The game Turtles 1 should have been!
- 42 **SUPER SIM PACK** Football, driving, tennis and, er, shooting...
- 50 **WORLD CUP RUGBY** Now's your chance to change history!

PLUS...

- 48 **BUDGET BONANZA!** The latest budget re-releases and new games

REGULARS

- 6 **COVERTAPE** Cisco Heat, two full games... and the brilliant RSX-LIB
- 14 **CHARTS** Never mind the figures, what do you readers think...?
- 16 **ON THE GRAPEVINE** Win a radio-controlled car in our Cisco Heat compo!
- 18 **REACTION** The 'Angry Letter' saga continues... take cover!
- 32 **CHEAT MODE** Beat those games, with Phil Howard's poking paradise
- 44 **BALROG** Adventuring news and views from the mystic master himself
- 53 **SPECIAL OFFERS** ...including a unique offer on Ubi Soft's Equinoxe program!
- 62 **SMALL ADS** AA's very own software/hardware mart
- 64 **SUBSCRIPTIONS** Guarantee your regular copy of AA AND save cash
- 67 **HELPLINE** At your wits end? Send in a postcard... and it's FREE!
- 72 **BUYERS GUIDE: GAMES** What are the best-ever shoot-em-ups on the CPC?
- 74 **AFTERTHOUGHT** At last! - what REALLY happened this month...

LINE UP

SMASH TV 38



Have you ever seen a game move this fast before? *Smash TV* will drive you potty...

Win a radio-controlled car!

See the special *CiscoHeat* compo on page 16



ACTIONpack 6



Cars, balls and Gaelic... *Cisco Heat* demo plus two complete games AND the excellent RSX-LIB from Smogware Systems...



TURTLES 2 40

Gameplay? What's that then? Who care? This one is just soooo playable you won't want to stop

BUYERS GUIDE 70

All the top CPC peripherals (part 2 next ish), PLUS the best-ever shoot-em-ups on the Amstrad

DISK DRIVE 58



Everything you need to add a 3.5-inch disk drive to your CPC, from Siren Software - including extended DOS, rombox and utilities

Future Publishing Limited Beauford Court, 30 Monmouth Street, Bath, Avon BA1 2BW

Tel: 0225 442244 • Fax: 0225 446019 • Editor Rod Lawton • Consultant Technical Editor Adam Waring • Staff Writer Adam Peters • Contributors Andy Price, Stuart Whyte, Phil Howard • Art Editor Paul Morgan • Additional design Maryanne Booth • Custard Coalpitheath Industrial Supplies • Advertisement Manager Cheryl Beesley • Publisher Jane Richardson •

© Future Publishing Ltd 1991 Amstrad Action is an independent publication. The company producing it - Future Publishing Ltd - has no connection with Amstrad plc. We cannot guarantee to return material submitted to us, nor can we enter into personal correspondence. We take great care to ensure that what we publish is accurate, but cannot be liable for any mistakes or misprints. No part of this publication may be reproduced in any form without our explicit written permission.

Promotions Manager Michele Harris • Publishing Assistant Tamara Ward • Group Publishing Director Greg Ingham • Production Melissa Parkinson • Subscriptions Christine Stacey, tel: 0456 74011 • Mail Order Claire Bates, tel: 0456 74011 • Circulation Director Sue Hartley, tel: 0225 442244 • Circulation Assistant Annie Gronow

'YOUR GUARANTEE OF VALUE'

This magazine comes from Future Publishing, a company founded just six years ago, but which now sells more computer magazines than any other publisher in Britain. We offer:

Better advice. Our files are packed with tips, suggestions and explanatory features, written by the best in the business.

Stronger reviews. We have a cast-iron policy of editorial independence, and our reviews give clear buying recommendations.

Clearer design. You need solid information fast. So our designers highlight key elements by

using charts, diagrams, summary boxes, annotated photographs etc.

Greater relevance. At Future, editors operate under two golden rules:
• Understand your readers' needs.
• Satisfy them.

More reader interaction. We draw strongly on readers' contributions, resulting in the liveliest letters pages and the best reader tips. Buying one of our magazines is like joining a nationwide user group.

Better value for money. More pages, better quality, magazines you can trust.



Home of Britain's finest computer magazines.

Amstrad Action • 8008 Plus • PC Plus • PC Answers • Amiga Forum • ST Forum • New Computer Express Your Single • Commodore Format • Sega Power • Amiga Power • Amiga Shopper • Classic CD • Mountain Biking UK • Newsletter



35,159

Member of the Audit Bureau of Circulations
January-June 1991

ACTION PACK

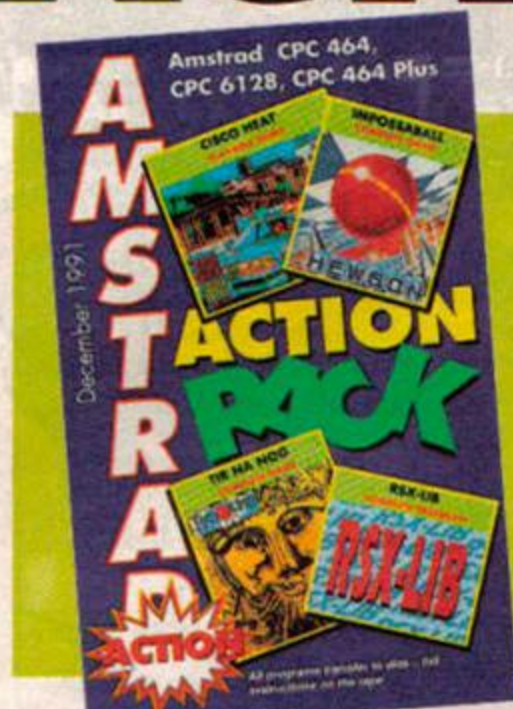

HOW TO LOAD THE COVERTAPE

Loading the programs couldn't be easier! Type RUN" (followed by RETURN) and press a key to start the tape. (A shortcut way to get RUN" is to hold down CONTROL and tap the small ENTER key.)

A menu screen will appear in a short time. Select the program you wish to load. Press SPACE to highlight the program you want followed by RETURN to load the program. The Cisco Heat

demo, Impossaball and Tir Na Nog are on side one of the tape. RSX-LIB is on side two. Turn the tape over and rewind to the beginning to load this program.

● If you have a disk drive connected to your machine you'll first have to type |TAPE to switch the machine to tape loading rather than disk loading. (The | is obtained by pressing SHIFT and @) The computer will load the next program.



● Cisco Heat is a car racing game. You're the car in red, and you've got to try not to crash.



● "And if you're going to San Francisco... make sure you pack a toothbrush and some sweets."



CISCO HEAT

San Francisco. It's a tough city, full of tough people. Even the sandwich sellers have it tough. Cops have it even tougher. Why are we giving you a guide to an American city? Because the covertape demo, Cisco Heat, is set in that very city.

It's a conversion of the racing coin-op of the same name. You play the role of a San Francisco sandwich seller (cop - ed), racing like a maniac round the 'Frisco streets. Normally you'd be delivering bagels to the local offices (chasing criminals - ed). Today, however, is the day of the annual race, where you compete against fellow bagel deliverers (police officers - ed) to see who's the fastest.

Not all of the sandwich lorries (police cars - ed) you'll encounter are in the race, some of them

are just there to get in your way and annoy you. What you get here is the first stage. The orangey rectangles that leap out at you are trams, and there's also a few yellow cars that pull out in front of you for no good reason.

Use your horn to get other vehicles out of the way (allegedly) and get to Fisherman's Wharf within the specified time limit, and you're laughing. And perhaps grinning smugly a bit too. Mine's a cheese and onion roll (conviction for gross stupidity - ed).

• Cisco Heat controls

Keyboard or joystick may be used

- QAccelerate
- ABrake
- OLeft
- PRight
- SPACEBeep horn
- RETURNChange gear



● "Right sunshine, out of the car. Been drinking then, have we, sir? Naughty, naughty."

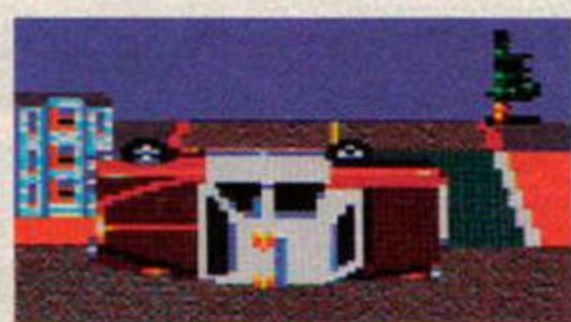

● Whoops. Er, this is quite a clever move this. It's, erm, a horizontal flip. Good, eh? (Ahem.)

IMPOSSABALL



Welcome to the most frustrating game in computing history. Adam P, who thinks patience is what you call a crowd of people in a doctor's surgery, has broken three of our best joysticks playing it. Barely an hour goes by without a scream of "I didn't mean to do that!" and a crashing noise as the Konix hits the wall.



● On the right are the barrels you've got to bump. On the left, the spikes you must avoid.

He's been plugging away for two weeks now, and has vowed not to do any work until he's got past Level One.

In Impossaball you have to bump these barrels with your ball. You can move about in all directions, and the longer you hold down Fire, the higher you bounce. If you hit any of the spiky things, the ball bursts and you return to the start. You've got four balls (and don't let



● There's a world outside your window. And a dead tricky ball game on your CPC screen.

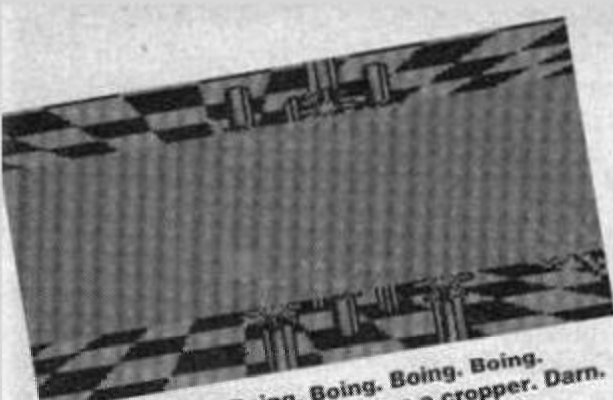

● Boing. Boing. Boing. Boing. Boing. Boing. Boing. Pop. Another ball comes a cropper. Damn.

your doctor tell you any different).

We think we know you well enough by now to tell you things we don't normally tell people. *Impossaball* is a brilliant yet infuriating game. It's difficult. More difficult, in fact, than fitting an adult giraffe into a standard sized handbag. We're going for a cold shower to recover.

• **Impossaball controls**

Keyboard or joystick may be used

- P.....Up
- L.....Down
- Q.....Left
- W.....Right
- X.....Fire
- RETURN.....Pause

TIR NA NOG

You know where you are with titles like *Street Fighter*, *Space Battle* and *Monster Kicking Ninja Warrior*. But *Tir Na Nog*? What the Dickens, Wordsworth and Shakespeare does that mean?

Off we popped, down the library, to check out the English-Gaelic dictionary. Well, *tir* means 'land' and *na* means 'of', but as for *nog*, we could find no trace. Then



● Here's a game with a difference. It's called *Tir Na Nog* (unlike any other game we know).

We hope that your covertape will load first time. However, having worked with computers for as long as we have, we know that things don't always go like clockwork. If you have problems loading the tape, try the following:

- Try loading at several different volume levels if you're using an external tape recorder. Computers can be very fussy about the volume they will load at.
- Clean the tape heads. This can be done with any commercially available cleaning kit. Alternatively, use a cotton bud soaked in alcohol. Gently rub the surface of the heads and pinch roller to remove that layer of accumulated grime.
- Adjust the cassette recorder's head alignment. The alignment screw is located just to the left of the tape head, and is usually

accessible through a small hole. Rotate it a fraction at a time with a jeweller's screwdriver. When the crispest sound is heard, the alignment is spot on.

- Sometimes the tape spools can jam or stick at a critical moment. Check the spools in your cassette rotate freely, if necessary giving the casing a slight tap against a table edge just to make sure. If, after trying the all of the above, you still can't get the tape to load then you can return it for a replacement. Send the tape, along with an SAE to:

**AA75 Covertape Returns,
Ablex Audio Video Ltd,
Harcourt, Halesford 14,
Telford, Shropshire TF7 4QD.**

someone tells us the title isn't in Gaelic after all. It's in Sidhe, an ancient language that died out in the third century BC or thereabouts, before anyone had got round to doing a Sidhe-English dictionary. Oh great.

Apparently Gaelic developed from Sidhe, along with all the languages that then developed from Gaelic. So it's over to the Irish, Welsh, Icelandic and Old Scottish dictionaries, and we discover that *tir na nog* means either 'land of than', 'land of sufficiently', or 'land of a small wooden peg used in weaving'. Er...

Sean of our sister mag *Commodore Format* reckons it means 'land of the dead'. But then again, ten years ago he thought humans would have colonised Mars by now (true), so let's not base too much on what he thinks eh?

• **Tir Na Nog controls**

Keyboard only (like all good games)

- ADGJL;.....Rotate left
- SFHK:].....Rotate right
- ZCBM.\.....Walk left
- XVN,/.....Walk right
- QETUO@.....Pick up

- WRYIP|.....Drop
- SPACE.....Lunge

Whoops, sorry, forgot to tell you what you have to do. First of all, you'll need a pen and paper, as there's a lot of mapping to be done. (Cor, it's just like a real adventure nearly, eh Balrog fans?) You've got to find the bits of the seal of Calum. It's a big job, and there are several smaller quests to be tackled before you can take on the main one. Often, the results of your actions will depend on whether you've collected the right object or done the right thing early on...

During the course of your travels you meet various monsters. Are they friendly? Well, some can be persuaded to help you, but others you will have to fight... combat outcomes are governed by what you're carrying and what you're using as a weapon. You have to work out the rules for yourselves!

You and the monsters travel along pathways and through doorways. You have to be facing a doorway to walk through it (use the rotate stuff for all that). Some are locked (so find a key!), some instantly transport you to another location. And take note of every object you find. They might seem worthless, but they all do something!

DISK DRIVE OWNERS READ THIS!

If you have a disk drive, you'll no doubt find the prospect of loading everything from tape daunting. Thanks to our special tape to disk transfer program, you'll only ever have to load from the tape once - all programs are transferred easily to disk.

Insert a blank formatted disk into the drive and the covertape at the start of side one into your cassette player. Connect the REM socket if you have one (6128 owners) - it'll automatically stop the tape in the right places when accessing the disk drive. (Otherwise it could prove a bit fiddly.)

Load the menu program in the normal way and select the TRANSFER TO DISK option. Follow the on-screen instructions and press a

key when the computer asks you to. It's as simple as that!

Should you experience problems you'll be asked to rewind the tape and try again. Don't panic if this happens - follow the advice for tape loading troubles.

DISK OFFER

All the programs on the *Amstrad Action* covertape are easily transferable to disk. However, owners of the 6128 Plus are unable to connect a cassette recorder to their machines, and some of the rest of you may experience loading difficulties.

We've come to a special arrangement with

our duplicators. For a small charge to cover costs, they will supply a disk containing all the programs we're giving away on the tape. If you would like a copy on disk, simply send them your name and address along with a cheque/postal order for £2.00 made payable to Ablex Audio Video Ltd. Send your orders to:

AA75 disk offer, Ablex Audio Video Ltd.,
Harcourt, Halesford 14, Telford,
Shropshire TF7 4QD.

You may also order previous covertapes from issues 67 onwards - just make sure that your envelope is clearly marked with the issue number of the covertape you require.

RSX-LIB

An RSX is a Resident System eXtension. It allows you to give a name to a machine code routine so it can be accessed with a simple keyword.

The computer needs to know what the routines are called and whereabouts in memory they are stored. This is a tricky process, and usually needs knowledge of machine code.

RSX-LIB makes creating RSXs easy. It allows you to create a library of these routines, and lets you select the ones you require and join them together in a group. This block of code can be loaded from BASIC where the named commands can be executed with the '!' prefix.

Once you've transferred RSX-LIB to disk, load it with RUN "RSXLIB". You will be prompted to give the disk a working name before it can be used for the first time.

The menu screen will then appear. Type in the required option after the prompt followed by ENTER. The options are as follows:

1. Assemble RSXs

This allows you to create a bunch of RSXs for use in your own programs. You will be presented by a list of all the entries in the library file. Use the arrow keys to move around the list select the RSXs to be included by pressing the COPY key. Pressing COPY again de-selects it.

Once you've selected the RSXs you want press ENTER to assemble the RSXs. Alternatively, ESC will quit without doing anything more.

You will be asked for a filename for the RSX file. The file will now be created from the machine code routines on disk. Once it has finished you will be asked to insert the disk to save the completed file to. You will then be told the list of BASIC commands necessary to install the RSX file. You will need to include these in your BASIC loader program, or type them in directly into the machine.

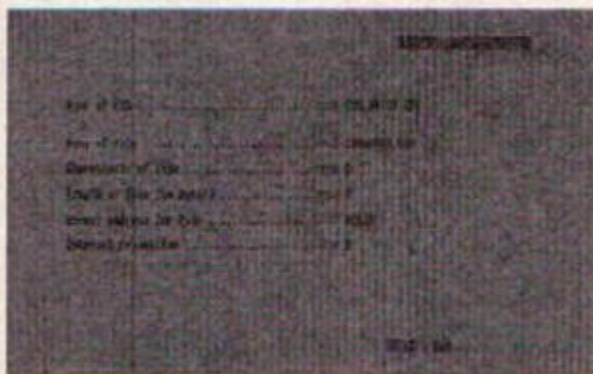

● The RSX-LIB information screen. This gives you all the gen about the RSX. It's used by a number of the options.

2. Disassemble RSX

This allows you to extract machine code files from existing RSX files. You will be asked for the name of the file you want to disassemble. RSX lib will attempt to locate the information table and will display the information on screen.

Fill in the information required – see box – and press ENTER to include the file in your library. Press ESC to omit it from the list. Repeat until all the RSXs have been processed.

3. Add RSX to library

This allows you to add new machine code programs to your RSX library. Fill in the information required – see box. Press ENTER to add the RSX to your library, press ESC to leave it out.

4. Delete RSXs from library

This allows you to delete RSXs from the library.

Disk only!
RSX-LIB will only work from disk, even though it is supplied on tape. Your first job is to transfer all the RSX-LIB files to disk. Then you need to use the supplied BASIC de-archiving program to split the RSX archive file into its constituent RSXs before you can use them.

You will be presented by a list of all the entries in the library file, use the arrow keys to move around the list select the RSXs to be deleted by pressing the COPY key. Pressing COPY again de-selects it.

Once you've selected the RSXs you want to get rid off press ENTER. The entries will be removed from the library file. Alternatively, ESC will quit without doing anything more.

5. View RSX Information

This allows you to view the RSX information held in the library file. You will be presented with a list of all the entries in the library file. Use the arrow keys to move around the list. Select the RSXs to be viewed by pressing the COPY key.

You will be presented with the information on the RSX, see box for details. You will not be able to make any changes.

6. Alter RSX Information

This allows you to alter the information for the RSXs. You will be presented with a list of all the entries in the library file. Use the arrow keys to move around the list. Select the RSXs to be viewed by pressing the COPY key.

You will be then be able to edit the information for the RSX. See box for details. When you have made your changes, press ENTER to return to the list.

7. View Library Information

This allows you to view information about the library. It will display the name of the disk where the library is held and the number of changes that you are allowed to make before the file is automatically saved.

8. Alter Library Information

This allows you to alter the library file's information. You can change the name of the disk it's saved to, and the number of changes allowed before it is automatically saved. Press ENTER to update the library file, or ESC to ignore any changes.

9. End Session

Quits, saving the library file to disk.



● You can build up libraries to contain just the routines you require.

Need a manual?
These are available directly from Smogware Systems, priced £9.95 (includes postage and packing). Orders should be addressed to: **RSX-LIB Manual Offer, Smogware Systems, 20 Grove Avenue, New Costessey, Norwich NR5 0HN.**

For your information...

The library file contains information about the RSXs. These are displayed – and can be altered by – a number of the options.

Name of RSX	Name of the RSX file. The command will be invoked by typing this name prefixed with a '!'.
Name of File	The name of the file containing the RSX machine code.
Whereabouts of File	Name of the disk where the file is stored.
Length of File	Length machine code file.
Normal Address of File	The address that the file is loaded at.
Internal relocation	The way internal relocation is carried out when assembling an RSX file.

Depending on the way the machine code program has been written, it may need to be relocated before it will work correctly. There are three different relocation methods:

- 0 No relocation.
- 1 Limited relocation. All instructions connected with absolute addressing will be modified.
- 2 Full relocation. Relocates all machine code instructions that refer to an address. Some of these instructions may refer to addresses used within the routine, but on the other hand might not.

● As a general rule, try option 0 first. If that fails, try option 1. Option 2 is the last resort; if this doesn't work then the only way to modify the routine is to use a disassembler and alter the routine manually.

PROTOTYPE – THE RETURN OF ARNOR!

Did you think Arnor had developed their last CPC product?

We must admit, it was starting to look that way. But now we are pleased to announce a stunning new arrival - *Prototype*. This provides *Protext* with the improved printing features that many of you have requested.

We honestly believe that it is not possible to achieve better quality output from a 9 pin printer than with *Prototype*. Just look at the examples below - all printed on an elderly Amstrad DMP 2000!

Prototype costs just £30 and is available on disc only. It works with *Protext* ROM and disc versions and may also be used as a stand alone program.

5 years after its original release *Protext* remains indisputably the leading CPC word processor. In the February 1991 issue, AMSTRAD ACTION said:

"Without doubt the most complete word processor available for the CPC ... Protext is very much a professional quality program."

AMSTRAD ACTION speed tests show *Protext* to be many times faster than other programs, for example:

Replace operation	Delete 17k block
Program A - 94 secs	Program A - 17 secs
Program B - 74 secs	Program B - 15 secs
Protext - 5 secs	Protext - 1 sec

Prices

Prototype	£30	(disc, Protext not required)
Protext + Prototype	£45	(disc)
Rombo ROM box	£20	(when at least one ROM is purchased)

ROM prices

Protext	£25	Promerge Plus	£20
Maxam	£25	Utopia	£20
Prospell	£20	Maxam 1½	£20
		BCPL	£20

Prototype is a typesetting print enhancer designed to squeeze maximum quality from low-cost 9 and 24-pin dot matrix printers. This paragraph shows how **Prototype** can work to a right-hand margin.

This actual-size printout was produced in one operation on a 9-pin printer using Arnor's **Protext** and **Prototype**.

Liquid^{293K}

	$c_p / J\ kg^{-1}\ K^{-1}$
① Acetic acid ($C_2H_4O_2$)	1.96×10^3
② Acetone (C_3H_6O)	2.21×10^3
③ Water _{sea} (H_2O , salts)	3.90×10^3

supports over 40 European languages including:

Anglo-Saxon	þ ð æ œ ā ē ī ō ū æ œ
Czech	á č ď é ě í ň ó ř š ť ú ů ý ž
Latvian	ā č ē ģ ī ķ ļ ņ š ū ž
Polish	ą ć ę ł ń ó ś ź ż
Turkish	â â ç ğ ı î ö ş ü

Prototype (disc only) works on:

- Amstrad CPC6128 (+)
 - CPC664 & 64K expansion
 - CPC464 & 64K expansion & disc drive
- Uses less than 350 bytes of the main 64K.

Fæder ure, þú þe eart on heofonum	(Old English)
Ár n-atheir, atá ar nèamh	(Irish Gaelic)
Fader vår som är i himmelen	(Swedish)
Svargayehi vāḍasiṭina apagē piyāṇeni	(Sinhalese)
Teve mūsų, kurs es danguje	(Lithuanian)
Pater noster, qui es in cælis	(Latin)

A Ganga común, «*Pterocles alchata*», 38cm
♀ con tres bandas en el pecho †
♂ faja pectoral castaña ‡

B just some of the non-ASCII symbols:
« » „ “ ” ¡ ¢ £ ¤ ¥ ¦ § ¨ © ª « » ¼ ½ ¾ ¯ ° ± × ÷
← → † ‡ § ¨ © ª « » ¼ ½ ¾ ¯ ° ± × ÷
& Å æ Æ œ Œ † ‡ † ‡ † ‡ † ‡
←line graphics too→

PROTOTYPE IS VERSATILE:

- multiple diacritics (accents) with any letter (è ñ ÿ Å)
- tabulates proportional text / micro-justifies spaces
- 240 DPI × 216 DPI resolution on a 9-pin printer!
- works with all 9-pin or 24-pin Epson-compatible printers
- use from *Protext*, Basic or machine code
- includes the seven fonts used in this demonstration
- choice of character designs within a font (page or page)
- !1x9! 10 911 0 10 911011 101111
- superscript, sub script, underline, **b** box, **e** encircle
- kerning (spacing of 'difficult' character pairs (AV))

Releasing your micro's potential...

ARNOR

Amscene

SIREN SOFTWARE TO MAKE DISK DRIVE INTERFACE FOR 464

Welcome reprieve for 464 owners as supplies of official DDI-1 drive dwindle

Supplies of the Amstrad DDI-1 drive are slowly drying up. Amstrad stopped making the beast some time ago, and although large numbers were nevertheless stockpiled within the trade, they obviously wouldn't last for ever. The DDI-1 drive package includes the interface needed for a 464 to be able to use disks.

However, Siren Software is shortly to release its own version of the interface: "We will be supplying an identical system to the DDI-1. However, the actual drive interface will be to our design. We have managed to retain 100% compatibility with the DDI-1."

Excellent news for 464 owners, who were otherwise facing the prospect of never being able to upgrade their machines. However, the reprieve may only be temporary, since Siren's supply of the 40015 disk ROMs, essential to the manufacture of the interfaces, is limited: "When we run out of 40015 disk ROMs, we will be unable to supply the DDI-2 to 464 owners. It is a first come first served situation."



● 464 owners need the discontinued Amstrad DDI-1 disk interface to use an external drive. Siren Software now plans to make its own.

Siren's drive/interface pack will cost the same as the discontinued Amstrad unit - £159.99. It will be supplied with operating manual and CP/M 2.2. (Once stocks of CP/M 2.2 are exhausted, Siren will supply alternative disk copying/formatting software running under Amsdos.)

Siren Software can be contacted at: Wilton House, Bury Road, Radcliffe, Manchester M26 9UH (061 724 7572).

Pagemaker latest

When we reviewed Alan Scully's Pagemaker Deluxe DTP program (AA73) we neglected to point out it was 6128-only. Sorry about that, folks. However, look out for next ish when we put the 64K version, Pagemaker Plus on the covertape... yoweee!

Fair statistics

It seems that 73% of the visitors who attended the Midlands All Formats Computer Fair are regular games players, 53% use a PC regularly, 47% own and ST or Amiga, 66% own 'multiple machines' and...

Well, yes, you get the picture. The point is that there are still some Fair dates left this year, including December 1st at the City Hall, Candleriggs, Glasgow, December 14th at the Horticultural Hall, Westminster and December 15th at the University Sports Centre, Leeds. Don't expect mega new releases, just bargs galore.

Opening hours are 10am to 4pm, and don't be surprised if some bod with a clipboard accosts you on the way in...

New retail chain opens

If you live in Ruislip or Muswell Hill, you'll already know about a new computer store chain called Game Vision. No? Well check them out! The rest of us can look forward to branches of the store springing up all over the country.

The company behind the new retail chain is Cityvision, which is the parent company of the Ritz video chain (Europe's largest, apparently). The stores will be designed specifically to appeal to the youth market, and will include "unique" demonstration consoles.

Game Vision shops will cover a variety of formats, including consoles. We don't know yet how much coverage the Amstrad will get, but the shops will be stocking a variety of goodies like joysticks too, so they'll definitely be worth a visit. And you may also get the chance to sample gaming of the future, in the form of interactive virtual reality machines...

PUT YOUR FOOT DOWN!



● Spectravideo's new Mega Star is designed to give arcade looks and feel.

Spectravideo's always turning out weird and wonderful new game controllers, but this time it's excelled itself...

The Quickjoy Foot Pedal controller has three pedals, which can be configured to replace three of the five controls of a standard joystick - great for driving games! Most games let you set up the controls yourself, so why not use the foot-controller for accelerator and brake and the keyboard for steering? The third pedal could be for nitro boost, or whatever.



● Put the pedal to the metal with Spectravideo's new foot controller...

The price will be £24.99.

Also new is the Mega Star, another 'nude' joystick (the Top Star was the first). Apart from having a transparent case, the Mega Star boasts super-chunky styling and heavy-duty microswitches and a short 'n' stubby handle, just like an arcade controller... "when the 'stick is in use you can see its microswitches rippling like a muscle builder." Sure.

The Mega Star will cost £27.95. Look out for both controllers in a shop near you real soon.

SNIPPETS...

Get the bug!

Cheetah's been trumpeting its new joystick for weeks now, and at last we've got hold of a review sample. The 'stick has an "ergonomically designed body for supreme comfort", but its biggest feature is its unique 'bug-eyed' look - both Fire buttons are positioned on the front of the casing rather than the top.



● Cheetah's Bug might look weird, but there's nothing wrong with the way it handles...

A bit of a gimmick? Not a bit of it. The Bug is one of the best joysticks we've ever tried! The 'stick itself is wonderfully light, the Fire buttons are positive and the whole thing handles superbly. It should be in the shops as you read this, priced £14.95.

● Look out for a special Bug Compo in next month's *Grapevine*...

Mr. Mangetout at Shopper Show

Make a note in your Filofaxes - the Computer Shopper Show is taking place between the 5th and 8th November at the Wembley Exhibition Halls. There's going to be all the usual bargs and goodies on offer, but this year's event boasts a rather unusual personality.

Mr. Mangetout is a Frenchman with a peculiar appetite. He eats anything. And at the show he will be eating an entire PC over the five-day period. That's not all Mr. Mangetout has eaten. Since 1966 he's scoffed his way through bikes, chandeliers, televisions, super-market trolleys and even a Cessna light aircraft.

The worst of it is, he's supposed to be eating this PC "byte by byte"... we don't think even Mr. Mangetout could swallow that.

Picture this

Serious publisher SD Micro-Systems is to branch out into the art world with a new art program called *Picasso*. The program will feature 12 different fonts, handle fills, incorporate a clipboard, offer a variety of image manipulations... all this and it works on a 64K machine. Look out for a full review soon.

Foundation Software address

Chris Own of Foundation Software, publisher of the one and only step time sequencer for the CPC, has asked us to point out that his new address is: 27 Crofters End, Sawbridgeworth, Herts CM23 0DF (0279 725788 after 6pm).

Green printer ribbons?

A Hong Kong company has come up with an innovative solution to the problem of ribbon-wasting...

Instead of chucking out your old ribbon once it dries out, case and all, and instead of spraying your old ribbon with horrible sticky black inks, you could just wind in a whole new ribbon, using the special cartridges supplied.

At the moment, the manufacturer, Total Printstrument MFY Ltd, doesn't have a UK importer, but the company says it will welcome orders from individuals. The address is: Total Printstrument MFY Ltd, Suite 7, City Garden Shopping Centre, 1/F, 233 Electric Road, North Point, Hong Kong.



● Made in Hong Kong: the new 'green' printer ribbon that could help save the environment.

YOUR SYSTEM DESERVES DELTEK

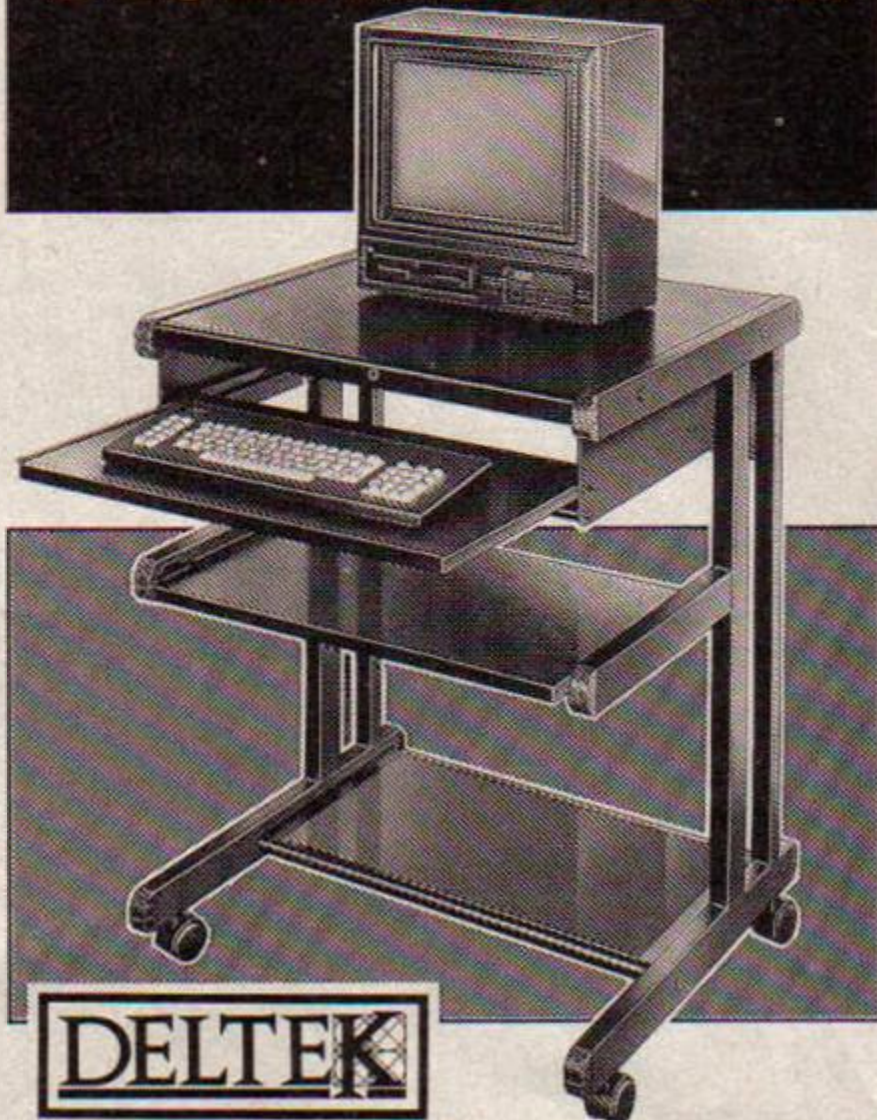

Deltek purpose-built quality home office systems at keenly competitive prices. There are 7 separate Deltek ranges in a choice of attractive finishes.

DATA COMPUTER WORK STATION

ONLY **£79.99**

OTHER UNITS AVAILABLE IN THE
DATA RANGES in black ash style
or mahogany style.

				
Desk ONLY	Pedestal Unit ONLY	3 Drawer Filing Cabinet ONLY	Cupboard Unit ONLY	Typist Return ONLY
£89.99	£59.99	£79.99	£89.99	£49.99

**UP TO £2000
INSTANT CREDIT**
With Homeplan
Account Card.
Subject to status.
APR 32.9% variable.
Written quotations
available on
request. MFI are
licensed Credit
Brokers.

MFI

SHOPPING HOURS
MON 10-8
TUES-WED 10-6
THURS-FRI 10-8
SAT 9-6
Scottish stores
open Sunday 10-5.
(Northern Ireland
exceptions
Mon 10-6, Wed,
Thurs, Fri 10-9.

Prices are for self-assembly units and do not include ornaments, accessories etc.
Some items may not be available in smaller stores.

PHONE 081-200 0200 FOR YOUR NEAREST STORE



MOVIE

Premiere

NOW SHOWING!!

**TEENAGE MUTANT
HERO
TURTLES**

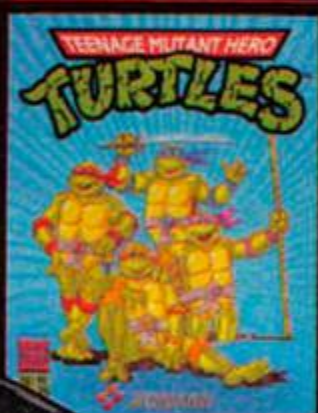

For years the magic of Hollywood has been the focus for the focus of people the world over. Nothing else quite matches the ability of screen to transport us beyond the barriers of reality. Through the medium of your computer, Movie Premiere offers you the chance to be in this magic . . .

Four of Hollywood's hottest films are now showing on a screen you can't miss.

BE FIRST IN THE QUEUE TO ENSURE YOU GET THE BEST SEAT



BACK TO THE FUTURE Part II™

© 1990 Miramax Limited
© 1989 UCS and Amblin

DAYS OF THUNDER™

TM and © 1990 Paramount Pictures. All rights reserved.
© 1990 Mindscape

TEENAGE MUTANT HERO TURTLES™

© 1991 Mirage Studios, USA
Published under licence from Miramax Ltd. Under sub-licence from Konami and under sub-licence from Mirage Studios, USA.
Konami is a registered trade mark of Konami Industry Co. Ltd.
© 1989 Konami
© 1990 Miramax Ltd.

GREMLINS 2™

© 1990 Warner Bros Inc. All rights reserved.



FORMATS

Commodore Amiga,
Atari ST,
IBM/PC 3 1/2",
IBM/PC 5 1/4",
Commodore 64 disc,
Commodore 64
cassette,
Spectrum cassette,
Amstrad cassette,
Amstrad disc.

elite

Elite Systems Limited,
Anchor House, Anchor Road,
Aldridge, Walsall, West Midlands
WS9 8PW, England.

fantasies of millions
lity of the silver
he interactive
nce to take part
ry near you(!) . . .

OUR COPY.

**4 GAME
COMPILATION**

elite

CHARTS

FULL-PRICE

1	Terminator 2 Ocean	AA74 89%	RAVE!
2	Final Fight US Gold	AA74 93%	MASTER
3	Manchester United Europe Krisalis	AA75 74%	
4	Rainbow Collection Ocean	Not reviewed	
5	Hero Quest Gremlin Graphics	AA71 91%	MASTER
6	Dizzy Collection Codemasters	Not Reviewed	
7	Big Box Beau Jolly	Not reviewed	
8	Teenage Mutant Hero Turtles Mirrorsoft	AA65 76%	
9	Grandstand Domark	AA73 63%	
10	Vix Virgin	AA72 69%	

It's all change on the Charts page. We've kicked out the Gallup charts and got a new way of working out the Top Tens, which we think will be much more representative of what's going on. We're comparing all your charts with what's happening in the shops and compiling an exclusive AA guide to what's hot on the street. And we don't mean freshly laid tarmac.

THE BUDGETS

1	Batman the Movie Hit Squad	6	Power Drift Hit Squad
2	Turrican Kixx	7	Heroes of the Lance Kixx
3	Moonwalker Kixx	8	Quattro Skills Codemasters
4	New Zealand Story Hit Squad	9	Bubble Bobble Hit Squad
5	Quattro Coin-Ops Codemasters	10	Shinobi Mastertronic



● Here's a digitised picture. Pretty good, huh? But who is it a piccie of? Er, dunno. Hang on, yes we do. This is Nick Barnes from Telford, and that's his top five games of all time over there. Nick says he'd like lots of screaming female fans. Wouldn't we all mate, wouldn't we all. Your best bet is probably to go to America and become a world famous baseball player (you've already got the cap for it). Anyone else want a go? Send your top fives and piccies to *Readers' Charts*, Amstrad Action, 30 Monmouth Street, Bath, Avon BA1 2BW.

READERS' CHARTS

- 1 **TURRICAN** Rainbow Arts
- 2 **RAINBOW ISLANDS** Ocean
- 3 **RICK DANGEROUS** Firebird
- 4 **MAGIC LAND DIZZY** Codemasters
- 5 **TEENAGE MUTANT HERO TURTLES** Mirrorsoft

TEENAGE MUTANT HERO

TURTLES

TM

THE COIN-OP!



THE RETURN OF THE AWESOME FOURSOME!

Now two dudes or dudettes can join forces and double team Shredder™ and his Turtle terminators in a bid to save April™ and Splinter™. Take control of your favourite Turtle in this turtley awesome version of the Konami coin op.



 KONAMI®

Image Works, Irwin House, 118 Southwark Street, London SE1 0SW. Tel: 071-928 1454, Fax: 071-583 3494

Teenage Mutant Hero Turtles™ is a registered trademark of Mirage Studios, USA. Splinter™, Shredder™, April O'Neil™, Bebop™, Rocksteady™ are trademarks of Mirage Studios USA. Based on characters and comic books created by Kevin Eastman and Peter Laird. © 1990 Mirage Studios. All rights reserved. Used with permission. Published by Mirrosoft Ltd under license from Konami® and under sub license from Mirage Studios, USA. Konami is a registered trademark of Konami Co., Ltd. © 1991 Konami Inc. © 1991 Mirrosoft Ltd. Image Works is a brand name of Mirrosoft Ltd.

ON THE GR

OFF ON THE CRUSADES



● *Space Crusade* offers both 2D and 3D views of the action as you tackle the alien-infested starships.

● Play twelve separate missions not included in the board game, using a *Hero Quest* style playing system.

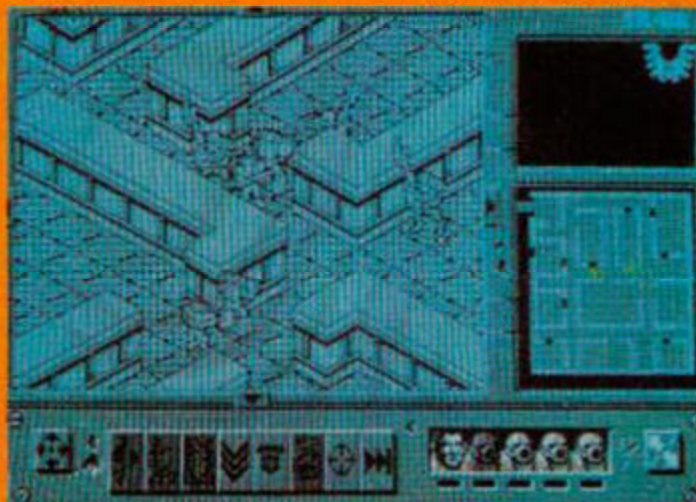

Magic? Pah! – kids' stuff! If *Hero Quest* made you gag, despite its excellent role-playing basis, you want *Space Crusade*, the sequel. This time you're battling terrifying aliens in infested derelict starships, previously lost for thousands of years.

Like *Hero Quest*, Gremlin's *Space Crusade* is a computer conversion of a top-selling role-playing boardgame. This time you get twelve different missions, none of them found in the boardgame, including the retrieval of experimental weapons and setting up the ships' self-destruct mechanisms.

Hero Quest scored an AA Mastergame, and *Space Crusade* looks like *Hero Quest* with knobs on. We can't wait!

Space Crusade will be out for Christmas, price £10.99 cassette, £15.99 disk



WHERE ARE THE SIMPSONS?

You've seen the ads, you've read the previews – so where's the game? Those hods on Your Sinclair have already seen and reviewed it, yet of the Amstrad version there is no sign. "Oh, we haven't seen the Amstrad version yet," quoth an Ocean spokesperson mysteriously. OK, all together now... "We want the Simpsons, we want the Simpsons, we want the Simpsons..."

The Simpsons should (!) be out for Christmas, price £10.99 cassette, £15.99 disk...

WHO NEEDS A HERO?

Well we do, apparently. According to *Domark*, we gobbled up last summer's *Heroes* compilation in such numbers that we're gasping for more of the same...

- So look out for *Superheroes* this Yuletide. The pack contains the following:
- *The Spy Who Loved Me*
 - *Last Ninja 2*
 - *Indiana Jones and the Last Crusade*
 - *Strider II*

Superheroes will be out in November, price £14.99 cassette, £19.99 disk



● Rod, amassing a huge score on the *Cisco Heat* cabinet brought in specially for the compo. Well, a medium score then (tiny).

Mirrorsoft is building up to a busy Christmas this year. First we had *Robozone*, then we had *Turtles 2* – the *Coin-Op* and next off the production line is a conversion of the Jaleco coin-op *Cisco Heat*!

Apparently, each year the streets of San Francisco (now where have I heard that before?) are cordoned off for the annual policeman's race. The SFPD are (it says here) "the meanest drivers around, as police chases through the city are a daily occurrence. Fine. Not the sort of place to go jaywalking, then.

What all this is really getting down to is another racing game, this time set against an authentic city backdrop. You're racing against strict time limits for successive stages. Each prang, needless to say, slows you down, and the time limits get tighter and tighter.

Mirrorsoft reckons there's some heavy-duty 3D graphics, realistic handling and

RAPEEVINE...

CHEVY CHASE



• Chevy Chase even looks good on the Speccy! Roll on the CPC version...

like a wobbling great pudding like you might expect - not with grippy tyres, fuel injection and nitro boost...

Chevy Chase will be out mid-November, price £3.99 cassette

Cor! - a game about the famous American comedian (oh, is that what he is)? Nope, it's actually a racing game involving Chevrolets (thank Gawd for that). The Chevrolet concerned is a 1959 Belair, but it doesn't flop around

CODIES CARTOON COLLECTION

Codemasters is at it again with another compilation for Christmas. We can't quite see it being the hit that *Dizzy's Excellent Adventures* will be, but it's still a tidy little package. It includes:

- Seymour goes to Hollywood
- Little Puff
- Dizzy (the original)
- Slightly Magic
- Spike in Transylvania

Cartoon Collection won't be coming in at the Quattro pack prices, but it's still looking pretty good value.

Cartoon Collection will be out in early December, price £9.99 cassette



• Seymour Goes to Hollywood scored 92% last ish - and it'll soon be in Cartoon Collection.

THE HEAT IS ON!



• Cisco Heat will be out on the Amstrad soon, but there's a stonky demo on this month's covertape for those who can't wait...

ultra-fabby scenery-smacking action - but hey, what are we telling you this for? We've put a demo on the covertape, so get stuck in and see for yourselves!

Cisco Heat will be out in early December, price £11.99 cassette, £15.99 disk

THE COMPETITION

We're all such super-cool hero-type hard dudes at Future Publishing that Mirrorsoft brought down a Cisco Heat arcade machine and ran a little compo after work to see just who was the meanest games player around. And guess who won it?

No, er, it wasn't Rod, actually. In fact it was some goerer called Stuart Campbell from some mag called *Amiga Power*. Stuart just happens to be video games champion of the UK 1988, or something like that. Anyway, it's all luck, isn't it?

The idea was that all the eds taking part were trying to win prizes to give away to their readers. And that's just what Rod did...



THE PRIZE

One lucky reader (thanks to the ed's remarkable games playing ability) is going to win an Atcomi Super Buggy radio-controlled rally car!

All you have to do is answer three rather easy questions:

1. In *The Streets of San Francisco*, who co-starred with Karl Malden?
 - a) Kirk Douglas
 - b) Michael Malden
 - c) Michael Douglas
2. Which of the following is not an American name for a tram?
 - a) Trolley
 - b) Street-car
 - c) Dirigible
3. What famous bridge can you see in San Francisco?
 - a) The Golden Gate bridge
 - b) The Brooklyn bridge
 - c) The Hamber bridge



Answers on a postcard, please, to:

Cisco Heat Compo, AA,
29 Monmouth Street, Bath,
Avon BA1 2DL

The closing date is the 8th December (so we've got a chance of getting the prize out to the winner for Xmas) - so get cracking!



Reaction

Amstrad Action's letters are edited by Adam Peters, whose pen is mightier than any sword...

And before you put pen to paper, make sure you've read the following:

- Got technical problems? You should be writing to *Forum*, not *Reaction*.
- Stuck on the basics and need help? That's what *Ask Alex* is for.
- Keep your letters short, and try to make just one point rather than loads
- Looking for a particular cheat or poke? You need *Cheat Mode!*
- Don't enclose SAEs or ask for individual replies – there's no way we have the time for that.

What should you write about? Anything remotely connected with Amstrad computing! We give away £25 mail order vouchers for the best letters and badges for the angriest...

WRITE TO:

Reaction, Amstrad Action,
Beauford Court, 30
Monmouth Street, Bath,
Avon BA1 2BW

Best letter ever

I'm writing to congratulate you on creating the best computer magazine on the newsagents' shelf (*blimey!*). Your team have the uncanny knack of being able to balance the serious and games side of computing perfectly. My favourite column has to be the Balrog's, although I also enjoy *Type-ins*, *Cheat Mode* and *Action Test*.

Type-ins are great now that they have an extended length (not that they weren't great beforehand!). *Cheat Mode* is greatly welcomed because the cheats always appear at exactly the same time as the games, and *Action Test* reviewers convey a game perfectly.

The *Action Packs* steal the limelight though – the best game was *Heavy on the Magick* (more adventures please!) – and the serious reviews, other columns and technical series are great also.

I have been buying AA since issue 35 (October 1987) and I have never missed an issue. The magazine was brilliant then, and I've seen never seen anything but improvements. Long live *Amstrad Action* and thanks to all the crew.

Thomas Christie
Grangemouth
Scotland

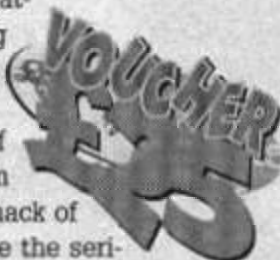

Adam: Now why can't more of you write letters like this? Sure, we get a few that begin off like this, but they invariably suddenly launch into "I have a favour to ask – please could you send me all your computers" or "but I think the latest issue is crap – you should all be shot".

Thomas' letter does neither of these. It's just pure unadulterated praise. Obviously the lad's a bit mad, but this is the sort of thing that needs to be encouraged. So we're sending Tommy a £25 voucher, a couple of budget games and a signed copy of this ish. And if you want the same, well, you know what to do. Write to *I Think AA Is Fab* at the usual address.

Oh, man (ho ho)

When I return a tape because it doesn't work, having cleaned the tape heads and made sure the computer is not at fault, I put a label on the faulty tape with a note of the error ('read error b' etc). My software dealer does not object to this. Perhaps Robert Kershaw should do this to stop his shop putting faulty tapes back on the shelf.

If someone can help with *Castle Master*, would they like a pen-friend that works in Oman? Jim says he can only find four keys (*who's Jim?*), but he would like an Amstrad penpal (*oh, I get it now, Jim's the person in Oman*). I will provide the first 39p stamp if they phone me on 0344 428053.

More Kim please!



● Darryl Catchpole thinks we should fill AA with pervy Kim Basinger stuff. We think Darryl should go and lie in a dark room.

I think that Adam Peters is a silly name. I further object to your persistent spelling mistakes. Darryl is spelt with two Rs in the middle. Darsrsyl, you see? (No.) I think Top Ten (or Top Five or whatever) lists are boring if just left to games. Who cares if Joe Bloggs like Gizard Puke beat-em-up 12. Top Ten Kim Basinger Fantasy lists would be far more interesting, eg (1) Kim Basinger and a can of Anchor Cream, (2) Kim Basinger and twin sister stuck in a lift, (3) Kim Basinger and the goat. I don't think I ought to go into detail, just in case her lawyers are reading this.

Darryl Catchpole
Scunthorpe

Adam: Firstly, *persistent* is spelt with an 'e' and *Kim Basinger* with one 's'. Secondly, that's not a Top Ten or a Top Five, it's a Top Three. Thirdly, er, the capital of Paraguay is *Asuncion*. And finally, if any other readers have any strange obsessions they'd like to share, you know who to write to. (Marjorie Proops at the *Daily Mirror*.)

Is Ocean filthy?

I would like to complain about Ocean's attitude to the people who put a roof over their heads

Does Amstrad Action reach Poland, Hungary or any other former Soviet block country? Do they have any Amstrad CPCs out there? Is there any way Amstrad owners can help them learn about computers? I would like to help them (if they speak English, as I only speak English and rusty French), but I don't seem able to reach the right people.

Angela Allum
Bracknell, Berks

Adam: But if a software shop's staff would rather not go to hassle of sending tapes back (as would seem to be the case in Whitchurch), and are in the habit of sticking them back on the shelves, what's to stop them removing the stickers? Good tip though.

AA in Eastern Europe? We send hundreds of copies out there, but unfortunately no-one can read it because it's in English. They think that it's a fishing magazine. Mind you, it's proving quite popular.

Moan, moan, moan...

It's now the 25th of September and tomorrow, Amstrad Action will be a full week late. Your Circulation Director told me that there had been 'a problem at the printers' when I called yesterday. For a whole week?

Funny that Commodore Format, a brand new mag from the same publisher gets on the queue for printing first. Come on Rod, assert yourself and look after your readers. A new mag shouldn't bump us like this.

On a different matter, would it be possible to verify contributions for Type-ins on the Plus machine as well? I'm a fairly new owner of a 6128+ and many machine-code type proggies don't work on this machine. I have spent many a frustrating hour typing in certain programs,

only to draw the conclusion that some poke or call to memory is suspect. I still can't figure out why Amstrad introduced incompatibilities between the old CPC and Plus machines. Any clue?

Thanks for a great mag (when you can get it on time, that is).

Stephen Jeavons
Camberley
Surrey

Adam: Sorry about not printing your letter in last month's issue Stephen, but it arrived too late (ho ho).

Seriously though, mega apologies about the late running of AA73. This was down to problems with the cover tape that were genuinely out of our control. As far as Commodore Format is concerned, we have a punch-up in the car park on the last Friday of every month to decide positions in the print queue. Unfortunately we've got Maryanne, so we usually lose. (That's not all you're going to lose, sunshine - Maryanne)

As for the Type-ins, we haven't had any problems on our office Plus machines (all progs are fully checked on all machines). Have you used Type-righter to check you've keyed



● Caralumba! It's fisticuffs time. Rod 'Crusher' Lawton decides to show Lam 'Get this loony off me' Tang another use for a joystick lead.

them in properly?

The CPC-Plus compatibility problems only affect a very small number of machine code programs. Basically, the Plus machines work off a 10 nano-second keyboard pulse, and programs need to be written with this in mind. The original CPCs were also supposed to run off a 10ns pulse (this was part of the machine's specifications). However, for some reason programs worked perfectly well if the pulse wasn't exactly 10ns, so a few programs were written with slightly different jump-blocks. These worked OK on the CPC, but on the Plus they'll load only to 'freeze' when encountering the first wait for a key entry.

This incompatibility wasn't deliberately 'introduced' by Amstrad. They haven't changed the ROM in any way, it's just "one of those things" really. If you want to blame someone (and I'm sure you do), blame the programmers.

Question time

Please, please, please, grovel, grovel etc, answer my questions. (Oh all right then, you snivelling little wretch.)

1. Will Ocean's Battle Command be released for the CPC/Plus?
2. Sometimes when I play Burnin' Rubber and hit a car the game crashes or makes me qualify again. What is at fault, the computer or the cartridge?
3. I recently bought Hit Squad's Driller. It worked for about a week, then none of the sides would load. The shop won't take it back. What can I do? Should I send it back to Hit Squad?
4. When will the Trojan lightgun be released and how much will it cost?

James Gunn
Arbroath
Scotland

BYTE SIZE

and bread on their tables, i.e. the great games buying public. I recently purchased Dragon Ninja on tape, which took ages to load. I don't like waiting so I transferred it to disk, using my Multiface 2. It didn't work. The screen went all fuzzy, and to my amazement the words "**** OFF YOU *****" appeared at the bottom of the screen (without the asterixes). Okay, I don't mind software houses protecting their games, but is it really necessary to be so abusive? Anyway, if I've paid for a game I think I deserve the right to make a back-up. I would like to see Ocean's response. I have over 50 of their games and do not deserve such offensiveness.

Alec Hay
Chelmsford

Adam: We rang Ocean up for an explanation, but they told us to "go **** up a tree". No, they didn't really say that (just kidding Ocean, ho ho and all that). They didn't know

anything about it. We went out and bought a copy, and that Multifaced perfectly without being rude to us. Maybe you're imagining it? Have any other readers had abuse hurled at them by their software? Write and tell us. By the way Alec, what did you think of Chelmsford 123? We stand by our original criticisms.

Charting a decline

I'm so fed up with the charts only showing the top ten games that I had to write and complain. My brother (Richard) also would like to know why you do not show the top 20 games in the charts.

Nicki Barratt
Rochdale

Adam: We're doing it deliberately just to spite you and your bruv. But there's another

reason too. Basically Gallup, the chart people, send us a Top 100 games list and we have to separate out the budgets and full-pricers. The Amstrad full-price market has fallen compared to budgets (around 85% of all games sold now are budgies). Consequently there are only twelve or thirteen full-pricers in the list we get. So we can't do a Top Twenty. Sorry.

A complaint

I read with the greatest horror your comments on Channel 4's Chelmsford 123 in your 73rd issue's Reaction. I think you are completely wrong and unutterably stupid, besides not knowing humour if you were to find it in your porridge. I am writing to Channel 4 straight away, telling them to ignore your letter, as you are clearly mad.

Matthew Watson
London

ANGRY LETTER OF THE MONTH

Michael Davies: A Response

I would just like to ask one simple question: Who the HELL does Michael Davies (*Reaction*, AA73) think he is? First of all, he slags off Jane Marie in saying that if it wasn't for us male "sh*ts", she wouldn't have an AA to send her so-called "garbage" to. Isn't this stating that AA is a male-only mag? I think not. If he'd care to look at the contents page he would see the names Alex van Damm, Maryanne Booth, Cheryl Beesley, Jane Richardson... the list goes on.

Michael then goes on to slag off Marcus Kasumba, saying he's poisoning his mind. To be frank, I think that it's Michael that is poisoning his mind, what with swearing every other syllable. This proves that his one adventure does not get as much attention as he so proudly and pompously says. What I'd like to know is why he has 104 other games and no more adventures? Surely he must enjoy going round ripping up old grannies with chainsaws in the latest *Codemasters Professional Granny Sim*, and setting fire to shops? I know quite a few people who enjoy



playing a game like *Predator 2* and still wouldn't break your neck when they saw the drivel that you wrote.

Another thing, does Michael not realise that if it wasn't for Mr Skilton's "toffee-nosed drivel" disks, modems and M/C, the CPC would have died a long time ago. Without modems, PD libraries would cease to exist, or at least not have as much software. Without disks, you wouldn't have fast PCs that you see today. Imagine loading a 128K file from tape, or a 1 Megabyte program from tape onto an Amiga! And if machine code didn't exist, how could you ever have any of your games? How many commercial programs are written in BASIC?

You're the kind of person I'd like to hang up by the b***s on a piece of cheese wire and drop over the grand canyon with your 104 games strapped to your head.

Graeme Chesser
Scotland

Adam: Ooer, this angry letter spot's certainly starting to hot up isn't it? We thought 'Mad' Mike Davies' letter in AA73 might provoke some sort of response.

Needless to say, we under-estimated and our postman is now in hospital with a hernia.

Graeme says in his P.S. that he'd like a reply from Michael to see what he thinks. Well so would we. Or indeed a reply from anyone else who wants to take Michael's side. We'll be putting a stop to this little shindig before it escalates into World War Three, so if you want to chuck in your tuppence worth, drop us a line today.

We usually send a badge to the angry letter winner, but in Graeme's case we're sending a £25 voucher. Partly because we know a lot of readers will share his views, and partly because we like a good scrap. But mainly because the only badges we've got left are a couple of Your Sinclair "I've Got Big Tips" badges that we nicked from their office when they weren't looking. And frankly, we're too embarrassed to send them to anyone (as they no doubt should be).

Anyway, dip your pen in the most expensive vitriol you can find, and get writing to I'm Flippin' Angry at the usual address. You'll regret it later, but by then it'll be too late.

Adam: 1. Yep. Take a look in your local software shop. If it's not there at the moment, it'll be there pretty soon.

2. Your driving, probably.

3. Let's ask Andrew Stewart of Bridgwater in Somerset. What do you reckon Andy? "You don't need proof of purchase to return faulty goods. Many shops have signs up saying you do, but they are breaking the law as it is illegal to display such a sign. The shop simply has to send the goods back to the manufacturers for a refund, so they do not lose out even if the game was not bought there. Having a receipt does avoid arguments though!"

"You do not have to accept another game in exchange. You can insist on having your money back, no matter what they say. Don't let the shops tell you otherwise, and then maybe they will stop cheating people." In other words, James, return to that shop and DEMAND they take the game back. Otherwise we'll send Rod up there to sing to them. (Shut yer neck, Adam - ed.)

4. Er, unfortunately Trojan has decided not to market the CPC version of the Phazer, even though it's been built and everything. If you own one of the original CPCs, you might still be able to find one of the old Trojan lightguns (the Magnum pack) if you look hard enough.

Seconds out...

I would like to defend myself against the obviously upset Michael Davies (has he got a chip on his shoulder or what?).

Firstly, he says "If your full address had been printed I might have come round and

given you a kick up the ****." It appears to me that he is the one who has had his mind poisoned with violence.

Secondly, he seems upset by my opinion of adventure games. Maybe I should have been more specific, but I thought the mention of 'hours of boring text' would show I was referring to traditional text-entry adventures. What's the big deal? It's only my opinion.

My friends, family and myself found his description of me very amusing, but I'm afraid

he won't be seeing me at the dole office. I did say in my letter that I'd be attacked by hordes of screaming adventure fans. Looks like Mr Davies is the first.

Marcus Kasumba
Sheffield

Adam: If you're out there Mad Mike, we're awaiting your reply. Maybe we could organise some sort of contest, perhaps a water pistol fight or something. **AA**

Scrap full-price games?

I consider myself a fair man, not given over to irrational notions or fits of radical opinion. However, I now believe that software houses should scrap full-price games and release all new games straight on to their budget labels.

Let us look at the facts: Budget games now account for the vast majority of games sold. Many people may buy only one or two full-pricers a year but a budget game every fortnight. Young kids, the growing sector of the GPC market, can't afford to pay ten to twenty pounds for games.

Scrapping full-pricers would also help put a stop to piracy. Pirate copies are floating around now because kids simply can't afford the ridiculous prices being

charged by software companies. They are blitzed with glossy ads and reviews for products they can't afford, or if they could it would cost them several months' pocket money.

Software houses would not lose out, in fact they'd do better. Piracy would be cut, and they would sell thousands more copies, especially with adverts and reviews being for games people can afford. Surely the time has come to put all new games, big licences and the lot, on the £3.99 shelves straight away. Is that so wrong or mad?

Peter Worley
Ilford

Adam: What do you reckon readers? Is Peter mad or what? Got any hare-brained ideas of your own?



SERIOUS GAMES

Imperial Conquest - £14.95

A war/strategy game for 1 to 5 players, based in the Mediterranean in 270 BC. Each leader controls tax levels, troop recruitment, the hiring of mercenaries, building of fleets, political relations, and commands their armies in the battlefield.

WW3 - £14.95

A large scale war game for 1 or 2 players, covering a global war in the near future between a Euro-Oriental fascist alliance, and a Sino-Soviet communist alliance. Map 280 by 140 squares, extending from Germany to Japan.

War in the West - £14.95

Similar in style and scale to WW3, this covers the 2nd World War in Europe, North Africa and the Middle East starting in late 1941.

Soccer Management Simulator - £14.95

Manage an English or Scottish club, over 3800 players.

All games from Serious Games work only on the CPC6128 and 6128+ because they use the extra 64K of RAM.

Prices include postage. (Overseas add £3.00).

Cheques/Postal Orders payable to **Serious Games**.

Dept AA12, Serious Games, PO Box 6, Seaham, County Durham, SR7 7EE

USE YOUR WITS TO
BEAT THE COMPUTER

QUICKFIRE!

win
a pocket
colour TV

The fastest &
most exciting trivia
game on your phone!

call now

0839 44 22 76

5p per 8 secs cheap rate 6 secs other times
Questel PO Box 3000 London N20 0NR

WIN
£100

and a CD

**NAUGHTY
TRIVIA QUIZ**

0839 03 03 64



**ROCK
TRIVIA QUIZ**
0839 03 03 62

FOOTBALL TRIVIA QUIZ
0839 03 03 63

5p per 8 secs cheap rate 6 secs other times
Questel PO Box 3000 London N20 0NR

COMPUTER REPAIRS

AMSTRAD ★ SINCLAIR ★ COMMODORE ★ ATARI
MOST MAKES REPAIRED AND SERVICED

FREE ESTIMATES

NO STANDARD CHARGES!

JUST BRING YOUR COMPUTER TO US FOR A FREE ESTIMATE
ALTERNATIVELY SEND YOUR COMPUTER TO US WITH A CHEQUE
FOR £5.00 TO COVER RETURN POSTAGE AND WE WILL SEND YOU
A WRITTEN QUOTATION WITH NO OBLIGATION!

TELEPHONE US NOW FOR FURTHER INFORMATION

HAWKWELL COMPUTING

2 WYMANS COTTAGES, MOUNT BOVERS LANE, HAWKWELL,
HOCKLEY, ESSEX SS5 4JB

TEL. SOUTHEND 0702-207593 ANYTIME.

OPEN MONDAY-FRIDAY 9AM-6PM SATURDAYS 10AM-1PM

WANTED



USE YOUR
VOICE
TO
OUTDRAW
THE
GUNFIGHTER

DEAD
OR
ALIVE CASH PRIZES

**0898
31 35 78**

TREASURE ISLAND

1 2 3 4 5 6 7 8 9 10



USE YOUR
VOICE TO
LOCATE THE
TREASURE

CASH PRIZES
**0898
31 35 86**

If you are under 18 years of age please obtain permission of whoever pays the phone bill.
INFODIAL POBox 36 L51 4TN Call charges 36p Per Min Cheap 48p Per Min All Other Times

Give your child a
head start with...

fun
school



5 to 7s

for 7 to 11 year

7 to 11s

“Fun School 4 zooms to the top of the class! Three brand new packages combining the essentials of the National Curriculum with beautiful graphics, cleverly animated rewards and stimulating sound keep your children engrossed while they learn.

Teddy for under fives, Freddy the Frog for five to seven year olds and Sammy the Spy for seven to eleven year olds provide SIX original stimulating programs in every pack. Plus, the carefully designed levels for each program encourage your children to have fun and learn at their own pace – and ensure they get the most from Fun School 4 and keep coming back for more.”

FORMAT	Amiga	ST	PC	C64		Spectrum		CPC	
				Tape	Disc	Tape	Disc	Tape	Disc
PRICE £	24.99	24.99	24.99	12.99	16.99	12.99	16.99	12.99	16.99

EUROPRESS
SOFTWARE

Europress Software Ltd, Europa House, Adlington Park, Macclesfield, Cheshire SK10 4NP
On sale at top retailers nationwide. Selected formats available at larger branches of
Boots, WH Smith and Menzies. For credit card purchases call 051-357 2961

Mastering m



Welcome to part four of Mastering Machine Code. This month the index register is explained – plus there's some code to multiply numbers and create RSX tables. **ANDY PRICE** shows you how it's done...

It is time now to discuss two more registers – the index registers. Indexed addressing is very useful for constructing tables and for passing parameters from BASIC to machine code – an index value is used to access a byte of information. Just as you would the index of a book to find a page number, we use a base value (held in the index register) and to it a value is added (an index) to access the information required. The two index registers are **IX** and **IY**. Thus, indexed addressing takes the format **(IX+n)** or **(IY+n)**, where **n** is the index value.

Have a look at Listing One. This is one way in which the index registers are useful, that is, in the construction of tables. You could alter the **IX** to **IY** if you wish. If you ran the program correctly you will see 'HAT' appear on the screen. Just read through the listing to get a general feel of the index registers. It isn't too complex. The second use of the index registers, passing parameters to machine code from BASIC, will be discussed in the next instalment.

Multiplication in assembly

Following a number of requests, *Amstrad Action* presents you with an extremely quick multiplication routine which is lightning fast but also very easy to understand in concept.

All comments on the working of the program are written into the listing (Listing Two). **NUM1** and **NUM2** are labels which hold the two numbers to be multiplied. The final total is stored in **HL**. Therefore, if you wish to preserve the values of registers, **PUSH** them onto the stack before **CALLING** the multiplication routine.

Resident System Extensions

For some unknown reason, it is assumed that if a person converts a machine code routine, no

Devpac users

If you've got a copy of Devpac from the AA71 covertape, you can use the listings on these pages directly. To get to grips with the program properly, though, you may want to take advantage of HiSoft's special offer on the Devpac manual (which we couldn't covermount!). Send a cheque or postal order for £9.95 to: **Devpac Manual Offer, HiSoft, The Old School, Greenfield, Bedford MK45 5DE.**

The price includes postage and packing.

The Great Article One Mystery...

There seem to be a lot of readers experiencing the same problems which, incidentally, are not my fault (I got out of that one!).

Regarding article one (in AA72), Ross Readen, Heather Keen, Iain Gilfeather and only a few million others are having problems with listings one and two. To fix listing one, change **ORG 30000** to **ENT #**. Listing two, on the other hand, came out as absolute garbage. Line 20 should read (with quotation marks this time and not funny symbols):

```
20 READ b$:b=VAL("&"*a$b)
```

Furthermore, all *Devpac* programs use the #

matter how crap, into an RSX, it automatically becomes the best program ever written. Not so! An RSX is just another way of **CALLING** your machine code routines – easily achieved.

A Resident System Extension (RSX) is an external command which can be added to the Amstrad's BASIC to provide an extension of the ordinary BASIC commands. An RSX is a string of letters or numbers which are accessed from BASIC by using the bar (!) command (press **SHIFT** and **@** together). The following are RSX commands:

```
!BASIC
!RECALL
!INTELLIGENCE
```

Believe it or not, the Amstrad has a built in RSX as standard called **!BASIC** – try typing this now. You will probably find that your computer has reset itself! All this **!BASIC** command does is **CALL** address 0 (try **CALL 0** now) which resets the computer. The other two RSX's, **!RECALL** and **!INTELLIGENCE**, are defined in Listing Three...

Type in Listing Three and assemble it. Then return to BASIC by typing **B** in editor mode. Type **CALL 30000** to log in the RSX commands (which is what the **CALL &BCD1** firmware call deals with) into the BASIC environment. **!RECALL** and **!INTELLIGENCE** are now active. **!RECALL** clears the screen and **!INTELLIGENCE** just changes the screen mode to **MODE 2**.

Obviously, these are just very simple exam-

ples, but with your knowledge of machine code I'm sure you can write some RSXs do do something more productive. You can log in as many RSX commands as you wish, just make sure the last letter of the RSX has #80 added to it (see listing) to signify the end of the RSX name and make sure that the **JP** instruction to the RSX routine coincides with the RSX name.

Try converting Listing One into an RSX. For

symbol rather than the & symbol. I apologise for this, but I work two articles ahead and I wrote the first two articles using my **MAXAM** assembler.

Lastly, read the instructions to your assembler, be it **Devpac** or **MAXAM** or whatever! You will find that problems creep up less frequently that way.

Also, if your name is Ian Highton, or you own the disk or tape version of **MAXAM** rather than the ROM version (which I have), then I suggest you assemble your code to somewhere like &6000 and type **LIMIT &FFFF** just after the **ORG** command to prevent your assembler having a freak tantrum!

example, if you wanted to run it by typing **!HAT**, do the following:

1) In the **COMMAND_TABLE** section, under the **JP CREATIVITY** command, type **JP HATROUTINE** or whatever.

2) In the **NAME_TABLE** section, above the **DEFB 0** directive (which ends the RSX table) and below the **INTELLIGENCE** RSX, type:

```
DEFM "H@"
DEFB "!"*#80
```

3) Type Listing One in the subroutine section, it really doesn't matter where, under the label **HATROUTINE**: or whatever you called it.

Code & Chips

Got any machine code queries? Things you don't understand? It doesn't matter how stupid the question, how basic your knowledge, write to:

CODE & CHIPS
AMSTRAD ACTION
BEAUFORD COURT
30 MONMOUTH STREET
BATH
AVON BA1 2BW

Machine code

4) Assemble, return to BASIC, CALL 30000 and type IHAT. If all went according to plan, 'HAT' should have appeared on the screen.

SAVING MACHINE CODE PROGRAMS

Once you have assembled your code into machine code, how to

Owing to the demand for RSX's or Resident System Extensions to be explained, the logical operators such as AND, OR and XOR will be explained in the next instalment.

you save that machine code to disk or tape from DEVPAK? Well, this can be achieved by using the command ,O, whilst in the editor.

Type: O,,filename

The O command saves to disk

or tape the machine code formed by the latest assembly. It saves the code at the program's origin.

Let us say that your code has an origin of #7000, you can reload this from BASIC by typing:

```
MEMORY &7000-1
LOAD"filename",&7000
```

AA

```

ORG #7000
ENT $

; Listing One:
; Demo of Indexed Addressing
; Type 1 - A Simple Table

CALL #BC14 ; Clear screen
LD IX,#6FF0 ; set base for index register IX
LD A,"H"
LD B,"A"
LD C,"I"
LD (IX+0),A ; store A at IX base address plus 0
LD (IX+1),B ; store B at IX base address plus 1
LD (IX+2),C ; store C at IX plus 3

LD A,(IX+0) ; load A with contents of address IX+0
CALL #BBSA ; print character on screen
LD A,(IX+1)
CALL #BBSA
LD A,(IX+2)
CALL #BBSA
RET

ADD HL,DE ; Add DE to total in HL

PROC2:
EX DE,HL ; Exchange values
ADD HL,HL ; Shift TOTAL left ('Partial Product Sum')
EX DE,HL ; Swap values back again
DJNZ PROC1 ; Decrease B (count) jump to PROC1 if not zero
POP BC ; Restore old BC value from stack
RET ; End MULTIPLY routine

ORG 30000
ENT $

; Listing Three:
; RSX Table Definer
; Resident System Extensions
; Programmers Toolbox - Code Macro 2

LD HL,WORK_SPACE ; buffer for the Kernal's use
LD BC,COMMAND_TABLE ; address of command table
JP #BCD1 ; introduce RSX table and return
; to BASIC once completed

COMMAND_TABLE:
DEFW NAME_TABLE ; address of new command table
JP PHOTOGRAPHIC_MEMORY ; new commands added using JP
JP CREATIVITY ; address of routine called by
; INTELLIGENCE

WORK_SPACE:
DEFB 0,0,0,0 ; for use by the Amstrad's Firmware

NAME_TABLE:
DEFW "RECAL" ; RSX IRECALL
DEFB "L"+#00 ; RSX IRECALL
DEFW "INTELLIGENC" ; RSX INTELLIGENCE
DEFB "E"+#00 ; RSX INTELLIGENCE
DEFB 0

; End of RSX Table - All RSXs are now defined
; Subroutines for the RSXs can now be coded below

PHOTOGRAPHIC_MEMORY:
CALL #BC14 ; Code for IRECALL goes here
RET ; End routine

CREATIVITY:
LD A,2 ; Code goes here for INTELLIGENCE
CALL #BC0E
RET ; End routine

ORG 30000
ENT $

; Listing Two:
; Fast Multiplication Code
; Programmers Toolbox - Code Macro 1
; Multiply HL by DE, store result in HL

NUM1: EQU 45
NUM2: EQU 18

LD HL,NUM1
LD DE,NUM2
CALL MULTIPLY
RET

MULTIPLY:
PUSH BC ; Preserve value held in BC
LD C,H ; Load C with high byte of HL
LD A,L ; Load A with low byte of HL
LD B,16 ; 16 bits in a 16 bit number
LD HL,0 ; TOTAL stored in hl, so reset hl first

PROC1:
SRL C ; Shift bits one bit to the left
RRA ; Rotate right one bit the accumulator
JR NZ,PROC2 ; If bit in A=1, jump to PROC2

PROC2:
EX DE,HL ; Exchange values
ADD HL,HL ; Shift TOTAL left ('Partial Product Sum')
EX DE,HL ; Swap values back again
DJNZ PROC1 ; Decrease B (count) jump to PROC1 if not zero
POP BC ; Restore old BC value from stack
RET ; End MULTIPLY routine
```



● Here's the main menu. It's in French. Er, but the things in it mean, respectively, create, manual, disk, tools listen, options and quit.



● Look, it's one of the rhythm tracks. Repeat the phrase 'bum sch bum sch bu bu bu bum sch' to get the full Equinox experience.

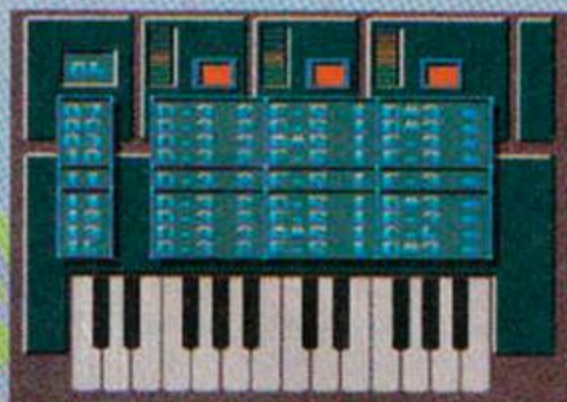

● And here's the full 'chainage' playing. Sing a series of rhyming couplets over it, and you've got yourself a hit single. Murrah!

EQUINOXE

If music be the food of love, *Equinox* must be some sort of microwave or something. ADAM PETERS dims the lights, puts on a baseball cap and becomes a rock star...

The roar of the crowd; ten thousand arms swaying in unison, screaming chicks throwing their underwear (yuck!); it's that rock and roll dream. Let's be honest though, this individual's previous attempts at rock stardom, fronting indie thrash heroes Hippy State, have hardly been an unmitigated success. The vision lasted seven minutes, and ended running screaming from the stage, amidst an angry hail of bottles and beer glasses (true). Can *Equinox* be that much-sought remedy for total absence of talent?

Possibly. It says on the box that it's the "new musical standard on the CPC", but then we never trust what's written on the box, do we kids? The proof is in the pudding. Or in this case, the disk drive.

At first glance, the proggie seems quite impressive. Along the bottom of the screen, two octaves of a keyboard. In the middle, the windows that sequence and chain info scroll up. And at the top, three LED-style indicators, one for each of the sound channels.

The pull-down menus are all in French, but the manual is in English. Providing you know what "Je m'appelle Fred" means, you shouldn't have much problem. Initially, *Equinox* can be a bit daunting though. The manual hasn't trans-

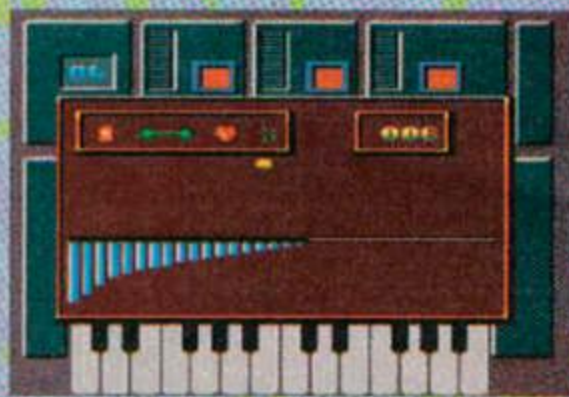

● You can create and edit your own sound envelopes too!

lated all that well (halfway through page one and you think you've bought an airline), and when you can't get any noise to come out of it, no matter what you do, it can get a bit frustrating.

Here's the rub: sounds (*sons*) and sequences (*musique*) have to be saved as separate files. Catalogue (*liste*) side B to find the names of the files provided with the disk. Then load (*charge*) a sound file and a sequence file. Then listen (*ecoute*) to either the single sequence or the full song (*chainage*). Switch off the lights, get a torch to flash, invite all your friends round and have a rave.

Then, when you wake up the following morning with a sore head and a wrecked house, examine some of the program's other features.

Once you've loaded in some sounds, the manual option (*manuel*) will allow you to use the top two rows of the keyboard as a synthesiser sort of thing.

Use the same technique when creating sequences and chainages under the *edition* menu. You can also create your own sound envelopes, which is dead complicated, but also dead good. There's a rhythm box to play around with, along with loads of hi-tech cut and paste options and other stuff.

Equinox really does push the CPC's sound chip to its limits, and really comes into its own when blasting out in stereo, through a Plus machine or a CPC with something stuck in the stereo socket (speakers, preferably).

It's a bit expensive, but if you've ever considered buying a Casio keyboard sort of thing, get this instead. The lack of MIDI implementation makes it of little use to serious musos, but anyone who wants to play around at making noises, and has the patience required, will say "thank you very much, Mr Ubi Soft".

And if you want to buy a copy, either organise a day trip to France (being sure to stock up on berets, onions and bicycle clips while you're there) or turn to page 53 and send that cheque to the sole UK distributors, AA Mail Order. Pretty soon you could be just like Bryan Adams. (What, Canadian? - ed.)

AA

WIN A FREE COPY OF EQUINOXE!



Yo, pop pickers, wanna free copy of *Equinox*? Then send us a tape with some original music on, whether a solo performance or a band or whatever. Just as long as (a) you're involved in it somewhere, and (b) so is a CPC (whether it's *Drumkit*, *Equinox*, *Advanced Music System* or something else). Try and get a really good quality recording, enclose a note explaining where you and your computer were involved, and send it to *Hello Bath, Are You Ready To Rock And Roll?*, Amstrad Action, 29 Monmouth Street, Bath, Avon BA1 2DL. Closing date, er, let's say January 18th 1992. Who knows, we might even chuck the winning composition on a cover tape. Yo!

GOOD NEWS

- Very well presented
- Loads of features
- Fun to play around with

BAD NEWS

- Not MIDI compatible
- Daunting at first

Verdict 83%

HOW TO BE A POP STAR

It takes more than owning a CPC and a copy of *Equinox* to make it in the wild world of rock. MARK FRITH of top pop fortnightly *Smash Hits* tells all...

So, you want to be a pop star do you? Well don't, it's silly. Being a pop star may seem to be a glamorous and fulfilling way to live your life, but it isn't. All it will bring you is a sudden temporary burst of glory, followed by years of squalor, unpaid taxes and lack of job opportunities due to a mis-spent missed-classes childhood. If you're lucky. But if you still want to chance your hand in the game called fame, there are certain steps you must take. And they are:

(i) Have very rich parents. Yes, sad but true, the age of needing inherited wealth is with us yet again. In recent times anyone with two tape recorders, a connecting lead and a couple of ideas could make records. These days the equipment is more expensive and the traditional 'proper' instruments still cost a bomb.

The validity of the 'rich parents' route to success can be seen with the recent development of the 'shoe-gazing scene' - young students with expensive equipment, smug, dour looks and not a single idea in their heads.

(ii) Rampant egomania. Childhood smart-arse? School show-off? General clever get? Then get some of your boasting into lyrical form - rap music is good for this - and you're well away. Pop fans love arrogant singers. Pop musicians should be bigger, sexier and cleverer than us mere mortals. Think big - and tell everyone how great you are.

(iii) Interests in dubious causes. Actually, don't worry about this one. As soon as you've had a sniff of a hit single you'll be collared into appearing on dozens of charity records, will have met Sting at a party and will be able to become a great authority on causes that, in reality, you know absolutely nothing about.

(iv) Good gear. This may involve a trip to the dreaded city centre to buy some clothes, I'm afraid. Your pop outfit should contain some - and perhaps all - of the following: Brightly coloured cap (worn backwards), a T-shirt featuring your favourite (ie completely obscure) indie group/cartoon character, lots of gold jewellery (hide the 'made in South Africa' tag, though), very baggy fluorescent trousers, and some cool training shoes.

Combine this with an individual hair cut (something with shaven sides and a long bit at the front you can shake around), a keyboard (playing it is optional) and extreme health problems.

Bing! You are a pop star! Just don't give up the day job, eh?



● How to be a music journalist: (i) Get flowers. (ii) Stand in field.



● How to be a crap band: (i) Get Adam P (behind guitar) as singer. (ii) Lock engineer in drum room. (iii) Act like berks for eight hours.

SUPER SEGA

5 GAME COMPILATION



FEATURING



SUPER MONACO G.P.™
"Absolutely gob-smacking graphics and animation, simply the best 3D animation I've seen on any computer."
COMPUTER FUN 96% (Amiga).

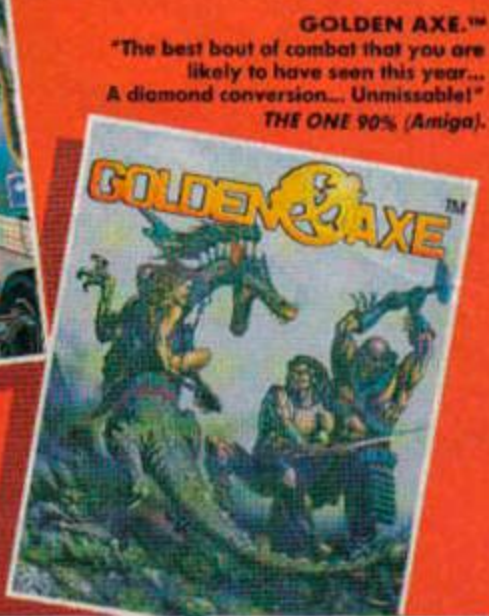

GOLDEN AXE.™
"The best bout of combat that you are likely to have seen this year... A diamond conversion... Unmissable!"
THE ONE 90% (Amiga).

Available on
CBM 64/128, Amstrad CPC Cassette & Disk, Spectrum 48/128K, +2 Cassette, Atari ST/STE & CBM Amiga A500/A1000/A2000 series.



CRACK DOWN™
"Definitely one for arcade addicts, a no-nonsense blasting frenzy."
YOUR AMIGA.



E-SWAT™
"One of the best conversions we've seen on the Amstrad, with all the playability of the coin-op."
C&VG (Amstrad).



SHINOBI™
"Superbly presented and highly playable... It's so authentic, at times I believed I was playing the arcade machine!"
ZZAP (C64).



This compilation © 1991 Sega™. All rights reserved. Super Monaco GP™, Shinobi™, Golden Axe™, ESWAT™ and Crack Down™ are trademarks of SEGA ENTERPRISES LIMITED. SEGA™ is a trademark of SEGA ENTERPRISES LIMITED. Manufactured and distributed under license from SEGA ENTERPRISES LIMITED by U.S. GOLD LTD., Units 2/3 Holford Way, Holford, Birmingham B6 7AX. Tel: 021 625 3366.

Cisco Heat

ALL AMERICAN POLICE CAR RACE™

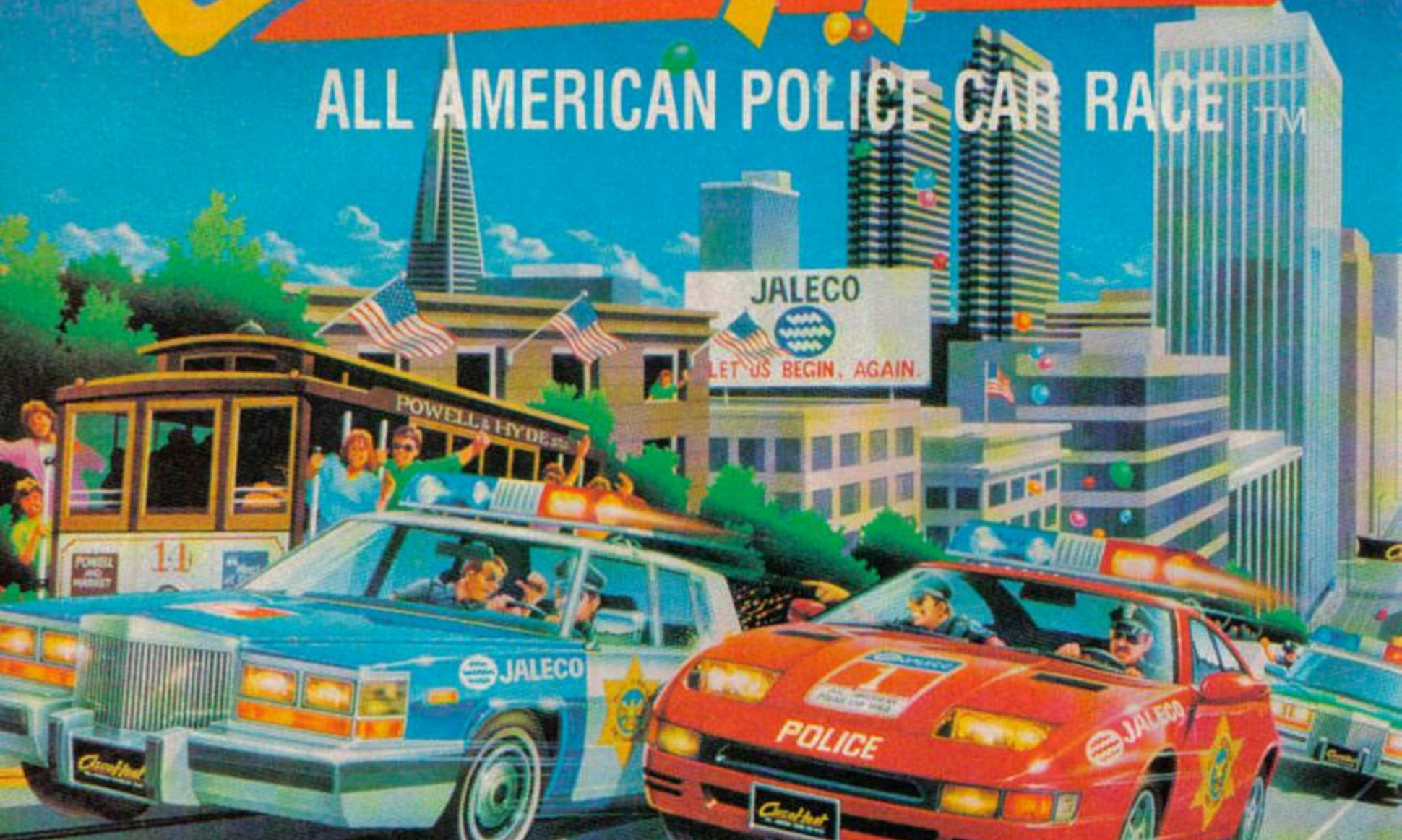

It's that time of year again. The centre of the city has been cordoned off in readiness for the annual police race.

Take the wheel of your high powered police car as famous areas of San Francisco flash by with exciting realism . . . The Golden Gate Bridge, Fisherman's Wharf, China Town and many more; as you head for the finishing line at Treasure Island.

With 5 levels to tackle, only the top class drivers can make it - so hit the gas pedal and race for glory.



Image Works, Irwin House, 118 Southwark Street, London SE1 0SW. Tel: 071-928 1454. Fax: 071-583 3494

© 1991 Jaleco Ltd. Cisco Heat™ is a trademark of Jaleco Ltd Japan. This game has been manufactured under licence from Jaleco Ltd Japan.
© 1991 Mirrosoft Ltd. Image Works is a brand name of Mirrosoft Ltd.

ACTION TEST

We've got a right
on corkers this month
in the form of *Smash TV*
and *Turtles 2*. Plus
treats for both rugby
and footie fans...

38



Ocean

● It's smashing! (Sorry)

WORLD CLASS
RUGBY

50

WORLD CLASS RUGBY

● Get your own back on the Aussies!

Audiogenic

28

MAN UNITED

TURTLES 2



Krysalis

● Strategy and skill, what a combination. The game that hit the top of the charts nearly makes a Rave...



Mirrorsoft

● Run, jump, punch, hit... oh, and read the plot sometime, but don't rush. It's great!

40

49

SLIGHTLY
MAGIC



Codemasters

● Little Puff in Mode 1? Or Dizzy with a hat on? We can't make our minds up, but it's still pretty decent.

ALIEN STORM

US GOLD ■ £11.99 cass, £16.99 disk

It's Sunday morning. The sound of drunken revelry has faded into the past. There is no-one around but a couple of joggers and a postman who's forgotten that the Royal Mail don't deliver letters on Sundays...



● Arrrggggh! Mutant blue snails hiding under oil drums! Now that's sneaky. Don't like the look of this character coming up behind, either.

On the pavement, lots of pools of oozing stinking slime. Yeuck, chunderama. From the dustbins come strange squidgy sounds, like the sort of noise you get if you squash a banana behind your ear. (I'm really sorry about this - ed.) It's just like any other Sunday morning.

But wait! What's that? Over there! No, not there, there! My God, the pools of sick are moving, there's giant snails in the dustbins, purple hedgehogs everywhere, and big red wobbly things wandering about.

Quick, better renew that

insurance policy, the aliens have invaded!

Thank heavens we've got Gordon, Karla and Scooter (wasn't he one of the *Muppets*?). They'll soon sort out those alien fiends. Their particle beam thingies aren't much cop, but the blaster guns they occasionally produce will make vegetarian mincemeat of those bug-eyed baddies.

Sure, the Milton Keynes UFO Watchers Society only has three members and holds its meetings in the local *Burger King*, but hey, it's enthusiasm like theirs that won us two world wars and three Eurovision Song Contests. They'll sort those extra terrestrials out, mark my words. Go get 'em, kids...

...Actually, US Gold's latest Sega coin-op convo isn't all that hot really. There's a slight bit of variation with the *Op Wolf* style shooting gallery bits and the stupid, pointless fast-scrolling somersault stage. Basically, though, it's a bit naff. You just walk up to the nearest baddie and keep pressing Fire till your character puts the stupid beam thing down and gets a proper gun out.

Some of the baddies spit fire. Others just tickle you to death with their antennae. The graphics are quite nice and the sound effects



● The *Op Wolf* style section. It would be a bit easier if the... blast!... if the danged crosshairs moved a bit... ack!... faster.

FIRST DAY TARGET SCORE

Get to Mission Three

make a brave attempt to conjure up that John Wyndham (*Day of the Triffids*) atmosphere.

There's actually quite a lot of game here for the money, but very little gameplay. It gets very boring very quickly. Some people will like it, but ultimately it's just far too insubstantial.

Adam P

ALIEN STORM
VERDICT

- GRAPHICS..... 71%
Run of the mill coin-op convo piccies.
- SONICS..... 48%
Stop shooting and drop a pin - 'nuff said?
- GRAB FACTOR..... 78%
Starts promisingly, with varied opening stages.
- STAYING POWER... 49%
It soon gets samey, you soon get sleepy.

RATING 52%

Alien Storm is a nice idea. Unfortunately, the gameplay got left in the removal lorry during the arcade-to-CPC transfer.

SECOND OPINION

"Alien Storm looks good and moves pretty well for an 8-bit arcade convo... but all you can do is stand there and trade blows. It's a bit dull."

Adam Waring

ACTION TEST

"Good evening from Old Trafford, tonight the venue for a very strange match indeed.

Manchester United Europe lines up in a battle for that great Mastergame Trophy. And now over to Emlyn in the studio."

"Squeak squeak squeak Man United squeak Graphics squeak Gameplay squeak squeak Quite a contest."

"Thank you Emlyn. And here comes the referee now, trotting on with the ball. Good job he remembered that. Jimmy Greaves?"

"Apples and pears, dog and bone, yes mate, what can I say, jocks, dagos, micks, it's a funny old game innit? Buy my book."



● And FSK Blue Star Liebfraumlilch are on the break here. Looks like a good scoring chance here, eh, Emlyn? "I'm mates with royalty, me."



● And what a fantastic save there from Jim Leighton! You don't see that sort of thing in real life. Gazza? "Eeee, I'm dead cheeky, me."

MANCHESTER UNITED EUROPE

KRISALIS ■ £11.99 cass, £15.99 disk

"And there seem to be twenty-two players on the pitch which has to be a good start. Tonight Man U have selected to play in the European Cup Winners Cup, but they could have chosen any of the three European competitions. Manager Alex Ferguson has opted not to play any friendlies in preparation for tonight's match. He's dropped Mark Hughes in favour of Mark Robins. What are the implications of that, Mick Channon?"

"Oo ar, the boy done good, you've got to get players into the box haven't you, he's decided what he wanted to do and he's gone and done it. Good luck to the lad."

"Er, thanks Mick. Well there's the whistle and they're off. Graham Taylor?"

"Well the play's a bit sluggish isn't it, and it's not very conducive to flowing, passing football but it looks good and it's certainly a lot of fun. I could say it's good or I could say it's not, but I can't really commit myself. They're playing well, but on the other hand they aren't..."

"Yes right, sorry, have to interrupt you there, it's a goal! Man United were a bit slow and the Indicators have scored. Any comment, Michel Platini?"

"Oui. Oh la la. Je m'appelle Michel, combien des oeufs avez vous? Voici Henri. Ou est le gare? Un, deux, trois, quatre, je

suis, tu es, il est..."

"And it's another goal! A second human player has taken

control of the other team and Man U have cracked in an equaliser. That two-player option has certainly paid off for United.

"Goodness gracious me! It's another one from United! They brought on a couple of substitutes to replace tiring players and immediately hammered one home. What a contest this is turning out to be. Gary Lineker?"

"Yes, I do think the goalkeeper might have been at fault, but it was a good strike. Everybody should be nice to each other and there should be no more wars. That'd be good."

"Well, this is quite a game. The overall depth of the United play is proving quite a challenge, with good control over both the

play and the overall shape of the team. Alec Ferguson has a lot of scope in picking his team. That option of which cup to play in, and the choice of playing friendlies against any of over a hundred different Euro opponents, is certainly paying off in a major way. Jimmy Hill?"

"I've noticed that players can dribble with the ball for inordinate distances, and are unable



● It's kick off time. So any predictions then, George Best? "Hic, sheesh, you're me best mate you are, hic, come 'ere mate, hic."

to pass or shoot when there's an opponent within a few feet of them, which is a bit silly."

"And there's the final whistle. Man Utd Europe was let down a bit by its lack of speed and accurate passing. It hasn't done enough to win the Mastergame, but a very good performance nonetheless. My name's Brian Moore, thank you and goodnight."

Adam P

SECOND OPINION
"The graphics are none to special, but the depth of the game makes up for that. The added element of strategy makes for a solid footie simulator."
Rod Lawton

FIRST DAY TARGET SCORE

Get to the semi-finals

MAN UTD EUROPE VERDICT

GRAPHICS..... 74%

Pele called football 'the beautiful game'. He'd call MUE 'quite pretty'.

SONICS..... 65%

All the usual farting and frying noises.

GRAB FACTOR..... 78%

Well presented and easy to get into.

STAYING POWER... 70%

Two-player option adds to the appeal, but it gets boring after a while.

RATING 73%

A very workpersonlike and polished performance from the Manc lads. They won't win any cups with this one, but at least relegation isn't an issue.



TERMINATOR™ 2

JUDGMENT DAY

IT'S NOTHING PERSONAL

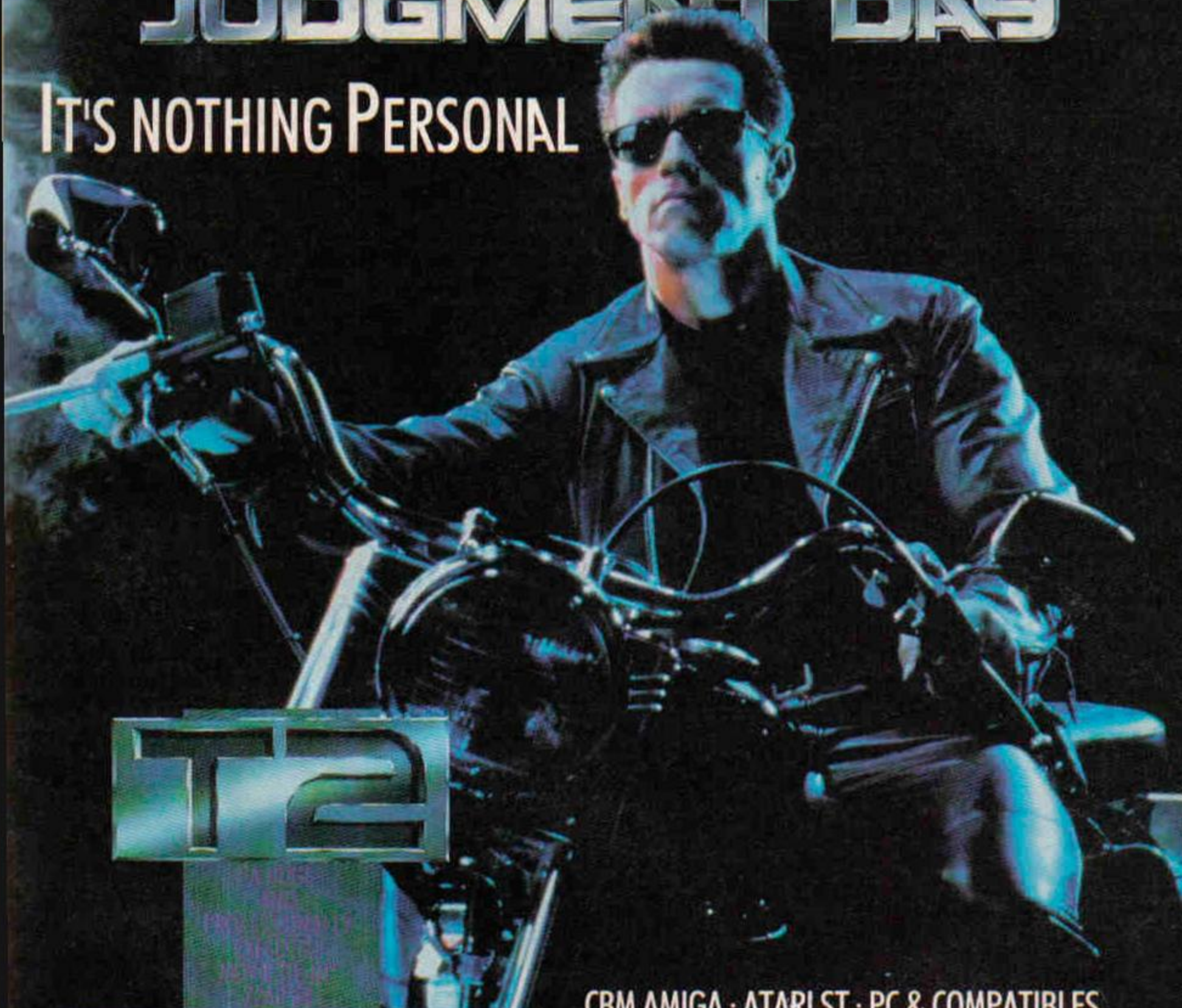

CBM AMIGA · ATARI ST · PC & COMPATIBLES
COMMODORE 64 · AMSTRAD · SPECTRUM

YOU ARE T-800

IN THE ACTION PACKED
GAME-PLAY OF
TERMINATOR 2,
THE YEAR'S HIT MOVIE,
AS IT EXPLODES ON TO
YOUR COMPUTER SCREEN,
SPECTACULAR GRAPHICS

AND FIERCE ANIMATION
THROW YOU HEADLONG
INTO THE FURIOUS
STORYLINE OF THE
BOX OFFICE SMASH....
AND A GAME YOU WILL
NEVER FORGET.

"Variety is definitely the winning ingredient with Terminator 2... Ocean's tie-in game will be their biggest yet... and could be their best." ZZAP 64

"You'll keep coming back like Terminator himself... good game-play will attract and absorb you... get hold of this, it's as mean as Arnie!" YOUR COMM

"An accurate conversion that will appeal to the fans of the film or the muscle-bound hero himself." ST ACTION



OCEAN SOFTWARE LIMITED
6 CENTRAL STREET
MANCHESTER · M2 5NS
TELEPHONE: 061 832 6633
FAX: 061 834 0650



© 1991 CAROLCO INTERNATIONAL N.Y. ALL RIGHTS RESERVED.
ACCLAIM™ AND MASTERS OF THE GAME™ ARE TRADEMARKS OF ACCLAIM ENTERTAINMENT INC.

entertainment inc

FREE T2 T-SHIRT
FREE T2 BADGE

SUPER SEGA

US GOLD ■ £17.99 cass, £24.99 disk

Compilation

Uh oh, Multi-load City here we come! ADAM PETERS digs into the coin-op compilation that will drive every tape user to despair...

SUPER MONACO G.P.



● A bit jerky and slow, but it's good when you get into it.

Possibly the most over-rated drive-em-up ever. It's not bad, but then it's not as good as it's sometimes claimed to be. Scrolling is slow and mega-jerky, controls are at times unresponsive, and in order to qualify for the race proper you have to complete a practice lap within a specified time.

Nothing wrong with that? Well it is a very long lap, and there are no other cars on the course (yawn). Even in the proper race, you'll lose track of the other cars pretty soon after the start, and will only run into one every minute or so. Boring is something drive-em-ups can't afford to be. But this one is.

SHINOBI

Yo, ninja kids! It's time to put on your pyjamas, fill your pockets with shurikens, and tie a big girly bow in your hair. Oh yeah, and take to the streets, and the tops of railway carriages, all over St Albans. In an

attempt to rescue a group of schoolkids from the evil Burde Poo. He's kidnapped them, the little rotter.

Like all the other games on this compo, Shinobi is a convo of a Sega coin-op, and also a very burdensome multi-load. Unlike any of the others, it's available as a budgie (budget game) so loads of you have probably got it already. It's pretty good, if fairly uninspired.

● Cor, this one's been around a bit. A demo on an AA covertape, a stint on full-price, then on budget, now on Super Sega! We're getting a bit fed up of it, frankly...



SECOND OPINION

"Coin-op convos are tricky on an 8-bit. Some of these are decidedly iffy, but Super Monaco GP is good if you like motor racing. I rate Shinobi a bit better than Adam does, too."

Rod Lawton

GOLDEN AXE

Fairly stupid swords-and-sorcery beat-em-up. You can be either a tall bloke with a stick, a short bloke with an axe, or someone else we haven't bothered trying.

Wander round, hacking and slashing everything that crosses your path, hitching lifts on Bizarrians (big chickens) where you can, fighting through to your ultimate destination. Which involves killing a bloke called Death Adder. Some people swear by Golden Axe. We stand next to it and say "poo".



● Colourful graphics, but blocky as heck. Golden Axe is OK, but it's not going to drive you wild.

ESWAT

Shinobi has lost his ninja powers and got some proper clothes (albeit rozzer-wear), and ended up wandering the streets of Cyber City. Doing much the same thing as usual, only this time with a gun. Eswat is crap.

It looks good, but it's slow, jerky, wholly derivative, and as easy as banging your head against a lamp-post. Keep lying prone on the ground and blast away at the wimpy bad guys in total safety. You'll finish this game within two hours of starting to play it. But don't bother playing it. Take it outside and shoot it instead.

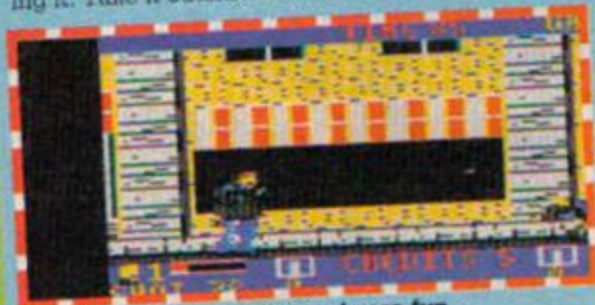

● Giant arthritic sprites and zero fun.

CRACKDOWN

Way back in the midsts of time there was a ZX81 game where you had to plant some bombs in a building, avoiding the baddies, and get out before they blew up. Crackdown is nothing like that. In Crackdown, the bombs are already there. You only have to prime them. And avoid the baddies. And, er, get out before they blow up.

Crackdown is actually a quite entertaining little shindig. It's one of those two player split-screen things, which means you and your chum don't have to hang around waiting the other person to catch up before being able to move on. Then again, it also means a crappy small screen for one player games. The map at the top of the screen shows the bombs, weapons power-ups and the baddies (and the layout of the place of course). Bombabunga!

● Look out for the baddies, prime the bombs and then get out of there! There's also a simultaneous two-player mode for extra fun.



SUPER MONACO G.P.	63%
CRACKDOWN	84%
GOLDEN AXE	58%
SHINOBI	80%
ESWAT	23%

Verdict 67%

"More patchy than that quilt Aunt Victoria knitted you. (But a bit more useful.)" Adam P

FRENCH TEST



- suitable for beginners and advanced alike -
£14.95 (Disk only)

- ★ Over 2500 words organised into more than 80 different topics and 40 dictionary tests plus dozens of useful phrases.
- ★ Flexibility - select from GCSE topics (Basic and Higher) or enter own vocabulary and merge a term's homework for revision.
- ★ Two levels - Quick Test for rapid revision and Full Test for language learning with inbuilt PROGRESS ASSESSMENT.

"Accurately and slickly presented, Guillotine game very well done" AA
 "An excellent utility which puts the fun back into learning" ACU

NOTE: Using this program ensures success at GCSE - pass or we guarantee to refund your money in full.



Including **LA GUILLOTINE**



Cheques etc. to: GMF Programs, Dept AA, 21 Northwick
 Park Road, Harrow, Middx. HA1 2NY
 Tel: (081) 861 2891 Plus evenings & weekends

- Amstrad MP3 Modulator/TV Tuner, use with CTM 644 **£29.99**
 - Amstrad MP2 (6128) Modulator/Power Supply.. **£19.99**
 - Amstrad MP1 (464) Modulator/Power..... **£14.99**
- Add £4.00 for postage and packing

All orders sent by return: Cheque/Visa/Access

Trade-In-Post, Victoria Road,
 Shifnal, Shropshire, TF11 8AF.
Tel/Fax: (0952) 462135



Trade enquiries welcome



"BOOKIE BEATER"

DON'T WANT TO WIN? O.K. IGNORE THIS!

Hi! My name is John Keneally, and I was once silly enough to be *CERTAIN* there was no such thing as a winning system for horse racing. *This is the program that forced me to eat my words!* I really couldn't believe it when I tested it myself, it just seemed to cast a magic spell over each race. **Just look at these ACTUAL RESULTS for a recent PICKED AT RANDOM.** Note we give EVERY RACE DAY, nothing left out.

Horse	Result	Odds	Date
DANCING RIVER	WON	2/7	15/10/91
VALATCH	LOST	12/1	16/10/91
-----	(NO BET)	-----	17/10/91
COMMON COUNCIL	WON	1/2	18/10/91
CLAY COUNCIL	WON	1/2	19/10/91
(No racing, Sunday)			20/10/91
CASTILLET	WON	5/2	21/10/91

Work out the winnings yourself. Convinced? You should be, I think they speak for themselves. The program gives just one bet per day (or 'no bet') and I promise you no complex 'form' details to enter. It will take you less than 5 mins. a day. The bad news is that we will only release a *LIMITED NUMBER* of (numbered) copies. To avoid disappointment **YOU MUST ACT NOW!** "BOOKIE BEATER" is DISK ONLY for all CPC at £35 per copy. Please send orders to Camel Micros, PO Box 172, EXETER EX1 2UR (not to Head Office). I won't wish you luck, you'll have plenty with "BOOKIE BEATER".
 John Keneally.

P.S. Yes, I am still using it myself - and winning!

Head Office: 38 Stuart Rd., EXETER. Tel: (0392) 421105

G.V.L. BAGSTORM

G.V.L. Bagsform
 191 Watling Street Road, Fulwood, Preston, PR2 4AE
 Phone 0772-701248 Fax 0772-703131

3 1/2" Super Drive £79.95

(Plus £3.00 p&p)
 (Including **FREE MS800 or MAXIDOS**)

- ★ 800k per disc
- ★ Dual Mode
- ★ 5 Status Indicators
- ★ Side Switch
- ★ Multi Compatible
- ★ Low cost Discs
- ★ External PSU
- ★ Compact size
- ★ **FREE Software**
 (NOT suitable as 1st drive for 464)

64k DKtronics RAM PACK	£38.95
FDI Disc Drive (State model)	£59.95
3.5" Discs (Branded Bulk) (10)	£ 7.45
3" Discs (Amsoft) (10)	£19.95
3.5" Disc Box (holds 40)	£ 6.95
Printer Lead (CPC or Plus)	£ 7.95
ABBA Switch	£10.95
3rd Drive Switch	£10.95

FILE TRANSFERS

CPC To/From PC's, PCW's, and Others
2in1 - £24.95 : MFU - £29.95
 (Both programs run in CPM+ - NOT CPM 2.2)

MAXIDOS (with FREE PROCOPY) £13.75
MS800 £ 9.95

BONZO SUPER MEDDLER	£13.75
BONZO BLITZ	£13.75
BONZO BIGBATCH	£ 9.95
BONZO FLASHBACK	£ 9.95

Please state model when ordering Disc Drives
 * Please add £3.00 p&p for Disc Drives
 All prices include VAT

**CREDIT CARD
 ORDERS**
 (24hr Service)

Phone 0772-701248

Cheat Mode

AA's cheating section is crammed with goodies for anyone stuck in a game:

- Pokes (the listings) let you hack into the game code to give yourself extra lives, fuel and more
- Multiface pokes (these follow the listings) are even easier to use for those people who

own those little black boxes

- Keypress cheats are put in by programmers to help the playtesters and then left in – they're often just there to be found...
- Passwords and solutions are sent in by dedicated gamers who want to share their hard-won knowledge

NEW KIDS BLOCK

If it's worrying you that the pokes in *Cheat Mode* just look like a jumble of signs, squiggles and numbers to you, fear not, that's just what they are! They're programs written by specialists to take the control of loading function, alter, and then start the game. What you will need to do, should you want to use one, is:

- 1 Make sure the routine is written for your format – disk or tape – they will not generally work with both.
- 2 Type it in to the computer, making sure there are no errors.

● Typing in routines is always prone to errors, so here's some help:

The funny numbers within the "[]" brackets on the left of the lines are NOT to be typed in but are a code produced by the TYPEWRITER program printed periodically in *Amstrad Action*. (It was on the covertape with AA67 and AA68). It checks each line as it is typed in and produces a code which can be compared with that printed. You don't have to use the TYPEWRITER program, but it's recommended.

All SPACES in the lines have been replaced by printed dots, the idea being that it makes them easier to see. See a DOT? Type a SPACE!

Quite often the routine itself will have a built-in check on the DATA numbers and will tell you if one of them is typed in wrongly. User-friendly or what?

- 3 Save the program to tape or disk (not the game tape or disk!) so that it can be used again.
- 4 Put in the game tape or disk and type |TAPE or |DISC.
- 5 Type RUN to run the routine (not RUN "" (CTRL+ENTER) as you normally would)

You should find that the game will load normally, or you will be given instructions on what needs to be done.

KLAX

Now here's an oddity.

Rob Scott of Leatherhead has written this routine which changes the colour of the yellow tiles in *Klax* (disk) to green and orange.

Apparently it was written for a friend whose monitor (or eyes) weren't all they should have been, so if you are in the same predicament, then this poke is for you.

```

<KtAw> 10.'...KLAX-disk.poke.(c).1991.STS.
<OrAi> 20.'
<BsBl> 30.'Turns-YELLOW-blocks-to-GREEN/ORANGE
<PtBi> 40.'Written-By-Rob-Scott-for-Jase-B.
<HuAi> 50.'
<OrAt> 60-MODE-1:INX-0,0:BORDER-0
<NjBn>
70-PRINT"Insert-KLAX-disk-and-press-any-key...."
<IqAp> 80-CALL-8BB18
<GsAs> 90-FOR-a=840-TO-861:READ-b#
<BiAu> 100-POKE-a,VAL("a"+b#):NEXT
<LwAo> 110-CALL-840
<LxBj> 120-DATA-11,00,00,0E,41,21,00,01,E5,DF
<PxB1> 130-DATA-5E,00,21,56,00,22,05,01,E1,C3
<LjBi> 140-DATA-16,BD,3E,42,32,8E,63,C3,00,04
<FtAp> 150-DATA-66,C6,07,00
    
```



And just in case your interest in *Klax* has been revitalised, here is a routine from Ross Younger of Edinburgh, which supplies infinite credits and drops for the tape version.

```

<HtAg> 1-'Klax-Tape-Poke
<BpAs> 2-'By-Ross-Younger
<EtAv> 3-'Infinite-Credits-&-Drops
    
```



```

<EwAl> 10-MODE-1
<FoAu> 20-FOR-t=840-TO-877:READ-a#
<KwAp> 30-c=c+VAL("8"+a#)
<KiAw> 40-POKE-t,VAL("8"+a#):NEXT-t
<BiAt> 50-IF-c()4529-THEN-140
<OpAn> 60-CALL-840
<NxAw> 70-DATA-01,2a,00,11,40,03,21,4e
<HkAx> 80-DATA-00,ed,b0,c3,40,03,06,01
<CkAx> 90-DATA-21,69,03,cd,77,bc,21,00
<JnAv> 100-DATA-01,cd,03,bc,cd,7a,bc,3e
<DeBk> 110-DATA-c3,32,8e,01,21,5f,03,22
<IiBi> 120-DATA-8f,01,c3,00,01,af,32,eb
<IoAw> 130-DATA-0b,32,fc,0a,c3,00,04,2e
<OnAs> 140-PRINT"DATA-ERROR!"
    
```

Address	Poke	Effect
0BEB	00	Inf. Credits
0AFC	00	Inf. Drops

NORTH & SOUTH

Civil war shouldn't really be this much fun (ask Rhett and Scarlet). If those damn Yankees are causing you trouble again here are some playing tips for *North and South* From Richard Hewitt of Belfast:

Battle

- Always blow up a the bridge (if there is one) and then position infantry and artillery in line with the unbreakable bridge.
- When using cavalry make sure you're in line with the bridge.
- If in hard mode, try not to get trapped on the enemy's side when retreating.
- When the computer has hardly any men it will attempt to retreat. You must chase them until there is nowhere left to go.

Fort and Train fort

- When on the ground, wait until dogs and people pass before getting up.
- Always climb the ladder at the start.
- Try hand-to-hand fighting to save on knives.
- You can only climb on the front or the back of a carriage.

Map

- The ship comes in May, September, and January. Only fight for these territories 1 month before, so it won't be won back in time.
- Always put new armies in your towns.

- In 1861 don't reinforce your armies.
- Use very small armies to defeat many people before getting wiped out (suicide mission).

BLOODWYCH

Fans of the (tape version) mighty *Bloodwych* get a helping hand from Kings Lynn's crowned poker Stephen Troup, who creates a super character for a super game. Super! I didn't get where I am today without a helping hand from Kings Lynn!

```
(NjAp) 10·REM··········Bloodwych
(AnBk) 20·REM·Makes·Blodwyn·a·Super·Character
(CoBl) 30·REM·Infinite·Energy·and·Spell·points
(GkAu) 40·REM··········by·Stephen·Troup.
(EiBl) 50·MEMORY·&9FFF:MODE·1:LOAD"!BLOODWYCH"
(EiAp) 60·FOR·a=ABE00·TO·ABE63
(LkAx) 70·READ·b$:POKE·a,VAL("&"&b$)
(LvAq) 80·t=t+VAL("&"&b$)
(EoAk) 90·NEXT
(BuBn)
100·IF·t(>&20C2·THEN·PRINT"Data·Error":END
(OjAo) 110·CALL·&BE00
(KkAx) 120·DATA·DD,2E,C3,11,10,A0,1A,DD
(FjBk) 130·DATA·AD,12,13,3E,A2,B0,20,F6
(PsBj) 140·DATA·21,24,01,22,01,A0,21,00
(IrAx) 150·DATA·BE,11,00,01,01,65,00,ED
(RnAw) 160·DATA·B0,C3,11,A0,3E,A7,32,23
(EvBj) 170·DATA·05,32,73,9B,11,FC,61,01
(MiAx) 180·DATA·2A,00,21,3A,01,ED,B0,C3
(EwAt) 190·DATA·00,02,63,63,63,63,63,FF
(MvAw) 200·DATA·FF,63,63,FF,63,63,05,00
(BjAv) 210·DATA·00,00,00,00,63,63,00,00
(MsAw) 220·DATA·2E,2E,1A,21,07,01,0A,0A
(AiAv) 230·DATA·00,00,00,02,00,FF,00,00
(HuAp) 240·DATA·FF,FF,FF,FF
```

• Multiface pokes for Bloodwych

Address	Poke	Effect
0523	A7	Inf. energy
9B73	A7	Inf. Spell

LIGHTFORCE

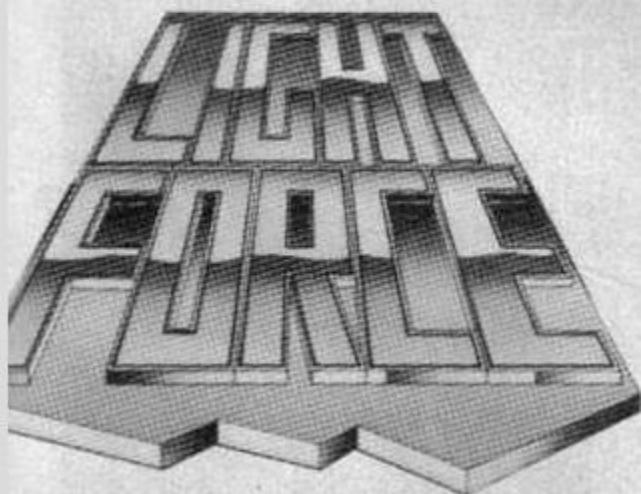

Ross Younger from Edinburgh (how was the festival Ross?) has cast some light on the AA72 cover tape game *Lightforce*. This one gives you infinite lives and invulnerability:

```
(FsAt) 1·'AA72·Lightforce·Poke
(BpAs) 2·'By·Ross·Younger
(AoAr) 10·MEMORY·&7FFF:MODE·1
(OuAp) 20·LOAD"!menu",&8000
(EnAp) 30·POKE·&8760,&C3
(GuAp) 40·POKE·&8761,0
(PkAo) 50·POKE·&8762,&BF
```

```
(MIAn) 60·x=&BF00
(HiAn) 70·GOSUB·90
(HqAo) 80·CALL·&80DC
(LpAn) 90·READ·a$
(FiAw) 100·IF·a$="end"·THEN·RETURN
(AoAw) 110·POKE·x,VAL("&"&a$):x=x+1
(CuAn) 120·GOTO·90
(DqBk) 130·DATA·af,32,da,79:REM·Infinite·Lives
(FuBo) 140·DATA·3e,c9,32,07,79:REM·
    Invulnerability
(BpAx) 150·DATA·c3,31,73,end:REM·Leave!!
```

• Multiface pokes for Lightforce

Address	Poke	Effect
79DA	00	Inf. lives
7987	C9	Invulnerability

ROBOCOP

It's time to give the very popular *Robocop* on tape an outing in cheat form. Rob Scott of Leatherhead in Surrey, who seems to have a firm grip on his speedlocks, has granted infinite time for all those wishing to even things up with the vile Boddicher (I quite like him actually) once again.

```
(CjBi) 10·'ROBOCOP·poke·for·INFINITE·energy
(JsBi) 20·'(c)·1991·Rob·'HANGMAN'·Scott
(AiAo) 30·'··········from·S.t.S·
(EtAj) 40·'
(GqAx) 50·'·Hi·Ratzy·,Squerf·,Jase·B·,Doc
(KvAi) 60·'
(PkAp) 70·FOR·a=ABE00·TO·ABE30
(GuBk) 80·READ·b$:POKE·a,VAL("&"&b$):NEXT
(MxAx) 90·MEMORY·&9000:LOAD"!":CALL·&BE00
(OqAi) 100·'
(DiAw) 110·'Patch·SPEEDLOCK·v90·loader
(AuAk) 120·'
(KkAx) 130·DATA·21,16,BD,36,C3,21,0E,BE
(BvBj) 140·DATA·22,17,BD,C3,C5,99,21,17
(PjAx) 150·DATA·BE,22,4F,A6,C3,08,A6,DD
(BvAw) 160·DATA·21,B9,A8,11,AB,00,C9,40
(EtAw) 170·DATA·A8,21,2A,BE,22,62,A9,C3
(PtAn) 180·DATA·E3,A8
(AsAj) 190·'
(PsAx) 200·'Poke·ROBOCOP·for·infinite·energy
(NuAj) 210·'
(PoAw) 220·DATA·AF,32,23,3F,C3,66,3F
```

• Poke 3F23 with 00 for Inf energy

CHIP'S CHALLENGE

Ross Younger (again, but older this time) of Edinburgh, J Crooks of Belfast and Chris Wilkins of Chariton and Nathan Parton (no relation to Dolly I suppose?) of Ystalyfera, Sam Robinson of Tiverton, Jonathan Hurren of Market Weighton have all sent me a host of four letter words, luckily none of them are particularly rude. They all access levels of *Chip's Challenge*. Apparently the final four aren't available from playing the game, and are extremely difficult to beat. Well done chips... er chaps.



- 1 BDHP
- 2 JXMJ
- 3 ECBO
- 4 YMCJ
- 5 TOKB
- 6 WNLP
- 7 FXQO
- 8 NHAG
- 9 KCRE
- 10 VUWS
- 11 CNPE
- 12 WVHI
- 13 OCKS
- 14 BTDY
- 15 COZQ
- 16 SKKK
- 17 AJMG
- 18 HMJL
- 19 MRHR
- 20 KGFP
- 21 UGRW
- 22 WZIN
- 23 HUVE
- 24 UNIZ
- 25 POGV
- 26 YVYJ
- 27 IGGZ
- 28 UJDD
- 29 QGOL
- 30 BOZP
- 31 RYMS
- 32 PEFS
- 33 BOSN
- 34 NOFI
- 35 VDTM
- 36 NXIS
- 37 VONK
- 38 BIFA
- 39 ICXY
- 40 YWPH
- 41 GKWD
- 42 LMFU
- 43 UJDP
- 44 TXHL
- 45 OVPZ
- 46 HDQJ
- 47 LXPP
- 48 JYSF
- 49 PPXI
- 50 QBDH
- 51 IGGJ
- 52 PPHT
- 53 CGNX
- 54 ZMGC
- 55 SJES
- 56 FCJE
- 57 UBUX
- 58 YBLT
- 59 BLDM
- 60 ZYVI
- 61 RMOW
- 62 TIGW
- 63 GOHX
- 64 LJPO
- 65 UPUN
- 66 ZIKZ
- 67 GGJA
- 68 RTDI
- 69 NLLY
- 70 GCCG
- 71 LAJM
- 72 EKFT
- 73 OCCR
- 74 MKNH
- 75 MJDV
- 76 NMRH
- 77 FHIC
- 78 GRMO
- 79 JINU
- 80 EVUG
- 81 SCWF
- 82 LLIO
- 83 OVPJ
- 84 UVEO
- 85 LEBX
- 86 FLHH
- 87 YJYS
- 88 WZVY
- 89 VCZO
- 90 OLLM
- 91 JPOG
- 92 DTMI
- 93 REKF
- 94 EWCS
- 95 BIFO
- 96 WVHY
- 97 IOCS
- 98 TKWD
- 99 XUVU
- 100 QJXR
- 101 RPIR
- 102 VDDU
- 103 PTAC
- 104 KWNL
- 105 YNEG
- 106 NXYB
- 107 ECRE
- 108 LIOC
- 109 KZQR
- 110 XBAO
- 111 KROJ
- 112 NJLA
- 113 PTAS
- 114 JWNL
- 115 EGRW
- 116 HXMF
- 117 FPZT
- 118 OSCW
- 119 PHTY
- 120 FLXP
- 121 BPYS
- 122 SJUM
- 123 YKZE
- 124 TASX
- 125 MYRT
- 126 ORLD
- 127 JMWZ
- 128 FTLA
- 129 HEAN
- 130 XHIZ
- 131 FIRD
- 132 ZYFA
- 133 TIGG
- 134 XPPH
- 135 LYWO
- 136 LUZL
- 137 HPPX
- 138 LUJT
- 139 VLHH
- 140 SJUK
- 141 MCJE
- 142 UCRY
- 143 OKOR
- 144 GVXQ
- Final sequence: YBLI 146 JHEN 147 COZA 148 RGSK 149 DIGW

INTERNATIONAL KARATE

Carl Surry of Barnet and Nigel Shipp of Kings Lynn have both supplied a keypress tip for the game *IK+* – when your fighter is knocked down, press pause (ESC) then unpause and you will be on your feet ready for action.

HEAVY ON THE MAGICK

Trevor Nunes of Romford has been hard at work casting a spell over the AA72 cover game *Heavy on the Magick*. In order to reach the exit at Collodons Pile, follow these 50 easy steps (pile of what, by the way?):

- 1 Pick up the GRIMOIRE (examine table). Don't get the BOOK OF SPELLS
- 2 Go E,N,N,E,E
- 3 "DOOR, SILENCE" (Door opens)
- 4 Go N (You are now a ZELATOR)
- 5 Go S,W,W,W,N,E
- 6 Blast, Blast and blast again until your opponent is dead.
- 7 Go N,NE
- 8 Pick up NOUGAT
- 9 Go SE,S,S,SW,SE
- 10 Blast, Blast and blast again until your opponent is dead.
- 11 Pick up SCROLL, TRANSFUSION, TRANSFUSION.
- 12 Go NW,NE,N,N,NW,SW,S,W,W
- 13 Blast, Blast and blast again until your opponent is dead.

CHEAT MODE

- 14 Pick up CLASP (you can now walk through fire)
- 15 Go E,S,S,E,E,E
- 16 Pick up SCROLL
- 17 Go W,W,W,N,N,E,N,NE,SE,N,S,W,SW,SE
- 18 Examine TABLE
- 19 Pick up NUGGET, drop NOUGAT, (you can now walk through werewolves)
- 20 Go NW,NE,W,N,SW,SW,E,S,S,NW



- 21 "DOOR WOLF" (Door opens)
- 22 Go N,NW,W,W,S,E,E
- 23 Pick up GARLIC, Pick up BAG
- 24 Go W,W,N,E,NE,SE,SW,E,NE,E,S,S
- 25 Pick up LOAF
- 26 Go W
- 27 "DOOR LUNACY" (door opens)
- 28 Go N, drop CLASP, pick up KEY
- 29 Go SW,W,SW,S,S,NW
- 30 Examine TABLE, Drop KEY (door opens)
- 31 Go N,W, Examine TABLE, Drop BAG (door opens)
- 32 Go N,SW,SE,SW,E
- 33 Examine CHEST, Pick up SLAT
- 34 Go N,NE,W,N,N
- 35 Pick up KEY
- 36 Go E,S,SE,NE
- 37 Wait a few seconds
- 38 Go SW,N,N,NE,E,NE,S,E,N,N,W,SW,W,NE,NW,SW,NW,W
- 39 Pick up KEY
- 40 Go E,SE,NW,SE,SW,E,NE,E,S,S,W,N,SW,W,SW,S,S,NE
- 41 Examine TABLE, Drop KEY
- 42 Go SW,NW,N,W,RIGHT, Pick up KEY.
- 43 Go E,S,SE,NE
- 44 Drop NUGGET, Drop GARLIC
- 45 Go SE,E, RIGHT, Drop BAG
- 46 Go N,SE,S,S,W (the SLAT kills the Cyclops)
- 47 Go W,W,LEFT, Drop KEY (Door opens)
- 48 Go N,SW,W
- 49 "DOOR ELEVEN"
- 50 Go N - THE EXIT.

ESWAT & SHADOW WARRIORS

I have had a barrage of letters from regular tipster William Huddleston of Innerleithen. He brings us these tips for two US Gold coin up conversions. Take it away, William...

● Shadow Warriors

If you're eager to see higher levels, but you're not good enough to get there the hard way, get to the end-of-level guardian and allow yourself to be beaten. When you are instructed to rewind the tape, don't! Instead, press Play - the next level will load.

● ESWAT

Choose the one-player mode, then, when you are about to die press the space bar to select the second guy, you will last twice as long. **AA**



MULTIFACE MARAUDERS

Carl Surry of Barnet, Lee Rouane of Woolley Moor in Derby, Tim John of Copthorne, Nathan Parton of Ystalyfera, Graham Smith of Ware, Matthew Capes of Reading, William Huddleston of Innerleithen, Stephen Troup of Kings Lynn, Stephen Matthews of Kings Lynn, Ken Wood of Blyth and Paul Stuart Williams of Broomhall have all contributed to this bumper (it's not much bigger than normal really) multiface extravaganza.

NAME		ADDRESS	POKE	EFFECT
Shadow Dancer	(d)	2106	A7	Inf. time
		06A2	A7	Inf. credit
		07C0	A7	Inf. magic
Un Squadron	(d)	1C1B	00	Inf. credits
		FE07	A6	Music off
Loopz	(d)	2A6F	A6	Inf. lives
Shadow of the Beast	(d)	2920	A7	Inf. energy
Altered Beast	(t)	09B0	00	Inf. credits
Howard the Duck	(t)	329C	00	Inf. time
Popeye 2	(t)	1767	00	Inf. bonus
Time Scanner	(-)	1211	00	Inf. balls
Sonic Boom	(-)	8CC6	00	Inf. credits
Colony	(-)	2DE9	FF	Cash
Sim City	(-)	3B9B	FF)	Cash
		3C74	FF)	
Airwolf 2	(-)	822B	No.	Lives
Space trader	(-)	659A	00)	No time limit
		659B	00)	or landing tax
How To Be A C B	(t)	13AC	00	Letters stay lit
Cavemania	(t)	1FD6	00	Inf. lives
Gryzor	(t)	1526	A7	Inf. lives
		10DD	00	Invulnerability
Sword Slayer	(t)	14A8	3C)	Invulnerability
		14B6	3C)	
Skweek	(t)	9974	FF	Lives player 1
		9982	FF	lives player 2
Shinobi	(t)	0F62	00	Inf. lives
		3758	00	Inf. time
Captain Blood	(-)	43A3	00)	Reset timer
		43A4	00)	
		43A5	00)	
Power up Compilation				
Altered Beast	(t)	09B9	00	Inf. credits
Star Wars	(t)	4515	00	Inf. Shields
Empire strikes back	(t)	0746	00	Inf. Shields

Using the Multiface...

The (t)s and (d)s before the address indicate whether the poke was written for a tape or disk game (they might work on both, its worth a try). Just in case you don't already how to put in these BLACK BOX POKES, here are the steps to success.

- a) Load the game as normal.
- b) Press the RED button on the MULTIFACE.
- c) Press "T" for tool.

- d) Press "" to make sure you select the code.
- e) Press "H" for HEXADECIMAL input.
- f) Press "SPACE" for input.
- g) Type in the ADDRESS (4 characters ie. 3A7C)
- h) Type in the POKE (2 characters ie. A7)
- i) Press "RETURN"
- j) If there is more than one poke goto (f)
- k) Press "ESC" back to the menu.
- l) Press "R" return to the game.

THE BEST IN QUALITY GAMES

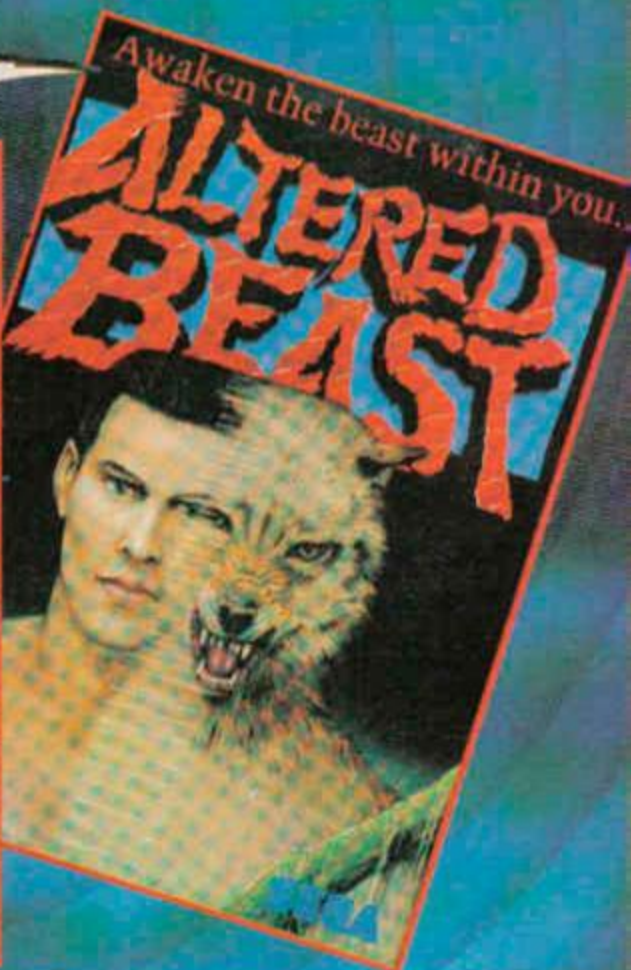

AT POCKET-MONEY PRICES! ONLY £3.99 EACH

ALL AVAILABLE FOR: SPECTRUM · COMMODORE · AMSTRAD

HIT NAMES · HIT GAMES · HIT SQUAD

THE HIT SQUAD · PO. BOX 350 · MANCHESTER M60 2LX

dktronics

64K AND 256K MEMORY EXPANSION

- Simple plug in memory expansion gives instant extra memory.
- Features bank switching software for easy use by the programmer or for use as a data storage area. • Ideal for use with the CPM 2.2 etc.
- The software also features some extra BASIC commands.
- 64K unit expands 464 to 128K. The 256K unit takes your 6128 to 320K!!
- 64K unit brings 464 up to CPC 6128 memory configuration making a much larger software base available. Will work straight off with many programs designed for this unit (including OCP Art Studio - see Ad.).
- Bank switching done automatically by software (cassette 464 - disk 6128).

ONLY £49.99 64K FOR 464

**ONLY £99.99
256K FOR 464 OR 6128 (PLEASE STATE)**

**THE RAM MUSIC MACHINE IS PROBABLY
THE MOST EXCITING MUSIC ADD-ON
AVAILABLE FOR ANY COMPUTER**



MUSIC MACHINE



• It's a full sound sampling system allowing any sound to be recorded digitally into the computer RAM. Once stored, the sound can be replayed at different pitches with many varying effects.

- It's an echo chamber & digital delay line. Create some very interesting effects.
- It's a two voice music/sound synth.
- The Music Machine can also be used as a drum machine - eight drum sounds are already provided for you, but you can easily produce more of your own.
- The extremely powerful software allows you to compose tunes from individual bars of music. You can edit your creations on screen & Save/Load sounds, instruments & rhythms.
- Fully MIDI compatible. The Ram Music Machine supports full MIDI In, MIDI Out &

- MIDI Thru.
- Output through your Hi-Fi or Headphones. Comes complete with microphone.
- Use a full size MIDI keyboard to play the Music Machine.
- Sounds produced by the Music Machine can be mixed with a MIDI synthesiser's own sounds.
- On screen Sound Editor can produce MIDI data from your own compositions.
- Various sampled sounds are provided in order to get you going.
- No other product can offer so much in one unit - it's the TOTAL SOLUTION!!

**ONLY £49.99 FOR THE BEST MUSIC ADD-ON AVAILABLE
FOR THE AMSTRAD**

AMDRUM



• Now you can turn your Amstrad into a real Digital Drum Machine.

- AmDrum from Cheetah Marketing is a superb plug in device that produces "real" drum sounds via its unique digital system.
- On screen menu driven drum kit makes composing drum sounds easy for anyone to do!
- Just plug the output into your Hi-Fi, cassette player, etc. and that's it - your Amstrad is a drum kit!!
- Comes complete with DrumKit Sound plus extra DrumKit and Kit Editor Program (worth £9.99) absolutely FREE!

ONLY £14.99

SPEECH SYNTHESISER & STEREO SOUND BOOSTER

- This easy to use Speech Synthesiser includes a powerful Stereo Amplifier and two pod speakers which are an enormous improvement on the sound supplied by the internal mono speaker.
- Speech output is monorial but directed to both speakers. Booster gives stereo to computer internal sound output.
- Using the SPO/256 Speech Chip the unit has almost infinite vocabulary.
- Text to speech software is provided in ROM to make speech output simplicity itself.
- Voicing is transparent to the user and the computer can carry on with other program tasks as necessary.



**ONLY £29.99
464 OR 6128 (Please state which)**

dktronics

LIGHTPEN/GRAPHICS SYSTEM



- Complete Lightpen and graphics system lets you create a whole range of effects on screen.
- It can magnify, shrink, colour fill and create circles, rectangles, lines and curves.
- Pictures can be edited at pixel level using a scratch pad which magnifies to full screen.
- Picture storage and retrieval, and a pen calibration feature.
- Printer dump utilities for Epson/Amstrad printers supplied (on cassette).

**ONLY £14.99 CASSETTE
OR £24.99 WITH SOFTWARE ON ROM - NOTHING TO LOAD 464 OR 6128 (Please state which)**

HOW TO GET YOUR ORDER FAST!

TELEPHONE [24Hrs] **0782 744707** CREDIT CARD ORDERS

ORDERS NORMALLY DISPATCHED WITHIN 48 Hrs. ALL CHEQUES/POSTAL ORDERS MADE PAYABLE TO...

DATEL ELECTRONICS LTD.

GOVAN ROAD, FENTON INDUSTRIAL ESTATE,
FENTON, STOKE-ON-TRENT, ST4 2RS, ENGLAND.

FAX 0782 744292 TECHNICAL/CUSTOMER SERVICE 0782 744324

DATEL Electronics

L i m i t e d

DATEL Electronics

NOW A TOTAL MOUSE/ GRAPHICS PACKAGE FOR YOUR AMSTRAD AT A TRULY UNBEATABLE PRICE!!

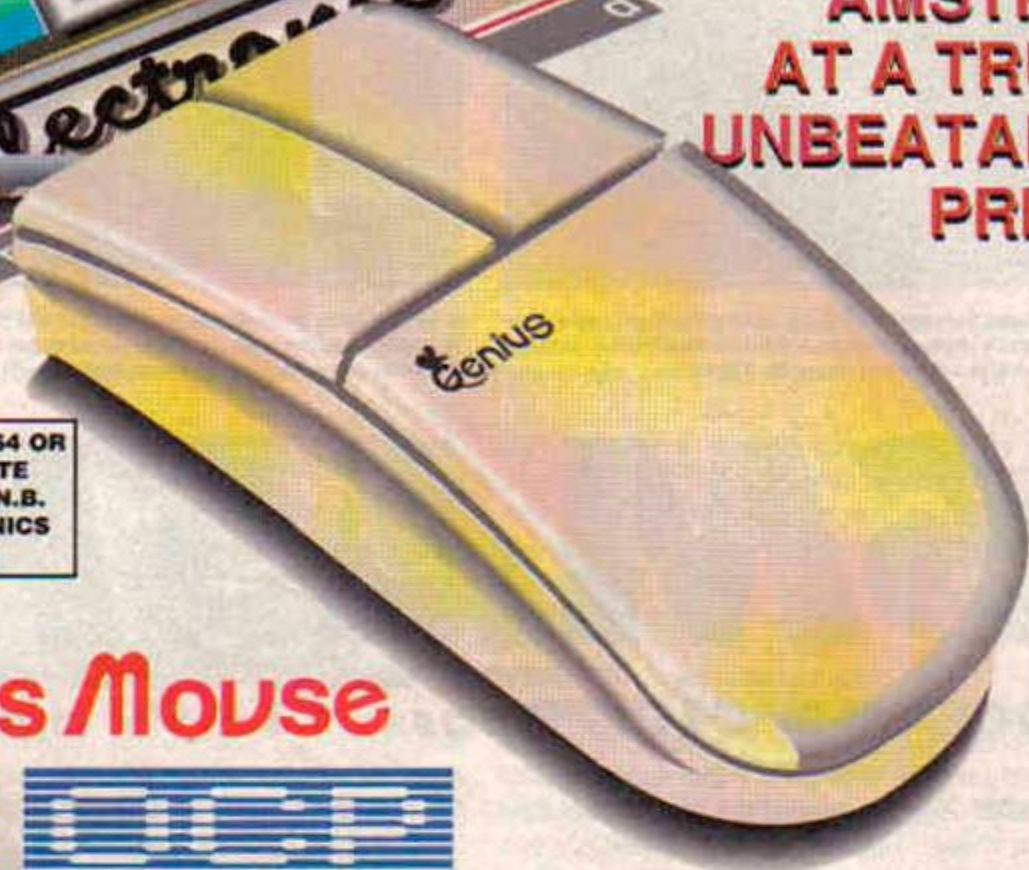

TAPE OR DISK FOR 464 OR 6128 (PLEASE STATE WHICH REQUIRED) N.B. 464 NEEDS DK'TRONICS 64K RAM PACK

Genius Mouse

COMPLETE WITH



- Genius Mouse is a high resolution two button mouse featuring optical counting, teflon guides, microswitches, rubber coated ball and high quality interface.
- When combined with OCP Advanced Art Studio this graphics package is quite simply the best system available. The features are unmatched...
- Create an image - shrink it, expand it, move it, rotate it, copy it, colour it, etc., etc.
- Spray patterns or shades, make elastic lines - stretch and manipulate shapes.
- Zoom in to add detail in fine mode. ● Full cut and paste facilities plus excellent printer support.
- Pull-down/icon driven menus for ease of use. ● Mouse operation, plus joystick and keyboard control.
- 16 pens, 8 sprays, 16 brushes - so flexible anyone can create superb graphics easily.

COMPLETE WITH MOUSE INTERFACE

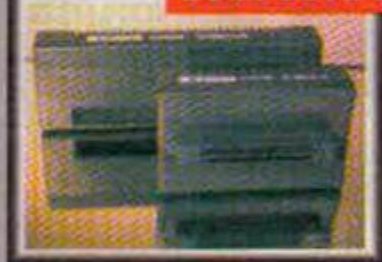

- The Genius Mouse Graphics System comes complete with the special Mouse Interface to allow super smooth control.
- Attractively styled to match your 464 or 6128 design and colour. Simply plugs into Expansion/Joystick port.

ONLY £49.99
TOTAL PACKAGE
INCLUDES GENIUS MOUSE,
INTERFACE, OCP ADVANCED ART
STUDIO PLUS FREE MOUSE MAT
AND HOLDER



FREE!
MOUSE MAT AND
MOUSE HOLDER
(WORTH £12.99)
WITH EACH PACKAGE



NEW LC 200 COLOUR PRINTER PACKAGE

NOW YOU CAN PRINT OUT YOUR PICTURES IN FULL COLOUR!

- The Star LC200 Colour Printer not only prints in Near Letter Quality for your regular jobs but also prints out your pictures from Art Studio, etc., in genuine colour!
- LC200 is a full Centronics printer so it works with other computers (Amiga, ST, etc.).
- Made possible by Datel's unique colour printer driver - now you can have a hardcopy in up to 16 colours!! ● No more to buy - just plug in and print!!

PACKAGE INCLUDES... STAR LC200 COLOUR PRINTER RRP £299.00
CENTRONICS PRINTER LEAD RRP £9.99
DATEL COLOUR PRINTER DRIVER SOFTWARE RRP £19.99
NORMALLY £327.98

COMPLETE PACKAGE NOW ONLY £239.00

COLOUR PRINTER DRIVER AVAILABLE SEPARATELY ONLY £19.99

- If you already have an LC10 or LC 200 Colour Printer we can supply the Driver separately.

HOW TO GET YOUR ORDER FAST!

TELEPHONE [24Hrs] **0782 744707** CREDIT CARD ORDERS

ORDERS NORMALLY DISPATCHED WITHIN 48 Hrs. ALL CHEQUES/POSTAL ORDERS MADE PAYABLE TO...



DATEL ELECTRONICS LTD.



GOVAN ROAD, FENTON INDUSTRIAL ESTATE, FENTON, STOKE-ON-TRENT, ST4 2RS, ENGLAND.
FAX 0782 744292 TECHNICAL/CUSTOMER SERVICE 0782 744324

ACTION TEST



● Here we are, early on in the contest, and there's lots of blokes with baseball bats and fireballs whizzing around. Yikes.



● Oh no, it's the wiggly worms. We've got the fireball gun though, so making minceworm of them is as easy as un, deux, turnip.



● Wooah. We've got the three-way gun, the best power up available. We are buzzin', boys and girls and hippopotamuses. Caralumba!

SMASH TV

OCEAN ■ £10.99 cass, £15.99 disk



SCENE: A game show of the future. *Blind Date* with aliens? *The Price is Right* where you win spaceships and robots? Nah, a bit more violent than that.

Cyberpunk sci-fi movies like *Spacehunter* and *The Running Man* (the best film ever) had the right idea. They depicted a future dominated by violent sport and ultra-violent game shows, like what *Smash TV* is. Just imagine *American Gladiators* with fireballs instead of tennis balls and you're halfway there.

MISSION: You've got to progress from arena to arena, trying to stay alive. Lots of nasty creatures, people, and er, thingies, are going to try and curtail your existence. You start with seven lives (if that sounds like a lot, you're in for a shock).

Extra lives appear every now and then as pick-up objects (hearts), along with loads of different weapons and stuff. Oh, and there's big piles of money, gold bars, toasters, VCRs and other stuff to collect on your way. There's four levels in all, each consisting of around seven or eight rooms.

ANECDOTES: Is *Smash TV* the sort of game

FIRST DAY TARGET SCORE

Beat our hi-scores!

you're going to want to play again and again? Well, here at AA Towers, when we're not actually working (which, of course, is hardly ever), we like to whack on a game and have a bit of a play. The average game'll be on for about five minutes before we get bored and put something else on.

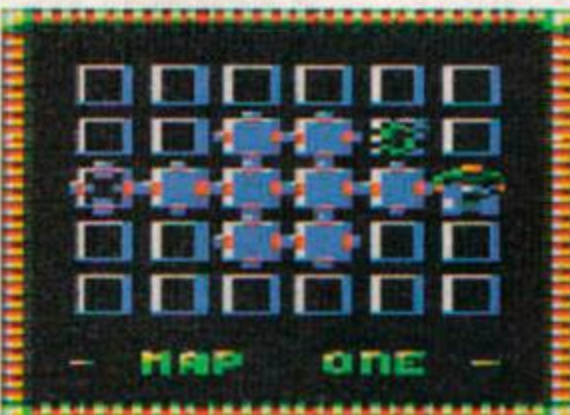

● At the start of each level you get shown a map (a bit like this one here). Er, but they're completely useless. Like platypuses.

Smash TV has been on continuously since we got it. (We don't even bother switching it off when we leave, in case the night-watchman wants a go.) A fair old competition over hi-scores has also developed, with yours truly having recently chalked up a whopping 61,810, smashing Rod's pitiful 56,710 tally. Ha! (Aha! - not so, I just got 62, 610 - ed.)

STYLE: *Smash TV* is a convo of the Williams coin-op, which was in turn an upgraded version

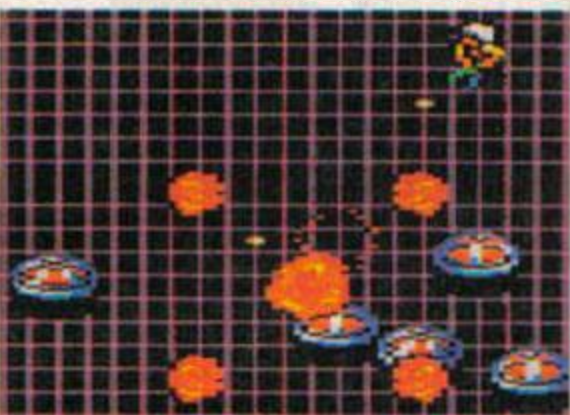

● The safest way to despatch the bad guys is to stand in a corner and fire diagonally. We've got a stunt sprite to demonstrate it above.

TEN FAMOUS TV SMASHERS

1. Adrian Edmondson. *The violent bloke in The Young Ones, Filthy, Rich & Catflap, The Dangerous Brothers and Bottom. He's smashed about twelve tellys, and eaten at least one.*
2. EMF. *Top Brit pop combo, who destroyed televisions in hotel rooms across America on their first US tour.*
3. Nigel Kennedy. *EMF pointed out a telly that had just called Aston Villa a "bunch of *****". Nigel threw it out of the window.*
4. Jeremy Beadle. *Causes hundreds of tellys to get smashed every time he appears.*
5. That bloke who kicked his telly in out of disgust when the Sex Pistols appeared on the Bill Grundy

- show. *He kicked his telly in out of disgust when... (yes, all right - ed)*
6. Arnie Schwarzenegger. *Usually by driving an articulated lorry into a pile of a hundred of them.*
7. That bloke who eats metal and plastic objects. *He's eaten five tellys, amongst lots of other things.*
8. Adam Waring. *Threw a brick at one, because he wanted to watch the tube inside blow up (!).*
9. Adam Peters. *Dropped one from a balcony and two weeks later threw a dustbin at a big pile of them (but we don't talk about that).*
10. Bill Faram. *One of Adam P's mates, who isn't famous at all, but he did smash his own telly in*

because he didn't like the poetry someone was reciting on it (true)! And anyway, he's famous now 'cos you've just read about him. (I think we need to have a little talk - ed.)

EDITOR'S NOTE

Please note that the information on smashing televisions is provided merely for educational benefit. We must stress that *Amstrad Action* in no way advocates or condones such acts of aggression against electrical appliances, whether they be tellys, radios, toasters or curling tongs. It's not big, and it's not clever. Oh, and don't try putting your pets in the microwave either.



● If you've got really bad eyesight, these things will look like trainers. If you've got incredibly bad eyesight, you'll say, "what things?"



● Oh no. It's the stage you always lose a life on. You can't destroy the tanks from below, so die and then run to the top of the screen.



● It's the bald androids and the Parker-Knoll recliners. (Parker-Knoll recliners are sort of armchairs, according to Rod.)

of an earlier coin-op, *Robotron 2084*. Obviously the home computer versions will be no match for the cabinet, which featured four joysticks and action so fast you needed to fire a tranquilliser dart at the screen before you could play it.

Graphically and sonically, though, *STV* is pretty flippin' excellent. There's a wide variety of noises, and the sprites are well good. The main thing about the prog though is that it's fast. If there's a faster CPC game around, we haven't seen it.

HAZARDS: The first thing you'll encounter is a big caterpillar thing. You can't run away, you've got to stay and fight the brute. Even once you've bumped that off, don't bother going for the doors. You have to slug it out with four or five different waves of baddies in each room before you can move on.

As well as caterpillars, you'll also be facing off against blokes with baseball bats, herds of fireballs (keep your wits about you when they

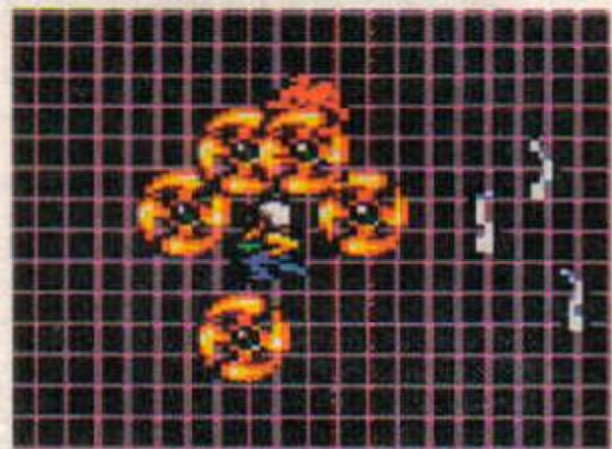

● This weapon causes a ring of big fireballs to appear around you. But they evaporate when you hit something. So be careful.

SECOND OPINION
"Smash TV is blindingly fast. The action is incessant and you can't afford to relax for a moment. A really excellent 'five-minute' game."
Rod Lawton

appear), wiggly worms (Rod's description), big robot eyes, Mr Shrapnels (who blow up when you wax them - look out), robots, armchairs, and lots of equally silly (and equally deadly) things. Crivens!

TIPS: It might be tempting to zoom around like a mad thing in the centre of the screen, firing wildly in all directions. But you won't last long. Better to set yourself up in one of the top corners of the screen, with your gun pointing down diagonally, and give that Fire button a pounding.

It's also tempting (but dangerous) to leave



● Whoops. That fat bloke on the right is Mr Shrapnel. His twin brother's just blown up and killed us. The get.

TEN WAYS TO SMASH A TV

1. Strap it to your head (with gaffer tape or similar), possibly screwing it into your skull to ensure it won't fall off. Then walk under a low doorway.
2. Wrap a West Ham scarf round it, and place it on the home terrace at Stamford Bridge.
3. Disguise it as a sheep and send it to France in a lorry.
4. Throw a frozen rabbit at it, (Linda from *Your Sinclair* thought of this one.)
5. Leave it in a pop star's hotel room, or on the set of an Arnie Schwarzenegger film.
6. Leave it on a pavement in Bath while Maryanne's having a driving lesson.

7. Tell Bernard Manning that it's a new style of chair.
8. Place it in the window of a local electrical shop the night before a poll tax demonstration.
9. Give it to Mike Smith so he can watch telly while he's flying his helicopter.
10. Er, hit it with a hammer. (You're starting to get silly now - ed.)



the relative safety of the corners to collect the power-ups and prizes that pop up regularly. The best of these, apart from the extra lives, are the triangles (which give you three-way fire) and the smart bombs (useful for clearing the herds of fireballs off the screen).

VERDICT: Ocean reckons *Smash TV* is the easiest game it's released for ages. It's certainly easier to progress in than many games, but there's enough rooms involved to present a long-term challenge for even the most battle-hardened of gamers.

The quality of the graphics and sound, and the incredible speed and frantic gameplay, puts *STV* in a class of its own - and a variety of different moves and techniques are required for dealing with the different foes.

Smash TV is the home computer game the home computer market has been waiting for since 1981. Gnarly.

Adam P

SMASH TV VERDICT

GRAPHICS..... **96%**
 Bright and colourful, with super-fast sprites.

SONICS..... **93%**
 Lots of bostin' combat sounds.

GRAB FACTOR..... **97%**
Smash TV is so fast, you get hooked straight away.

STAYING POWER... **95%**
 And you won't get bored in a hurry.

RATING 96%

If the four minute warning was to sound today, this would be the game to load. (Er, except tape owners wouldn't have time.) It's smashing (groan).



● Oh no, it's the limbless Star Wars stormtroopers' brothers. Oh well, stuff them, let's have a sunbathe (ahem).



● Oh hello, it's the neon pink leather jacket triplets. And it looks like the ceiling's on fire. Go, turtle, go! (calm down - ed)



● Yikes, it's a blue troll in red trainers. We don't remember inviting him round. I think I'll sneak out the side door.

TURTLES 2

THE COIN-OP GAME



MIRRORSOFT ■ £11.99 cass, £15.99 disk

We're a fickle bunch aren't we, pop pickers? One minute we're tearing round town with a plastic shell on our back and a green mask, waving a sword and shouting "caralumba!" The next minute we're dying our face yellow, buying a skateboard, instructing people to consume our trousers, and whispering "who were those reptiles sitting opposite us in Pizza Hut, I'm sure I've seen them somewhere before?"



The Turtles, as everyone knows, were last year's things. Today they're just a bunch of sadbos who live in a sewer, and probably smell of wee. So has Mirrorsoft missed the boat then?

Possibly. Last Christmas it gave us the first *Hero Turtles* game, a passable little shindig it knocked up itself. This time we get a conversion of the popular



● Kerpow! Feverish two-player action as Pepperoni and Cornetto take to the streets.

SECOND OPINION
"There's not much variety and there's not much gameplay - but here you don't need it! Incessant action and terrific fun, especially in two-player mode."
Rod Lawton

Konami coin-op. And it's not at all bad, actually, thanks for asking.

It's a sideways scrolling, horizontal, ninja beat-em-up sort of thing. You take command of either Titian, Botticelli, Giovanni or Macaroni, and kick, jump, jab and skewer your way through streets, houses, sewers and car parks, killing all the dayglo villains that cross your path.

Each hero has his own weapon, be it a sword, a stick, a trident, or, er, another sword. (It would be a num-chucka, but they've been banned after loads of kids wiped out their neighbours with homemade ones.) All the weapons work in exactly the same way (i.e. skewering the opponent and throwing them over your shoulder). They just, er, look different, that's all.

Fact fans, take note: There are precisely five reasons why *Turtles 2* is a brilliant game (a Mastergame, in fact).

Firstly, the graphics. The sprites might not be a match for *Final Fight* in the massiveness



● Bandera's a brave chap isn't he? Taking on all these bad dudes with only a broken twig in this way of weaponry. Daft berk.



● Ooer, it's that Joanna Lumley *New Avengers* kick. You'd better duck, Papparazzi. Looks like everyone else is just watching.



● Ha ha, two purple chaps fly through the air. Time to sing the turtles song; "We are Turtles, yo! It's a ninja fighting show. Er..."



● Watch out for that purple chap. He leaps out of the manhole and lobs the cover at you. The orange bloke with the laser's a get too.



● Down in the sewers and even the smell of dead rats isn't enough to prevent the baddies from continuing to hassle you. The rotters.



● Caralumba! It's Armani, leaping through the air, slashing enemies and hacking down foes in his wake. Er, when they show up.



● Pavarotti, Macaroni, De Niro and Warhol - choose your favourite small crusty one.

stakes, but are certainly large enough to satisfy all but the most maniac of appetites. The backgrounds are suitably detailed, atmospheric and varied, and the animation is very smooth and cartoon comical.

Then there's the variety of moves. In reality, there's only three or four different moves you can make to actually cause any damage, but in between them you wave your weapon round your head, leap through the air, and do all sorts of other stuff that looks really good (but



does bog all).

Thirdly, there is such

a lot to do. There's fifteen sub levels to work through, and, even when using the patented AA cheat (pressing Fire to bring the second player on to screen just before the first one dies), it's still going to take a lot of waggling and burning of the midnight oil before you get to finish it (if you ever do). But hey, remember, that ever-so-interesting chemistry homework comes first...

Reason number four - the end-of-level guardians. In most games nowadays these are crap. Complete flippin' wimps. In *Turtles 2* they most certainly ain't. They start tough, and get tougher. The machine that poos aliens out of its bottom is a particularly nasty specimen.

The final and most important reason for *Turtles 2* being so fab? The two-player option. This really makes for corking two-player action. Take control of a green 'n' brown one each and double team, to really give those bad-guys something to think about ('cept there's more of them than usual, the swine). The Commodore 64 version doesn't have a two-player option, so when that obnoxious C64 owner in your life starts prattling on about how much better than the CPC their machine is, instead of thumping them in the eye as usual, just offer to give 'em a game of this on your Amstrad instead. Then watch them crawl away, blubbing like a baby. Ha ha ha.

To sum up, *Turtles 2* is brilliant. If you don't buy it, you just don't deserve to own a computer!

Adam P

FIRST DAY TARGET SCORE

Oh look, just enjoy yourself

**TURTLES 2
VERDICT**

GRAPHICS..... **94%**

Very lovely indeed. You can tell these green chaps are painters.

SONICS..... **69%**

Not much going on here, really. But who cares?

GRAB FACTOR..... **87%**

Just fly in, and start jabbing those bad guys.

STAYING POWER... **93%**

Two-player option for a fun-packed Christmas Day.

RATING 91%

Turtles 2 has everything - graphics, gameplay, fun, and a full-size model of the Eiffel Tower. (Er, the last one was a lie.)

TURTLE RECALL

So what are the Turtles getting up to then, now that everyone's forgotten about them? We sent ADAM PETERS down the sewers to talk to Cannelloni and Matisse about their lives, their loves and their somewhat ephemeral (look it up) careers...

Adam: Hello... (cough, splutter)... anyone down here? Blimey, what a stink!

Cannelloni: Caralumba!

Matisse: Caralumba from me too!

Adam: Yikes, you scared me!

Cannelloni: Sorry dude. Yo, have some pizza.

Adam: Mmmpff... yeuk... thanks, but I've already eaten.

Cannelloni: No man, have some pizza. It's great! Hey Matisse, caralumba, it's pizza time!

Matisse: Haven't you got any buns?

Cannelloni: What are you talking about dude? Have some pizza, it's crucial! Mmm...

(crunch)... yerk, it's a bit hard.

Adam: Er, I think you're supposed to cook it after taking it out of the freezer.

Matisse: A patty would be nice.

Adam: Erm, right. First question - why do you live in a sewer? No doubt it's something to do with the housing crisis, twelve years of Tory misrule, Rachmann-like landlords, and all that sort of stuff?

Cannelloni: We've got some more pizza in the other room if you want some.

Matisse: Wish I was back in Hull. They do some really great patties up there.

Adam: Er, so what are you lot getting up to now? I've heard there's going to be a third film. What happens in that then?

Cannelloni: Dunno.

Matisse: We probably fight some baddies or something like that.

Cannelloni: Yeah. Caralumba!

Matisse: Teenage Mutant Hero Turtles 3 - The Turtles Visit Hull And Have Some Buns.

Cannelloni: And we all grow beards in it.

Adam: Hang on a minute, none of the Turtles came from Hull.

Matisse: Er, Caralumba! Have some pizza, dude! Yo, caralumba dude!

Adam: And none of them have beards either.

Cannelloni: Yikes.

Adam: And what's all this green paint on the floor? You're not the Hero Turtles at all, are you... you're Rod Lawton and Adam Waring all dressed up.

Matisse: Er, got to dash.

Cannelloni: Yeah. See you.

Adam: Yeah that's right, run off. Trying to con the kids like that, you should be ashamed of yourselves! Run away in shame. Run right up that ladder and shut that manhole cover after you... (Pause.) Er, hang on, I can't open the manhole from down here. Lads...? Great joke, lads... Er, lads...?

SUPER SIM PACK

US GOLD ■ £17.99 cass, £24.99 disk

Tennis, football, car-driving and bomb-dropping galore in US Gold's tenuously linked compilation. ADAM P laps it up



AIRBORNE RANGER

Here's a corking little shindig. You're a sort of marine, and you get dropped out of a plane into enemy territory (having dropped three Supply Pods out of the plane first). You've got a gun sight on screen, which you have to position over things and then press Fire to shoot them.

There's a massive selection of missions (well, twelve), and you've got a selection of weapons (carbines, grenades, time bombs, knives, etc) at your disposal. Graphics are all in four-colour mode (mode 1), and scrolling is fairly slow, but neither of these really detract from the gameplay at all.



Airborne Ranger is an excellent combination of arcade shoot-em-up action and war gaming tactics. The instructions are admirably detailed (twelve pages of them) and the whole thing is excellent to have handy, for either a short burst of blasting or a long-term challenge.

● Wandering through the snowy wastelands, shooting at people. (Beats pottery any day.)

CRAZY CARS II

Now here's a game that looks really smooth. The graphics are excellent, though perhaps a tad slow, and the sound effects are brilliant (police sirens building and fading as the rozzers pass you, etc). It's a drive-em-up with a difference. You're not on a racing track, you're just haring round America for one reason or another.



Cop cars cover your route, and try to block your way so you crash into them (great policing, huh?). You need to feint one way then whizz past on the other side. There's also lots of barriers and lamp-posts, but you can't get past them by feinting.

You can also pop off the road briefly, and one of the best bits is spinning off the road, then whizzing back on without hitting a lamp-post. It's great. There's also some flashing lights and numbers at the top of the screen that mean something, but don't worry about them. We don't.

● Oh no, a cop car. And you're not allowed to ram it.

ITALY 1990

Simulate being at a football match in your front room. Turn off the central heating, open all the windows, get five mates to stand on the exact same spot as you, get someone to wee on the floor, drop bits of beefburger on your shoes, and then load the best computer footie game on the Amstrad ever. Yep, this one.

There are three things to look for in a computer footie game - speed, passing control and team selection. *Italy 1990* has plenty of speed, a lot of team features (selecting players, editing player names, bringing on substitutes, choosing formations, etc), but a slight lack of passing.



It's one of those kick-and-rush types, but at least you won't get bored in a hurry. Any lack of tactics are more than made up for by smooth scrolling graphics and whizz bang speed. Play a one player game, a two player game, or go for a full length world cup tournament. Soccerbunga!

● Here we go, here we go, here we go (etc)...

INTERNATIONAL 3D TENNIS	73%
CRAZY CARS II	78%
ITALY 1990	89%
AIRBORNE RANGER	91%

84%

"Three pretty unique games, plus the best footie prog around. A darned good compo all in all"

Adam P

● OK, so the players don't look too good, but it is genuine 3D.

SECOND OPINION

"A good bunch of games. The link between all four as 'simulators' is a bit dodgy, but what counts is the quality of the software - Super Sim Pack delivers."
Rod Lawton

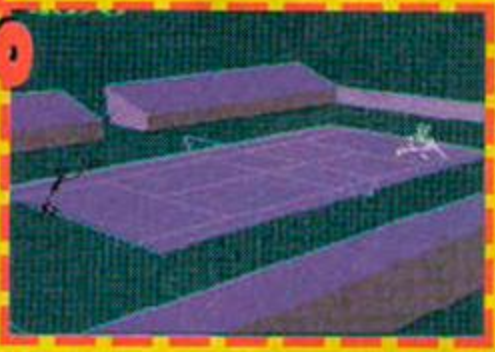

INTERNATIONAL 3D TENNIS

This is the weirdest sport sim ever, as far as appearance goes. The two players appear as gangly, wobbling stick men, moving around in a super clumsy way, flailing at the ball. The movement is bio-dynamically correct, but the whole thing does look incomparably daft.

It's very derivative of the Freescape style (as displayed in games like Driller and Castle Master). You get an option on which angle you wish to view the court from, and you get a very 3D-looking scoreboard. There's an option on whether to play a single game (one or two player), a tournament, or a whole season.

The controls are easier to get to grips with than most tennis sims, and it has a heap more playability than you'd expect. It's a great game, though hardened gamers might view it with a little suspicion.

NEW - 3.5" SUPERDRIVE - £79.95

★ 800K STORAGE PER DISK ★ FREE MS800 or FREE MAXIDOS - YOU CHOOSE

We were the first to bring the 3.5" drive below £100
We were the first to bring you the Dual-Mode 3.5" drive
We were the first to give you 800K software - free!
And now we are the first to bring you the SuperDrive.
Others may follow but WE LEAD THE WAY

The SuperDrive is still the most reliable (TEAC), still the most compact, still the quietest and still has the best free software. It is still Dual-Mode and, because no additional software is needed to store up to 800K per disk (MS800 is free), it is still the lowest cost 3.5" CPC drive!

NEW - a set of 5 indicators display the various states of the drive. Some are used immediately and some are for further expansions - see FEATURES.

The SuperDrive is ready to plug in and use. Nothing else is needed except a few blank disks. Please state 464, 664, 6128, 464+ or 6128+.

SuperDrive.....£79.95
plus £3 p&p

N.B. This drive is not suitable as a 464 first drive.

FEATURES:

- ★ 800k per disk when used with MS800 (free), RAMDOS, ROMDOS or Rodos
- ★ Low cost disks
- ★ DUAL-MODE. Mode 1 - SuperDrive is a complete alternative B drive Mode 2 - It is also a megadrive (800k per disk)
- ★ LEDs indicate which disk side is in use (3.5" disks don't turn over)
- ★ LEDs show whether it is selected as the A or the B drive when used with our ABBA SWITCH² (not DeCable) which plugs onto the disk drive port to allow the internal (A) and the external (B) drives to be switched around
- ★ LED shows when the drive is selected - active when used with our 3rd DRIVE SWITCH² which plugs on to the disk drive port and allows the connection of 2 external drives, only one of which can be in use at any one time. The switch selects which one. Can be switched while the computer is turned on so B to B copying can be done.
- ★ SIDE SWITCH switches the disk side and permits mode 1 operation
- ★ PSU is external and easily replaced should the need arise. The alternative is an internal PSU and a costly, specialised repair.
- ★ COMPATIBLE with all 800k software
- ★ COMPATIBLE with almost all computers. The SuperDrive can go with you if you change computers. Only a different connector or lead is needed.

²The ABBA and 3rd DRIVE switches are optional extras (£10.95 each) and do not need to be used. To accommodate possible future needs, their LED indicators are fitted to the SuperDrive as standard. The switches are available for the 664, 6128 and 6128+ computers and will shortly be available for the other CPC's.

NEWS

Oh dear. There's nothing much in the way of news to report this month so I'll just start to type and see what the old grey cells produce.

The bulletin board info was a bit screwed up last month and those who tried to log onto Supe's Motel at 300 and 1275 must have wondered what was happening. Hopefully it will be corrected below.

Supe's Motel 0274 602180 1200-2400
Smallest BBS 0905 613968 300-2400
Clapham Junction 0234 364261 1275-2400
Preston ROS 0772 652212 1275-2400
all are BNI, scrolling.

PD - A PERSONAL VIEW

Almost all PD libraries are run by youngish people who, for some reason, open a PD library as a part of their computing hobby. They want our custom and sometimes vie with each other to be the cheapest PD library around. However, they don't make a profit or, if they do, it is small and very well deserved for the excellent service that they provide. Their main reward is the good feeling that they get in providing their services.

I would like to think that we don't even look at their charges, as long as they are within acceptable limits, but that we try to encourage those people, especially the youngsters, by using many libraries instead of sticking to one or two. So, if you see a new one, write for the list and buy something. Remember, the more people that are out there helping us, the better off we all are. If you aren't a PD user - become one. There's plenty of good stuff for you in the libraries. And whilst we're on the subject, here's another new one for you.

PISCES PD has come up with a new idea. Paolo Cuomo is out to save everybody a bit of money by providing software on the cheaper 3 1/2" MS800 formatted disks as well as on 3". Using MS800's unique '4 sided' disk format (I don't mind giving myself a free plug!), he can supply 4 full sides of PD on one 3 1/2" disk. For full details and sample programs, send a 3" disk and s.a.e. to Pisces PD, c/o Paolo Cuomo, Century Cottage, Bronley, Faversham, Kent, ME13 9LL.

ADVENTURE COMMS

Adventurers who are into comms run the risk of being turned into piglets if they don't log onto Cece's Cornucopia, Anne Roy's new adventure BBS. So take no chances and dial 0563 395999 between 8pm and 2am. 1200 and 2400 BNI scrolling. (say Jennifer sent you).

WACCI LATEST

Subscribers to WACCI will have wondered why the fanzine hasn't appeared for several months and if it will ever appear again. I can report that the WACCI that was, with Steve Williams at the helm, fell into insurmountable difficulties causing it to fail. But because most WACCIites want the fanzine, Clive Bellaby has taken on the task of its production and at his own financial risk. It's a daunting task and I don't envy him one bit but he does need the support of subscribers so he would like all current subscribers to send a stamped addressed envelope to him for details of what did happen and what will happen with WACCI. Clive Bellaby, 12 Trafalgar Terrace, Long Eaton, Nottingham, NG10 1GP. 0602 725106.

PHONE YOUR ORDER TODAY GOODS DESPATCHED TOMORROW phone Mon-Fri, 2pm-6pm

MS800 - the standard in 800K storage - £9.95
(supplied free with the SuperDrive)

MS800 enables the Dual-Mode disk drive to store up to 800K per disk. Since we introduced it earlier this year it has become the best selling software of its kind by far. So much so that many people have converted their earlier 3.5" drives to dual-mode capability and switched to MS800. As one user put it "...MS800...knocks spots off Rodos" and we have had similar comments concerning the other alternatives.

FEATURES INCLUDE:

360K, 400K or 2 x 180K per side; compatible with CPCs, PLUSes, CP/M+, MFII, Stop Press, etc.; 64 or 128 directory entries; verify disk; disk copy; file and batch copy; unlike all alternatives, each disk initialises the computer for its own format without using up any of the storage space! Once a disk has been formatted, MS800 itself is not needed.

Formatting up to 400K on each side needs a SIDE SWITCH on the drive. Our drives already have one but for £3 we can supply a kit and instructions - suitable for 80 track, double sided 3.5" or 5.25" disk drives.

MAXIDOS (with free PROCOPY) £13.75
THE MOST COMPREHENSIVE & EFFECTIVE GENERAL DISK UTILITY AVAILABLE FOR THE CPC

Fully compatible with RAMDOS, ROMDOS, AMSDOS and CPM formats! COPY files/disks; VERIFY disks; RESURRECT erased files; FAST FORMAT Amdos/Ramos/Romdos; IDENTIFY format; CAT files (inc. erased ones) optional status/address/length/etc; alter USER AREAS, make/unmake system or read only; DISPLAY or PRINT files... AND MUCH MORE! BEST SECTOR EDITOR EVER for the CPC. All standard editing facilities PLUS FILE MAPPING to screen or printer, auto step by step movement through a file, string and byte SEARCH through file/disk FILE ARCHIVER backs up disks to tape; variable baud rates. SPEED UP YOUR DISKS! unique OPTIMIZE re-arranges your 'crowded' disks, making them load up to 50% faster.

BONZO SUPER MEDDLER £13.75

now includes the BONZO HACKPACK - free! The most comprehensive tape to disk utility. Supplied on disk with a huge database of verified transfers. Produces stand-alone transfers. "A real alternative to a Multiface" - *Amstrad Action* "The best tape to disk transfer utility available" - *WACCI*

BONZO BLITZ.....£13.75.

now includes BONZO'S DOODAH and 4 adventure games - free! Tape to disk transfers. Deals with all forms of Speedlock. Works on all CPCs. Huge database of verified transfers.

BONZO's BIGBATCH.....£10.00

Fast, flexible DATABASE, superb FOOTBALL POOLS PREDICTOR plus a user-friendly, memory saving SCREEN & SPRITE DESIGNER.

BONZO's FLASHPACK.....£10.00

"The best all round BASIC extension program" *WACCI*. FLASH BASIC adds about 70 extremely useful RSXs to use in your BASIC programs but the resulting programs will run on any computer without the presence of FLASH BASIC. Includes a database and other excellent example programs.

6128 ROMS£24.95
includes fitting instructions

FILE TRANSFERS -

cpc TO/FROM PC's, PCW's and Others

2IN1 - £24.95

Moonstone's 2IN1, the Rolls-Royce of CPC/PC file transfer utilities, not only allows the transfer of files by copying to and reading from PC disks but it also allows the same data disk to be used in both machines. FORMAT, COPY, CAT, IDENTIFY FORMAT etc. PC disks on your CPC. Full range of utilities - fully menu driven. When compared to the rest AA said "Quite simply, it knocks the competition into a cocked waste paper basket".

MFU - £29.95

Transfers files easily to and from PC's, various CPM format machines (e.g. PCW), BBC's, Osborne and other computers; Its PC transfer is the basic 2IN1 program but without all the facilities. When MFU's PC transfer capability was compared with all the alternatives (except 2IN1), it was judged by AA to be "head and shoulders above the rest".

GENERAL

If you just want PC transfers then 2IN1 is by far the best. If you also need transfers to/from the other machines, then MFU is the one to have. Both programs run in CPM+, not in CPM 2.2.

OTHER ITEMS

64k DKtronics RAM PACK	38.99
FD1 DISK DRIVE (See below)	54.95
RAMDOS (disk)	19.95
ROMDOS (rom)	29.95
6128 ROM	24.95
3.5" DISKS (branded bulk)	10 for 7.50
.....	30 for 20.00
3" DISKS (Amsoft)	10 for 20.00
3.5" DISK BOX lockable, holds 40.....	7.00
PRINTER LEAD (CPC or PLUS) 6'	8.00
ABBA Switch.....	10.95
3rd Drive Switch	10.95

Please add £3 p&p to disk drives
FD1 - state 464, 664, 6128 or 6128 PLUS

**32k RAMROM
£13.95!!**

The RAM that thinks it's a ROM is a little gem. It is 32k of RAM which can be loaded with 1 or 2 (yes two!) ROM programs. After which it behaves exactly like 1 or 2 ROMs. It plugs onto the computer so a romboard isn't needed. You can select a rom slot for each 16k bank or choose to have both banks on the same slot switching between them at will. Complete with through connector and type-in software, it is now available for an amazing £13.95. Send s.a.e. for fuller details or a cheque to get yours now.

**464 PLUS/6128 PLUS
ADD-ONS**

Bonzo Blitz See Above
Bonzo Super Medler See Above
32k RAMROM..... See Opposite
FD1 3" B drive (464 & 6128)..... £59.95*
3.5" B drive (464 & 6128)..... £79.95*
See above for full details

Printer lead (6ft)..... £8.00
Plus to edge adaptor..... £8.50

Allows CPC add-ons to be used on the PLUS computers

*Please add £3 p&p on disk drives
PLUS OWNERS WATCH THIS SPACE

We will add more items for your computer as quickly as we test them.

VISA

MICROSTYLE

MasterCard

Access

DEPT. AA, 28 BELMONT AVENUE,
LOW MOOR, BRADFORD, W.YORKS
BD12 0PA. Tel: 0274 602180 (2pm-6pm).

Prices include VAT and carriage unless otherwise stated.



Balrog

Armed with a 3-inch disk and a pen and paper the Balg casts his critical eye across the adventure club scene as well as all the usual features...

Adventure Clubs Update

In AA55 the Balg reviewed the various adventure clubs available for Amstrad Owners. Since then *Spellbreaker* and *Harlequin & Steel* have gone bye bye (although *H & S* was only around for one issue - it was very mediocre and too expensive), *ACL* has changed owners (and name!) and *Confidential* has become 16-bit only.

The Balg is constantly hearing of new clubs starting up but usually they don't get past their first issue before the new editor realises how much work is needed! (I'm sure Rod will agree as an editor!) Anyway here are the major adventure clubs around at the moment:

Adventurers & Strategy Club
£24 per year, £14 for six months ● Editor Sue Roseblade ● 17 Sheridan Road, London E12 6QT (081 470 8563)

The *Adventurers & Strategy Club* is the new name for what was *ACL* - but don't be put off - the ownership and editorship has changed as well! This fact should be stressed because the old club got much bad press due to the antics of Henry Mueller, the editor/owner.

The club is different from the others in that it doesn't produce a regular magazine. The annoying thing with magazines is that you spend ages searching through piles of the things before you find the article/issue you want. Instead, *ASC* produces a bi-monthly pack of loose sheets which can be put into a binder, thus creating a reference book of adventuring.

It should also be said that since the change in ownership, the packs are much bigger and arrive on time! *ASC* caters for all formats so unfortunately the CPC isn't mentioned much, but the mag has the advantage of no adverts and the reference book approach. It's expensive, but could prove indispensable in years to come especially if you plan buying another computer.

Adventure Probe

£1.50 per month ● Editor Mandy Rodrigues HBalg ● 67 Lloyd Street, Llandudno, Gwynedd, LL30 2BN (0492 77305 at any reasonable hour!)

The longest-running adventure magazine (over five years now!), *Probe* (as it is affectionately known) is more of a group of friends than a formal club and as such has a lovely chatty atmosphere. As well as a comprehensive monthly magazine *Probe* offers an adventure solution database for hundreds of games as well as a helpline and clues. It caters for all computer formats but has a strong Amstrad following.

By the time you read this the second *Adventure Probe* convention will have taken place (Hi! to everyone who went!) and if it's anything like last year it will have been great!

Probe just has to be the Balrog's favourite adventure magazine - go and buy a sample copy today!

Adventure Coder
£1.00 per month ● Editor Chris Hester ● 3 West Lane, Baildon, Near Shipley, West Yorkshire, BD17 5HD

Adventure Coder has gone through some changes since it was last reviewed. It is now 8-bit only (none of those boring Amiga and ST articles) and bi-monthly. However, the content of the magazine is still the same - the discussion of writing your own adventure games.

As well as general articles there are sections covering *GAC*, *Quill*, *ADLAN* and *PAW*. *Adventure Coder* is a great little magazine but has been having troubles recently with new material (no material = no magazine) so if you have any ideas then get writing to Chris!

NEWS...NEWS...NEWS...

Recreation Re-creation closed

The Balg has received several complaints concerning RR not responding to orders/letters. It seems that Mark Eltringham, head honcho at RR, has disappeared from the adventure scene completely so please DO NOT ORDER ANY GAMES FROM RECREATION RE-CREATION UNTIL FURTHER NOTICE! If Mark would like to please get in touch with me I would be grateful.

** STOP PRESS **

Two of *Recreation Re-creation's* ex-authors have clubbed together to save the games catalogue of RR. Tony Collins (author of *The Hermitage* amongst other games) will sell the disk versions and Peter Knowles will sell the tape versions. However, the new company will have nothing to do with RR and so no money will be refundable. Tony Collins can be contacted at: 760 Tyburn Road, Erdington, Birmingham B24 9NX, Tel: 021 749 2585 and Peter Knowles at 153 Standhill Crescent, New Lodge, Barnsley, South Yorkshire S71 1SW, Tel: 0226 292141.

Covertape news

Hopefully the January covertape will have some interest to adventurers. At the moment the Balrog can't say much more (Rod's sworn me to secrecy!), but it will not be an adventure game...

CONTACTING THE BALG

To get in contact with the Balg, write to him at Amstrad Action, Future Publishing Ltd, Beauford Court, 30 Monmouth Street, Bath, AVON BA1 2AP.

Balrog's Cluepot

Thanks this month to Mark Conmy (Strider), Dave Cox, Alistair Crook, Adrian Forbes, Dave Harvard, Ben Isba, Peter Knowles, Amir Mansour, Chris

Morgan, Pamela (who wants to remain anonymous) and Edmund Spicer for all their clues – may they adventure long and prosper!

Al-Strad

- Give banana to monkey.
- Give penny to shopkeeper.
- Choose 'bridge' game.
- Examine case.

Astral Plain

- Go round the compass anti-clockwise starting at north.
- The shadow wants the staff.
- The adder wants an abacus.
- Stand on the pentagram.
- Give the lamb a drink.

Colossal Adventure

- Wave black rod at chasm.
- Free the bird to scare the snake.

Escape from Planet of Doom

- Knock on door.
- The key can be used more than once.
- Buy ticket with silver.
- Give custard to monster in custard shop.

Fourth Protocol

- Eileen Growes has come to the aid of Andy Ridding's problem – the answers are Fingerprint, Gaza and False Flag.

Heroes of Karn (especially for Steven Haddon)

- Water ashes to prevent the phoenix from returning.
- Get Beren to attack the bat with the falcon.
- Get Khadim to kill the pirate with the dagger.

Hitchhiker's Guide to the Galaxy

- Put the dangly bit in the real tea. Turn the generator on and wait until you can feel.
- Put all the fluff in the flowerpot. Wait until you see a shoot and then go in Sauna.
- Eat the fruit to find the correct tool and go and ask Marvin to fix the hatch.

Knight Orc

- To get in and out of the castle without opening the drawbridge 'tie rope to ivy'. You can now go up and down as you please.

Clue Cauldron... Bloodwych

Thanks go to Adrian Forbes and Chris Roberts for a veritable overdose of clues for this brilliant roleplaying game:

- Make a good map, make sure you explore EVERYWHERE and have stood on every place possible. Also note down the colour of the locks on the doors so that if you find a key then you'll know what it unlocks.
- If you still can't get off a level, then cast the blue spell that allows you to see illusions (*I seem to remember it's TRUVIEW - Balg*) then go through the whole level again. If you see a difference, then select a member without a spell and if a wall suddenly appears then it is an illusion.
- If you see a gem socket with no gem in it and you have a colour gem, then put the gem in the socket as it is likely to be a teleport. If you are teleported, take the gem back.
- Watch out for the annoying minefields – these are long corridors that you have to pass over, but standing on specific squares teleports you somewhere else (usually to the start of the corridor). Stand on every square you

can and mark down on your map whether it is a teleport or not and you will build up a path through the 'minefield'

- If you ever come across a door that when opened presents a T-junction with a green 'grid' at the cross over point then save your game before you step forward onto the grid as it is likely to take you to the next level. If it does but you haven't fully explored the current level then just re-load your party because when you stand on these squares there's no way back... Also be cautious going through the doors with black locks – nine times out of ten they will close behind you. Again, make sure you have fully explored the current level before you pass through.
- It is handy to have snake slime in the transfer slot when in combat so that you can quickly give it to someone to drink.
- Blaze or Firepath are great spells to cast when you see advancing enemies, it will knock down their constitution considerably before they even get within striking distance. Be careful when casting Blaze, though – some squares won't accept the 'firepath' and the fireball will just bounce around until it hits something (probably you!).

- To get the rope through the ring, tie it to the spear.

Lurking Horror

- Throw the contents of the flask at the curtain of slime when you first see it, i.e. before you approach the wall.

Wise and Fool of Arnold Blackwood

- At gravestone with chilling message: dig grave, unscrew coffin, get crowbar, get coffin, open trapdoor with crowbar.
- Launch the coffin in the sewer.

Wishbringer

- Look under the seat in the cinema.
- Read the letter after your boss has opened it.

Wolfman

- Part 2: To stop David, the wolf, from killing you, you must go to your bedroom, strip, close curtains, enter bed and kiss David. Play dead to fool guards. On the castle wall, creep up on guard.
- Part 3: When Nardia gets cold type 'Nardia cloak'.

HELP!

If you're really desperate for help in an adventure and no-one else can help you then write to the Help section at the usual address, if possible enclosing some contributions for Cluepot and Just for Laughs whilst you're at it!

Smashed

David Broughton is stuck in his first adventure – he can't rescue Clingon, get into the Sergeants' mess, drive the jeep, get the pearls or get the oil. Can anyone help?

Knight Orc

Chris Morgan is desperate for help, so desperate in fact that if he doesn't get any soon he will



Chris Morgan needs help in Knight Orc – if he doesn't get any he may pack in adventuring for good!

hang up his adventuring cloak forever (steady!). He has collected the halyard, noose, line, hawser, cord, tether, lasso and horse's reins and yet his rope is still too short – where are the rest of the rope pieces?

LORDS & LADIES OF ADVENTURE

Once again six expert adventures offer aid to the needy. As always don't forget to send an SSAE or your query won't be answered...!

Bard's Tale • Hitchhiker's Guide • Hobbit • Lord of the Rings • Pawn • Shadows of Mordor.

David Nicholas, 23 Houghton Lane, Sancton, East Yorkshire YO4 3QU.

Adult II • Can I Cheat Death? • Doomlords • Firestone • Jason and the Argonauts • Roog • Spacey • Tizpan.

Adam Maxwell, 9 Peth Green, Hetton-le-Hole, Tyne & Wear DH5 0EY.

Base • Hollywood Hijinx • Infidel • Island • Spiro Legacy • Test • Wishbringer • help for PAW programmers.

Ken Bond, 17 Adel Park Gardens, Adel, Leeds, West Yorkshire LS16 8BN. (0532 672278)

Adventure Quest • Dungeon Adventure • Gnome Ranger • Imagination • Knight Orc • Kobayashi Naru • Jewels of Babylon • Lancelot • Lords of Time • Mystery of Indus Valley • Price of Magik • Redmoon • Return to Eden • Shadows of Mordor • Snowball •

Souls of Darkon • Venom.

Wendy Watters, 82 Booth Road, Stacksteads, Bacup, Lancashire OL13 0SF. (0706 877518)

Classic Adventure • Fantasia Diamond • Hobbit • Hollywood Hijinx • Inca Curse • Mountains of Ket • Planet of Death • Sorcerer.

Dave Havard, 21 Belvoir Close, Fareham, Hants PO16 0PJ.

Forest at World's End • Jewels of Babylon • Seabase Delta.

James Mackle, 45 Kenure Park, Rush, Co Dublin, Ireland

BALROG'S POSTBAG

More PD Adventures...

I have written two PD adventure games and I would be happy to give copies to anyone who sends me a SSAE and a disk with at least two other PD adventures. I will also put on some other PD programs (mainly BASIC) which I have written.

If someone wants the games but does not have any PD adventures then they can just send me a disk, SSAE and £1.50.

Paolo Cuomo
Century Cottage
Brenly, Faversham
Kent ME13 9LU.

Thanks very much Paolo!

Greetings from Falstate

Could the Great Balrog assist a mere novice in the hunt for a source of the great *Bard's Tale*? As I have heard so much gossip I wish to pursue this mythical

masterpiece and to delve therein for a time.

Also, mighty sage, if thou knowest of any more classic legends of our time, would not a concise inventory of suggestions taken from your vast library of tomes be worthy of the cost of scribe and parchment within the magical work, namely *Amstrad Action*?

I thank you and may your purse ever hold moonpieces.

Tookeen Strange the Gnome
(Illusionist to Xundra Sharmhand of Guardby and member of a Winter's Tale)

Loosely translated, I think you want to find where you can buy Bard's Tale! Unfortunately, Bard's Tale seems to be no longer available - not even Electronic Arts has any copies left. Therefore I think your best chance would be to put an advert in the Small Ads section or in Adventure Probe asking for it and I'm sure someone will reply (hopefully!).

Adventure suggestions

I have just finished writing my first adventure game and I am just having it playtested and then I will sort out the packaging. Any suggestions before I release it? Could you also give me some addresses for me to send it to to be reviewed.

Oh, thanks to Joan Pancott and Ken Bond for their advice.

Gwynn Hopkins
Llandre

Well, if you've already talked to Ken and Joan I can't really think of anything more you need to know. Between them they've packaged and released quite a few games! As for addresses - try the clubs mentioned in this month's column (although avoid Adventure Coder as they don't review!). If the reviews you get are favourable then send the game to me!

Adventure tip

If anybody is stuck on an adventure game on their CPC6128 this little word should work: XYZY.

Robbie Hammond
Herts

I don't think this always works Robbie!

Adventures dead?

I'm worried about the recent state of the adventure scene. It seems to be slowly deteriorating. I mean, the only new adventures coming out are PD. Where has Magnetic Scrolls/Rainbird gone to, responsible for such games as *Guild of Thieves* and *Jinxter*? And is there any way of convincing Level 9 to return?

Phillip Calver
Essex

Well Phillip, the Balg has been chasing up your various questions. Magnetic Scrolls is now firmly 16-bit only - its new adventure operating system, Magnetic Windows, uses up 180K of disk space before any adventure is actually created - there is no way it could viably produce a CPC version! Rainbird has disappeared, bought up by the same company who bought Telecomsoft. A quick phone call to Level 9 gave the answer "...Not at the moment..." Level 9 is going through some difficult times itself and is at the moment not producing any games. As to your comment about the only adventures appearing being in Public Domain - this is not true! Companies such as Wow and FSF are continuing to support the good old CPC.



• Tookeen Strange the Gnome (what? - ed) is desperate for a copy of *Bard's Tale*. Can anyone help?



• *Corruption* is just one of Magnetic Scrolls' excellent adventures. Where are they now? Will there be any more?

SEIKOSHA

DOT MATRIX PRINTERS

Silica Systems are pleased to recommend Seikosha printers to you at **NEW LOW PROMOTIONAL PRICES**. The Seikosha range is built to the highest standards, by a company that is used to manufacturing high quality precision products. In fact, you may be wearing one of these products on your wrist as Seikosha are part of the massive Seiko/Epson group (with a turnover of £6 billion and 18,000 staff!).

When you buy a Seikosha printer from Silica, we will give you a **Silica PRINTER STARTER KIT** (worth £25 +VAT = £29.38) **FREE OF CHARGE**, to make sure you get off to a flying start with your new printer. For further information on the Seikosha range, complete and return the coupon below. Or, if you can't wait to get your hands on a new low priced Seikosha printer, telephone our mail order hotline, 081-309 1111 to place your order now.

FREE DELIVERY

Next day - anywhere in the UK mainland

FREE HELPLINE

Technical helpline during office hours.

FREE STARTER KIT

Worth £29.38 with every Seikosha printer.

1 YEAR WARRANTY

With every Seikosha printer from Silica.

Each print example was produced by the printer it is shown with. Printer speeds are quoted as follows: SD = Superdraft 15cps, D = Draft 12cps, NLD = Near Letter Quality 12cps, LQ = Letter Quality 12cps.

9-PIN PRINTER



192 CPS **80 COLUMN**

- Seikosha SP-1900AI - 9 pin - 80 col
- 192cps Draft, 48cps NLD
- 1K Printer Buffer + 2 Fonts
- Parallel interface
- Graphics Resolution: 144x72dpi
- Epson and IBM Emulation
- Paper Parking
- FREE Silica Printer Starter Kit

SP-1900AI RRP £179
STARTER KIT £25

TOTAL RRP: £204

SAVING: £105

SILICA PRICE (exc vat): £99

£99

+VAT= £116.33 Ref: PRI 8190

9-PIN PRINTERS



192 CPS **80 COLUMN**

- Seikosha SP-2000AI - 9 pin - 80 col
- 192cps Draft, 48cps NLD
- 21K Printer Buffer + 2 Fonts
- Parallel and Serial Interfaces
- Graphics Resolution: 144x72dpi
- Epson and IBM Emulation
- Optional Auto Sheet Feeder Unit
- FREE Silica Printer Starter Kit

RRP: £196
STARTER KIT: £25
TOTAL RRP: £221
SAVING: £100
SILICA PRICE: £129



240 CPS **136 COLUMN**

- Seikosha SP-2415AI - 9 pin - 136 col
- 300cps SD, 240cps Draft, 50cps NLD
- 17.5K Printer Buffer + 3 Fonts
- Parallel and Serial Interfaces
- Graphics Resolution: 240x144dpi
- Epson and IBM Emulation
- Superior Paper Handling
- FREE Silica Printer Starter Kit

RRP: £240
STARTER KIT: £25
TOTAL RRP: £265
SAVING: £136
SILICA PRICE: £209



240 CPS **80 COLUMN**

- Seikosha SL-92AI - 24 pin - 80 col
- 240cps Draft, 80cps LD
- 44K Printer Buffer + 2 Fonts
- Parallel Interface
- Graphics Resolution: 360x360dpi
- Epson Emulation
- Optional Font ROM - 7 Fonts
- FREE Silica Printer Starter Kit

RRP: £220
STARTER KIT: £25
TOTAL RRP: £245
SAVING: £117
SILICA PRICE: £189



324 CPS **80 COLUMN**

- Seikosha SL-210AI - 24 pin - 80 col
- 324cps Draft, 108cps LQ
- 5K Printer Buffer + 9 Fonts
- Parallel and Serial Interfaces
- Graphics Resolution: 360x360dpi
- Epson and IBM Emulation
- Optional Auto Sheet Feeder
- FREE Silica Printer Starter Kit

RRP: £399
STARTER KIT: £25
TOTAL RRP: £424
SAVING: £215
SILICA PRICE: £369



144 CPS **80 COLUMN**

- Seikosha LF-20 - 24 pin - 80 col
- 180cps SD, 144cps Draft, 60cps LQ
- 1K Printer Buffer + 9 Fonts
- Parallel Interface
- Graphics Resolution: 360x180dpi
- IBM Emulation
- Built-in 50 Sheet Auto Feeder
- FREE Silica Printer Starter Kit

RRP: £279
STARTER KIT: £25
TOTAL RRP: £304
SAVING: £175
SILICA PRICE: £249

24-PIN PRINTERS

BUSINESS PRINTERS (WIDE-BODY)



277 CPS **136 COLUMN**

- Seikosha SL-230AI - 24 pin - 136 col
- 277cps Draft, 92cps LD
- 5K Printer Buffer + 9 Fonts
- Parallel and Serial Interfaces
- Graphics Resolution: 360x360dpi
- Epson and IBM Emulation
- Optional Auto Sheet Feeder
- FREE Silica Printer Starter Kit

RRP: £489
STARTER KIT: £25
TOTAL RRP: £514
SAVING: £125
SILICA PRICE: £449



462 CPS **136 COLUMN**

- Seikosha BP-5500AI - 8 pin - 136 col
- 462cps Draft, 106cps NLD
- 18K Printer Buffer
- Parallel and Serial Interfaces
- Graphics Resolution: 240x144dpi
- Epson and IBM Emulation
- Optional Auto Sheet Feeder
- FREE Silica Printer Starter Kit

RRP: £1299
STARTER KIT: £25
TOTAL RRP: £1324
SAVING: £325
SILICA PRICE: £999



520 CPS **136 COLUMN**

- Seikosha BP-5780AI - 18 pin - 136 col
- 780cps SD, 520cps Draft, 130cps NLD
- 20K Printer Buffer + 2 Fonts
- Parallel and Serial Interfaces
- Graphics Resolution: 240x240dpi
- Epson and IBM Emulation
- Handles 1+6 Multipart Forms
- FREE Silica Printer Starter Kit

RRP: £1499
STARTER KIT: £25
TOTAL RRP: £1524
SAVING: £135
SILICA PRICE: £1399



800 CPS **136 COLUMN**

- Seikosha SBP-10AI - 18 pin - 136 col
- 800cps Draft, 200cps NLD
- 64K Printer Buffer + 2 Fonts
- Parallel and Serial Interfaces
- Graphics Resolution: 240x240dpi
- Epson and IBM Emulation
- Built-in Cut Sheet Feeder
- FREE Silica Printer Starter Kit

RRP: £2999
STARTER KIT: £25
TOTAL RRP: £3024
SAVING: £525
SILICA PRICE: £2499

FREE! STARTER KIT



Every Seikosha printer from Silica comes with the Silica Printer Starter Kit, worth £29.38 (£25 +VAT), completely **FREE OF CHARGE**. It includes all you need to get up and running with your new printer.

- 3 1/2" Disk with Amiga & ST Printer Drivers
- 1.8 Metre Parallel Printer Cable
- 200 Sheets of Quality Continuous Paper
- 100 Continuous Tractor Feed Address Labels
- 5 Continuous Envelopes on Tractor Feed

Printer owners may order the Silica Starter Kit (Ref: KIT 5000) for only £24.38 - £5 off RRP!

SILICA SYSTEMS OFFER YOU

- FREE OVERNIGHT DELIVERY:** On all hardware orders shipped in the UK mainland.
- TECHNICAL SUPPORT HELPLINE:** Team of technical experts at your service.
- PRICE MATCH:** We normally match competitors on a "Same product - Same price" basis.
- ESTABLISHED 12 YEARS:** Proven track record in professional computer sales.
- BUSINESS + EDUCATION + GOVERNMENT:** Volume discounts available for large orders.
- SHOWROOMS:** Demonstration and training facilities at our London & Sidcup branches.
- THE FULL STOCK RANGE:** All of your requirements from one supplier.
- FREE CATALOGUES:** Will be mailed to you with offers and software/peripheral details.
- PAYMENT:** By cash, cheque and all major credit cards.

Before you decide when to buy your new printer, we suggest you think very carefully about WHERE you buy it. Consider what it will be like a few months after you have made your purchase, when you may require additional peripherals or software, or help and advice. And, will the company you buy from contact you with details of new products? At Silica Systems, we ensure that you will have nothing to worry about. We have been established for over 12 years and, with our unrivalled experience and expertise, we can now claim to meet our customers requirements with an understanding which is second to none. But don't just take our word for it. Complete and return the coupon now for our latest Free literature and begin to experience the "Silica Systems Service".

MAIL ORDER HOTLINE
081-309 1111

SILICA SYSTEMS

MAIL ORDER: 1-4 The Mews, Hatherley Rd, Sidcup, Kent, DA14 4DX. Tel: 081-309 1111
Order Lines Open: Mon-Sat 9:00am-4:00pm No Late Night Opening Fax No: 081-309 0908

LONDON SHOP: 52 Tottenham Court Road, London, W1P 0BA. Tel: 071-580 4000
Opening Hours: Mon-Sat 9:30am-6:00pm No Late Night Opening Fax No: 071-323 4737

LONDON SHOP: Selfridges (1st Floor), Oxford Street, London, W1A 1AB. Tel: 071-629 1234
Opening Hours: Mon-Sat 9:30am-6:00pm Late Night: Thursday until 8pm Extension: 3914

SIDCUP SHOP: 1-4 The Mews, Hatherley Rd, Sidcup, Kent, DA14 4DX. Tel: 081-302 8811
Opening Hours: Mon-Sat 9:00am-5:30pm Late Night: Friday until 7pm Fax No: 081-309 0017

To: Silica Systems, Dept AMACT-1291-56, 1-4 The Mews, Hatherley Rd, Sidcup, Kent, DA14 4DX
PLEASE SEND FREE SEIKOSHA INFORMATION

Mr/Mrs/Ms: Initials: Surname:

Company Name (if applicable):

Address:

Postcode:

Tel (Home): Tel (Work):

Which computer(s), if any, do you own?



BUDGET GAMES

ES... RE-RELEASES... RE-RELEASES...

Turrican

Kixx • £3.99



John Turrican. He's big, he's bad, he's got a large gun to shoot things with. Turrican is one nellyva game.

Spacebunga! It's Turry, one of the most hottest, hardest and hyperboliest of shoot-em-ups. You play space commander John Turrican, and you have to leap around a massive playing area, shooting things. There's loads of great power-ups, hyper-active game-play, and plenty to do. Totally crucial. (Also available on the Power Up compilation.)

90%

Powerdrift

Hit Squad • £3.99



In Power Drift you play a skinhead driver (or someone else if you prefer), and try to win a race. Spooky, huh?

The first of two bodacious and weirdsome drive-em-ups in this month's crop. Power Drift is a car racing thingie, in which you yank a kind of drag-car thingie round a bumpy, hilly course, trying to finish in the top three. Your car goes through a 90-degree spin every time you hang a corner. PD is pretty fast, and there's five distinctly different courses to haul round. Six points on the gnarly-o-meter. 85%



Stunt Car Racer

Kixx • £3.99

Here's a bit of an odd game. It's a drive-em-up featuring vector graphics (ie lots of lines and boxes instead of proper backgrounds), and it scored a mind-numbing 96% when it first came out. It's one of them games you'll need a lot of concentration for. 78%



BUDGET

SANTA'S XMAS CAPERS

Zeppelin • £3.99

"Jingle bells, jingle bells, jingle all the way, oh what fun it is to see the Charlton win away (hoi)."

Yes, boys and girls, ladies and gentlemen, aardvarks and slightly malnourished hippopotami, it's that time of year again. A time of drunken debauchery, top football matches, The Great Escape, chocolate sickness, and loadsapresents. Oh, and crap festive computer games like this one.

Get ready, here comes the plot... Someone's spiked Santa's Christmas pud, and the old duffer is laid out in the casualty department of he local hosie, with a serious case of food poisoning. Donning Santa's garb (which is obviously much too big for you 'cos it covers you completely), you take to the skies in the Rudolph-mobile, hurling snowballs at all the naughty pixies, and basketballs, and trains, and other



things that hurtle towards you.

You've got four lives, and there are three short stages to stagger through. The first is set over Lapland, the second over the Atlantic Ocean (where American dudes chuck radar beams at you), and the final one sees you delivering pressies to the kiddies.

Santa's Xmas Capers is too pathetic, dull, simple and twee to be of interest to anyone over the age of five. And far too difficult for anyone young enough to appreciate it. It



Riding through the air, on a one-horse open sleigh...

might find its way into a few stockings (oo-er) because of its Christmasness, but sadly it's one of the worst games ever to (dis)grace the computer store shelves.

Santa's capers can be summed up in one word, and that word is "pathetic"



68% VERDICT



Oh no, some bouncy balls are shooting toilet plungers at us.



Penguin, snowman, crackers, igloo, plunger, ball, tree, boring.



It's the end of level guardian. A big snowman bloke. Chilling, eh?



Uh oh, a couple of rubber ducks. The word 'bizarre' springs to mind.

TEN SANTA FACTS

1. Santa comes from Lapland, which is near Greenland, which is near the North Pole.
2. It's quite cold there.
3. So he wears lots of really warm woolly clothes.
4. And he has a big white beard to keep his face warm.
5. He's also known as Father Christmas, and he's a bit of an amazing guy.
6. For a start, he manages to be in 256 different Debenhams stores at exactly the same time.
7. And he still crawls down people's chimneys, even though we've all got central heating now.
8. He's got lots of little helpers (pixies, elves, YTS trainees) who, er, help him.
9. The French think Santa is called Nicholas, and they reckon he wears a big red trenchcoat and smells of garlic. And then wanders the streets on Christmas Eve, singing carols.
10. Which just goes to show how stupid the French really are.



RE-RELEASES... RE-RELEASES... RE-RELEASES...

BONANZA

Heroes of the Lance

Kixx • £3.99



• Cowabunga! It's role-playing action galore in this Dungeons & Dragons spin off, with more rules than a maths book.

Cor. Here's an instruction sheet the size of a tablecloth, and a game that takes half-an-hour to load. It's a role-playing thingie. A Dungeons & Dragons licence in fact. So, as you can expect, there's loads of stuff about stamina points, combat modifiers, spell casting, and all that sort of stuff. It's a bit like the adventure games we've had on our cover laps, only bigger and more complex.

84%



• Oh no, it's a sleazy winged thing, and two of our eight heroes have been deadified. Doesn't look too good.

Altered Beast

Hit Squad • £3.99

Poor old Trenton Webb. There he was, writing a slagging off review of a crap beat-em-up coin-op conno, when he decided to throw in an odd Stonehenge analogy that no-one has ever understood. Two years later, the Hit Squad prints part of that analogy on an inlay and it appears that Amstrad Action likes this game. We don't. We hate it.

14%

X-Out

Kixx • £3.99

Leap into your spaceship, and leap into space, the sea. X-Out is a horizontally scrolling shoot-em-up thingie, with excellent graphics and mega hectic gameplay. One that set standards for the others to follow. (Also available on the Power Up compilation.)

88%

SLIGHTLY MAGIC

Codemasters • £3.99

We've never really understood wizards. All that growing long pointy beards, wearing long pointy hats and cloaks with stars on, and doing magic. It's no substitute for getting spiky haircuts, wearing combat trousers and Sensless Things T-shirts, and going to nightclubs.

Oh well, it's a free world though (in so much as you don't have to pay for it). And Bigwiz certainly seems to enjoy being a wizard, even if he has just left the castle in a hurry to go to a Ned's Atomic Dustbin concert, leaving behind his spare wand in the process. And forgetting to lock his lab door. And forgetting to take his nephew Slightly (stupid name for a nephew) with him. What an absent-minded old so-and-so, eh?

Slightly Magic is one of the games on the upcoming *Cartoon Collection* compilation, but it's also being released as a separate game at the standard budget price.



• Yeah, you guessed right. *Slightly Magic* is another cutie.



• Here's Slightly, a dragon, a cat and a miserable old tree. And the moon. And some flowers. And...



• Oh dear. When you die, this message appears, inviting you to spend a small fortune.



• That dragon is going to burn you to a crisp. Unless you can find a bucket of water pretty sharpish.

You take the role of Slightly (surprise, surprise), and your first mission is to get hold of a spellbook and wand, so you can start casting spells. These are both located on

the starting screen, but unfortunately aren't accessible without having to wander through loads of other rooms, dealing with the various hazards that await you. 'Damn' and 'blast', as the Wonderstuff would no doubt say if they were here.

The first hazard you'll encounter is a bunch of fire-breathing dragons. Buckets of water come in useful here. Your main mission is to rescue a gnarly princess from a particularly large dragon. So polish up your chivalry and get on down.

Standard Codies' graphics. Standard Codies' gameplay. What do you reckon then, Jim Bob out of Carter USM? "Could you get out of my bathroom, please?" Oh, okay.

Run-of-the-mill arcade adventure from the Darling posse

13% VERDICT

WIN A WOOLLY HAT AND A PACK OF VEGE BURGER MIX

Winter is on the way. It's starting to get mighty chilly. And what better way to keep warm than with a wonderful green woolly hat (as worn by the army when they're fighting wars in cold places) and a packet of nutritious vege burger mix. Normally, these two insulating beauties would cost around £2.50, but you can win them for only the price of a stamp.

Look closely at the *Slightly Magic* review. At first glance, it might look just like any other review. But

look a little closer, and you'll see our writer has cleverly hidden the names of four crap indie bands in there.

Using your incredible deductive powers, locate the four names, and write them on the back of a postcard or sealed-down Trident missile. Then send them to *Woolly hat and Vege Burger Compo*, Amstrad Action, 29 Monmouth Street, Bath, Avon BA1 2DL to arrive by December 17th 1991. Stay warm while all around you are going "brrrrr".

ACTION TEST

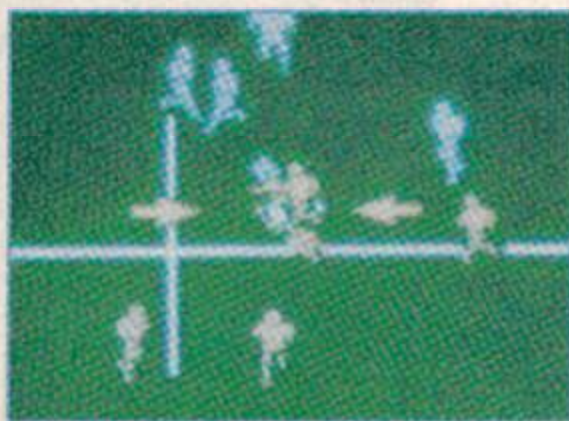

● Tackle the other blokes just by piling into them and pressing Fire. Get it even half right and they'll go flying.

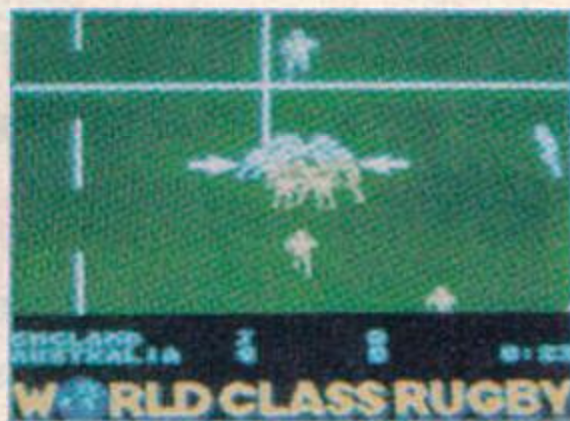

● Ever felt stuck in a ruck? (Ha ha) Rucks are impromptu scrums. Much waggling is needed to gain possession of the ball.



● When you kick off, you get a map of the pitch and the position of the players, plus a direction/power meter (lower left).

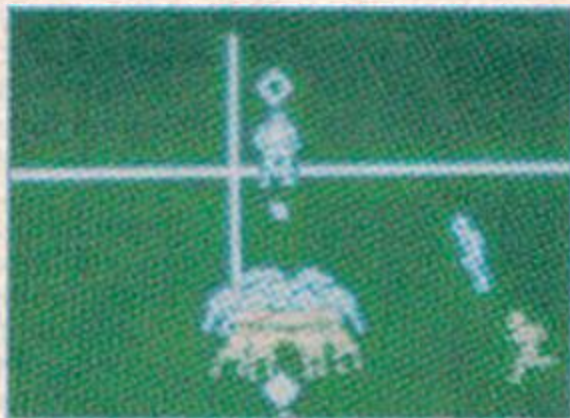

● Blast! The other team has got the ball. More waggling practice needed, methinks. Get 'im lads!



There are flaws, though. The graphics aren't going to win any prizes and the players don't react to the controls particularly quickly, but passing, kicking and tackling are all pretty easy to suss out, and there's lots of scope for improving your game – including a variety of 'set moves' to master.

There are also a variety of opponents to tackle in *World Class Rugby*. You can elect to play either friendly matches or embark on a full World Cup competition. If you decide to go for the World Cup you can set up the various competing countries as either human or computer players – the two-(human)-player mode is excellent fun.

World Cup Rugby is the oval-balled equivalent of *Kick Off*. Its principal ingredient is sheer speed, playability and fun. But, unlike *Kick Off*, it's got a lot of depth too.

The graphics and general speed are all that let *WCR* down. Apart from that, it's great!

Rad

● Ach! Techie probs galore! Sorry about the grabs on these pages – the game itself looks loads better! *WCR WON'T RUN ON THE PLUS.*

WORLD CLASS RUGBY

AUDIOGENIC ■ £10.99
cass, £15.99 disk

Rugby: grab the ball, run like stink, get knocked down, wrestle in a heap with 20 other blokes, grab ball, run like stink, get knocked down etc. Oh yes, and don't forget the mud.

Rugby, believe it or not, is a game of skill. Hard to believe when you're watching thirty grown men with no teeth and far-too-tight headbands mauling each other to death on a Saturday afternoon on a playing field in Wigan.

But it's true. Ever heard of a 'ruck'? What about 'grounding' and 'scissor moves'? All part of the weird and wonderful rugby terminology revealed as you read the instructions to *World Class Rugby* (after taking fifteen minutes to work out that two computer teams are playing).

Right, let's see now... you pick up the ball automatically when you run over it, use the 'stick to control the direction to run in and...

ooof! – some sixty-stone Aussie head-butts you in the solar plexus.

Right! How do you tackle? The player currently under your control is highlighted with an arrow. Run up to the offending Aussie, time it just right... and Fire! Gotcher! You bring the mad lump down... and about forty blokes jump on top of you in a 'ruck'.

So whaddya do now? Waggle the stick, says the book. Yeah, you've got possession again! Run, run, run! You're past the 22-yard line! Run! The crowd are on their feet (*er, they're queuing to leave, actually – Adam*) – quick, how do you score a try? (Fumble fumble.) Aha, press Fire and push in the direction of travel... and it's a try! The crowd goes wild! (*Wild? It's furious.*)

That's right, rugby is a game of skill, ahem. But *World Class Rugby* makes it all pretty painless. More than that, though, it actually makes it excellent fun!

Just like Anco's excellent *Kick Off*, *World Class Rugby* takes a potentially very complicated sport and turns it into a highly playable computer game. Sure, you can memorise all the different moves and controls, but the real fun is just piling in against either a friend or the computer, waggling like a madman and demonstrating all the forethought, finesse and judgment of a stampeding mammoth.

SECOND OPINION

"Rugby may be a game played by men with odd-shaped balls who hang around with sheep, but *World Class Rugby* is clean, civilised and a lot of fun. And no sheep."

Adam P

WORLD CLASS RUGBY VERDICT

GRAPHICS..... **68%**
Horrible colours (mind you, the pitch is green) and a bit slow

SONICS..... **81%**
The ref's whistle and the roar of the crowd – what more do you need?

GRAB FACTOR..... **84%**
Easy to pick up, and instantly addictive

STAYING POWER... **90%**
Lots of stuff to master, and there's the two-human option too

RATING 87%

Nothing special to look at, but really playable and terrific fun.

3.5" DISK DRIVE

OUR SLIMLINE SONY 3.5" DISK DRIVES COME COMPLETE WITH FULL INSTRUCTIONS, FREE UTILITY SOFTWARE AND A 12 MONTH GUARANTEE FOR ONLY £69.99 (plus £4.00 for postage and packing). Ten 3.5" disks only £10.00.

SPECIAL SUMMER BARGAIN

A 3.5" disk drive, ROMDOS and a 6 socket rombox for only £99.99 (plus £5.00 postage and packing). This is a genuine saving of £40!!

464 OWNERS

DDI-1 Amstrad 3" disk drives now in stock. The only disk drive that can be used as a first drive on a 464. Comes complete with manual and system disk. Only £159.99. Ten 3" disks only £17.50.

Please state computer (464/664/6128) when ordering.
464 owners must have a DDI-1 before using a 3.5" disk drive.



SIREN SOFTWARE



Wilton House, Bury Rd, Radcliffe, Manchester M26 9UR.
Tel: 061-724 7572 Fax: 061-724 4893

STRATEGY GAMES FOR THE SPEEDWAY FAN

(No Joystick Required)

(Please Name Team Supported)

"TEAM CHAMPIONSHIP"

Try to win the League Title with your team

- * League Tables * Fixtures * Results
- * Injuries * Points * Name change facility
- * All current Division one/two riders

Two versions on one tape/disc (North and South)

Amstrad CPC TAPE £7 DISC £7.50



"WORLD CUP"

Can you win the World Cup

- * 12 Countries take part
- * England * Denmark * Sweden * USA etc.
- * Qualifying Rounds, Semi-Final, Final
- * 2 Leg Events, Aggregate Scores 2nd Leg
- * PLUS YOUR REGIONS CUP

All on one tape/disc

Amstrad CPC TAPE £7. DISC £7.50

Both Games on TAPES £12. Both Games on DISC £13

Please make Cheques/Postal Orders payable to

ET SOFTWARE

64 Montrose Avenue, Lillington

Leamington Spa, Warwickshire CV32 7DY

Many other speedway games for Amstrad, Spectrum, Commodore. Details on request



PROTON SOFTWARE



Call for special offers: Hotline: 0462 851855

AMSTRAD TOP 60

	CASS	DISK		CASS	DISK
Addicted To Fun	7.99	11.99	World Champ. Soccer	7.99	11.99
Amazing Spider Man	11.99	11.99	Fun School 4 (All ages)	9.99	12.99
Super Heroes	10.99	14.99	Better Maths 1 (12-16)	8.99	12.99
Super Space Invaders	7.99	12.99	Better Maths 1 (12-16)	8.99	12.99
Pittfighter	7.99	12.99	Better Spelling (9-14)	8.99	12.99
Soccer Compilation	9.99	13.99	Donald Alphabet Chase	8.99	11.99
Shoe People	7.99	11.99	Cool Croc Twins	7.99	11.99
Chart Attack	10.99	14.99	Int. Sport Challenge	TBA	TBA
Space Crusade	7.99	11.99	Blues Brothers	7.99	11.99
Famous Five	8.99	11.99	Realms	TBA	TBA
Judge Dredd	7.99	10.99	Double Dragon II	TBA	TBA
Dizzy Collection	7.99	11.99	3D Construction Kit	18.99	18.99
Turtles	8.99	12.99	Darkman	7.99	11.99
Big Box	12.99	14.99	Grandstand	10.99	14.99
Ultimate Collection	11.99	15.99	Hero Quest	7.99	11.99
Fun School 3 (All ages)	9.99	12.99	Virtual Worlds	10.99	14.99
The Simpsons	TBA	TBA	North + South	8.99	12.99
Golden Axe	7.99	10.99	Swap	7.99	11.99
Sim City	9.99	13.99	Final Fight	8.99	12.99
Man. United	7.99	11.99	Super Sim Pack	12.99	18.99
Man. United Europe	9.99	13.99	Robo Zone	7.99	11.99
Hollywood Collection	11.99	14.99	Movie Premiere Comp	10.99	14.99
Rick Dangerous 2	7.99	11.99	Capcon Collection	12.99	18.99
James Bond Collection	9.99	14.99	Gunship	11.99	14.99
Mini Office II	11.99	15.99	Kick Off 2	7.99	11.99
Thunder Jaws	7.99	12.99	RBI 2	7.99	12.99
Pop Up	8.99	11.99	Switchblade	7.99	11.99
Power Up	11.99	14.99	F15 Strike Eagle	7.99	11.99
Secret Agent/Sly Spy	7.99	11.99	F16 Combat Pilot	10.99	14.99
SWIV	8.99	11.99	Golden Axe	7.99	10.99

★ SPECIAL OFFER ★

Captain Blood Amstrad Disk £3.99

Teenage Queen Amstrad Disk £3.99

Cheques/PO's to: PROTON SOFTWARE, SOUTHWAYS SUITE 1,
111 STATION ROAD, LOWER STONDON, BEDS, SG16 6JP.
Tel: 0462 851855 24 hour. Fax: 0462 851898

SEE
BELOW FOR
COMPETITION



Tel 0257 276800

Main office & 24 hour order line

Fax 0257 274753

Help desk 0490 3284

Weekdays 3-4pm

Overseas orders please add £5.00.

All prices include P+P and VAT.

WITH *Intraset Ltd*

Our compendium of gaming software uses your computer's intelligence and logic to predict winners and advise you on strategy. Whether you're an experienced punter or a novice, with a little time and our range of software, you can maximise your winning potential.

COURSEMASTER

Our proven horse racing program for both FLATS or JUMPS £24.95

*NEW

TRACKMASTER

The Greyhound Racing Tipster £19.95
Coursemaster & Trackmaster Twin Pack £39.95
(Saving £4.95)

Using simple information from the racing card in daily papers or the racing papers, COURSEMASTER and TRACKMASTER will predict with consistent accuracy.

The winner is predicted as well as second and third places for tricasts. The programs also mention attractive long shots, recommend types of bets and most importantly warn when not to bet.

Successful betting extends beyond merely picking the winners and COURSEMASTER and TRACKMASTER will assist in managing your bets. They work out your winnings on the most popular types of bet including SINGLES, DOUBLES, PATENT, YANKEE, CANADIAN, print out your betting slips, and even maintain your betting bank account. SYSTEM BETS will regularly provide a system for MAJOR WINS with small stakes - try it and surprise yourself.

COMPETITION Details and rules

Our company likes to see people winning, which is why we're running our fabulous 'Win a pc competition'. With every purchase you make, you will automatically be entered into the draw. You can also enter for free by sending a postcard to INTRASET.

1st prize - PC NT286 Colour

2nd prize - Complete set of Intraset Business and Gaming Software
3rd prize - Complete set of Intraset Gaming Software
5 runners up will each win their choice of one Intraset title.

Intraset's decision will be final on all matters.
Send an SAE for list of winners.
Draw dates 28/2/92 and 28/9/92

SPECIAL OFFER

POOLSMASER and COURSEMASTER together for £44.95 (Saving £4.95.)

Our complete gaming suite: £110.00
POOLSMASER (British & Australian),
PERM-MASTER, SPOT-THE-BALL,
COURSEMASTER, TRACKMASTER
Saving £22.70

'A licence to print money' Mr FC Hammond of Essex who won nearly £10,000 in 16 weeks

'We have won many thousands' Mr PE Roberts of Dorset who so far has won more than £46,000

*Copies of these and other endorsements from actual customers are available on request.

POOLSMASER British or Australian £24.95 each.
Poolsmaster British and Australian £44.95 (Saving £4.95)

The Football Pools Predictors

Developed after years of detailed study, POOLSMASER uses a unique scientific formula to predict Home, Aways and Draws. The FORM PREDICTION option analyzes result possibilities with amazing accuracy. The unique indexing system allows for quick entry of fixtures and results, and updates itself season after season so there is no need to buy a new copy each year. Poolsmaster also contains a unique coupon number sequence predictor.

Together, both Poolsmaster editions cover all British league and cup matches and the Australian league.

PERM-MASTER £19.95
The perfect companion for Poolsmaster

Designed for users of PERM systems, PERM-MASTER ends the agony of checking by doing it for you. It comes complete with several of the top perms built in but you can also create your own with the unique PERM EDITOR and PERM CALCULATOR features. PERM-MASTER is fast and easy to use and can be used for most block and single line perms. Additional discs of top perms are available at £14.95 each.

All programs available for IBM/PC & compatibles, all Amstrad PC's, Amstrad PCWs, Atari, Amiga and CPC 6128. Coursemaster, Poolsmaster British and Trackmaster are also available for all Amstrad CPC's, all Spectrums and C64 & 128.

SPOT-THE-BALL £17.95

There is no more need for counting 'x's or using messy rubber stamps. Simply tell your computer where you think the ball is using the screen template provided. It will give you a print-out of up to 540 micro-fine crosses in your chosen shape or it can chose at random for you. SPOT-THE-BALL learns week after week and builds up a database of results for the SEQUENCE PREDICTOR OPTION.

GUIDE TO POOLS AND PERMS £14.95

The definitive guide to Pools permutations and betting systems

Written by the experts responsible for our successful software range. Master the fine art of prediction by reading this fascinating in-depth explanation of betting systems and perms. Plan a campaign for that elusive big win and use this books' tips on selecting the best matches and races and how to use perms to maximum effect on Pools, Horses and Dogs.

INTEREST-FREE CREDIT

Spend over £80 and spread the cost at no extra charge! (Cheque purchases only.) Simply divide your order by 4 and send us 4 cheques each with your name and address and cheque guarantee number: Date the first cheque with today's date and post-date each of the other cheques by one month ie. 1/5/91, 1/6/91 etc. We will then hold each cheque until it is due.



Intraset Ltd

Send an SAE for full catalogue

Send cheques or postal orders to INTRASET LTD (DEPT AA) FREEPOST,
10 Woodside Avenue, Clayton-Le-Woods, Chorley, Lancs. PR6 7BR.
Phone or Fax for lightning service. All major credit cards accepted.

TERMINATOR 2 Ocean



The film that was a smash hit in the box offices scores a Rave on the Amstrad. Another cracking film licence from Ocean.

Description	Price	Order No
T2 Cass	£8.99	AA648AC
T2 Disk	£11.99	AA648AD

FINAL FIGHT US Gold



One of the best ever beat-em-ups in the arcades is now one of the best ever beat-em-ups on your machine. Don't miss it!

Description	Price	Order No
Final Fight Cass	£9.99	AA649AC
Final Fight Disk	£12.99	AA649AD

EQUINOXE

THE NEW MUSICAL STANDARD ON THE CPC?

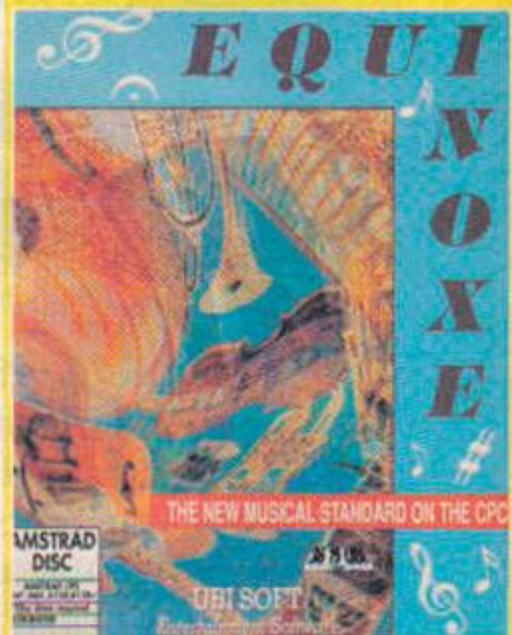

THE NEW MUSICAL STANDARD ON THE CPC
AMSTRAD DISC
UBI SOFT

MAIL ORDER

AA BINDER



Keep your valued Amstrad Action magazine collection together in this bright red binder.

Description	Price	Order No
One binder	£5.99	AA417R
Two binder	£9.00	AA4172R

NORTH & SOUTH infogrames



Relive the epic battles and strategies of the American Civil War in this Mastergame from one of France's leading software house.

Description	Price	Order No
N & South Cass	£7.99	AA636AC
N & South Disc	£10.99	AA636AD

FUN SCHOOL 4 Database Software



Bumper packages of educational software for infant and primary school children. The complete suite of six programs. **Teddy Bear Under 5's** **Frog 5-7 years** / **Robot Over 7**

Description	Price	Order No	Description	Price	Order No
T. Bear Cass	£9.99	AA632AC	Frog Disk	£11.99	AA633AD
T. Bear5 Disk	£11.99	AA632AD	Robot Cass	£9.99	AA634AC
Frog Cass	£9.99	AA633AC	Robot Disk	£11.99	AA634AD

TURRICAN 2 Rainbow Arts



The original Turrican was one of the best shoot-em-ups of 1990. **Turrican 2** is even better. A huge playing area, more monsters than ever and an incredible arsenal of weaponry - it's stunning.

Description	Price	Order No
Turrican 2 Cass	£7.99	AA647AC
Turrican 2 Disc	£10.99	AA647AD

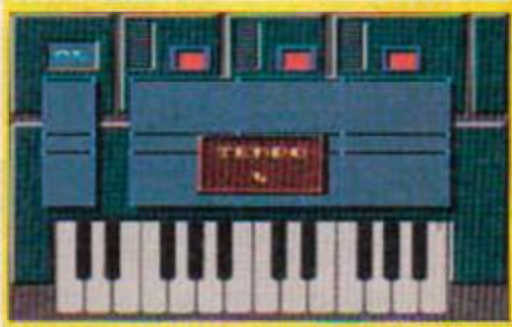

By special arrangement with the French publisher Ubi Soft, **Amstrad Action** can bring you the music program that's taking France by storm. Create your own sequences, edit sound envelopes, save your musical creations to disk and more... see the review on page 24 of this issue for the full story. Remember, you can **only get this program from Amstrad Action.**

- DISK ONLY
- The menus in this program are in French but the manual contains instructions in English

Description	Order No
Equinoxe	AA653AD



THE LATEST AND GREATEST PRODUCTS AT THE BEST POSSIBLE PRICE

SEE OUR AMAZING SUBSCRIPTION OFFER OF FREE SOFTWARE ON PAGE 64

Prices include POSTAGE, packing and VAT NO HIDDEN EXTRAS

AMSTRAD ACTION MAIL ORDER

Name	Description	Price	Order No
Address			
Postcode			
Phone number			

Method of payment (please circle) Access • Visa • Cheque • PO

TOTAL ORDER

Credit Card No

Expiry date

Please make all cheques payable to Future Publishing Limited

SEND THIS FORM TO: Amstrad Action, Future Publishing Ltd, Freepost, Somerton, Somerset, TA11 7BR

No stamp required if posted in the UK, Channel Islands or the Isle of Man

● For overseas orders call Claire Bates for prices on 0458 74011

Forum

This is the spot for all those people with technical problems. Send us a letter detailing the trouble you're having and if we can't fix you up with a solution, one of our readers surely will. Or maybe you've discovered some valuable tip you want to share with the rest of us? Write to: *Forum, Amstrad Action, Beauford Court, 30 Monmouth Street, Bath, Avon BA1 2BW*

Dear Santa

Q Please could you print this as I need the answer for my Christmas presents. Here goes: I have a 464 with a green monitor. Is there anything you can buy which would allow me to plug my 464 into a colour TV? If so, where can I get it and how much will it cost?

On a different tack, just what was the *Type-In Archiver* by Andy Price supposed to do? I tried to archive something from tape to disk and all it did was wipe off the (luckily very few) files that were on the disk.

Tim Nutley
Shrewsbury

P.S. Frank looked a lot better with the Predator mask.

A Start early, Tim, that's my advice. Sainsbury's already have their shelves stocked with Christmas crackers and it's 'only' a couple of months 'til the big day.

Ask Santa to try and get hold of an MP1 modulator. This device supplies power to the computer and produces a TV signal so you can

plug it into your telly's aerial socket. The MP2 modulator is designed for the 6128 and has an additional power socket for the disk drive. It will work fine with your computer, though, and you've got more chance of getting hold of one. As for a source, your best bet is to check out the mail order advertisers in AA.

The Archiver is designed to make a copy of your disk onto tape for safe keeping. It copies the disk as a whole to tape, rather than the programs individually and so is useful for backups or storing disks that you're not likely to be using for a while.

Squiggly brackets

Q Looking at my Watch Type-In in issue 73, I noticed your Apple Mac seems to cut off part of lines 110 and 120 and given weird Type Righter codes. They should have read:

```
110 PRINT "ITSET,(h),(m),(s) " Set the time."
120 PRINT "IASET,(h),(m),(s) " Set the alarm."
```

This seems to be because of the squiggly bracket

ets. Your thingy which puts in the *Type Righter* codes mistakes them for the end of a line, moves the next five characters to the beginning as the codes and blasts the rest away (hmm... yes... too many shoot-em-ups).

Anyway, how many of you machine code programmers get fed up with the prospect of typing in a load of POKE statements when you want to load a headerless file or something? Well, no more. Just type:

```
KEY 139,CHR$(13)+"a=a+1:POKE a,&"
a=start address of your code-1
```

Then press the small ENTER key, type in the first hex code and repeat the process until you've got all your code in.

Chi Keong Lee
Moreden, Surrey

A You're right about the *Type Writer* program. All we want is to make life easier for our readers, so we put the *Type Writer* codes at the front of our listings to make them more readable. Unfortunately the program that does this takes the first squiggly bracket as the code and chops the line up there and then. It's the first time we've had this problem, by the way. Steps are being taken to ensure it's the last time, too!

Light writing

Q If I was to purchase a printer and light pen would it be possible for me to print out bar codes onto sticky labels, program in specific data cor-

Protection off

I was reading the October issue of AA when I came across a letter in *Forum* regarding loading protected BASIC programs.

I remembered I'd seen an easier way of doing this in AA53 (Feb '90). Phil Howard says you should do this (only works on CPC464s):

```
POKE &AC03,&C0
POKE &AC02,&90
POKE &AC01,&C3
LOAD ""
```

The protected program will now load.

Matthew Kirby
London

Thanks to Matthew and also to Phil Howard, who came up with these pokes originally.

Colourful characters

Q Please help me make my CPC6128 talk to my Star LC10 colour printer. Colour dumps, including MJC's, won't work. *Tasword* prints normally. Manufacturers say you can program it to print in colour, but how?

I want to make my own Christmas cards - personalised HAPPY CHRISTMAS with each letter in a different colour. I've managed to write a BASIC program to get each word a separate colour, but each letter!?!

And how do you print a colour picture? I have about 100 working days, and it looks like I'll need every one!

C Russell
Harrow

A The LC10 can be made to change the colour it's printing in by the use of a system of double-bracket



● Gosh! The Star LC-10 colour printer is terribly clever, isn't it? Just one thing, how do you actually use the thing?

On form

```

1 CP/M Ultraform adapter
2 By Ian E. Dowse
3
10 t=0:FOR a=1 TO &30:READ a$:t=t+VAL("&"a$):NEXT
20 IF t<>2264 THEN PRINT"Data Error":STOP
30 OPENOUT"b203k.com":GOSUB 60:PRINT#9,CHR$(255):CLOSEOUT
40 OPENOUT"bnorm.com":GOSUB 60:PRINT#9,CHR$(0):CLOSEOUT:END
60 RESTORE:FOR a=1 TO &30:READ a$
70 PRINT#9,CHR$(VAL("&"a$)):NEXT:RETURN
80 DATA 0E,0E,1E,01,CD,05,00,0E,1F,CD,05,00
90 DATA EB,21,16,01,01,1B,00,ED,B0,C7,28,00
100 DATA 03,07,00,CC,00,3F,00,C0,00,10,00,01
110 DATA 00,02,03,00,28,0A,30,00,02,20,32,60
    
```

● Use our Ultraform Type-In under CP/M with this neat little patch.

accessed. BNORM will return drive B to normal.

Note that this program will not work with CP/M 2.2 on a single drive system.

I hope that this will help Ranji and any other readers who are having the same problem.

Ian Dowse
Dunglohaire, Eire



Thank you Ian, there's a voucher on its way to you for your trouble!

Ranji Mistry of Bradford wrote in recently (AA72) on the subject of being unable to access Ultraform's 203K format from CP/M. I came across the same problem and wrote a short program to rectify it.

Simply type in the following program, insert a disk and run it. It will save two files to the disk: B203K.COM and BNORM.COM. When using CP/M type B203K and whenever 'Drive is B.' is displayed a 203K disk can be

responding to the bar codes and then get the computer to read the bar codes via the light pen?

For instance, if I had firstly entered the codes and the list of various books, could I get the computer to display on screen the correct title of the book I scanned.

I would be most grateful if you could answer my questions.

Jay McGuiness
Colchester

A I'm afraid that the answer's a big 'No'.

The light pens you describe work by reading the beam of light used to make up the screen display of the computer. Bar code reading is a horribly complicated

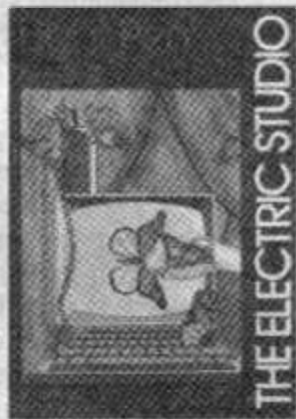

● Light pens are all well and good for on-screen drawing, but bar codes? Forget it!

codes. Enclose the colour you want to change to in a set of brackets like this:

((C1))

Instead of printing out the above as text, the printer will interpret the double brackets as a signal to alter the way it prints. In the example the C tells it to change colour and the 1 tells it that you'd like to change to red.

The colours are selected with the following numbers: 0 Black; 1 red; 2 blue; 3 violet; 4 yellow; 5 orange; 6 green.

As for printing out pictures, the utility you have is designed to convert the screen formats for pictures saved from Advanced Art Studio or AMX Art only. You need one of these programs to make use of your utility. I would recommend Advanced Art Studio as being an easy to use and powerful art package.

Good luck with the Crimbo cards and don't forget to send one to the AA office!

subject, and involves bouncing laser beams around and reading the reflected light.

Bar code readers are available for business computers such as the PC, but cost many hundreds of pounds.

Back to base

A I own a 6128 Plus and found that Rambase gives a load failed message in line 4010. Is there a fault in the program or has something happened elsewhere?

Where should the BANKMAN.BIN be? Should it be in the program, if so where? Also by way of footnote in the instructions on how to use Rambase it reads RUN"RAMBASE - this will not work, you have to type in: RUN "RAMBASE2".

Please could you sort this problem out, it's driving me up the wall.

Mick Williams
Chichester

A RAMBASE needs another file, called Bankman, to run. This file is supplied on the system disk that came with the machine.

We would have liked to have put this program on the tape to make it easier to use RAMBASE, but were unable to because it's a copyrighted piece of software. You need to copy BANKMAN.BIN onto the same disk as the RAMBASE program in order for it to work.

Bankman is supplied on your system disk, and yes, it's perfectly legitimate for you to make copies for your own use.

Gone DIPpy

A I have an Amstrad 464 computer with an Amstrad DMP3160 printer. I have lost the manual for the printer and the problem is that the children in my house have at some time switched all the switches to off. I don't know how to get it back to its basic setting let alone anything else! I

would be grateful of any help you could give me with this problem.

S J Wheatley
Ailon, Hants



First thing to do is give them all a good clip round the earhole and send them to bed without any supper. Second thing is to put the switches to their proper positions. Here's what they all do:

FUNCTION	OFF	ON
Bank one:		
1 International characters	-	-
2 International characters	-	-
3 International characters	-	-
4 Carriage return	CR only	CR & LF
5 Paper out sensor	Enable	Disable
6 Page length	11 inch	12 inch
7 Default character set	-	-
8 Default character set	-	-
Bank two:		
1 Zero character	Unblanked	Slashed
2 Default skip perforation	Disable	Enable
3 Buffer mode	Character	Graphics
4 Buffer mode	Character	Download /graphics
5 SLC7 2H signal	Not sent	Auto Sent
6 Alarm beeper	Disable	Enable
7 Default typeface	Bold off	Condensed & bold on
8 Default typeface	Condensed off	Bold on
9 Do not use (factory set)		
10 Do not use (factory set)		

Cash in your chips

A I have a 464 with a Citizen 120D printer. I am interested in buying a disk drive I will probably need more memory to run disk games. Would it be better to but the extra memory first and then buy a disk drive?

Is it possible to just buy the memory chips by themselves and put them in myself?

Andrew McDermott
St. Albans

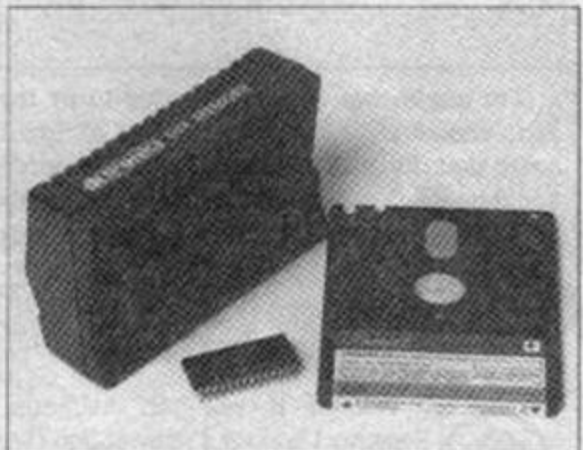

● Need to expand your machine? You're much better off buying a ready-made unit than trying to bodge one together yourself.



Go for the disk drive first. Plenty of games run in a 64K machine from disk, but there are few games that require 128K that load from tape.

Starting out

Q I am thinking of starting my own PD library, but I am not sure how I can get hold of the software. The only programs I have so far are ones that I have written. Can I send off to other PD libraries for programs and then use them in my library and can I use the programs from AA in my library?

I would like to know, when you come to publishing letters in AA, whether you read them all and then publish the most interesting and helpful ones or do you publish the first ones you come across?

Martin Rowbory
Fleet, Hants

A Public domain is freely available to anybody who wants it, and can be distributed by anyone who wants to. There's no big problem with obtaining stuff from other libraries and including it in your own collections. However, be fair. You shouldn't start a library with the intention of making packets of cash, it's not in the spirit of PD software.

We have decided that all the programs in the Type-Ins pages are public domain, unless the author specifically states that the program is not PD. As for the cover-tapes, the programs there most certainly aren't PD. Although the games are given away with the magazine, AA has merely been granted the right to put the games on the tape, and doesn't hold the copyright. The rights to game demos on the tape are owned by the software house, and they may grant you the right to place a demo in your library, put make sure you get their permission first!

As for letters in AA, we've printed yours so we certainly don't pick the most interesting ones! Only joking - we do read all the letters sent to us, and try to pick a variety that will help most people. When we do run out of space, useful letters are held over for possible inclusion in the next month's section.

I'm afraid that it's not possible to fit the extra memory internally, you need a circuit board that fits onto the back of your computer. You'd be much better off buying a ready-made unit. Check out AA's advertisers for the best deals.

City Razed

Q I wonder if you can help me. Recently I bought a copy of *Sim City* for my 6128 Plus. After I had created a city, I decided to save it for a later date. Unfortunately I didn't put a blank disk in the drive and I saved my data on the *Sim City* program disk. Now I can't access the game. Can you help?

Darren Johnston
Orkney



● Apocalypse! Saving data to your *Sim City* program disk is the equivalent of dropping a 100-megaton bomb on Milton Keynes. Hmm, maybe that's not a bad idea...

A Never, ever save anything onto an original program disk, unless it specifically tells you to in the instructions! Always write

protect the games disks you buy to prevent accidents.

But that advice is a little too late for you. I suggest you write a nice, pleading letter to Infogrames along with your disk saying what a silly boy you've been and promising it won't happen again.

And it won't happen again, will it Darren, because from now on you're going to extra careful with your disks and you're going to follow the above advice, right?

Super keys

Q With all the current plugs for *Supercalc 2*, I wonder if you would be interested in a slightly different *Type-In*. It sets up the 6128 keyboard to mimic, as far as possible, the function key assignments of *Supercalc 5*. Use of the numeric pad is not lost - the numerals are all available in their shifted state and CONTROL/CAPS LOCK will toggle SHIFT LOCK for intensive numeric entry.

```

0 N B C "X" cursor up/insert space
1 N B C "O" cursor right
2 N B C "Z" cursor down/delete space
3 W " " "801" home (F9 - PLOT GRAPH in SC5)
3 C " " "801" active cell to home position
4 N "J" window (F6)
5 N "Z" delete entry (F3 MARKS in SC5)
7 N "I" pointing
8 N B C "S" cursor left
9 N B C " " "803" copy
10 N "I" recalculate (F7)
11 N "6" resume macro/QRT (F8)
12 N "W" go to (F5)
13 N "Y" help (F3)
14 N " " "802" edit current cell (F2)
15 N " " "09" tab (moves entry cursor to start/end of entry)
16 N B C " " "X" clr
20 N " " "27" see (F4 AND in SC5)
66 N B " " "27" asc
66 C "Z" delete entry
72 N B C " " "B" )
73 N B C " " "B" )
74 N B C " " "B" ) joystick/mouse movement
75 N B C " " "B" )
76 N B C " " "B" 'fire' = 'delete entry'
79 N B C " " "B" backspace
E 800 " " "1" N
E 801 " " "3" N
E 802 " " "X" N
E 803 " " "C" N
    
```

● Make your CPC version of *Supercalc 2* think it's *Supercalc 5*. This redefines the keyboard to mimic the latter's function keys.

1. Type the following into an ASCII file called KEYS.SC2 and copy it to your *Supercalc 2* working disk (comments to the right may be left out if required):
2. Copy SETKEYS.COM onto your *Supercalc 2* working disk.
3. Add the line SETKEYS KEYS.SC2 to your PROFILE.SUB or create a new PROFILE.SUB file with the lines:

```
SETKEYS KEYS.SC2
SC2
```

4. The function keys operate in NORMAL state but the numeric keypad can be restored with

SHIFT or CONTROL/CAPS LOCK (i.e. SHIFT LOCK) for intensive numeric entry. '0' duplicates TAB for moving the entry cursor quickly to the start/end of an entry; '.' on the keypad duplicates '.'; other keys like COPY, CLR, DEL operate as expected.

John Hudson
Huddersfield

A Thank you for that, John. It'll be especially useful for those who use *Supercalc 5* at work and have *Supercalc 2* at home.

Room for improvement

Q I bought a 6128 four years ago when I was ten. Now I think I will get a second drive. I'm thinking of getting a 3.5 inch drive because:

- It's cheaper;
- The disks are cheaper, and;
- There is more room on the disks.

I'm baffled, though. In some of the ads on AA it says you can get 800K of storage per disk if you use some software included. Is the software on disk or is it on ROM and do you need a rombox?

Finally, do you need an interface or is it included? Oh, and one more thing, could you suggest a good firm to get a drive from?

James Harvey,
Bansley, S. Yorks

A A 3.5-inch drive is an excellent choice for a second drive for all the reasons you mention. Though capable of far greater storage than a standard Amstrad drive, the 3.5-inch drive is limited by the CPC's operating system which only allows a maximum of 178K of storage.

To overcome this problem, a different operating system is required. This 'takes over' all disk operations and is configured to work with much larger disk sizes. There are three operating systems generally available: they are Ramdos and Romdos from KDS and Rodos from Romantic Robot.

Ramos comes on disk and sits in the background while the computer gets on with it. Romdos is the same, except that it comes on ROM and so doesn't need to be loaded in every time you use the computer. Rodos works slightly differently and has some very clever functions built in to it, but is not compatible with many programs. Rodos is only available on ROM.

To use a ROM-based operating system you do, indeed, need a rombox. No other interfaces are required. The disk drive simply plugs straight into the second drive port at the back of the computer.

Siren Software sells a kit containing everything you need to get started. Check out the review on page 58. The address is Siren Software, Wilton House, Bury Road, Radcliffe, Manchester M26 9UR. Tel 061 724 7572.

Check out Amstrad Action's mail order advertisers for details of other 3.5-inch disk drive offers.

KDS can be contacted on 04853 2076.

Romantic Robot lives at 54 Deanscroft Avenue, London NW9 8EN. Tel 081 200 8870.

Getting started

Although everything you need is included in the package, the supplied instructions leave a lot to be desired. Here's AA's step-by-step guide to high-capacity computing.

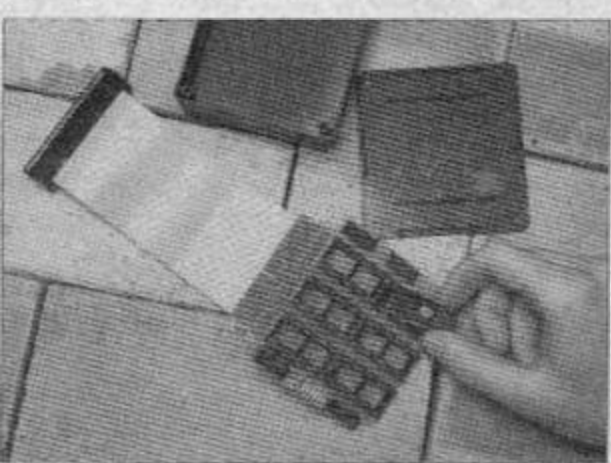

● **INSTALLING THE ROMDOS ROM** You'll need a screwdriver for this. Unscrew the four screws at the corner of the rombox, carefully line up the legs of the ROM with one of the sockets and gently push it home, taking care not to break any of the legs. Switch the ROM on by flicking the corresponding switch inside the box. Screw the lid back onto the top of the box.



● **PLUGGING IN** Make sure the computer is switched off - you could have an expensive bill otherwise! Plug the rombox into the expansion adaptor and the disk drive into the second disk drive port. Plug in the disk drive power supply, switch on the Amstrad. Type IB to check drive 2 is in order. If it doesn't respond, you probably have the disk cable upside-down.

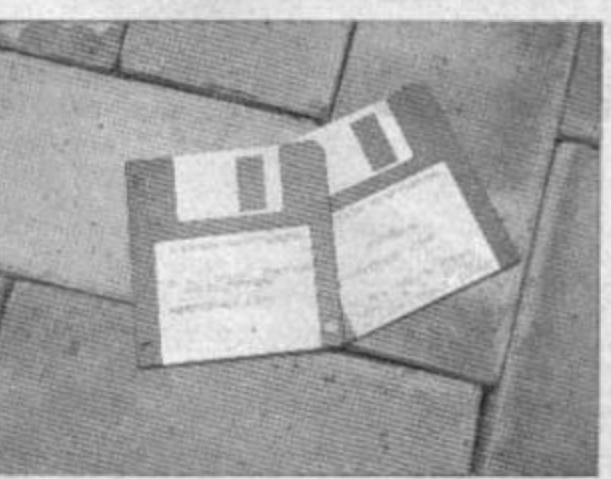

● **COPYING SOFTWARE** The Ramdos and utilities software is supplied on two 3.5-inch disks, and need to be copied onto a 3 inch 'work disk', which is a bit of a nuisance but otherwise painless. The easiest way is to use the ramdisk's Copy function. Insert the utilities disk into drive B, type RUN*RD followed by I COPY, "B:*.*", "A". Repeat the process to copy Ramdos.

● **FORMATTING A DISK** The Format utility supplied by Siren is much the easiest way to format a disk. Four types of format are available, offering between 712K and 796K of storage. The lowest capacity format offers greatest compatibility with disk editors and the like. Other options allow twice the number of directory entries, from 128 to 256.

DISK DRIVE BARGAIN PACK

£99.99 (plus £4.00 p&p) ● Siren Software ● Wilton House, Bury Road, Radcliffe, Manchester M26 9UR. Tel 061 7244 7572

Adding a 3.5-inch second disk drive to the Amstrad offers a cheap, large-capacity alternative to 3-inch disks. But getting an efficient system set up involves buying several components, often from different suppliers. ADAM WARING finds out whether Siren's all-in-one package provide the solution at an unbeatable price...

Four times the space for a quarter of the price: a 3.5-inch drive offers a great deal in the byte-per-pound stakes of storage capacity. Amstrad's 3-inch disks give 178K of data per side and will cost you about £2 apiece, even if you buy in bulk. 3.5-inch disks offer 800K without needing to turn the disk over, and can be picked up for as little as 50p each with a little bit of advert scanning.

A second drive is useful for anyone who uses their computer for anything more than games-playing. Copying files from one disk to another is so much easier, for a start, as there is no tedious disk-swapping. And there's the

bonus of having large amounts of storage space on a single disk.

The CPC and Plus computers use an industry-standard disk interface and so will work with most disk drives fitted with an appropriate connector. However, the Amstrad's built-in disk operating system is only designed to work with a disk size of 178K, and while a drive may be capable of much more, the built-in DOS isn't.

- Siren's package comprises:
- A slimline 3.5-inch disk drive
 - The Romdos disk operating system (which allows you to use the far greater storage potential of 3.5-inch disks)

ROMs and romboxes

Although you can use the 3.5-inch disk drive straight away, Amstrad's built-in operating system will only allow you to use disks formatted to the usual 178K - this is actually twice as wasteful, as you can't flip a 3.5-inch disk over to use the other side the same way you can with a 3-inch disk.

To realise the full advantages of a high-capacity second drive, an additional disk operating system is required. Disk operating systems are available on disk, and once installed allow the machine to take advantage of the higher-capacity drives.

But having to load in the disk operating system every time you want to use the machine is a bit of a bind. The best solution is to use a disk system permanently stored on ROM. A ROM-based system is always at hand, from the instant you switch on the machine.

Siren supplies Romdos, probably the most popular operating system available. Romdos takes control when the computer attempts to

use any of the disk commands, allowing the greater capacity of the disk drive to be used.

Also included is Ramdos, which can be loaded in and used as a disk operating system in its own right, and also has some extra utilities. Formatting, for instance, is carried out with a utility on the Ramdos disk. Siren has also included some extra utilities, such as a RAM disk, a disk editor and a faster formatting program.

You can't plug roms directly into the machine though - you need a rombox. A rombox fits into the expansion port and allows a number of these chips to be plugged in.

The supplied rombox will accommodate up to six ROMs, so as well as Romdos, there's space for another five chips as well. The ROMs are plugged directly into sockets mounted on a circuit board, and can be switched on and off by a set of tiny switches inside the box (a touch inconvenient, since to switch off a ROM you have to open up the box with a screwdriver!).



● All this for a whisker under £100? Siren Software's 3.5-inch disk drive pack is excellent value.

- A rombox (needed for *romdos*)
- A bunch of utilities thrown in for good measure.

The disk drive is well built with a sturdy metal case and is also very quiet in operation – there are no clunks and clanks as the disk whirrs around. It's also a darned sight prettier than Amstrad's FD2 second drive, which has all the elegance of a breeze block.

The instructions are a little unclear, giving separate directions for plugging in the drive, using *Romdos* and the correct operation of the rombox. In addition, the software is supplied on two 3.5-inch disks formatted to 178K. These

need to be copied onto an 3 inch disk before you can use them. This is extra hassle, but presumably it keeps the cost down and only needs to be done the once anyway.

Siren is offering everything you need to use a high capacity drive in one simple package. It cuts out the hassle of having to buy all your bits and pieces from different suppliers. In addition, you get them at a very attractive price.

If you were intending to buy a second disk drive anyway, then you'd be a fool to ignore this option. And if you weren't considering such an upgrade for the moment, then maybe it's time you did.

AA

GOOD NEWS

- All you need in one package
- All components are well made
- You can't buy this set up for less!

BAD NEWS

- Instructions are a little unclear
- Software needs copying to 3 inch disk before use

Verdict 92%

SOUNDBLASTER

£34.95 ● Siren Software ● Wilton House, Bury Road, Radcliffe, Manchester M26 9UR. Tel 061 724 7572

Believe it or not, the CPC range has rather impressive sound capabilities. A three channel sound chip with stereo output lurks inside the machine. Will the Soundblaster unleash the beast within, asks ADAM WARING...?

It's a pity that the Amstrad is equipped with such a puny speaker tucked round the back of the casing. Siren's Soundblaster is set to overcome this problem. It takes the sound signal, pumps it through a powerful stereo amplifier, and then through a pair of car speakers. At five watts per channel, there's enough output to have your Mum banging on the ceiling – and you can also plug in a pair of Walkman headphones if the neighbours get to stropy.

The Soundblaster looks like a slab of cream-coloured cheese, which doesn't complement the CPC's casing one little bit. This is because it's sold for a variety of computers. There are a few shoddy design elements too – all the plugs and

sockets are the same type, whether it's for speakers, headphones or power supply, and it's



● Want more noise? Siren's plug-in Soundblaster delivers!

all too easy to plug the wrong bits into the wrong places.

Each channel has a separate volume control. Strangely, they are set so that turning them anti-clockwise notches up the volume – the opposite way to normal. What we thought would be a relatively subdued setting made everybody in the surrounding offices jump out of their skin!

The Soundblaster does its job. It's loud enough to have the neighbours complaining and sound quality remains good even on the higher volume settings.

GOOD NEWS

- Loud and clear!
- Impressive-looking speakers

BAD NEWS

- A few design problems
- Not that pretty

Verdict 73%

GALLERY

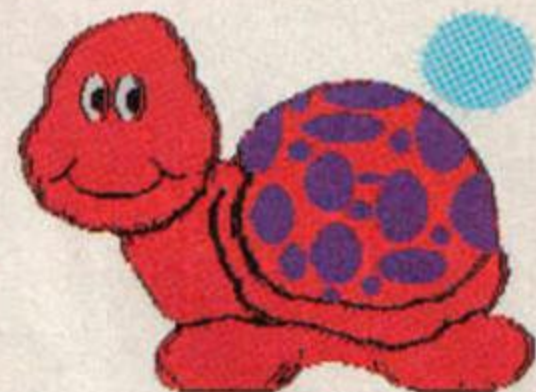

Hello, my name's TOMMY TORTOISE, and I'm hosting the triumphant return this month of the AA Art Gallery (Paul Tomlinson of Yeovil drew me on *Smart 2* incidentally). Anyway, let's have a look at your pics. Eek, eek...



● Good old Aaron Slocombe of Bridgwater in Somerset. Off he went, down to the river-bank at the dead of night with his CPC, to paint us this. What a star, eh? Cheers, Aars.



● The KLF is going to rock you. Wooo wooo. Yo, Tim Blackwood of Liversedge, West Yorks, jack that body on the dancefloor. Wooo wooo.



● Daft old fool. Oh sorry Mr Reagan sir, mistook you for someone else. And hey, put the big grey guns down, okay? Another Liversedge export.



● Denstone lad Stuart Ryder has done us a pic of everyone's favourite bald Welshman.

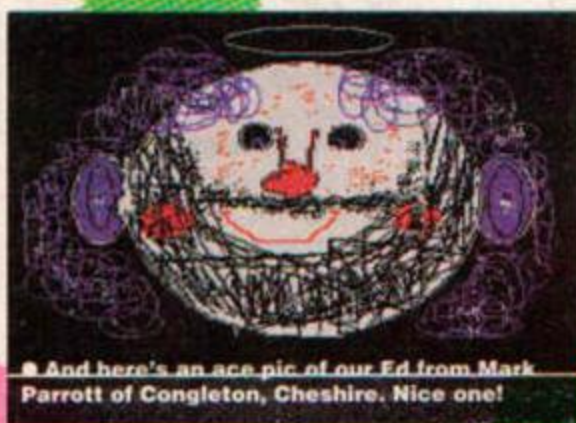

● And here's an ace pic of our Ed from Mark Parrott of Congleton, Cheshire. Nice one!



● Tim Blackwood's early '90s meisterwerk, *Television set in middle of nuclear meltdown*. Hmm, interesting use of the colour orange.

SMART 2 - NOW WITH 16 COLOURS!

You've fiddled about with the art program on last month's covertape and created a few groovy pics. Now you want a few extra colours to play around with, you greedy person you. Okay then just load the program (in other words type `LOAD smart2` not `RUN`). Five lines need slight changes. Type `EDIT` and the line number, then type the bits in red in, erasing what used to be in their place.

```
(Ltav) 10 BORDER 0:MODE 4:SYMBOL AFTER 32
(Crcj) 60 PRINT CHR(23);CHR(8);:WINDOW 1,20,4,25:PAPER 0:WINDOW1,1,20,3,25
(DIep) 880 WINDOW 21,22+23-1,25,24+25-1:PAPER 05:CLS:PLOT 32#A1-32,414-(16#A3):DRAW A2#32-
      2,0,1:DRAW 0,-(A4#16-2):DRAW -(A2#32-2),0:DRAW 0,A4#16-2
(BScj) 1200 ch=-1:FOR f=w TO 0 STEP 4:IF TEST(f,v1)=rd THEN ch=0:NEXT
(EqBt) 1220 FOR f=w TO 640 STEP 4:IF TEST(f,v1)=rd THEN ch=0:NEXT
```

Line 2870 needs to be entered in full. Here it is:

```
(CkFv) 2870 RESTORE 880:LOCK2 IN 10:PRINT"PLEASE WAIT" (FOR F=65 TO 81:FOR C=0 TO 5:READ N(C):
      24(5)=FROM(N(C)):"00000":N(C)=VAL"00"+N(C)):NEXT:SYMBOL F,N(0),N(1),N(2),N(3),N(
      4),N(5),N(6),N(7):NEXT:MODE 0:RETURN
```

Then SAVE the program, and voila. A palette of 16 colours (out of the full 27) for you to apply your painterising powers to.

SHOW US YOURS

We want your pictures, art pickers: Send us your *Smart 2*, *Advanced Art Studio*, or whatever, piccies (on tape or disk) to:

**Art Gallery, Amstrad Action, 30
Monmouth Street, Bath, Avon
BA1 2BW.**

The pic of month wins its creator either a £25 mail order voucher or a punch on the nose (please specify which you'd prefer). Caralumba!



NEW! CARTOON CLASSICS PACK

HARDWARE:	SOFTWARE - PRODUCTIVITY
512K AMIGA 500 £329.99	DELUXE PAINT III £79.99
A520 TV MODULATOR FREE	PLUS! FREE FROM SILICA
A501 RAM EXPANSION £99.99	ARCADE ACTION PACK £229.78
SOFTWARE - ENTERTAINMENT	PHOTON PAINT 2.0 £89.95
BART SIMPSON £24.99	TOTAL RRP: £906.67
CAPT. PLANET & PLANETEERS £25.99	YOU SAVE: £507.67
LEMMINGS £25.99	

£399

PLUS! 16 NIGHTS FREE HOLIDAY ACCOMMODATION

SILICA PRICE - INC VAT + FREE DELIVERY



AMIGA

STAND-ALONE 500 COMPUTER

- 512K AMIGA £329.99
- TV MODULATOR FREE
- MOUSE CONTROLLER FREE

PLUS! - FREE FROM SILICA

- ARCADE ACTION PACK £229.78
- PHOTON PAINT 2.0 £89.95

TOTAL RRP: £649.72
YOU SAVE: £320.72

SILICA PRICE: £329

PLUS! FREE HOLIDAY ACCOMMODATION

£329

SILICA PRICE - INCLUDES VAT + FREE DELIVERY

FREE! FROM WITH SILICA EVERY

ARCADE ACTION PACK

The new Arcade Action Games Pack is THE software compendium for Amiga owners, featuring ten top titles with a variety of different types of games for you to enjoy. Each title is packaged in its own plastic case, with a colour sleeve and full instructions. The Arcade Action Pack is FREE! when you buy your Amiga 500 from Silica.

FREE! WORTH **£219.78**

ARCADE ACTION GAMES PACK

AMIGA

TOTAL FREE PACKAGE

ARCADE ACTION PACK - £229.78:

- Asterix - By Coktel Vision £24.99
- Chess Player 2150 - By CP Software £24.95
- Drivin' Force - By Digital Magic £24.95
- Live & Let Die - By Elite £19.99
- Onslaught - By Hewson £24.99
- Pipe Mania - By Empire Software £24.99
- Rick Dangerous - By Firebird £24.99
- Rock 'n' Roll - By Rainbow Arts £19.99
- Skweek - By US Gold £19.99
- Trivial Pursuit - By Domark £19.95

ART PACKAGE - £89.95:

- Photon Paint 2.0 - By Microworlds £89.95

TOTAL RRP: £319.73

FREE! WORTH NEARLY: £320

PLUS! FREE HOLIDAY ACCOMMODATION

FREE! PHOTON PAINT 2.0 GRAPHICS PACKAGE

Every Amiga 500 from Silica Systems comes with a FREE Photon Paint 2.0 (RRP £89.95), one of the most advanced art packages available for the Amiga. With it, you will be able to harness the extraordinary graphics power of the Amiga and produce inspirational pictures in minutes. With 4096 colours, your pictures will reach life-like appearance. These can be animated in real-time using a vast range of graphical effects, including blending colours and dithering, stencils, shadowing, contour mapping and surface mapping.

WORTH £89.95

FREE! 16 NIGHTS HOLIDAY HOTEL ACCOMMODATION

Every Amiga from Silica comes with a FREE 72 page, full colour brochure with accommodation vouchers. These vouchers entitle 2 people to stay up to 16 nights in one hotel (or any number of hotels to a total of 16 nights) with accommodation FREE (you could take up to six nights for four people, or other options). Choose from the 250 hotels featured in the catalogue. All you have to pay for are your meals (prices are listed in the brochure). Reduced rates in top London hotels and hotels in France are also featured.

SILICA SYSTEMS OFFER YOU

- **FREE OVERNIGHT COURIER DELIVERY:** On all hardware orders shipped in the UK.
- **TECHNICAL SUPPORT HELPLINE:** Team of Amiga technical experts at your service.
- **PRICE MATCH:** We normally match competitors on a "Same product - Same price" basis.
- **ESTABLISHED 12 YEARS:** Proven track record in professional computer sales.
- **BUSINESS + EDUCATION + GOVERNMENT:** Volume discounts available for large orders.
- **SHOWROOMS:** Demonstration and training facilities at our London & Sidcup branches.
- **THE FULL STOCK RANGE:** All of your Amiga requirements from one supplier.
- **FREE CATALOGUES:** Will be mailed to you with offers and software/peripheral details.
- **PAYMENT:** By cash, cheque and all major credit cards.

Before you decide when to buy your new Amiga computer, we suggest you think very carefully about WHERE you buy it. Consider what it will be like a few months after buying your Amiga, when you may require additional peripherals or software, or help and advice with your new purchase. And, will the company you buy from contact you with details of new products? At Silica Systems, we ensure that you will have nothing to worry about. We have been established for over 12 years and, with our unrivalled experience and expertise, we can now claim to meet our customers requirements with an understanding which is second to none. But don't just take our word for it. Complete and return the coupon now for our latest Free literature and begin to experience the "Silica Systems Service".

MAIL ORDER: 1-4 The Mews, Hatherley Rd, Sidcup, Kent, DA14 4DX Tel: 081-309 1111
Order Lines Open: Mon-Sat 9:00am-6:00pm No Late Night Opening Fax No: 081-309 0908

LONDON SHOP: 52 Tottenham Court Road, London, W1P 0BA Tel: 071-580 4000
Opening Hours: Mon-Sat 9:30am-6:00pm Late Night: Thursday until 8pm Fax No: 071-323 4737

LONDON (SELFRIDGES): 1st Floor, 369 Oxford Street, London, W1A 1AB Tel: 071-629 1234
Opening Hours: Mon-Sat 9:30am-6:00pm Late Night: Thursday until 8pm Ask for extension 3914

SIDCUP SHOP: 1-4 The Mews, Hatherley Rd, Sidcup, Kent, DA14 4DX Tel: 081-302 8811
Opening Hours: Mon-Sat 9:00am-5:30pm Late Night: Friday until 7pm Fax No: 081-309 0017

To: Silica Systems Ltd, Dept AMACT-0991-60, 1-4 The Mews, Hatherley Rd, Sidcup, Kent, DA14 4DX

PLEASE SEND FREE AMIGA COLOUR CATALOGUE

Mr/Mrs/Ms: Initials: Surname:

Address:

Postcode: Tel:

Which computer(s), if any, do you own?

MAIL ORDER HOTLINE
081-309 1111

SILICA SYSTEMS

© 1992 Silica Systems Ltd. Advertised prices and specifications may change - please return the coupon for the latest information.

AA SMALL ADS

For Sale

CPC464 colour monitor, hardly used, around 50 games plus 9 boxed games, 2 joysticks, manual, few magazines. Worth £300, sell for £200. Unable to deliver. Phone Paul, 07524 410063.

Amstrad CPC464, colour monitor, can part-ex green screen monitor if poss. Phone Chris, 0257 426776.

Amstrad CPC6128, colour monitor with all manuals, Multiface 2, tape recorder, dustcovers, lots of software, blank disks, magazines, all vgc. £170. Can deliver within S.E. region. Phone Thomas, 081 699 0556 evenings or weekends.

Amstrad CPC6128 mono, good condition, includes utilities, mouse, art packages, games, manuals, books, magazines and twenty blank disks. Only £200 for quick sale. Phone Richard, 0734 318685.

CPC6128 colour, 2nd 3.5-inch drive, DMP2160 printer, TV tuner, mouse, Multiface, manuals, software, magazines. GX4000 games console with games. Everything boxed, vgc. "Everything" for only £375 ono. Phone Michael, 07048 78874.

CPC6128 colour monitor & new tape deck, £400 & disk and tape games including *F16*, *Cheat Mode 2*, megaboard joystick. Cost over £900, now £450 ono. Phone Tim, 0525 60213 after 5pm.

Back issues Amstrad Action, numbers 6 to 10, £17.00, thereafter £16.50 per

10 consecutive issues up until present. All in excellent condition. Phone Keith, 0732 456929.

CPC6128 colour monitor, joystick, manual, games including *E-Motion*, *Shadow Dancer*, plus *Mini Office 2* & tapes. £250 ono. May deliver. Phone 081 941 4473 after 6pm.

CPC464 mono (excellent condition), disk drive, 64K expansion, MP-2 modulator, mouse, 10 blank disks, AAs 27-63 (including covertapes), £400+ software. Worth over £1000, accept £550 ono. Phone Brett, 081 688 1576 after 4pm.

Amstrad GX4000 console, power adaptor, two game paddles, TV lead, *Switchblade*, *Pang*, *Dick Tracy*, *Burnin' Rubber* and *Tennis Cup 2*. Worth over £200, will accept £90. Phone Graham, 0442 61019.

CPC6128, great condition, colour monitor, Multiface 2, new disk drive only installed, £100s worth of software including *Mini Office*, *Daypac 80* and DTP, stacks of mags. £300. Phone Pauric, 06626 48115 on Sundays.

Amstrad hardware speech ROM with stereo booster, light pen, *Music Machine*. The lot £60. Phone Paul, 031 660 4721.

Amstrad CPC464 colour monitor, disk drive, Multiface 2, mouse, lightpen, 70+ games, joystick, 11 blank disks, manuals, 500+ pokes, mags. £400 ono. One year old. Phone Andrew, 051 677 5052 after 4:30pm.

CPC464, TV modulator, disk drive, 64K

memory expansion, joystick, £100+ software - *X-Out*, *Lords of Chaos*, *Image System* on tape & disk, numerous manuals & books. Will sell for £100 ono. Phone 0865 863177 evenings.

Amstrad 6128 colour, 2 drives, joystick, Multiface 2, spreadsheets, word processors, spellcheckers, mouse, spare disks, top games, magazines, manuals, value £900, all in perfect working order. £299.00 cash. Phone Fred on 081 888 1532 any time.

Amstrad software for sale, pristine condition and not copies, on disk and tape. Send SSAE for list. Phone Mark, 081 681 5543.

CPC464 fully upgraded to CPC6128, colour monitor, DMP2000, joystick, mouse, lightpen, Multiface, *Stop Press*, *AMX Art*, *Protext*, *Mini Office*, two disk drives, £600+ software utilities and manuals £800 ono. Phone 0493 751098.

CPC6128 colour monitor, joystick, mouse, art package, over £300 worth worth of disk games. All good condition. Worth £1000, sell £350 ono. Phone Robert, 0753 593311 after 6pm.

CPC464, monitor, £150 games, *Chase HQ*, *Robocop*, *Afterburner* etc, TV modulator, joystick, books and magazines, 100 type-in programs, book, word processor and some children's easy games, excellent condition £250 ono. Phone 041 777 8224.

Pagemaker Deluxe DTP for 6128/664+64K. Reviewed AA73 p22.23 - "Cheap but not nasty." Verdict 95%. Amazing value for only £5 inclusive. SSAE for details. CPC Domain, 119 Laurel Drive, East Kilbride, Glasgow G75 9JG.

CPC464 colour monitor, 10 disks + drive, joystick, dust covers, over 100 games including *Mini Office II*, *Gunship* etc plus loads of magazines, only £275. Phone Paul, 0274 879333.

CPC6128 with colour monitor, AMX mouse, mat, home, interface, *OCF Art Studio*, *Mini Office II*, £700+ of games, top titles on tape & disk, joystick + tape

recorder. £399 ono. Phone Andrew, 0924 257853.

Amstrad CPC464 colour monitor, lots of games: *Switchblade*, *Stunt Car Racer* and *Turrican*, joystick and AAs worth £450+ sell for £220 ono. Phone 0382 459298.

Amstrad 464 Plus, colour monitor, joystick, controller paddle, £500 worth of software, magazines, nine months old, worth £900, sell for £450 ono. Phone Graeme, 0325 486628 between 6pm and 8pm.

Wanted

Has anyone got the CPC464 welcome instruction cassette to sell? For new beginner. Holly, aged 7. Phone Madge, 061 437 9488.

User Group

Print-Out (Issue 9) - 40 A4 pages of news, tutorials, listings, advice and many other features for all CPC/Plus users. Articles include BASIC, machine code & CP/M tutorials & free supplement for Plus owners. Costs £1.10. Phone Thomas, 0279 651487.

Has your user group folded? Join the United Amstrad User Group, established 1986, bi-monthly magazine, book library, discounts. Free PD library. SAE to UAUG, 26 Uplands Crescent, Fareham, Hants PO16 7JY.

CPC Domain - the only monthly magazine for serious CPC users. Only £1.25 for over 40 packed pages. Six month subscription for £7.50. CPC Domain, 119 Laurel Drive, East Kilbride, Glasgow G75 9JG.



This section offers you a really cheap and effective opportunity to speak direct to 30,000 CPC owners - or would-be owners. You can place an ad up to 30 words for just £5. So you could use it to sell a printer, launch a user group or advertise a piece of software you've written. (One thing you can't advertise is the sale or swap of software. Such ads can be used by pirates.) Fill in the application form and send it to us together with payment. We'll place the ad in the next available issue (published 2-7 weeks after we receive your order). ● We can print only your first name and phone number, so please make sure these are included.

ORDER FORM

SEND TO AA SMALL ADS, FUTURE PUBLISHING LTD, BEAUFORD COURT, 30 MONMOUTH STREET, BATH, AVON BA1 2AP

Please place the following advertisement in the next available issue of *Amstrad Action*

Name _____

Address _____

Telephone _____

I enclose payment of £5.00 by Cheque/ P.O./ Access/ Visa

Credit Card number _____

Credit Card expiry date _____

Classification. Tick box: For sale Wanted Services User Groups Other

Write your advertisement here, one word per box. Include your first name and phone number.



ATARI ST

520ST-E DISCOVERY XTRA PACK

RETURN THE COUPON FOR A FREE! COLOUR CATALOGUE

HARDWARE:	
512K 520ST-E + MOUSE	£329.99
ENTERTAINMENT SOFTWARE:	
ANARCHY - Arcade Game	£19.99
DRAGONS BREATH - Adventure	£29.95
INDIANA JONES - Arcade Adv	£19.95
SUPER CYCLE - Racing Game	£19.95
PRODUCTIVITY SOFTWARE:	
CONTROL ACC - Utility Software	FREE
EMULATOR ACC - Utility Software	FREE
FIRST BASIC - Programming	£49.99
NEOCHROME - Art Package	£29.99
ST TOUR - Tutorial	£4.99
JOYSTICK CONTROLLER:	
ATARI CX40 JOYSTICK	£4.99
PLUS! FREE FROM SILICA:	
TENSTAR GAMES PACK	£219.78
PRODUCTIVITY PACK	£104.97
TOTAL VALUE:	£834.54
YOU SAVE:	£505.54
SILICA:	£329
PLUS! FREE HOLIDAY ACCOMMODATION	£329



1040ST-E FAMILY CURRICULUM PACK

The Family Curriculum Pack comes with a 1040ST-E computer and mouse plus 5 software modules (3 titles in each), one for every age range. The combination of education, creative and business software from Atari, plus the FREE entertainment and productivity packs from Silica, makes for a package the whole family can enjoy!

PLUS! FREE HOLIDAY ACCOMMODATION

1M5 1040ST-E + MOUSE	£399.99
1. PLAY & LEARN	£76.59
2. JUNIOR SCHOOL	£58.54
3. GCSE REVISION	£55.54
4. BUSINESS COMPUTING	£159.85
5. CREATIVE COMPUTING	£134.97
PLUS! FREE FROM SILICA	
TENSTAR GAMES PACK	£219.78
PRODUCTIVITY PACK	£104.97
TOTAL VALUE:	£1210.23
YOU SAVE:	£811.23
£399	

SILICA PRICE - INC VAT + FREE DELIVERY

ATARI 520ST-FM DISCOVERY PACK

£279

INC VAT + FREE DELIVERY + FREE TENSTAR & PRODUCTIVITY PACKS

ATARI ST - MORE THAN JUST GREAT GAMES!

FREE! FROM WITH SILICA EVERY ATARI ST

TENSTAR GAMES PACK

The TenStar Games Pack is THE software compendium for Atari ST owners, featuring ten top titles with a variety of different types of games for you to enjoy. Each title is packaged in its own plastic case, with a colour sleeve and full instructions. The TenStar Games Pack is FREE! when you buy your ST from Silica Systems.

FREE! WORTH **£219.78**

TENSTAR GAMES PACK

TOTAL FREE PACKAGE

TENSTAR GAMES PACK - £219.78:	
Asterix - By Coktel Vision	£24.99
Chess Player 2150 - By CP Software	£24.95
Drivin' Force - By Digital Magic	£19.95
Live & Let Die - By Elite	£19.99
Onslaught - By Hewson	£19.99
Pipe Mania - By Empire Software	£24.99
Rick Dangerous - By Firebird	£24.99
Rock 'n' Roll - By Rainbow Arts	£19.99
Skweek - By US Gold	£19.99
Trivial Pursuit - By Domark	£19.95
PRODUCTIVITY PACK - £104.97:	
1st Word - Word Processor	£59.99
Spell It! - Spell Checker	£19.99
ST Basic - Programming Language	£24.99
TOTAL RRP:	£324.75

FREE! SILICA SYSTEMS ST PRODUCTIVITY PACK

Every Atari ST from Silica comes with a FREE Silica ST Productivity Pack, worth over £100. This pack has been specially put together by Silica to help you to get to grips with the productive side of computing from day one. Each title has been tried and tested by tens of thousands of Atari ST owners, who have begun word processing with 1st Word and programming with Atari ST Basic.

1st WORD - from GST	£59.99
SPELL IT! - for use with 1st WORD	£19.99
ST BASIC - with tutorial	£24.99
TOTAL RRP:	£104.97

FREE! 16 NIGHTS HOLIDAY HOTEL ACCOMMODATION

Every Atari ST from Silica comes with a FREE 72 page, full colour brochure with accommodation vouchers. These vouchers entitle 2 people to stay up to 16 nights in one hotel (or any number of hotels to a total of 16 nights) with accommodation FREE (you could take up to six nights for four people, or other options). Choose from the 250 hotels featured in the catalogue. All you have to pay for are your meals (prices are listed in the brochure). Reduced rates in top London hotels and hotels in France are also featured.

FREE! WORTH NEARLY: **£325**

PLUS! FREE HOLIDAY ACCOMMODATION

SILICA SYSTEMS OFFER YOU

- **FREE OVERNIGHT COURIER DELIVERY:** On all hardware orders shipped in the UK.
- **TECHNICAL SUPPORT HELPLINE:** Team of Atari technical experts at your service.
- **PRICE MATCH:** We normally match competitors on a 'Same product - Same price' basis.
- **ESTABLISHED 12 YEARS:** Proven track record in professional computer sales.
- **BUSINESS + EDUCATION + GOVERNMENT:** Volume discounts available for large orders.
- **SHOWROOMS:** Demonstration and training facilities at our London & Sidcup branches.
- **THE FULL STOCK RANGE:** All of your Atari requirements from one supplier.
- **FREE CATALOGUES:** Will be mailed to you with offers and software/peripheral details.
- **PAYMENT:** By cash, cheque and all major credit cards.

Before you decide when to buy your new Atari ST computer, we suggest you think very carefully about WHERE you buy it. Consider what it will be like a few months after buying your ST, when you may require additional peripherals or software, or help and advice with your new purchase. And, will the company you buy from contact you with details of new products? At Silica Systems, we ensure that you will have nothing to worry about. We have been established for over 12 years and, with our unrivalled experience and expertise, we can now claim to meet our customers requirements with an understanding which is second to none. But don't just take our word for it. Complete and return the coupon now for our latest Free literature and begin to experience the "Silica Systems Service".

MAIL ORDER:	1-4 The Mews, Hatherley Rd, Sidcup, Kent, DA14 4DX	Tel: 081-309 1111
Order Lines Open:	Mon-Sat 9:00am-6:00pm	No Late Night Opening
LONDON SHOP:	52 Tottenham Court Road, London, W1P 0BA	Tel: 071-580 4000
Opening Hours:	Mon-Sat 9:30am-6:00pm	Late Night: Thursday until 3pm
LONDON (SELFRIDGES):	1st Floor, 369 Oxford Street, London, W1A 1AB	Tel: 071-629 1234
Opening Hours:	Mon-Sat 9:30am-6:00pm	Late Night: Thursday until 3pm
SIDCUP SHOP:	1-4 The Mews, Hatherley Rd, Sidcup, Kent, DA14 4DX	Tel: 081-302 8811
Opening Hours:	Mon-Sat 9:00am-5:30pm	Late Night: Friday until 7pm

To: Silica Systems, Dept AMACT-0991-63, 1-4 The Mews, Hatherley Rd, Sidcup, Kent, DA14 4DX

PLEASE SEND FREE ATARI COLOUR CATALOGUE

Mr/Mrs/Ms: _____ Initials: _____ Surname: _____

Address: _____

Postcode: _____ Tel: _____

Which computer(s), if any, do you own? _____

MAIL ORDER HOTLINE
081-309 1111

SILICA SYSTEMS

PLEASE - Advertised prices and specifications may change - please return the coupon for the latest information.

Subscribers' Club

You not only receive an ace gift when you subscribe - you can also take advantage of our exclusive subscriber offers! An extra bonus or what? Just you take a look!

This month's special offer to subscribers is...



MASTER
GAME

from Mirrosoft - a brilliant conversion of the blockbusting Konami coin-op arcade game.

Subs Club Price

CASSETTE £7.99 (RRP £11.99)

DISK £10.99 (RRP £15.99)

To order please use the coupon opposite.

SUPERB SOFTWARE WHEN YOU SUBS



THE ADVANCED GCP ART STUDIO

Simply the best art program around for the Amstrad! Comprehensive and easy to use, it's packed with features and is icon driven.

- The package normally retails for £22.99 but this special AA version is yours as a gift!
- Disk only. 128K memory required.
- Mouse not included.



BUILDER LAND

Guide Melba to safety across a hazard-strewn landscape in Loricel's challenging scrolling puzzle game.

MASTER
GAME

BACK ISSUES

SORRY SOLD OUT

ISSUES 1-50, 52, 54, 56, 57, 58, 59

ISSUES STILL AVAILABLE

51 • £1.45

Batman and Powerdrift get the treatment, PC Show report, RSX LIB, Nirvana and Sprites Alive reviewed.

53 • £1.45

EPROMs feature, PD column begins plus an awesome Batmap.

55 • £1.45

Education special, Heart research, Phil Howard takes over Cheat Mode with Myth Mastergame.



ISSUE 61 • £1.95

Fifth birthday issue with cover tape and special boardgame. Iron Lord and Monty Python reviewed.



ISSUE 62 • £1.60

Past, present and future of film films. Rick Dangerous II Mastergame. CES report.



ISSUE 63 • £1.60

Shadow of the Beast and Learn to Read with Prof reviewed. Part 1 of the AA end-of-year games retrospective.



ISSUE 64 • £1.60

Switchblade on the console reviewed. AA Christmas covertape including Pizznic demo, Lost Caves & Sprites Alive game.



ISSUE 65 • £1.60

Complete guide to word processing for beginners. Ninja Turtles, Lotus Challenge and Gazza II reviewed.



ISSUE 66 • £1.60

How to beat games - a 6-page guide to all the best techniques. North & South reviewed plus Robocop II on the console! Also, Fun School 3 arrives.



ISSUE 67 • £2.20

Part one of our DTP special. Boxed covertape includes full versions of Dizzy and Hydrofool, plus a playable demo of Total Recall.



ISSUE 68 • £2.20

No less than four Mastergames! Total Recall, F-16 Combat Pilot, Bat and Switchblade all win AA's most prized accolade. Includes covertape packed with games and demos.



ISSUE 69 • £2.20

Learn how to be an artist with your Amstrad. Amor's new printing utility Prototype reviewed. Nightshift, Navy, Prince of Persia, Dick Tracy, Predator 2 and much more!



ISSUE 70 • £2.20

Superb console game Pang reviewed. Also, new, action-packed budget section begins. Plus Donald's Alphabet Chase, Tearaway and Shadow Dancer.



ISSUE 71 • £2.20

Hero Quest and 3D Construction Kit demos on the covertape - plus Devpac assembler! Turrican 2 reviewed. Hero Quest, Z80 Simulator and Fun School 3.



ISSUE 72 • £2.20

Domark's 3D Construction Kit gets a special feature review. Ocean's Power Up scores 85%. Full, working database on the covertape. All your regular tips, news letters.



ISSUE 73 • £2.50

Free covermounted tips booklet. Turrican 2 and Thunderjaws demos on the covertape. Budget DTP program and Robozone reviewed plus Ocean's Plotting on cart.



ISSUE 74 • £2.50

Turtles 2 demo on the covertape plus two complete games. Brand new buyers' guide starts. Fujitsu DL900 24-pin printer reviewed. Terminator 2 and Final Fight.

ABOVE PRICES
FOR UK ONLY

Overseas prices:

Europe £5

Rest of World £7

To order back issues use the subscriptions order form opposite.

RE - YOURS AS A GIFT - CRIBE TO AMSTRAD ACTION



ROBOZONE

Save the world from ecological disaster with Imageworks' excellent shoot-em-up. Three distinctly different levels and game styles, and enough of a challenge to keep you struggling for ages. Superb graphics.

The benefits of subscribing...

- **You guarantee your copy**
- avoid missing any vital information and advice.
- **You get it delivered at no extra charge**
- save the time and trouble of having to go and find your copy every month.
- **You get first refusal on all special offers**
- normally at exclusive discount prices.
- **You protect yourself against inflation**
- the price you pay is guaranteed for the duration of your subscription. Even if the cover price goes up, you don't pay a single penny more.
- **You get complete peace of mind**
- not only are you assured of your copy each month you also have a no-risk guarantee.
- **You receive a gift software package of your choice**
...you know it makes sense!

**COMPLETE
THE COUPON AND
RETURN IT TODAY.
ALTERNATIVELY, CALL
OUR CREDIT CARD
HOTLINE ON
0458 74011**

**Don't miss out, get your copy of AA delivered
and claim your gift software - all for less than
you'd pay at the newsagent!!**

YOUR NO QUIBBLE, NO RISK GUARANTEE!

YOU CAN CANCEL YOUR SUBSCRIPTION AT ANY TIME IN THE FUTURE AND WE WILL REFUND YOU IN FULL FOR ALL UNMAILED ISSUES.

YES! PLEASE ENTER/RENEW MY SUBSCRIPTION TO AMSTRAD ACTION AT THE ALL INCLUSIVE PRICE OF TICK AS APPROPRIATE

12 ISSUES

UK £29.95. EUROPE £47.25 REST OF WORLD £63.10

To ensure you receive your magazine and tape quickly and undamaged, all overseas subscriptions are sent Air Mail

MY CHOICE OF GIFT IS TICK YOUR CHOICE

ROBOZONE BUILDER LAND ADVANCED OCP ART STUDIO

PLEASE ALSO SEND ME THIS MONTHS SUBS CLUB SPECIAL OFFER - TURTLES

DISK £10.99 CASSETTE £7.99

If you are an existing subscriber please quote your subscription reference number here - you will find this on your address label _____

PLEASE ALSO SEND ME THE FOLLOWING BACK ISSUES PLEASE INDICATE _____

MY METHOD OF PAYMENT IS TICK YOUR CHOICE

TOTAL PAYMENT £ _____

VISA ACCESS CARD NO. BPS CHEQUE *Make payable to Future Publishing Ltd*

NAME _____ SIGNATURE _____

ADDRESS _____

POST CODE _____

Enclose this coupon (together with your cheque if applicable) in an envelope and send to: AMSTRAD ACTION SUBSCRIPTIONS, FREEPOST, SOMERTON, TA11 7BR

THIS COUPON IS VALID UNTIL 31 DECEMBER 1991 AA/MAG/1291

PROFIT FROM YOUR MICRO £14.95
Comprehensive step-by-step 60 page guide

Recession? What recession? Make your micro earn

- Whatever the make of your micro, you can use it to make a good income even with only a couple of hours spare each week. Ideal for those at home/unemployed.
- NOT pie in the sky, make a million before breakfast nonsense but a true report of exactly the sort of steps we took ourselves at Intraset.
- Easy, sensible business ideas which can easily be used by anyone with any micro. Part or full-time.
- No computer expertise required. Earn £££ from home doing what you enjoy - using your computer.
- Very little capital outlay needed - you probably have everything you need to start earning
- Learn how to find hundreds of potential customers in your area who will gladly pay for your services.
- Full step-by-step 60 page book

Phone or Fax for lightning service.

Send cheques or postal orders to INTRASET LTD
FREEPOST, 10 Woodside Avenue,
Clayton-Le-Woods, Chorley, Lancashire. PR6 7BR.

TEL 025 72 76800

Main office & 24 hr order line

Fax 025 72 74753

Helpdesk 0490 3284

Weekdays 3-4pm

All major credit cards
accepted

All prices include P&P and VAT
Overseas orders add £5.00

CASHMASTER

Home and business accounts £39.95

Cashmaster is the easiest to use, most versatile accounts program yet written for both small business accounts or home finance. We wrote CASHMASTER for our own use, out of sheer frustration with other 'easy to use' packages.

Just look at Cashmaster's main features:

- Easy, natural data entry - just like a handwritten ledger.
- Full vat analysis if needed
- VAT inclusive, exclusive or zero-rated entries
- Unlimited no. of ledgers at one time - limited only by disc space
- Span any time period - no set period or 1 year limit
- 1000 User-definable class and 1000 accounts codes
- Detailed statements by selected Classes and Accounts
- Profit and loss-type statement
- Tagging of entries for selective reports
- Automatic repeat of entries - standing orders etc. (Yearly, Half-Yearly, Quarterly, Monthly, Fortnightly, or Weekly)
- Automatic date-sorting of entries - entries can be inserted anywhere in ledger
- Output reports to screen, printer or disc file
- Reference field for each entry - Invoice or Cheque no.
- Split and merge ledgers at any time
- All functions available from main program screen - Class and Account codes visible at all times
- Pop-up running-total calculator with one key press.

The most user-friendly, powerful and versatile accounts package yet - *you won't be disappointed.*

CASHMASTER INVOICING & STOCK CONTROL

Companion to Cashmaster or standalone program £39.95

- Full Customer Data file - easy to find account records
- Full Stock Data file, Price Lists, Re-order lists
- Full invoicing with user-defined messages
- Full invoice editing, Invoice To & Deliver To fields
- Settlement, No-Return and Line discounts

A standalone, or integrates with Cashmaster for a fully featured accounts/invoicing package costing less than a quarter the price of its rivals.

SPECIAL OFFER - both programmes £69.95 Saving £9.95

THE GRAPHOLOGIST

Handwriting analysis program £49.95

'Uncannily accurate' 8000 Plus Magazine
'Recommended highly for the novice and the professional' Micromart

From the beginner to the expert, use The Graphologist to analyse your handwriting, your partners, friends, business associates, prospective employees.

With a sample of handwriting, answer the on-screen questions and follow the instructions. Anything from a signature analysis to a full 15 page complete character report, including career ambition and health through to sexual preferences and megalomania. Edit this report using your word processor for a professional presentation.

The Graphologist is a valuable business tool as well as entertaining and fun. Comes complete with comprehensive manual of graphology.



Intraset Ltd

ONLY POOLS AND HORSES

SENSIBLE PROGRAMS AT SENSIBLE PRICES

Every program written by a mathematician who has spent many years in the betting industry. He KNOWS how the professionals operate. He KNOWS how to help you win.

FOOTBALL BOXFORM Written by a former pools expert for Littlewoods. The program has forecast over 50% more draws than would be expected by chance. Homes, aways and draws shown in order of merit and true odds given for every match. Merit tables show at a glance the teams currently in form and those having a lean spell. Australian Pools program included in the price.

SUPER PLANNER by the same author. full details given of OVER 400 ENTRIES covering up to 57 selections. Includes SINGLE AND MULTIPLE entries of LIT PLANS 1, 2, 9, 25, 27, 28, 29, 47, 48, 49, 50, 79, 80, 81, 82, 83, 84, 96, 100, 200, B37, B38, B39, B49, B50, B54, B58, B59, B145, B180, V-Plans 20, 42, 43, 44, 83, 84, 85, 87, TIP TOP 10 & 15, EXPRESS 35 & 38, MAIL 80, 75, E, P, MIRROR 1 & 8, FULL PERMS 8 from 9 to 8 from 14. All FULLY CHECKED in seconds by your computer. Not just the highest scoring but ALL POSSIBLE WINNING LINES.

POOLS PLANNER Similar to above but covering block permutations using Littlewoods standard guarantee blocks.

RACING BOXFORM Course characteristics (built into the program) as well as the form of the horses are considered in speedily producing an order of merit for each race. Designed for flexibility allowing users to amend the program if they wish. Price still includes the highly acclaimed HANDICAP WINNER - more than 1000 winners every year - over 25% of them at 5/1 or better.

PUNTERS PARTNER Works out almost any bet...doubles, trebles and accumulators including mixed stakes, yankee, Canadian, Heinz, Goliath, patent, union jack, up & down (if cash bets) single & double stakes, round robins, rounders, roundabouts, round the clock, Win or each way. Covers non runners, rule 4, dead heats. Versatile multiple odds calculator for fixed odds bets and the lines required for any full perm you're likely to meet.

PRICES. (Tape) £16.95 each. £25.95 any two. £34.95 any three. For disks please add £2 per program.

SPECIAL OFFERS FOOTBALL BOXFORM, RACING BOXFORM & PUNTERS PARTNER...£27.95 TAPE, £31.95 DISK

FOOTBALL TOOL KIT Football Boxform, Super Planner, Pools Planner, Punters Partner...£30 TAPE, £35 DISK

RACING TOOL KIT Racing Boxform, Punters Partner plus 4 further programs which enable you to keep your own records or produce or amend form and time ratings...£33 TAPE, £38 DISK.

BOTH THE ABOVE KITS...£55 TAPE, £62 DISK.



Advertised for six years in the sporting and computer press
BOXoft CLEVER..GET THE BEST
Please make cheques or Postal orders payable to BOXOFT (CF),
65 Allans Meadow, Neston, South Wirral L64 9SQ
Tel: 051-336 2668

CPC
CMD 64/128
PCW
SPECTRUMS

COMPUTER REPAIRS

★ AMSTRAD AUTHORISED ★

Quality Assured!

- ★ Fixed price repairs on many machines
- ★ Over 2500 square foot engineering complex
- ★ Top quality technicians at your disposal
- ★ All work warranted
- ★ Fast turnaround
- ★ Simply post or hand deliver your machine and we will do the rest

Amstrad 464	£32.00
Amstrad 6128	£36.00 (extra if disk drive)
Colour monitor	£75.00
Others	P.O.A.

Please add £5.00 for 24 hour return courier

Tel: 0582 491949 (4 lines)

WTS Electronics Ltd, Chaul End Lane, Luton, Beds LU4 8EZ

HELPLINE

Feeling helpful? Need help? Can't get past the rhinoceros in *Revenge of the Turnips*? Trying to get hold of a firmware manual or a TV modulator? *Helpline* is here for you.

Just send your first name and phone number, and details of what you're after to: *Helpline*, Amstrad Action, Beauford Court, 30 Monmouth Street, Bath, Avon BA1 2BW. Please write on a postcard or the back of a stuck down envelope and keep it short or you won't get in (or you'll get cut to 'loads of games').

Due to shortage of space, we prefer to only print a first name and phone number. If you want help contact the appropriate Helpliner - not us. And phone only in decent hours!

Piracy is not welcome: don't try it, you'll get booted off. Keep it legal, keep it cool, keep it on the straight and narrow. Yo!

Wanted: *Shadow Dancer*, *Crazy cars 1 & 2*, *Thunderbirds* and *Supercars*. Will swap for: *Turtles*, *X-Out*, *Forgotten Worlds*, *Gemini Wing*, *Red Heat*, *Toobin'* and *Silkworm*. All games on CPC464 cassette.
Philip, 09603 41356 after 5pm

Please, can anyone tell me what finally kills the Nechromancer in *Sorcery Plus*.
Eileen, 0582 873267 5pm-9pm

Help wanted on *Castle Master*. I don't know how to get the key on the roof of the cavern. Also I require help on finding the rest of the keys needed to complete the game.
Karl, 0204 399198

Offered: Limited advice on hardware problems.
David, 0793 532417

Wanted: *Robocop 2* (cartridge) with box and instructions. Will swap for either *Switchblade* (cartridge), *Golden Axe*, *Supercars*, *Ghostbusters 2*, *Fists of Fury (Edit 2)*, all on disk with instructions.
Chris, 0634 683852

Will someone swap their *Rick Dangerous 2* disk for my *APB* and *Cyberoid* tapes? Also wanted: AA back issues 1-48, 50, 51. Will pay a reasonable price.
Tim, 0689 829451 6pm-9pm

Has anyone got *Stop Press* and *AMX* mouse on disk to sell for £20, or a Rombo rombox, KDS 8-bit printer port and a De-cable drive switcher by ABD Holdings to sell for £10 each?
Darren, 0302 864730 after 6pm

Wanted: *Rick Dangerous 2*, P-47 *Thunderbolt*, *Prince of Persia* or *Navy Seals* (tape originals). Will swap for: *Last Ninja 2*, *Licence to Kill*, *Back to the Future 2*, *Indiana Jones & the Last Crusade* and *Temple of Doom*, or *Italy 1990*. Also help wanted on *Batman the Movie*.
Chris, 0752 844946

Wanted: Urgently need colour monitor for CPC 464. Will swap for GT65 Green Screen plus cash, or will buy for under £60.
David, 081-540 9011

Help needed on original 3D version of *Batman*. Where's the seventh bit of Batmobile? Using the batmap in AA9.
Roy, 0977 675522

Broken hearted child needs a *Fruity Frank* cassette for his 464 computer. This was his favourite game which won't load any more. Will gladly pay or swap.
Ricky, 0245 74347

I'm starting a PD library. Help, info and software greatly appreciated.
Paul, 0272 865343 4pm-10pm

Desperately needed for CPC 464: *European Superleague*, *North and South*. Viz. Will swap for a game from a list of twelve, including *Laser Squad* and *Shadow Dancer*.
Simon, 0782 51797

Wanted: *Continental Circus*, *Quattro Cartoon* and *Passing Shot* (all CPC tape). Will swap for: *Green Beret*, *Combat Lynx*, *Soul of a Robot*, *Army Moves*, *Fantasia Diamond*, *Forest at World's End*, *A View To A Kill*, *Adventure Quest* and *Shadow Fire*. (Or will swap three games for one.)
Aram, 081-551 4390

Wanted: *Golden Axe*, *Gauntlet 3*, *Joe Blade*, *Bloodwych*, *Hero Quest*. I will swap combat/sim games - *F-15*, *Acro Jet* and more, *Matchday 2*, *Driller*, *Dark Side* and *Armageddon Man* (all disk) and *Dizzy Collection* (tape). I have a 6128 (preferably on disk, but tape is okay.)
Chris, 0872 222942

Help wanted! Will anybody lend me the *Firmware Guide Soft 198* for a week or so. I will pay postage.
Andrew, 0642 474599

Has anyone got *Amsword* on disk?
Mark, 0272 604303

PEN-PALS

Pen-pal wanted to swap and lend games.
James, 0329 661949 Mon-Fri 4pm-6pm

Wanted: Female pen-pals (but males accepted), 12-14.
Leslie, 0228 45324 6pm-7pm

Pen-pals wanted, all ages, male or female.
Dave, 0270 872217

25-year old Ghanaian Sunday School teacher and Accounting student, wants pen-friend to discuss car and cooker repair and textile designing with. (Honestly, we're not making any of this up.)
Benjamin Akoto Asare, Faith Baptist Church, PO Box 5595, Accra-North, Ghana.

O!

Helpline is for readers wanting help, tips or penpals, or offering any of the above. No money is to change hands, OK? This page is for free help only. If you send in an entry asking for money for your services you're wasting your time and a stamp - it'll be straight in the bin. On the other hand, send in a cheque for £5 and you could go in *Small Ads...*

DON'T MISS YOUR REGULAR COPY OF AMSTRAD ACTION!

Every day we get dozens of phone calls from desperate people. Why are they desperate? Because their newsagent has sold out of their favourite magazine...DON'T LET THIS HAPPEN TO YOU!

Instead, cut out this coupon (or a photocopy) and give it to your friendly newsagent:

Dear Newsagent, please reserve *Amstrad Action* for me each month, beginning with the January issue, out on Thursday, 19th December.

My name

My Address

Type-ins

We've got another *Type-ins* special this month, this time courtesy of Shabaz Yousaf. He sent us a whole truckload of routines, and we've printed some of the best ones here, including a mini hardware project...

● Fancy yourself as a bit of a programmer? Send your programs to: *Type-ins*, Amstrad Action, Future Publishing, Beauford Court, 30 Monmouth Street, Bath, Avon BA1 2BW

Shabaz tells all...

Shabaz Yousaf is responsible for all this month's *Type-ins*. But how did he get into computing? And where's he coming from,



● Shabaz Yousaf is a self-taught computer boffin.

man? Well how are we supposed to know? Oh, hang on, I suppose we could always ask the lad himself. Go on then, Shab, tell it like it is...

"I'm a 17 year old student and have owned an Amstrad computer for around five years. Before this I didn't have a computer, so every Saturday morning would find me at one of the local computer shops, fiddling away on the demonstration computers - BBCs, Apples or even - dare I mention - Spectrums. The retailers grew to dislike me intensely. I can't think why.

"By the time I had my own computer - a green screen CPC 464 - I already knew a little about BASIC, such as PRINT, FOR-NEXT statements and so on. After typing in a few programs from the manual, I began typing my own simple ones, copying programs from beginners' books, adapting them, and so forth. I purchased a few issues of the 'official' Amstrad magazine, then dropped it in favour of AA when I discovered it on the top shelf at WHSmiths. It ain't half bloody difficult reaching up seven feet when you're only twelve years old. Some people have no consideration at all.

"Amstrad Action first published a program of mine way back in December 1987 - a crummy little effort, now looking back on it.

"Other hobbies of mine include electronics and since owning a 464, I have built my own joystick, speech synthesiser, etc. The parallel printer and joystick ports make interfacing simplicity itself. Some people have problems hooking up disc drivers to Amigas,

which just goes to show how flexible CPCs are.

"They are also very robust - my first one lasted me four years until I blew it by connecting some dodgy bits of circuitry to it. After ripping out all my hair - and everyone else's within a radius of 200 yards - I scraped together enough cash to get another.

"Some people think that in order to start programming it is essential to have a 16-bit machine, several megabytes of RAM and the odd disc drive or three. This is simply not true. During the time I have owned a 464, I have not bought a single add-on. Nor did I have an assembler until AA was nice enough to plonk one on a cover cassette. Until then I would type in machine code byte by byte. This is not to be recommended (this comes from painful experience).

"I did my GCSEs this year, and passed all nine (flippin' swot - Adam). I am now doing my A-levels - CDT, physics and two maths. The intention is to get a job working with computers eventually, but I am not studying computer science since mathematics is considered to be a more important qualification for a job with computers.

"I have no intention of getting rid of my CPC yet - it has served me well so far - although I might one day purchase a PC. And a printer. And a disc drive, a new coffee maker, a colour monitor, a Black and Decker Workmate..."

DOODLE

Caralumba, turtles fans! Get ready to sketch your favourite ninja fighting heroes (or anything else for that matter) with possibly the shortest graphics program in history. Use the cursor keys to move the cross hairs, TAB to draw, and TAB plus any cursor key on the menu bar to change pen colour (four colours are available). Yo, let's draw!

```
(NqH1) 10·DATA·3E,1,CD,59,BC,CD,99,90,3E,0,32,B
B,90,32,BC,90,CD,1E,BB,20,7,3E,2,32,BC,
90,10,C,3E,2,CD,1E,BB,20,5,3E,4,32,BC,9
0,3E,0,CD,1E,BB,20,7,3E,4,32,90,10,C
,3E,1,CD,1E,BB,20,5,3E,2,32,90,3A,BB
,90,FE,0,20,7,3A,BC,90,FE,0,20,B8,CD,99
,90
(BuAs) 15·DATA·3A,BB,90,FE,0,20
(LJHj) 20·FOR·i=&9000·TO·&90BA:READ·a$:POKE·i,U
AL("A"+a$):NEXT·c=1:MODE·1:PRINT"COL·1·
·SAVE·LOAD":DATA·14,FE,2,20,9,2A,B7,90,
23,22,B7,90,10,7,2A,B7,90,2B,22,B7,90,3
A,BC,90,FE,0,20,14,FE,2,20,9,2A,B9,90,2
3,22,B9,90,10,7,2A,B9,90,2B,22,B9,90,3E
(ExHu) 30·CALL·&9000:f=0:x=XPOS*2:y=YPOS*2:IF·I
NKEY(68)=0·THEN·IF·g<304·THEN·PLOT·x,y,
c·ELSE·f=1:IF·x<90·THEN·c=(c+1)·MOD·4:L
OCATE·4,1:PRINT·c:BORDER·10:FOR·d=1·TO·
200:NEXT·BORDER·1:DATA·0,CD,59,BC,ED,5B
,B7,90,2A,B9,90,CD,C0,BB,C9,3E,FF,11,0,
0,1,3F,1,2A
(NTIj) 40·IF·f=1·THEN·IF·x>110·AND·x<170·THEN·S
AVE·"!SC",b,&C000,&3F80:GOTO·30·ELSE·IF
·x>190·AND·x<250·THEN·LOAD·"!",&C000:GOT
O·30·ELSE·30·ELSE·30:DATA·B9,90,CD,5F,B
C,3E,FF,ED,5B,B7,90,21,0,0,1,C7,0,CD,62
,BC,C9,00,0,64,0,'·4·Line·Doodle·-
·by·S·Yousaf·(c)1991
```

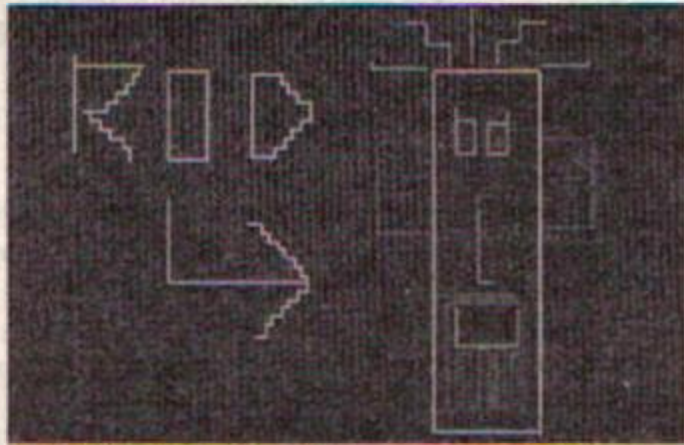

● A quick piccile of Rod done with Doodle... oh, er, sorry Rod, didn't see you there... eek!

MORSE

This groovy prog transmits morse code at the standard rate, as used by coastguards, boats and secret agents the world over. The accompanying hardware project is a unit that will allow your computer to electronically key a morse CW transmitter. Fab, eh? The prog also works without the circuit, giving normal sound output. Acieeeeed.

```

(BkAu) 1.'Morse Code transmitter
(GIBt) 2.'with output through the SOUND channel
      1 and parallel port
(KqBt) 3.'(to provide keying using the supplied
      circuit diagram)
(CvAt) 4.'(C) 1991 Shabaz Yousaf
(FuAj) 5.'
(NvAu) 10.p=60.'PITCH FROM SOUND CHANNEL
(DxBi) 20.d=4.'DURATION OF ONE 'DIT'
(AmCn) 30.OUT=&EF00,0:MODE:2:PRINT:"Morse Code
      Transmitter.V1.0.(C) 1991.S.Yousaf"
(PtCa) 40.PRINT:PRINT"Enter message, then press
      (ENTER) to transmit via the parallel port
      and"
(HwCt) 50.PRINT"through SOUND channel.1.":PRINT
      :PRINT:"Acceptable characters (others ignored):"
(HnBr) 60.PRINT:DIM m$(90):FOR n=39 TO 90:READ
      m$(n)
(JtBp) 70.IF m$(n)<" " AND n<65 THEN PRINT CHR$(
      n)" ";
(BxBu) 80.NEXT:PRINT:PRINT:"and the alphabet":W
      INDOW 1,80,12,25
(ApBs) 90.WHILE NOT BORED:PRINT:" ";:LINE INPUT
      a$:a$=UPPER$(a$)
(FkBu) 100.FOR j=1 TO LEN(a$):x$=MID$(a$,j,1):G
      OSUB 110:NEXT:WEND
(KoAk) 110.'Tx
(OrBi) 120.x=ASC(x$):IF x=32 THEN 200
(BtAw) 130.IF x<39 OR x>90 THEN 190
(NwBj) 140.FOR i=1 TO LEN(m$(x)):z$=MID$(m$(x),
      i,1)
(BsBj) 150.IF z$="0" THEN SOUND 1,p,d,15
(MwBk) 160.IF z$="-" THEN SOUND 1,p,d*3,15
(AxBv) 170.OUT=&EF00,255:WHILE SQ(1)<>4:WEND:OU
      T=&EF00,0:SOUND 1,0,d
(MpBj) 180.NEXT:PRINT:PRINT:"and the alphabet":W
      INDOW 1,80,12,25
(AtAn) 190.RETURN
(BoAl) 200.'SPACE
(LxBo) 210.SOUND 1,0,4*d:WHILE SQ(1)<>4:WEND:GO
      TO 190
(IsBt) 220.'MORSE DATA--Enter with care and
      check using Type-Righter
(MpDw) 230.DATA 0---0,,,,--00--,0000-,0-0-0-
      ,,-----,0----,00---,0000-,00000-,
      0000-,000-,00---,00---,0---000,,,,00--
      00,,0-,000-,0-0-,00,0,00-0,--0
(IsC1) 240.DATA 0000,00,0---,0-0-00,--,0,---
      ,0-0-,--0-,0-0,000-,00-,000-,0---,00-,
      -0---,--00
  
```

Mini Hardware Project...

This simple set-up sits between any morse CW transmitter and your CPC's printer port. With this circuitry in place, your CPC can drive the transmitter directly.

CIRCUIT DIAGRAM

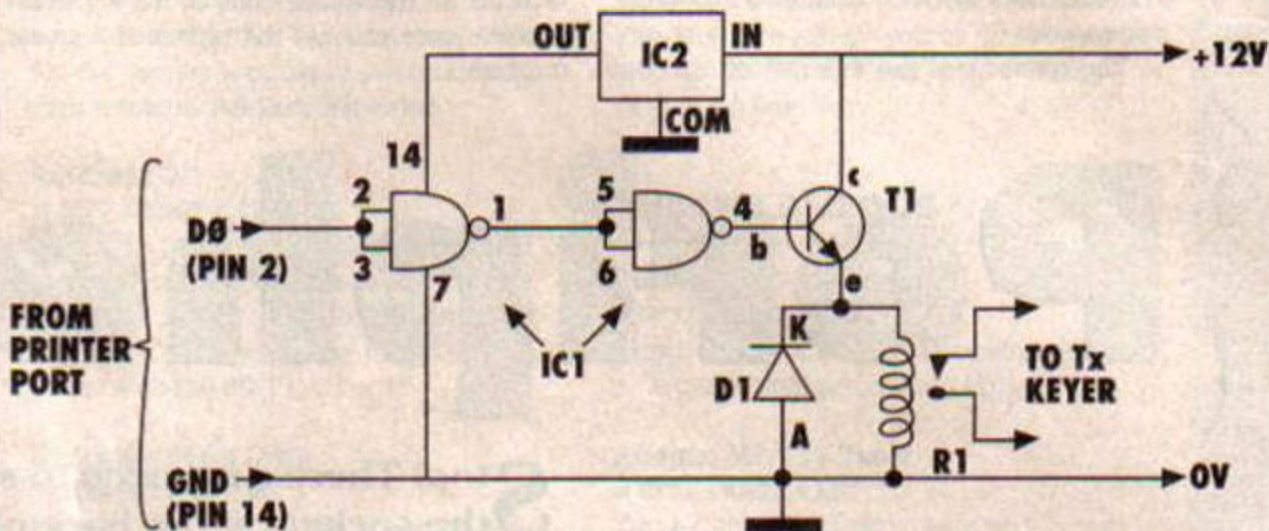

PIN IDENTIFICATION

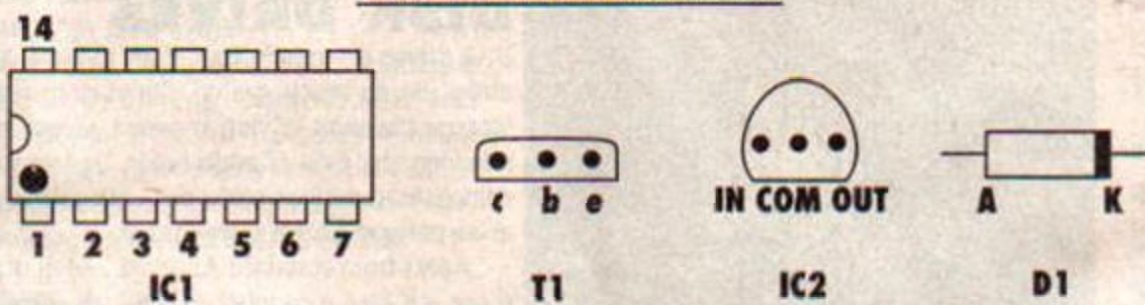

COMPONENTS LIST:

- IC1 - 7401
- IC2 - 78L05
- T1 - ZTX300
- D1 - IN4148
- R1 - 12V RELAY

All parts available from MAPLIN (see W H Smith for a MAPLIN catalogue - £2.45)

TV

Here's a demo of satellite TV. We take it Shabaz isn't a fan of those big white dishes. Good on you, mate.

```

(DnHp) 10.FOR i=&AF00 TO &AF8F:READ a$:POKE i,U
      AL("&a$"):NEXT:MODE 1:CALL &AF00:BORDE
      R 0:INK 0,0:INK 1,26:INK 2,13:INK 3,0:W
      HILE NOT bored:OUT &BD00,INT(RND*256):W
      END:DATA 01,00,c0,ed,5f,81,a7,02,03,78,
      fe,00,c8,c3,03,af:'Satellite TV demo b
      y S.Yousaf
  
```

TUNE

And to round off tonight's performance, a one-line rendition of *The Irish Washerwoman*. Yo Ireland, send us your Type-ins!

```

(OnAv) 1.'One-line Irish Washer-woman
(BwAs) 2.'By Shabaz Yousaf
(CwHt) 10.a$="HGFDADDFFHGFGEEBEGEGIHGFDDADD
      DFHGFGEHGFDDDFHXJKDFHXJKMLKLEKILKLN
      MLILLHLLGLLFLGFGHGFDD":DIM a(14):FOR
  
```

```

      i=1 TO 14:READ a(i):NEXT:FOR i=1 TO 96
      :SOUND 1,a(ASC(MID$(a$,i,1)))-
      64):NEXT:DATA 239,213,190,179,159,142,1
      27,119,106,95,89,80,71,63
  
```

AA

NEXT MONTH

Extended Basic by Shabaz Yousaf installs 55 RSX commands, giving 28 new features, including most of the 6128 commands for 464 owners. You won't need to type it in, though. Why? Because it'll be on next month's cover tape, along with Alan Scully's popular (464 compatible) DTP program *Pagemaker Plus*, top adventure writing package *Graphic Adventure Creator*, and loads of other stuff we're not allowed to tell you about yet. Looks like it's going to be one hell of a Christmas - join that queue outside the newsagents today!

BUYERS' GUIDE

There's a lot of gadgets you can attach to your computer to make it do weird and wonderful things. We'll be looking at modems and audio add-ons next month. This month, we'll have a gander at disk drives and some other CPC goodies...

Getting stuck in

At the back of your machine you'll find some sockets. Every machine has a printer socket. The CPC 464 and 464 Plus have a joint disk drive/extension socket. The CPC 6128 and 6128 Plus have separate disk drive and extension sockets.

The connections are different on the Plus

machines, though, being the more hard-wearing D-type connectors as opposed to the standard edge connectors on the old CPCs. This does mean that some of the older peripherals can't be attached to the Plus machines, except by using the Wave widget, a small device that plugs into the Plus expansion socket and allows peripherals with edge connector interfaces to be attached.

Many of the more popular, and recent, periph's are available in both CPC or Plus versions. Many are also available in different versions for the 464 or 6128. So it's important to make sure you get the right one for your machine...

BUY CUT

Peripherals

Stop! There's no need to stick parts of your body into the sockets at the back of your machine. Look, you can stick some of these things there instead...



● A 3.5-inch disk drive is one of the most popular CPC peripherals of all - four times the capacity on disks one quarter the price!

first. And you'll need a special operating system to make use of the increased storage capacity. (The relevant software will normally be included as part of the package.)

DISK DRIVES

Disk drives are gnarly bits of kit to have. They make life so much easier, allowing increased storage capacity, giving reduced access time, relieving the pain of multi-loads, and enabling complicated serious packages with lots of separate parts to be run comfortably.

Apart from standard Amstrad 3-inch drives, there are also a number of 3.5-inch drive kits available that enable you to use those thin blue disks with your machine. You know, the ones that give you four times the storage capacity for a quarter of the price.

These are only available as second drives, though, so 464 owners will need to buy the DD-1 kit (interface plus standard 3-inch drive)

LOOKING FOR LEADS

Other than printer leads (PL-1s) and disk drive leads (DL-2s), there's all sorts of Amstrad attachments that let your machine talk to other objects (TVs, videos,

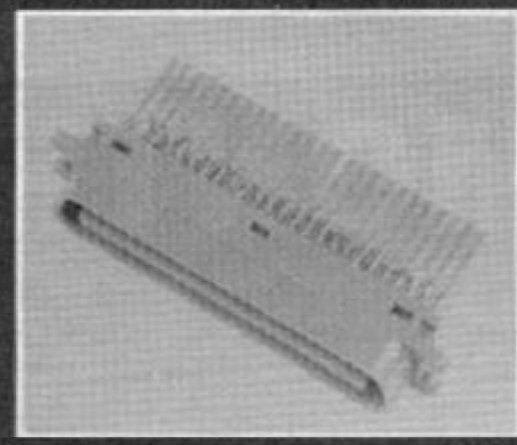

washing machines), or even turn into them.

The MP-2 modulator lets you plug your CPC into an ordinary household telly, and the MP-3 turns your CPC monitor into a telly (cor).

You can also get a lead that will connect your CPC to a video recorder, so you can video your pathetic attempts to get past the bent copper in *Final Fight*.

Check our list, shop around for the best prices on everything, and turn your machine into a monster. Peripherals - get stuck in.

● The 'WAVE Widget' is a connector that lets you plug existing peripherals into the backs of new Plus machines.

ROMS & ROMBOXES

What has a faster access time than even a disk? Answer, a ROM (Read Only Memory) chip. These allow instant loading, and take up none of the computer's RAM, thereby allowing more space for the created files and stuff.

GX4000/Plus games cartridges contain a ROM chip and an interface chip, the latter enabling the computer to read the data on the former. Romboxes enable you to connect up to six ROM chips to the expansion port at the back of your machine.

Many of the leading serious software packages (*Protext* word processor, *Maxam* assembler, *BCPL* programming language, etc) are available on ROM, making a rombox a worthwhile purchase for anyone wanting to add a bit of wellie to their set-up.

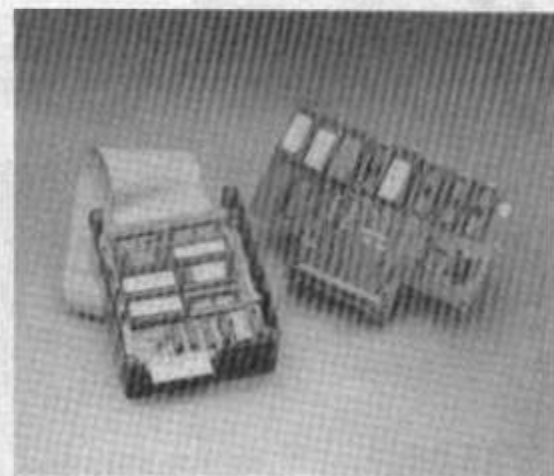

● Some software is not just supplied on disk/tape - you can also get it on ROM chips. These plug into special 'romboxes' attached to the back of your machine, and allow near-instantaneous loading.

BUYERS' GUIDE

WHAT TO GET

MULTIFACE 2



● Romantic Robot's Multiface 2 is a little device that lets you 'freeze' and examine the contents of your machine's memory.

The most popular peripheral around, the Multiface is a funky little widget that plugs into the back of your machine, and allows you to 'interrupt' any game at any point.

You can use it to back up tape games to disk, save games at any point so you can return to that stage later (i.e. once you've died), enter Multiface pokes for infinite lives etc, and possibly also do lots of naughty hacking sort of things that you'll get locked in a small cell with a big tattooed biker for.

The Multiface 'dumps' the entire memory to either disk or tape, and can also be used to 'grab' screen shots. You can examine memory, enter hex, and do more strange things than could possibly be good for you.

The Multiface is an absolutely vital purchase for any programmers or games freaks out there - don't be without one.

DISK DRIVES

Amstrad DD-1

☛ 0277 230222 • £150

The kit (FD-1 plus interface) that turns your 464 into a disk-based system. Vital for 464 owners wanting to use disks with their machine. **AA Recommended.**

Amstrad FD-1

☛ 0277 230222 • £100

Amstrad's 3-inch second drive. Very solid in build and appearance. 6128 owners wanting a second drive should go for this one (they don't need the interface that comes with the DD-1.)

Microstyle Super Drive

☛ 0274 602180 • £80

Includes the new MS800 operating system. We haven't seen this yet, so we can't give you a verdict.

Siren Disk Drive Pack

☛ 061-724 7572 • £100

Siren's new bargain package, including a ROM box, operating system on ROM, and the relevant lead. An ace piece of kit for the money, particularly since the ROM box can be used for other things.

Reviewed on page 58. **AA Best Buy.**

ROMBOX

Rombo Rombox (Armor)

☛ 0733 68909 • £20 (when at least one ROM is bought)

As well as supplying most of its excellent serious progs and utilities on ROM (MAXAM and Protext are recommended), Armor also offers you a rombox at a knock down price. **AA Recommended.**

MULTIFACE

Multiface 2 (Romantic Robot)

☛ 081-200 8870 • £38

The most vital bit of CPC kit out there. The Multiface allows you to 'freeze' any program in mid air, and then do things with it. **AA Best Buy.**

MISCELLANEOUS

Amstrad MP-2 Modulator

☛ 0277 230222 • £35

Attaches your CPC to a television. Ideal for when your monitor blows up.

Amstrad MP-3 TV Tuner

☛ 0277 230222 • £50

Turns your monitor into a telly, so you can watch *Neighbours* in your room. Er, hurrah! **AA Recommended.**

CPC-to-Video lead (WAVE)

☛ 0229 870000 • £7

Lets you, er, attach your CPC to a Video. (And they say the art of incisive writing is dying out - ed.)

Wave Widget

☛ 0229 870000 • £10

Lets you use standard CPC peripherals on your Plus machine. **AA Recommended.**

MEMORY

Dk'tronics 64K/256K memory (Datel)

☛ 0782 744707 • £50/£100 respectively

Expand your 464's memory to 128K with the Dk'tronics 64K RAM pack. Or, for the really greedy, there's a 256K version. **64K version AA Recommended.**

THANKS FOR THE MEMORY

There are two big differences between the CPC464 and the 6128. The 6128 has a disk drive, and it also has another 64K of RAM.

You can upgrade your 464 by adding a disk drive (see elsewhere in this section) and you can also plug in the extra RAM. Apart from a few software incompatibilities (which can only be solved by inserting a 6128 ROM chip into your 464), your 464 is now as powerful as a 6128.

Plug-in 64K memory modules were made in great numbers by peripherals manufacturers Dk'tronics. These RAM packs are still available from mail order suppliers like Datel. If an extra 64K isn't enough for you, there's also a 256K version! Bear in mind, though, that few if any commercial CPC programs will use more than 128K.

● A 64K RAM pack will boost your 464 up to 128K.



Shoot-em-ups

Guns are very dangerous things, readers, you could take someone's eye out with them. Much safer to buy a computer game instead, and shoot people *that way*...

For a lot of game styles (platform games, drive-em-ups etc), it seems the best games all came out ages ago. None of the recent stuff cuts enough mustard to cover a cocktail sausage, let alone one of those big German things with a knot at each end.

In the area of shoot-em-ups, though, it's quite a different story. A few months back we had *Turrican 2*, still the first choice for anyone who wants a bit of exploration with their bad-die-waxing. And now we've got *Smash TV*, the joystick destroyer to beat all others.

The shoot-em-up is one of the most common types of computer game, and shooties go back to the very beginning of computer games history. It's a long story, but the year 1978, the name Toshiro Nishikado, and the phrase *Space Invaders* are the important bits. Tikoshniko it was who created the game that took the world by storm.

Basically, you had three lives and moved from left to right along the bottom of the screen, hiding behind shieldy things and trying to shoot rows of aliens. These scrolled down the screen doing a Lulu dance, and got faster the more of them you shot. Oh, and there were some UFOs flying across the top of the screen as well. You got bonus points if you waxed them.

The best tactic was to move to the side of

the screen and blast away at the end columns. A bit crap really, but the game gripped the imagination of young persons, in much the same way that the Rubic's Cube did three years later.

Loads of other simple arcade shooties soon followed, including the hyper-frustrating *Asteroids*. And *Defender*, which will always remain the best computer game in history, even if someone makes a machine you can stick your head in so your brain gets sucked out and attached to the ROM chips or something.

Shooties are popular for all the same reasons that films like *Die Hard*, *Total Recall* and *Terminator 2* are popular. Most of us would quite like to fly through space with a laser gun, blasting three-headed green things to bits. But we either haven't got the time or are too scared of getting hurt. Or possibly don't own a spaceship. So we play a violent, action-packed computer game instead (which is probably just as well, really). With guns and stuff in it.

Sure, it won't help us with our geography homework, it won't make that girl who lives next door like us (*you could try plastic surgery - ed*), and it won't earn us an academy award or a mention in the New Year honours list. But it's more interesting than reading a book or watching the news, so who cares? **AA**

BEST SHOOT-EM-UP

Smash TV (Ocean)

What can we say that we haven't said in the review on pages 38 & 39? Er, we could say "wibble", "bumpkida-cious" or "quasi-pallovial spricket sponge". But we

won't, 'cos that would be silly.

What we'll say instead is that *STV* is a very simple game. But it's the lack of things like a detailed graph-

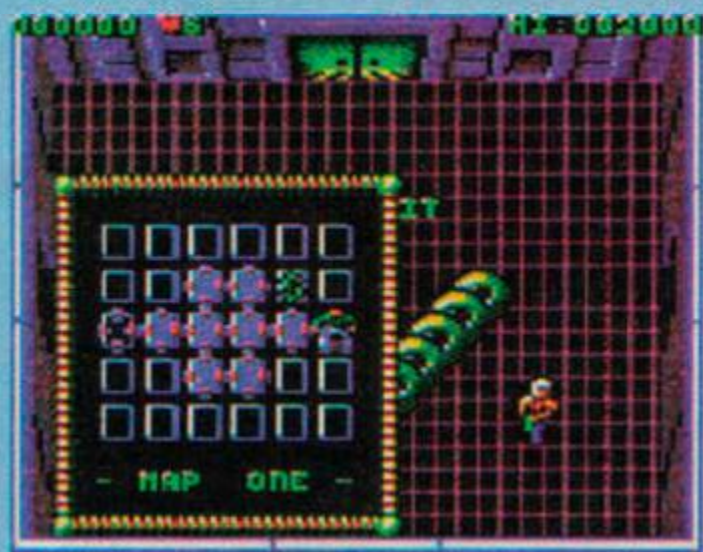

● *Smash TV* contains a few dozen rooms full of more nasty alien thingies and nice power-ups than you could shake a Brazilian rain forest at. It's dead fast, too.



● Here's you, shooting at something. Hurrah!

ics background, and more importantly scrolling, that have made the game so fast. There's an excellent selection of weapons for mega-firepower, loads of different baddies and enough different rooms to ensure you won't be able to finish it on the first day, no matter how hard you try.

Smash TV - it's spinky, spanky and sponky. No frills, only thrills.

SHOOT-EM-UPS TOP TEN



- 1) Smash TV (Ocean) ▲**
Fireballs and baddies galore in this fast-moving burst of non stop action. **96% (AA75)**



- 2) Turrican 2 (Rainbow Arts) ▲**
Lots to shoot, and an exploratory long term challenge too. Cor. **97% (AA71)**

- 3) Operation Wolf (Ocean)**
Rootin', tootin', shootin' gallery fun in this arcade convo classic. **89% (AA40)**

- 4) Afterburner (Activision)**
Take to the air in your F-14 fighter, and shoot lots of things. **81% (AA41)**

- 5) X-Out (Rainbow Arts)**
A speedy spaceship, a shop that sells some wicked power ups - what more do you need? **86% (AA56)**



- 6) Pang (Ocean) ▲**
Balloon bursting ahoy in one of the best cartridge games ever. Balloona-bunga! **93% (AA70)**

- 7) Operation Thunderbolt (Ocean)**
Op Wolf's big brother gives ya two player action with grenades and stuff. **89% (AA52)**

- 8) Silkworm (Virgin)**
Jump in a helicopter or a jeep (or both in two-player mode) and go totally mental. **72% (AA47)**

- 9) Turrican (Rainbow Arts)**
The game that knocked the spots off the rest, only to have its own acne cured by *Turrican 2*. **90% (AA57)**

- 10) Robozone (Mirrorsoft) ▼**
A laid-back kinda shootie, but with three different game styles to get to grips with. **86% (AA73)**



CITIZEN

DOT MATRIX & NOTEBOOK PRINTERS

ALWAYS A GOOD IDEA

Silica presents some great offers on the award winning range of high quality matrix printers from Citizen. Each Citizen printer is built in the UK to exacting standards, ensuring superb reliability and output. Our confidence in Citizen's quality is such that we are pleased to include a 2 year guarantee with every printer. Plus, if you buy a Citizen printer from us, we will give you the Silica Systems Printer Starter Kit (worth £29.38), FREE OF CHARGE!

FREE DELIVERY

Next Day - Anywhere in the UK mainland

FREE STARTER KIT

Worth £29.38 - With every Citizen printer from Silica

2 YEAR WARRANTY

Silica offers a 2 year warranty (including the printer head) with every Citizen printer from Silica

WINDOWS 3.0

Free Windows 3.0 driver included with the Silica Starter Kit.

FREE COLOUR KIT

With every Swift 9 and Swift 24e printer

FREE HELPLINE

Technical support helpline open during office hours.

MADE IN THE UK

Citizen printers are manufactured to high standards.



9 PIN PRINTER

144 CPS 80 COLUMN

- Citizen 1200+ - 9 pin - 80 column
- 144cps Draft, 30cps NLO
- 4K Printer Buffer + 2 Fonts
- Parallel Interface as Standard
- Graphics Resolution: 240x240dpi
- Epson and IBM Emulation
- Pull tractor & bottom feed
- FREE Silica Printer Starter Kit

RRP:	£199	SERIAL INTERFACE OPTION The 1200 printer is available with a serial interface for £139+VAT Net: PRi 2125 - £163.33 inc VAT
STARTER KIT:	£29	
TOTAL RRP:	£228	
SAVING:	£35	
SILICA PRICE:	£129	

£129

+VAT=£151.58 ref: PRi 2120

9 PIN PRINTERS



FREE! COLOUR KIT

192 CPS 80 COLUMN

- Citizen Swift 9 - 9 pin - 80 column
- 192cps Draft, 48cps NLO
- 8K Printer Buffer + 3 Fonts
- Parallel Interface
- Graphics Resolution: 240x240dpi
- Epson and IBM Emulation
- FREE Colour Kit
- FREE Silica Printer Starter Kit

RRP:	£239
COLOUR KIT:	£38
STARTER KIT:	£29
TOTAL RRP:	£266
SAVING:	£113
SILICA PRICE:	£179

£179

+VAT=£223.38 ref: PRi 2108



Colour Option Extra - See Accessories

192 CPS 136 COLUMN

- Citizen Swift 9x - 9 pin - 136 column
- 192cps Draft, 48cps NLO
- 8K Printer Buffer + 3 Fonts
- Parallel Interface
- Graphics Resolution: 240x240dpi
- Epson and IBM Emulation
- A3 landscape printing
- FREE Silica Printer Starter Kit

RRP:	£329
STARTER KIT:	£29
TOTAL RRP:	£358
SAVING:	£113
SILICA PRICE:	£249

£249

+VAT=£304.33 ref: PRi 2109

24 PIN PRINTERS



FREE! COLOUR KIT

216 CPS 80 COLUMN

- Citizen Swift 24e - 24 pin - 80 column
- 216cps Draft, 72cps LQ
- 8K Printer Buffer + 6 Fonts
- Parallel Interface
- Graphics Resolution: 360x360dpi
- Epson, IBM & NEC P6+ Emulation
- FREE Colour Kit
- FREE Silica Printer Starter Kit

RRP:	£389
COLOUR KIT:	£38
STARTER KIT:	£29
TOTAL RRP:	£428
SAVING:	£169
SILICA PRICE:	£259

£259

+VAT=£304.33 ref: PRi 2134



Colour Option Extra - See Accessories

192 CPS 80 COLUMN

- Citizen 224 - 24 pin - 80 column
- 192cps Draft, 64cps LQ
- 8K Printer Buffer + 2 Fonts
- Parallel Interface
- Graphics Resolution: 360x360dpi
- Epson and IBM Emulation
- Colour Option Available
- FREE Silica Printer Starter Kit

RRP:	£269
STARTER KIT:	£25
TOTAL RRP:	£294
SAVING:	£95
SILICA PRICE:	£199

£199

+VAT=£233.83 ref: PRi 2484

NOTEBOOK PRINTER



WORLD'S SMALLEST & LIGHTEST A4 NOTEBOOK PRINTER

64 CPS 80 COLUMN

- Citizen PN48 Notebook Printer
- Non-impact Printing On Plain Paper
- LASER QUALITY - 64cps
- 4K Printer Buffer + 2 Fonts
- Rear and Bottom Paper Loading
- Parallel Interface
- Graphics Resolution: 360x360dpi
- Epson, IBM, NEC P6 & Citizen Emulation
- Power: Mains, Battery or Car Adaptor
- FREE Silica Printer Starter Kit

RRP:	£325
STARTER KIT:	£29
TOTAL RRP:	£354
SAVING:	£105
SILICA PRICE:	£249

£249

+VAT=£302.38 ref: PRi 2107

24 PIN PRINTER



Colour Option Extra - See Accessories

192 CPS 136 COLUMN

- Citizen Swift 24x - 24 pin - 136 column
- 192cps Draft, 64cps LQ
- 8K Printer Buffer + 4 Fonts
- Parallel Interface
- Graphics Resolution: 360x360dpi
- Epson, IBM and NEC P6 Emulation
- A3 landscape printing
- FREE Silica Printer Starter Kit

RRP:	£489
STARTER KIT:	£29
TOTAL RRP:	£518
SAVING:	£175
SILICA PRICE:	£349

£349

+VAT=£420.38 ref: PRi 2131

24 PIN PRINTER

GOLD AWARD
Best Budget Printer 1990
Micro Technology

- Citizen 124D - 24 pin - 80 col
- 144cps Draft, 48cps LQ
- 8K Printer Buffer + 2 Fonts
- Parallel Interface
- Graphics Res: 360x360dpi
- Epson and IBM Emulation
- FREE Silica Printer Starter Kit

RRP:	£249
STARTER KIT:	£25
TOTAL RRP:	£274
SAVING:	£105
SILICA PRICE:	£169

£169

+VAT=£208.38 ref: PRi 2133

ACCESSORIES STARTER KIT

SHEET FEEDERS		
PFA 1200	£71.38	
PFA 1215	£88.76	
PFA 1225	£82.36	
SERIAL INTERFACES		
PFA 1189	£56.45	
PFA 1209	£32.25	
PFA 1219	£26.38	
32K MEMORY EXPN		
PFA 1232	£32.18	
PRINTER STAND		
PFA 1242	£34.83	
PFA 1214	£28.88	
ORIGINAL RIBBONS		
RIB 3020	£7.91	
RIB 3040	£7.15	
RIB 3024	£4.29	
RIB 3036	£15.82	
RIB 3048	£3.61	
RIB 3045	£3.61	
COLOUR KITS		
PFA 1236	£35.25	
PFA 1240	£35.25	
PN48 ACCESSORIES		
PFA 1142	£51.76	
PFA 1155	£ TBC	
PFA 1162	£ TBC	

All prices include VAT and Free Delivery.

FREE!

Worth: £25 +VAT=£29.38

- To get you up and running with your new printer from Silica:
- 2 1/2" Disk - Amiga & ST Drivers
 - 2 1/2" Disk - Drivers for Windows 2
 - 2 Metre Parallel Printer Cable
 - 200 Sheets of Continuous Paper
 - 100 Continuous Address Labels
 - 5 Continuous Envelopes
- If you already own a printer, and would like to buy a kit, you may order one (ref: KIT 5500) for £24.95 - £5 off RRP!



SILICA SYSTEMS OFFER YOU

- **FREE OVERNIGHT DELIVERY:** On all hardware orders shipped in the UK mainland.
- **TECHNICAL SUPPORT HELPLINE:** Team of technical experts at your service.
- **PRICE MATCH:** We normally match competitors on a "Same product - Same price" basis.
- **ESTABLISHED 12 YEARS:** Proven track record in professional computer sales.
- **BUSINESS + EDUCATION + GOVERNMENT:** Volume discounts available for large orders.
- **SHOWROOMS:** Demonstration and training facilities at our London & Sidcup branches.
- **THE FULL STOCK RANGE:** All of your requirements from one supplier.
- **FREE CATALOGUES:** Will be mailed to you with offers and software/peripheral details.
- **PAYMENT:** By cash, cheque and all major credit cards.

Before you decide when to buy your new printer, we suggest you think very carefully about WHERE you buy it. Consider what it will be like a few months after you have made your purchase, when you may require additional peripherals or software, or help and advice. And, will the company you buy from contact you with details of new products? At Silica Systems, we ensure that you will have nothing to worry about. We have been established for over 12 years and, with our unrivalled experience and expertise, we can now claim to meet our customers requirements with an understanding which is second to none. But don't just take our word for it. Complete and return the coupon now for our latest Free literature and begin to experience the "Silica Systems Service".

MAIL ORDER:	1-4 The Mews, Hatherley Rd, Sidcup, Kent, DA14 4DX	Tel: 081-309 1111
Order Lines Open:	Mon-Sat: 9:00am-6:00pm	No Late Night Opening
LONDON SHOP:	52 Tottenham Court Road, London, W1P 0BA	Tel: 071-580 4000
Opening Hours:	Mon-Sat: 9:30am-6:00pm	No Late Night Opening
LONDON SHOP:	Selfridges (1st floor), Oxford Street, London, W1A 1AB	Tel: 071-629 1234
Opening Hours:	Mon-Sat: 9:30am-6:00pm	Late Night: Thursday until 6pm
SIDCUP SHOP:	1-4 The Mews, Hatherley Rd, Sidcup, Kent, DA14 4DX	Tel: 081-302 8811
Opening Hours:	Mon-Sat: 9:00am-5:30pm	Late Night: Friday until 7pm

To: Silica Systems, Dept AMACT-1291-55, 1-4 The Mews, Hatherley Rd, Sidcup, Kent, DA14 4DX

PLEASE SEND A CITIZEN COLOUR CATALOGUE

Mr/Mrs/Ms: _____ Initials: _____ Surname: _____

Address: _____

Postcode: _____

Tel (Home): _____ Tel (Work): _____

Company Name (if applicable): _____

Which computer(s), if any, do you own? _____

MAIL ORDER HOTLINE
081-309 1111

SILICA SYSTEMS

AAfterthought

Bye-bye Paul, hello Ange

Yes it's a sad, sad day, ladies and germs. Funky Paul Morgan, AA's cropped, psychopathic Art Editor is leaving the mag. Boo, sniff... oh well, never mind, he wasn't very good anyway (*I haven't left yet, mate - Paul*)...

As you'll know if you've read *Reaction*, a regular feature of life at AA is our monthly fights with the staff of our sister mag, *Commodore Format*. These are normally fairly good-natured affairs. Sure, most of us end up in hospital, but it's just a bit of a laugh really. Or at least, that's the way the rest of us see it. Paul seems to take it all a little more seriously, though.

Up till now, this hasn't resulted in anything more worrying than *CF* Deputy Editor Sean Masterson being thrown through a window (which we all thought was fair enough anyway). October's shindig went a bit over the top though, when Paul faced off with *CF* Art Editor, formerly of this parish, Ollie 'Ollie' Alderton.

Things started building up, and in the midst of it all, Paul gave Ollie one almighty smack round the back of a head with a baseball bat, knocking him out. We looked on in shock (Maryanne ran off and hid behind a tree) as he gradually came to, having completely lost his memory, and now under the impression that he

was in fact an exotic dancer called Samantha. It was time to either call an end to the punch-ups, or else get rid of Paul. We got rid of Paul - off to the ground floor, where we hope the calm and restful lifestyles of the joss-stick burning, mantra-chanting, old hippies that produce *ST Format* will help to mellow him out.

Still, in the middle of all this ruthless, executive decision-making, we suddenly realised we needed to find someone to fill Funky's place. Her name's Angela Neal and she assures us she's done this sort of thing before. So welcome aboard the good ship AA, Ange!



● Paul delivers the deadly blow that made Ollie go all funny. The AA team tries to get his memory back, but to no avail...

CRAP HAIRCUT COMPO

It had Michael and Ross from Kircaldy in hysterics, Stuart from Ipswich thought it was dead cool, and CPC owners around Britain have been discussing it over breakfast. What are talking about? The Adam Peters Haircut, of course, as unleashed on the world in a photo in the October issue. Small children point at it in the streets, worriedly asking their parents in they might one day grow up to look like that; whole crowds gather round him when he wanders past Bath Abbey, thinking that he must be some sort of street performer (*I collected £12 last Wednesday afternoon - Adam*).

But we don't think even this current cut is quite stupid enough to adequately represent Adam's personality. We want something that will have him ridiculed by everyone, disowned by all his relatives, and possibly placed in an secure institution 'in his own best interests'. So, having failed to learn the lessons of the past, we've decided to turn to you, the readers, to design something even worse.

Do a sketch of the haircut you think Adam should sport (including comments and explanations where necessary), and send it to *Crap Haircut Compo*, *Amstrad Action*, 29 Monmouth Street, Bath, Avon BA1 2DL, to arrive by December 19th 1991.

We'll select the daftest one, and send Spotty off down the barbers with it. The winner will get a tape version of *Terminator 2* (complete with badge). Tootle pip.

WANTED!

Your honest opinion of AMSTRAD ACTION

■ To help us keep improving your favourite magazine, please fill in and return this form each month

1. How did you buy this issue?
 I subscribe
 Newsagent delivered it to my home
 Asked newsagent to reserve copy
 Bought it on planned shop visit
 Just happened to see it and liked it

2. Rate AMSTRAD ACTION in terms of value for money:
 Excellent! Good
 Reasonable Poor Ripoff!

3. Out of ten, how much did this month's cover make you want to look inside?...../10

4. How much does this issue appeal to you overall?...../10

5. How does it compare with previous issues you've seen?
 Much better! Slightly better About the same standard
 Slightly worse Much worse!

6. Rate out of ten this and any other computer magazines you read regularly:
 AMSTRAD ACTION...../10
/10
/10
/10

7. Out of ten, how useful did you find this month's printer review and buyers' guide?...../10

8. What do you like most and then least about this issue?
 I most like

And I least like

.....

.....

Your name and address:*

.....

.....

.....

* Leave blank if you wish - but we may want to send you details of exclusive special offers

■ No stamp needed if posted in UK. Return to: AMSTRAD ACTION December Survey, Future Publishing, Freepost, Bath, Avon BA1 2XF

PLAY THE GAME MAN!

hello

fellow humans!
Bartholomew J. Simpson here, with
a very important secret:

**SPACE MUTANTS
ARE INVADING
SPRINGFIELD**

That's right man! A buncha slimy,
horrible, totally gross and putrid
monsters are taking over the
bodies of the people who live here
and they wanna build a weapon
that's gonna take over the entire
planet!

PRetty CoOL, HUH?

Anyway, yours truly is the only one
who can see 'em! I've gotta spray-
paint things, get radical on my
skateboard, use my trusty slingshot,
and in general behave like a
nuisance, man.

Plus, with evil dudes like Nelson
the bully and Sideshow Bob getting
in my way, it's a good thing I've got
the rest of the Simpsons to help me
out!

So if you're a decent person a
patriot, and somebody who cares
about this sorry planet, you'll do the
right thing.

SAVE THE EARTH

BUY THIS GAME!
Thanks man.

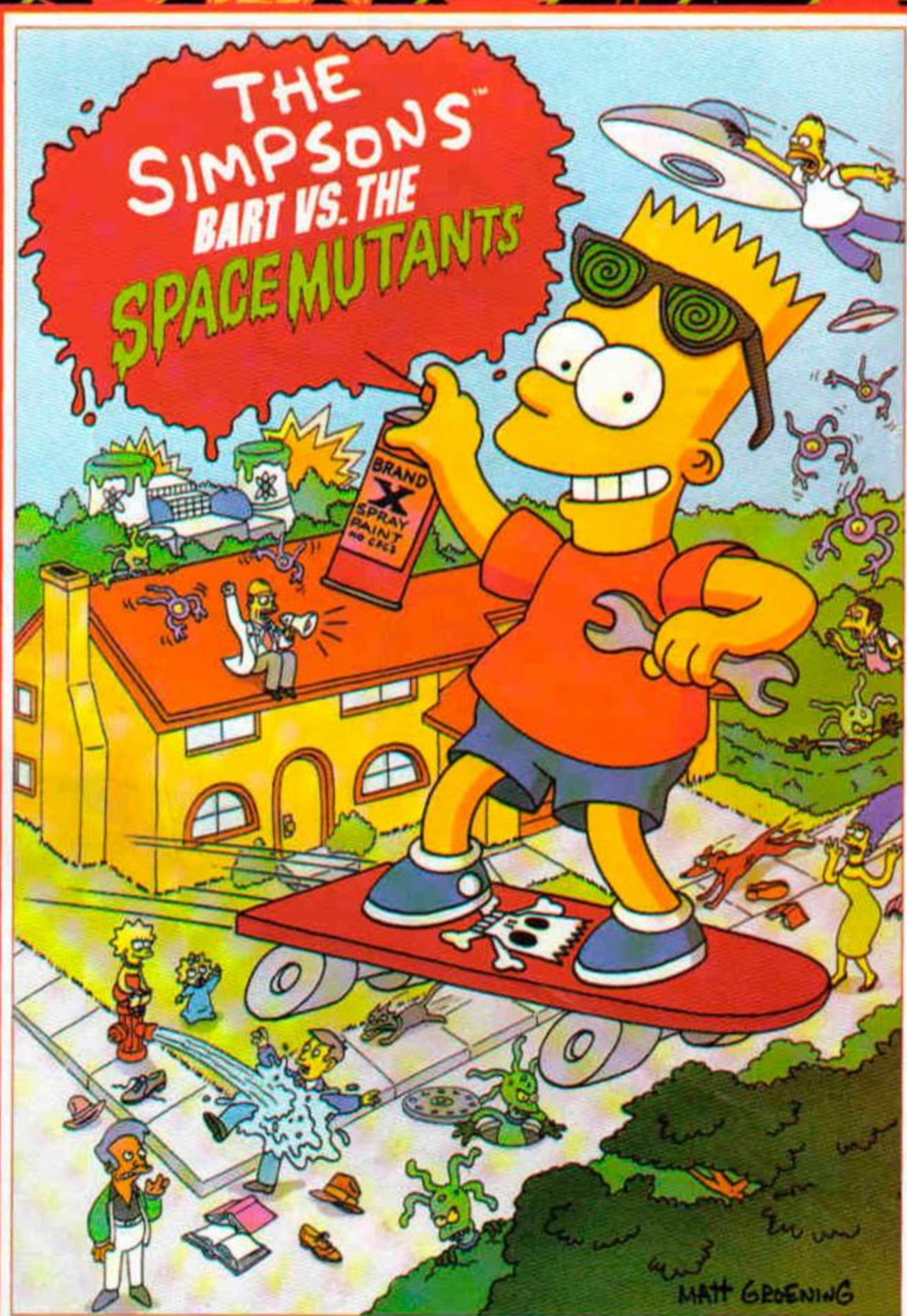

MATT GROENING

GBM AMIGA
ATARI ST
SPECTRUM
COMMODORE
AMSTRAD

Acclaim™
entertainment, inc.

ocean®

ACCLAIM™ AND MASTERS OF THE GAME™ ARE TRADEMARKS OF ACCLAIM ENTERTAINMENT INC.
THE SIMPSONS™ TM & © 1990 TWENTIETH CENTURY FOX FILM CORP. ALL RIGHTS RESERVED.

OCEAN SOFTWARE LIMITED
6 CENTRAL STREET · MANCHESTER · M14 5NS
TELEPHONE: 061 832 6633 · FAX: 061 832 6634

20/20 VISION
PRESENTS
**HUDSON
HAWK**
THE MOVIE
AVAILABLE FROM
YOUR LOCAL
VIDEO RENTAL STORE

Shy.
Sensitive.
Law-abiding.
Polite.
Respectful.

BRUCE WILLIS HUDSON HAWK

...I don't think so.

Now
steal in on the game...

"Sheer, unadulterated addiction...which is guaranteed to last a lifetime...Infuriatingly addictive game-play... grab onto it with both hands"

ACE

"Excellent graphics move well... the comic animation will raise a smile from even the most hardened hearts."

ST ACTION



© 1991 TRI-STAR PICTURES, INC.
ALL RIGHTS RESERVED