

The ultimate CPC peripheral

TOP TIPS • FIRST REVIEWS • BEST ADVICE

ISSUE No.90 March 1993 £2.50

CPC



PLUS



Future PUBLISHING

Your guarantee of value



NOT an official Amstrad publication!

AMSTRAD

BIGGER AND BETTER
the wonderful world of upgrades



Clunk-Click Every Trip

Nigel Mansell's World Championship speeds past the competition



ACTION

Is your covertape missing? If so, ask your newsagent where it is!

The night of a thousand pokes...

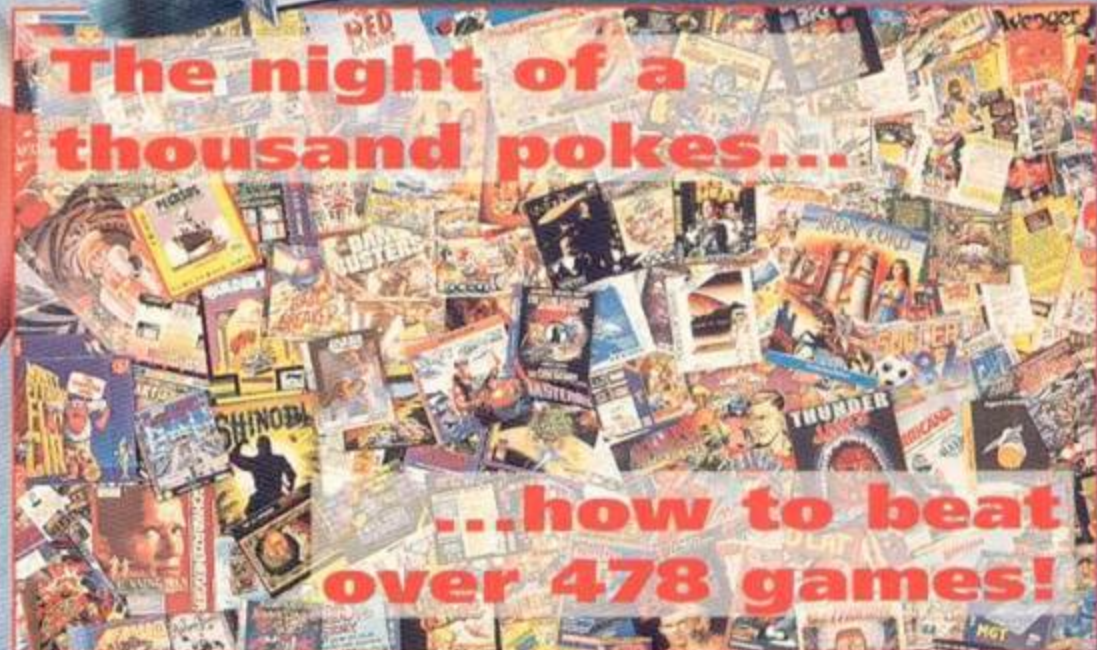

...how to beat over 478 games!

ALSO ON DISK!

Want a disk version of the covertape? (6128 Plus owners take note) See the tape pages for ordering details.

Line

Serious

8 Bigger & Better

Phil Craven begins a new series on add-ons. Get the most out of your machine, without spending loads of money.

24 Technical Forum

Richard Fairhurst answers sackloads of your technical problems, including a whole bundle of Multiface problems.

32 Public Image

Tim Blackbond sorts through the latest PD releases. If it's any good, you can be sure he'll tell you!

38 Type-ins

Jerry Glenwright checks out more of your handywork, and carries on with the BASIC tutorial.

Games

12 Poking fun

Phil Howard provides us with probably the largest number of multiface POKES this side of, well, anywhere really! You need never despair again.

22 Balrog

Leaving all those smelly orcs behind for the day, The Balrog takes his monthly pilgrimage to Bath for the chance to swap tales of distant lands.



Postman Pat, a cat and a hat on page 48.



Main feature

46

Nigel Mansell's World Championship

Have you got what it takes to be the best? If so, then this is the game for you. It's one of the best we've seen.

31 Sherwood Forest?

Win a weekend in Nottingham for a family of four, visit the castle, the Tales of Robin Hood, Sherwood Forest and meet the Sheriff (if he's in town).

43 Power up

Yes! It's your chance to find out just what it is that makes the AA team tick. Plus! Take in all this issue's games at a single glance. Marvellous!

44 Kids Pack 2

It's finally here. More horrific violence coming your way... No sorry, wrong game. This one's cute 'n' cartoony!

45 The Popeye Collection

Time to crack open the spinach! It's all three Popeye games in one compact box.



Tread in Robin's footsteps! Turn to page 31.

48 Postman Pat Hit Collection

He's back. He's mean. He's got three games to his name, and Alternative have just released them on a compilation!

50 Classic Arcadia

There were only meant to be three, but Alternative have gone wild and given us six remastered classics!

51 Cheat Mode

Phil Howard jumps on a few pages to regale us with yet more cheats. This month, he shows you how to beat all those Quattro compilations and a smattering of Dizzy games too.

55 Air Attack

Put your head in the clouds and test your flying skills at 50,000 feet! You'll find a lifejacket under your seat and a sickbag to your right. Thank you!



Act like Arnie! Terminator 2 is on page 56.

AA

55 Action Replay

There's only two entries in this month's Action Replay. We've got Terminator 2 and RBI2, and they've both got a whole page to themselves.

Regulars

4 The Tape Pages

You'll definitely need those instructions this month. LARA certainly takes a fair old bit of explaining.

7 Amscene

News from the Amstrad front. Some serious bargains in the way of hardware, software, and slightly-squidgy-ware!

19 Reaction

More of your views, questions and wondrous warblings.

28 Subs

Save time, effort, money, shoe leather, frustration, space, the ozone, "filename.ext", water, the whale and the dolphin... with a subscription!

30 Back Issues

So you missed the eightieth issue of AA, did you? Well, wipe those tears away, turn to this page and cheer up!

42 Small Ads

Are you missing a vital piece of hardware? Got something to sell? Want to swap some software? Got something to tell? Reach 35,000 readers in one go. It's as easy as one, two, three!

58 Next Month

Let us wet your appetite! Isn't it nice to know that the next issue of AA is going to be just as good as this one? Read the last page and smile!

ACTION PACK

A slight change of pace this month, as we settle down to the more relaxed, intellectual feel of a game of snooker and a very serious machine code utility. Why don't you just go and get your slippers?



Steve Davis Snooker

You've shot the bad guys, saved the planet, won the race and flown the helicopter. Now it's time to play a nice relaxing game of snooker. Failing that, hit 'em as hard as you can!



2 LARA

Bored with BASIC? Not much good at COBOL? It could be time for machine code, and time to check out LARA! Even if you hate coding, take a look anyway. Not only is it free, it's also amazingly good. Even if you don't know what's going on, you can still sit and gaze in awe. Alternatively, you could actually use it!



Type-Ins

Some more of the hottest reader programs to ever reach AA Towers, and you don't even have to type them in! For the inherently lazy among you, we've put them on the tape. There's a height predictor (incredibly strange, but remarkably true!) a flags utility, and loads more for you to look at and learn from.

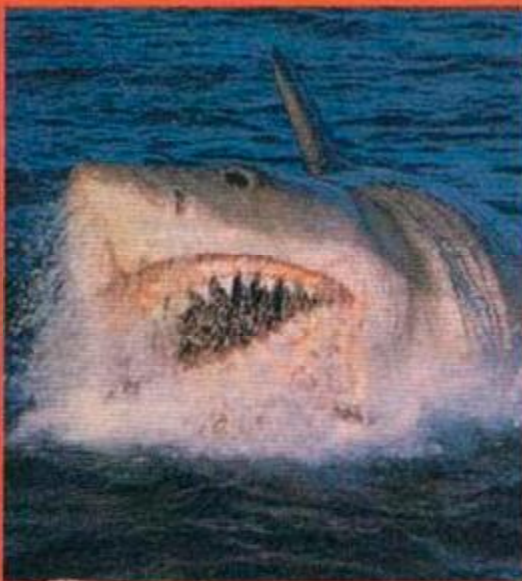

No POKES!

For a while this month we thought we'd have enough room for the POKES on the covertape - that's why we wrote all about them on the tape inlay. Unfortunately, Steve Davis Snooker and LARA were both so big that there was no tape space left for our poor forlorn little POKES. Aaahh! Don't worry, they'll be back next month. In the meantime, sit back in and enjoy this issue of AA.

Just turn the page for all the details

ACTION PACK

Complete Game CDS Software

Here at AA Towers, we've had enough of guns for a while. It's time to be nice to animals, bad guys, and aliens. We want to play something a little more passive, something which calls for a quiet kind of skill, for a careful aim and gentle endurance. Something, in fact, like *Steve Davis Snooker*.

Snooker doesn't excite everybody, but we think we'll make lots of converts out of you lot with the help of this game. But before you go and play it, we're going to have to quickly show you how it's done.

Use the keyboard keys Q, A, O, P and ENTER (or a joystick) for moving your target around the table, and press fire. Then use left and right to set the power of the shot, and press fire again. Next, move the arrow around the white ball at the bottom of the screen to select spin. After that,



Spin the ball by using a combination of keys, and go for the red.

SNOOKER DOS AND DON'TS

You don't want to offend any snooker players by not adhering to all those special little points that they care so much about. Not only would you seem like an outsider, but it's not polite.

- Unlike real snooker, you are allowed to eat and drink whilst playing *Steve Davis Snooker*.
- No spitting.



Oooh, you're so close. Just nudge it and you could have your ball!

Steve Davis Snooker

It's time to put away those guns, space helmets and other worldly toys. Instead, settle down at your monitor with a nice cup of orangina and enjoy a game of snooker.



And you're off! Take your time and look at all the angles.

press fire, and watch all the balls whizz around!

When you pocket a red (stop, thief!), you can select a colour by pressing the corresponding number key on the keyboard. The numbers are easy - They start at two, and run in order of points (yellow, green, brown, blue, pink, and black). Oh yeah, at the start of the game, you have to position the cue ball somewhere in the 'D' (the semicircle at one end of the table) by using normal directions and fire/enter.

If you are so abysmal at aiming a white ball that you foul, you will be asked 'Play Again?' This is simply if you want the player who committed the foul to play the next shot or not. It's not at all complicated!

As for the more advanced rules of snooker, you could go out and find a book or something,

- Using the thin end of the stick, hit the white ball with the stick, and hope it hits the red ones.
- If the red balls fall into one of the holes at the side of the table, you have to cheer.
- Follow this move by hitting one of the lovely coloured ones into a hole as well.
- If you manage to hit the white ball into a red one and nothing goes into a hole, it's the other player's turn.
- If you lose the black ball in a hole before one of the reds, or any ball hits the pint mug on the table, you're out.
- Don't eat the blue chalk.
- Don't distract other players by blowing in their ears.
- Don't wear tight, shiny brown trousers.
- Don't even think about cracking one of the thousands of possible smutty jokes to be made about snooker. (And that also includes you, Simon. Ed)

Snooker - is it a game of carefully-taken angles and razor-sharp wits, or is it just two blokes hitting little balls with big sticks?

Well, Steve Davis thinks it's the former and Mrs Gladys Frunge from Kidderminster said she would stand up, in public, in support of the latter view.



but you probably won't need it. If you don't manage to pick up the general idea of this game then you're obviously a babe in arms and shouldn't be touching anything electrical. It's kinda surprising that we should have to go through the rules, but there may have been some little bit you weren't clear on, so it's better to sort everything out!

CONTROLS

Joystick or the keys Q, A, O, P and ENTER



And when you've perfected the moves, why not start another game?

Type-ins

For all those of you who are too worried about their fingernails to tap in long lists of numbers, here are the pick of the recent crop of fruity AA Type0ins.

Flags Ross Riley

Wow! It's a flag! And another! There's Germany! America! Fab! Groovesome etc. Sit back and watch this nice little display of the major flags of the world.

Okay, so you're probably wondering what use this program could possibly have. Well, have you ever considered the fact that there are some people out there who get loads of enjoyment out of looking at flags? Well, there are. So spare them a thought!



Look at that! Isn't it lovely? A real work of art, that is!

Height James Ross

Have you ever noticed just how easy it is to insult short people? (Watch it, you're on very dodgy ground. Ed) Some people on the AA team are a little under-tall themselves. (I'm warning you. Ed) Here's a nice program with which you can tell stumpy people that they aren't going to get any nearer the clouds. Just enter your height in centimetres, or millimetres if it's easier, your age, and this program tells you what height you'll eventually reach.



Did you know that most males grow up to be taller than their mothers?

Number Scoffer Dean Jackson

It's time to blip round a screen scoffing numbers, and avoiding the nasties! What fun! It's also very, shall we say, uncomplicated. Use the joystick. (Is that all there is to say? Ed) Erm, yes. It's easy and it's fun. Basically. (There must be more than that? Let me have a go... I see what you mean. It certainly is good fun, and it's ever so easy to pick up. But what you didn't mention is the fact that it's a bit on the addictive side. And that's quite an important point. Ed)

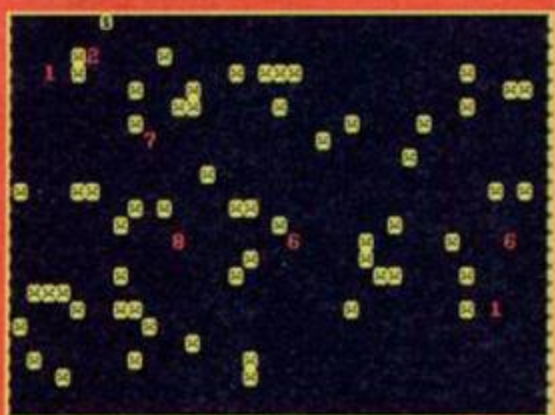

I'm a little number, short and stout, I haven't done any harm. Don't eat me!

Swap Paul Turner

Have you ever played one of those puzzle games where you have to slide all the bits around? (I love those, they're my fave. Is this game like that? Can I have a go? Ed) Yes, this game's just like one of those and it's fab. The point of the game is to finish with an exact mirror image of the starting position of the grid. Simply move the bits using the cursor keys, and press copy when you want to swap a piece. Actually, it's a similar concept to the puzzley bits in Terminator 2. Okay, you can have a go now, Ed.



Gesh, it even tells you what to do. How awfully considerate!

How to load your covertape

Just pop the tape into your machine, making sure it's rewound to the start of Side 1, and then press CTRL + ENTER (or type RUN"), then press any key and the tape will start loading.

Within a few moments you get a menu screen. Choose the program you want using the Spacebar, then hit the Return key.

- Note that none of the programs need be loaded directly from the main menu. They can all be run from BASIC. The menu lists them, but you must quit back to BASIC to run them. (Use the RUN"(filename)" command.)

- If you have a disk drive either built into your machine or plugged in, you will first have to type ltape to switch the computer to tape loading. You get the | character by pressing SHIFT+@. Then just proceed as normal.

Duff tape?

We go to great lengths to make sure that our covertapes work properly. However, if you still have difficulty, try this:

- Loading at several different volume levels (if you're using an external tape recorder)
- Cleaning the tape heads. This can be done with any commercially available cleaning kit
- Adjusting the cassette recorder's head alignment. The alignment screw is located just to the left of the tape head, and is usually accessible through a small hole. Turn it a fraction at a time with a jeweller's screwdriver. When the crispest sound is heard, the alignment is spot on.
- Tapping the cassette gently against a table edge - the spools may be sticking or jammed.

If you still can't get the tape to load then send the tape, along with a brief description of the problem and a sae to:

**AA90 Covertape Returns,
Ablex Audio Video Ltd,
Harcourt, Halesford 14,
Telford, Shropshire
TF7 4QD**

Want a disk version?

The covertape contains its own tape-disk copying program. To transfer the programs to tape, simply follow the instructions on the tape.

- 464 owners with external 3-inch drives will have no problems, but 6128 owners will need a cassette player with a REM socket. Stopping and starting the tape manually is difficult.

- 6128 Plus owners who've had their machines modified to load from tape can transfer the programs to disk, but must rewind to the start of the tape again before the transfer starts.

You can also order a disk version of the covertape from our duplicators, Ablex. Snip off the coupon on the corner of this page and send it with a cheque/PO for £2.00 to:

**AA90 Disk Offer, Ablex
Audio Video, Harcourt,
Halesford 14, Telford,
Shropshire
TF7 4QD**

Run this month's fabulous type-ins by typing RUN" and pressing enter or return.

**Disk 90
Token**

If somebody walked up to you in the street, and whispered in your ear, "Ere, squire, fancy a top-quality machine code utility for only £5?" you'd probably be quite tempted. But buy it, and you'd have wasted your money, because this month's covertape contains just such a utility and it's completely free.

We couldn't put the instructions for LARA on the tape, because they're 45K long. There also written in German. This is a pity, because it can be tricky to use. However, this short tutorial should get you acquainted with what is possibly the best Z80 monitor available for the CPC.

LARA positions itself in extra memory if you have a 128K computer, so as not to corrupt the main program. You can load LARA, exit (press E followed by ENTER), load the program you want to have a look at, and then re-enter LARA (with SHIFT and function key 9). 64K users are restricted to the memory below &4000, which is okay for programs of less than 16K.

LARA commands mostly consist of a single letter, sometimes followed by one or more parameters. The first command you should know is H (or ?) which brings up a help-screen of all the available commands. When it pauses, press any key to progress to the second screen.

Let's have a look at a few of these commands. To dump memory to the screen, type D followed immediately by the address from where you want to start (for example, DBB00 to start from &BB00). After a while, the memory dump will stop: just press D and ENTER to carry on from where you left off. You can also disassemble code: instead of typing D, use L instead.

This is all well and good, but it's possible that

LARA

LARA is a toolbox utility for machine coders and it's a teensy bit on the clever side. No hang on, it's more than that - it is in fact remarkably clever!

you don't have anything in memory to look at right now. No problem: load in a file using the R command. If you want to load it to a specific address, add a comma followed by the address (in hex) at the end of this. CP/M .COM files can be read by using the CR command.

You can also use LARA to look at ROMs. To do this, type K followed by the ROM number (for example, K07 will select the disk ROM), and then disassemble or dump as usual - remember that ROMs sit between &C000 and &FFFF. KFF returns to RAM.

To alter the contents of memory, use the S command followed by an address (S4000 alters &4000 onwards). The address will be shown, followed by its present contents, and a cursor for you to type in a new value - or simply press ENTER to move to the next one. ESC quits this mode. To make it easy to enter text into memory, the P command is available, which is followed by the relevant address and text (e.g. P170,Another great program with AA!)

Perhaps you need to search for some bytes. LARA's Q command comes in here: for example, to search between &4000 and &7FFF for the sequence &CD,18,&BB, type Q4000,7FFF,CD,18,BB. You can also look for

strings: if you wanted to search the whole of memory for the string "hazelnuts", you would type QT0000,FFFF,hazelnuts - Easy!

At some time you'll probably want to execute a machine code routine in memory: to do this, type G followed by the address. Two break-points (i.e. places where the computer pauses and reports what's going on) can be set, the address of which should be added to the G command with a preceding comma (for example, G3000,3012 would execute code from &3000, and stop when &3012 is reached).

If you're not exactly sure what effect the routine will have on memory, 128K owners can use the commands YG and YP: YP puts the contents of memory into your extra memory (as a backup), and YG gets it back again. 64K owners, obviously, can't use this facility. You can move small areas of memory to a safe place somewhere else using the M command (M2800,29FF,8000 copies the bytes between &2800 and &29FF to &8000).

We could go on for hours, but now that you know the basics, you can just as easily find out by experimentation. (Besides, there's no space left.) The program is great for debugging code and examining other people's: 128K owners should even be able to use it in conjunction with the Multiface's "jump" function to hack into games. Now, no program is safe (evil cackle)...

LARA by Jürgen Heber

```
-?
B(base)
CR(file),(adr)
CH(file),(start),(len)
C(drive)
D(start),(end)
E
F start,end,byte
G(start),(brk1),(brk2)
H or ?
Hint1,int2
H.byte
Hidez
I
R(confbyte)
L(start),(end)
```

```
SCREENBASE
READ COMFILE
WRITE COMFILE
CAT
DUMP MEMORY
END LARA
FILL
GO CODE
HELP
COMPUTE
CHANGE TO DEZ
CHANGE TO HEX
INIT SCREEN
MEMORY KONFIGURATION
DISASSEMBLE
```

The question mark at the command line gives you a list of all the commands available.

And what a truly huge amount of commands there are. This is just the first section of the list.

Coming Soon!

Don't forget that next month AA will undergo a radical change. Not, we hasten to add, in the content of the magazine, but the covertape will be one of the best we've ever given you. Amstrad Action, in conjunction with Tasman Software, brings you the truly excellent and renowned word processing package Tasword 464.

As usual, the tape will also contain a superior complete game. To fit all this on to the tape, we've had to raise the cover price slightly - the new AA will cost £2.95. But you are getting a full word processor (that will

work on disk machines as well) for a mere 45p!

All this, plus the usual blend of news, reviews, serious software, programming, and AA fun! Please turn to page 21 for an explanation from Amstrad Action's publisher.



Amscene

Amstrad news, views and goodies!

This month we've found loads of bargains for you and a fair bit of news. If you've got any info that you think should be passed on to other Amstrad owners, then write to Amscene, Amstrad Action, Beauford Court, 30 Monmouth Street, Bath, Avon BA1 2BW.

Fly Fishing...

We don't quite know whether anyone's noticed this before, or whether it was some kind of naff joke (and we'd know all about them) on the part of the author, but if you look at last month's review of *Vigilante*, you can't but help notice that the author of the game is one Mr J R Hartley.

Cheap ROMs

Too cheap to buy a full ROM box? Dartsma PD is knocking out Arnor's AD1 boxes (only one socket folks) with Maxam or maybe Protex stuffed in. They cost around £10, but stocks are limited (he's go about twenty left). As usual, you can find Dartsma on 081 317 1170.

WAVE Update

Long standing hardware suppliers WAVE have announced some new products soon coming to the CPC. Amongst these will be a range of leads to connect your old CPC monitors to completely different computers – solving a lot of reader's queries! They can supply leads to connect both old monitors (CTM 640/644) and new monitors (CM14) to Amigas (£14.99), STs (£15.99), MegaDrives (£12.99), and Spectrum +2s and +3s (£12.99). Unfortunately, the old monitors don't have speakers, so you'll need an extra pair, or headphones.

On top of this, they're reproducing the MP3, which allows you to use your old monitor as a colour TV (if you've got a colour monitor) for £34.99, plus £5.88 handling fee.

You can contact WAVE on 0229 87000.

HackIt's Back!

Just when you thought it was safe to turn your CPC back on, Siren Software release their new HackIt black box (well it's white, actually). The new model is said to be even better as it's stuffed with an assembler as well as all the usual stuff. We'll have more for you at a later date.

CampurSoft Goes Ape!

Campursoft have got wads of new stuff coming out, including a scanner, a genlock (limited version), a memory expansion, and a stunning hard disk drive (possibly with an autoboot feature) with software written by our very own ChaRleyTroniC!

The Aussie's Need Help!

No, that's not cultural prejudice, it's a fact. They've got no CPC support down there! A certain Peter Campbell is a tad concerned at this, and has supplied two contacts for them.

The first is Q3Soft, based in Tasmania on 002 535318, and the second is the PCW Australia User Group who support CPCs as well, on 027 571105. Give them a call today!

Dartsma Moves House

Dartsma PD has now changed address, and can now be found residing at 5c Robert Street, Plumstead, London, SE18 7NE.



That's Tanya on the left and John Barnes is the one with the silly grin. No, hang on...

A Final Photocall

I know our "Get-A-Photo-Of-Yourself-With-A-Star-And-A-Copy-Of-Amstrad-Action" competition finished a while ago now, but we just had to print this one of Tanya Winston and her brother, Ben, next to Liverpool's John Barnes. And was she thrilled? "Not really, I actually support Arsenal."

Creative Dealings

Creative are offering the 464 Plus with a mono monitor for just £115. They've also got a few modulators for the knockdown price of £19. Hurry while stocks last! Call 0353 663030 now!

Computer Shopping Spectacular

If you're anywhere in the Telford area on March the sixth and seventh, then pop into the Telford Exhibition Centre. Why? Well, it's hosting a massive computer fair and we've heard that there are going to be lots of bargains, competitions and a local radio roadshow. Cool!

The Mammoth AA Compo Results Bit

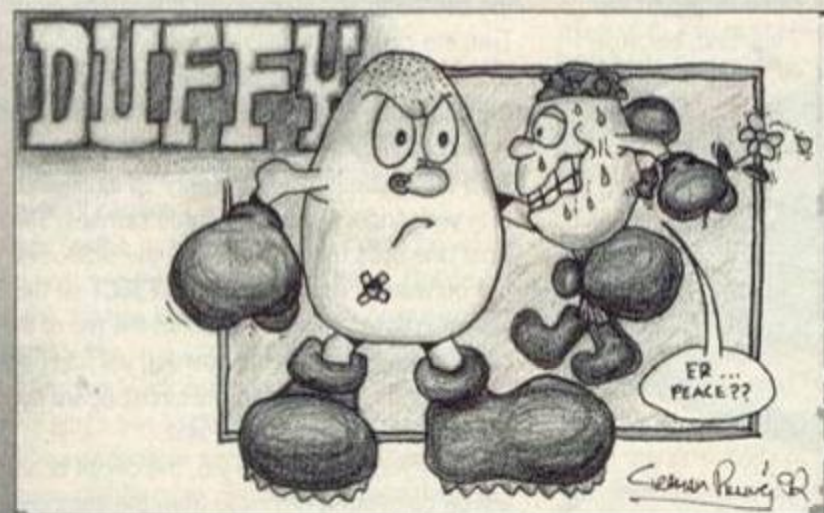

The scenario: Wading into the office through thousands of Dizzy pictures to find the AA editor curled up in the foetal position under a desk. "I've done it! I've finished judging the Dizzy competition!" Oh dear. Seems the strain was too much for Rod. That's the real reason he left, you see. He simply couldn't handle all the hideous egg gags.

Whilst being strapped up and carried off, he gave the name of the competition winner in a demented scream. "Graham Pilling of Huddersfield for his Duffy!" Now... Because we're all sadists here at AA, we're going to torment a few of those who didn't win, but came damned close. They're Aidan McKenna, Malcolm Cleland and Tom Ash, but they don't get a single egg gimick!

Rod, however, totally neglected to judge the Alternative compo that night, so we did it for him. The winner here is David Southgate of Staffordshire, so he can expect a bag of games pretty soon!

BIGGER AND BETTER

THE WONDERFUL WORLD OF UPGRADES

Of all the great add-ons for the 464 Plus the most popular are the 64K RAM pack and the disk drive. They're also the most expensive... or are they? In the first part of a new series, PHIL CRAVEN tells you how to cut the cost of add-ons.

A RAM pack costs between forty and fifty pounds, and a disk drive about £160. There's no doubting their usefulness but there's no doubting their cost either.

So what if I were to tell you that you could have the extra 64K for only a tenner? You like that? And how about knocking, say, fifty to sixty quid off the cost of a drive? You like that too? Aaw, shucks. Sad to say, it can't be done. I'm sorry to be the one to tell you but, although we can get you the drive

for a tweak over £100, the best we can manage the extra 64K for is £10.72, including VAT and postage, which is a massive 72p up on what I led you to think. You still want it? Oh, all right. If you've got money to burn, read on.

Until you actually buy one, you wouldn't know that the existing 64K RAM pack was designed to perch neatly on the back of the older 464 and, although it works fine on the 464 Plus, it doesn't exactly perch neatly anywhere. In fact it

fits rather like a square peg in a round hole, and I don't just mean that they have different connectors. The RAM pack is too tall for the 464 Plus. The answer to this is to either raise the computer on a board or use an extension cable and let the RAM pack sort of flop all over the desk. The best solution is not to use the RAM pack at all but to put the extra 64K inside the computer where it couldn't be neater. Using a soldering iron, a solder sucker and this article you can upgrade your 464 Plus to 128K, the same as the 6128

Plus, and, because the parts cost a mere

£10.72, you can save yourself at least £30 in the process!

It isn't widely known, but the main circuit boards of the 464 Plus and the 6128 Plus are identical, having identical circuit tracks and identical holes for the various components. The difference between the two models is that the 6128 Plus has the disk interface and extra 64K components fitted where the 464 Plus has holes and the 464 Plus has tape components fitted where the 6128 Plus has holes. So it doesn't take an Einstein to wonder if putting the extra 64k components into the correct holes in the 464 Plus' circuit board would produce a 128K computer – and it does! The same applies with the disk interface components (464 Plus) and the tape interface components (6128 Plus). But first – the extra 64K.

Assembling the upgrade kit is simple. There are ten components to buy and fit (see the parts list) but, before you rush to get them, take a little time to examine the task ahead and make sure that you are confident enough to perform it or that you know a man who is.

With all power turned off, remove all peripherals including the cartridge and tape from the computer and disconnect it from the monitor. Turn the computer upside down and remove all the screws from the underside. While you've got the underside up, notice the three catches – one in the centre of the front and one on each side. Turn the keyboard the right way up again and, with your fingers, undo the three catches. The front one pulls towards you and the side ones pull outwards. That done, press EJECT on the tape player to raise its lid and lift the top of the casing away from the keyboard. It will fold back but it is still connected to the circuit board by several wires so don't yank at it.

Whilst you're doing the job, the circuit board will be completely removed from the computer but, at this point, leave it where it is and leave



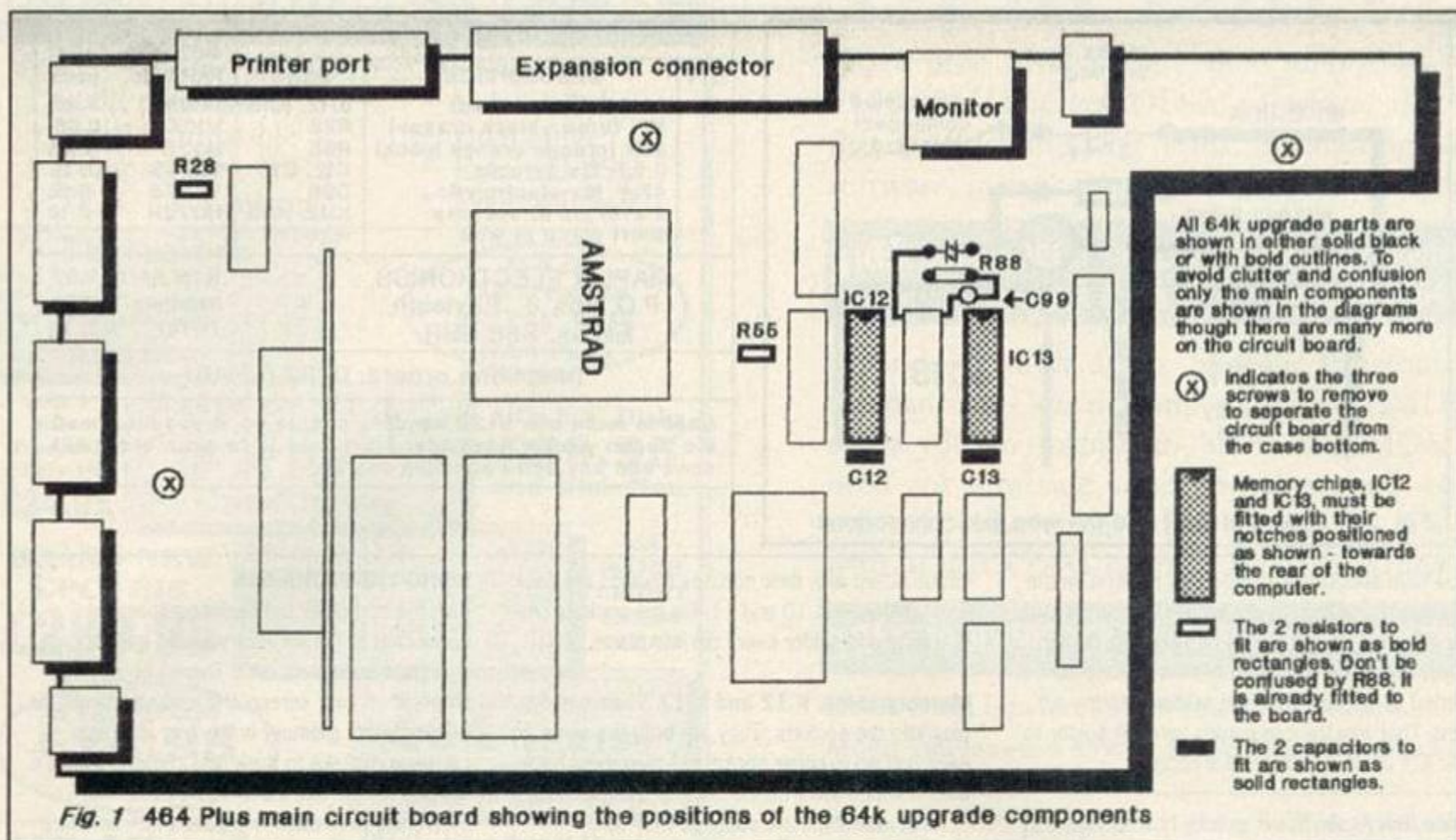

Fig. 1 484 Plus main circuit board showing the positions of the 64k upgrade components

the top connected to it. Don't touch anything on the circuit board but compare it with Fig.1 and Fig.2 and take a little time to consider how the 64K upgrade will be done. Fig.1 shows where the components are fitted to the circuit board, Fig.2 shows the detail of fitting the electrolytic capacitor and wire link and the parts list indicates each component that you will have to fit. Use the diagrams to identify the location where each component fits. You will notice that the holes for the components have been filled with solder during the manufacturing process and it needs to be removed before fitting the components. For that, you'll need a solder sucker. Tandy sell a cheap bulb-type one that looks like abit like a small vinegar bottle and Maplin sell a better one called a Desolder Tool - its order code is FR26D and it costs £3.95.

If it looks easy enough to you then go ahead and buy the parts. If not, then close up the computer in the reverse order to opening it and consider the service offered by Avatar.

DOING IT

Open the computer as described earlier. Now, before going any further, hold your cold water tap for a second to discharge any static electricity from your body. That done that, touch the circuit board and chips as little as possible. Zapping a chip with the body's static electricity is rare these days but it's always better to err on the side of caution.

Remove the case top from the circuit board by disconnecting the wires that join them. Notice that the the two pairs of wires have colour-coded sockets - the blue socket goes on to the blue plug and the black one on to the black plug. Those plugs and sockets clip together and a small screwdriver is needed to prise their vertical tongues slightly open. Remove the tape deck connector by pulling it upwards. Remove the

keyboard by pulling the two film connectors from their sockets and take out the three screws that hold the circuit board to the case bottom (see Fig.1). The circuit board can now be lifted out but handle it by its edges. The component's pins on the underside of the board are sharp and will scratch a polished surface. You have been warned, you've no excuse.

Suck the solder from the holes that are needed for the ten components. You'll probably find it easier to suck from the underside of the board. Don't worry about the weight of the board bending the copper leaf springs. They will bend back again later. With the solder sucker poised very near a hole melt the solder inside the hole with your soldering iron, quickly move the sucker nozzle onto the hole and suck. Some of the holes will only be partly filled and sucking is more successful when a hole is full so, if at first you don't succeed, fill it up with solder and try again. It's easy when you get the hang of it. When all the holes have been cleared look closely at them, preferably with a magnifying glass, and get rid of any solder bits. Now you're almost finished!

There is no particular order in which the components should be fitted but, to help you get used to it, you might like to do resistors R28 and R55 first. The only fiddly bits are the wire link and the electrolytic capacitor, C99, which are best fitted before the IC sockets. Otherwise the sockets can get in the way.

FITTING EACH COMPONENT

Resistors R28 and R55 To make buying the parts easier, I have specified them all from a single source, Maplin. But Maplin don't stock the precise resistors that Amstrad used in the 6128 Plus machines (1/6th watt, 4.1mm long). To avoid any possibility of overheating the resistors, the ones specified are 6.8mm long and are bigger than those already in the circuit board.

This is not a problem. Bend the wires to fit the holes and solder into place.

They are coded by coloured bands as shown in the parts list followed by a brown and a red band. Be sure to put the correct resistor into the correct place. It doesn't matter which way round they are fitted. Push the wires of one resistor through its holes so that the resistor's body is quite close to the circuit board and bend the wires outwards on the underside of the board. That prevents the resistor from slipping out when you turn the board over to solder it into place. Turn the board over and solder the wires into place. Trim off the excess wire. Now do the same with the other resistor.

Capacitors C12 and C13 These are brown discs. Like the resistors, they can be fitted any way round - either wire in either hole.

Electrolytic capacitor C99 There are no holes for this one and when you've fitted it, you'll think it looks a bit odd but, surprisingly, this is exactly how it is done in the 6128 Plus.

C99 is a small metal can with two wires at one end and a dark stripe down one side, next to one of the wires. The stripe indicates that that wire is negative. It is important to connect this capacitor the correct way round. Fig.2 shows it as a circle with a positive sign (+) at one side and a negative sign (-) at the other. The negative sign indicates the dark stripe side. Melt a small blob of solder onto pin 18 of the existing memory chip, IC11, and solder C99's positive wire (not the dark stripe side) to that pin. Solder the negative wire to the side of the existing resistor, R88, as shown in Fig.2. You'll need to bend the wires to fit and the result will leave the capacitor sticking up but it can be bent over a bit before you close up the computer.

When soldering to an IC pin, as in this case,

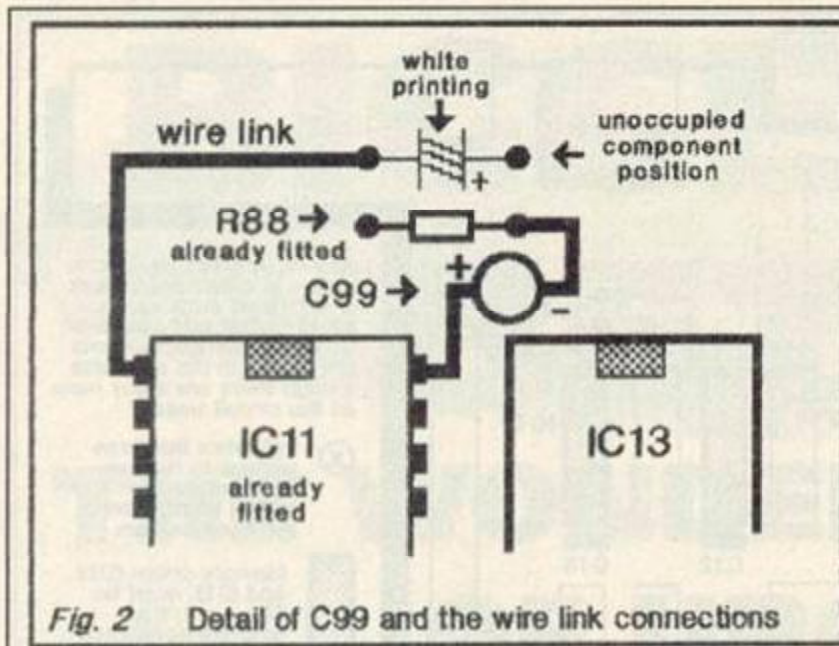

Fig. 2 Detail of C99 and the wire link connections

you have about six seconds with the iron on the pin before the heat starts to become dangerous for the chip. Six seconds is a very long time in soldering terms but, even so, it is best to do it as stated by melting a blob of solder onto the pin first. That way the capacitor's wire will solder to the IC's pin in a fraction of a second.

Wire link Again, this is exactly how it is done in the 6128 Plus. Any short piece of wire will do. Strip about 1/8" of insulation from each end of the wire and tin the exposed metal conductors. Tinning is covering the conductor with solder and it is done by holding the soldering iron onto the conductor and allowing solder to melt over it.

Melt a blob of solder onto pin 1 of the existing memory chip, IC11, and solder one end of the wire onto it. Solder the other end of the wire to the hole as shown in Fig. 2. It isn't necessary to clear that hole of solder as melting it will allow the wire to push through.

Sockets for IC12 and IC13 These aren't really necessary but many people are afraid to solder the pins of chips. The sockets avoid that and they are cheap enough.

Look at the existing IC10 and IC11 and notice that they each have a notch at the end nearest to the back of the computer. The notches are to indicate which end is which. Most sockets have notches too. If yours do, then place them into the

circuit board with their notches towards the back – exactly like ICs 10 and 11. Do the sockets one at a time and solder every pin into place.

Memory chips, IC12 and IC13 These simply plug into the sockets. They are both the same so each can go in either socket but they must have their notches towards the back of the computer.

Most new chips are supplied with 'splayed' pins which must be bent inwards. It's quick and easy to hold a chip at each end with one row of pins on a hard surface and push down so that the whole row of pins bends inwards. You want each row to be more or less at right angles to the chip's body. Push each chip into one of the sockets making sure that all the pins go in and none become bent.

CLOSING UP

The upgrade is now finished and the extra memory can be used but, before closing up the computer, check that you have C99 the right way round and that the memory chips have their notches at the back. Now you can close it up, remembering to screw the circuit board to the case bottom and reconnect the keyboard's two film connectors, the tape connector and the blue and black wire pairs. The copper leaf springs should rest on the underside of the keyboard. If they have been bent down and can't touch the keyboard, bend them up again so that they do.

PARTS LIST

QTY	DESCRIPTION	PART	MAPLINS PART No.	cost each
2	41464 or equivalent	IC12, IC13	UH93B	4.45
1	10K (brown black orange)	R28	M10K	0.03
1	33R (orange orange black)	R55	M33R	0.03
2	0.1uF 12v ceramic	C12, C13	YR75S	0.12
1	47uF 16v electrolytic	C99	YY37S	0.12
2	2 x 18 pin IC sockets	IC12, IC13	HQ76H	0.10
1	short piece of wire	wire link	—	—

MAPLIN ELECTRONICS,
P.O. Box 3, Rayleigh,
Essex, SS6 2BR.

total parts 9.52
handling 1.20
TOTAL £10.72

Telephone orders: 0702 554161

Maplins make one £1.20 handling charge so, if you also need the solder sucker (desolder tool), add it to your order but don't add any extra handling charge.

USING THE EXTRA 64K

With the computer put back together and connected to the monitor you can turn it on et voila! Nothing! Now! Zilch! There'll be nothing different on your screen and nothing to indicate that the extra memory is there at all. It's a common mistake to think that some software is needed for the extra 64K to be used. The DKTronics RAM pack is supplied with software which people imagine is necessary, but it isn't. What it does is test the extra memory and provide some RSX's so that it can be used from within Basic programs. But the main use of the extra 64K is with commercial programs that are written to use it and those programs will find it straight away. You don't have to do anything. You don't have to tell the computer that it's there and you don't have to tell a program that it's there. Programs that want it will find it. CPM+ is one such program.

Using the extra memory in your own BASIC and machine code programs needs some knowledge of the CPC's memory organisation facilities which, unfortunately, is beyond the scope of this article.

FINALLY

DIY projects that tell you how to alter the insides of your computer are unusual and we don't want to leave you in the lurch so we have taken the unusual step of providing technical help for this project on a special phonenumber – the number is 0274 602180. It must be said. If these instructions are followed accurately, and the parts are good, the upgrade will work. But we cannot control what a person does inside his/her computer and neither Amstrad Action nor Future Publishing, nor the author of this article can accept any responsibility or liability for any damage to parts or equipment that might occur by doing this project. I can say is that many others have already done the project as sold in kit form by Avatar.

Hopefully, you've read this far before closing your computer so wet your appetite a bit by spotting another group of unused holes on the circuit board, including a set behind the tape deck that is obviously for a connector. A disk drive connector? You'll just have to wait and see, won't you? Seeya next month.

And for 6128 PLUS owners..."

Have you always wanted the facility to use tape software and copy tape to disk but have been frustrated by the lack of a tape input on your computer? Have you considered the available tape upgrades but are concerned when press statements say, 'but it doesn't operate the remote?' To be fair though, there is one available upgrade that does operate the remote. Nevertheless, coming soon to an Amstrad Action near you is the DIY and ultra-low cost tape upgrade that does operate the remote. Stay tuned.

POKING

AA presents the longest list of Multiface POKEs ever. Phil Howard is the man responsible for giving you everlasting life.

The Multiface way

The (t)s and (d)s before the address indicate whether the POKE was written for a tape or disk game (they might work on both, it's worth a try). Just in case you don't already know how to put in these BLACK BOX POKES, here are the steps to success.

- a) Load the game as normal.
- b) Press the RED button on the MULTIFACE.
- c) Press "T" for tool.
- d) Press "*" to make sure you select the game code.
- e) Press "H" for HEXADECIMAL input.
- f) Press "SPACE" for input.
- g) Type in the ADDRESS (4 characters ie. 3A7C)
- h) Type in the POKE (2 characters ie. A7)
- i) Press "RETURN"
- j) If there is more than one poke (indicated by a ") goto (f)
- k) Press "ESC" back to the menu.
- l) Press "R" return to the game.

1942	(t) 2974 C3 Manual rapid fire
1942	(t) 2982 00 Auto rapid fire
1942	(t) 24C0 C9 Inf lives
1942	(t) 24D0 C0
1943	(t) 7A21 A7 Inf energy
3D Starfighter	(t) 7F3A 00 Invulnerability
3D Starfighter	(t) 7F15 00
720 Degrees	(t) 8027 00 Inf lives
720 Degrees	(t) 9528 00 Inf credits
720 Degrees	(t) 80B8 00 Inf tickets
ATF	2C5A FF 255 Lives
ATF	(d) BE4C FE Lots of fuel
ATF	(d) BE61 FF Lots of cannon
ATF	(d) BE62 FF Asraam missiles
ATF	(d) BE63 FF Maverick missiles
ATV Simulator	(t) 4C1E 00 Stops the clock
Academy	8CF3 00 Inf missiles
Academy	8D17 00 Inf ammo
Academy	8DD6 00 Inf delay bombs
Academy	8CC8 00 Inf flares
Academy	A049 00 Inf fuel
Academy	8BEC 00
Academy	83C2 00 Inf shield
Addams Family demo	(t) 12D0 00 Inf lives
Advanced Pinball	(t) 0415 00 Inf balls
After the War	(t) 804E 00 Inf lives (part 1)
After the War	(t) 8049 00 Inf lives (part 2)
Afterburner	(t) 1D58 00 Inf missiles
Afterburner	(t) 20A7 3A Inf lives
Agent X 2	(t) 5CDA A7 Inf energy
Airborne Ranger	(t) 945A 5C Inf aid - press DE
Airborne Ranger	(d) 9539 3B Inf aid - press DE
Airwolf 2	(-) 822B No lives
Airwolf	(t) 786F 00 Inf lives
Alien 8	(t) 41BE 00 Inf lives

Alien 8	(t) 2EFE 00 Inf time
Altered Beast	(t) 0980 00 Inf credits
Altered Beast	(t) 0989 00 Inf credits
Anarchy	(t) 48E1 C9 Inf lives
Android 2	(t) 2822 00 Inf shields
Antiraid	(t) 5749 00 Gives boots
Antiraid	(t) 64F4 00 Gives guns
Antiraid	(t) 5BBE B7 Invulnerability
Antiraid	(t) 6F58 B7 Inf energy
Antiraid	(t) 6F3A 00 Radiation (1)
Antiraid	(t) 6F3B 00 Radiation (2)
Arcade Flight Sim	(t) 9D12 00 Inf lives (1)
Arcade Flight Sim	(t) 9CD6 00 Inf lives (2)
Arctic Fox	(t) A300 00 Inf shields
Arkanoid 2	(t) 3318 A7 Inf lives 1st load
Arkanoid 2	(t) 419C A7 Inf lives 2nd load
Arkanoid 2	(t) 3318 A7 Inf lives 3rd load
Arkanoid 2	(t) 4207 A7 Inf lives 4th load
Arkanoid	(t) 20FE 00 Inf lives
Arkanoid	(t) 20F3 00 Inf lives
Arkanoid 2 (coin op)	(t) 3318 A7 Inf lives (load 1)
Arkanoid 2 (coin op)	(t) 419C A7 Inf lives (load 2)
Arkanoid 2 (coin op)	(t) 3318 A7 Inf lives (load 3)
Arkanoid 2 (coin op)	(t) 4207 A7 Inf lives (load 4)
Army Moves	(d) 0752 00 Inf lives (1)
Army Moves	(d) 0480 00 Inf lives (2)
Artic Fox	8049 00 Infinite shields
Artura	(t) 218B 00 Inf energy
Artura	(d) 218B 00 Inf energy
Astro Marine Corps	(d) 4234 FF Grenades (part 2)
Astro Marine Corps	(d) 4FD5 FF Grenades (part 1)
Atom Ant	(t) 18DC 00 Inf lives
Atom Ant	(t) 1918 00
Atom Ant	(t) 0BD7 No lives
Atom Ant	(t) 1490 No time
Atom Ant	(t) 1413 No bombs
Atom Ant	(t) 1882 C9 No collision
Auf Wiedershen Monty	ADB3 00 Inf lives
BMX Freestyle	(t) 1456 00 Qualify
BMX Freestyle	(t) 1480 00 on
BMX Freestyle	(t) 1481 00 each
BMX Freestyle	(t) 1482 00 event
BMX Freestyle	(t) 148F 00
Back to the Future 2	6954 00 Inf time
Back to the Future 2	7A4C 00 Inf lives
Bad Cat (Go Crazy)	(d) 221D 0A Lots of time
Bad Cat (Go Crazy)	(d) 221E 09 in venue 1
Bad Cat (Go Crazy)	(d) 21FF FF Time in interlude
Bad Cat (Go Crazy)	(d) 21FD 0A Lots of time
Bad Cat (Go Crazy)	(d) 21FE 09 in venue 2
Bad Cat (Go Crazy)	(d) 2223 0A Lots of time
Bad Cat (Go Crazy)	(d) 2224 09 in venue 3
Bad Cat (Go Crazy)	(d) 221A 0A Lots of time
Bad Cat (Go Crazy)	(d) 221B 09 in venue 4
Ball Crazy	(t) 1C6F A7 Inf lives
Ball Crazy	(t) 1C6F A7 Inf lives
Barbarian 2	(t) 3D12 D6 Mega power
Barbarian 2	(t) 3D13 10
Barbarian 2	(t) 3D96 3A
Barbarian 2	(t) 3E12 3A Inf energy
Barbarian 2	(t) 432F A7 Inf lives
Barbarian 2	(t) 432F A7 Inf lives
Bart Simpson	(d) 15AC FF Inf lives
Bart Simpson	(d) 380E 00 Position
Basil Mouse Detect	(t) 90D0 C9 Inf time
Basil Mouse Detect	(t) 8E46 C9 Inf energy

Batman the Movie	1D62 FF Removes grenades
Batman the Movie	(t) EE06 C9 Inf energy
Batman the Movie	(t) 6743 00 Inf lives
Batman the Movie	(t) 76EE 00 Inf time
Batman 3D	(t) 1C90 00 Inf lives
Batman the Movie	(d) EE06 C9 Inf energy
Batman the Movie	(d) 6743 00 Inf lives
Batman the Movie	(d) 76EE 00 Inf time
Battle of Britain	(t) 4030 00 Inf fuel
Batty	432B FF 255 lives
Batty	(t) 4515 00 Inf lives 1 play
Batty	(t) 4523 00 Inf lives 2 play
Bedlam (Go Crazy)	(d) F1BE 09 9 Lives
Beyond Ice Palace	(t) 0D38 A7 Inf spirits
Beyond Ice Palace	(t) 0ED3 C9 and
Beyond Ice Palace	(t) CF32 00 Invulnerability
Beyond Ice Palace	(t) E77F 00 use all 5
Beyond Ice Palace	(t) FF34 C9 pokes
Bigfoot	(t) 1016 A7 Inf lives
Bigfoot	(t) 0601 00 Lots of lives
Billy the Kid	(t) 81C9 00 Inf ammo
Billy the Kid	(t) 92CA 10 One shot
Bionic Commandos	0EFB FF Lots of lives
Black Tiger	(d) 5612 A7 Inf lives
Blackbeard	38DA A3 Inf lives
Blackbeard	4C3E 00 Inf bullets
Blade Warrior	(t) 031B 00 Inf lives
Blade Warrior	(t) 625C 18 Inf time
Blade Warrior	(t) 77A1 C9
Blasteroids	2155 00 Inf lives
Bloodwych	(t) 0523 A7 Inf energy
Bloodwych	(t) 9B73 A7 Inf spell
Bobby Bearing	(t) 8243 00 Disables baddies
Bombfusion	(t) 493A 00 Slows Timer
Bombfusion	4A72 00 Inf lives
Bombfusion	4935 00 Inf time
Bombfusion	(t) 4A71 00 Inf lives
Bombjack	0090 00 Loads of lives
Bombjack II	02EB 00 Loads of lives
Bombjack II	0549 00 Stops all enemies
Booty	(t) 54F4 00 Inf lives
Boulderdash IV	(t) 05E9 FF Extra lives
Boulderdash IV	(t) 6C3C 00 Inf time
Boy Racer	83E4 AF Indestructable (p1)
Boy Racer	83CA AF Indestructable (p2)
Brainache	7312 00 Inf lives
Breakthru	BE38 00 255 lives
Brian Bloodaxe	(t) 684B C3 Inf lives
Brian Jacks s/star	(t) 198D A7 Full strength part 1
Brian Jacks s/star	(t) 1999 A7 Full strength part 2
Bronx Street Cop	(t) 0579 32 Extra time
Bronx Street Cop	(t) 4FFA A7 Inf bullets
Bubble Bobble	(t) 6D26 A7 Inf lives part 1
Bubble Bobble	(t) 6D87 A7
Bubble Bobble	(d) 6D24 A7 Inf lives part 1
Bubble Bobble	(d) 6D85 A7
Bubble Bobble	(d) 6C0F A7 Inf lives part 2
Bubble Bobble	(d) 6C70 A7
Bubble Bobble	(t) 6E72 00 Inf lives
Bubble Ghost	(t) 82A4 00 Inf bubbles
Bubbler	A74E B7 Inf lives
Buggy Boy	1E7F C9 Inf time
Butcher Hill	(t) 115D A7 Inf lives
Butcher Hill	(t) 11FD A7
Cabal	(t) 1972 00 Inf lives
Cabal	(d) 0B1A 00 Inf lives

FUN

Cabal	(d) 1972 00 Can't die	Cybernoid 2	2AD6 C9 Invulnerability	E-Motion	(d) 28A7 00 Inf lives
Camelot Warrior	(-) 089E 00 Inf lives	Daley Thompson	(t) 17DE 00 Inf lives	E-Motion	(d) 1321 00 Inf energy
Captain Planet	7CD6 00 Inf lives	Dan Dare	(t) 7C58 C9 Inf lives	E-Motion	(d) 1329 00
Captain Dynamo	(t) 460F 50 80 lives	Dan Dare 2	(t) 7B91 A7 Inf lives	E-Motion	(d) 2E05 00 Balls don't explode
Captain Blood	(-) 43A3 00 Reset timer	Dan Dare 3	(t) 06FA 00 Inf jet pack	E-Motion	(d) 389E 18 Pods don't grow
Captain Blood	(-) 43A4 00	Dan Dare 3	(t) 48BD 00 Inf ammo	Eagles Nest	(t) 1AE3 00 Inf Keys
Captain Blood	(-) 43A5 00	Dan Dare 3	(t) 7444 00 Inf lives	Elidon	(t) 749F 00 Inf lives
Castle Master	(-) 7E7F 00 Inf energy	Dan Dare 3	(t) E7AA 00 Inf energy	Elite	(t) 4611 00 Inf missiles
Castle Master	(-) 6829 00	Dandy	(t) 570C 06 9990 Energy	Elite	(t) 7401 00 Inf fuel
Castle Master	(-) 7305 00	Dandy	(t) 570D 27	Elven Warrior	18DF 00 Inf keys
Cauldron	(t) 9C83 00 Inf lives	Dandy	(t) 5710 FF 255 keys	Elven Warrior	1826 00 Inf arrows etc
Cauldron	(t) 8D57 A7 Inf lives	Dandy	(t) 570E FF 255 spells	Empire Strikes Back	(t) 0746 00 Inf shields
Cauldron	(t) 8D58 A7	Dark Fusion	(d) 0851 00 Inf lives	Enduro Racer	(t) A114 00 Inf time
Cauldron	(t) 8D59 A7	Dark Side	(t) 6F7B A7 Inf fuel	Escape FTPOTRM	(t) 421A 00 Inf credits
Cauldron 2	(t) 1C90 00 Inf lives	Dark Side	(t) 6E0A A7 and shield	Escape FTPOTRM	(t) 4846 00 Inf bombs
Cavemania	(t) 1FD6 00 Inf lives	Dark Side	(t) 6580 18	Escape FTPOTRM	(t) 6887 C9 Inf power
Caves of Doom	(t) 2525 FF 255 lives	Dark Side	(t) 6581 1B	Exolon	(t) 2A25 00 Inf lives
Chain Reaction	4A41 00 Stops timer	Dark Side	(t) 6E20 00	Exolon	(t) 1159 00 Inf ammo
Chain Reaction	4B81 00 Inf lives	Dark Side	(t) 6E3E 00 Inf time	Exolon	(t) 1F7A 00 Inf grenades
Championship Sprint	(t) 4646 04 Don't lose car	Dark Side	(t) 52B0 00 Inf lives	Exolon	(t) 12FA No start zone
Championship Sprint	(t) 2346 84 Inf spanners	Dead or Alive	(t) 514C 00 Inf bags	Exploding Wall	420D 00 Inf lives
Chase HQ	(d) 2022 00 Inf time	Dead or Alive	(t) 50D6 00 Inf ammo	Extreme	(d) 1B3F 00 Inf time
Chase HQ	(d) 3820 00 Inf turbo	Death Stalker	(t) 171C 00 No ghosts	Extreme	(d) B061 00 Inf energy
Chase HQ	(t) 2074 00 Inf time	Death Stalker	(t) 18BD 00 No demons	Extreme	(d) AB11 00 Inf torch
Chase HQ	(t) 3872 00 Inf turbo	Defenders	OE (t) 8461 18 Inf Lives	F1 Tornado	(t) 977B 00 Invulnerability
Chevy Chase	(t) 24E7 00 Inf time	Defenders	OE (t) 8462 08	Fairlight	(t) 7D2F 00 Inf life
Chicago '30s	(t) 43DD 00 Inf lives	Deflektor	003C No Select level	Fairlight	75AB 18 Unlocks doors
Chimera	9172 F0 Inf water/food	Deflektor	07CF 00 Inf lives	Fairlight	6F88 00 Inf life
Cholo	(t) 8316 A7 Invulnerability	Deliverance	(t) 10FC A7 Inf lives	Fairlight 2	3865 18 Unlocks doors
Chronos	(t) 738B FF Inf lives	Desolator	0819 FF 255 lives	Fairlight 2	3208 00 Inf life
Chronos	(t) 81EB 00 Bonus on screen	Destructo	(t) 5166 00 Inf time	Fairlight 2	3E73 00 Inf brooch (1)
Chronos	(t) 8C5B 00 No background	Destructo	(t) 3DAA 00 Invulnerability	Fairlight 2	3E85 00 Inf carpet (2)
Chubby Gristle	(t) 1468 FF Lives	Devils Crown	(t) 914A 00 Inf oxygen	Fantasy World Dizzy	(t) A063 A7 Lives
Chuckie Egg	(t) 985B 00 Inf lives	Devils Crown	(t) A103 00 Inf bullets	Fast Food	570C 00 Inf lives
Chuckie Egg 2	(t) 67C2 FF 255 lives	Devils Crown	917F 00 Inf oxygen	Fernandez Must Die	538C A7 Inf lives
Classic Aliens	(t) 388D A7 Inf lives	Dizzy	(t) 953A 00 Inf lives	Feud	(t) 0E57 C9 Inf time
Classic Muncher	(t) 09E9 C9 Inf lives	Dizzy	(t) 8925 No speed (1-10)	Final Fight	(d) 1F31 No credits
Classic Arcadia	(t) 1295 00 Rapid fire	Dizzy Yolk Folk	(t) 185F 00 Inf lives	Final Fight	(d) 1F36 No Player 1 lives
Cobra	4CCF 00 Gun shots	Dizzy down the Rapid	(t) 22ED FF 255 lives	Final Fight	(d) 1F37 No Player 2 lives
Cobra	4ECA 00 Inf lives	Dominator	(t) 0736 00 Inf lives	Finders Keepers	(t) 20CE 00 Inf lives
Cobra Force	417F 8F Inf lives	Dominator	09A4 FF 255 lives	Finders Keepers	(t) 20CE 00 Inf lives
Cobra Force	41CC B3	Doodlebug	99AE 00 Inf lives	Firetrap	6DCB FF 255 lives
Collapse	5F1D AA Stops timer	Doors of Doom	85F6 A7 Inf energy	Fimbos Quest	7724 00 Inf lives
Colosseum	68C4 00 Inf lives	Double Dragon	(t) 393D 00 Inf lives	Fimbos Quest	(d) 770F 00 Inf lives
Colony	(-) 2DE9 FF Cash	Double Dragon	(t) 384F 00 Inf time	Fly Spy	(t) AB2C 18 Bombs can't kill
Colussium	68C4 00 Inf lives	Double Dragon	(d) 4CEB 00 Inf lives	Flying Shark	(t) 4FA6 00 Inf smart bombs
Combat School	042C 0A Slows timer	Dragon Spirit	(t) 206B 00 Inf lives	Forgotten Worlds	00F3 00 Inf energy
Combat Lynx	(t) 5899 No of choppers	Dragon Breed	3612 00 Inf credits	Frankenstein Jnr	5DA7 A7 Inf bottle
Combat Zone	(t) 05FE 00 Inf lives	Dragon Breed	3A1E 00 Invulnerability	Frankenstein Jnr	(t) 70C0 00 Remove ghosts
Combat School	(t) 042C 0A Slow timer	Dragon Breed	3A1F 00	Front line	F41B A7 Inf troops
Commando	(t) 14C0 FF 255 lives	Dragon Breed	3A20 00	Fruit M/c Sim	(t) 733F 00 Inf credits
Commando	(t) 072A FF 255 bombs	Dragoninja	(t) 13C0 00 Inf time	Fruity Frank	(t) 5A98 00 Inf lives
Conquest	(-) 77D7 A7 Inf energy	Dragoninja	(t) 1D54 00 Inf time	Future Knight	06A2 80 128 lives
Continental Circus	(t) 0FEC 00 RANK Only gets better	Dragons Lair	(t) 2587 A7 Inf lives	Future Knight	(t) 0799 A7 Inf lives
Continental Circus	(t) 0B86 00 More time	Dragons Lair 2	(t) 7D3D 00 Inf lives	Future Bike Sim	(t) 0E7F A7 Inf lives
Continental Circus	(d) 2772 00 Inf continues	Driller	(t) 6F7B A7 Inf fuel	Game Over 2	(d) 8FEA 00 Inf lives pt 1
Cop Out	195B 00 Inf lives	Driller	(t) 6E0A A7 and shields	Game Over 2	(d) 9BC3 00 Inf lives pt 2
Count Duckula	(t) 0F6E C9 No mummies	Driller	(t) 6580 18	Game Over	1F7C 00 Inf lives
Count Duckula	(t) 101B C9 No rocks	Driller	(t) 6581 1B	Garfield	(t) 1EAC 00 Don't fall asleep
Count Duckula	(t) 10C7 C9 No crow bros	Driller	(t) 6E20 00	Gemini Wing	(t) 443B 00 Inf lives
Count Duckula	(t) 11DE C9 No bats	Driller	(t) 6E3E 00 Inf time	Get Dexter	(t) 7ED1 00 Inf energie
Crack Up	1233 A7 Inf lives	Driller	(t) 7A19 00	Ghostbusters 2	(t) 6721 00 Inf lives pt 1
Crazy Cars	(t) 5195 3C Stops timer	Driller	(t) 4566 00 Inf energy	Ghostbusters 2	(t) 6A01 00 Inf proton beams
Critical Mass	(t) 308E 00	Dun Darach	(t) 792A 18 Opens doors	Ghostbusters 2	(t) 6A83 00 Inf pkr bombs
Critical Mass	(t) 308F 00 Inf Crafts	Dynamite Dux	(t) 8B07 A7 Inf lives	Ghostbusters 2	(t) 6AD9 00 Inf pkr shields
Critical Mass	(t) 3090 00	Dynamite Dux	(t) 8D29 00 Inf ammo	Ghostbusters 2	(t) 6D63 00 Inf fireballs pt 2
Crossfire	(t) 0D1F 00 Inf lives	Dynamite Dux	(d) 8B84 A7 Inf credits	Ghostbusters 2	(t) 70FC 00
Crossfire	(t) 0BE2 xx No of lives	Dynamite Dan	(t) 2DBE 07 7 Dynamite	Ghostbusters 2	(t) 7195 00 Inf slime
Curse of Sherwood	(t) 66AC 00 Inf lives	Dynasty Wars	(d) 2B3B C9 Inf energy	Ghosthunter	(t) 61CA No start room
Curse of Sherwood	(t) 756F 00 Permanent map	Dynasty Wars	(t) 2974 C3 Manual rapid fire	Ghosthunter	(t) 61CF C9 Inf energy
Cybernoid	(t) 0227 FF 255 lives			Ghouls 'n' Ghosts	(d) 3182 A7 Inf lives
Cybernoid	16AF FF Inf lives				

GI Hero	4D8B 00	Inf magazine	Jack the Nipper 2	(t) 705C 00	Inf lives	Lost Caves	(t) 1038 no	Level number
GI Hero	48E8 00	Inf ammo	Jack the Nipper 2	5D23 00	Inf coconuts	Mag Max	(t) 1AC1 C9	Invulnerability
Gilbert Escape Drill	(t) 0797 18	Inf time	Jackal	(t) 610B A7	Inf lives	Magician Dizzy	(t) F7B3 C9	Super jump
Gilbert Escape Drill	(t) 0798 29		Jackal	(t) 5A65	No No lives	Magician Dizzy	(t) FE9B 00	Walk on water
Gilbert Escape Drill	(t) 10A6 A7	Inf snot	Jaws	(t) 3957 00	Inf time	Magician Dizzy	(t) 0093 00	Fish and traps
Glider Rider	(t) 112B 00	Stops timer	Jaws	(t) 4A45 05	5 lives part 2	Magician Dizzy	(t) 0135 C9	Inf snorkle
Glider Rider	(t) 12DF 00	Inf bombs	Jaws	(t) 3FC0 00	Inf mega bullets.	Marauder	(t) 030E FF	Lives
Glider Rider	(t) 1309 00	Invulnerability	Jaws	(t) 4E4A 00		Marauder	(t) 0309 FF	Smart bombs
Goonies	(t) 465F FF	255 lives	Jaws	(t) 4E74 00		Marsport	7456 18	Unlocks doors
Ground Zero	5AF8 00	Stops timer	Jet Set Willy	(t) 57B7 00	Inf lives	Mask	(t) 8B16 3A	Inf damage
Gryzor	(d) 1526 A7	Inf lives	Jet Set Willy 2	(t) 81F0	No No of lives	Max Headroom	(-) 12A5 00	Inf energy
Gryzor	(t) 1526 A7	Inf lives	Joe Blade	3 2EE9 00	Inf time (sub game)	Max Headroom	(-) 12B7 00	
Gryzor	(t) 10DD 00	Invulnerability	Joe Blade 3	2EB6 00	Inf time (main)	Max Headroom	(-) 12D0 00	
Guardian Angel	(t) 916A	No Lives	Joe Blade 3	2079 A7	No baddies	Mazie	(t) 8800 00	Inf lives
Gun Smoke	(t) 23AC 3C	Inf lives	Joe Blade	105D 00	Inf lives	Mega Apocalypse	(t) 01FF 00	Inf lives
Gun boat	(t) 7CB0 C9	Invulnerability	Joe Blade	1490 00	Inf uniform	Meganova	67C8 00	Inf lives
Gunfighter	(t) 33EC A7	Inf lives	Joe Blade	1284 00	Inf keys	Metal Army	(t) 7362 00	Inf lives
Gunfighter	(t) 3388 A6	Inf bullets	Jungle Warfare	(t) 3867 00	Inf lives	Metal Army	(t) A3A4 00	Inf lives
Gunflight	0EE6 00	Inf lives	Jungle Warfare	(t) 801A 00	Inf bullets	Metal Army	(t) 878E 00	Inf ammo
Gyroscope	(t) 5308 C9	Invulnerability	Kane	(t) 1386 00	No obstacles	Metrocross	(d) 6433 09	Timer
HATE	(d) 54D2 00	Inf lives	Karnov	(t) 40DB 00	Inf lives	Metrocross	(d) 6434 09	starts at
Hard Drivin'	(t) 08BF 00	Inf time	Killer Ring	(t) 1208 C9	Invulnerability	Metrocross	(d) 6435 09	9.99
Head Over Heels	(t) 23C3 00	Inf lives	King Tut's Pyramid	7471 00	Inf water	Metropolis	(t) 2C69 00	Inf lives
Head Over Heels	(t) 2632 18	Inf doughnuts	King Tut's Pyramid	7462 A7	Inf water	Miami Cobra GT	(t) C7C8 00	Inf time
Head Over Heels	(t) 29D9 00	Inf running	King Tut's Pyramid	7105 A7	Inf lives	Miami Vice	(t) 0352 A7	Inf energy
Head Over Heels	(t) 4750 00	Inf shield (head)	Klax	(t) 0BEB 00	Inf credits	Miami Cobra Rally	C7C8 00	Inf time
Head Over Heels	(t) 474A 00	Inf shield (heel)	Klax	(t) 0AFC 00	Inf drops	Microball	(t) A54E 00	Inf balls
Head Over Heels	(t) 247B 07	Equipment	Knight Force	(d) 48AC 00	Inf energy	Midnight Resistance	1557 00	If die, extra level
Heartland	4725 00	Inf energy	Knight Force	(d) 4F12 00		Mig 29	08C8 00	Inf lives
Herbert's Dummy run	(t) 0204 00	Inf energy	Knight Force	(d) 5B25 00	Inf time	Mikie	621C C3	Invulnerability
Herbert's Dummy Run	1D08 00	Inf lives	Knight Force	(d) 546D C9	No decapitation	Mission Genocide	(t) A0C7 C9	Invulnerability
Highway Encounter	(t) 0077 03	Freeze aliens	Knightmare	3967 C9	Inf Candle	Mission Jupiter	(t) 6154 00	Inf fire power
Hirise	(t) 297D 00	Inf lives	Krakov	(t) 7B3A 00	Inf lives	Molecule Man	(t) 9EBD 00	Inf time
Hirise	(t) 2A7D 00	Inf glue patches	Kwik Snax	(t) 19C9 00	Inf lives	Monty Python	(d) 8B91 FF	Lots of lives
Hobgoblin	(t) 1234 00	Inf lives	LED Storm	5ADB 00	Inf energy	Monty Python	(d) A388 00	Inf lives
Hoppin' Mad	(t) 04FF 00	Inf lives	Laser Squad	(d) 4652 00	Inf money	Monty on the Run	(t) 9C8C 00	Inf lives
Hotrod	(d) 4B2B 00	Inf fuel	Last Duel	(d) 147F 00	Inf lives	Moon Buggy	(t) 8438	No Zone number
Hotrod	(d) 4B2C 00		Last Duel	(d) 2BED 00		Motorcross Sim	(t) 05C7 00	Bikes
Hotrod	(d) 4B2D 00		Last Ninja 2	(t) 5289 8D	128 lives	Motorcross Sim	(t) 0D2B 00	
Hotrod	(d) 4B36 00		Led Storm	(t) 5ADB 00	Inf energy	Moving Target	(t) 64CF 00	Inf bullets
How To Be A C B	(t) 13AC 00	Letters stay lit	Licence to Kill	(d) 5ADB 00	Inf energy	Moving Target	(t) 6B36 00	Inf lives
Howard the Duck	(t) 329C 00	Inf time	Licence to Kill	(d) A6E5 A7	Inf	Muggins the Spaceman	11A9 00	Inf shots
Hydrofool	(t) 7575 C3	Stops rust	Licence to Kill	(d) A4F4 00	every thing	Mutant Fortress	(t) 0798 A7	Inf lives
I Ball	(t) 11B3 FF	255 lives	Licence to Kill	(d) A7EE 00	on all	Mystery on the Nile	(t) 0408 00	Inf lives
I Ball 2	21B2 00	Stops timer	Licence to Kill	(d) ABFO 00	levels	Mystical	1E3F 00	Inf lives
I Ball 2	251D 00	No baddies	Licence to Kill	(d) 9D7E 00		Myth	(d) 886D 00	Inf credits
Ikari Warriors	(t) 5960 B7	Inf bullets	Licence to Kill	(d) 9A02 00	Input all	Myth	(d) 1401 A7	Lives level 1
Ikari Warriors	(t) 5908 B7	Inf grenades	Licence to Kill	(d) 9F44 00	of the	Myth	(d) 13A4 A7	Lives level 2
Ikari Warriors	(t) 5878 18	Invulnerability	Licence to Kill	(d) A47D 00	pokes	Myth	(d) 140C A7	Lives level 3
Impact	(t) 6F95 C3	Inf lives	Licence to Kill	(t) CEFF	No No of lives	Myth	(d) 1414 A7	Lives level 4
Impossible Mission	(t) 261C 00	Inf energy	Licence to Kill	(t) 81AB	No No of lives	Navy Moves	(t) 7D01 FF	255 lives
Impossible Mission	(t) 0ED7 C9	Robots harmless	Light Corridor	3ACE	No No of balls	Navy Moves	(t) 048C BE	Inf lives
Impossible Mission	2632 21	Inf lift	Light Force	(t) 79DA 00	Inf lives	Nemesis	(d) 98A0 05	
Impossible Mission	2659 21	Inf snooze	Live + Let Die	(t) 5B67 00	Invulnerability	Nemesis	(d) 9B9F 18	Invulnerability
Impossible Mission	265B 00	Passwords	Live + Let Die	(t) 7402 01	Inf fuel	Nemesis	(d) 9D74 00	Inf lives
Indy Jones Crusade	(t) 2249 A7	Inf whips	Live + Let Die	(t) 7495 00	Inf missiles	Nemesis	(t) 9682 D4	Shield
Indy Jones Crusade	(t) 31A7 A7	Inf lives	Live + Let Die	(d) 7402 01	Inf fuel	Nemesis	(t) 96AA 20	+laser + double
Indy Jones Crusade	(t) 31B8 00	Inf lives	Live + Let Die	(d) 5b67 00	Invulnerability	Nemesis	(t) 9D74 00	+Inf lives
Indy Jones Crusade	(t) 224B 00	Inf whips	Live + Let Die	(t) 7417 A7	Inf fuel	Nemesis	(t) 27BF 00	Inf lives
Insector Hecti	(t) 4E74 00	Inf time	Living daylight	(t) 2CED 00	Inf energy	Netherworld	(d) 04CF 00	Inf lives
Insector Hecti	(t) 4F2F 00	Inf lives	Loopz	(d) 2A6F A6	Inf lives	Nightbreed	(t) 04CF 00	Inf lives
Insector Hecti	(t) 4F22 50	50 shots per level	Lopears	(t) 2BA6 00	64k Inf energy	Nightshade	(t) 7ED3 00	Inf lives
Insector Hecti	(t) 7F0B 50		Lopears	(t) 2D4E 00	64k Inf time	Ninja Commando	(t) 83D1 00	Inf lives
Inside Outing	(t) 0F97 C3	Inf energy	Lopears	(t) 2BA4 00	6128k Inf energy	Ninja Spirit	(d) 522D 00	Inf credits
Inside Outing	(t) 4F91 00	Stops nasties	Lopears	(t) 2D4C 00	6128k Inf time	Nodes of Yesod	(t) 4EA7 00	Inf lives
Ironman	(t) 8913 00	Inf continues	Lord of the Rings	(t) 417F 8F	Inf health	North & South	(d) 0443 00	Time
Italian Supercar	(t) 17C8 00	Inf takes	Lord of the Rings	(t) 41CC B3	Inf keys + arrows	North & South	(d) 13B2	No bags
Italian Supercar	(t) 4f91 00	Inf time	Lords of Chaos	(t) 96DE 00	Inf experience	North & South	(d) 28A7 00	Inf lives
Italian Supercar	(t) 0049	No start scene	Lords of Chaos	(t) 96DF 00		Ollie and Lissa 3	(t) 5030 C9	Inf wax for candle
			Lords of Chaos	(t) 96EA 00		Ollie and Lissa 3	(t) 636D C9	Removes ghosts
			Lords of Chaos	(t) 96EB 00				

On the Run	A48D 00	Energy	Prohibition	(t) 198E 00	No shooting back	Rolling Thunder	(t) 4740 00	Inf energy
On the Run	B2F2 00	Inf lives	Project Future	(t) 9564 FF	255 lives	Ruff & Ready	(t) 53D1 00	Inf time
Op Thunderbolt	(d) 18FF 00	Inf bullets	Project Future	(t) 9B9D FF		Rygar	(t) 2C38 A7	Inf lives 3
Op Thunderbolt	(d) 5362 00	Inf credits	Psycho Pigs UXB	2418 7F	128 lives	SAS Combat Simulator	(t) 49AA 00	255 grenades
Op Thunderbolt	(d) DFE9 00	Inf time	Psycho Hopper	(t) 0303 00	Inf lives	SAS Combat Simulator	(t) 3286 FF	255 lives
Op Wolf (It gun)	(t) 2C75 C9	Inf energy	Psycho Hopper	(t) 2146 04	Extra time	SAS Combat Simulator	(t) 328B FF	
Op Wolf (It gun)	(t) 2CFD 00	Inf magazines	Pulsator	(t) 5395 00	Inf lives	SDI	(t) 3A49 00	Inf lives
Op Wolf (It gun)	(t) 2584 A7	Inf grenades	Pulsator	(t) 5396 00		SDI	(t) 3A7C 00	Inf lives
Op Wolf (It gun)	(t) 256F 00	Inf bullets	Puzznic	(d) 38C0 FF	Lots of retries	Saboteur	B796 00	Inf time
Op Wolf (It gun)	(t) 25D6 00	Inf credits	Puzznic	(d) 599C 00	Stops clock	Saboteur	B78E 00	
Op Wolf (It gun)	(d) 2CBD C9	Inf energy	Q10 Tankbuster	(t) 599D 00		Saboteur 2	(t) 33F4 00	Timer
Op Wolf (It gun)	(d) 2D63 00	Inf magazines	Quest for Mindstone	(t) C512 00	Inf lives	Saboteur 2	(t) 3AC6 00	Longer jumps
Op Wolf (It gun)	(d) 25EA A7	Inf grenades	Quest for Mindstone	(t) 58BF FF	255 gold	Saboteur 2	(t) 3C85 00	No enemies
Op Wolf (It gun)	(d) 25D5 00	Inf bullets	Quest for Mindstone	(t) 5C91 FF	Kyle strength 255	Saboteur 2	(t) 960E 00	Inf energy
Op Wolf (It gun)	(d) 263C 00	Inf credits	Quest for Mindstone	(t) 5C92 FF	Merle strength 255	Sabre Wolf	(t) A570 A7	Inf lives
Operation Gunship	858E 00		Quest for Mindstone	(t) 5C93 FF	Quin strength 255	Saigon Combat Unit	(t) A398 00	Inf lives side A
Operation Gunship	8591 00	Inf armour	Quest for Mindstone	(t) 5C94 FF	Taina strength 255	Saigon Combat Unit	(t) A3FE 00	Inf ammo side A
Operation Gunship	8D53 00	Inf bullets	Quest for Mindstone	(t) 5C94 FF	Taina strength 255	Saigon Combat Unit	(t) A412 00	Inf bombs side A
Operation Gunship	855B 00	Inf fuel	Quest for Mindstone	(t) 5C9B FF	Kyle psyche 255	Saigon Combat Unit	(t) A4C7 00	Inf lives side B
Operation Gunship	8E9B 00	Inf bombs	Quest for Mindstone	(t) 5C9C FF	Merle psyche 255	Saigon Combat Unit	(t) A52D 00	Inf ammo side B
Operation Thunderbolt	CF62 00	Inf life	Quest for Mindstone	(t) 5C9D FF	Quin psyche 255	Saigon Combat Unit	(t) A541 00	Inf bombs side B
Operation Hanoi	(t) 8AB3 A7	Inf ammo	Quest for Mindstone	(t) 5C9E FF	Taina psyche 255	Salamander	3237 FF	Inf lives
Operation Hanoi	(t) 8ACF A7	Inf grenades	R-Type	927B A7	Inf credits	Salamander	40FC C9	Invulnerability
Operation Hanoi	(t) 8F0E A7	Inf lives	R-Type	(t) 91E7 C9	Invulnerability	Salamander	4855 C9	Watch the level
Operation Hormuz	(t) 1869 00	Inf Harriers	R-Type	(t) 91EF 00	Inf lives	Smash TV	(d) 1D5C 00	Inf lives
Operation Hormuz	(t) 540E 00		Race Against Time	(t) 900C AF	Stops clock	Satan	7C4C C9	Inf time
Old Run	2253 00	Inf time	Race Against Time	(t) 8E7C 39	9 minutes	Satan	(t) 6DEB 00	Inf lives
Outrun Europa	(d) EE81 00	Inf time	Rainbow Island	20BF 00	Inf restarts	Savage Part 1	(t) 033C FF	255 lives
Outrun Europa	(d) FF24 FF	255 credits	Rainbow Islands	(t) 1C1E 00	Inf lives	Savage Part 2	(t) 2611 00	256 lives
Overlander	(d) 1815 00	Inf lives	Rainbow Islands	(t) 42AC 01	Kill guardian 1 hit	Savage part 3	(t) 0C3B 00	256 lives
Overlander	(t) 1815 00	Inf lives	Rambo	(t) 8E9C 00	Inf lives	Scooby Doo	(t) 7C95 9F	No ghosts
P47 Thunderbolt	(t) 27DC 00	Inf lives	Rambo 3	(t) 1BA6 00	Inf continues	Scooby Doo	(t) 7A26 00	Inf lives
Pacland	(d) 2C78 FD	253 lives	Ramparts	(t) 6983 A7	Inf energy (p1)	Score 3020	68E9 00	Inf lives
Paladin	97C2 00	Inf lives	Ramparts	(t) 68E1 A7	Inf energy (p2)	Seymour to Hollywood	61C8 00	Inf lives
Paladin	9750 00	Inf time	Ranarama	(t) 798C 00	Slows energy	Shackled (Go crazy)	(d) D732 09	Pulse 99999
Palitron	(t) 2427 00	Inf lives	Raspurin	(t) DF94 A7	Inf health	Shackled (Go crazy)	(d) D733 99	Player 1
Paperboy	(t) 05AC 00	Inf lives	Rastan	(t) 2353 00	Inf lives	Shackled (Go crazy)	(d) D734 99	
Parabola	(t) 8514 00	Inf lives	Realm	(t) 7C80 00	Inf lives	Shackled (Go crazy)	(d) D771 09	Pulse 99999
Paws	293F 00	Inf statina	Red Heat	(t) 9F01 00	Inf energy	Shackled (Go crazy)	(d) D772 99	Player 2
Periscope up	(t) 1DD8 00	Inf lives	Red Heat	(t) 95DB 00	Inf bullets	Shackled (Go crazy)	(d) D773 99	
Periscope up	(t) 1F5C 00	Inf scouts	Red Heat	(t) 867E A7	Inf lives	Shadow Skinner	(t) 049F 30	Extra lives
Periscope up	(t) 1156 00	Inf fuel	Red Heat	(t) 9F13 00	Inf energy	Shadow of the Beast	(t) 2920 00	Inf energy
Periscope up	(t) 1181 00	Inf air	Red Heat	(t) 95EC A7	Inf bullets	Shadow Dancer	(d) 2106 A7	Inf time
Peter Pack Rat	8702 3A	Inf time	Red Heat	(t) 867E A7	Inf lives	Shadow Dancer	(d) 06A2 A7	Inf credit
Peter Pack Rat	8EDF 00	Stops flies	Reflex	(t) 77B2 00	Inf power	Shadow Dancer	(d) 07C0 A7	Inf magic
Pick 'n' Pile	039F FF	255 lives	Renegade	(t) 0FBF FF	Stay on platform	Shadow of the Beast	(d) 2920 A7	Inf energy
Pipemania	(t) 263B 00	Stops timer	Renegade	(d) 0FEL FF	Stay on platform	Shanghai Warriors	(t) 3331 00	Inf lives
Plasmatron	(t) 0352 FF	Inf damage	Renegade 3	(t) 4DDF C9	Inf lives	Shaolins Road	(t) 1B10 A7	Inf lives
Popeye 2	(t) 1767 00	Inf bonus	Return of Jedi	(t) 0680 A6	No obstacles	Shinobi	(t) 15B7 65	100 lives
Pewerdraft	(d) 2A82 FF	255 lives	Return of Jedi	(t) 0677 A6		Shinobi	(t) 1407 00	Inf time
Powerdrift	(t) 2AA1 FF	255 lives	Revolution	(t) 071A 00	Inf lives	Shinobi	(t) 0F62 00	Inf lives
Predator	(d) 97F1 FE	254 lives	Revolution	(t) 071E 00		Shinobi	(t) 3758 00	Inf time
Predator	(d) C7C6 39	Timer	Rex	(t) 3F11 00	Inf lives	Shockway Rider	(t) 9181 no	No of lives
Predator	(d) C7C7 39	99 mins	Rick Dangerous	88C3 A7	Inf lives	Sidarmis	0686 FF	Lots of lives
Predator	(d) C7C9 39	Timer	Rick Dangerous	9F35 A7	Inf fire	Silkworm	(t) 4D69 00	Inf lives
Predator	(d) C7CA 39	99 secs	Rick Dangerous	9F90 A7	Inf dynamite	Sim City	(-) 389B FF	Cash
Predator	(d) 97F3 FE	Lots of ammo	Rick Dangerous 2	9F99 C3	Invulnerability	Sim City	(-) 3C74 FF	
Predator	(d) FFF3 FF	Lots of grenades	Rick Dangerous 2	(t) 8623 A7	Inf lives	Skate Crazy	(d) 8D3F 00	No checkpoints
Prince of Persia	(t) 935A 00		Rick Dangerous 2	(t) 9192 A7	Inf laser	Skatin' USA	(t) 4976 00	Inf energy
Prince of Persia	(t) 235A 00	Inf lives	Rick Dangerous 2	(t) 9734 A7	Inf bombs	Skatin' USA	(t) 48D3 00	Inf shots
Prison Riot	(t) A11B 00	Inf time main	Ricochet	(t) 6331 00	Inf lives	Skatin' USA	(t) 177F 99	99 energy points
Prison Riot	(t) A13C 00	Inf time sub	Road Runner	(d) 023F 00	Inf lives	Skatin' USA	(t) 1784 99	99 shots
Pro Boxing Sim	(t) 1521 No	Lives player 1	Roadblasters	(t) 24B4 01	Inf fuel	Skweek	(t) 9974 FF	Lives player 1
Pro Boxing Sim	(t) 1522 No	Lives player 2	Roadblasters	(t) 35B7 10	Extra extras	Skweek	(t) 9982 FF	Lives player 2
Pro Powerboat Sim	(t) 883C No	Lives 1	Roadrunner	(t) 023F 00	Inf time	Skweek	(t) 72A0 C9	Invulnerability
Pro Powerboat Sim	(t) 8841 No	Mines 1	Robocop	(t) 3F23 00	Inf energy	Slap Fight	(t) 4F32 FF	255 lives
Pro Powerboat Sim	(t) 882C No	Lives 2	Rocky Horror Show	(t) 2413 FF	255 time	Slightly Magic	(t) 40F1 00	Inf lives
Pro Powerboat Sim	(t) 8831 No	Mines 1	Rocky Horror Show	(t) 2414 FF		Slug	073B 00	Inf lives
Prohibition	(t) 09EC FF	255 lives	Rogue	(t) 838A 64	100 strength	Slug	09A6 00	Inf time
Prohibition	(t) 0FB1 B7	Inf hide time	Rogue Trooper	(t) 3554 00	Inf medi-kits	Smash TV	(d) 1D5C 00	Inf lives
Prohibition	(t) 0B69 B7	Inf lives	Rolling Thunder	(t) 4720 00	Inf lives	Snowball in Hell	(t) 101A 00	Inf lives

Soldiers of Light	(t) 57FA 00 Lives 1	TLL	(t) A99B 00) do both	Twin Turbo V8	(t) A550 00 Inf time
Soldiers of Light	(t) 5A49 00 Lives 2	Target Renegade	(t) 0F28 A7 Inf lives	Twin Turbo V8	(t) 1BEE 99 lives
Sonic Boom	(d) 8CC6 00Inf credits	Tau Ceti	(t) 10B0 00 Inf lives	Twin Worlds	345E A7 Inf energy
Soul of a Robot	(t) 2304 FF 255 lives	Technician Ted	(t) 4DA3 00 Inf lives	Twin Worlds	3658 00 Higher jump
Soviet Fighter	OCF1 00 Inf fuel	Techno Cop	(t) 60B6 01)Inf nuke	Typhoon	(t) B084 00 Inf lives
Space Harrier 2	(t) 1003 00 Lives	Techno Cop	(t) 8F10 A7)	Ultima Ratio	(t) 31D9 00 Inf lives
Space Harrier 2	(t) 0793 00 Inf lives	Techno Cop	(t) 77B3 C9 Inf damage	UN Squadron	1CDB 00 Inf lives
Space Harrier 2	(d) 0476 00Inf lives	Techno Cop	(t) 909F 00 Inf lives	UN Squadron	(d) 1C1B 00Inf credits
Space Rider	(t) 5FC4 00 Inf lives	Teenage Turtles	(t) 5D5D C9)Put all pokes	UN Squadron	(d) FE07 A6 Music off
Space Trader	(t) 74CD FF 255 shields	Teenage Turtles	(t) EF88 00)in to get	Untouchables	0FD2 A7 Inf time
Space Trader	(t) 74CC FF 255 lasers	Teenage Turtles	(t) 6275 00)Inf lives	Uridium	(t) 1FC2 00 Inf lives
Space Trader	(t) 74CE FF 255 exterior	Teenage Turtles	(t) OCC6 75)and protection	Uridium	(t) 0962 00)No homing
Space Trader	(t) 74CF FF 255 interior	Teenage Turtles	(t) OCC8 18)from falling	Uridium	(t) 0963 00)missiles
Space Trader	(t) 74D0 FF 255 computer	Teenage Turtles	(t) OCC9 0C)buildings	Uridium	(t) 0964 00)all 3 pokes
Space Trader	(t) 4DFA No cash	Tennis Cup	(-) 8968 3A Inf credits	Vampire	(t) 2D5B 34 Inf lives
Space Trader	(-) 659A 00)No time limit	Terra Cognita	(t) 19AE 00 Inf lives	Victory Road	(t) 3B5E FF 255 lives (p1)
Space Trader	(-) 659B 00)or landing tax	The Apprentice	(t) 919E 00 Inf lives	Victory Road	(t) 3B6F FF 255 lives (p2)
Spaced Out	5886 00 Inf time	The Apprentice	(t) 8978 00 Inf lightning	Vigilante	5816 A7 Inf life
Speedking	(t) 152A C9 Stops clock	The Hit Squad	46F9 00 Inf lives	Vigilante	(d) 8C2B A7Inf lives
Speedzone	(t) 2832 A7 Inf lives	The Munsters	(t) 1EE7 A7 Inf energy	Vindicators	(t) 07D3 F0 240 lives player 1
Spellbound Dizzy	(t) BC52 00 Inf lives	The Prize	(d) 350D 00Inf lives	Vindicators	(t) 07B8 F0 240 lives-player 2
Spike in Transylvania	(t) 1691 00 Inf lives	The Prize	(d) 3C00 FF 255 bullets	Vindicators	(t) 1667 C9 Inf fuel
Spikey Harold	(t) 9C33 A7 Inf lives	The Plot	1C62 00 Inf fuse	Vindicators	(t) 158F 00 Inf stars
Spindizzy	(t) A85E C9 Inf time	The Spy Who Loved Me	(d) 113C 00464 cheat	Vindicator Level 1	0584 A7 Inf oxygen
Spindrome	(t) 7C4A 00)Inf lives	The Spy Who Loved Me	(d) 123C 006128 cheat	Vindicator Level 1	0BD9 A7 Inf lives
Spindrome	(t) 7667 00)	Thing Bounces Back	(t) 9335 C9 Inf lives	Vindicator Level 2	1D21 A7 Inf lives
Spitfire	(t) 1B2A 00 Inf spits	Thrust	(t) 4347 C3 Inf lives	Vindicator Level 3	12F9 A7 Inf lives
Spitting Image	36F3 C1 Always win	Thrust 2	(t) 268B 00 Inf lives	Vindicator Level 3	060E 00 Inf time (part 1)
Split Personalities	(t) 2F23 A7 Inf lives	Thunderbirds	(t) 5E48 A7 Level 1 time	Vindicator Level 3	0615 00 Inf time (part 2)
Split Personalities	(t) 0FF6 C9 Stops fuse	Thunderbirds	(t) 5FFC A7 Level 2 time	Vixen	3514 A7 Inf lives
Spooky Castle	(t) 090A 00 Inf lives	Thunderbirds	(t) 57C6 A7 Level 3 time	Wanderer 3D	(t) 154E C9 Inf energy
Star Wars	(t) 4515 00 Inf Shields	Thunderbirds	(t) 5746 A7 Level 4 time	Wanderer 3D	(t) 1578 00 Inf shields
Stardust	03E4 00 Inf lives	Thundercats	(t) 787A No No of lives	Wanderer 3D	(t) 4706 05)Shortens route
Steel Eagle	(t) 1B98 A7 Inf lives	Thunderjaws (demo)	47CC A7 Inf credit	Wanderer 3D	(t) 4718 05)through
Stormbringer	(t) 16C7 No Starting position	Tiger Road	(d) 56F1 00Inf lives	Wanderer 3D	(t) 4724 05)black holes
Stormlord	(t) 6B7D C9 Invulnerability	Time Scanner	(-) 1211 00 Inf balls	Warlock	(t) 264F 00 Inf lives
Street Fighter	(t) 839F 00 Inf credits	Time Machine	733D 00 Inf lives	WEC Le Mans	1345 00 Inf time
Street Fighter	(t) 9197 00 Inf energy	Tir Na Nog	9ACE 00 Invulnerable	West Bank	(t) 8A58 FF)Inf lives
Street Fighter	(t) 944C 00 Time limit 9999	Tir Na Nog	A083 18 Unlocks doors	West Bank	(t) 8CF4 A7)
Strider	(t) 28DE A7 Inf energy	Titan	(t) 1075 No 01-10 for level	West Bank	(t) 92DD A7)
Strider	2BE9 00 Inf lives	Titan	(t) 1225 FF 255 lives	Wizard Witty	1C1C 00 Inf lives
Strider	2AC2 00 Inf time	Titanic	4162 A7 Inf oxygen	Wizball	(t) A92B C3)Inf lives
Strider 2	12E6 A7 Inf time	Titanic	41F9 00 Inf lives	Wizball	(t) A93A A7)
Strider 2	017E 00 Inf lives	Titanic	3008 00 Inf bullets	Wonder Boy	52E2 00 Inf lives
Strike Force Cobra	6943 A7 Stops timer	Titus the Fox	(d) 1F7A FF)255 lives	Wonder Boy	(t) 52E5 00 Inf lives
Stunt Car Racer	(d) 2177 00)Inf boost	Titus the Fox	(d) 2147 FF)	Wrestlemania	(d) 2A64 00)Inf credits
Stunt Car Racer	(d) 98C3 C9)Invulnerability	Titus the Fox	(d) 2011 FF 255 energy	Wriggler	(t) 8018 00-256 lives
Subterranean Stryker	(t) 7D36 A7 Inf lives	Tombstowne	(t) 90C3 00 More energy	Xcel	(t) 33A4 00 Inf lives
Super Robin Hood	(t) 6C97 C9 Invulnerability	Tomcat	(t) 93F6 A7 Inf lives	Xenon	(t) 0827 C9 Inf lives
Super Robin Hood	(t) 6122 00 Faster Robin	Toobin'	(t) 9CE5 00 Inf credits	Xenon	(t) 080B C9 Inf energy
Super Hero	(t) 3763 00)Inf lives	Toobin'	(d) 9CE5 A7)Inf credits	Xevious	03F0 FF 255 lives
Super Hero	(t) 376A 00)	Top Cat	7C09 30 Stops clock	Xybots	(t) A8F3 C9 Inf credits
Super Scramble	(d) A8B1 00)Stops clock	Trantor	(t) 2A7F 00 Inf time	Xybots	(t) 70F3 00 Inf credits
Super Tank Sim	(t) 992B 00 Inf lives	Trantor	(t) 0C72 FF Inf health	Yabba Dabba Doo	(t) 0AE0 A7 Inf lives
Super Tank Sim	(t) 37F6 00 Improves firepower	Trantor	(t) 1888 00 Inf fuel	Yie Ar Kung Fu	883E 00 Inf energy
SuperTrux	(t) 1991 00)Stops clock	Trantor	(t) 1614 00)Invulnerability	Yogi's Great Escape	(t) 07CC A7 Inf lives
SuperTrux	(t) 9961 00)	Trantor	(t) 17D7 00)	ZTB	(t) A282 C9 No badstars
SuperTrux	(t) 9A25 00)	Trantor	(t) 1871 00)	ZTB	(t) A0C7 C9 Invulnerability
SuperTrux	(t) 94F5 00 Less crashes	Treasure Island Dizzy	(t) 012E 18)Immunity from	Zarkon	(t) 2B1F C9 No enemy craft
Supersam	(-) 9BE2 00 Inf lives	Treasure Island Dizzy	(t) 8B0A 18)just about	Zarkon	(t) 8B69 18 Inf lives
Switchblade	(t) 30AC 00 Inf Lives	Treasure Island Dizzy	(t) 8A92 18)everything	Zolyx	(t) 4390 00 Inf lives
Switchblade	(t) 252B 00 Inf Weapons	Troll	5461 00 Inf lives	Zorro	(t) 57BC FF 255 lives
Sword Slayer	(t) 14A8 3C) Invulnerability	Turbo Esprit	6FF7 7E Lots of lives	Zub	(t) 4319 00 Droids harmless
Sword Slayer	(t) 14B6 3C)	Turbo Outrun	1487 FF 255 credits	Zynaps	(t) 6139 C9 Rapid fire
T Bird	(t) 1433 A7 Inf smart bombs	Turbo Outrun	(t) 15ED 00 Inf credits	Zynaps	(t) 5F7E FF 255 lives
T Bird	(t) 15AB A7 Inf lives	Turbo Tortoise	(t) 60DB 00 Inf bullets	Zynaps	(t) 4A3F 00 No enemy craft
TLL	(t) 917A 00 Inf lives	Turrican 2 (demo)	9B47 A7 Inf lives		
TLL	(t) A6A2 A7 Inf fuel	Turrican 2 (demo)	3E65 3E) Inf smart bombs		
TLL	(t) 909B 00)Inf time	Turrican 2 (demo)	3E66 FF)		
TLL	(t) 909C 18) do both	Turrican	(t) 04F0 00 Inf vitality		
TLL	(t) A8C8 00)Inf bombs	Turrican	(t) 8F63 C3 Inf lives		
		Twin Turbo V8	(t) 818B 00 No corners		

SAVE £50!
OFF PREVIOUS SILICA PRICE OF £299

FREE!

ZOOL SOFTWARE PACK



ZOOL STRIKER
TRANSWRITE
PLUS! PINGBALL DREAMS
GFA BASIC AND PHOTON PAINT 2.0

TOTAL VALUE: **£267.87**

WITH THE AMIGA 500

Commodore

CARTOON CLASSICS



A500 'PLUS' MODEL



INCLUDES BUILT-IN 18-KEY NUMERIC KEYPAD

AMIGA 500

CARTOON CLASSICS

- PACK INCLUDES:**
- 1Mb AMIGA 500 PLUS..... £399.99
 - BUILT-IN 1Mb DRIVE..... FREE
 - A520 TV MODULATOR..... FREE
 - THE SIMPSONS..... £24.99
 - CAPTAIN PLANET & THE PLANETEERS..... £25.99
 - LEMMINGS..... £25.99
 - DELUXE PAINT II..... £79.99
- PLUS! FREE FROM SILICA:**
- ZOOL PACK..... £127.92
 - PHOTON PAINT v2.0..... £89.95
 - GFA BASIC v3.5..... £50.00
- PACK VALUE: £844.82**
PACK SAVING: £575.82
SILICA PRICE: £249.00

SALE!

We are pleased to offer the original 1Mb Amiga 500 Plus (Kickstart/Workbench v2.04), including a built-in 18-key numeric keypad and Cartoon Classics software at a new low sale price of only £249. The Amiga 500 Plus can be upgraded, using any of the hundreds of peripherals that are now available, which include the award winning GVP range. In addition to the 1Mb version of the Cartoon Classics pack at only £249, we are pleased to offer a specially upgraded version with 2Mb RAM for only £279. And, when you buy an Amiga 500 Cartoon Classics Pack from Silica (1Mb or 2Mb version), we will give you a ZOOL PACK plus GFA BASIC and PHOTON PAINT II worth over £267, absolutely FREE!

1Mb A500 PLUS CARTOON CLASSICS

£249

INC VAT - Ref: AMC 0592

2Mb RAM VERSION **£279** INC VAT
AMC 0592 + RAM 0592

RETURN THE COUPON FOR YOUR FREE COPY OF SILICA'S NEW 64 PAGE AMIGA CATALOGUE!

CDTV MULTIMEDIA SYSTEM

- Easy to use home entertainment system
- Infrared Remote Control
- Sleek black design
- Keyboard, disk drive and mouse included
- Based on the best selling Amiga computer
- Plays CD audio discs
- Compatible with CD+G & CD+MIDI formats
- Over 100 CDTV titles available
- Compatible with 100s of Amiga programs
- Fred Fish CDPD is a 'collection' of 660 disks of public domain software. It includes utilities, applications, games and tools.



A complete CDTV environment. With keyboard and disk drive it is fully software compatible with the Amiga 500, and able to run all Amiga games and application software. £50 of CDTV software vouchers PLUS Sim City (worth £29.99) are included FREE with every CDTV Multimedia System from Silica.

CDTV Player	£399.99
CDTV Keyboard	£49.99
CDTV Disk Drive	£99.99
Fred Fish CDPD	£19.99
Sim City	£29.99
Software Vouchers	£50.00
Total Pack Value:	£649.95
Less Pack Saving:	£150.95
Silica Price:	£499.00

FREE! FROM SILICA with the CDTV Multimedia System **SIM CITY ENHANCED CD VERSION** £50 of CDTV SOFTWARE VOUCHERS **£80** WORTH NEARLY

£499

Ref: CCD 1250

AMIGA CDTV SALE!



£100 OFF RRP! £50 OF VOUCHERS! FREE SIM CITY

FREE! FROM SILICA with the A570 **SIM CITY ENHANCED CD VERSION** £50 of CDTV SOFTWARE VOUCHERS **£80** WORTH NEARLY

The A570 is an essential add-on for your Amiga 500. CD-ROM is set to replace disks as the standard format for games and serious titles in the not too distant future. Most software companies have already announced plans to release CD versions of their software! The sheer storage size of a CD (600 disks) means that using CD software is faster, graphics are enhanced and game play is increased with bigger levels, more complex problems to solve and larger areas to explore! And, being compatible with audio CDs, the sound quality from CD games is unrivalled! Sim City for instance has over 10Mb of data for its graphics alone and has music recorded in a studio! Silica's special sale price of £249 means that there is no better time to buy the A570 and, with the award winning Sim City included FREE with every A570 from Silica Systems, there's no better place to buy it from!

CDTV AMIGA A570 ADD-ON FOR AMIGA 500 OWNERS

- Enables your Amiga to run CDTV software
- Plays normal audio CD discs
- Storage capacity equal to 600 floppy disks
- Internal RAM expansion option (coming soon)
- Internal hard drive option (coming soon)
- Compatible with CD + G and CD + MIDI formats
- Transfer time 153Kb/second
- Compatible with CD-ROM industry standard ISO9660
- Comes with Fred Fish CDPD collection + Sim City FREE from Silica

Note: 1Mb of Chip RAM/FAT Agnus is required for full compatibility with all CDTV software. Silica offer an upgrade service. Please call and quote REA 1000.

SAVE £100! OFF NORMAL RRP OF £349

£249

Ref: CCD 0588

ALL PRICES INCLUDE VAT - DELIVERY IS FREE OF CHARGE IN THE UK MAINLAND

SILICA SYSTEMS OFFER YOU

- FREE OVERNIGHT DELIVERY:** On all hardware orders shipped in the UK mainland.
- TECHNICAL SUPPORT HELPLINE:** Team of technical experts at your service.
- PRICE MATCH:** We normally match competitors on a "Same product - Same price" basis.
- ESTABLISHED 14 YEARS:** Proven track record in professional computer sales.
- £12 MILLION TURNOVER (with 60 staff):** Solid, reliable and profitable.
- BUSINESS + EDUCATION + GOVERNMENT:** Volume discounts available 081-308 0888.
- SHOWROOMS:** Demonstration and training facilities at our London & Sidcup branches.
- THE FULL STOCK RANGE:** All of your requirements from one supplier.
- FREE CATALOGUES:** Will be mailed to you with offers + software and peripheral details.
- PAYMENT:** Major credit cards, cash, cheque or monthly terms.

Before you decide when to buy your new Amiga computer, we suggest you think very carefully about WHERE you buy it. Consider what it will be like a few months after buying your Amiga, when you may require additional peripherals or software, or help and advice with your new purchase. And, will the company you buy from contact you with details of new products? At Silica Systems, we ensure that you will have nothing to worry about. We have been established for almost 14 years and, with our unrivalled experience and expertise, we can now claim to meet our customers' requirements with an understanding which is second to none. But don't just take our word for it. Complete and return the coupon now for our latest FREE literature and begin to experience the "Silica Systems Service".

MAIL ORDER: 1-4 The Mews, Hatherley Rd, Sidcup, Kent, DA14 4DX
Order Lines Open: Mon-Sat 9.00am-6.00pm
No Late Night Opening
Tel: 081-309 1111 Fax No: 081-308 0666

LONDON SHOP: 52 Tottenham Court Road, London, W1P 0BA
Opening Hours: Mon-Sat 9.30am-6.00pm
No Late Night Opening
Tel: 071-580 4000 Fax No: 071-583 4737

LONDON SHOP: Selfridges (1st floor), Oxford Street, London, W1A 1AB
Opening Hours: Mon-Fri 9.30am-7.00pm (Sat close 6.30pm)
Late Night: Thursday - 8pm
Tel: 071-629 1234 Extension: 3914

SIDCUP SHOP: 1-4 The Mews, Hatherley Rd, Sidcup, Kent, DA14 4DX
Opening Hours: Mon-Sat 9.00am-5.30pm
Late Night: Friday - 7pm
Tel: 081-302 8811 Fax No: 081-309 0017

ESSEX SHOP: Keddies (2nd floor), High Street, Southend-on-Sea, Essex, SS1 1LA
Opening Hours: Mon-Fri 9.30am-5.30pm (Sat 9.00am-6.00pm)
No Late Night Opening
Tel: 0702 468039 Fax No: 0702 462363

To: Silica Systems, AMACT-0393-100, 1-4 The Mews, Hatherley Rd, Sidcup, Kent, DA14 4DX

PLEASE SEND A 64 PAGE AMIGA COLOUR CATALOGUE

Mr/Mrs/Miss/Ms: Initials: Surname:

Company Name (if applicable):

Address:

Postcode:

Tel (Home): Tel (Work):

Which computer(s), if any, do you own?

MAIL ORDER HOTLINE **081-309 1111**

SILICA SYSTEMS

MJC

COMPUTER SUPPLIES

Suppliers of Discount Software since 1984

HOW TO ORDER:

All prices include VAT & delivery

Please allow 5 days for cheque clearance.

Send cheques or postal orders made payable to:

MJC SUPPLIES (AA)

Unit 2, The Arches, Icknield Way, Letchworth,
Herts, SG6 1UJ

Or telephone with Access or Visa debit
and credit cards on:

0462 - 481166

Overseas Customers: write for quotation
Educational Bodies, Local Authorities, Govt.

Departments: send written order

FAX US ON 0462 670301

**NEW - MICRODESIGN PLUS **

This superb Desktop Publishing program is now available from MJC Supplies. MD+ offers superb page layout features along with probably the best printouts you will see on a CPC. MD+ can import Stop Press pages & cut-outs along with the cut-outs on Extra. MD+ files are also compatible with MD2 on the PCW and PC. The program is also compatible with the AMX mouse. Contains too many features to list here!

REQUIRES 128K AND A DISK DRIVE

MJC PRICE ONLY £28.95

MICRODESIGN PLUS & AMX MOUSE

Buy the Microdesign+ program together with the AMX Mouse

MJC PRICE ONLY £59.95

GOLDMARK PAGE PRINTER

Contains printer drivers to enable you to print out your Microdesign Plus pages on your 24 pin or Bubble Jet printer

MJC PRICE ONLY £9.95

ADVANCED ART STUDIO

Probably the best graphics package for the CPC. Contains lots of features such as: Cut and Paste, Zoom in & Out, 16 Pens, 8 Sprays, 16 Brushes, Rotate, Copy and many more. It is also compatible with the AMX Mouse. (Requires 128k)

ADVANCED ART STUDIO CASSETTE ..15.95

ADVANCED ART STUDIO DISK17.95

ADVANCED ART STUDIO & MOUSE...49.95

AMX MICE & INTERFACE

We now have CPC mice and Interfaces back in stock.

CPC MOUSE & INTERFACE £34.95

(Plus' owners please call before ordering)

PRINTER RIBBONS

X1 X2 X5

DMP 2000/30003.00 ..5.50 ..12.00

Panasonic KXP1081/1180 3.95 ..7.00 ..15.00

Citizen 120-D3.95 ..7.00 ..15.00

Star LC-10 Mono3.95 ..7.00 ..15.00

Star LC24-10 Mono4.95 ..9.00 ..20.00

Panasonic KXP-11243.95 ..7.00 ..15.00

Star LC-10 Colour5.95 ..11.00 ..-

Star LC200 Mono5.50 ..10.00 ..-

Star LC200 Colour10.95 ..19.95 ..-

Star LC24-200 Mono4.95 ..9.00 ..-

CF2 DISKS

5 for£8.95

10 for£15.95

20 for£29.95

SERIOUS DISKS

NIRVANA

Various disk utilities including Copy Format and Un-Erase. Also includes a Sector Editor & File Archiver
MJC PRICE £14.95

Protect19.95

Prototype21.95

Prospell17.95

Promerge17.95

Matrix Spreadsheet Plus29.95

Masterfile 329.95

Mastercalc 12825.95

Stardump14.95

Stockmarket29.95

Extra Extra (Fonts & Clip Art).....14.95

Money Manager21.95

Maxam Assembler19.95

Mini Office 214.95

COLOURDUMP 3

After a lot of feedback on ColourDump 2, we are now pleased to announce the latest version of the best colour screen printing program for the CPC range. Requires Star LC-200 or compatible 9 pin colour printer.

Improved use with Advanced Art Studio. Will automatically read in palette file and set screen mode to ensure your page is the same as your screen. Uses compressed or uncompressed files.

Bigger printouts. In addition to the original 13 cm x 9 cm image, a large print out at 22cm x 15cm is available at single or double density.

Use Multiface screens. A conversion routine is supplied to allow most Multiface screens to be used.

NO OTHER COLOUR SCREEN DUMP OFFERS SO MANY FEATURES.

COLOURDUMP 3 £15.95 DISK ONLY

GAMES DISKS

THIS MONTH'S SPECIAL STREET FIGHTER 2

MJC PRICE ONLY £11.95

(Price valid until 31st March 1993)

Football Manager 3CALL

Hero Quest Double Pack12.95

Lemmings15.95

Manchester United Europe10.95

North & South12.95

Outrun Europa11.95

Sim CityCALL

Smash TV11.95

Space Crusade11.95

Street Fighter 211.95

Titus The Fox11.95

COMPILATIONS

Classic Games 412.95

Capcom CollectionCALL

The Dream Team15.95

Gary Lineker CollectionCALL

Max Pack17.95

Super Fighter15.95

Super Sega CollectionCALL

Super Sim PackCALL

EDUCATIONAL DISKS

LCL SOFTWARE

Primary Maths (3-12 years).....19.95

Micro Maths (11-GCSE)19.95

Micro English (8-GCSE).....19.95

Mega Maths (A-Level)19.95

KOSMOS SOFTWARE

French Mistress (12 to adult)15.95

German Master (12 to adult).....15.95

Italian Tutor (12 to adult)15.95

Spanish Tutor (12 to adult).....15.95

Answerback Junior Quiz (6-11 years).....10.95

Factfile Arithmetic (6-11 years) ...7.95

Factfile Spelling (6-11 years).....7.95

(Factfiles require Answerback Junior Quiz)

THE FUN SCHOOL RANGE

Fun School 3 6 programs per disk

Fun School 3 For 2 to 5 years...11.95

Fun School 3 For 5 to 7 years...11.95

Fun School 3 For 7 to 11 years...11.95

Fun School 4 6 programs per disk

Fun School 4 For 2 to 5 years...11.95

Fun School 4 For 5 to 7 years...11.95

Fun School 4 For 7 to 11 years...11.95

ACCESSORIES

DKT 64K Memory Expansion39.95

8 bit printer port (inc. lead)24.95

CPC to parallel printer lead9.95

CPC PLUS to parallel printer lead6.95

464 keyboard to monitor ext leads...7.95

6128 keyboard to monitor ext leads...7.95

6128+ keyboard to monitor ext leads...7.95

FD1 Disk Drive lead (664/6128).....7.95

464/6128 Dust Covers7.95

464/6128 PLUS Dust Covers8.95

Quickjoy Python Joystick.....9.95

Competition Pro 5000 Joystick13.95

Zip Stick14.95

Topstar Joystick19.95

CPM BASED

Protect CPM.....39.95

At Last Plus24.95

Supercalc 239.95

lankey Crash Course Typing .18.95

lankey Two Finger Typing ...18.95

Hisoft Nevada Cobol36.95

PRINTERS

All prices include a cable, ribbon, VAT, postage & packing. A courier delivery service is available, just add £5.00.

Using a colour printer with the Amstrad CPC requires additional software.

FEEL FREE TO CALL FOR ADVICE

THE MJC COLOUR PRINTING PACK

All you need to start designing and printing colour pictures on your Amstrad CPC 6128.

This is a complete package and does not require any additional cables or software. The software supplied will only run on the 6128 or 6128+

PACKAGE CONTAINS:

Star LC-100 Colour Printer

ColourDump 3,

Advanced Art Studio

Parallel Printer Lead

NORMAL PRICE £223.80

MJC PRICE £199.95

9 PIN PRINTERS

STAR LC-20

Star's new replacement for the popular LC-10 is sure to be a winner
MJC Price £159.95

PANASONIC KXP-1170

Replacement for the very popular KXP-1180. Still offers 4 NLQ fonts and fast printing. Very good quality text for a 9 pin printer
MJC PRICE £159.95

NEW - STAR LC-100 COLOUR

The new budget 9 pin printer from Star. 8 NLQ fonts, 180 cps in draft mode and 45 cps in NLQ. Paper parking with push feed tractor. Excellent value for money.
MJC PRICE £189.95

24 PIN PRINTERS

When printing graphics from a 24 pin printer the results will be distorted without using some extra software.
Please call for advice before ordering.

STAR LC24-100

Star's new 24 pin mono printer. 192 cps draft and 64 cps LQ. 10 Letter Quality Fonts
MJC Price Only £199.95

PANASONIC KXP-1123

Panasonic's entry level 24-pin printer. Offering a better print quality than the Star models, but with 4 LQ fonts and fewer effects
MJC Price £219.95



Card holders can order now on: **0462 481166**



Reaction



Welcome to Reaction! As well as your letters, we've also got an open letter from the publisher of Amstrad Action to you, the readers.

Don't try this at home, kids!

As a newcomer to the world of computers, and very ancient into the bargain, I find much of what I read in your magazine a complete mystery. However, I have made a discovery which I wonder if many of your readers know about.

When a tape fails to load properly and the screen goes either blank or comes up with the message "read error", it may be possible to cure the problem. I have encountered this on two occasions and each time I stopped the tape at the place where the fault occurred, removed it from the tape player, carefully pulled out a couple of feet of the tape, placed the tape between a couple of layers of smooth material (a couple of pillow cases are ideal), and then carefully ironed over the tape with a warm iron. After winding the tape back in and then rewinding in the computer tape player the tape then loaded perfectly! Am I an old genius, or what?

Mrs V Crossley
Polegate, Sussex

Erm, I'm not entirely sure how good an idea it is to pull out bits of your covertape and iron them. I mean, it is a good idea in itself as you're straightening out the tape. But, and I would stress this, please don't try this if you're one of our younger readers. Not only will you be unable to reach the ironing board, but irons are very dangerous things. Ask your mum or dad to iron your tape for you. Alternatively, for that real professional touch, take it to the launderette and

get it done there! Ed.

The awful truth

I have been playing *Tir Na Nog* for at least three years and I seem to be unable to complete the game. This is despite playing it in several different ways.

I am now worried that this is a game which is perhaps impossible to complete. Several clues seem to point towards this conclusion...

★ None of the Lords and Ladies seem to have completed this game, although it's been around for ages.

★ No one has answered my previous pleas for help in AA.

★ You gave the game away a year ago, so someone must have tried it.

Can you confirm the truth about this game? Can you force the writer to come clean? This is a last desperate plea, I must know if there is hope.

Dave Gahan

Tupsley, Hereford

There are two schools of thought as regards this little poser. Some people say that the reason nobody's ever finished the game is simply because it's so dull. The other school, of which I'm a member, tend to think that the rest of the world is conspiring against you - including the programmer! No, seriously, I'm sure there's nothing wrong with the program itself otherwise we would have had other letters about it and, erm, we haven't.

By the way, are you that Dave Gahan out of Depeche Mode? Is that the reason you haven't



Life after Protext

Why is it always *Protext* which is put forward as the last thing in word processing for the CPC? I have to admit that I was an avid user of the program, that is until *Brunword*.

I have been using *BW* now for about two and a half years for page layout including illustrations.

Logos are designed using the *Easydraw*

released many records recently - because you've been too preoccupied with Tir Na Nog? Ed.

Naughty, naughty, very naughty!

In issue 88 of AA, I glanced at a program by Simon Clark called *Blocks*. Very recently I had borrowed some copies of ACU from someone, and I noticed a striking resemblance to a ten-liner called *Tower of Brahma* by Chris Wooton. Simon Clark has taken *Tower of Brahma*, added bits and bobs to it, called it *Blocks*, and put it under his own name. I have supplied a photocopy of the original program, which was in the April 1990 issue of ACU. Whether this deserves £20 is beyond me, but I don't think it does. Maybe Simon thought we wouldn't notice, eh? So don't do it again, mate.

Nicholas Campbell

Newtonmards, Northern Ireland

I suppose it is a bit on the naughty side, but it's not the naughtiest thing I've ever seen. After all, it's not as if it's exactly the same program, Simon did make some changes. Maybe those bits aren't worth £20, but all we can do is try and be more vigilant in the future.

By the way, did you know that Brahma is a Brazilian beer with a really smart advertising campaign? Y'see, if you buy a bottle of Brahma then ten pence, or something, goes towards saving the rainforest. The best bit is the posters, there's all these bright parrots sitting in the forest and underneath it says something like 'Drink Brahma and be popular with the birds.' It's very smart. Ed.

program which was published in the now-defunct *Attack* magazine, any cleaning up being done in the *Dartscan* program. Illustrations are scanned using *Dartscan*.

M F Gurney
Billericay, Essex

*I must admit that Mr Gurney's letter and enclosed example looked very good indeed. We've reproduced his pictures, so you can see the quality. So, if you're thinking of getting a word processor, this is certainly one to think about. Alternatively, you could wait until next month and get *Tasword* free.*

Ed

Soccer simulation shock

A few months ago I came into a little money, only a little. So I saw your rave reviews on the football compilation Soccer Stars and I ordered it from MJC Supplies. I received the game and, as you said, it was great. *Gazza 2* was good fun, as was *Kick Off 2*, and *Emlyn Hughes* was excellent. The problem came when I loaded *Microprose Soccer*. It loaded fine, and I saw in the instructions to go for *Microprose International Challenge* for a quick start, this was not in my options menu. Your review said that you used the 11-a-side facility and it said nowhere in the instructions that you couldn't get 11-a-side on the Amstrad. I was quite put off as the six-a-side American facility isn't that good. Please could you give me an address where I could find out whether I could get this facility or a new disk.

Jon Joasbury
Ivybridge, Devon

Well, either our reviewer was lying, or you can get 11-a-side and you just haven't found it yet. You could either contact MJC supplies and see if they forgot to include part of the instructions. You could just find the address of the original publisher on the game box itself, and try contacting them. **Ed.**

Console conundrum

I am the proud owner of the Amstrad games console, the Amstrad GX4000. I have not yet bought any games, but I have been out looking for some. After a day of no success, I decided to go to the shop where I bought the console itself. They told me that I wouldn't find any in the shops, but that if I became a member of the Amstrad User Group then that had games for my particular console. Unfortunately, they had no idea where I should write off to, so I thought, "Who better than Amstrad Action?"

Could you please send me information about this club if it does exist, and where I can find games if it doesn't? I would very much appreciate it as I'm getting tired of *Burnin' Rubber*.

Giancarlo Cassano
London

Okay, first the bad news - the Amstrad User Group disbanded quite a while ago. But, and here's the good news, you can probably get console games from a mail order company called *Trade-In Post*. They advertise in AA on a fairly regular basis, look in a few of your back issues. **Ed.**

Some questions

I am writing to congratulate you on producing a good magazine which is a good read for gamers and serious users alike. I have several questions to ask you, they are...

1. What is the value of the components in a GX4000 console? Why did it have little commercial success?
2. What games do you have lined up as covertape games in the near future?

3. How much of the cost of an £11.99 computer game goes to the software house and how much to the retailer?

4. Why don't you include slightly more adverts (ie - you charge less for adverts) and then you could produce a proper magazine with more than your measly 58 pages.

Peter Barnes
Stroud, Gloucester

1. The value of the components is probably around £30, but you've got to remember that they're buying in bulk. The reason it had no commercial success was because it was aimed at CPC users - people who preferred to have the CPC+ which was effectively a console and a CPC in one box.

2. Oooh, let's see... we've got *Wizard's Lair*, *Syntax* and *European Superleague* amongst others. And they're all pretty smart.

3. It depends on the retailer. Big retailers like *Smiths* and *Menzies* earn more from their games than *Fred Bloggs*, independent retailer.

4. A lot of people don't like to admit this, but adverts make money. Our ads aren't actually that expensive (as ads go). If we charge less for ads then we need more ads to get the same amount of money as we were getting before. (If you see what I mean.) We'd have to sell loads more ads before we could afford an increase in pages. **Ed.**

All together now

Firstly I would like to point out that if anyone was thinking of following up the article about the huge amount of CPC software available in France, don't bother. When I went, the full price shelves in Auchen were all but empty and, although the range of budget games was large, there were no outstanding titles. This was just before Christmas, when you'd expect the shelves to be quite full. I would also like to point out that in the latest issue of *Check It Out*, a young people's buying guide, not only was the great AA given a very poor 32%, but CPC Attack got 40%.

Also, snide comments were made about the amount of life left in the CPC. I urge all faithful AA readers to boycott this pathetic mag that's obviously written by Gameboy-playing idiots. Together we stand united.

Fraser Hewitt

Help us to help you

Now, we know that it's essential that readers are able to contact the world's greatest CPC mag, but we seem to be having a few problems. Firstly, there's the problem of unmarked mail. We receive far too many letters addressed simply to Amstrad Action. It would be much nicer if you would mark on the letters which particular feature you are writing to, as it makes our mail sorting system much easier, and means your letter is much more likely to reach its proper destination.

Secondly, it must be stressed that we cannot replace games that you have bought in the shops. Any damaged goods you have bought should be exchanged at the shop you

Sandwich, Kent

United we stand, divided we fall! Workers of the world unite, we have nothing to lose but our minds, and they aren't our own anyway! Remember kids, the state is your enemy! Storm the barricades! Lock yourself in your bedroom! Refuse to eat anything but crisps and... Oi, Adam! What are you doing here? Get out, shoo! **Ed.**

I know a man who does!

I have grave news - the rare oasis in London, Virgin Gamestore, has stopped stocking Amstrad software. This means that the only way Amstrad owners in the south can get hold of software is by ordering through mail order or taking a daytrip to France.

I have found a shop that does sell Amstrad software and isn't thinking about quitting the Amstrad market, but unfortunately for me it's way up in Coventry. It's called K-Soft, it's in Cathedral Lanes and has over four shelves of CPC stuff, but no cartridges.

Chris Edwards
Surbiton, Surrey

There is actually a very good mail order company called EDOS (which stands for Electronic Distribution of Software). They have masters of absolutely tonnes of games, you tell them what game you want and they duplicate it for you and send it off. It's all perfectly above board and legal, and the software houses know all about it. So don't worry! For a free catalogue simply send a large sae to EDOS, Computer Visions, 30a School Road, Tilehurst, Reading, Berkshire RG3 5AN. **Ed.**

A face in the crowd

Has anyone watching *Gamemaster* noticed a certain Scottish chap commenting on the challenges called Frank O'Connor? The challenges he commented on were for the SNES. Is this the same chappie that used to work for AA and left just before Adam came along? Traitor!

Matthew Long
Calcot, Berkshire

You're spot on, Matthew. That cheery chappie was none other than the same Frank O'Connor who once graced these pages with his wicked wit

bought them from. If, however, you have problems dealing with software companies, then please write and tell us, but mark your letters to Reaction, and don't include your tape! We really cannot do anything with them. Of course, if you have problems with your covertape, then send the tapes to Ablex and they'll send you a new one back. Their address is on the covertape pages. Thank you, thank you and thank you. (Again!)

The address to send you Reaction letters to is...
Reaction, Amstrad Action, 30 Monmouth Street, Bath, Avon BA1 2BW.
We regret that letters cannot be answered personally, so please don't enclose saes

URGENT!

AMSTRAD ACTION

Beauford Court, 30 Monmouth Street, Bath, Avon, BA1 2BW
Telephone: 0225 442244 Fax 0225446019

23rd February, 1993

Dear *Amstrad Action* Reader,

Next month you will witness a radical change in *Amstrad Action*. Not so much in the magazine, but in the already acclaimed covertape. For a start, it's now going to be called **The AA CLASSIC COLLECTION**. This means it'll feature better programs than ever before, and more of them.

Every month you will receive a full commercial program, worth at least £20. Guaranteed.

This does mean that the price of the magazine will increase by forty-five pence (to £2.95), but it also means that we're sticking to our commitment of value for money. After all, you're getting a magazine, a full program (worth at least £20) and a game (worth at least £2.95) for less than three pounds. I consider this to be an exceptional offer.

We've spent the last couple of months trawling the CPC world for full commercial versions of the best programs. This means word processors, databases, spreadsheets, printing utilities, DTP packages... the list goes on. These will help to increase the size and breadth of your software collection. This means that you really will be getting the most from your CPC, and it'll help you make considered buying decisions when choosing the really advanced programs.

The first offer will be a fully working version of top word processing package *TasWord*, with spelling checker. This is *Amstrad Action's* most ambitious offer to date. **If you were to buy this version of *TasWord* in the shops, it would cost you £25.** This doesn't mean that we'll be neglecting games. The new **Classic Collection** pack will feature an action-packed full commercial game every month.

And what of the magazine itself? Well, I can assure you that it will continue to be the essential read it always has been. It'll be packed with information on the serious and the not-so-serious side of CPC computing.

**AMSTRAD ACTION IS 100 PER CENT COMMITTED TO THE CPC. IT IS THE ULTIMATE
CPC PERIPHERAL.**

I look forward to hearing your comments on the **Classic Collection**. I feel certain that you will be as enthusiastic about this as I, and the rest of the *Amstrad Action* team are.

Kind regards,



Colin Campbell
Publisher

Future
PUBLISHING

Registered Office
Future Publishing Limited
Beauford Court, 30 Monmouth Street,
Bath, Avon, BA1 2BW
Tel: 0225 442244 Fax: 0225446019
Registered Number
2008885 England

Balrog

Adventuring news, views and awards.

Welcome to yet another missive from the mighty Balrog spreading the word of adventure to all his followers. There's no hanging about this month, we go straight into the most awaited event in the adventurers' calendar...

The Balrog awards results:-

The response to the Balrog awards was very impressive – letters appeared from all over the World, and the results were as follows:-

The Top Five Adventures Of All Time:

- 5 *Magnetic Moon* FSF Software
- 4 *Price of Magick* Level 9
- 3 *Hobbit* Melbourne House
- 2 *Bard's Tale* Electronic Arts

According to AA readers, *Helvera Mistress of the Park* is the best adventure of all time. Well done to Bob Adams, the author, for writing such a popular game!

The award for the best text adventure of the year was a close-run thing but the winner was... (sound of an excitedly-ripped open envelope)



Aargh! To think we give this thing freelance work!

Helvera Mistress of the Park!

The best graphic adventure of the year was also very close, but eventually Rob Buckley's *Eve of Shadows* came out on top. *Eve of Shadows* also scooped the award for best PD adventure.

Wow Software deservedly (I think!) won the title of best software house (well done Joan!) and **Adventure PD** won the title of best public domain library.

Adventure personality of the year was another close run award (at one point it looked like yours truly would win but unfortunately I didn't!) which was eventually given to **Debby Howard** of Adventure PD.

And the award for the most promising author went to **Simon Avery**. And why not! (Brilliant Barry Norman impression by the Balg... NOT!)

The results of the Balrog questionnaire were also very interesting – the average age of a Balrog reader is 17 and 5% of Balgers are female (Balgettes?). There's an even split between 464 and 6128 owners with quite a few adventurers without disk drives. (The Balg was surprised by this – I thought many more adventurers would have disk drives so that they could play the various Infocom, Magnetic Scrolls and PAW games).

Nearly all of you gave the Balrog column a good mark out of ten (it averaged out to about 8.5) and most peoples favourite section was the cluepot, with the GAC Clinic and Lords & Ladies being the least popular (although this was often a

Lords & Ladies of Adventure

I always have to tell any possible newcomers out there how this bit works, so if you've heard it before, skip to the start of the list! For you newies, this is how this section can help you... There are a number of CPC adventurers who are willing to share their knowledge with you. If you have a problem with any of the following

games, simply drop a line to the Lord or Lady who's got the solution. Enclose a sae, and remember to keep your needs as simple as possible.

Complete solutions are out - these kind volunteers have their lives to be getting on with!



Adventure Quest ● Dungeon Adventure ● Gnome Ranger ● Imagination ● Knight Orc ● Kobayashi Naru ● Jewels of Babylon ● Lancelot ● Lords of Time ● Mystery of Indus Valley ● Price of Magik ● Redmoon ● Return to Eden ● Shadows of Mordor ● Snowball ● Souls of Darkon ● Venom.

Wendy Watters, 82 Booth Road, Stacksteads, Bacup, Lancashire OL13 0SF. Tel: (0706) 877518

Classic Adventure, Fantasia Diamond, Hobbit, Hollywood Hijinx ● Inca Curse ● Mountains of Ket ● Planet of Death ● Sorceror.
Dave 'Flossie' Havard, 21 Belvoir Close, Fareham, Hants PO16 0PJ

Forest at World's End ● Jewels of Babylon ● Seabase Delta.
James Mackle, 45 Kenure Park, Rush, Co Dublin, Ireland

Bard's Tale ● Hitchhiker's Guide ● Laser Squad ● Lord of the Rings ● Lords of Chaos ● Lurking Horror ● Price of Magic ● Quill (+Illustrator) ● Scapeghost.
Simon Netherwood, 36 Toothill Bank, Rastrick, Brighouse, West Yorkshire HD6 3EZ. Tel: (0484) 719326 5-9pm weekdays, 12-11pm weekends

Andy Capp ● Price of Magic. The Kenderian, 475 Westhorpe Ave, Eltham, London SE9 5LR

Jewels of Babylon
Chris "The Barbarian" Gore, 22 St. Anthony's Pk., Mallow, Co. Cork, Ireland

Help!

Stuck in an adventure? Or desperately trying to find one – the helpline is the place for you! Just send a postcard to Balrog's Helpline at the usual Balrog address.

● Patrick Dyson from Shipley wants to know how do you glue the map and open the safe in *Subsunk* – can anyone help?

● Wanted: *Genesis* instruction booklet and hints and tips for *Moonmist*, *Lancelot* and *Staine*.
Dominic Corby, 62 Roxwell Road, Chelmsford, Essex CM1 2ND. Tel: (0245) 353718

● Mark Hudd is stuck on Level 6 of *Bloodwych* – does anyone know how to get past the green pads? He also wants to know what the various wands and rings do.
2 Bankside, Staple Hill, Bristol, BS16 5LQ

● Philip Carver is stuck in no less than three games. He wants to know how to stay in the kitchen in the *Famous Five*. How to move the lift in *The Pawn* and, finally, how to persuade the sessiones to retreat at Tintagel in *Lancelot*.
20 Pirie Road, West Bergholt, Essex, CO6 3TA. Tel: (0206) 241181

matter of taste – some people gave marks of 10 for Lords & Ladies and others gave it 0). Suggestions ranged from the silly ("Why don't you become a vegetarian and stop eating all those hobbits?") to more constructive comments which have all been eaten (but in a very intellectual kind of way).

Finally, as promised, two lucky readers won a game for their troubles of sending in the questionnaire. Well done to **Marc Curtis** of Liverpool and **Graham Booth** of Tadcaster.

If you have anything to say about an adventure game or the adventure scene in general then write to the Balrog at the usual address. Sorry but the Balrog cannot reply personally – I have enough on my plate trying to control all the orcs that live with me!

GAC Programming Clinic

This month readers have sent hints on how to get the most out of GAC...

Dear Balg,

I overcame one little difficulty in a way other users may find helpful. Unless you are extremely well organised, it can be a pain remembering the next number to use for your verbs, nouns and adverbs. I always have one of each called 'AA' carrying the highest number.

So, when I need a new verb, the screen displays all my verbs in alphabetical order with AA sitting at the top (naturally!) showing the next number. If it were, say, 47 and I needed a new verb, Twist, I can immediately delete 47, enter 47 Twist and 48 AA.

Ray Bryan

Dear Balrog,

Does anyone else know about the ADVINMAN.ADV file that follows QS.ADV on the covertape? It is an amusing little adventure, and it is very helpful to be able to examine the GAC conditions used in it and see how they work.

C Hetterington

Multipart adventures

Although it is not possible to link various parts of a game together so you can carry through objects, there is another way to make multi part adventures – simply at the end of the first part give the player a password for the second part and then at the start of Part Two, make the start location have the description 'from Part One...' (making sure you have no exits from this location). Then just create a condition so that when the password is typed the player is transported to Part Two proper. However you won't be able to take objects across from Part One – you have to try and make Part One end with the player carrying either no objects or a few objects which you can predict (so at the end of Part One you could attack the player muggers who steal all his objects etc).

Contacting the Balrog

To communicate the Balg, write to him at Amstrad Action, Future Publishing, Beauford Court, 30 Monmouth Street, Bath, Avon BA1 2BW.

Letters

Dear Balrog,

I am conducting market research into the demand for Adventure Software on the Amstrad (tape/disk) as I am thinking of starting up an adventure software house to try and revive some of the old flare for the games.

Is it possible to print this plea for help and ask everyone that's interested to write to me. **Iain Quigley, 14 Bute Court, Greenock, Inverclyde, Strathclyde, Scotland PA16 7AG**

Good luck Iain and keep me up to date if anything comes of your idea! **The Balg.**

Dear Balrog

What is your favourite Level 9 game?

Robert Melody, Purley

Probably Worm in Paradise – the game is massive and has some very tricky puzzles. Thanks for the letter and GAC hints, Robert. Unfortunately I can't print them as they came from another magazine. **The Balg.**

Dear Balrog,

I was thinking of buying *Bloodwych* as I have greatly enjoyed playing *Bard's Tale*. I was wondering if it was worth getting, how difficult it was and where on Earth to get it! I'm also looking for the old RPG *Rings of Darkness*.

Tom Ford, 5 Sheperds Way, Harpenden, Herts AL5 3HF

Bloodwych is well worth getting – however you may have difficulty finding it now. If anyone wants to sell their copy then get in contact with Tom. *Rings of Darkness* is now pretty ancient and could be very difficult to get hold of. Even if you do manage to you'll probably only get it on the *Fourmost Adventures* compilation. Again if any readers can help then they should get in touch. **The Balg.**

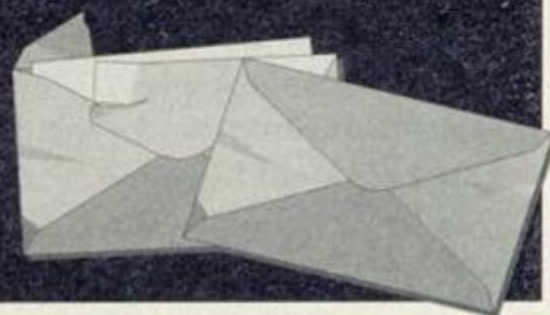

Balrog's Cluepot

Cluepot

This month's honeypot of clues comes to you courtesy of the following do-gooders... Thomas Christie of Grangemouth, Richard Jamieson of Aberlour, Katharyne Allen of Guernsey, Dominic Corby of Chelmsford and Robert Smith of Gwynedd.

Case of the Mixed-up Shymer

- Examine garden display for pack of seeds.
- Give them to Mary, Mary, quite contrary to complete the first puzzle and get gloves.
- Put all in briefcase, find tramp in park and attack him, you will now be taken to hospital.
- Wait until the nurse goes, don't get watch.
- Get up. Get cases and papers. Get up.
- Put briefcase on empty bed, south, south, open locker, get stethoscope and clothes, north, east, put all but papers in pillowcase, wait for second footsteps outside, wait, west, west, wear bandage, lie on bed, wait, wait. You are now in the ambulance.
- Wear stethoscope and wait until you are dropped off.

Erik the Viking

- Blow the horn to summon your friends.
- Type pull boat in the boathouse.
- Don't drink wine offered by enchantress.
- When you meet Dragon of the north sea, send Erik up mast and up on to dragon's nose. Dragon will sneeze and blow you and the boat away. To avoid this, block his nostrils with the bedding from the great hall.

Microman

- Get lighter, examine car, climb seat belt, wind handle and jump to escape the car.

Mordon's Quest

This one's especially for Rix.

- Make a blowpipe to despatch the pygmy and then use the pygmy to get passed the plant.
- Lay down the blanket over the quick sand to walk over it safely.

Rigel's Revenge – Part 2

- To get passed the checkpoint: From start: Ex2, wait until you hear marching to east, E, N, E, get rifle, examine seat, get documents, W, S, W, wait again until you hear marching to the east, E, Sx2, Ex4, S, E, dig and get light guide.

Seabase Delta

Another one for Rix!

- Enter car, fasten seat-belt and insert card in slot to get car in station to move (the card is obtained from the dead body).

Smashed

Robert Smith! This one's just what you need.

- Inject Clingon with anaesthetic.
- Get cat and then enter chopper, switch on then pull joystick to get the key.
- Inject Crank with sodium pentathol.
- Get Clingon's dress.
- Hypnotise crank with Padre's book and give him the dress.
- Drill pills and string them with catgut to make fake pearls.

Technical Forum

This month **RICHARD FAIRHURST** answers loads of your letters. If you have a pressing technical query then just write it down and send it off to Technical Forum, Amstrad Action, Beauford Court, 30 Monmouth Street, Bath, Avon BA1 2BW. We'll try and help. Now let's make a start on those letters...

SCROLL OF WISDOM

I am trying to make a game, but have a major problem. Is there any way, in BASIC, that you can make the screen scroll from right to left (as in R-Type, Robocop etc) instead of bottom to top?

Bruce Dunbar
Tyne and Wear

No problem at all. Type in this listing...

```
10 MEMORY &9FFF: FOR n=&A000 TO &A02E
20 READ a$: POKE n,VAL("&" + a$)
30 NEXT n: CALL &A000
40 DATA 21,09,A0,01,0D,A0,C3,D1,BC,00,00,00
50 DATA 00,15,A0,C3,1F,A0,C3,27,A0,52,49,47
```

```
60 DATA 48,D4,4C,45,46,D4,00,CD,0B,BC,2B,2B
70 DATA C3,05,BC,CD,0B,BC,23,23,C3,05,BC
```

This sets up two new commands: *IRIGHT* scrolls the screen right, and *ILEFT* scrolls it left. Like all RSX programs, you should only RUN this program once after every reset. **AA**

DOWN UNDER

1. In Australia, there is hardly anything for the CPC, except Amstrad Action! How is it possible to purchase the latest CPC software?
2. I use Stop Press on my 6128 and the printing is incredibly slow, because it uses only two pins. Could I get a program which increases the

Multiface Questions

This month AA is going overboard with tips for Romantic Robot's little black box. Here are some of the questions you've sent us about it...

ANCIENT AND MODERN

I have recently purchased a second-hand Multiface 2. When I first attempted to use it, the game I tried to load (*Rainbow Islands* on disk) did not load. I read in AA that it is possible to hide the Multiface by pressing the Stop button then R. However, this did not work. In fact, only a small selection of my tape games loaded successfully. Is there a way of hiding it?

Matthew Boulton
Kent



Rainbow Islands - if it doesn't load, what's wrong?

Older Multifaces, unfortunately, don't have the facility to be hidden - this was introduced after software houses got wise to the device and started making games crash if a Multiface was detected. As you bought yours second-hand, it seems that you have one of these! The best suggestion is to phone the manufacturers, Romantic Robot (081 200 8870) and ask them if they could upgrade your Multiface to the latest version. AA

PLUS PROBLEMS

I have recently attached a Multiface 2 to my 464 Plus. Everything works well until I try and switch the Multiface off by selecting Return from the Multiface's menu: anything I type in, I get the message "Press PLAY then any key" and if I try and press ESCape, the disc drive I have attached starts. The only way I can stop this is by resetting my computer. Please help me, or I can't transfer many of my tape games to disk. Thanks.

Bruce West
March

Are you using the special CPC Plus version of the Multiface? A slightly different model is needed for correct operation on 464 Plus and 6128 Plus machines. If you bought the Multiface second-hand, without realising that it was a CPC version, this might explain why it's not working. Again, a phone call to Romantic Robot (081 200 8870) should sort things out. If you are using the Plus version in

conjunction with a WAVE widget, it may be a case of a dirty expansion port somewhere along the line. Find an ink rubber (or even better, a Peco track rubber from a model railways shop), and clean all the expansion port connections with it. If you still have no luck, return it to Romantic Robot. **AA**

ROBBING THE BANK

I find the Multiface's toolkit brilliant for altering the contents of memory, hacking games, etc. But how do I get to fiddle about with the extra memory of my 6128? The manual says something about pressing 'S', but I don't understand what it means: all that happens when I press it is that a question mark appears and I can't type anything. Please help me!

Robert Ham
Edinburgh

When you press S, the Multiface wants to know the bank-switching code (from 0 to 7) to use. This number determines whereabouts in memory the extra 64K is switched in.

The easiest way to access extra memory is to do the following: if you press S followed by 2, then whatever you do will alter the extra memory instead of the first 64K. (This is very useful for altering the second program if you're using *Flik*, from last month's covertape!) Pressing S followed by 0 brings back the first 64K. Unfortunately, the Multiface can't actually alter memory in 256K RAM packs above the first 64K! **AA**

number of pins and the speed?

3. I can format and read sectors with a length of six, but is it possible to write to this format?

Matthew Brown
Australia

1. Most of the mail-order companies which advertise in AA will be happy to send software overseas, for an additional postage charge. Write to them with an International Reply Coupon for details.

2. X-Press, by Medway/King, is one of the best programs that will deal with your specific problem. Unfortunately, it's not being advertised any more, but placing a Wanted advert in the Small Ads section in AA might help.

Alternatively, a Polish PD program prints Stop Press pictures quickly - try your friendly local PD library. (That's if you've got one. If not, try a British one.)

3. Not really. It is possible to write a small portion of data to this format, but not the full 8K: this means that a CPC cannot copy such sectors, a fact used by many disk protection systems. However, an Australian boffin has reputedly come up with a hardware modification for your CPC which lets you do this. More details when we get them. AA

CANON LAW

I am writing to enquire about the Canon bubble-jet printer. I have heard that it can emulate an Epson nine-pin dot-matrix printer. Would this printer be compatible with my CPC 464 (upgraded to a 6128)?

A. Baker
Northampton

The Canon bubble-jets are increasingly popular these days, and no wonder: the output quality is excellent. Make sure that you buy a BJ-10ex, rather than a BJ-10e. The 'ex' model is the one which emulates an Epson 9-pin, which most CPC programs support. You'll need a CPC printer cable, too: O J Software can sell you one for £8.95 (0257 421915). AA

SIZING THINGS UP

Please help: is it possible for the length of a file to be recorded in a variable?

Tom Ford
Harpenden

Enter this listing and RUN it:

```
10 MEMORY &9FFF: FOR n=&A000 TO &A021
20 READ a$: POKE n,VAL("&"+a$)
30 NEXT n: CALL &A000
40 DATA DD,6E,00,DD,66,01,46,23,5E,23,56,EB
50 DATA 11,00,C0,DD,ES,CD,77,BC,DD,E1,DD,6E
60 DATA 02,DD,66,03,71,23,70,C3,7D,BC
```

Once RUN, you can get the length of a file (in bytes) into a variable as follows:

```
variable%:0: a$="filename": CALL
&8000,@variable%,a$
```

That should do the trick! AA

TOP TIPS

MACCPC

In Reaction (AA89) you printed a letter from a reader offering to send people details of how to transfer files from a CPC to an Apple Mac. Unfortunately you forgot his address, but it's easy anyway. Simply copy your files to a PC format 3.5" disk (using 2-in-1), and read this disk on the Mac using Apple File Exchange (which should come free with your Mac). If you have an old Mac without an Apple SuperDrive installed, you need to buy a SuperDrive for it.

I use this regularly for copying files between Protex on my 6128 and my school's Mac Classic II - as long as they are saved in ASCII format, MacWrite II can load them with absolutely no problem.

Matthew Khan
Powys

USER-FRIENDLY

I have read a lot of tips that say that you can change the user area to anything from 0 to 255 (with 229 being the erased files area) by simply poking this number into &A701.

Well, this worked on my 6128, until I bought a second ROMBO and fitted some ROMs (like Protex) in slots from 8 up: from then on it did nothing. However, I have come up with a POKE that works on all CPC setups. Type this line:

```
POKE PEEK(&BE7D)+256*PEEK(&BE7E)+1,user
number
```

Or, if you remove the '+1' and place 0 or 1 after the comma, you can select a disk drive without the usual whirring!

Chris Jones
Aldershot



Stars and stripes - easy hub?

MOVIN' ON UP

1. Will the 256K upgrade work on the CPC 464?
2. I am thinking of getting an EPROM programmer: do you think it is the best for writing a program?
3. I am hoping to upgrade my CPC 464 to 6128 configuration: how could my 464 match the 6128?
4. What does the MP1-F do for the 464?

James Henry
Colchester

1. Yes, although remember that not many programs can use the extra memory. To use it in your own programs, you'll need to use the supplied software (if you don't have a disk drive, make sure that it comes on tape!).

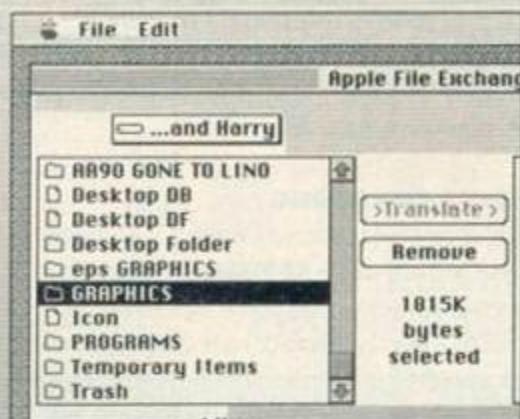

This is what Apple File Exchange looks like. It is extremely useful.

STARS AND STRIPES

I've discovered a great tip to produce stripey writing on the CPC's screen (I use a 664). Simply POKE &B72F with a number between 0 and 255: change the number for different effects (I find 60 gives a good stripe effect in MODE 1). Or, to change the background, POKE &B730 instead. Smart eh?

Don Tucker
Llangollen

The same addresses should work on the 6128. On the 464, try &B28F (for PEN) and &B290 (for PAPER).AA

PARLEZ-VOUS PROTEXT?

In Technical Forum (AA85), Alex Williamson described how to get accents for European languages for those sending letters as BASIC programs. I think I have an even better solution: just use Protex. It gives you a number of commands which set up the character set for foreign languages, such as French, German and Italian.

Even better, when you quit out of Protex, the letters stay the same! This means that, if you have Promerge Plus, you could have IP,"FRENCH" as a line in your BASIC program, which would redefine the characters and let you use them in your program. Of course, this is of absolutely no use if your pen-pal doesn't have Promerge Plus and Protex too. Still, it might come in handy!

John Waite
Woolwich

2. Only if you want to write machine code programs on ROM, and even then, you'll need a RAM-ROM (Avatar, 0442 251705) to test them. If you don't already have a disk drive, this is the most useful addition. For the budding machine code programmer, a ROM-board, Protex and Maxam 1.5 on ROM are recommended.
3. You'll need a disk drive (either an Amstrad DD1, or Siren's 3.5" equivalent - 061 724 7572) and a RAM expansion (64K or 256K). If you really want to go the whole hog, you can buy a 6128 ROM, to give you the new 6128 commands such as FILL (WAVE, 0229 870000). However, this isn't usually necessary for running 128K commercial programs, and fitting can be very difficult on some 464s.
4. The MP1-F lets you display the output from

your CPC on any TV equipped with a SCART socket (in general, only present on more expensive models). The quality isn't too amazing: Campursoft's Videomaster (041 554 4735) gives better quality results. **AA**

PRINTS CHARMING

I have recently obtained a Citizen 120D printer for use with my son's 464 Plus. Unfortunately, being somewhere in the stone age as far as computers are concerned, I am unable to make it print any text from the screen. A friend tells me I need a print driver. Could you point me in the right direction?

Secondly, could you please recommend an effective but relatively simple graphics package for my son's use?

T.E. Sumner
Plymouth

Oh dear, your friend is leading you astray! All you need to do to print a line of text is use the command PRINT#8. For example, to print "The ultimate CPC peripheral", just type:

PRINT#8,"The ultimate CPC peripheral"

You don't need a print driver at all. As to your second question, the best art package that works on a 64K machine is the PD program GPaint. A copy was given away on the covertape with AA - our back issues department can send you a copy for £2.50. **AA**

AAS EYE-STRAIN

I find that most of the menus on Advanced OCP Art Studio are unreadable. Black and dark red bars can be seen, but no letters!

Recently my seven-year-old grand-daughter came across the disk and tried it out - with no

OH CRIKEY, HE'S BACK

Just when you thought it was safe to turn on your CPC again, our intrepid techie expert Mr Fairhurst decides to increase the suffering of us all. Fade to a beach. Someone who bears a remarkable resemblance to an ageing television personality ambles along picking up tennis balls and bottle tops. The cold, salty wind breezes through his hair.

"Doctor?" questioned Richard.
"Is that you, student?"
"Yes, doctor. We need your guidance once more. Evil lords have taken over the CPC as we know it. There's a software cartel started, and Simon Forrester has

been linked with the Brinks-Matt robbery and is due for the chair at seven!"

"And you think you can get me back by just asking?" asks the wizened seer of the EEC 3" disk mountain.

"AA are offering a fairly healthy wodge of cash if you'll do it," answers the ever quick Richie.

"How much?"
"A lot"
"Right. Stand aside all you fascist programmers and money-minded sales people. I'm coming back. You can't get away with this any longer!... Wheeze... You won't get away with abysmal conversions and game concepts any longer. I can see the real situation. If you want to stick around, you'd better stand up to the almighty power of THE FEGGI!"
Oh brollies... We're sorry...

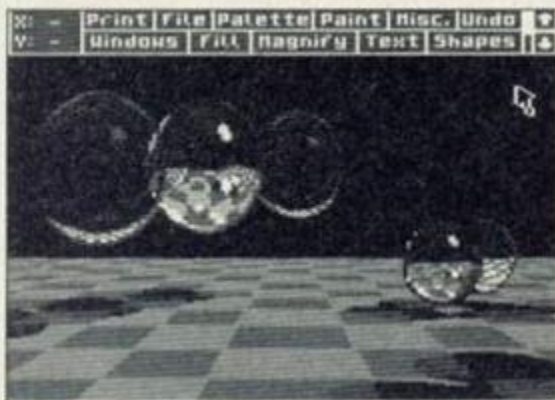

Advanced OCP Art Studio - it helps if you can see what's happening on screen.

success. However, leaving her persevering with it, suddenly the 'Misc' menu appeared in black-and-white - as did all the others. Unfortunately, after a few shape trials the menus reverted to

their original condition. Have I by any chance got a copy with a bug in it?

John Brownlee
Hertfordshire

The reason that the menus suddenly became readable is because your grand-daughter selected the 'Screen mode 2' option: this selects the two-colour mode, and so only the first two standard colours are used.

Advanced OCP Art Studio can be very difficult to see on a green screen (let alone understand!), but on a colour monitor it should be no trouble. Have you tried adjusting the brightness control? Failing that, select the 'Palette' option, and you will be able to change the colours (look in the manual for details) to something just a little bit more readable! **AA**

DOS UPDATE

Last month, AA featured the ultimate guide to disk operating systems. Well, almost: since then, we've heard of major improvements to the two top-rated DOSses, so we thought a brief second look was in order.

ROMDOS XL The souped-up version of ROMDOS from Siren Software, has been completely debugged since the version we



The software may be extremely smart, but it's useless without a 3.5" disk drive.

reviewed. What's more, it can now automatically detect between formats in drive B. There is no longer any need to type IDOSOFF if you want to read data or CP/M format disks. This is great, because we reckoned this was the major minus point against the program.

One smart new feature added to ROMDOS XL is a sector editor, like the DMON utility which we gave away on the covertape. If you play around with disks a lot, this is a great addition and unique amongst DOSses.

S-DOS This too, can now automatically sense what format the disk you have placed in the drive is. Unlike ROMDOS XL, though, it does this in both disk drives - great for ABBA switch owners or people with a 3.5" first disk drive (e.g. 464 Plus owners). It can also do this under both versions of CP/M (2.2 and Plus), a boon for all you 'A>' prompt junkies.

In addition, two more formats are supported by S-DOS: the first is a 3" disk format which gives you an extra 27K per disk - the same format as printed in an AA type-in (Ultraform) a while ago, except that S-DOS detects it automatically. For 3.5" disks, format 5 from MS800 (the most popular MS800 format) is included: if you have a collection of MS800

disks, this makes S-DOS an ideal upgrade.

After last month's round-up, ROMDOS XL and S-DOS were way in front of the competition: these improvements have pushed them further ahead. For devotees of the original ROMDOS, the improvements make the new version a very tempting proposition: if you have a large stack of ROMDOS disks, and want the convenience of built-in utilities, such as the rather spanky new sector editor, it's definitely recommended. To access 800K per disk without using a side switch, there is no other choice.

S-DOS narrowly retains the gold, though: it lets you use large formats in drive A, it's as happy under CP/M Plus as AMSDOS, the utilities are generally more powerful, and it's compatible with more programs. It's a close-run contest, but S-DOS is still the front-runner amongst DOSses.

ROMDOS XL 87%
£19.99 (ROM), £29.99 (cartridge)
Siren Software, (061) 724 7572

S-DOS 89%
£12.95 (ROM)
STS Software, (081) 317 3536

FREE! FROM SILICA



When you buy your new Atari 520 or 1040ST-E computer from Silica Systems, we will give you an additional £324.75 worth of software FREE OF CHARGE, including some great entertainment and productivity programs. Plus, with every ST and TT, we will give you 16 nights holiday hotel accommodation for you and your family to enjoy a break.

TENSTAR PACK:

ASTERIX	£24.99
CHESS PLAYER 2150	£24.95
DRIVIN' FORCE	£18.05
LIVE AND LET DIE	£19.99
ONSLAUGHT	£24.99
PIPE MANIA	£19.99
RICK DANGEROUS	£24.99
ROCK 'N' ROLL	£19.99
SKWEEK	£19.99
TRIVIAL PURSUIT	£19.95

PRODUCTIVITY PACK:

1st WORD*	£59.99
Word processing package from G3T	
SPELL IT	£19.99
Spelling checker to complement 1st Word	
ST BASIC	£24.99
Basic programming language with tutorial	

TOTAL VALUE: £324.75
WORTH NEARLY £325!



HARDWARE:

1/2Mb RAM 520ST-E	£249.99
16MHz 16-bit 68000 CPU, 512K RAM, Mouse, TV Modulator, Internal PSU, 1Mb Disk Drive	

SOFTWARE - ARCADE GAMES:

Final Fight - Street fighting game	£25.99
9 Lives - Help save Claudette	£24.99
Robot Monsters - Arcade Shoot Up	£19.99
5m City - Control your own city	£29.95

SOFTWARE - PRODUCTIVITY:

Neochrome - Art package	£29.99
1st Word - Word processor	£59.99
First BASIC - Programming lang	£49.99
ST Tour - Tutorial Disk	FREE
ANI ST - Animation Package	£29.95

PLUS! FREE FROM SILICA:

Silica Productivity Pack*	£44.99
TenStar Games Pack	£219.78

Total Value: £785.59
Less Pack Saving: £536.59
SILICA PRICE: £249.00

ATARI
1/2Mb RAM 520ST-E
DISCOVERY XTRA
WITH FREE GIFTS FROM SILICA
(SEE PANEL TO LEFT)

1/2Mb RAM INCLUDING UPGRADE TO **1Mb RAM**
£249 **£279**
Inc VAT - Ref: STC 6300 Inc VAT - Ref: STC 6311

ATARI ST MORE THAN JUST GREAT GAMES!

ATARI TT



- NEW LOW PRICE**
- 32-bit 32-bit 68030 Processor
 - 3 1/4" 1.44Mb Double Sided Disk Drive
 - 2/4Mb RAM Versions
 - Stereo 8-Bit PCM Sound Output
 - 4096 Colour Palette
 - Built-in 68882 Maths Co-Processor
 - Up to 1280 x 960 Resolution
 - VME + SCSI Expansion Ports
 - Expandable to 30Mb RAM
 - Hard Drive Expansion Options
 - FREE 16 Nights Holiday accommodation

2Mb RAM	4Mb RAM	8Mb RAM
£999	£1299	£1599

NEW! ATARI FALCON



The new Atari Falcon 030 is expected into stock soon. It is a powerful, versatile, multipurpose home computer, offering unmatched performance for its price. Included in its advanced specification are multiple co-processors for sound and graphics, true colour displays from a pallet of over a quarter of a million colours and 16-bit stereo sound input for speech recognition and sound sampling. These all combine to provide a new computer capable of running unrivalled sound, graphics and multimedia applications. The Falcon is an ideal upgrade for Atari ST owners who are looking for a more powerful model, as it is compatible with the majority of ST application software. Call for details of availability.

- 16-bit, 32-bit 68030 Processor
- 32-bit Motorola DSP and BLITTER co-processors
- DSP capabilities for voice recognition, speech synthesis and numerous audio special effects
- True colour display: 768 x 480
- 65,000+ colours on screen at once
- Record 8 channel, 16-bit stereo sound and play back 4 channel, 16-bit stereo simultaneously
- SCSI II, DMA, MIDI IN & MIDI OUT, Stereo audio & microphone ports
- 1.44Mb Floppy Disk
- 1, 4 or 14Mb RAM Configurations
- Optional 65Mb Hard Disk
- Built-in ADC & DAC converters

ATARI FALCON 030
16MHz 32-bit 68030 CPU, 1Mb RAM, 3 1/4" 1.44Mb FDD

HARDWARE:

1Mb RAM - 0Mb HD	£499
4Mb RAM - 0Mb HD	£699
4Mb RAM - 65Mb HD	£899

SOFTWARE:

- CALKPTT - Personal Information Manager
- Enhanced version of the Atari 520ST-E's
- PROCALC - Calculator
- SYSTEM-AUDIO-MANAGER - An Audio Filter
- Desk Accessory combination that allows the user to record sounds from a microphone and assign various system functions
- TALKING CLOCK - An advanced clock
- AUDIO FUN MACHINE - A revolutionary audio program using DSP
- LANDMINES & BREAKOUT - Two fully featured games

ATARI 1040ST-E



FREE GIFTS FROM SILICA WITH THIS PRODUCT
SEE TOP LEFT

NEW! REVISED PACK

MUSIC MASTER

This pack combines the 1040ST-E with the renowned MIDI package PRO 24 II to provide a perfect environment for novice and professional alike. Using any MIDI keyboard, PRO 24 offers the ability to write and compose music to a very high standard. You can record up to 24 tracks simultaneously, and then apply real time editing.

HARDWARE:

1040ST-E COMPUTER	£299.99
8MHz 16-bit 68000 CPU, 1Mb RAM, Mouse, TV Modulator, Internal PSU, 1Mb Disk Drive	

SOFTWARE:

PRO 24 II	£150.00
-----------	---------

PLUS! FREE FROM SILICA:

Silica Productivity Pack	£104.97
TenStar Games Pack	£219.78

Total Value: £774.74
Less Pack Saving: £475.74
SILICA PRICE: £299.00

£299
Inc VAT - Ref: STC 1261

FAMILY CURRICULUM II

HARDWARE:

1040ST-E COMPUTER	£299.99
8MHz 16-bit 68000 CPU, 1Mb RAM, Mouse, TV Modulator, Internal PSU, 1Mb Disk Drive	

SOFTWARE MODULES:

PLAY AND LEARN - A Game with Words and Sentences	£76.59
JUNIOR SCHOOL - Spelling, Primary Maths	£58.54
Answer Book General Knowledge Quiz	
GCSE - Micro Maths, French, and Geography Quiz	£55.54
HYPER PAINT - Full Colour Paint Package	£39.99
MUSIC MAKER II - Music Creation Software	£49.99
FIRST BASIC - Powerful Programming Language	£49.99
1st WORD - Very easy-to-use Word Processor	£59.99
ANI ST - Animation Package	£29.95

GAMES

9 LIVES - The ultimate in playability! - help Bob Cat save Claudette	£24.99
PRINCE - Do battle in this tenth century game of warfare	£24.95

PLUS! FREE FROM SILICA:

Silica Productivity Pack*	£44.99
TenStar Games Pack	£219.78

Total Value: £1035.27
Less Pack Saving: £736.27
SILICA PRICE: £299.00

£299
Inc VAT - Ref: STC 1272

NEW! 12" MONITOR FOR ST OWNERS



- 12" Greyscale Monitor
- Represents Colour in unlimited Shades of Grey
- Works in Low (320 x 200) + Medium (640 x 200) Resolution ST Modes
- Free High-Res (640 x 400) Emulation Software for ST-ST-E
- Stereo Speakers Built-in
- Small Footprint
- Case Colour Compliments ST Housing
- Tilt & Swivel Base Available (Ref: MOA 5500 - £15.99)
- Easy Access to Controls for Volume, Brightness, Contrast

The ViewTek VT12 12" Monitors offers high quality monitor output at an affordable price. It is ideal for text applications using the free high resolution emulation software supplied. It can also be used in low and medium resolution mode to produce stunning greyscale graphics for entertainment software. At only £69 (ref: MON 3012) the ViewTek VT12 offers exceptional value for money. And, when you buy a ViewTek monitor from Silica, we will give you a cable to connect it to your Atari ST FREE OF CHARGE! When ordering, please specify whether you have a ST-FM or an ST-E computer, so that the correct cable can be included free with your monitor.

FREE CABLE
Please Specify
STFM - Mono
CAB 5912
or
ST-E - Stereo
CAB 5920

£69
INC VAT - MON 3012

ALL PRICES INCLUDE VAT - FREE OVERNIGHT COURIER DELIVERY IN THE UK MAINLAND

SILICA SYSTEMS OFFER YOU

- **FREE OVERNIGHT DELIVERY:** On all hardware orders shipped in the UK mainland.
- **TECHNICAL SUPPORT HELPLINE:** Team of technical experts at your service.
- **PRICE MATCH:** We normally match competitors on a "Same product - Same price" basis.
- **ESTABLISHED 14 YEARS:** Proven track record in professional computer sales.
- **£12 MILLION TURNOVER (with 60 staff):** Solid, reliable and profitable.
- **BUSINESS + EDUCATION + GOVERNMENT:** Volume discounts available 081-308 0888.
- **SHOWROOMS:** Demonstration and training facilities at our London & Sidcup branches.
- **THE FULL STOCK RANGE:** All of your requirements from one supplier.
- **FREE CATALOGUES:** Will be mailed to you with offers - software and peripheral details.
- **PAYMENT:** Major credit cards, cash, cheque or monthly terms.

Before you decide when to buy your new computer, we suggest you think very carefully about WHERE you buy it. Consider what it will be like a few months after you have made your purchase, when you may require additional peripherals and software, or help and advice with your new purchase. And, will the company you buy from contact you with details of new products? At Silica Systems, we ensure that you will have nothing to worry about. We have been established for almost 14 years and, with our unrivalled experience and expertise, we can now claim to meet our customers' requirements with an understanding which is second to none. But don't just take our word for it. Complete and return the coupon now for our latest FREE literature and begin to experience the "Silica Systems Service".

MAIL ORDER: 1-4 The Mews, Hatherley Rd, Sidcup, Kent, DA14 4DX
Order Lines Open: Mon-Sat 9.05am-6.00pm
No Late Night Opening
Tel: 081-309 1111
Fax No: 081-308 0608

LONDON SHOP: 52 Tottenham Court Road, London, W1P 0BA
Opening Hours: Mon-Sat 9.30am-6.00pm
No Late Night Opening
Tel: 071-580 4000
Fax No: 071-323 4737

LONDON SHOP: Selfridges (1st Floor), Oxford Street, London, W1A 1AB
Opening Hours: Mon-Fri 9.30am-7.00pm (Sat close 6.30pm)
Late Night: Thursday - 8pm
Tel: 071-629 1234
Extension: 3914

SIDCUP SHOP: 1-4 The Mews, Hatherley Rd, Sidcup, Kent, DA14 4DX
Opening Hours: Mon-Sat 9.05am-6.00pm
Late Night: Friday - 7pm
Tel: 081-302 8811
Fax No: 081-309 0017

ESSEX SHOP: Keddies (2nd Floor), High Street, Southend-on-Sea, Essex, SS1 1LA
Opening Hours: Mon-Fri 9.30am-5.30pm (Sat 9.05am-6.00pm)
No Late Night Opening
Tel: 0702 468039
Fax No: 0702 462063

To: Silica Systems, AMACT-0393-79, 1-4 The Mews, Hatherley Rd, Sidcup, Kent, DA14 4DX

PLEASE SEND A BROCHURE ON THE ST RANGE

Mr/Mrs/Miss/Ms: Initials: Surname:

Company Name (if applicable):

Address:

Postcode:

Tel (Home): Tel (Work):

Which computer(s), if any, do you own?

79H

MAIL ORDER HOTLINE
081-309 1111

SILICA SYSTEMS

E&OE - Advertised prices and specifications may change - Please return the coupon for the latest information.

Subscribe to Action!

FREE

**when you
subscribe,
the Cheat
Mode II
book!**

- **POKE** games for extra lives, energy, time etc
- **CHEAT** your way through dozens of classic Amstrad games
- **EXPLORE** uncharted gaming territory with specially drawn game maps

First released three years ago, this book contains countless hints, cheats, tips, pokes and solutions for hundreds of CPC games.

Originally costing £9.99, this book is now available **FREE** to subscribers!

Complete the coupon and return it today. Alternatively, call our Credit Card Hotline on **0458 74011**

**YOUR
NO-QUIBBLE,
NO-RISK
GUARANTEE**

You can cancel your subscription at any time in the future and we will refund you in full for all unmailed issues.

You just can't lose out!

– the magazine that brings you
ALL THIS!

● **A superb covertape**

Packed with software including complete games, demos of new releases, serious utilities, readers programs and game cheats

● **Top game reviews**

We don't just give you an opinion, we give you **FACTS** – plus maps, annotated diagrams, tips and more info than you'll get anywhere else

● **Budget games latest**

Many top games are now being re-released at budget prices. We make sure you don't miss any

● **Game cheats**

Stuck in a game? Every month we print pages of tips, hints, help, cheats, passwords, maps and solutions sent in by our readers

● **The latest news**

New products, game previews, industry interviews, reader opinions and show news

● **Technical help**

Pages and pages of help, tips and info for those who want to do more than just play games... **PLUS** reviews of all the latest serious products

● **Top features**

On music, desktop publishing, games, art and more – all the background you need to getting the very best from your CPC

● **BASIC programming**

Learn how to use your machine's built-in programming system to write your own programs **AND** see what our readers can do in our Type-Ins section

...and there's much, much more!

IF YOU'VE GOT A CPC OR A PLUS, GET AMSTRAD ACTION!

Back Issues

Sold out! Issues 1-54, 56-65 • Still available! Issues 55, 66, 68, 71-81



Issue 82; On the tape: PowerPage and playable Lemmings demo. Inside: reviews of Lemmings and The Addams Family. Plus! Buyers' Guide to art packages.



Issue 83; A packed tape with Tetris game, music composer and a full game - Defenders Of The Earth. Inside: CPC bargains in France!



Issue 84; On the tape: Famous Five, the complete game. Inside! Review of Hideous, Virtual Reality special, the best 3D CPC games and colour printing special.



Issue 85; A look at music-making on the Amstrad, a WIMP interface and a PowerPage tutorial. On t'tape, two full games - On The Run and Link.



Issue 86; Feature on Alternative's kid's TV licences plus review of the Picasso art package. On the tape - Glider Rider (full game), MIDI demo and three utilities.



Issue 87; Inside - the complete history of Dizzy and review of the Amstrad NC100 notepad. And! Football Manager 3 reviewed. Full game of Nexor on the tape.



Issue 88; Two complete games on the tape - Tankbusters and Penguins. Inside, Videomaster, Robin Hood: Legend Quest and Crystal Kingdom Dizzy reviewed.



Issue 89; Inside - Buyers' Guide to disk drives, a look at CPC-stretching demos and Crazy Cars 3 reviewed. Plus! Wiggler and three great utilities on the covertape.

Amstrad Action Back Issues

Name _____

Address _____

Post code _____ Phone No _____

Method of payment (please tick)

Access Visa Cheque PO

Credit Card No _____

Expiry date _____

I would like the following back issues...

UK price original cover price • Europe £5 • Rest of the world £7 • Post and packing is £1 per order (regardless of size).

Please make all cheques payable in pounds sterling to Future Publishing Limited, and send the whole lot off to AA Bargain Basement, Future Publishing, FREEPOST, Somerton, Somerset TA11 7BR.

Fancy a holiday?

WIN A WEEKEND IN ROBIN HOOD COUNTRY! PLUS FIVE COPIES OF ROBIN HOOD: LEGEND QUEST!

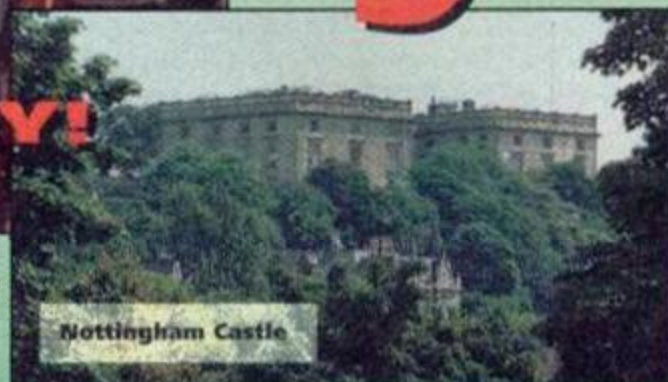

Nottingham Castle

Okay, hands up who's seen Robin Hood: Prince of Thieves? It's good, isn't it? Especially the bit where our Kevin swings through the burning trees and jumps on the baddies. That's all supposed to take place in Sherwood Forest, the very same forest that you could be wandering around if you win this rather ace competition.

Simply by filling in that coupon at the bottom of the page, a family of four are in with a winning chance to be taken on a guided tour of Nottingham, taking in the castle, the museums, the rather nice shops and the Tales of Robin Hood. The latter is a sort of interactive exhibition with all the smells, sights and sounds of mediaeval England. But that's not all! You'll also spend the weekend in one of Nottingham's many fine hotels, with breakfast and dinner thrown in. (Well, maybe more 'served' than 'thrown', actually!) And! You'll be taken around Sherwood forest itself. As an extra special treat you may get to meet the Sherrif of Nottingham. We can't promise anything cos he goes away a lot, but if he's in town we're sure he'll be dying to meet you! You don't go away empty-handed either, the City of Nottingham also mentioned some free gifts. Yum!

As runners-up prizes, we've got five copies of the Codies' *Robin Hood: Legend Quest*. A very smart prize indeed!

To be in with a chance of winning this fabulous family weekend away, all you have to do is answer the following question...

★ Which of the following is one of Nottingham's main roads?

- a) Friar Tuck Avenue
- b) Maid Marian Way
- c) Robin Hood Place

Write the answer on the coupon, stick it on to the back of a postcard or envelope and send it off to "I'm With The Bloke In The Green Jerkin", Compo Amstrad Action, 29 Monmouth Street, Bath, Avon BA1 2DL. All entries must be on the Ed's desk by the first of April, 1993.



Everywhere in Nottingham, you'll find reminders of Robin Hood.

The Rules

- ★ Employees of Future Publishing, CodeMasters and The City of Nottingham Council are barred from entering this compo.
- ★ All entries must be received by the first of April, 1993. Any entries that reach us after that date will, I'm afraid, be chucked in the bin.

(That's after we take the stamps off for charidee.)

- ★ Multiple entries are very naughty and not allowed.
- ★ The Editor's word is absolutely final.



Sherwood Forest - home of outlaws and also the place where Robin and Marian were married.

Robin Hood Compo

To: I'm With The Bloke In The Green Jerkin, Competitions, Amstrad Action, 29 Monmouth Street, Bath, Avon BA1 2DL

The answer is

My name is

My address is

..... Postcode

Public Image

TIM BLACKBOND wants it to be known that he lives in Barnsley and eats coal. We don't believe him, but here's his PD news anyway...

Adder

By Simon Walker

Available from PD Fun

This is a simple game based on the concept of an ever-growing snake. Hands up those who have heard of it before! The object of this game is to

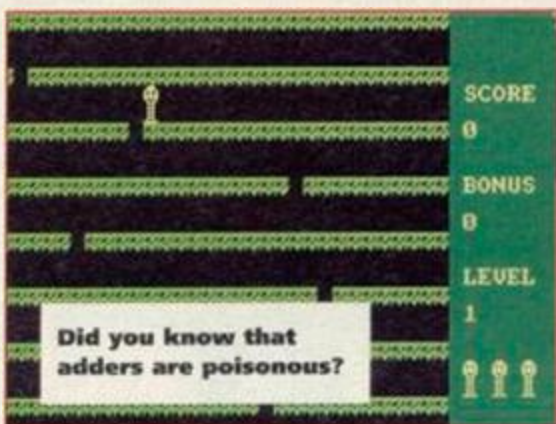

guide your snake around a screen (avoiding the walls), eating the snakey staple-diet – numbers! Each number appears on the screen one at a time and slowly counts down until it reaches zero when... it disappears. If you get to it fast enough, the appropriate number of segments will be added to your body. It starts off easy enough for a two year old to play it, but as you get better the game gets harder as it's difficult to move around with your back legs three miles away. (But snakes haven't got legs. Ed)

The graphics are simple, but then aren't all really lasting games simple in the visual department? Doubtless, this will keep you going for many moons to come.

78%

Spring On A Thing

By Frederick Nordakke

Not to be confused with the Gremlin game of almost the same name (*Thing On A Spring*), *Spring* is another one of those simple concept games to while away Sunday afternoons.

Spring has to get to the top of various multi-platform screens by leaping through the gaps that randomly appear on each row. The gaps wait for a few seconds before being replaced by

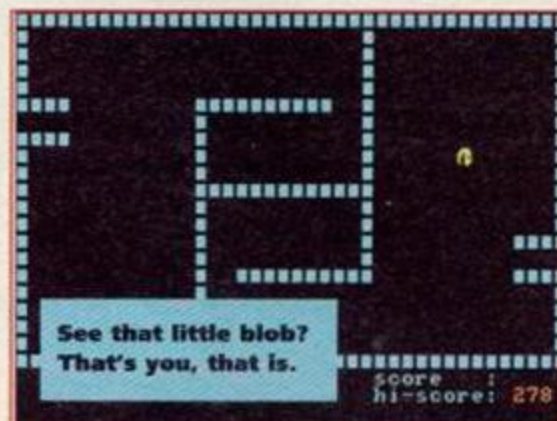

another hole somewhere else along the line. Sometimes it's possible to accidentally fall down a hole, in which case you'll have to climb back up again and waste valuable and limited time. Death awaits all those springs that are unfortunate enough to drop to the bottom row, so you'll have to be quick if you're to succeed.

Once you've passed the first level, you're treated to more of the same – except that arrows shoot across random rows, giving you something else to worry about. And that's about it. *Spring* will bring an hour or so of pleasure for the aforementioned Sunday afternoon, but it gets too repetitive for long-term enjoyment.

57%

Loose Talk

Amsof PD address presumed missing...

It's all very well to give a new library a huge plugging, but it all becomes so very, very pointless when the address is left out. (*Hear, hear! Ed*) This was exactly what happened in the case of Amsof PD last month. Just to set the record straight, here is that elusive address:

★ **Derek Hyland, Lyssanly, Cloyne, Middleton, Ireland**

Amstrad Users Unite

Apparently, the United Amstrad User Group has been running for several years, yet has been constantly ignored by that get who runs the AA Public Domain column. I'm sorry. Anyway, past offences aside, for a paltry £8 per year you get full membership including a bi-monthly fanzine, free Public Domain and a smashing postal-book

lending service. Write for more information to:

★ **UAUG, c/o Tony Baker, 26 Uplands Crescent, Fareham, Hampshire PO16 7JY**

Alive and kicking updates

After the exclusive AA review of Lee Rouane's fanzine, improvements have been made on the presentation front. Now, a font is used that actually has a lower case! The latest issue has no less than thirty-six pages filled with cheats, reviews and even tape-to-disk information. All this for a mere £1.20. Write to:

★ **Lee Rouane, 3 Causeway House, Kelstedge, Chesterfield S45 0DW**

Zap T' Balls: the untold story

There are a hell of a lot of angry people on the continent, particularly EGS after the game *Zap T' Balls* has been freely distributed around Britain. Well, apparently it isn't public domain,

Far from it, in fact. The only public domain version of *Zap T' Balls* is the one that only has five levels and comes with a preview of the Advanced Edition. This only leaves the problem of what is to be done with the many libraries that have it within their catalogues. The best advice would be to remove it, quickly...

A short public announcement...

Artificial Intelligence issue eight was released just before Christmas 1992 and as a consequence of the usual poor postal service around this time of year, I have received a few letters from people saying that they have not received a copy. If you have ordered, yet still not seen issue eight of AI, please write and tell me at:

★ **19 Lee Street, Liversedge, West Yorkshire WF15 6DZ**

You'll get a replacement copy and I'll know who's just trying to get a free one.

The mailbag

As the number of letters has dramatically picked up, I can't guarantee a personal answer, so don't waste a stamp by putting a sae in the envelope. Sorry an' all, but what can you do? Letters than cannot be answered in AA will almost certainly be in Artificial Intelligence!

NOWHERE TO ROAM

After reading a few issues of AA, various PD items have appealed to me. My problem is that I don't have the distributors' addresses. I would be grateful if you could send me some addresses, in particular that of Robot PD as *Power Tetris* looked really radical. Could you possibly tell me how much *Power Tetris* is?

Gregory Birchall
Coventry

No addresses printed last month! See what lack of space does to a man (lobby your MP for more PD pages now!). If you'll care to look elsewhere about this page, you'll find a number of addresses that will come in useful.

Robot PD is temporarily closed for re-organisation, so orders will be ignored until he can clear the backlog. The price of Power Tetris varies from library to library. The cheapest library in Britain is Sheepsoft at a mere 20p per disk side. AA

CUE VIOLINS, CUE SIMON BATES AND GET THE HANKIES!

I have been a subscriber to AA since issue one and was very pleased when a PD spot started. However, since then I have encountered nothing but problems. I do realise that these things are not out to make a profit, but I do not mind paying more for a better service.

I spied the *Print Enhancer* review and sent two disks to Presto at thier new Neath address (which, I believe, has moved again). I got no answer. Also, I sent a letter to Dartsma asking for some of their clip art. I enclosed a sae and got no reply.

I think that all the PD libraries that are plugged in AA should carry some kind of guarrantee that they will return orders, instead of just leaving readers without their disks.

Dave Wilkins
Northampton

Actually, I'm the one who has to take the blame for the Presto delay. I was meant to send Matt Gullam a copy of Print Enhancer, but due to a sudden barrage of other things, his copy was delayed. You were not the only one to be kept waiting - I am sorry.

I must say that, in principle, I agree with you - PD librarians should send disks back as soon as possible. But remember that it is simply no more than a hobby to most, seeing as no money is made. AA

WATER, WATER EVERYWHERE!

I am a boating enthusiast (when I can get away from my 6128!) and would like to get hold of a navigation program similar to PC *Wayplanner*. Does such a package exist for my machine?

John Haas
Essex

I have no knowledge of a boating navigation program on the CPC whatsoever, especially public domain! If anybody else does, feel free to tell me about it. AA

Postbox

For those of you who are interested in getting hold of more PD, here a few addresses to write off to. I'll have more for you next month, but I seem to have run out of room already!

ADVENTURE PD Debby Howard, 10 Overton Road, Abbey Wood, London SE2 9SD

DARTSMA PD Adam Shade, 47 Kidd Place, Charlton, London SE7 8HF

DEMON PD David Long, 47 Hillton Avenue, Birmingham B28 OPE

DOMAIN PD Graeme Chesser, 44 Echline Grove, S Queensferry EH30 9RU

G.D. PD Dave & Ged Lawson, 49 Woodville, Barnstaple, N Devon EX31 2HL

WORLD PD E Williams, 111 Riverside Road, Orewa, New Zealand

Fanzine review extra!

If you run a fanzine, no doubt it could do with a good plugging, especially if it wasn't mentioned in the last fanzine round-up in *Amstrad Action*. Send me a copy and I'll return a sparkly copy of AI for your troubles and a review. You can't say fairer than that!

Eurostrad

Editor: La Redaction ■ Issue Two: £1 ■ UK: Malcolm Smith, 2 Baily Place, Moray, Scotland IV31 6RW ■ France: Thomas Fournier, La Hemelinere, 50450 Hambye ■ Espana: Manuel Laorden Mas, Valldemosa 64, Entlo 2, 08016 Barcelona

Eurostrad claims to be the first European fanzine for the Amstrad CPC. Well, that's what it says on the cover so it must be true. It's a twelve-page A4 fanzine, bound together with one staple in the top-left-hand corner of the page and is written in no less than three languages, these being English, French and Spanish. There should be no disappointments here as I'll bet every reader has a firm grasp on at least one of these dialects.

So what's actually in the mag, then? Firstly, there's a British fanzine round-up of which some rag with the name Artificial Intelligence comes out on top of three others with a spanking nine point five out of ten! I think I'll be buying a copy of that fanzine very soon indeed! (*That's enough AI, Ed*)

Quite a lot of it is actually in English, and there's a round-up of several British PD libraries, as well as a brief look at French fanzines and a short article on piracy in the United Kingdom.

Unfortunately, no matter how interested you are on the subject, you'll be none the wiser if you can't speak French.

The presentation is good, although in some areas a font is used that is both small and completely upper case. True, if you want a full-English read, this may not be the one for you but is still a very interesting read. It even has a Smurf on the cover!

78%

Amstrad Express

Editor: Salman Sandhu ■ Issue One: 50p + disk ■ Salman A Sandhu, 17 Cromer Road, London SW17 9JN

Take a look at any French or German disk-fanzine and you'll be astounded at the amazing mix of both graphics and music. Now, stop that and move to Britain. Firstly we have CPC Domain which, and let's be fair, is an example of what not to do with a disk fanzine. Amstrad Express, I'm sorry to say, takes this concept one step further.

The entire magazine spans two sides of a disk. The contents are little more than uncompressed screen files (some of which are ripped straight from computer games) and ASCII text files, bound together with a simple menu system. Oh well, the presentation would have anybody vomiting in loathing and disgust, but it's the content that counts. Isn't it?

Unfortunately, this bit's pretty much the same. There's also some POKEs and keypress cheats (the *TMH Turtles* POKE I'm sure used to be in AA) and an adverts section which is a collection of

badly drawn screens for WAVE.

There is a good point to the magazine, and you'll be glad to know it's a great one: The Special Offers section. This includes a wide range of software and hardware going at low prices. For example, a GX4000 can be snapped up for £25.

I suppose for 50p and a disk, it isn't too much to ask but when the ASCII reader system does little more than list a file, you might as well import the text into PowerPage 128 or a less-effective DTP.

25%

Next month

Okay, so Rogues Gallery has been left out again! WHAT! So have the charts! It's a disgrace! But don't worry yourselves, they'll both return next month along with more letters and reviews of two more fanzines, namely the United Amstrad User Group magazine and Amstrad Fun. In the meantime you can write to me at **Public Image, Amstrad Action, 30 Monmouth Street, Beauford Court, Bath, Avon BA1 2BW**. Thank you for listening, good night.

GAMESMASTER

THE GREATEST SHOW ON TV...

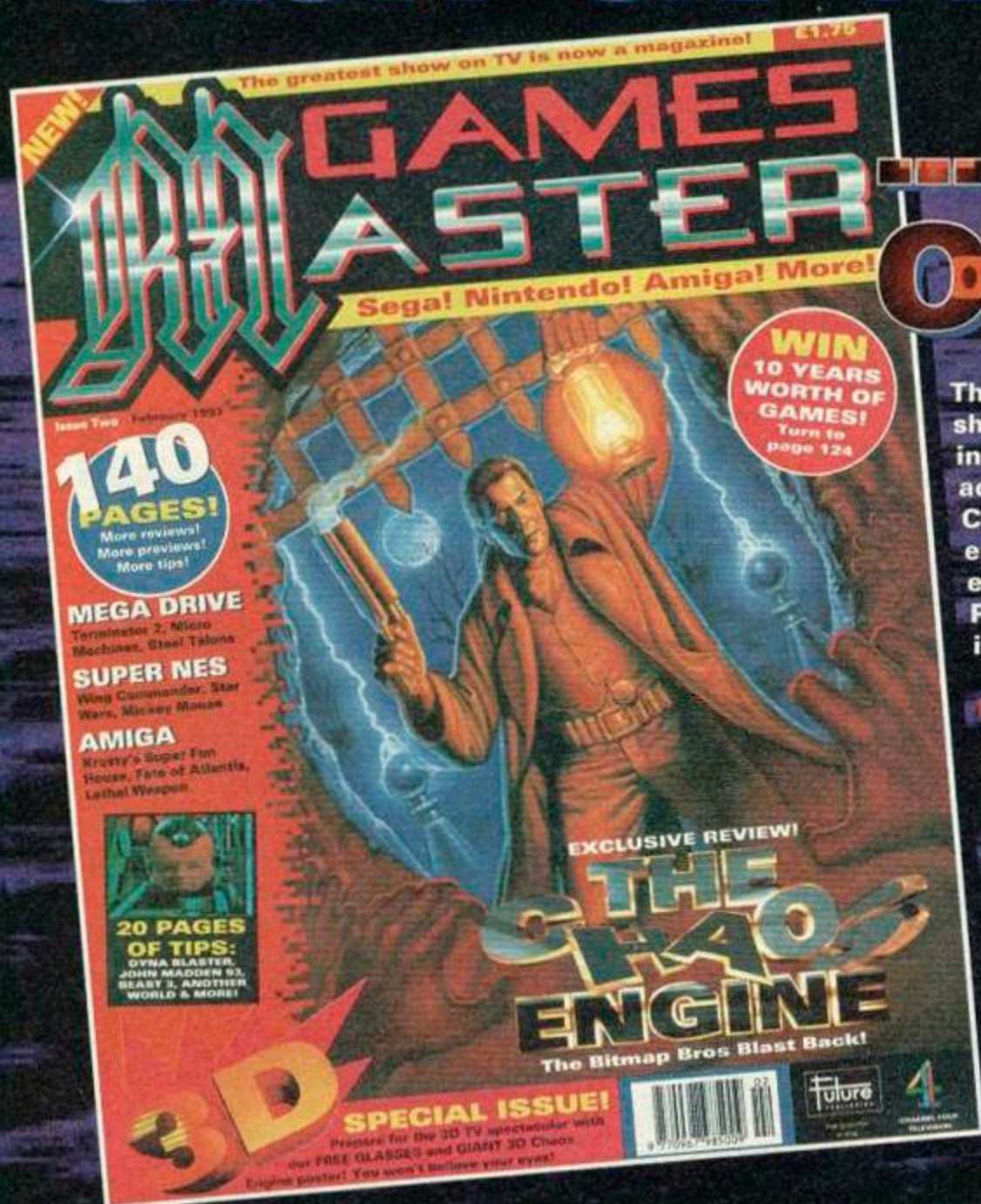

... IS NOW ON PAPER!

The second issue of GamesMaster is in the shops on Thursday January 21st, and it's incredible! Guiding you swiftly, gently and accurately through the storm of post-Christmas software releases for every major entertainment system, GamesMaster is the essential purchase for today's video gamer. Particularly excellent highlights this month include:

- A **FREE** pair of 3D glasses, with which you can view the thrilling GamesMaster 3D TV Spectacular!
- A **GIANT** Chaos Engine poster with 3D bits on it from the TV Show.
- The chance for 10 winners to collect **A YEAR'S WORTH OF FREE GAMES!**

SECOND ISSUE IS ON SALE THURSDAY 21ST JANUARY

MEGA DRIVE, SUPER NES, AMIGA, NEO GEO, PC ENGINE, MEGA CD, GAME BOY, GAME GEAR AND LYNX!



**Price
Buster**

PUBLIC APOLOGY

**Fast 7 day
delivery***

WE WOULD LIKE TO APOLOGISE TO MAIL ORDER CUSTOMERS WHO HAVE ORDERED FROM OTHER FIRMS AND HAVE BEEN DISAPPOINTED. PRICEBUSTER WILL RESTORE YOUR FAITH.

Amstrad Sellers	Cass	Disk
ADDAMS FAMILY	£8.99	£12.99
DIZZY CARTOONS	£7.50	N/A
DIZZY COLLECTION	£7.50	N/A
DIZZY'S EXCELLENT ADVENTURES	£7.50	N/A
Fun School 4 Range (State age)	£9.99	£12.99
Hero Quest	£4.99	N/A
LINEKER COLLECTION	£7.50	N/A
Mega Hot (8 titles)	£4.50	N/A
SPACE CRUSADE	£7.50	£10.99
Streetfighter 2	£9.99	£14.99
Superfighters (WWF, Final Fight, Pitfighter)	N/A	£15.99
Too Hot To Handle	£12.99	N/A
DREAM TEAM (WWF, TERMINATOR 2, THE SIMPSONS)	£10.99	£15.99

BUDGET	Ghosts & Ghosts	Go for Gold
3D International Tennis	£3.99	NEW £3.99
3D Pool	£3.99	NEW £3.99
Aerobot	NEW £3.99	£3.99
Airborne Ranger	£3.99	NEW £3.99
American Tag Team	£3.99	NEW £3.99
Wrestling	NEW £3.99	NEW £3.99
Atlantis 4 Pack	£3.99	NEW £3.99
Bad Lands	NEW £3.99	£3.99
Batman the Movie	£3.99	£3.99
Bubble Bobble	£3.99	£3.99
Bubble Dizzy	£3.99	£3.99
California Games	£3.99	£3.99
Captain Dynamo	NEW £3.99	£3.99
Castlemaster	NEW £3.99	£3.99
Championship Golf	£3.99	£3.99
Crackdown	NEW £3.99	£3.99
Cyberball	NEW £3.99	£3.99
Dizzy Down The Rapids	£3.99	£3.99
Dizzy Panic	£3.99	£3.99
Dizzy Prince of York	£3.99	£3.99
Folk	NEW £3.99	£3.99
Dragons of Flame	£3.99	£3.99
Dragon Spirit	£3.99	£3.99
Escape from Planet of the Robot Monsters	£3.99	£3.99
F-15 Strike Eagle	NEW £3.99	£3.99
F-16 Combat Pilot	£3.99	£3.99
Fantasy World Dizzy	£3.99	£3.99
First Past The Post	£3.99	£3.99
Footballer of the Year 2	£3.99	£3.99
Fimbo's Quest	NEW £3.99	£3.99
Fun School 2 Range (state age)	NEW £3.99	£3.99
Ghostbusters II	£3.99	£3.99

Pit Fighter	NEW £3.99	Super Off Road	£3.99
Pro Tennis Tour	£3.99	Super Seymour	£3.99
Puffy's Saga	£3.99	Switchblade	£3.99
Quattro Fantastic	£3.99	Swiv	NEW £3.99
Quattro Fighters	£3.99	Sword of the Samurai	NEW £3.99
Quattro Skills	£3.99	Terminator 2	NEW £3.99
Quattro Sports	£3.99	The Match	£3.99
Quattro Power	£3.99	The National	£3.99
Quattro Adventure	£3.99	Toobin'	£3.99
Quattro Coin Ops	£3.99	Total Recall	NEW £3.99
Quattro Arcade	£3.99	Treasure Island Dizzy	£3.99
Quattro Combat	£3.99	Treble Champions	£3.99
Quattro Cartoon	£3.99	Trivial Pursuit	NEW £3.99
Quattro Firepower	£3.99	Turbo Outrun	£3.99
Quattro Racers	£3.99	Turbo The Tortoise	NEW £3.99
Quattro Superhits	£3.99	Turrican	£3.99
RBF2 Baseball	NEW £3.99	Turrican II	£3.99
Rainbow Islands	£3.99	Tusker	£3.99
Red Heat	£3.99	Vendetta	£3.99
Robin Hood Legend	£3.99	Wild West Seymour	NEW £3.99
Quest	NEW £3.99	X-Out	£3.99
Robocop	£3.99		
Rick Dangerous	£3.99		
Rick Dangerous 2	NEW £3.99		
Shadow of the Beast	£3.99		
Seymour goes to Hollywood	NEW £3.99		
Shadow Warriors	£3.99		
Silent Service	£3.99		
Sly Spy	£3.99		
Smash TV	NEW £3.99		
Snooker Management	£3.99		
Soccer Double 2	£3.99		
Soccer Double 3	£3.99		
Soccer Rivals	£3.99		
Spy Who Loved Me	£3.99		
Spellbound Dizzy	NEW £3.99		
ST Dragon	£3.99		
Streetfighter	NEW £3.99		
Strider	£3.99		
Strider 2	NEW £3.99		
Striker in the Crypt	£3.99		
Stun Runner	NEW £3.99		
Stunt Car Racer	£3.99		
Supercars	£3.99		
Sturman Seymour	NEW £3.99		
Super Monaco GP	NEW £3.99		

STOP PRESS

Great New Budget Titles for March and April:

Shadow Dancer	£3.99
Sargeant Seymour	£3.99
Robot Cop	£3.99
WWF Wrestlemania	£3.99
The Simpsons	£3.99
Super Space Invaders	£3.99
April	
Mercs	£3.99
Rodland	£3.99
Final Fight	£3.99
Darkman	£3.99

SPECIAL OFFERS

CRYSTAL KINGDOM DIZZY	Cass £7.99
FIREHAWK	Cass £7.99
SUPERSTAR SEYMOUR	Cass £9.99

NIGEL MANSELLS WORLD CHAMPIONSHIP Cass £8.99

*Subject to availability
Release dates of new titles are subject to change by the manufacturer

**CALL US ON 24 HOUR
CREDIT CARD HOTLINE
021 440 4108**
Please state name, card number, expiry date & goods required

ORDER FORM AND INFORMATION. All orders sent FIRST CLASS subject to availability. Just fill in the coupon and send it to: PRICEBUSTER Unit 23, 14/20 George Street, Birmingham B12 9RG

BLOCK CAPITALS	Name of game	Computer	Value
Name:			
Address:			
Postcode:			
Tel. No:			
POSTAGE RATES: Please add 50p p&p on all orders. EEC countries add £1.00 per item. Non EEC countries add £2.50 per item. Cheques payable to: Price Buster (Sterling only)			Postage
			Total

ROMBO DISCOUNTS

ROMBO ROMBOARD Now only £25.00

The most widely used of all Romboards. 8 sockets; on/off switch for each; high 8 or low 8 ROM slots selectable; facility for a ZIF socket or 16k RAMROM.

DISCOUNTS
20% - with the Dual-Mode Drive
10% - with ROM software valued at £20 or more.

EPROM PROGRAMMER with eject socket - £30

Programs 8k, 16k, 32k, 12.5v, 21v, CMOS, non-CMOS eproms; all or part eprom copying; supplied with its software on ROM and a disc; a PD games ROM file, utility to turn Basic and m/code programs into ROM programs, instructions on ROM layout and using 32k eproms to double a romboard's capacity.

32k RAMROM - £13.95

32k of RAM in two 16k blocks. Each behaves like a ROM, surviving resets, when loaded with ROM software. Ideal for testing ROM programs without the need to blow/erase eproms.

ROMBO VIDEO DIGITISER Now only £65.00

Captures video pictures from a video recorder, camera or TV with 'video out' to computer memory. Manipulate pictures, save to disc, use in programs, print out, etc.

ROMONOFF SWITCH - £7.95

Connects to the expansion port to turn all external ROMs OFF or ON as needed. Not suitable for a 464 with disc drive.

3 1/2" DUAL-MODE DRIVE

Includes:-
* MS800 on disc * MS800 on ROM
* 10 blank discs * carriage

Our superior drives do everything that all other 3.5" drives do - and more besides!

CHECK OUT THESE FEATURES:-
MODE 2: Full, unimpeded use with Rodos, Ramdos, Romdos and Romdos XL giving up to 800k per disc without the need to use the SIDE SWITCH. The statement elsewhere that "other drives... will only allow you to access 400k at a time" is a lie as many who have resorted to adding their own side switch to inferior drives can confirm. Full use of MS800, the no.1 high capacity formatter - 800k per disc at 400k per side. MODE 1: works as a complete alternative to the FD1 B drive - 180k per side. Without the side switch, mode 1 is not possible.
OVERALL: Ultra quiet TEAC mechanism, the type used in most professional computers; super small; separate power supply; sleek metal case. You need to buy nothing else to use your drive immediately. MS800 is supplied on disc and ROM whether or not you have a Romboard - see the ROMBO DISCOUNTS.

464 PLUS 1st drive - see this ad.
Old 464 1st drive - not suitable.
Please state your computer model when ordering.

**£79.95
complete**

MS800 is the number one high capacity formatter, allowing up to 800k storage per 3.5" disc. It is the ONLY one that doesn't need to be present for its discs to be used, the ONLY one that is compatible with all software including CPM, the ONLY one that uses no memory whatsoever, the ONLY one that can use its discs in drive A (ABBA switch users, please note), the ONLY one that works with the Plus machines. It is supplied with its own copying utility and a menu program that allows many tape to disc transferred games to run from drive B. Check these features against any alternative and you'll see why MS800 is simply the best.
MS800 disc or ROM 9.95
MS800 disc and ROM 14.95
ROM for disc owners (proof needed) 5.50

464 PLUS 1st DRIVE - £120 under

BONZO SUPER MEDDLER

Exceptionally good tape to disc transfer utility, very large on-disc database of verified transfers. Produces stand-alone transfers.

BONZO BLITZ

Transfers all varieties of SPEEDLOCK tapes onto disc, producing stand-alone transfers. On-disc database of verified transfers. Includes 4 adventure games - FREE!

BONZO'S FLASHPACK

Over 60 additions to Basic, some very powerful. Flash Basic's commands can be used within your own Basic programs but it does not need to be present for the programs to run!

MAXIDOS

The most comprehensive and effective general disc utility available for the CPC. All features work with Amados, CPM, Ramdos and Romdos. Includes: disc/file copy, disc optimise, CAT inc. erased files, restore erased files, disc editor and much much more.

BONZO'S BIG BATCH

Fast, flexible Database; superb pools predictor; screen and sprite designer.

SUPER MEDDLER	13.95
BLITZ	13.95
FLASHPACK	9.95
BIG BATCH	9.95
MAXIDOS	13.95

ROM SOFTWARE

PROTEXT	£30	UTOPIA	£25
PROSPELL	£25	MAXAM	£30
PROMERGE	£25	MAXAM 1.5	£25
PD GAMES ROM (2 games)	£3.50		
6128 UPGRADE ROM			
Supplied with full fitting instructions	£24.95		

3rd DRIVE SWITCH	12.95
ABBA SWITCH	12.95
SIDE SWITCH (kit)	3.00
SIDE SWITCH (plug-on)	5.95
ABBA & SIDE combined	14.95
DRIVE ADAPTERS	various
ROMDOS (ROM only)	9.95
Amstrad FD1 3" B drive	79.95
3" Amsoft discs (10)	20.00
3.5" discs (10)	7.50
3" individual disc case (10)	5.95
3.5" locking disc box (40)	7.95

The switches, which can be daisy-chained, plug onto the 6128 or 664 drive port and the drive(s) plug onto the switches. The 3rd DRIVE SWITCH allows 2 external drives to be connected and selected at will. B to B copying is OK. The ABBA switch logically swaps the internal and external drives around so that A becomes B and vice versa. The SIDE SWITCH gives the Dual-Mode feature to a double headed drive. DRIVE ADAPTERS allow CPC drives to be used on other machines, e.g. PC, PCW, ST, Amiga.

**DUAL CHANNEL
RS-232**
£39.95
with software

464/6128 PLUS

Low cost INTERNAL disc/memory upgrades

	D.I.Y. kit	Done by us
464 PLUS Extra 64k Disc interface*	15.00	25.00
6128 PLUS Tape with remote (tape recorder not included)	18.00	30.00

* Together with the 3.5" drive, this is the lowest costing 1st drive by a very wide margin.

Please write or phone for details before sending your computer.

AVATAR
Phone: 0442 251705

39 CROSSFELL ROAD, LEVERSTOCK GREEN,
HEMEL HEMPSTEAD, HERTS. HP3 8RG
Monday to Friday

**MAJOR CREDIT
CARDS TAKEN**
No callers please

TROJAN PHAZER GUN FOR GX4000/464+/6128+

(RRP £34.99) OUR PRICE £29.99

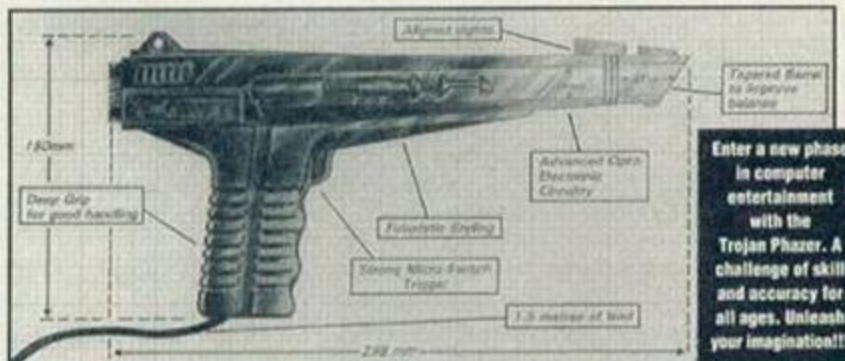

Enter a new phase in computer entertainment with the Trojan Phazer. A challenge of skill and accuracy for all ages. Unleash your imagination!!!

Phazer Gun plugs straight into analogue port (next to joystick port). Comes complete with SKEET SHOOT CARTRIDGE.



SKEET SHOOT consists of 6 levels, each broken up into two normal rounds and one bonus round. See games review in Amstrad Action - Feb '93

ENFORCER CARTRIDGE. Your job is to gun down the bad guys as they pop up, but not civilians. PRICE £14.99



AMSTRAD GAME CARTRIDGES FOR 6128+/464+/GX4000

TITLE	BOXED WITH INSTRUCTIONS	UNBOXED NO INSTRUCTIONS
Klax	£24.99	£14.99
Pro Tennis Tour	£24.99	£14.99
Batman	£24.99	£14.99
Operation Thunderbolt	£24.99	£14.99
Barbarian II	£24.99	£14.99
Navy Seals	£24.99	£14.99
Robocop II	£24.99	£14.99
Pang	£24.99	£14.99
Switch Blade	£24.99	£14.99
No Exit	£24.99	£14.99

* Special offers: 10 Unboxed games (all different) £100.00 *
Amstrad GX4000 Games Consoles with free game £59.99
Amstrad Paddle Controller £8.99
Burnin' Rubber + Locomotive Basic Cartridge £19.99

AMSTRAD 464 AND 6128 - GENERAL

Amstrad MP3 Modulator/TV Tuner, for use with CTM644 monitor	£29.99
Amstrad 464 Light Gun & Games Cassette	£19.99
Amstrad 6128 Light Gun & Games Disk	£19.99
Amstrad CT1 Clock Radio	£14.99
Amstrad CPC464 Cassette Mechanism with tape head and motor	£29.99
Amstrad 464 Head Alignment Tapes	£9.95
Tape Head Demagnetizer	£9.99

Prices include VAT, postage and packing

All orders by return: Cheques/Visa/Access/POs
Tel/Fax (0952) 462135
TRADING POST, Victoria Road, Shifnal, Shropshire TF11 8AF

O.J. SOFTWARE
Fast Friendly Service

(0257) 421915

(0257) 421915

ADVENTURE	COMPILATIONS	EDUCATION	PRINTERS																																																																																																																												
<table border="1" style="width: 100%; border-collapse: collapse;"> <thead> <tr> <th>CASS</th> <th>DISK</th> </tr> </thead> <tbody> <tr><td>Achelon</td><td>£11.95</td></tr> <tr><td>Avon (with Murdoc)</td><td>£11.95</td></tr> <tr><td>Countdown to Doom</td><td>£11.95</td></tr> <tr><td>Return to Doom</td><td>£11.95</td></tr> <tr><td>Last Days of Doom</td><td>£15.95</td></tr> <tr><td>Kingdom of Hamil</td><td>£11.95</td></tr> <tr><td>Philosophers Quest</td><td>£11.95</td></tr> <tr><td>Hero Quest + Ret W/Lord</td><td>£10.95 £14.95</td></tr> <tr><td>War in Middle Earth</td><td>£6.99</td></tr> <tr><td>Famous Five on Tr. Island</td><td>£9.50 £11.95</td></tr> <tr><td>Giant Killer Maths Adventure</td><td>£15.95</td></tr> </tbody> </table>	CASS	DISK	Achelon	£11.95	Avon (with Murdoc)	£11.95	Countdown to Doom	£11.95	Return to Doom	£11.95	Last Days of Doom	£15.95	Kingdom of Hamil	£11.95	Philosophers Quest	£11.95	Hero Quest + Ret W/Lord	£10.95 £14.95	War in Middle Earth	£6.99	Famous Five on Tr. Island	£9.50 £11.95	Giant Killer Maths Adventure	£15.95	<table border="1" style="width: 100%; border-collapse: collapse;"> <thead> <tr> <th>CASS</th> <th>DISK</th> </tr> </thead> <tbody> <tr><td>2 HOT 2 HANDLE: Golden Axe, Sup. Off Rd, Tot. Recall, Shad. Warriors</td><td>£12.95 £15.95</td></tr> <tr><td>FISTS OF FURY: Shinobi, Double Dragon II, Ninja Warriors, Dyn. Dux</td><td>£9.99</td></tr> <tr><td>HOLLYWOOD COLLECTION: Brian Movie, Robocop, G. Busten II, I. Jones L.C.</td><td>£11.95 £15.95</td></tr> <tr><td>DREAM TEAM: Terminator II, Simpsons, WWF Wrestlingmania</td><td>£15.95</td></tr> <tr><td>MEGA SPORTS: 30+ Sporting Events</td><td>£15.95</td></tr> <tr><td>MINDSTRETCHERS: Monopoly, Scrabble, Cluedo</td><td>£12.95</td></tr> <tr><td>SUPERFIGHTER: Final Fight, WWF Wrestlingmania, PaFighter</td><td>£15.95</td></tr> <tr><td>SOCCER STARS: Kick Off II, Gazza II, Emlyn Hughes, Microprose Soccer</td><td>£11.95 £15.95</td></tr> </tbody> </table>	CASS	DISK	2 HOT 2 HANDLE: Golden Axe, Sup. Off Rd, Tot. Recall, Shad. Warriors	£12.95 £15.95	FISTS OF FURY: Shinobi, Double Dragon II, Ninja Warriors, Dyn. Dux	£9.99	HOLLYWOOD COLLECTION: Brian Movie, Robocop, G. Busten II, I. Jones L.C.	£11.95 £15.95	DREAM TEAM: Terminator II, Simpsons, WWF Wrestlingmania	£15.95	MEGA SPORTS: 30+ Sporting Events	£15.95	MINDSTRETCHERS: Monopoly, Scrabble, Cluedo	£12.95	SUPERFIGHTER: Final Fight, WWF Wrestlingmania, PaFighter	£15.95	SOCCER STARS: Kick Off II, Gazza II, Emlyn Hughes, Microprose Soccer	£11.95 £15.95	<table border="1" style="width: 100%; border-collapse: collapse;"> <thead> <tr> <th>CASS</th> <th>DISK</th> </tr> </thead> <tbody> <tr><td>Fun School I Under 5</td><td>£8.95</td></tr> <tr><td>Fun School I 5-8</td><td>£8.95</td></tr> <tr><td>Fun School I 8-12</td><td>£8.95</td></tr> <tr><td>Fun School II or IV 5</td><td>£10.95 £13.95</td></tr> <tr><td>Fun School III or IV 5-7</td><td>£10.95 £13.95</td></tr> <tr><td>Fun School III or IV 7-11</td><td>£10.95 £13.95</td></tr> <tr><td>Lets Play with Words 4-8</td><td>£12.95 £12.95</td></tr> <tr><td>Fun with Words 7</td><td>£8.50 £11.95</td></tr> <tr><td>Read Right Away 1 5-8</td><td>£9.95 £12.95</td></tr> <tr><td>Read Right Away 2 6-9</td><td>£9.95 £12.95</td></tr> <tr><td>Read Right Away 3 7+</td><td>£9.95 £12.95</td></tr> <tr><td>Better Spelling 9+</td><td>£8.95 £12.95</td></tr> <tr><td>Lets Play Numbers 4-8</td><td>£12.95 £12.95</td></tr> <tr><td>Lets Play Money 4-8</td><td>£12.95 £12.95</td></tr> <tr><td>Primary Maths 3-12</td><td>£24.95 £24.95</td></tr> <tr><td>Fun with Numbers 7</td><td>£8.50 £11.95</td></tr> <tr><td>Target Maths 6-13</td><td>£12.95</td></tr> <tr><td>Micro Maths 9-16</td><td>£24.95 £24.95</td></tr> <tr><td>Better Maths 12-16</td><td>£8.95 £12.95</td></tr> <tr><td>Mega Maths 15+</td><td>£24.95 £24.95</td></tr> <tr><td>Biology 1 12-16</td><td>£8.95 £12.95</td></tr> <tr><td>Chemistry 1 12-16</td><td>£8.95 £12.95</td></tr> <tr><td>Physics 1 12-16</td><td>£8.95 £12.95</td></tr> <tr><td>French Mistress 11+</td><td>£15.95</td></tr> <tr><td>German Master 11+</td><td>£15.95</td></tr> <tr><td>Spanish Tutor 11+</td><td>£15.95</td></tr> <tr><td>Micro English 8-Ad</td><td>£24.95 £24.95</td></tr> <tr><td>The Three Bears 5+ (6128)</td><td>£12.95</td></tr> <tr><td>Five on Treasure Island</td><td>£9.50 £11.95</td></tr> <tr><td>Granny's Garden 6-10 (6128)</td><td>£16.95</td></tr> <tr><td>Dragon World 6-10 (6128)</td><td>£20.95</td></tr> <tr><td>Giant Killer Maths Adv 9-14</td><td>£15.95</td></tr> <tr><td>Answer Back Jr Quiz 6-11</td><td>£11.95</td></tr> </tbody> </table>	CASS	DISK	Fun School I Under 5	£8.95	Fun School I 5-8	£8.95	Fun School I 8-12	£8.95	Fun School II or IV 5	£10.95 £13.95	Fun School III or IV 5-7	£10.95 £13.95	Fun School III or IV 7-11	£10.95 £13.95	Lets Play with Words 4-8	£12.95 £12.95	Fun with Words 7	£8.50 £11.95	Read Right Away 1 5-8	£9.95 £12.95	Read Right Away 2 6-9	£9.95 £12.95	Read Right Away 3 7+	£9.95 £12.95	Better Spelling 9+	£8.95 £12.95	Lets Play Numbers 4-8	£12.95 £12.95	Lets Play Money 4-8	£12.95 £12.95	Primary Maths 3-12	£24.95 £24.95	Fun with Numbers 7	£8.50 £11.95	Target Maths 6-13	£12.95	Micro Maths 9-16	£24.95 £24.95	Better Maths 12-16	£8.95 £12.95	Mega Maths 15+	£24.95 £24.95	Biology 1 12-16	£8.95 £12.95	Chemistry 1 12-16	£8.95 £12.95	Physics 1 12-16	£8.95 £12.95	French Mistress 11+	£15.95	German Master 11+	£15.95	Spanish Tutor 11+	£15.95	Micro English 8-Ad	£24.95 £24.95	The Three Bears 5+ (6128)	£12.95	Five on Treasure Island	£9.50 £11.95	Granny's Garden 6-10 (6128)	£16.95	Dragon World 6-10 (6128)	£20.95	Giant Killer Maths Adv 9-14	£15.95	Answer Back Jr Quiz 6-11	£11.95	<p>All printers listed below are suitable for use with AMSTRAD CPC, ATARI ST, COMMODORE AMIGA, IBM PC & COMPATIBLES</p> <p>When ordering please state computer</p> <table border="1" style="width: 100%; border-collapse: collapse;"> <tbody> <tr><td>CITIZEN 120D + 9 Pin Mono</td><td>£139.95</td></tr> <tr><td>STAR LC20 9 Pin Mono</td><td>£149.95</td></tr> <tr><td>STAR LC100 9 Pin Mono/Col</td><td>£189.95</td></tr> <tr><td>STAR LC24-20 24 Pin Mono</td><td>£209.95</td></tr> <tr><td>STAR LC24-100 24 Pin Mono</td><td>£219.95</td></tr> <tr><td>STAR LC24-200 24 Pin Mono</td><td>£259.95</td></tr> <tr><td>STAR LC24-200 24 Pin Mono/Col</td><td>£289.95</td></tr> </tbody> </table> <p>All prices include cable & delivery</p>	CITIZEN 120D + 9 Pin Mono	£139.95	STAR LC20 9 Pin Mono	£149.95	STAR LC100 9 Pin Mono/Col	£189.95	STAR LC24-20 24 Pin Mono	£209.95	STAR LC24-100 24 Pin Mono	£219.95	STAR LC24-200 24 Pin Mono	£259.95	STAR LC24-200 24 Pin Mono/Col	£289.95
CASS	DISK																																																																																																																														
Achelon	£11.95																																																																																																																														
Avon (with Murdoc)	£11.95																																																																																																																														
Countdown to Doom	£11.95																																																																																																																														
Return to Doom	£11.95																																																																																																																														
Last Days of Doom	£15.95																																																																																																																														
Kingdom of Hamil	£11.95																																																																																																																														
Philosophers Quest	£11.95																																																																																																																														
Hero Quest + Ret W/Lord	£10.95 £14.95																																																																																																																														
War in Middle Earth	£6.99																																																																																																																														
Famous Five on Tr. Island	£9.50 £11.95																																																																																																																														
Giant Killer Maths Adventure	£15.95																																																																																																																														
CASS	DISK																																																																																																																														
2 HOT 2 HANDLE: Golden Axe, Sup. Off Rd, Tot. Recall, Shad. Warriors	£12.95 £15.95																																																																																																																														
FISTS OF FURY: Shinobi, Double Dragon II, Ninja Warriors, Dyn. Dux	£9.99																																																																																																																														
HOLLYWOOD COLLECTION: Brian Movie, Robocop, G. Busten II, I. Jones L.C.	£11.95 £15.95																																																																																																																														
DREAM TEAM: Terminator II, Simpsons, WWF Wrestlingmania	£15.95																																																																																																																														
MEGA SPORTS: 30+ Sporting Events	£15.95																																																																																																																														
MINDSTRETCHERS: Monopoly, Scrabble, Cluedo	£12.95																																																																																																																														
SUPERFIGHTER: Final Fight, WWF Wrestlingmania, PaFighter	£15.95																																																																																																																														
SOCCER STARS: Kick Off II, Gazza II, Emlyn Hughes, Microprose Soccer	£11.95 £15.95																																																																																																																														
CASS	DISK																																																																																																																														
Fun School I Under 5	£8.95																																																																																																																														
Fun School I 5-8	£8.95																																																																																																																														
Fun School I 8-12	£8.95																																																																																																																														
Fun School II or IV 5	£10.95 £13.95																																																																																																																														
Fun School III or IV 5-7	£10.95 £13.95																																																																																																																														
Fun School III or IV 7-11	£10.95 £13.95																																																																																																																														
Lets Play with Words 4-8	£12.95 £12.95																																																																																																																														
Fun with Words 7	£8.50 £11.95																																																																																																																														
Read Right Away 1 5-8	£9.95 £12.95																																																																																																																														
Read Right Away 2 6-9	£9.95 £12.95																																																																																																																														
Read Right Away 3 7+	£9.95 £12.95																																																																																																																														
Better Spelling 9+	£8.95 £12.95																																																																																																																														
Lets Play Numbers 4-8	£12.95 £12.95																																																																																																																														
Lets Play Money 4-8	£12.95 £12.95																																																																																																																														
Primary Maths 3-12	£24.95 £24.95																																																																																																																														
Fun with Numbers 7	£8.50 £11.95																																																																																																																														
Target Maths 6-13	£12.95																																																																																																																														
Micro Maths 9-16	£24.95 £24.95																																																																																																																														
Better Maths 12-16	£8.95 £12.95																																																																																																																														
Mega Maths 15+	£24.95 £24.95																																																																																																																														
Biology 1 12-16	£8.95 £12.95																																																																																																																														
Chemistry 1 12-16	£8.95 £12.95																																																																																																																														
Physics 1 12-16	£8.95 £12.95																																																																																																																														
French Mistress 11+	£15.95																																																																																																																														
German Master 11+	£15.95																																																																																																																														
Spanish Tutor 11+	£15.95																																																																																																																														
Micro English 8-Ad	£24.95 £24.95																																																																																																																														
The Three Bears 5+ (6128)	£12.95																																																																																																																														
Five on Treasure Island	£9.50 £11.95																																																																																																																														
Granny's Garden 6-10 (6128)	£16.95																																																																																																																														
Dragon World 6-10 (6128)	£20.95																																																																																																																														
Giant Killer Maths Adv 9-14	£15.95																																																																																																																														
Answer Back Jr Quiz 6-11	£11.95																																																																																																																														
CITIZEN 120D + 9 Pin Mono	£139.95																																																																																																																														
STAR LC20 9 Pin Mono	£149.95																																																																																																																														
STAR LC100 9 Pin Mono/Col	£189.95																																																																																																																														
STAR LC24-20 24 Pin Mono	£209.95																																																																																																																														
STAR LC24-100 24 Pin Mono	£219.95																																																																																																																														
STAR LC24-200 24 Pin Mono	£259.95																																																																																																																														
STAR LC24-200 24 Pin Mono/Col	£289.95																																																																																																																														
<table border="1" style="width: 100%; border-collapse: collapse;"> <thead> <tr> <th>CASS</th> <th>DISK</th> </tr> </thead> <tbody> <tr><td>Addams Family (128K)</td><td>£14.95</td></tr> <tr><td>Captain Blood</td><td>£11.95</td></tr> <tr><td>F16 Combat Pilot</td><td>£3.75 £7.95</td></tr> <tr><td>G-Loc (128K)</td><td>£13.95</td></tr> <tr><td>Gauntlet III</td><td>£13.95</td></tr> <tr><td>I. Jones Fate Atlantis</td><td>£9.95 £13.95</td></tr> <tr><td>Lemmings</td><td>£12.95 £15.95</td></tr> <tr><td>Monty Python</td><td>£11.95</td></tr> <tr><td>Outrun Europa</td><td>£9.50 £13.95</td></tr> <tr><td>Paperboy II</td><td>£9.50 £12.95</td></tr> <tr><td>Rodland</td><td>£12.95</td></tr> <tr><td>Sim City</td><td>£14.95</td></tr> <tr><td>Simpsons</td><td>£9.50 £12.95</td></tr> <tr><td>Space Crusade</td><td>£12.95</td></tr> <tr><td>Street Fighter II</td><td>£14.95</td></tr> <tr><td>Super Monaco G. Prix</td><td>£9.50 £12.95</td></tr> <tr><td>Terminator II</td><td>£9.50 £12.95</td></tr> <tr><td>Titus the Fox</td><td>£9.50 £12.95</td></tr> <tr><td>WWF Wrestlingmania</td><td>£10.95 £12.95</td></tr> </tbody> </table>	CASS	DISK	Addams Family (128K)	£14.95	Captain Blood	£11.95	F16 Combat Pilot	£3.75 £7.95	G-Loc (128K)	£13.95	Gauntlet III	£13.95	I. Jones Fate Atlantis	£9.95 £13.95	Lemmings	£12.95 £15.95	Monty Python	£11.95	Outrun Europa	£9.50 £13.95	Paperboy II	£9.50 £12.95	Rodland	£12.95	Sim City	£14.95	Simpsons	£9.50 £12.95	Space Crusade	£12.95	Street Fighter II	£14.95	Super Monaco G. Prix	£9.50 £12.95	Terminator II	£9.50 £12.95	Titus the Fox	£9.50 £12.95	WWF Wrestlingmania	£10.95 £12.95	<table border="1" style="width: 100%; border-collapse: collapse;"> <thead> <tr> <th>CASS</th> <th>DISK</th> </tr> </thead> <tbody> <tr><td>Colossus 4.0 Bridge</td><td>£3.75 £7.95</td></tr> <tr><td>Colossus 4.0 Chess</td><td>£3.75 £7.95</td></tr> <tr><td>F16 Combat Pilot</td><td>£3.75 £7.95</td></tr> <tr><td>Hunt Red October</td><td>£6.99</td></tr> <tr><td>Monopoly</td><td>£2.99 £6.99</td></tr> <tr><td>Scrabble</td><td>£2.99</td></tr> <tr><td>Scrabble De Luxe 6128</td><td>£12.95</td></tr> <tr><td>Trivial Pursuits</td><td>£3.75</td></tr> </tbody> </table>	CASS	DISK	Colossus 4.0 Bridge	£3.75 £7.95	Colossus 4.0 Chess	£3.75 £7.95	F16 Combat Pilot	£3.75 £7.95	Hunt Red October	£6.99	Monopoly	£2.99 £6.99	Scrabble	£2.99	Scrabble De Luxe 6128	£12.95	Trivial Pursuits	£3.75	<table border="1" style="width: 100%; border-collapse: collapse;"> <thead> <tr> <th>CASS</th> <th>DISK</th> </tr> </thead> <tbody> <tr><td>AMX Mouse & Interface</td><td>£34.95</td></tr> <tr><td>AMX Mouse + Adv Art + Mouse Mat</td><td>£54.95</td></tr> <tr><td>Amstrad MP1F (464 to Scart TV)</td><td>£29.95</td></tr> <tr><td>Amstrad MP2F (6128 to Scart TV)</td><td>£34.95</td></tr> <tr><td>+ Above require RGB input</td><td></td></tr> <tr><td>Cassette Lead (with R&M Conn)</td><td>£3.95</td></tr> <tr><td>Cassette Rac + Leads (not 6128+)</td><td>£23.95</td></tr> <tr><td>Cover Set (state mach & mon)</td><td>£8.95</td></tr> <tr><td>Disk Drive Cleaner 3"</td><td>£5.95</td></tr> <tr><td>Genius Mouse & Adv Art</td><td>£49.95</td></tr> <tr><td>Joystick Splitter</td><td>£8.95</td></tr> <tr><td>Keyboard Ext Leads 464/6128+ 6128</td><td>£8.95</td></tr> <tr><td>Keyboard Ext Leads 464+/6128+</td><td>£8.95</td></tr> <tr><td>MP3 + P/S for CTM 640 Monitor</td><td>£39.95</td></tr> <tr><td>MP3 TV Tuner for 464+/6128+</td><td>£39.95</td></tr> <tr><td>MP3 TV Tuner for CTM644 Mono</td><td>£32.95</td></tr> <tr><td>Memory Expansion 64K for 464</td><td>£44.95</td></tr> <tr><td>Printer Cable 1 Mtr £8.95, 2 Mtr £10.95</td><td></td></tr> <tr><td>Printer Cable 464+/6128+ 2Mtr</td><td>£7.95</td></tr> </tbody> </table>	CASS	DISK	AMX Mouse & Interface	£34.95	AMX Mouse + Adv Art + Mouse Mat	£54.95	Amstrad MP1F (464 to Scart TV)	£29.95	Amstrad MP2F (6128 to Scart TV)	£34.95	+ Above require RGB input		Cassette Lead (with R&M Conn)	£3.95	Cassette Rac + Leads (not 6128+)	£23.95	Cover Set (state mach & mon)	£8.95	Disk Drive Cleaner 3"	£5.95	Genius Mouse & Adv Art	£49.95	Joystick Splitter	£8.95	Keyboard Ext Leads 464/6128+ 6128	£8.95	Keyboard Ext Leads 464+/6128+	£8.95	MP3 + P/S for CTM 640 Monitor	£39.95	MP3 TV Tuner for 464+/6128+	£39.95	MP3 TV Tuner for CTM644 Mono	£32.95	Memory Expansion 64K for 464	£44.95	Printer Cable 1 Mtr £8.95, 2 Mtr £10.95		Printer Cable 464+/6128+ 2Mtr	£7.95	<table border="1" style="width: 100%; border-collapse: collapse;"> <thead> <tr> <th>CASS</th> <th>DISK</th> </tr> </thead> <tbody> <tr><td>Avalanche (Italy WW2)</td><td>£10.95 £11.95</td></tr> <tr><td>Battle of Bulge</td><td>£10.95 £11.95</td></tr> <tr><td>Crete 1941</td><td>£10.95 £11.95</td></tr> <tr><td>Desert Rats</td><td>£10.95 £11.95</td></tr> <tr><td>R.T. Smith Compendium (Ancient Battles + Arnhem + Vulcan)</td><td>£12.95 £13.95</td></tr> </tbody> </table>	CASS	DISK	Avalanche (Italy WW2)	£10.95 £11.95	Battle of Bulge	£10.95 £11.95	Crete 1941	£10.95 £11.95	Desert Rats	£10.95 £11.95	R.T. Smith Compendium (Ancient Battles + Arnhem + Vulcan)	£12.95 £13.95														
CASS	DISK																																																																																																																														
Addams Family (128K)	£14.95																																																																																																																														
Captain Blood	£11.95																																																																																																																														
F16 Combat Pilot	£3.75 £7.95																																																																																																																														
G-Loc (128K)	£13.95																																																																																																																														
Gauntlet III	£13.95																																																																																																																														
I. Jones Fate Atlantis	£9.95 £13.95																																																																																																																														
Lemmings	£12.95 £15.95																																																																																																																														
Monty Python	£11.95																																																																																																																														
Outrun Europa	£9.50 £13.95																																																																																																																														
Paperboy II	£9.50 £12.95																																																																																																																														
Rodland	£12.95																																																																																																																														
Sim City	£14.95																																																																																																																														
Simpsons	£9.50 £12.95																																																																																																																														
Space Crusade	£12.95																																																																																																																														
Street Fighter II	£14.95																																																																																																																														
Super Monaco G. Prix	£9.50 £12.95																																																																																																																														
Terminator II	£9.50 £12.95																																																																																																																														
Titus the Fox	£9.50 £12.95																																																																																																																														
WWF Wrestlingmania	£10.95 £12.95																																																																																																																														
CASS	DISK																																																																																																																														
Colossus 4.0 Bridge	£3.75 £7.95																																																																																																																														
Colossus 4.0 Chess	£3.75 £7.95																																																																																																																														
F16 Combat Pilot	£3.75 £7.95																																																																																																																														
Hunt Red October	£6.99																																																																																																																														
Monopoly	£2.99 £6.99																																																																																																																														
Scrabble	£2.99																																																																																																																														
Scrabble De Luxe 6128	£12.95																																																																																																																														
Trivial Pursuits	£3.75																																																																																																																														
CASS	DISK																																																																																																																														
AMX Mouse & Interface	£34.95																																																																																																																														
AMX Mouse + Adv Art + Mouse Mat	£54.95																																																																																																																														
Amstrad MP1F (464 to Scart TV)	£29.95																																																																																																																														
Amstrad MP2F (6128 to Scart TV)	£34.95																																																																																																																														
+ Above require RGB input																																																																																																																															
Cassette Lead (with R&M Conn)	£3.95																																																																																																																														
Cassette Rac + Leads (not 6128+)	£23.95																																																																																																																														
Cover Set (state mach & mon)	£8.95																																																																																																																														
Disk Drive Cleaner 3"	£5.95																																																																																																																														
Genius Mouse & Adv Art	£49.95																																																																																																																														
Joystick Splitter	£8.95																																																																																																																														
Keyboard Ext Leads 464/6128+ 6128	£8.95																																																																																																																														
Keyboard Ext Leads 464+/6128+	£8.95																																																																																																																														
MP3 + P/S for CTM 640 Monitor	£39.95																																																																																																																														
MP3 TV Tuner for 464+/6128+	£39.95																																																																																																																														
MP3 TV Tuner for CTM644 Mono	£32.95																																																																																																																														
Memory Expansion 64K for 464	£44.95																																																																																																																														
Printer Cable 1 Mtr £8.95, 2 Mtr £10.95																																																																																																																															
Printer Cable 464+/6128+ 2Mtr	£7.95																																																																																																																														
CASS	DISK																																																																																																																														
Avalanche (Italy WW2)	£10.95 £11.95																																																																																																																														
Battle of Bulge	£10.95 £11.95																																																																																																																														
Crete 1941	£10.95 £11.95																																																																																																																														
Desert Rats	£10.95 £11.95																																																																																																																														
R.T. Smith Compendium (Ancient Battles + Arnhem + Vulcan)	£12.95 £13.95																																																																																																																														
<table border="1" style="width: 100%; border-collapse: collapse;"> <thead> <tr> <th>CASS</th> <th>DISK</th> </tr> </thead> <tbody> <tr><td>Advanced Art Studio 6128</td><td>£19.95</td></tr> <tr><td>Colour Dump 3 (Col Scr Dump)</td><td>£12.95</td></tr> <tr><td>Crash Course Typing Tut 6128</td><td>£20.95</td></tr> <tr><td>Mastercalc 128 (128k)</td><td>£27.95</td></tr> <tr><td>Masterfile III (128k)</td><td>£29.95</td></tr> <tr><td>Maxim (Assembler)</td><td>£23.95</td></tr> <tr><td>Mini Office II</td><td>£12.95 £16.95</td></tr> <tr><td>Money Manager (+PCW)</td><td>£24.95</td></tr> <tr><td>Prospell</td><td>£20.95</td></tr> <tr><td>Protex</td><td>£16.95 £21.95</td></tr> <tr><td>Prototype (Print Enhancer)</td><td>£23.95</td></tr> <tr><td>tasSpell (For Tasword)</td><td>£20.95</td></tr> <tr><td>Tasword 6128</td><td>£24.95</td></tr> </tbody> </table>	CASS	DISK	Advanced Art Studio 6128	£19.95	Colour Dump 3 (Col Scr Dump)	£12.95	Crash Course Typing Tut 6128	£20.95	Mastercalc 128 (128k)	£27.95	Masterfile III (128k)	£29.95	Maxim (Assembler)	£23.95	Mini Office II	£12.95 £16.95	Money Manager (+PCW)	£24.95	Prospell	£20.95	Protex	£16.95 £21.95	Prototype (Print Enhancer)	£23.95	tasSpell (For Tasword)	£20.95	Tasword 6128	£24.95	<table border="1" style="width: 100%; border-collapse: collapse;"> <thead> <tr> <th>CASS</th> <th>DISK</th> </tr> </thead> <tbody> <tr><td>AMSTRAD JY2</td><td>£7.95</td></tr> <tr><td>CHEETAH Bug</td><td>£13.95</td></tr> <tr><td>CHEETAH Moch 1</td><td>£11.95</td></tr> <tr><td>KONIX Speedking</td><td>£10.95</td></tr> <tr><td>KONIX Navigator</td><td>£13.95</td></tr> <tr><td>POWERPLAY Terminator</td><td>£14.95</td></tr> <tr><td>QUICKSHOT Python 1</td><td>£10.95</td></tr> <tr><td>QUICKSHOT Python 1 Microswitch</td><td>£11.95</td></tr> <tr><td>ZIPSTICK Super Pro</td><td>£14.95</td></tr> <tr><td>464+/6128+/GX4000 Games Paddle</td><td>£8.95</td></tr> </tbody> </table>	CASS	DISK	AMSTRAD JY2	£7.95	CHEETAH Bug	£13.95	CHEETAH Moch 1	£11.95	KONIX Speedking	£10.95	KONIX Navigator	£13.95	POWERPLAY Terminator	£14.95	QUICKSHOT Python 1	£10.95	QUICKSHOT Python 1 Microswitch	£11.95	ZIPSTICK Super Pro	£14.95	464+/6128+/GX4000 Games Paddle	£8.95	<table border="1" style="width: 100%; border-collapse: collapse;"> <thead> <tr> <th>CASS</th> <th>DISK</th> </tr> </thead> <tbody> <tr><td>Arithmetic 6-11</td><td>£7.95</td></tr> <tr><td>Spelling 6-11</td><td>£7.95</td></tr> <tr><td>World Geography 6-11</td><td>£7.95</td></tr> <tr><td>Natural History 6-11</td><td>£7.95</td></tr> <tr><td>English Words 6-11</td><td>£7.95</td></tr> </tbody> </table>	CASS	DISK	Arithmetic 6-11	£7.95	Spelling 6-11	£7.95	World Geography 6-11	£7.95	Natural History 6-11	£7.95	English Words 6-11	£7.95	<table border="1" style="width: 100%; border-collapse: collapse;"> <thead> <tr> <th>Quantity:</th> <th>1</th> <th>2</th> <th>5</th> </tr> </thead> <tbody> <tr><td>DMP 2000/3000</td><td>£3.75</td><td>£7.00</td><td>£16.25</td></tr> <tr><td>CITIZEN 120D</td><td>£3.75</td><td>£7.00</td><td>£16.25</td></tr> <tr><td>PANASONIC KP10/1180</td><td>£3.75</td><td>£7.00</td><td>£16.25</td></tr> <tr><td>STAR LC10/20</td><td>£3.75</td><td>£7.00</td><td>£16.25</td></tr> <tr><td>STAR LC24-10/20</td><td>£3.95</td><td>£7.50</td><td>£17.50</td></tr> <tr><td>PANASONIC KP1124</td><td>£3.75</td><td>£7.00</td><td>£16.25</td></tr> <tr><td>STAR LC200 Mono</td><td>£4.95</td><td>£9.50</td><td></td></tr> <tr><td>Star LC200 Colour</td><td>£9.95</td><td>£18.95</td><td></td></tr> </tbody> </table> <p>Other printer ribbons please phone</p> <table border="1" style="width: 100%; border-collapse: collapse;"> <tbody> <tr><td>RIBBON RE-INK</td><td>£12.95</td></tr> </tbody> </table>	Quantity:	1	2	5	DMP 2000/3000	£3.75	£7.00	£16.25	CITIZEN 120D	£3.75	£7.00	£16.25	PANASONIC KP10/1180	£3.75	£7.00	£16.25	STAR LC10/20	£3.75	£7.00	£16.25	STAR LC24-10/20	£3.95	£7.50	£17.50	PANASONIC KP1124	£3.75	£7.00	£16.25	STAR LC200 Mono	£4.95	£9.50		Star LC200 Colour	£9.95	£18.95		RIBBON RE-INK	£12.95																								
CASS	DISK																																																																																																																														
Advanced Art Studio 6128	£19.95																																																																																																																														
Colour Dump 3 (Col Scr Dump)	£12.95																																																																																																																														
Crash Course Typing Tut 6128	£20.95																																																																																																																														
Mastercalc 128 (128k)	£27.95																																																																																																																														
Masterfile III (128k)	£29.95																																																																																																																														
Maxim (Assembler)	£23.95																																																																																																																														
Mini Office II	£12.95 £16.95																																																																																																																														
Money Manager (+PCW)	£24.95																																																																																																																														
Prospell	£20.95																																																																																																																														
Protex	£16.95 £21.95																																																																																																																														
Prototype (Print Enhancer)	£23.95																																																																																																																														
tasSpell (For Tasword)	£20.95																																																																																																																														
Tasword 6128	£24.95																																																																																																																														
CASS	DISK																																																																																																																														
AMSTRAD JY2	£7.95																																																																																																																														
CHEETAH Bug	£13.95																																																																																																																														
CHEETAH Moch 1	£11.95																																																																																																																														
KONIX Speedking	£10.95																																																																																																																														
KONIX Navigator	£13.95																																																																																																																														
POWERPLAY Terminator	£14.95																																																																																																																														
QUICKSHOT Python 1	£10.95																																																																																																																														
QUICKSHOT Python 1 Microswitch	£11.95																																																																																																																														
ZIPSTICK Super Pro	£14.95																																																																																																																														
464+/6128+/GX4000 Games Paddle	£8.95																																																																																																																														
CASS	DISK																																																																																																																														
Arithmetic 6-11	£7.95																																																																																																																														
Spelling 6-11	£7.95																																																																																																																														
World Geography 6-11	£7.95																																																																																																																														
Natural History 6-11	£7.95																																																																																																																														
English Words 6-11	£7.95																																																																																																																														
Quantity:	1	2	5																																																																																																																												
DMP 2000/3000	£3.75	£7.00	£16.25																																																																																																																												
CITIZEN 120D	£3.75	£7.00	£16.25																																																																																																																												
PANASONIC KP10/1180	£3.75	£7.00	£16.25																																																																																																																												
STAR LC10/20	£3.75	£7.00	£16.25																																																																																																																												
STAR LC24-10/20	£3.95	£7.50	£17.50																																																																																																																												
PANASONIC KP1124	£3.75	£7.00	£16.25																																																																																																																												
STAR LC200 Mono	£4.95	£9.50																																																																																																																													
Star LC200 Colour	£9.95	£18.95																																																																																																																													
RIBBON RE-INK	£12.95																																																																																																																														
<table border="1" style="width: 100%; border-collapse: collapse;"> <thead> <tr> <th>CASS</th> <th>DISK</th> </tr> </thead> <tbody> <tr><td>Chuckie Egg</td><td>£7.95</td></tr> <tr><td>Continental Circus</td><td>£7.95</td></tr> <tr><td>Dizzy Yolk Folk</td><td>£7.95</td></tr> <tr><td>Dragons of Flame</td><td>£7.95</td></tr> <tr><td>Emlyn Hughes Soccer</td><td>£7.95</td></tr> <tr><td>Flimbo's Quest</td><td>£7.95</td></tr> <tr><td>Gunslip</td><td>£7.95</td></tr> <tr><td>Puzznic</td><td>£7.95</td></tr> <tr><td>Silent Service</td><td>£7.95</td></tr> <tr><td>Terminator II</td><td>£7.95</td></tr> <tr><td>Turbo Tortoise</td><td>£7.95</td></tr> </tbody> </table>				CASS	DISK	Chuckie Egg	£7.95	Continental Circus	£7.95	Dizzy Yolk Folk	£7.95	Dragons of Flame	£7.95	Emlyn Hughes Soccer	£7.95	Flimbo's Quest	£7.95	Gunslip	£7.95	Puzznic	£7.95	Silent Service	£7.95	Terminator II	£7.95	Turbo Tortoise	£7.95																																																																																																				
CASS	DISK																																																																																																																														
Chuckie Egg	£7.95																																																																																																																														
Continental Circus	£7.95																																																																																																																														
Dizzy Yolk Folk	£7.95																																																																																																																														
Dragons of Flame	£7.95																																																																																																																														
Emlyn Hughes Soccer	£7.95																																																																																																																														
Flimbo's Quest	£7.95																																																																																																																														
Gunslip	£7.95																																																																																																																														
Puzznic	£7.95																																																																																																																														
Silent Service	£7.95																																																																																																																														
Terminator II	£7.95																																																																																																																														
Turbo Tortoise	£7.95																																																																																																																														

PRICES INCLUDE POSTAGE & PACKING IN U.K. PLEASE MAKE CHEQUES & POSTAL ORDERS PAYABLE TO: O.J. SOFTWARE AND SEND TO O.J. SOFTWARE, 273 MOSSY LEA ROAD, WRIGHTINGTON, NR. WIGAN, LANCs WN6 9RN (MOST ORDERS DESPATCHED BY RETURN). ACCESS & VISA ORDERS TEL/FAX ON 0257 421915 MON-FRI 9.00 - 17.30 (ANSWERPHONE/FAX OUTSIDE HOURS). OVERSEAS ORDERS WELCOME (SOFTWARE ADD £1 PER ITEM POSTAGE; PAYMENT BY CREDIT CARD, EUROCHQUE OR BANK DRAFT)

Type-ins

This month, live from Bath, we have four type-ins. If yours are half as good then send them to Type-ins, Amstrad Action, Beauford Court, 30 Monmouth Street, Bath, Avon BA1 2BW. If your routine is up their with the best, you could earn yourself twenty pounds!

ESTI-DIY

ESTI-DIY by A J Bishop of Daventry, Northants, enables committed DIYers to work out, accurately, the amount of materials they'll need to complete a job. The program is menu-driven and, by prompting for the areas involved, computes the number of bricks or what have you necessary for a project with dazzling speed and accuracy. Interesting, and very useful.

FAPG 5·REM·BY·T·BISHOP·...

BAHP 10·MODE·1

FALC 20·REM·esti·d.i.y.

BAFC 30·CLS

IADA 40·LOCATE·15,3:PRINT·"ESTI·D.I.Y"

IAMM 50·LOCATE·15,9:PRINT·"A...BRICKWORK"

IAGA 60·LOCATE·15,12:PRINT·"B...CEMENT"

IACK 70·LOCATE·15,15:PRINT·"C...CONCRETE"

IAMP 80·LOCATE·15,18:PRINT·"D...WALLPAPER"

GAGJ 90·A\$=INKEY\$:IF·A\$=""·THEN·90

IAMA 100·IF·A\$="A"·OR·A\$="a"·THEN·GOTO·140

IACB 110·IF·A\$="B"·OR·A\$="b"·THEN·GOTO·260

IAEB 120·IF·A\$="C"·OR·A\$="c"·THEN·GOTO·340

IAXB 130·IF·A\$="D"·OR·A\$="d"·THEN·GOTO·460

BAHJ 140·CLS

GADO 150·PRINT·TAB(15)"BRICKWORK"

MAAM 160·LOCATE·4,6:INPUT·"LENGTH·OF·WALL·IN·METRES";br

NAED 170·LOCATE·4,9:INPUT·"HEIGHT·OF·WALL·IN·METRES";bri

EAMH 180·bric=(br*4.5)

GAMX 190·brick=CINT(bri*13.3)

IACM 200·bricks=bric*brick/100*105

NAJP 210·LOCATE·4,12:PRINT·"BRICKS·225x113x75·ALL·SIZES·IN·MM"

PABO 220·LOCATE·4,15:PRINT·"BRICKS·REQUIRED...CINT(bricks)

MABG 230·LOCATE·4,24:PRINT·"RETURN·TO·MAIN·MENU·?(Y/N)"

GARN 240·A\$=INKEY\$:IF·A\$=""·THEN·240

KAAH 250·IF·A\$="Y"·OR·A\$="y"·THEN·GOTO·30·ELSE·END

BAKJ 260·CLS

GADM 270·PRINT·TAB(15)"CEMENT·1:4"

LADG 275·LOCATE·4,6:INPUT·"No·OF·BRICKS";bricks

GAIL 290·cement=bricks/250

FAMM 300·sand=cement*0.2

OAEA 310·LOCATE·4,12:PRINT·"SAND·REQ·IN·CUBIC·METRES.";sand

PAGE 320·LOCATE·4,15:PRINT·"CEMENT·REQ·BAGS...CINT(cement)

CAEK 330·GOTO·230

BAJJ 340·CLS

HALG 350·PRINT·TAB(15)"CONCRETE·1:6"

KALM 360·LOCATE·4,6:INPUT·"LENGTH·IN·METRES";co

KALP 370·LOCATE·4,9:INPUT·"WIDTH·IN·METRES";con

Telephone Directory



Alasdair Gillies's program Telephone Directory is a basic (2K) but very usable repository

for the telephone numbers of all your friends and relations. The program prompts for a name and, when you've entered it, fires the telephone number associated with that person right back at you. Phone numbers must be entered as data statements while you're typing in the program - although an input routine could easily be added to smooth the whole operation. All instructions necessary are contained within the program. Alasdair hails from Ardrossan, Ayrshire and has just made twenty quid!

CAKB 5·INK·1,24

CAKQ 6·BORDER·6

KACK 10·DIM·NAME\$(20),N\$(20),T\$(20),YN\$(3),N2\$(20),T2\$(20)

BAJP 20·MODE·2

ABAN 30·LOCATE·25,1:PRINT**·TELEPHONE·DIRECTORY·BY·ALASDAIR·GILLIES**·

MAEG 40·LOCATE·25,2:PRINT">>TYPE·'?'·TO·EXIT·PROGRAM<<"

NABD 50·LOCATE·25,3:PRINT"PLEASE·ENTER·NAME";:INPUT·NAME\$

EAMK 60·IF·NAME\$=""·THEN·20

FAND 70·IF·NAME\$="?"·THEN·300

GAND 80·IF·NAME\$="LIST"·THEN·500

IAHL 90·PRINT:PRINT:PRINT;"SEARCHING"

CAFN 100·RESTORE

DALL 110·FOR·N=1·TO·30

DAFA 120·READ·N\$,T\$

GAGL 130·IF·N\$=NAME\$·THEN·GOTO·250

HAFO 140·IF·N\$="END"·OR·T\$="END"·THEN·160

CADG 150·NEXT·N

MAHX 160·IF·N\$(<)NAME\$·THEN·PRINT·NAME\$;"·S·NUMBER·IS·NOT"

LAKK 170·PRINT:PRINT"INCLUDED·IN·THIS·DIRECTORY."

ABKI 200·LOCATE·25,15:PRINT·"DO·YOU·REQUIRE·A·NOTHER·NUMBER";:INPUT·YN\$

LAMH 210·IF·YN\$=""·OR·YN\$="Y"·OR·YN\$="YES"·THEN·GOTO·20

MAFG 220·IF·YN\$("<)"·OR·YN\$("<)"YES"·OR·YN\$("<)"Y"·THEN·GOTO·300

KAPD 250·PRINT·NAME\$;"·S·NUMBER·IS·";T\$;GOTO·200

BAFJ 300·CLS

CANN 310·INK·1,26,6

OBMP 320·PRINT·"THEN·WHY·DON'T·YOU·GO·AND·SLICE·YOUR·HEAD·OFF·WITH·AN·AXE·AND·BOIL·IT·IN·A·PRESSURE·COOKER·UNTIL·IT·EXPLODES!"

EABF 321·FOR·Q=100·TO·200

DALG 322·SOUND·1,Q,1

CAIG 323·NEXT·Q

DAIM 324·FOR·Q=1·TO·60

GANL 325·SOUND·1,RND(100),1,15,0,0,31

CALG 326·NEXT·Q

CAFK 330·GOTO·321

FADG 500·CLEAR:RESTORE·9000

LAAG 510·CLS:PRINT·TAB(4)**·TELEPHONE·DIRECTORY**

DAAM 520·FOR·N=1·TO·30

FAOP 530·IF·N=15·THEN·GOSUB·700

DAFG 540·READ·N2\$,T2\$

IANC 550·IF·N2\$="END"·OR·T2\$="END"·THEN·600

IADH 560·LOCATE·25,N+8:PRINT·N2\$;"·...";T2\$

CAJG 570·NEXT·N

EBCD 600·PRINT:PRINT:PRINT:PRINT"NO·MORE·NUMBERS...WANT·TO·CONTINUE";:INPUT·YN\$

CADK 610·GOTO·210

ABJI 700·PRINT:PRINT:PRINT:PRINT"WANT·TO·CONTINUE·LIST";:INPUT·YN\$

LAJG 710·IF·YN\$=""·OR·YN\$="Y"·OR·YN\$="YES"·THEN·RETURN

CAEH 720·GOTO·20



ProgLib - which disk?

Anyone who's been an Amstrad owner for some time will know that it's often difficult to keep track of the thousands of programs tucked away on disk and tape. Commercial titles, games and utilities typed in from Amstrad Action and other sources, public domain downloads - they all have to be stored somewhere and catalogued. And it's for the latter operation that *ProgLib* was created. Written by Chris Godfrey of Basingstoke, Hants, *ProgLib* is a menu-driven database which stores details and whereabouts of all your programs so that, to find one, all you have to do is enter its name and the computer coughs up the relevant info. A print routine means you can get a hard copy listing of your software at any time.

```
JAPK 10·DIM·name$(1000):DIM·author$(1000)···
IAKA 20·MODE·2:BORDER·0:INK·1,26:INK·0,0
JABM 30·PRINT"··········PROGRAM
M·LIBRARY"
IALA 40·PRINT"··········
··········"
FAAK 50·PRINT:PRINT:PRINT
GAIO 60·PRINT"1·····ENTER·LIST"·····
FAMC 70·PRINT"2·····LIST"·····
EARI 80·PRINT"3·····BYE."
FAPP 90·PRINT"4·····SAVE·LIST"
GAJB 100·PRINT"5·····LOAD·LIST"
CACG 110·PRINT"6·····CLEAR·LIST"
CAIG 120·PRINT"7·····PRINT·LIST"
KAIE 130·INPUT"What·do·you·choose";ns
```

```
JALE 140·ON·ns·GOSUB·180,280,370,450,530,610,
660
KABE 150·LOCATE·7,25:PRINT"Press·any·key"
GAKO 160·IF·INKEY$=""·THEN·GOTO·160
CADH 170·GOTO·20
LANI 180·MODE·2:PRINT"··········
··········ENTER·NAMES"
IANK 190·PRINT"··········
··········"
FANM 200·PRINT:PRINT:PRINT
EAEH 210·FOR·x=1·TO·10000
MAII 220·INPUT"Name·of·Game/Program";NAME$(X)
)·····
MAIK 230·INPUT"Name·of·Publisher";author$(x)
HAED 240·IF·NAME$(X)=""·THEN·GOTO·260
BAGP 250·NEXT
HAHL 260·PRINT"No·more·input."
CAJJ 270·RETURN
LAME 280·MODE·2:PRINT"··········
··········LIST·NAMES"
IABI 290·PRINT"··········
··········"
FAOM 300·PRINT:PRINT:PRINT
EAPC 310·FOR·X=1·TO·1000
HADD 320·IF·NAME$(X)=""·THEN·GOTO·350
MAEN 330·PRINT·NAME$(X);:PRINT"·BY·";:PRINT·A
UTHOR$(X)·····
BAGP 340·NEXT
IAEE 350·PRINT:PRINT"·LIST·FINISHED."
CAJJ 360·RETURN
LAAB 370·PRINT:INPUT"Are·you·sure·(Y/N)";a$
IAPB 380·IF·UPPER$(a$)=""·THEN·GOTO·440
KALC 390·IF·UPPER$(a$)=""·THEN·GOTO·400·ELSE
·380
JAKA 400·PRINT:PRINT"Bye·then.":CLEAR
GANJ 410·PRINT"press·a·key"
FAPI 420·IF·INKEY$=""·THEN·420
BABK 430·NEW
CAIJ 440·RETURN
CBPE 450·PRINT:PRINT:PRINT"·Insert·tape/disc·
```

```
then·press·a·key"
FACG 460·OPENOUT"data"·····
EAME 470·FOR·x=1·TO·1000
JAJA 480·WRITE#9,name$(x),author$(x)
BAMP 490·NEXT
DADC 500·CLOSEOUT
GAEF 510·PRINT"data·saved"
CAHJ 520·RETURN
CBOX 530·PRINT:PRINT:PRINT"·Insert·tape/disc·
then·press·a·key"·····
EAMM 540·OPENIN"data"·····
FALA 550·FOR·x=1·TO·1000·····
JANA 560·INPUT#9,name$(x),author$(x)
CALH 570·NEXT·····
CAKM 580·CLOSEIN
GACL 590·PRINT"data·loaded"
CAGJ 600·RETURN
JAGH 610·PRINT:INPUT"Are·you·sure";a$
IAJC 620·IF·UPPER$(a$)=""·THEN·GOTO·640
KANA 630·IF·UPPER$(a$)=""·THEN·RETURN·ELSE·6
20
CABC 640·CLEAR
BAAL 650·RUN
EANC 660·FOR·X=1·TO·1000
HAMO 670·IF·AUTHOR$(X)=""·THEN·GOTO·700
JAJO 680·PRINT#9,NAME$(X);:PRINT#8,AUTHOR$(X)
BAOP 690·NEXT
CAHJ 700·RETURN
```

```
LAXM 380·LOCATE·4,12:PRINT"ONE·INCH·=·0.025·
OF·A·METRE"
MAJL 390·LOCATE·4,15:INPUT"THICKNESS·IN·METE
RS";conc
HANP 400·concr=co*con*con*0.15
GAEE 410·concre=concr*5.6
HAOB 420·concret=concre*5.6
OAFI 430·LOCATE·4,18:PRINT"CEMENT·BAGS·····
··········";concret
PALB 440·LOCATE·4,21:PRINT"BALLAST·IN·CUBIC·
METRES·····";concre
CAHK 450·GOTO·230
BAMJ 460·CLS
GACO 470·PRINT·TAB(15)"WALLPAPER"
LAKJ 480·LOCATE·4,6:INPUT"WALL·DROP·IN·METRE
S";wd
NAOI 490·LOCATE·4,9:INPUT"DIST·AROUND·ROOM·I
N·METRES";dr
EAOA 500·pape=wd*dr
EAOD 510·pape=pap/5
MAKJ 520·LOCATE·4,12:PRINT"ROLLS·WALLPAPER·RE
Q";pape
CAGK 530·GOTO·230
```

Alpha Scroll

You've all seen those funky scrolling messages on computer screens in shop windows, estate and travel agents, railway stations and the like which display on an endless sideways scrolling loop information and advertising, right? Well now you too can create scrolling messages. Manchester boy David Hall's *Alpha Scroll* reads a previously saved text file (or enables you to enter one and save it) which it then scrolls smoothly right to left across the CPC's screen. Fun for all the family!

```
JAJM 10·'·**·ALPHA·SCROLL·**·By·David·Hall
JAAD 20·'(C)·Mar·1990······and·Andy·Hall
AAKX 30·'
KAPA 40·'-----Amstrad·CPC·version·-----
HANP 50·'·for·A·M·S·T·R·A·D·A·C·T·I·O·N·
AANK 60·'
FAHM 70·IF·HIMEM=9999·THEN·100
EAEH 80·SYMBOL·AFTER·31
DAGG 90·MEMORY·9999
CAPD 100·INK·0,0
```

```
CAGH 110·INK·1,14
CAKH 120·INK·2,16
CAHE 130·INK·3,2
CAIE 140·INK·4,1
CAME 150·INK·5,3
CAAF 160·INK·5,6
CACI 170·INK·6,15
CAFI 180·INK·7,16
CAII 190·INK·8,26
CAAM 200·BORDER·0
EAOA 210·store=10000
FABC 220·FOR·loop1=1·TO·46
CAHH 230·sum=0
GABA 240·READ·code$,total
HAPA 250·FOR·loop2=1·TO·24·STEP·2
KAPF 260·value=VAL("&"·MID$(code$,loop2,2))
GAOH 270·POKE·store,value
FAJO 280·sum=sum+value
FAOK 290·store=store+1
DAOP 300·NEXT·loop2
HAPB 310·IF·sum=total·THEN·340
LAPC 320·PRINT"Error·in·line·";1120+loop1*10
BANI 330·END
EABA 340·NEXT·loop1
```

```

CAOC 350·MODE·1
BAPO 360·PEN·3
HAAG 370·PRINT·"A·L·P·H·A·S·C·R·O·L·L"
CAIE 380·PRINT
BABP 390·PEN·2
MABI 400·PRINT·"Type·name·of·file·to·load·or"
NAOI 410·PRINT·"press·ENTER·to·create·a·message"
CADE 420·PRINT
BALO 430·PEN·1
HAHE 440·LINE·INPUT·">...",lname$
GAFC 450·IF·lname$=""·THEN·480
FAKE 460·LOAD·lname$,12000
CACL 470·GOTO·950
BACK 480·x=1
BAEK 490·y=1
EACB 500·store=12000
CANC 510·MODE·2
BALO 520·PEN·1
NAEO 530·PRINT·"·ALPHA·SCROLL·by·David·Hall·-·Please·";
OAHF 540·PRINT·"type·your·message·(·SPACE·LE·FT·=·20000·)"
IABL 550·PRINT·"·=====·(c)·Mar·1990"
FAGL 560·PRINT·STRING$(80,"*")
DAIF 570·LOCATE·1,25
FADP 580·PRINT·STRING$(80,"*");
EANO 590·WINDOW·#1,1,80,4,24
EALC 600·LOCATE·#1,x,y
EAOM 610·PRINT·#1,CHR$(143)
DAGC 620·i$=INKEY$
EALH 630·IF·i$=""·THEN·600
GAKG 640·IF·i$(<)CHR$(127)·THEN·690
EAAD 650·LOCATE·#1,x,y
DANE 660·PRINT·#1,"·"
DAFO 670·SOUND·4,1000,2
CAHL 680·GOTO·880
FAGP 690·IF·i$=CHR$(16)·THEN·600
KAON 700·IF·i$(<)CHR$(13)·AND·store(<)32000·THE·N·760
BAKJ 710·CLS
LAHP 720·PRINT·"Type·in·filename·to·SAVE·or"
LAAM 730·PRINT·"press·ENTER·to·continue·:-";
GALF 740·LINE·INPUT·"",sname$
CADL 750·GOTO·950
GAEA 760·IF·ASC(i$)>180·THEN·850
DAGL 770·SOUND·4,100,2
GANK 780·POKE·store,ASC(i$)-31
FADL 790·store=store+1
EANC 800·LOCATE·#1,x,y
DADH 810·PRINT·#1,i$
CADE 820·x=x+1
GACK 830·IF·x=81·THEN·x=1:y=y+1
HALL 840·IF·y=21·THEN·PRINT·#1:y=y-1
DAKF 850·LOCATE·71,1
FAKL 860·PRINT·32000-store
CAOK 870·GOTO·600
GAEF 880·IF·x=1·AND·y=1·THEN·600
CAME 890·x=x-1
GAAX 900·IF·x=0·THEN·x=80:y=y-1
FAFM 910·IF·y=0·THEN·y=1:x=1
EAEL 920·POKE·store,1
FABL 930·store=store-1
CADL 940·GOTO·850
CADD 950·MODE·0
JAJI 960·FOR·loop=store·TO·store+22
EAGC 970·POKE·loop,1
DAXN 980·NEXT·loop
EADJ 990·POKE·loop,255
GALH 1000·IF·sname$=""·THEN·1020
JANJ 1010·SAVE·sname$,b,12000,store-11960
BAFM 1020·CLS
CAFH 1030·INK·2,1
BADP 1040·p=10
FAMP 1050·FOR·t=1·TO·640·STEP·4
NAIB 1060·PLOT·t,398,p:DRAW·0,-150:MOVER·0,-100:DRAW·0,-180
GALN 1070·p=p+1:IF·p=16·THEN·p=10
CAIC 1080·NEXT
EAPF 1090·p=10:CALL·10000
HAKK 1100·INK·p,1:CALL·&BD19:CALL·10006
IAON 1110·INK·p,0:p=p+1:IF·p=16·THEN·p=10
CAPP 1120·GOTO·1100
IAKL 1130·DATA·CD2027CD3B27CDBE27CD8D27,1398

```

```

IADI 1140·DATA·CD6D27C921F47E360011F57E,1399
IALG 1150·DATA·018007EDB03E80326F9D21DF,1313
IACH 1160·DATA·2E226D9DC30C28DD21D08406,1193
IAAB 1170·DATA·0BC5DDE5213528115000E20,927
IAFH 1180·DATA·06087EDD7700DD232310F7DD,1255
IAXF 1190·DATA·190D20F0DE1110800DD19C1,1220
HAFP 1200·DATA·10B21010022409CC91120C3,968
IANC 1210·DATA·2188900620C5D5015000EDB0,1255
IAND 1220·DATA·D1EB7CC6086730040150C009,1211
IAPJ 1230·DATA·EBC110E9C921D084ED5B409C,1799
HAJO 1240·DATA·191188903E20015000EDB001,911
IAFA 1250·DATA·0800093D20F411F47E210893,929
HAGO 1260·DATA·0E1006501AFE002001772313,610
IAOG 1270·DATA·10F60D20F1C93A409C3DE607,1325
IAMD 1280·DATA·32409C21F57E11F47E010005,1067
IADJ 1290·DATA·ED8021437FDD212D280E08ED,1238
IAOI 1300·DATA·5B6B9D1A473A6F9DA0FE0028,1232
HANO 1310·DATA·03DD7E00D511500006027719,812
IAHI 1320·DATA·10FCD113DD23DD20E23A6F9D,1349
IAFI 1330·DATA·1F326F9DFE00C03E80326F9D,1303
IAAK 1340·DATA·2A6D9D23226D9D7EFEFF2007,1317
IABE 1350·DATA·21E02E226D9D7E11080021F4,1031
IALK 1360·DATA·9F471910FD226B9DC9F03CFC,1575
IAJF 1370·DATA·03FC3CF0F0CC883030303064,1427
HAGN 1380·DATA·CC0C200000000440C0C2030,420
HAHL 1390·DATA·303030640C0C20000000044,368
HAMK 1400·DATA·0C0C200000000440C302000,216
HAEI 1410·DATA·000000443000000044800000,320
HAPI 1420·DATA·00000008844000000000044,280
HANJ 1430·DATA·000088000404008800004400,348
HAMI 1440·DATA·08004400000000400008800,216
HAMF 1450·DATA·00000080044000800000400,88
HAPJ 1460·DATA·888800040000080044000000,352
HAJE 1470·DATA·08040000000000004000000,16
HADB 1480·DATA·0000000000800000000000,8
HAJF 1490·DATA·080400000020000400000800,56
HAIE 1500·DATA·101000080000040020000400,80
HADE 1510·DATA·000000100000080000000020,56
HACF 1520·DATA·00040020000010000800010,84
HAEZ 1530·DATA·000020000400000020100000,84
HAMK 1540·DATA·000000001020000000CC8800,388
HALL 1550·DATA·00000044C0C200000000044,384
HAJM 1560·DATA·0C0C200000000440C0C2030,228
HAHL 1570·DATA·303030640C0C20000000044,368
HAOJ 1580·DATA·0C3020303030306430000000,432

```

Famous Five!

That's what we're offering: five minutes of glorious fame, and masses of cash (well, your name in print and twenty quid, anyway...). So if you're a brilliant BASIC programmer writing code which knocks spots off anything published here - send it in! Your name in lights and big prize money is awaiting. Here's a few dos and don'ts to help you on your way...

- ⊙ DO include your name and address with your tape or disk.
- ⊙ DO include a sae if you want material returned.
- ⊙ DO write your application on the back of a fiver if you want to jump to the head of the queue. (O! Behave. Ed)
- ⊙ DO include a written description of your program and details of its operation - on-disk doc files won't do!
- ⊙ DON'T include instructions saying "...here's my program *Hot-Dots*, the name speaks for

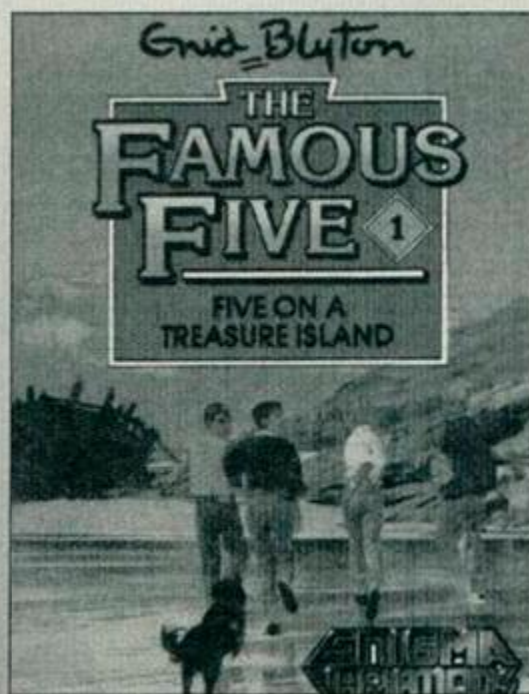

Get in Type-ins and win an island!

itself... because it doesn't! If you can't be bothered to describe what it does, I can't be bothered to load it up, okay?

Imagination

Each month, we get a lot of Type-ins. We get a lot of really good software. However, we also get a lot of stuff that really isn't worth printing. Why? It's not because it's too long, too short, or badly programmed. The reason a lot of programs fail to get on these pages is a lack of imagination.

If you want to guarantee your program a place on the most coveted listings pages this side of Venus, there's one simple rule to stick to - make it original! We've had thousands of file copiers, maths programs, graph drawers, etc. Why not try adding a twist? Why not take an old idea and give it a bit of life? Also, try sending in modifications to old Type-ins. If we get enough we might try starting a regular feature of updates for popular programs.

Finally, don't worry about listings being too short. If your program does the job and is still incredibly short, so much the better.

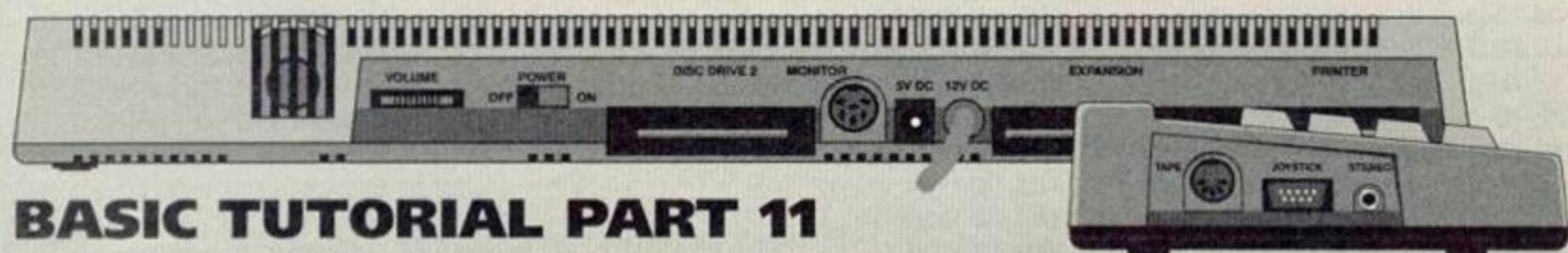

BASIC TUTORIAL PART 11

Last month we examined the password routine in detail and saw that, by combining BASIC constructs such as ON BREAK with simple string checking code we could work up an – albeit minimal and rudimentary – form of password protection. Here it is for those who missed it:

```

5 REM This is a program to count the
characters in a string
10 VALID$="valid"
15 ON BREAK GOSUB 500
20 FOR CNT=1 to 5
30 etc

500 REM This code checks for a valid code
examination
510 CLS: LOCATE 15,7
520 PRINT "ACCESS ATTEMPT – ENTER
PASSWORD"
530 LOCATE 20,10
540 INPUT "Enter password: "; PASS$
550 IF PASS$="" THEN 540
560 IF ASC(PASS$)<>ASC(VALID$) THEN
CLS:LOCATE 15,15:PRINT "INVALID
PASSWORD": NEW
570 RETURN
  
```

Of course, the password routine in this program doesn't actually stop anyone from running the code – ie by checking that they're valid users, all it does is stop unscrupulous persons from examining what took you hours, days or even weeks of hard work to produce. In other words, it helps to keep out unwanted program crackers, by deleting the code if the 'cracker' doesn't know the password.

BASIC isn't terribly good at providing suitable tools for protection. The password routine given here would probably insult the intelligence of anyone even half familiar with breaking into programs, but it does, at least, serve to illustrate a point. And when you become more

conversant with BASIC and the machine in general, you can write more effective protection routines in both BASIC and machine code (the latter offering the only real solution to effective copy and cracking control).

But what if you want to check user validity before allowing them to even use the program let alone examine its workings? Easy. Simply insert something like this new line 15:

```

5 REM This is a program to count the
characters in a string
10 VALID$="valid"
15 GOSUB 500
20 FOR CNT=1 to 5
30 AS=""
40 INPUT "Please type a string"; AS
50 etc
  
```

Now every time the program is run it will expect the user to hack in a valid password before allowing them to continue operation (and thereby do anything useful). This kind of checking is common on multi-user installations in offices and the like where even operating the computer is limited to the privileged few. If you want to check for valid operation and examination rights, use the ON BREAK GOSUB and the new line GOSUB 500, with slightly amended (separate) routines and two different passwords.

```

5 REM This is a program to count the
characters in a string
10 VALID$="valid": EXAM$="AUTHOR"
15 ON BREAK GOSUB 500
20 GOSUB 600
25 FOR CNT=1 to 5
30 AS=""
40 INPUT "Please type a string"; AS
50 etc
  
```

Here, two levels of password are in effect allowing operation of the program and containing unauthorised examination. You'll come across this kind of user-interrogation, known collectively as testing and branching, throughout your excursions into BASIC programming. It's a useful and does more than simply provide an answer to a computed equation. Look at the following

```

10 INPUT "Would you like to play a
game";AS
20 IF AS="yes" THEN 100
30 PRINT "OK, bye for now"
40 END
100 INPUT "Which level, (H)ard or (E)asy";AS
etc
  
```

When the program is run it interrogates the user as to whether they'd like to play a game or not. If the answer is in the negative, then operation simply falls through to line 30 – a simple goodbye type message, and the program ends. If however, the user wants to play, then operation is restarted from line 100 – the start of the program proper. Line 10 gets a user response, line 20 makes a decision based on that response.

You can also make use of ON GOTO and ON GOSUB when testing and branching by using it to enable the user to select from a range of options, and we'll look at that next month.

So, include plenty of interrogation in your programs – that way, you'll ensure the user is getting exactly what he or she wants from it, and always encode pieces of the program which will be used more than once as subroutines. Unique code can be included in the main part of your program, oft-used stuff as subroutines placed in order at the beginning or end. Try multi-layer protection with one of your programs, and have fun until next month.

Speaking of next month, there'll be some slight changes to Type-Ins. The main difference is that it'll be hosted by Simon Forrester, the newbie here at AA. Also, the tutorial section will be very different. Instead of the usual topics, he'll be dissecting a reader program each month, and taking you through the workings and uses of BASIC that way. There comes a point where you can learn nothing more by reading tutorials, and you've just got to dive straight in, and so that's what we're going to help you to do. Also, from now on, we'd like to see more assembly (machine code) listings in the mag. We've had plenty of tutorials on the subject, so we won't be covering them in that sense, but there's no reason why you shouldn't send your assembly listings in.



Oh wow! It's a CPC464+! We've got one of these in the office, you know!



And here's a CPC6128. Very useful if you want to use this programming column.

AA SMALL ADS

For Sale

LISTINGS - lots of them on 3" disk. Mostly games or graphics, some from 1985, for £3.00 only. From Angela Allum, 22 Point Royal, Bracknell RG12 7HH.

AMSTRAD CPC464+ with colour monitor. One year old, Mini Office 2, some games and manual. Offers around £260. **Phone (060548) 5485 after 6pm.**

AMSTRAD 6128 colour monitor, joystick, printer, tape deck, 85 games, £275 o.n.o. **Tel: 081-460 7079 after 6pm.**

AMSTRAD CPC6128 colour monitor, cassette player with lead. Also printer lead, lots of disks, tapes and books including Mini Office II, Pyradev and many games, £275 o.n.o. **Phone Roger (0646) 684423 after 6pm.**

SPECTOR 5: (STRATEGY) Buy weapons and armour to win all five sectors of an Alien Planet, and dominate the world. 1-2 players. Homebrew. £2.00 + tape/disk. A Swinbourne, 11 Vicarage View, Redditch, Worcs B97 4RF.

DDI DISK DRIVE plus Interface and manual £50. ROM Board with RODOS, Protex, Pascal and 6128 ROM £40. **Tel: Brian (0425) 477229 (Hampshire).**

DISK GAMES for sale, including Lemmings, Turrican, Hollywood and many more. Originals in boxes. **Tel (0582) 606888.**

AMSTRAD 6128 colour monitor, manual, magazines, Datacorder and all leads. Lightgun plus loads of games on disk and tape including some covertapes. £150, no offers. **Call Paul 051-928 3207.**

FOR SALE: Loads of games, tapes only. Titles include Continental Circus, Lotus Esprit, Target Reneage, Wonder Boy, Out Run, Stunt Car Racer. All games for CPC464 only. For a list send an SAE to: Paul Garratt, 28 Howe Dell, Hatfield, Herts AL10 8BD.

AMSTRAD 464 MPI modulator. 10 games, joystick, instruction book, £85 o.n.o. **Tel (0642) 467413.**

SOFT 968 Firmware book for 464/664/6128. ROM routines and explanations. Any reasonable offer. **Tel: Dave 061-427 7222.**

ROMBOARD XTRA (7 sockets) for CPC464, complete with 40025 (CPC6128 system) ROM. Switchable between 464/6128 operating systems. Upgrade your CPC464 for just £40 including P+P. **Phone Tim (0291) 627732 Chepstow.**

AMSTRAD 464 plus with green screen monitor, 1 joystick, many games plus two cartridges, AA mags and manual, £150. **Tel (0482) 795170.**

CPC464 with colour monitor, joystick, manual, 30 games, 25 magazines. £150 o.n.o. or will swap keyboard and cash for 6128 keyboard and manual. **Phone Jimmy on 7998266 anytime.**

AMSTRAD CPC6128 PLUS, colour monitor and paddle controller! Some software, including Mini Office II, £185 o.n.o. **Tel: Chester (0928) 725904.**

ONE THOUSAND games, 84-92, tape and disk from £1. Speech Synth, mono monitor, Light Pen, every Amstrad mag, Multiface, upgrading so all must go. For details **phone Wayne (0532) 572154.**

464+ COLOUR MONITOR, Multiface, DK Tronics Lightpen, 64K expansion, 2 joypads, 4 cartridges, £120 worth of software, 19 copies of AA. Worth £600, accept £320. **Tel: Dean (0253) 770391.** Buyer collects (Fleetwood).

COMPLETE PACKAGE. 464 colour monitor, DDI drive, printer, Light Pen, Multiface 2, 6128 expansion memory, all manuals, £400 worth software, including Mini Office 2, Devpack 80, Tassign, Lemmings, Rick Dangerous 2, Hero Quest, Back to the Future 2 and many more. £200. **Tel: Geoff (0305) 854012.**

ROMBO ROMBOX with Protex and Maxam 1 1/2 ROMS £45. 3.5" second drive with RAM DOS and ROM DOS, £40. RS232 Pace Interface with Commstar software, £35. Multiface 2, £40. **Phone (0271) 24843.**

Wanted

DOOMDARKS REVENGE by Mike Singleton wanted desperately for the Amstrad CPC464 on cassette. Will pay £10 for working boxed tape. Write to: Paul Suttle, 11 Bath Place, Margate, Kent CT9 2BN.

OLD 464 GAME Who Dares Wins Two, desperately wanted, will pay reasonable price. **Contact Craig on (0670) 855013.** Please help!

AMSTRAD ACTION magazines, issues 1-19 and 22-45. Also wanted the following games, on disk. Grand Prix Circuit, The Cycles, Lotus Exprit Turbo Challenge, Super Monaco GP and Dominator. Nigel Soal, 12 St Margarets Avenue, Sidcup, Kent DA15 7NP.

WANTED: SSA1 Speech Synthesizer or Modulator for CPC464. Will swap Multiface 2 Lightgun Phaser and games, or Quickshot Aviator joystick. Swap 1 for 1. Interested? Write to: Richard Latham, 31 Oriol House, Black Cat Close, Birmingham B37 5DG.

DDI-1 DISK DRIVE wanted with Interface. Reasonable price for unit in good condition. Chris Rivers, 1 The Butts, Steeple Ashton, Near Trowbridge, Wiltshire. **Tel (0380) 870782.**

AMSTRAD 6128 with colour monitor. I must buy one - mine is bust. Good price paid. **Tel (0536) 518780 (Kettering).** **JACK NICKLAUS** Golf disk wanted. **Tel (0734) 596884.**

DESPERATELY NEEDED! Devpac Assembler from AA71 also magazine issue if possible - pay cover price + postage. Also AA72 magazine only. **Call Paul 051-928 3207 anytime.**

PENPALS WANTED - male or female especially 6128 owners for swaps, info etc. Also games for sale: Wrestlemania, Moonwalker, Starwars. Write to: Teresa or Mark, 28 The Rally, Arlesey, Beds SG15 6UJ.

DOES ANYONE out there have a copy of Poolmaster on tape? **Phone Bill 061-436 1812.**

ELITE on disk. Will pay the original price. Wanted desperately. Stuart Henshall, Flat 49, University Hall, Parry's Lane, Bristol BS9 1AR.

WANTED DESPERATELY. North and South, Nightbreed Adventure for the CPC464, tape only. Will pay up to £9 each. **Phone (0376) 516352 (Ian) (Witham).**

FREE BASIC Programming help. Send specific enquiry (I don't have time to run a correspondence course!) with SAE to: Sean McManus, 226 Chertsey Rise, Stevenage, Herts SG2 9JQ.

FREE! BASIC and assembly language programming advice for everyone! Don't forget to send an SAE to: Robin Gilbert, 9 Brynglas Terrace, Pyle, Mid Glamorgan CF33 6AG.

BROKEN JOYSTICK? For cheap repair call Wrexham (0978) 362808 after 6pm and ask for Martin. Send to 19A, Kenyon Avenue, Wrexham, North Wales LL11 2SP.

DEMON PD LIBRARY the largest CPC Library in the UK with over 300 selections at only 50p each! Write to: 47 Hilton Avenue, Hall Green, Birmingham B28 0PE.

TUCK PD - for a stock list and more details send an SAE to: Matthew Tuck, 15 Ravencar Road, Eckington, Sheffield S31 9GJ.

PD FUN!!! For a free catalogue send an SAE to: 41 Mitchelgate, Kirkby, Lonsdale Via Carnforth, Lancs LA6 2BE. We offer 100% fun! Games, demos, adventures and more (nothing boring).

Other

WILL SWAP MY Amstrad Digital drum system for use on 464 664 6128 for any game on the 464+ machine. **Call Dave (0222) 860581 (Caerphilly).**

NUMEROUS CASSETTE Compilations (History in The Making, Go Crazy, Five Star) swap for console, disk games (Rainbow Islands, Pang, Toki, Protex, RoboCop 2, Space Gun, Addams Family, X-Out). **Tel (0935) 25974.**

I WANT TO SWAP my Tamiya Radio controlled car for a CPC6128 with a cassette datacorder. Can't be bad! **Tel: Gareth (0691) 778493.**

MAN UTD FANZINE coming out. It'll grow with support, £1. 'Football Premier' Fanzine on all your results, letters, predictions and more, £1.50. To order: **ring 061-799 4533 and ask for Matt.**

HARD CORE PD is open for orders. For details send SAE to: Hard Core PD, 'Bradda' Crowborough Road, Georgeham, North Devon EX33 1JZ. You choose the programs you want!

Services

AMSTRAD HOME programmed computer games for sale. Including Adventure and Arcade games. Word processors and other programs. For list, send SAE to: Derek Payne, 89 Wolverhampton Road, Codsall, Wolverhampton WV8 1PL.

ORDER FORM

SEND TO AA SMALL ADS, AD PRODUCTION, FUTURE PUBLISHING LTD, BEAUFORD COURT, 30 MONMOUTH STREET, BATH, AVON BA1 2BW

Please place the following advertisement in the next available issue of *Amstrad Action*

Name

Address

Telephone

Classification. Tick box: For sale Wanted Services User Groups Other

Write your advertisement here, one word per box. Include your name and phone number if you want them



FREE READER ADS!

It's true - from now on you can advertise in *Amstrad Action* for **NOTHING!** It's all part of our continuing efforts to provide you with the best value magazine possible.

Power

Up

ACTION TEST pages 44-49 • ACTION REPLAY pages 56-57 • CHEAT MODE pages 51-54

Hurrah! It's finally arrived and it's absolutely beautiful. What are we talking about? Why, Nigel Mansell's World Championship, of course!



Simon Forrester

We all get the distinct feeling that Simon struck some kind of publicity deal with Nigel Mansell this month, what with his rave review. Why should we think such a strange thing? Well, maybe the new Porsche parked outside AA Towers has got something to do with it. (I wish! Si) Simon spook fact number 528: He's related to Lady Godiva! Yep, the one who rode through Coventry with no clothes on!



Linda Barker

Linda didn't review any games this month, instead she just subbed everybody else's stuff. (It's not true, I did The Popeye Collection! Ed). She's also recently become the proud owner of an orange VW beetle. Stand aside Nigel Mansell, Barker's on the road. Linda spook fact number 834: She can actually stomach (and find) salmon and black pepper flavoured crisps! (I just thought I'd point out that I can't actually drive. Ed) Oh dear!



Jonathan Nash

John, as usual, didn't actually appear in print this month either, but he did a lot of behind-the-scenes work and other such vital what-would-we-do-without-you type stuff. We can't actually tell you what Jonathan's been doing, because a lot of it counts as delicate information! Jonathan spook fact number 395: He's world famous for his collection of Pinky and Perky memorabilia!

Reviewed this month

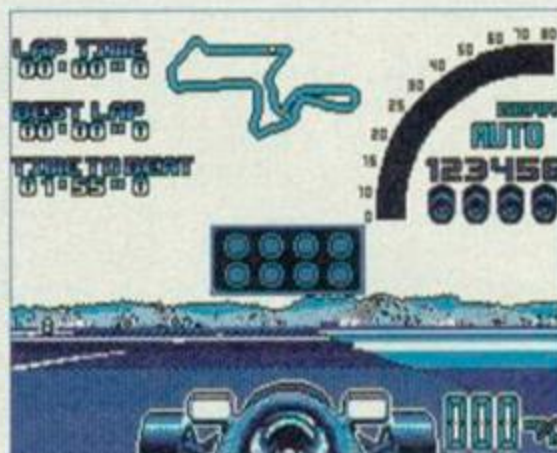

NIGEL MANSELL'S WORLD

CHAMPIONSHIP93%



KIDS PACK 288%

THE POPEYE COLLECTION60%

THE POSTMAN PAT HIT COLLECTION89%

CLASSIC ARCADIA89%

The hit parade

1 NEW ZEALAND STORY Hit Squad

2 DIZZY DOWN THE RAPIDS

CodeMasters

3 DIZZY PRINCE OF YOLKFULK• C/Masters

4 STREET FIGHTER• Kixx

5 BUBBLE DIZZY• C/Masters

6 FUN SCHOOL 2 OVER 8• Hit Squad

7 FUN SCHOOL 2 6-8• Hit Squad

8 LOTUS TURBO CHALLENGE• GBH

9 MINI OFFICE• Alternative

10 MAGICLAND DIZZY• C/Masters

11 FUN SCHOOL 2 U6• Hit Squad

12 CRYSTAL KINGDOM DIZZY• C/Masters

13 PIT FIGHTER• Hit Squad

14 GOLDEN AXE• Tronix

15 BUBBLE BOBBLE• Hit Squad

16 SPELLBOUND DIZZY• C/Masters

17 TRIVIAL PURSUIT• Hit Squad

18 SOCCER DOUBLE• E&J

19 SMASH TV• Hit Squad

20 TERMINATOR 2• Hit Squad



Action

THIS MONTH'S
REPLAY
RE-RELEASES

RB1290%

TERMINATOR 290%



School holidays? Off work? Ready to strangle the kids? Don't. Apart from being highly illegal, it's not very nice. **SIMON FORRESTER** thinks that buying them **Kids Pack 2** from Alternative is a much better option!

This little bundle contains six games - *Count Duckula 2*, *Fireman Sam*, *Popeye*, *Postman Pat 2*, *Huxley Pig* and *Bangers & Mash*. In case you hadn't noticed, some of these are reviewed elsewhere in this issue, so turn a few pages for those reviews, but as for the rest...

Count Duckula 2

No, don't laugh, it's really on here, and it's abysmal. It's a simple platform game with bland monochrome sprites, hideously slow and jerky movement, an ice-skating main figure (it kinda helps if the legs move roughly in time with Duckula's movement) and pathetic moving platforms that don't so much move as vanish and re-appear elsewhere. *Count Duckula 2* isn't a game, a game is fun. This is like sitting your A-levels again.



Count Duckula 2 is as bad as it looks.



Tea, eh? Just what the postman ordered.



Pigs love toast. It's a fact.



KIDS PACK 2

Alternative Software ■ £9.99 cassette ■ 0977 797777

Heaven knows why it was released the first time round, let alone put out again. In fact, it doesn't even deserve a ratings box. (You can't do that, it's got to have a score. Ed) Oh okay, how about zero? (Come on, Ed) Alright, it can have a crap 2%

2%

Fireman Sam

That's *Postman Pat*! No it's not. It's *Fireman Sam*. It may look pretty similar, but there are major differences. The fire engine is faster than Pat's van and there's lots of little subgames to have fun with too. These can vary from platform games to putting out fires, finding skateboards and getting kites off roofs.

Fireman Sam is a slightly more frantic version of *Postman Pat*, with loads more arm work and less time to doze.

The only drawback is the loading system. The main game loads all at once, but the bits which involve putting out fires, climbing up the sides of houses and the like, load separately. Still, the newfangled kids of today should be able to figure it out. That said, don't ever make the mistake of thinking this is just for kids. If a twenty year old reviewer can sit and get addicted to this stuff, it really does deserve to be taken seriously!

84%

Huxley Pig

The obvious reaction to this game would be 'Wow!' considering the excellent TV series, and the loading sequence does nothing to quench your enthusiasm. It loads. You press fire. You see the graphics. You move around the house. Scream. 'It's Craaaap!' Don't despair, things could be worse. They get worse.

The game is based more around a bloke avoiding spiders than Huxley, looking slightly over-done and moving like he's broken both his legs, interacting with his friends. Yet another opportunity for a fun licence has been wasted.

38%

Bangers & Mash

Oh no! It's the one with the theme tune by Chas 'n' Dave! *Bangers & Mash*, *Bangers & Mash*, *Rabbit Rabbit Rabbit Wotcha Rabbit Rabbit Rabbit Wotcha Bangers & Mash*. Classic musicians. (It took him two hours to work that out. Ed)

Bangers (or is it *Mash*?) is a rather acrobatic, chimp who has to jump along the jungly platforms and collect fruit (for his mum's pies) and diamonds (for points). At the same time he's

got to stun, and escape from, the baddies.

The graphics are reminiscent of an enlarged *Rick Dangerous* and the sound is limited to appropriate spot effects and a nice meandering little tune whenever a ghost or witch is near.

Death, though inevitable, is especially irritating in *B & M*, as it comes in the most unexpected forms. A witch may fly up directly underneath you, and you'll die. Or maybe you'll jump and the screen will scroll upwards, you'll hit a previously unseen ghost, and you'll die. Failing that, you'll be standing on a platform, a poisonous plant will grow where you're standing, and you'll die. Persevere and you'll survive!

Bangers & Mash is definitely one of the better games on this compilation. It's fun to play, challenging, and teasing. Each time you play you do progress a little further, though expect to find toothmarks in your joystick! It can get very frustrating.

85%

By the way, *Postman Pat 2* is reviewed on page 48 and *Popeye* on page 45. Both games have been taken into consideration when awarding an overall mark.

VERDICT

GRAPHICS

You'd have to play it to realize just how nice some of these graphics really are.

88%

SONICS

Sonically restricted, but the whine doesn't grate and a nice tune sets the whole thing off.

78%

GRAB FACTOR

This game will leap out of your CPC, grab you by the ears and scream in your face - it grabs you.

89%

STAYING POWER

It maybe easy, but it's fun, and you'll go back again and again.

88%

This is probably the most beautiful game you'll see for quite a while.

RATING 88%

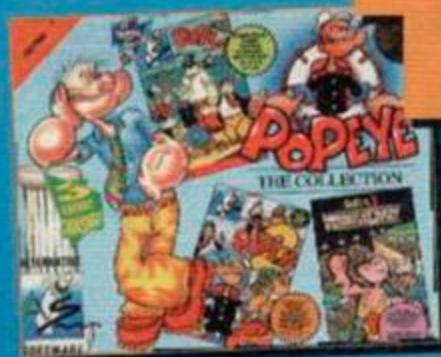

The Popeye Collection

Alternative ■ 0977 797777 ■ £6.99 cassette

Blistering barnacles and shiver me timbers if it ain't Popeye! LINDA BARKER checks her sea legs and wades in...

Popeye is a perennial favourite, these Killer Tomatoes may come and go but the world's most famous sailorman lives on in these three games from Alternative. What a shame then, that they're not that good. Actually, that's a bit unfair cos Popeye is a bit of a laugh and Popeye 2 does have its good bits. Anyway, lets take a look at them one by one, shall we?

Popeye

This is undoubtedly the best of the bunch - it's big, it's blocky and it's a bit beaut! The sprites are massive and dead colourful yet, despite their bulk, they manage to move with ease. You play the part of our Pops and you have to collect enough hearts to convince the fickle Olive that you really love her. If you don't... well, she might just run off with that brute Bluto.

Popeye is kind of 3D, its difficult to explain but you can take refuge in doorways and window alcoves. Y'see, even though they look exactly like the rest of the scenery, they are actually set back from the rest. As well as being very clever, this is also very useful and is therefore a very good thing. So whenever Bluto comes blundering towards you, or a vicious vulture vrooms straight for your jugular - find a doorway! Ah, talking of doorways, you need to collect keys too as these give you access to other areas of the game.

As for the baddies, they seem to have absolutely no connection with the game, or with each other - apart from the fact that they all knock you out. I mean, one minute you're fighting off a witch and the next a floating shark knocks you out! It's mad. It's also quite a laugh.

80%



You've been a swell crowd - I love you all!



What a smart Tonka toy!

Popeye 2

Oh no, that silly sausage Olive has gone and fallen foul of Bluto's burly biceps! He's grabbed her and made a run for it and you've got to save your babe. Lucky ol' Olive, eh? Popeye 2 is a platform game and it looks lovely. The characters, the platforms, the ladders and the various bits and bobs are all beautifully drawn. It really does look like it's going to be a complete treat to play.

But wouldn't you just know it - appearances are playing that old deceiving trick again. Popeye 2 plays like a particularly spoilt child losing at Frustration - badly! The little Popeye sprite is wonderful until you actually try moving him. It's at this point that you begin to realise that this isn't going to be the pleasant experience that you were anticipating.

Popeye insists on falling down gaps rather than jumping over them and sometimes refuses to get off the ladders when you want him to. What's more, he has a marked fondness for death. Death comes in many guises but, whatever the means, Popeye always falls flat on his back with a rather large pot-belly stuck in the air. This confuses me. Popeye, standing upright, looks like rather a thin little chap - where does this belly come from? Oh well, pot-belly or no pot-belly - it's still not a very good game.

65%



He'll never fit in that little box!



I thought carrots made you yellow?

Popeye 3

Popeye 3 isn't very good at all because the basic concept behind Popeye 3 is crap. It really does seem as if Alternative thought they should get in on the wrestling thang, and quickly. So they came up with the idea of some alien fiends called KRAGGS kidnapping Popeye and forcing him to save the earth by, erm, wrestling. The gameplay was tied to this conceptual plot and it really shows. The main sprites are murky and undefined and the gameplay is simply dull. Popeye 3 doesn't work as a wrestling game. You could have fun with it, but not for very long.

50%

VERDICT

GRAPHICS

Popeye 1 and 2 look pretty darn good. Both are pretty darn good, Popeye 3 has smart aliens.

85%

SONICS

We've got the Popeye theme tune and various blips and blops. Good, but not great.

70%

GRAB FACTOR

These games are easy to grasp and quite easy to settle down with - but for how long?

70%

STAYING POWER

You'll play Popeye for ages, Popeye 2 for a while and Popeye 3 is only for serious wrestling fans.

50%

Popeye is the only game of the three that you should own. The other two are okay, but nothing special at all.

RATING 60%



Nigel Mansell's World Championship

Gremlin ■ 0742 753423 ■ £15.99 disk

The true British classics, eh? Monty Python, Carry On films, Gazza and now, says SIMON FORRESTER, Nigel Mansell (and his fairly natty set of wheels)...

Okay, so Gazza is a bit of an idiot, and Carry On films aren't exactly tasteful, but Monty Python and Nige make us all stand proud. We at AA towers awaited the CPC version of *Mansell* with baited breath, hoping that it would measure up to what we'd seen on other formats.

When you first run *Mansell*, you'll see a Gremlin logo, and think 'Hmm... that's pretty'. If this is the case, the odds are you'll probably spit your teeth out once the main game gets going. You're



What a logo! What a world! Have you ever seen anything so absolutely gorgeous?

greeted with some of the most beautiful graphics ever to grace the CPC. Forget demos – they're all the same anyway. Just spend a while playing *Mansell* to find out what your machine can really do with some decent software.

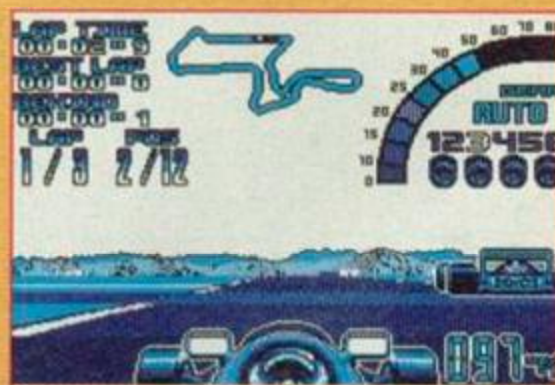

It's a very blue kind if game is Nigel Mansell's World Championship.

We've all heard this kind of slobbering rant several times before, and we all know that beautiful sounds and graphics do not a stunning game make. So it's time to prise open the box and check under the hood, so to speak!

Nigel Mansell's World Championship is a, erm, racing game. Basically. (We gathered that. Ed). Okay, right – you, as Nigel Mansell, burn round as many courses as you can and get to be the world champion a lot. If this sounds a bit limiting, don't worry – it's not. You work your way round the world, with plenty of different tracks, varying weather conditions (which you must accommodate by modifying your car), and

Possible Downers

DISK FLIPPING

So, you've loaded the game and you want to get burning. That's all very well, but with a game this size, it would have been impossible to fit it on to one side of a disk. This does have quite an unfortunate effect – you'll have to do a lot of side-swapping throughout the various sequences in the game. This isn't too much of a hindrance, but there seems to have been very little planning as to what section goes where. For example, you'll sometimes find yourself swapping to the other side just to display the leaderboard, and then swapping back again. It's hardly a major flaw, but it could mar your enjoyment slightly.

CASSETTES?

Now, for all you 464 owners who are slightly miffed at missing out on such a great game, you still have a chance. Gremlin aren't sure whether a cassette version will be released, but there's an outside chance. We must stress the word outside here, as the game wouldn't really lend itself to a huge multiloader. However, no doubt thousands of 464 owners will give Gremlin untold grief until they release a tape version that, due to the nature of the game, would be abysmal. You'd spend most of your time rewinding cassettes, screaming at tape loaders, and getting annoyed with tape counters. Sorry and everything!



Some lovely huge graphics on the joystick-controlled main menu screen.

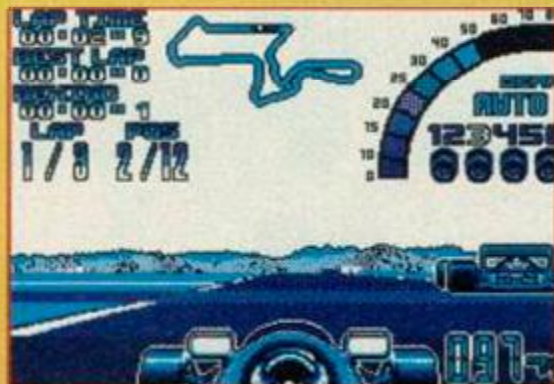

It's like a busy shopping day in Bath city centre minus the gawping grannies.



A nice open stretch and a chance to get some speed up, ready to fly off a corner!



That flag at the top means you're on your last lap of the circuit.



I wonder who sponsored this license then? Was it Ford? How about Fiat? Ferrari? Lotus? Honda? Or maybe Renault...

various opponents. In each race, you must first qualify to decide your position on the grid. The qualifying race usually consists of two to three laps. After that, you'll be entered in the 'real' race, where twelve of the best drivers in your field are waiting to destroy and humiliate you. After the race comes the award ceremony, complete with a podium (no champagne though), and a chance to view the leaderboard to see just where you are in the big scheme of things.

If you're not exactly God's gift to drivers, you have the option to go to driving school, which involves whizzing round the track a few times in order to get the hang of the game (a nice idea), and check out the competition.

It's weird. The only way to describe it is that it's as if someone really loved this game and spent all their time working on it until there was absolutely nothing more they could possibly add. When you want to modify your car to handle varying weather conditions, etc, there's this lovely sideways view of the car, and any alteration you select is played out via an animated sequence. At the beginning of the whole game, you are presented with a spinning globe, stopping at your current location. The options menu has some of the most scrumptious



icons you're ever likely to see, and all the menus throughout the game are joystick controlled and beautifully presented. (By Jove, I think he rather likes it. Ed)

Another thing you'll notice about *Mansell* is that it runs at incredible speeds. Granted, the screen update is slow, but this doesn't seem to impair the game play, as it seems to create the impression that your car's going really fast. I suppose that what I'm trying to say is that it isn't at all flickery in the conventional sense.

There are varying difficulty levels and the easier ones are quite unbelievably, erm, easy. Once you've been on one practise run, you'll be able to handle the car with no problems, and you'll probably find yourself well ahead of the other drivers whether you started in pole position or not. But don't for a minute you go thinking that this detracts from the gameplay, because it doesn't! We all know just how irritating it is to play a racing game, make a slight slip, and know that no matter what you do in the next few laps, you've lost and won't qualify for the main event. It makes a nice change to actually play a game where you stand at least a fighting chance of progressing. Still, even on the easier levels there are a few challenges. Overtaking, for example, is very difficult, as *Mansell* didn't seem to be at the front of the queue when they handed out track width.

And of course, once you've got the hang of things, you can try out the harder levels.

So what separates this game from the average driving game, such as *Crazy Cars III* last month? Well, the emphasis in *CC3* is on money. That's all very well, but *Mansell* allows you to explore all the lovely things you can do to your car without worrying about cash. It also lets you advance around the world freely, as your progress depends on your skill rather than your



A gorgeous animated sequence accompanies any changes you make to your car.

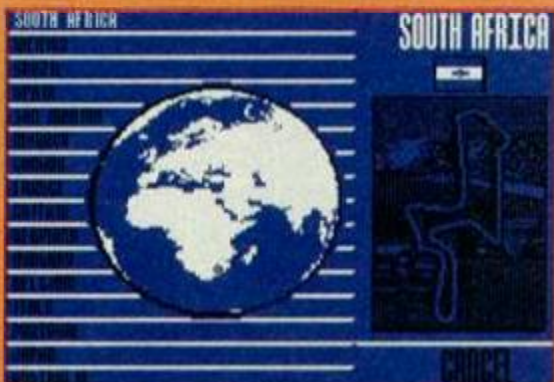

You can select various courses around the world with this spinning globe.



I was wondering how I'd survive without my daily dose of Nige... Thank heavens for Gremlin Graphics!

luck at betting. Also, you're racing against a more logical opposition, as opposed to cars that just appear out of nowhere. When you overtake the pack, you don't have to dodge cars, just stay in the lead (unless you lap them - ahem).

Flashy bits aside, *Mansell* is a very enjoyable game. Of course, if you don't like racing games, then don't bother, but if you do then this is most definitely one of the best there is.

If, however, you're not into this kind of thing, don't worry, because neither was a certain staff writer before seeing probably the best racing game released to date.

VERDICT

GRAPHICS

You have to play it to realize just how wonderful these graphics really are. Buy it!

97%

SONICS

Sonically restricted, but the whine doesn't grate and a nice tune starts the whole thing off.

86%

GRAB FACTOR

This game will leap out of your CPC, grab you by the ears and scream in your face - it grabs you.

94%

STAYING POWER

It maybe easy, but it's fun, and you'll go back again and again.

88%

This is probably the most beautiful game you'll see for quite a while.

RATING 93%

The Postman Pat Hit Collection



Alternative Software ■ £6.99 cassette ■ (0977) 797777

You've seen the film. You've read the book and heard the hit rave theme. Now play the games. That's what **SIMON FORRESTER'S** done!

First there was *Pat*. In *Pat 2*, the battle continues. *Pat 3* sees the final battle against rising postal costs with Pat sporting an Uzi and bandana. (He lives in his own world, y'know. Ed)

Postman Pat

PP sees you on a basic delivery run on a standard sunny day. No aliens, no bad guys, no ramps, jeeps or rocket launchers – just Pat, the cat, and the van. This game is blissfully puerile. The most you will ever have to worry about is getting Miss Hubbard's prescription to the chemist's, and drinking tea with the postmistress. When you're not leading this frantic social life, you're lazily driving around in this funky roadster of a Pat van. If you can't find your way to the doctor's house, don't worry – just keep driving round until you find it. Backwards if you want – nobody cares.

This game is absolutely perfect for its target age group. It doesn't have power-ups, continues, guns, or anything that anyone could possibly object to. It's just plain nice. The one mistake to



Not so much Paperboy as Paperpat!



Burning up the village in *Pat 1*.



There's lots of nice locations in *PP1*.

make would be to restrict this masterpiece to children. Everybody should try to live like this. (Like, wow man!)

If you don't fall in love with this game, something is quite obviously hideously wrong with you.

90%

Postman Pat 2

He's back, he's mean, and he's broken his van. That's why he's on foot, and that's why they haven't bothered with the colour red.

Pat 2 is a lot like *Pat 1*, but with a little less reliance on the cute factor. In fact, the emphasis seems to be on more lifelike characters, that aren't in the least bit cuddly.

Graphically, it's a Speccy port (or a very close conversion), and is distinctly unappealing. The addition of a radar to help you seems a little tacky, as do the moving counters representing other characters. Stylewise, it's a fast version of *Tir Na Nog*, with the added bonus of being able to tell which way you're facing.

Pat 2 turns a lazy drive round town into a boring trudge round the streets, and the colours give the impression that it's going to rain any minute.

51%

Postman Pat 3

Oh no! Delivery man Dan has broken his leg! Who will deliver all those phone directories? If you



Eek! It's the rozzers! We've been rumbled!

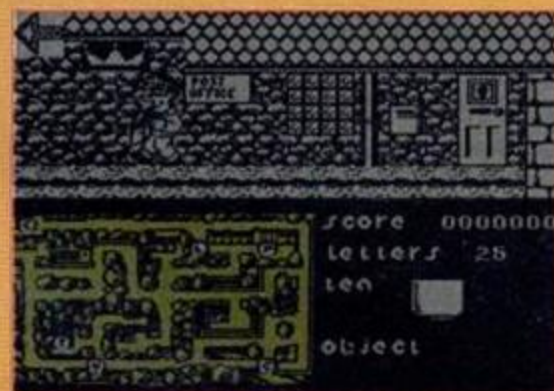

More Speccy port action in *PP2*.

have a problem, if no-one else can help, and if you can find him, maybe you could hire Pat.

Paperboy fans will love this one. It runs in overhead view, a view that sees Pat screaming down a road chucking phone books at houses. That's not all. There are roadworks and other cars to avoid, as well as the police who, however cuddly, probably have a distinctly unsavoury cell waiting for Pat.

You must deliver a set number of directories to specified houses within a certain time limit. It seems logical that the roads get progressively harder through the game, but this is not all that evident. All in all, it's a nice way to round off the collection.

84%

VERDICT

GRAPHICS

The emphasis here is definitely on cute, but what's wrong with that, eh?

83%

SONICS

There's only so much you can do with van noises, and these games don't exactly stretch the limits!

53%

GRAB FACTOR

Quite frankly, if this stuff doesn't appeal to you, there has to be something wrong!

88%

STAYING POWER

They will be played quite a bit, if not just to complete the various tasks throughout the game.

85%

Never before has the CPC seen such hideously cute releases. We love this stuff!

RATING 89%

WIZARD GAMES

1 NORTH MARINE ROAD, SCARBOROUGH, NORTH YORKSHIRE, YO12 7EY
 IF YOU'RE IN THE SCARBOROUGH AREA, COME IN AND SEE US.
 OPEN 9am -5.30pm 6 DAYS A WEEK. TEL: 0723 376586

AMSTRAD DISKS

ACTION FORCE.....	£5.99	LOOPZ 2 COLLECTION.....	£9.99
D.A.T.....	£7.99	EMLYN HUGHES ARCADE QUIZ/HELTER	
CLUEDO.....	£7.99	SKELTER KICK OFF COLLECTION	
CAPTAIN PLANET.....	£6.99	3 FOOTBALL GAMES.....	£9.99
COLOSSUS CHESS.....	£6.99	MONTY PYTHON'S FLYING CIRCUS.....	£6.99
CISO HEAT.....	£7.99	MERCS.....	£9.99
DAN DARE III.....	£5.99	LOTUS ESPRIT TURBO CHALL.....	£9.99
DARK SCEPTRE.....	£6.99	LEMMINGS.....	£11.99
DALEY THOMPSON'S OLYMPIC		MAXIM II MACRO ASSEMBLER, EDITOR,	
CHALLENGE.....	£9.99	MONITOR CPC 6128/CPW 8256-8512	£11.99
DOUBLE DRAGON/RODLANDS.....	£9.99	NEW YORK WARRIORS.....	£6.99
DARK FORCE NIGHT BREED/ MIDNIGHT RESS.....	£9.99	NINJA REMIX.....	£6.99
BATTLE OF THE BULGE.....	£9.99	POP UP.....	£6.99
BACK TO THE FUTURE		NO LIMITS-UN SQUADRON/STRIDER 2.....	£9.99
PARTS II + III.....	£9.99	OUT RUN EUROPA + G LOC.....	£9.99
FAIRLIGHT.....	£9.99	PIT FIGHTER.....	£6.99
FUN SCHOOL 3 5-7 YRS.....	£10.99	RODLANDS.....	£5.99
FUN SCHOOL 4 UNDER 5's.....	£10.99	SHADOW DANCER/ALIEN STORM.....	£9.99
FUN SCHOOL 3 OVER 7's.....	£10.99	ROCK N ROLL.....	£6.99
EUROPEAN SUPERLEAGUE.....	£8.99	SAINT DRAGON.....	£5.99
GALACTIC GAMES.....	£6.99	TOYOTA CELICIA GT RALLY.....	£9.99
HUNT FOR RED OCTOBER.....	£6.99	TAS SIGN SIGNMAKER FOR CPC 6128/ CPW 8256 + 8512.....	£9.99
I.S.S.....	£6.99	SIM CITY.....	£9.99
SOCCER SPECT (5 GAMES).....	£9.99	TETRIS PCW.....	£9.99
SCRABBLE DELUXE PCW.....	£6.99	TOLKIEN TRILOGY.....	£9.99
SCRABBLE/MONOPOLY/CLUEDO.....	£9.99	THE HOBBIT/LORD OF THE RINGS/ SHADOWS OF MORDOR	
SNOOPY.....	£6.99		
SPORTING TRIANGLES QUIZ.....	£7.99		

AMSTRAD CASSETTE

BLACK TIGER.....	£2.99	NINJA REMIX.....	£2.99
DARKMAN.....	£3.50	PUZZNIC.....	£2.99
HUDSON HAWK.....	£3.50	PIT FIGHTER.....	£2.99
JAHANGIR KHAN SQUASH.....	£2.99	R B I BASEBALL.....	£2.99
LINE OF FIRE.....	£3.00	R TYPE.....	£2.99
MERCS.....	£2.99	SHADOW DANCER/ALIEN STORM.....	£3.99
MYTH.....	£2.99	SUPER SPACE INVADERS.....	£3.50
MIDNIGHT RESISTANCE.....	£2.99	TRIVIAL PURSUIT.....	£3.50
MONTY PYTHON.....	£2.99	WELLTRIS.....	£2.99
MONOPOLY.....	£2.99	WAR IN MIDDLE EARTH.....	£2.99

COMPILATIONS

FISTS OF FURY 2.....	£4.99	SHINOBI/DYNAMITE DUX/NINJA WARRIORS/DOUBLE DRAGON 2	
KIDS PACK 1.....	£6.99	POSTMAN PAT/POPEYE/SOOTY + SWEEP/WOMBLES/ SUPER TED/COUNT DUCKULA	
KIDS PACK 2.....	£8.99	FIREMAN SAM/COUNT DUCKULA 2/POPEYE/POSTMAN PAT 2 /HUXLEY PIG/BANGERS + MASH	
GRANDSTAND.....	£5.99	GAZZA'S SUPER SOCCER/PRO TENNIS TOUR/WORLD CLASS LEADERBOARD/CONT CIRCUS	
SUPER HEROES.....	£5.99	LAST NINJA 2/THE SPY WHO LOVED ME/INDIANA JONES LAST CRUSADE/STRIDER 2	
MEGAMIX.....	£4.99	OPERATION WOLF/DRAGON NINJA/REAL GHOSTBUSTERS/ BARBARIAN II	
THE BIZ.....	£4.99	DOUBLE DRAGON/R TYPE/OPERATION WOLF/BATMAN	
POSTMAN PAT COLLECTION.....	£6.99	POSTMAN PAT 1, 2 + 3	
POPEYE COLLECTION.....	£6.99	POPEYE 1, 2 + 3	
GINORMOUS PACK.....	£9.99	RED ARROWS/ARMY MOVES/GRID IRON 2/PRO MOUNTAIN BIKE SIMULATOR/BMX NINJA/RUGBY BOSS/EVERYONE'S A WALLY/SOCCER CHALLENGE/THE REAL STUNT EXPERTS/COMBAT ZONE/SOCCER BOSS/RUN FOR GOLD/DEAD OR ALIVE/TURBO BIKE/AUSTRALIAN RULES FOOTBALL/GUN BOAT/PUNCH + JUDY/GAME OVER/RALLY DRIVER/STRIKE FORCE COBRE	

NEW TITLES ARRIVING DAILY ALL FORMATS PHONE FOR DETAILS

GAMES SUBJECT TO AVAILABILITY. PRICES INCLUDE POSTAGE + PACKING. PLEASE NOTE - A PHONE CALL RESERVES YOUR ORDER.
 CHEQUES + POSTAL ORDERS MADE PAYABLE TO WIZARD GAMES.
 PLEASE ALLOW 7 DAYS FOR DELIVERY

ADVERTISERS INDEX

AVATAR	17
BOXFORM	49
C.A.V.E. ELECTRONICS	OBC
DATTEL ELECTRONICS	IBC
G.V.L. MICROFORM	11
M.J.C. SUPPLIES	18
O.J. SOFTWARE	36
P.R. FREEDMAN	17
ROMANTIC ROBOT	11
SILICA SYSTEMS	27, 35
SIREN SOFTWARE	11
SOFTWARE CITY	41
TRADING POST	36
WIZARD GAMES	49
W.T.S. ELECTRONICS	49

ONLY POOLS AND HORSES

FOOTBALL BOXFORM The ONLY pools program written by a GENUINE EXPERT who has been employed as such by Littlewoods. He KNOWS how to help you win. He can't guarantee you'll become a millionaire (if he could he'd be one himself) but he can GREATLY IMPROVE YOUR CHANCES OF WINNING ON THE POOLS OR FIXED ODDS. The program consistently forecasts 50% more draws than would be expected by chance... A.P.C.W. mag. A RECORD UNMATCHED BY ANY OTHER PROGRAM OR POOLS EXPERT. Homes, aways, draws shown in order of merit. True odds for every match. Covers league & non league. Australian Pools program included in the price.

SUPER PLANNER THE BEST PERM GUIDE OF ALL TIME. Details of OVER 400 ENTRIES of LIT, V- and newspaper plans and perms. ALL CHECKED IN SECONDS by your computer.

RACING BOXFORM Fast and profitable. Quite remarkable results. strike rate of 64.8% averaging 3/1 per winner. G.S.U.G. mag. Price includes HANDICAP WINNER 1000 Winners every year - 25% of 5/1 or better.

PRICES \$21.95 for one, \$32.95 any two, \$42.95 all three.

FOOTBALL TOOL KIT Football Boxform, Super Planner, Littlewoods Block Perms Planner, program to work out bets, Dividend Forecaster. £39.95

RACING TOOL KIT Racing Boxform plus 5 further programs which enable you to keep your own records, produce and amend form and time ratings, work out almost any bet... £39.95

PLEASE MAKE CHEQUES OR POSTAL ORDERS PAYABLE TO: BOXFORM

BOXFORM [AA] 65 Allans Meadow Neston, South Wirral, L64 9SQ Tel: 051 336 2668

SPECIAL OFFER
 BOTH
 TOOL KITS
 £64.95



COMPUTER REPAIRS

★ AMSTRAD AUTHORISED ★

Quality Assured!



- ★ Fixed price repairs on many machines
- ★ Over 2500 square foot engineering complex
- ★ Top quality technicians at your disposal
- ★ All work warranted
- ★ Fast turnaround
- ★ Simply post or hand deliver your machine and we will do the rest

Please supply evening and daytime telephone numbers

Amstrad 464	£37.00
Amstrad 6128	£41.00 (extra if disk drive needs complete replacement)
All monitors	£15.00 Diagnostic charge plus quote
Others	P.O.A.

WTS Electronics Ltd reserve the right to refuse machines that in their opinion are beyond reasonable repair. Full charge applies.

Tel: 0582 491949 (4 lines)

WTS Electronics Ltd, Chaul End Lane, Luton, Beds LU4 8EZ



Classic Arcadia Collection

Alternative Software ■ £4.99 cassette ■ (0977) 797777

Question: Do classic old arcade games that were a big hit in the old days need a re-release now? **SIMON FORRESTER** has a ponder.

Well, the answer to that very question depends both on the games and whether you were around when these games were the 'in thing'.

Classic Arcadia Collection consists of six of the earliest (and some believe the best) games ever seen: *Invaders*, *Axiens*, *Muncher*, *Missile*, *Crazy Er*ert* (I never did understand why the star was there. Is Er*ert a swear word, or something?), and *Grebit*. For all those who quietly snigger at games like this whilst loading up *Blasterzombiephaze*, just remember that these games were the predecessors to all the techojunk floating around.

So... The games. Graphically and sonically, these games won't astound you. On the plus side though is the fact that, that from a programmer's point of view, the whole selection is very tightly designed. For anyone who's never played any of these oldies, here they are one by one.

Invaders

This is the standard shoot-em-up (I can't believe I'm explaining *Invaders*). Take away all the



Classic Invaders action - we love it!



What exactly, if anything, is a Pac?



Oh no! The invaders are fighting back!

phazers, smart bombs, thrusters, etc and you're left with something like the screenshot. The block of ships at the top move left and right, gradually getting lower, and your mission is to kill them. Basically.

As a faithful representation of an all-time classic, this has to be worth a second look.

73%

Axiens

In the history of shoot-em-ups, this came next. It involves the same old *Space Invaders* stuff (no doubt something to do with it being a straight conversion of *Galaxians!*), but with the invaders bombing down the screen with the intention of severely hurting you. There's enough extras here to make this a darn playable game.

67%

Muncher

You've seen it on the covertape, you've played it to death. Now buy an official version and play that to death as well.

Muncher is nice as a *PacMan* clone but it doesn't really gel. Come to think of it, maybe the original didn't either...

55%

Missile

This one involves an alien race attempting to blow you to smithereens. And, erm, that's it. If you're looking for fast fun and excitement then this game is definitely one to be avoided.

30%

Crazy Er*ert

This was known as 'The Game That No-One Could Control' and it's just as blimmin' difficult today. The easiest way to describe this game is as an isometric beat'em-up on a mountain. (You have to change the colour of the blocks by jumping up and down on them. Ed)

It's too confusing, and it really isn't much fun. Another duff one, methinks.

47%



Could you run those keys by me again?

Grebit

If you've ever played *Frogger*, then you'll understand *Grebit*. The idea is to guide your frogs across a busy road, and to the safety of a lily pad on the other side.

Frogger is as *Frogger* does, it wasn't all that thrilling then and, well, you can work out the rest yourself.

67%

So, we've seen a bundle of old classics, some good, some bad. But whether a collection such as this is worthy of a re-release is debatable. In the end, it's got to be subjective. Remember though that this stuff started tit all.

VERDICT

GRAPHICS

They're faithful to the originals but, still, they're not exactly impressive.

69%

SONICS

Don't expect miracles here either - the odd beep or rasp is all you'll get out of these.

63%

GRAB FACTOR

As with all the early stuff, their simplicity will definitely grab you. These were here first, remember!

86%

STAYING POWER

The fascination will wear off, but not before you've played some of them to death.

75%

A nice package giving faithful covers of the old classics. Worthwhile for posterity, and fun

RATING 80%

Cheat Mode

That Phil Howard, eh? What a chap and no mistake. Once you've worked your way through his cheats special (back on page 12) get going with this little lot. Does this man never rest? Save Phil a bit of work by sending in YOUR maps, cheats, tips and pokes to Cheat Mode, Amstrad Action, Beauford Court, 30 Monmouth Street, Bath, Avon BA1 2BW.

POKEs for CodeMasters compilations are this month's flavour to be savoured. Dug up from past issues and requested by lots (and lots) of people are the following tape cheats. Most of the Quattro cheats will work on the individual games if you have them.

The Quattro compilations...

Adventure, Arcade, Cartoon, Combat, Firepower, Power, Racer, and Superhits. Dunstable's Andy Price has, in his time, cheated on games almost too numerous to mention, here are some.

Quattro Adventure:

- Dizzy – Lives
- Vampire – Lives
- Super Robin Hood – Invulnerability
- Ghost Hunters – Start room/energy

Withstand the arrows of outrageous fortune with a few well-placed numbers!



- HAGF 1.' Quattro Adventure
- EADF 2.' by ANDY PRICE
- AAMH 5.'
- FAJC 10·DATA·2a,30,3d,22,2d
- FAJI 20·DATA·be,ac,ad,21,37
- FAED 30·DATA·bd,3e,c3,77,23
- EAEN 40·DATA·3e,21,77,23,3e
- EALM 50·DATA·be,77,21,40,00
- EA00 60·DATA·e3,11,00,bb,00
- EAKP 70·DATA·c3,4a,3a,41,50
- FAID 80·DATA·af,32,3a,95,3e
- EAEH 90·DATA·04,32,25,89,00
- FAKF 100·DATA·21,3d,be,22,4f
- FAIL 110·DATA·bf,c3,00,bf,c3
- FAAA 120·DATA·08,13,21,23,be
- FAED 130·DATA·22,e3,39,3e,c3
- EAOM 140·DATA·32,e2,39,21,40
- FAAC 150·DATA·00,11,00,bb,e5
- FANJ 160·DATA·eb,e5,c3,b7,39
- FAJJ 170·DATA·dd,e5,dd,21,91

- FAGG 180·DATA·01,3e,d0,dd,77
- FAOG 190·DATA·00,3e,6f,dd,77
- FACJ 200·DATA·01,3e,cd,dd,77
- FANI 210·DATA·02,dd,e1,f1,f3
- FAFD 220·DATA·c9,3e,34,32,5b
- EAGP 230·DATA·2d,18,c5,00,00
- EABP 240·DATA·06,05,11,00,ac
- FANG 250·DATA·21,20,be,cd,77
- GAFc 260·DATA·bc,eb,cd,83,bc
- FAGM 270·DATA·23,e5,cd,7a,bc
- FAAD 280·DATA·21,1b,be,22,92
- FAMM 290·DATA·ac,c9,3e,ee,32
- FABA 300·DATA·22,61,3e,e9,32
- FAOD 310·DATA·97,6c,c3,d0,76
- FAMA 320·DATA·52,4f,42,49,4e
- EAP0 330·DATA·06,0d,11,00,c0
- FAGK 340·DATA·21,20,be,cd,77
- GAFc 350·DATA·bc,eb,cd,83,bc
- FAGM 360·DATA·23,e5,cd,7a,bc
- FAAJ 370·DATA·21,1b,be,22,fe
- FAPG 380·DATA·a4,c9,3e,e9,32
- FAFD 390·DATA·cf,61,3e,02,32
- FAAD 400·DATA·ca,61,c3,73,61
- EAB0 410·DATA·47,40,4f,53,54
- FAOA 420·DATA·2d,40,55,4e,54
- DABI 430·DATA·45,52,53
- HAPA 440·RESTORE 10:start=&BE00
- GAOP 450·finish=&BE20:GOSUB 770
- FAHP 460·MODE 1:INK 1,15:INK 0,0
- FAFC 470·PRINT 1·Dizzy"
- FAB0 480·PRINT 2·Vampire"
- IAMB 490·PRINT 3·Ghost Hunters"
- IALM 500·PRINT 4·Super Robin Hood"
- IABC 510·PRINT:INPUT"Number)".,no
- GAFP 520·ON no·GOSUB 530,600,650,700
- HABJ 530·RESTORE 80:start=&BE21
- HANA 540·finish=&BE29:GOSUB 770
- JADK 550·CLS:PRINT"Inf lives active"
- JANK 560·INPUT"Speed of Dizzy (1..10)".,s
- HADE 570·POKE &BE26,s:POKE &BE2A,&CF
- HAAE 580·POKE &BE04,&2B:MEMORY &2FFF
- GAPN 590·LOAD"dizzy":CALL &BE00
- HAND 600·RESTORE 100:start=&BE00
- HABA 610·finish=&BE43:GOSUB 770
- JA0B 620·CLS:PRINT"Infinte lives"
- IAOG 630·MEMORY &2FFF:LOAD"vampire"
- DAGB 640·CALL &BE0C
- HAHE 650·RESTORE 330:start=&BE00
- HAGA 660·finish=&BE34:GOSUB 770

- JALO 670·CLS:PRINT"Invulnerability"
- LAPC 680·PRINT:INPUT"Enter start room";r
- GAPD 690·POKE &BE21,r:CALL &BE00
- HADE 700·RESTORE 240:start=&BE00
- HARB 710·finish=&BE2C:GOSUB 770
- MADI 720·CLS:PRINT"Invulnerability active"
- JAMX 730·PRINT:INPUT"Faster Robin";y†
- GAPP 740·IF LEFT†(y†,1)="n"·THEN 760
- DAII 750·POKE &BE1C,0
- DACA 760·CALL &BE00
- HAFP 770·FOR a=start TO finish
- FAJX 780·READ b†:b=VAL("†"+b†)
- GABJ 790·POKE a,b:NEXT:RETURN

Quattro Arcade:

- Advanced Pinball – Balls
- Fruit Machine – Credits
- 3D Starfighter – Invulnerability
- Grand Prix Sim – Track

Endless cost-effective arcade fun!



- KACJ 1.' Quattro Arcade Cheat System
- EADF 2.' by ANDY PRICE
- AAXH 3.'
- FAAE 10·FOR x=&BE00 TO &BE24
- GALJ 20·READ cd†:cd=VAL("†"+cd†)
- EAGL 30·POKE x,cd:NEXT
- JAJK 40·MODE 1:PEN 2:PRINT"Choose Game:"
- IAOE 50·PEN 1:PRINT 1·Pinball Sim"
- HABP 60·PRINT 2·3D Starfighter"
- GAKN 70·PRINT 3·Grand Prix 2"
- JADA 80·PRINT 4·Fruit Machine Sim"
- HABI 90·PRINT:INPUT"Number:". ,n
- GABH 100·ON n·GOSUB 120,140,160,200
- CANK 110·GOTO 390
- FALP 120·RESTORE 330:GOSUB 220
- CAEJ 130·RETURN
- GABA 140·RESTORE 370:GOSUB 220
- CAGJ 150·RETURN
- KANF 160·PRINT:PRINT"Grand Prix cheat:"
- KAPI 170·PRINT:PRINT"Re-define name as:"
- HACJ 180·PEN 3:PRINT"INTEGRA":PEN 1

BADP 190·RUN""
 FAMP 200·RESTORE·350:GOSUB·220
 CADJ 210·RETURN
 FAII 220·FOR·x=ABE25·TO·ABE2B
 GABP 230·READ·a\$:POKE·x,VAL("&"a\$)
 EAPA 240·NEXT:RETURN
 FAMA 250·DATA·ED,5B,38,BD,ES
 FADA 260·DATA·AC,E1,ED,53,2D
 FABA 270·DATA·BE,AD,11,37,BD
 EABN 280·DATA·3E,C3,12,13,3E
 EACN 290·DATA·25,12,3E,BE,13
 EAPJ 300·DATA·12,21,40,00,E3
 EAKL 310·DATA·11,00,BB,00,C3
 EACL 320·DATA·4A,3A,41,50,00
 EAAO 330·DATA·AF,32,15,04,EE
 EAGI 340·DATA·41,00,00,00,00
 EALP 350·DATA·AF,32,3F,73,EE
 EAIJ 360·DATA·50,00,00,00,00
 EAGO 370·DATA·AF,32,3A,7F,32
 EAIX 380·DATA·15,7F,00,00,00
 EAIA 390·POKE·ABE2C,ACF
 FAFH 400·MEMORY·A2FFF:LOAD""
 CAOP 410·CALL·ABE00

Quattro Cartoon:

Frankenstein Jnr – No ghosts
 Wizard Willy – Lives
 Olli and Lissa 3 – No ghosts
 Little Puff – Invulnerability

GAOH 1·'·Quattro·Cartoon
 EADF 2·'·by·ANDY·PRICE
 AAKH 3·'
 HAGI 4·'·Frank·Jnr:·No·Ghosts
 NABB 5·'·Wizard·Willy:·Inf·lives·&·Firepower
 LAHF 6·'·Little·Puff:·Invulnerability
 IABM 7·'·.....and·move·location
 IAFX 8·'·Ollie·&·Lissa:·No·Ghosts
 AAAI 9·'
 FANI 10·DATA·2a,38,bd,e5,ac
 FAEI 20·DATA·e1,22,2c,be,aa
 FALF 30·DATA·ab,21,37,bd,3e
 EAEN 40·DATA·c3,77,23,3e,23
 FAPA 50·DATA·77,3e,be,23,77
 EABJ 60·DATA·21,40,00,e3,11
 FAEF 70·DATA·00,bb,c3,4a,3a
 FAGC 80·DATA·af,32,05,5d,ee
 FAAD 90·DATA·41,ee,50,cf,00
 FAEF 100·DATA·af,32,1c,1c,32
 FABF 110·DATA·4c,1d,00,cf,00
 EAPN 120·DATA·00,00,0a,00,0a
 FABG 130·DATA·21,de,7f,22,4b
 EAEN 140·DATA·80,21,18,8e,22
 EAPJ 150·DATA·70,80,18,22,21
 FABJ 160·DATA·ec,7f,11,00,fc
 FAPE 170·DATA·01,0a,00,ed,b0
 FAOM 180·DATA·c3,4d,fc,3e,c9
 EAFN 190·DATA·32,60,63,01,8d
 EABN 200·DATA·7f,18,69,00,00
 FADI 210·FOR·x=ABE00·TO·ABE2E
 FALJ 220·READ·a\$:a=VAL("&"a\$)
 GACD 230·POKE·x,a:NEXT:MODE·1
 FAHE 240·MEMORY·A2FFF:PEN·1
 HAPA 250·PRINT"1.→Little·Puff"
 HAEJ 260·PRINT"2.→Wizard·Willy"
 JAGC 270·PRINT"3.→Frankenstein·Jnr"
 IAIE 280·PRINT"4.→Ollie·&·Lissa·III"
 HAIH 290·PRINT:INPUT"Option";n
 CALD 300·ON·n·GOTO·320,390,430,440

FAIK 310·RESTORE:CLEAR:RUN
 JAND 320·CLS:PRINT"Keypress·Cheat:"
 KABA 330·PRINT:PRINT"Press·Keys·";PEN·2
 NACH 340·PRINT"D·R·A·G·O·N";PEN·1:PRINT"·all
 ·together"
 MAGF 350·PEN·1:PRINT"Gives·Invulnerability"
 LAPP 360·PRINT"Also·Press·SHIFT·Plus·Arrow"
 KAKB 370·PRINT"Keys·To·Move·Location"
 BAEP 380·RUN""
 DABJ 390·RESTORE·100
 FAJI 400·FOR·x=ABE23·TO·ABE2E
 GABP 410·READ·a\$:POKE·x,VAL("&"a\$)
 HAAN 420·NEXT:LOAD"wiz":CALL·ABE00
 IAKB 430·LOAD"frank.jnr":CALL·ABE00
 DAAJ 440·RESTORE·130
 FANI 450·FOR·x=A7FD0·TO·A7FF5
 GAGP 460·READ·a\$:POKE·x,VAL("&"a\$)
 IAHB 470·NEXT:LOAD"candlelight"
 DAPA 480·CALL·A7FD0

Quattro Combat:

Arcade Flight – Lives
 Death Stalker – No ghosts
 SAS Combat Sim – Lives

KAIK 1·'·Quattro·Combat·Cheat·System
 EADF 2·'·by·ANDY·PRICE
 JAIA 3·'·*·use·Typewriter·codes·*
 AALH 4·'
 FAND 10·FOR·x=ABE00·TO·ABE21
 FAGJ 20·READ·p\$:p=VAL("&"p\$)
 EAPF 30·POKE·x,p:NEXT
 IAKD 40·MODE·1:PRINT"Choose·Game:"
 HABL 50·PRINT"1·Death·Stalker"
 HANH 60·PRINT"2·SAS·Combat·Sim"
 IAAO 70·PRINT"3·Arcade·Flight·Sim"
 HAAI 80·PRINT:INPUT"Number:·",n
 FAII 90·ON·n·GOSUB·100,180,200
 FAOI 91·RESTORE·440:GOTO·500
 FAOP 100·RESTORE·400:GOSUB·290
 IAPH 110·INPUT"Ground·ghouls";y\$
 GAMP 120·IF·LEFT\$(y\$,1)="y"·THEN·160
 JAHC 130·INPUT"Fireball·demons";y\$
 GAPP 140·IF·LEFT\$(y\$,1)="y"·THEN·170
 CAGJ 150·RETURN
 GAIA 160·POKE·ABE24,&3C:GOTO·130
 GABA 170·POKE·ABE29,&3C:RETURN
 GANA 180·RESTORE·300:GOSUB·290
 CAKJ 190·RETURN
 GABA 200·RESTORE·420:GOSUB·290
 JADF 210·CLS:PRINT"Infinite·lives:"
 GAAC 240·INPUT"Player·1";y\$
 HAFA 245·IF·LEFT\$(y\$,1)="y"·THEN·260
 DACO 250·POKE·ABE24,&3D
 GADC 260·INPUT"Player·2";y\$
 HAJA 265·IF·LEFT\$(y\$,1)="y"·THEN·280
 DAJO 270·POKE·ABE29,&3D
 CAKJ 280·RETURN
 FAAJ 290·FOR·x=ABE23·TO·ABE2E
 HANA 300·READ·p\$:POKE·x,VAL("&"p\$)
 EANA 310·NEXT:RETURN
 FAHB 320·DATA·ED,5B,38,BD,EB
 FAAN 330·DATA·22,34,BE,11,37,BD
 FANI 340·DATA·EB,3E,C3,77,23,3E
 FADH 350·DATA·23,77,3E,BE,23,77
 FAAD 360·DATA·21,40,00,E3,11,00
 FANH 370·DATA·BB,00,C3,4A,3A,91
 FAAL 380·DATA·AF,32,AA,49,3E,FF
 FAOE 390·DATA·32,86,32,32,8B,32

FALF 400·DATA·3E,00,32,1C,17,3E
 FAPD 410·DATA·00,32,BD,18,00,00
 FALG 420·DATA·3E,00,32,8A,89,3E
 FAMD 430·DATA·00,32,4E,89,00,00
 FABE 440·DATA·00,41,50,00,CF,00
 FANI 500·FOR·x=ABE2F·TO·ABE34
 HAAB 510·READ·p\$:POKE·x,VAL("&"p\$)
 GAAL 520·NEXT:MEMORY·A3000:LOAD""
 DABA 530·CALL·ABE00



Quattro Firepower:
 Mig 29 Fighter – Lives
 Operation Gunship – Invulnerability
 3D Starfighter – Invulnerability

Zap 'em out of the skies and remain invincible!

HALF 1·'·Quattro·Firepower
 EADF 2·'·by·ANDY·PRICE
 AAKH 3·'
 KAFM 10·MODE·1:PRINT"Quattro·Firepower"
 HAJL 20·PRINT·TAB(13)"by·ANDY·PRICE"
 XAOB 30·PRINT"1·Mig·29·Soviet·fighter"
 JAEI 40·PRINT"2·Operation·Gunship"
 HABP 50·PRINT"3·3D·Starfighter"
 HAPJ 60·PRINT:INPUT"Number";jp
 FACL 70·ON·jp·GOTO·340,100,560
 CACE 80·GOTO·10
 AALH 90·'
 HAHK 100·'·Operation·Gunship
 HAML 110·'·Quattro·Firepower
 AAKN 120·'
 EAFL 130·'·by·ANDY·PRICE
 AAMN 140·'
 DABJ 150·RESTORE·160
 GAFI 160·DATA·2a,38,bd,e5,ac,e1
 FADP 170·DATA·22,35,be,ad,21,37
 GAOC 180·DATA·bd,3e,c3,77,23,3e
 FAFN 190·DATA·23,77,3e,be,23,77
 FAJE 200·DATA·21,40,00,e3,11,00
 GADH 210·DATA·bb,00,c3,4a,3a,af
 GADA 220·DATA·32,9b,8e,32,5f,8d
 FAJJ 230·DATA·32,53,8d,32,b1,85
 FAPO 240·DATA·3e,41,3e,50,cf,00
 FANA 250·DATA·00,00,00,00,00,00
 FAKH 260·FOR·x=ABE00·TO·ABE36
 FAAX 270·READ·a\$:a=VAL("&"a\$)
 HAGP 280·POKE·x,a:chk=chk+a:NEXT
 GAED 290·IF·chk()&1546·THEN·320·
 FAEH 300·MEMORY·A2FFF:LOAD""
 CANP 310·CALL·ABE00
 IAGN 320·PRINT"Error·in·poke":STOP
 AANN 330·'
 IAJC 340·'·Mig·29·Soviet·Fighter
 HACH 350·'·Quattro·Firepower
 ARAO 360·'
 EALL 370·'·by·ANDY·PRICE
 AACO 380·'
 DAEJ 390·RESTORE·400
 GACI 400·DATA·2a,38,bd,e5,ac,e1
 GAMB 410·DATA·22,2b,be,ad,21,37
 GALT 420·DATA·bd,3e,c3,77,23,3e
 FACN 430·DATA·23,77,3e,be,23,77

FAPE 440·DATA·21,40,00,e3,11,00
 GAJH 450·DATA·bb,00,c3,4a,3a,af
 FAHM 460·DATA·32,c8,08,32,f1,0c
 FAKH 470·DATA·cf,00,00,00,00,00
 FAKI 480·FOR·x=ABE00·TO·ABE2C
 FAEX 490·READ·a\$:a=VAL("&"a\$)
 HAPB 500·POKE·x,a:chk=chk+a:NEXT
 GAPD 510·IF·chk(<)&116D·THEN·540·
 FAIH 520·MEMORY·&2FFF:LOAD""
 DABA 530·CALL·ABE00
 IAKN 540·PRINT"Error·in·poke":STOP
 AABO 550·'
 GAMB 560·'·3D·Star·Fighter
 HAGM 570·'·Quattro·Firepower
 AAEO 580·'
 EAFL 590·'·by·ANDY·PRICE
 AAMN 600·'
 DAGJ 610·RESTORE·650
 FAFI 620·FOR·x=ABE00·TO·ABE2B
 GACN 630·READ·cd\$:cd=VAL("&"cd\$)
 EANO 640·POKE·x,cd:NEXT
 FAAB 650·DATA·ED,5B,38,BD,ES
 FAHA 660·DATA·AC,E1,ED,53,2D
 FAFB 670·DATA·BE,AD,11,37,BD
 EAFN 680·DATA·3E,C3,12,13,3E
 EAGN 690·DATA·2S,12,3E,BE,13
 EADK 700·DATA·12,21,40,00,E3
 EAOL 710·DATA·11,00,BB,00,C3
 EAGL 720·DATA·4A,3A,41,50,00
 EAGO 730·DATA·AF,32,3A,7F,32
 EAIK 740·DATA·15,7F,00,00,00
 EAIA 750·POKE·ABE2C,&CF
 FAOH 760·MEMORY·&2FFF:LOAD""
 DAHA 770·CALL·ABE00

Quattro Power:

- Motorcross Sim – Bikes
- Twin Turbo V8 – Time/lives
- Pro Powerboat – Lives
- ATV Sim – Time

Stay ahead simply by tapping in this list.



FAFL 1·'·Quattro·Power
 EADF 2·'·by·ANDY·PRICE
 AAMH 5·'
 FAOL 10·MODE·1:INK·1,1S:INK·0,0
 HAEO 20·PRINT"1·Moto·Cross·Sim"
 HAAP 30·PRINT"2·Twin·Turbo·V8"
 JADC 40·PRINT"3·Pro·Powerboat·Sim"
 HADK 50·PRINT"4·ATV·Simulator"
 HAPB 60·PRINT:INPUT"Number">·",no
 GAIF 70·ON·no·GOTO·880,660,320,90
 CACE 80·GOTO·10
 HAAM 90·'·ATV·Simulator·cheat
 EAFL 100·'·by·ANDY·PRICE
 XAPF 110·'·Function:·stops·the·clock
 DALI 120·RESTORE·130
 EADJ 130·DATA·21,70,01,11,35
 EALM 140·DATA·04,3E,16,CD,A1
 EAGP 150·DATA·BC,2A,0E,BC,22
 EACP 160·DATA·B5,BE,3E,C3,32
 FAFB 170·DATA·0E,BC,21,9F,BE
 EABP 180·DATA·22,0F,BC,CD,80

EAMO 190·DATA·01,ES,21,AB,BE
 EALO 200·DATA·22,8E,98,E1,CD
 FAIB 210·DATA·B4,BE,C9,F5,AF
 EAMN 220·DATA·32,1E,4C,F1,C3
 EAMK 230·DATA·00,04,CF,00,00
 FAMN 240·FOR·ad=ABE00·TO·ABE66
 FADO 250·READ·x\$:x=VAL("&"x\$)
 GAHP 260·POKE·ad,x:z=z+x:NEXT
 FANE 270·IF·z(<)&1800·THEN·300
 HANJ 280·MODE·0:PRINT"Press·PLAY"
 DAMA 290·CALL·ABE00
 HAIG 300·PRINT"DATA·error":STOP
 AALN 310·'
 HAAH 320·'·Pro·Powerboat·Sim'
 EAHL 330·'·by·ANDY·PRICE
 FAXJ 340·'·tape·method·1
 AAPN 350·'
 DAHJ 360·RESTORE·370
 FAOB 370·DATA·ED,5B,38,BD,ED
 FAIA 380·DATA·53,3D,BE,AD,3E
 FADA 390·DATA·59,A4,CB,77,AF
 EAPN 400·DATA·21,37,BD,3E,C3
 EACM 410·DATA·77,23,3E,28,77
 EAFN 420·DATA·3E,BE,23,77,21
 EAPJ 430·DATA·40,00,E3,11,00
 EAFO 440·DATA·BB,00,C3,4A,3A
 EAOM 450·DATA·3E,09,32,2C,88
 EAIL 460·DATA·3E,12,32,31,88
 EAAN 470·DATA·3E,08,32,3C,88
 EAAM 480·DATA·3E,17,32,41,88
 DAIJ 490·DATA·CF,00,00
 FADN 500·FOR·ad=ABE00·TO·ABE3E
 FANJ 510·READ·a\$:a=VAL("&"a\$)
 GACM 520·y=y+a:POKE·ad,a:NEXT
 FANG 530·IF·y(<)&168E·THEN·640
 FAJD 540·MEMORY·&3000:LOAD""
 HAEI 550·INPUT"lives·for·p1":p
 DAJL 560·POKE·ABE33,p
 HAHJ 570·INPUT"lives·for·p2":p
 DAAM 580·POKE·ABE29,p
 HACI 590·INPUT"mines·for·p2":p
 DAFM 600·POKE·ABE2E,p
 HAKH 610·INPUT"mines·for·p1":p
 DALL 620·POKE·ABE38,p
 DACA 630·CALL·ABE00
 IAGE 640·PRINT"Error·in·DATA":STOP
 AACO 650·'
 FAPH 660·'·Twin·Turbo·V8
 EAOL 670·'·by·ANDY·PRICE
 AAFO 680·'
 DAKJ 690·RESTORE·700
 FADA 700·DATA·2A,38,BD,ES,AC
 EAMO 710·DATA·E1,22,31,BE,AD
 EAEO 720·DATA·21,37,BD,3E,C3
 EACM 730·DATA·77,23,3E,23,77
 EAKN 740·DATA·3E,BE,23,77,21
 EAEK 750·DATA·40,00,E3,11,00
 EAKO 760·DATA·BB,00,C3,4A,3A
 EAMN 770·DATA·AF,32,50,65,3E
 FAHA 780·DATA·99,32,EE,1B,EE
 EALF 790·DATA·41,EE,50,CF
 FAID 800·MEMORY·&3000:LOAD""
 FAGH 810·FOR·y=ABE00·TO·ABE30
 FAOM 820·READ·p\$:p=VAL("&"p\$)
 GAKJ 830·x=x+p:POKE·y,p:NEXT
 FAOG 840·IF·x(<)&14A8·THEN·860
 DACA 850·CALL·ABE00
 HADH 860·PRINT"DATA·error":STOP
 AAGO 870·'

IAAL 880·'·Moto·Cross·Simulator
 EACM 890·'·by·ANDY·PRICE
 AAAO 900·'
 DAJJ 910·RESTORE·920
 FAHA 920·DATA·2A,38,BD,ES,AC
 FAEA 930·DATA·E1,22,2F,BE,AD
 EAIO 940·DATA·21,37,BD,3E,C3
 EAGM 950·DATA·77,23,3E,23,77
 EAON 960·DATA·3E,BE,23,77,21
 EAIK 970·DATA·40,00,E3,11,00
 EA00 980·DATA·BB,00,C3,4A,3A
 EAMN 990·DATA·AF,32,C7,05,32
 EADN 1000·DATA·2B,0D,00,00,00
 DABD 1010·DATA·00,CF
 FADG 1020·MEMORY·&3000:LOAD""
 FAFL 1030·FOR·y=ABE00·TO·ABE2E
 FAJP 1040·READ·p\$:p=VAL("&"p\$)
 HALG 1050·ch=ch+p:POKE·y,p:NEXT
 GADB 1060·IF·ch(<)&10A8·THEN·1080
 DABD 1070·CALL·ABE00
 HAFB 1080·PRINT"error·in·DATA"

Quattro Racer:

- BMX Freestyle – Qualify
- BMX Sim 2 – Time
- ATV Sim – Time
- Championship Jet Ski – Course



Race to the front and stay there whilst others look on in awe!

GAIA 1·'·Quattro·Racers
 EADF 2·'·by·ANDY·PRICE
 AAKH 3·'
 HAOC 4·'·ATV·Sim·--·stop·clock
 GAPL 5·'·BMX·2·--·clock·speed
 NAGC 6·'·BMX·Freestyle·--·nefarious·odds!
 XAAL 7·'·Champ·Jet·Ski·--·choose·course
 AAPH 8·'
 EAPI 10·DATA·21,30,6c,11,30
 FAFC 20·DATA·ac,01,91,01,ed
 EAKP 30·DATA·b0,21,94,be,22
 FALI 40·DATA·6f,ac,c3,30,ac
 EALM 50·DATA·3e,01,32,43,5b
 FAAA 60·DATA·c3,40,00,4f,6f
 FAJG 70·DATA·4f,4f,b8,a8,a0
 FAEJ 80·DATA·2a,38,bd,e5,ac
 FABJ 90·DATA·e1,22,2f,be,ad
 FAMF 100·DATA·21,37,bd,3e,c3
 EAKN 110·DATA·77,23,3e,23,77
 FACD 120·DATA·3e,be,23,77,21
 EAML 130·DATA·40,00,e3,11,00
 FACI 140·DATA·bb,00,c3,4a,3a
 FAAA 150·DATA·3e,c3,32,10,66
 EAFP 160·DATA·21,31,be,22,11
 FAPC 170·DATA·66,cf,00,00,3e
 FAKA 180·DATA·02,32,f9,65,c3
 FAIN 190·DATA·13,66,ff,ff,ff
 EABJ 200·DATA·21,70,01,11,35
 EAJN 210·DATA·04,3E,16,CD,A1
 EAEP 220·DATA·BC,2A,0E,BC,22
 EAAP 230·DATA·B5,BE,3E,C3,32
 FADA 240·DATA·0E,BC,21,9F,BE
 EAPO 250·DATA·22,0F,BC,CD,80
 EAKO 260·DATA·01,ES,21,AB,BE

EACP 270·DATA·22,8E,98,E1,CD
 FAPB 280·DATA·B4,BE,CS,FS,AF
 EAEO 290·DATA·32,1E,4C,F1,C3
 EAKK 300·DATA·00,04,CF,00,00
 DALN 305·MEMORY·&2FFF
 JAFK 310·MODE·1:PRINT"Quattro·Racers"
 HAMO 320·PRINT·TAB(13)"by·ANDY·PRICE"
 HARN 330·PRINT"1.·ATU·Simulator"
 IABC 340·PRINT"2.·BMX·Simulator·2"
 HAEM 350·PRINT"3.·BMX·Freesytle"
 KAJH 360·PRINT"4.·Championship·Jet·Ski"
 HADN 370·PRINT:INPUT"Number";jp
 GAFL 380·ON·jp·GOTO·490,400,530,580
 CAJK 390·GOTO·310
 DAJF 400·RESTORE·10
 FABJ 410·FOR·x=ABE80·TO·ABE8B
 GACP 420·READ·a\$:POKE·x,VAL("&"a\$)
 FALN 430·NEXT:LOAD"BMX2",&6C30
 JACP 440·PRINT"Clock·Speed·(1·is·fast)"
 IABG 450·PRINT·TAB(13)"(5·is·normal)"
 IAFA 460·PRINT·TAB(13)"(255·is·slow)"
 JAHJ 470·INPUT"Enter·Speed·Value:";v
 GADF 480·POKE·&BE95,v:CALL·&BE80
 DADJ 490·RESTORE·200
 FAOI 500·FOR·x=ABE80·TO·ABE86
 GACP 510·READ·a\$:POKE·x,VAL("&"a\$)
 EABI 520·NEXT:CALL·&BE80
 LAFJ 530·MODE·1:PRINT"Keypress·Cheat:";PRINT
 KAIL 540·PRINT"Redefine·each·players";
 HABE 550·PRINT"·name·as:";PRINT
 LAEC 560·PEN·2:PRINT"TAHC·('CHEAT'·reversed
)"



Quattro Superhits:

Super Tank Sim – Lives

Super Hero – Lives
 Italian Supercar – Time

Gain superhuman qualities with this simply super routine!

HAPG 1.·Quattro·Super·Hits
 EADF 2.·by·ANDY·PRICE
 AAKH 3.·
 FANE 10·FOR·x=ABE80·TO·ABE2A
 GALJ 20·READ·cd\$:cd=VAL("&"cd\$)
 EAGL 30·POKE·x,cd:NEXT
 JAJK 40·MODE·1:PEN·2:PRINT"Choose·Game:"
 JAMM 50·PEN·1:PRINT"1.·Super·Stuntman"
 GAEJ 60·PRINT"2.·Super·Tank"
 GAGJ 70·PRINT"3.·Super·Hero"
 JACA 80·PRINT"4.·Italian·Super·Car"
 HABI 90·PRINT:INPUT"Number:";n
 GABH 100·ON·n·GOSUB·160,120,140,200
 CAHK 110·GOTO·390
 FAOP 120·RESTORE·360:GOSUB·220
 CAEJ 130·RETURN
 GACA 140·RESTORE·380:GOSUB·220

CAGJ 150·RETURN
 KACB 160·PRINT:PRINT"Super·Stuntman:"
 KAOI 170·PRINT:PRINT"Type·LIVEMIRE·into";
 IAOK 180·PRINT"·high·score·table"
 BADP 190·RUN""
 FALP 200·RESTORE·340:GOSUB·220
 CADJ 210·RETURN
 FAFI 220·FOR·x=ABE2B·TO·ABE31
 GABP 230·READ·a\$:POKE·x,VAL("&"a\$)
 EAPA 240·NEXT:RETURN
 FAMA 250·DATA·ED,5B,38,BD,ES
 EACP 260·DATA·AS,ED,53,33,BE
 EACP 270·DATA·E1,AC,DD,21,37
 FAOA 280·DATA·BD,3E,C3,DD,77
 EAOH 290·DATA·00,3E,2B,DD,77
 EADP 300·DATA·01,3E,BE,DD,77
 EAPJ 310·DATA·02,21,40,00,E3
 EAIM 320·DATA·11,00,BB,37,3F
 EAPL 330·DATA·C3,4A,3A,00,00
 EAFN 340·DATA·AF,32,C8,17,32
 EAGK 350·DATA·91,4F,00,00,00
 EAKN 360·DATA·AF,32,F6,37,32
 EAKK 370·DATA·2B,99,00,00,00
 EAJM 380·DATA·AF,32,63,37,32
 EALK 385·DATA·5A,37,00,00,00
 DAIP 390·POKE·&BE32,&CF
 FAED 400·MEMORY·&3000:LOAD""
 CAOP 410·CALL·&BE80

Graham Smith of Street has bashed together cheats for *The Dizzy Compilation* and *The Cartoon Collection*, get stuck into them too.

Cartoon Collection:

Seymour goes to Hollywood – Lives
 Spike in Transylvania – Lives
 Slightly Magic – Lives
 Dizzy (again) – Lives
 Little Puff – Invulnerability



NAKI 1.·Cartoon·collection·by·Graham·Smith·
 HDKX 10·DATA·06,00,11,11,11,cd,77,bc,d5,eb,cd
 ,83,bc,e5,cd,7a,bc,01,10,00,11,00,be,21,
 c2,90,ed,b0,e1,d1,7a,fe,3a,20,28,7d,fe,4
 3,c0,2a,38,bd,22,0a,be,21,37,bd,36,c3,23
 ,36,00,23,36,be,11,00,bb,21,40,00,e3,c3,
 4a,3a,21,38,90,22,22,3b,c3,e9,3a,d5,01
 GDLE 20·DATA·71,00,11,1e,02,21,5b,90,ed,b0,d1
 ,c3,1e,02,7a,b7,20,10,21,2a,02,22,7f,00,
 eb,e9,cd,9f,00,af,32,91,16,c9,fe,03,20,1
 0,21,3e,02,22,3e,03,eb,e9,cd,98,03,af,32
 ,f1,40,c9,fe,8a,c2,00,00,21,59,02,22,56,
 8b,21,00,00,22,60,8b,eb,e9,cd,52,fe,01
 CCKN 30·DATA·1d,00,11,00,00,21,68,02,ed,b0,c9
 ,cd,52,fe,af,32,b8,61,21,c8,61,36,7e,23,
 36,b7,23,36,c2,23,36,02,23,36,61,23,77,2
 3,77,c9,af,32,3a,95,3e,c9,32,18,95,cf
 CCKL 40·DEFSTR·a-e:FOR·j=&9000·TO·&90CB:READ·
 a:POKE·j,VAL("&"a\$):NEXT:a=STRING\$(22,4
 2):b=""+STRING\$(20,32)+"":c=STRING\$(15
 ,42):d=""+STRING\$(13,32)+""
 FBNC 50·e="·Infinite·lives·":GOSUB·80:PRINT
 ↑Seymour·goes·to·Hollywood
 IAPA Spike·in·Transylvania

FABF Slightly·Magic
 CAKB Dizzy
 EAPB Little·Puff
 JAIL <↓;e;e;e;e;"Invulnerability
 JANE ↑<"a;b;b;b;a;"CARTOON·COLLECTI
 ON
 GAOG < Insert·game·tape
 BADP <("·"
 GAMP 60·CALL·&9000:GOSUB·80:PRINT"
 KENC ··During·the·game·press·keys·D·R·A·G·O·N
 at·the·same·time·for·invulnerability·...
 from·most·things·...This·also·lets·you·
 change·location·by·holding·down·shift·...
 and·pressing·an·arrow·key·...If·you·do·
 get·killed·then·";
 DBLB 70·PRINT"re·enter·the·cheat·after";"rest
 arting·the·game.
 HARE · "j;c;d;d;d;c;"LITTLE·PUFF
 MAGI ↑<<·Press·any·key·>·...
 "·CALL·&BB18:CALL·&9042
 MAFC 80·PRINT"↑AMS
 TRAD·ACTION·CHEAT·MODE":RETURN

The Dizzy Collection:

Dizzy (yet again) – Lives
 Treasure Island Dizzy – Immunity
 Fantasy World Dizzy – Lives
 Magicland Dizzy – Lives
 Fast Food – Lives

MAKX 1.·Dizzy·Collection·By·Graham·Smith.
 MAGA 2.·Also·for·original·games,·except
 GAKJ 3.·(perhaps)·Dizzy·4.
 JALH 4.·Dizzy,·Dizzy·3,·Dizzy·4·and
 KAGA 5.·Fast·Food·-·infinite·lives.
 MAKH 6.·Dizzy·2·-·immunity·from·drowning,
 LAPP 7.·flames,·cages·and·sea·creatures
 IAJI 8.·Save·to·tape,·not·disc.
 AAI 9.·
 IACP 10·DATA·11,00,01,43,cd,77,bc,d5,eb,cd
 JAFJ 20·DATA·83,bc,cd,7a,bc,e1,7c,fe,3a,28
 IAND 30·DATA·4e,fe,af,28,25,01,17,00,11,85
 IANM 40·DATA·8a,21,27,be,ed,b0,c3,91,8a,21
 HAHP 50·DATA·00,c3,22,4b,3e,11,00,40,c3,71
 IAJB 60·DATA·be,21,19,8b,36,c3,23,36,85,23
 IAAK 70·DATA·36,8a,21,47,be,22,c0,af,c3,80
 IAPM 80·DATA·af,21,0a,8b,7e,fe,20,3e,18,20
 HA00 90·DATA·06,77,32,92,8a,18,06,32,1c,8b
 IAEF 100·DATA·32,a4,8a,32,2e,01,c3,40,00,2a
 JAEA 110·DATA·38,bd,22,9e,be,21,37,bd,36,c3
 IABG 120·DATA·23,36,7e,23,36,be,11,00,bb,21
 IADJ 130·DATA·40,00,e3,c3,4a,3a,21,0c,57,7e
 IAKD 140·DATA·ee,3d,20,03,77,18,14,21,63,a0
 IAKK 150·DATA·7e,ee,3d,20,03,77,18,09,af,32
 HAAG 160·DATA·3a,95,3e,c9,32,18,95,cf
 HANF 170·FOR·j=48640·TO·48797:READ·a\$
 JAIN 180·x=VAL("&"a\$):y=y+x:POKE·j,x:NEXT
 GACN 190·IF·y=15354·THEN·CALL·48640
 GAPE 200·PRINT"data·error





AIR ATTACK

Alternative Software ■ Tel 0977 79777 ■ £4.99 cassette

Up there, flying through the clouds, soaring with the birds, swooping like an eagle, diving like a heron (getting blown to bits like a clay pigeon), playing in the fluffy pink clouds, and back in time for tea - life in the Air Force is good, handsome, brave, dashing... or is it. SIMON FORRESTER thinks not.

That's dross. Your lifespan was ten minutes in a Spitfire, and probably not much longer in a Harrier. You were cold, scared, and exhausted and filled with the cold dread of sudden, unheroic death. So especially for you, Alternative have allowed us all to relive the experience with their flight sim compilation pack containing *Spitfire 40* and *Strike Force Harrier* - two of the biggest selling sims on the CPC. But are these games any good? In reality, it all depends what lights your candle. Personally, my candle positively melts when I think of hanging upside down 30,000 feet up in the air!

Spitfire 40

This game must have been a nightmare to program, seeing as not only have you got to write a flight sim, but a faithful conversion from reality. Whether they've achieved this is, quite frankly, anybody's guess (when was the last time you went up in a Spitfire then?).

The game is simple; fly over England blasting as many bells as possible out of your opponents. That's it. Your opponents, like everything else in this game, are essentially vector graphics, but the speed at which this game runs excuses that - if those straight lines were all filled in with colour and stuff like that, the game would be too slow to be playable.

On loading, you have the choice of practice



Checks away, and I suppose I'd better start the plane up (It usually helps).

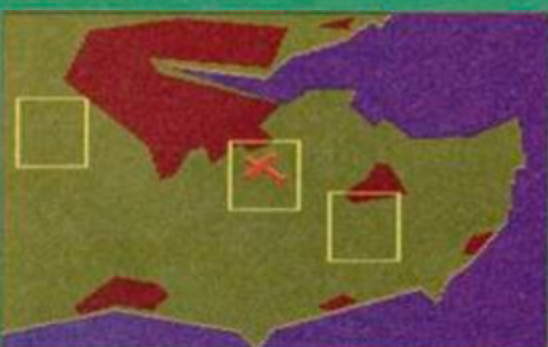

Oooh, it's a bit of Blighty! Some of it's a bit brown, but it's what we call home.

mode (no evil villainous bad guys), combat mode (the real thing, chocks away etc), and finally combat practice (this sees you already in the air being attacked by a stream of Red Baron style blokies). This makes *Spitfire 40* more than just a mediocre fly-and-shoot-'em-up.

The graphics in *Spitfire 40* aren't exactly beautiful, with not much on the ground, the horizon, or indeed, the air. Life isn't all dull though, as getting used to the controls and learning to fly a plane that has great difficulty maintaining height will keep you too occupied to worry about the lack of ground detail. Sonically, this game is just a tad annoying. The problem with any simulator is that programmers always seem to feel compelled to simulate a whining engine with a really heavy flange.

When you're flying, certain things are bound to confuse you at first. The scariest problem you'll have is suddenly tipping forwards and flying towards the ground. Aaaaaaueargh!

Spitfire 40 isn't the smoothest or flashiest game in the world, but it's fun.

82%

Strike Force Harrier

Time to dispense with all the 'Tally Ho!'s and such like, and move to more modern quotes such as, 'I'll see you in hell, Jack!' as we move almost bang up to date with *Strike Force Harrier*, and if you though reviewing *Spitfire 40* was difficult enough, you ought to try taking an authoritative stance this one! However, I suppose I'd better do my job (When? Ed) and appear the all-seeing, all-knowing reviewer.

The quality of the simulation is still open to question, but what about the quality of the game? The first problem you'll encounter is the fact that there don't seem to be any instructions. You're not even told how to speed up, let alone climb! Always assuming you don't want to use them, there are a lot of features on the Harrier. There's loads of weapons (what is a chaff anyway?) and



Oh I see, these are the controls are they? So how do I fly this thing?



Life on the ocean waves, la da da ... Oh sorry, wrong game.

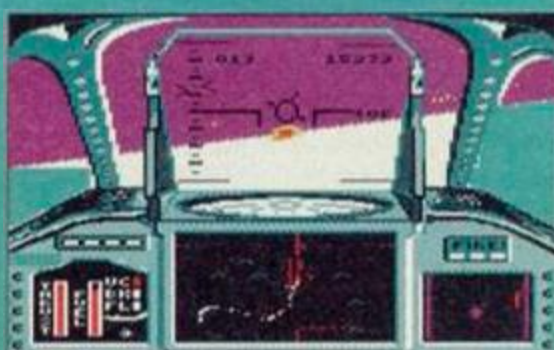

Die, you planey-type flying thing that's probably British. Oh dear.

some nice fun to be had shooting the hell out of people.

Graphically, *Harrier* is a little better than *Spitfire 40*, with stuff on the ground, mountains, etc. Sonically, it's pretty much the same.

Once you get the knack of playing this game, you'll enjoy it. However, if you don't like flight sims as a rule, what are you doing with this game anyway?

78%

VERDICT

GRAPHICS

They're both good looking and nice to play, but *Harrier* seems ever so slightly better.

77%

SONICS

There's not much you can do with a flight sim. As far as flanging motor effects go, they're okay.

74%

GRAB FACTOR

How grabby can a flight sim be? There's little room for originality in the format.

84%

STAYING POWER

If you like flying around a lot, this pack has certainly got the goodies to keep you happy.

88%

Flight sims are a funny bunch. You either love them or hate them. If you love them, these are for you!

RATING 80%

There may only be two games in this month's Action Replay, but they're two jolly good ones. So good in fact, that we've put one on each page!

Action replay

RBI 2 Baseball

The Hit Squad ■ 061 832 6633 ■ £3.99

That incredibly sporty jock (ahem) **SIMON FORRESTER** picks up his bat and steps on to the diamond...

Oh scridly dee. La tum te tum. What? A baseball game? What's baseball? Oh, you mean rounders? So what's the difference? A diamond? Where does that come into it?

(Ooh Lordy Simon, you are so thick. Baseball differs from rounders in that baseball is played on a diamond shaped pitch, and only has four



This is what the whole screen looks like. It's pretty spiffy, isn't it?

bases (including the batting base). All the standard rules of rounders are still applicable as, basically, baseball is just an American variation of rounders, or rounders is just an English version of baseball.

In RBI2 most of the game involves shots of the diamond, the field, and the bowlers mound. The animated sequences are absolutely beautiful, with the ball arcing right up to almost obscure your view of the diamond.

The game is quite a good simulation. You have the option to select the starting players in your team and, with none of the messing around involved with positioning people, you can dive headfirst into the main game. Fielding can be a tad slow, with the blokes crawling through the grass, but the batters don't move all that fast either anyway.

Gra... (Graphically, there's very little you can do with a game like this. Ed) Oi! (If you've ever played a cricket game, you'll know it's just like an isometric version of Lemmings. Ed) Help! I'm being obscured by Ed comments! (The fielders are slightly easier to control in RBI2, though you might have some trouble getting to grips with it first time around. Ed)



As the fielder ran towards the ball, the audience held their collective breath.



Daylight turned to dusk and the players' thoughts turned to their tea.

Can I do the sound, Linda? (The sound is all right and quite unobtrusive, it won't detract from the game though it won't add much either.

All in all, RBI2 gels together quite well. It's nice to be able to select your team, and it doesn't get too tedious as there isn't much tactical talk. It's always a plus point to have some animated sequences to look at instead of lots of boring boxes with numbers in. Ed)

Erm, Linda, (What? Ed) I was quite looking forward to reviewing this game. (But it's quite clear to everyone that you know very little, if anything, about the intricacies of the game of baseball. Ed) But I could learn...

How do you play it?

The players come in two teams. This guy (the pitcher) stands on this hill and throws a ball at a bloke (batter) holding a big stick that's fat at one end, and thin at the other. The bloke hits the ball with the stick, and then runs around the diamond.

Whilst he's hitting the ball, some of his friends are running round the diamond already. They have to run when he runs, and when they get all the way around, they score a point. If, however, one of the small army of men standing miles away on the field (did we mention them?) manages to get the ball back to a point on the diamond whilst a bloke is

running towards it, said blokey goes home and cries a lot. If, however, the people on the field catches the ball, then the batter is out straight away, and everybody starts shouting and hugging each other.

Now... If the batter is so crap that he can't hit any of three balls that are thrown at him (not all at once, obviously), he's also out straight away, as these balls are all caught by a bloke standing behind him who's dressed like the Michelin Man.

And those are the rules, chaps. Happy hitting! Last one home smells like a very old baseball mitt!



Right, this is either Walton or Ballard. One's a nice boy and one's a sci-fi freak.



RBI - What does it mean?

- Righteous Baseball Interaction
- Rather Blimmin' Important
- Really Blue Ink
- Rancid Banana Incense
- Render Badgers Insensible
- Respect Bad Instructions
- Romantic Bohemian Inventor

VERDICT 90%

Terminator 2

The Hit Squad ■ 061 832 6633 ■ £3.99

"I'm a cold heart breaker, fit to burn, and I'll rip your heart in two..." **SIMON FORRESTER** straps on his metal arm and grabs a piece of the action.

So it's the game of the film of the book, eh? Quite frankly, the thought of meeting that Axl Rose (*Who? Not terribly with it AA reader*)... out of Guns 'n' Roses (*Oh yes, Guns and Roses. Jolly nice chaps, lovely ear for melody. Even less with it AA reader*) in a dark alley is slightly more horrific than meeting Arnie (*especially if Axl started singing Ed*). Still that's by the by and, after a pointless effort to let you know how scared I am of Axl Rose, we'd better take a look at the game.

Level One – The shopping mall – Enter Arnie stage right, and the strange liquid bloke stage left. If you play this game anything like I do, it'll run as follows: Arnie kicks the other bloke. Bloke turns his hand into a spike and stabs Arnie. Arnie tries to punch him. Arnie misses. Bloke head-butts (or rather blob-butts) Arnie. Arnie kicks. Arnie kicks. Arnie kicks. Bloke melts. Bloke reforms himself. Arnie keeps kicking. Bloke eventually dies after doing various liquidy things. (*Why do I get the feeling that everyone's going to write in, having followed this paragraph to the letter and then lost? Ed*)

Level Two – The flood channel – Enter Arnie on a cool Harley, with John Connor draped over the back (*Makes a change from a scantily clad, erm, lady. Ed*), being pursued by the same rather scary liquid bloke in a pretty hefty truck. The idea



Allo! Ich bin das Terminator und I would like to know vas mein hed ist doing over there?



Ich bin das Terminator und du ist ein blob von metal. Du cannst nicht me beat.



here is to outrun the truck, whilst not smashing into tyres, sofas (well they look like sofas) and the other stuff that litters the highway. If you do, both Arnie and John lose even more energy. There are also puddles to skid about in and drink cans that, for some reason, seem to cause immense hassle. (*I think they're meant to be petrol cans actually. Ed*)

Later on, you get some smart puzzle bits to work out. In Level Three you have to operate on the Terminator's arm. It's one of those rearrange-the-blocks puzzles and it's fiendishly difficult. Still, everything's made a bit easier by the friendly controls. If you're kicking yourself with frustration it won't be because of the joystick. A couple of levels later, you have to do the same thing with old Tarmy's head. The levels kind of repeat themselves, so you get a couple of other racey levels and a couple of fighty ones. They may be quite similar ideas, but they get progressively more difficult. One thing's for sure, this is a blimmin' hard game.

Like Arnie (okay, I admit it, I can't spell his last



Ha! das Terminator (das ist me, ja?) ist vonce again die best. Oh, Ich bin so gut!



Diss ist me bevor de surgery. I am now much more handsome, ja?



Dis ist mein vater's vater - mein grandvater. He voss ein gut man.

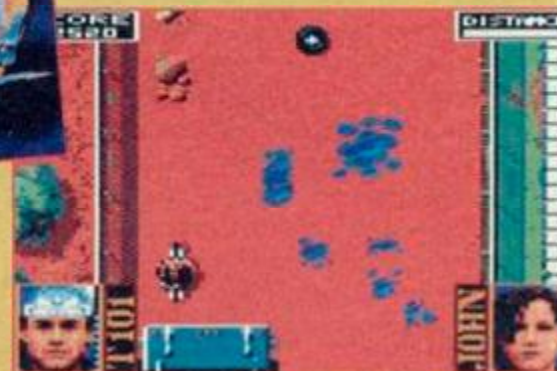

Your Ameikanische roads are sehr dirty. In Deutschland, alles ist clean und, how you say, neece. Ja, ist all neece.

(name), this game is immensely and well 'ard. You've seen those games where you complete them in a matter of seconds? Well, this is definitely not one of them. You will progress further every time you play, but you won't complete this on your second go. You'll definitely keep on trying and there are certain skills that you'll slowly get the gist of, and some that'll take a little longer to master. Indeed, there are a wide range of skills needed, not least puzzling out just how to fit all those blocks into Arnie's unfished fizzog. This isn't just a fighting game, a racing game nor a puzzle game. It is in fact a combination of all the elements that have created classic games in the past. Whether this was a deliberate strategy on the part of the programmers, or whether the plot of the film simply lent itself rather easily to this format isn't clear. Whichever way round though, you'll have a lot to do.

So how does it measure up? Well, as an action game, it's got it all, or most of it at least. And it's even got those lovely puzzley bits. It's nicely presented, with some good graphics, and incidental loading screens. It's definitely worth a review, which is a good job really!

VERDICT 90%

Future Publishing Limited,
 Beauford Court, 30
 Monmouth Street,
 Bath, Avon BA1 2BW
 Tel: 0225 442244
 Fax: 0225 446019

Editor Linda Barker

Staff Writer Simon Forrester

Contributors Stuart Whyte, Phil Howard,
 Jerry Glenwright, Richard Fairhurst,
 Tim Blackbond, Colin Wren, Stuart Baynes

Art Editor Nick Aspell

Senior Ad Sales Executive Jackie Garford

Publisher Colin Campbell

Promotions Assistant Tamara Ward

Group Publishing Director Greg Ingham

Production Craig Broadbridge

Subscriptions Christine Stacey,
 tel: 0458 74011

Circulation Director Sue Hartley,
 tel: 0225 442244

● **Reader calls:** We regret we have to restrict reader calls to Tuesday afternoons.

© **Future Publishing Ltd 1993** Amstrad Action is an independent publication. The company producing it - Future Publishing Ltd - has no connection with Amstrad plc. We cannot guarantee to return material submitted to us, nor can we enter into personal correspondence. We take great care to ensure that what we publish is accurate, but cannot be liable for any mistakes or misprints. No part of this publication may be reproduced in any form without our explicit written permission.

Printed in the UK



'Your guarantee of value'

This magazine comes from Future Publishing, a company founded just seven years ago, but which now sells more computer magazines than any other publisher in Britain. We offer:

Better advice. Our titles are packed with tips, suggestions and explanatory features, written by the best in the business.

Stronger reviews. We have a cast-iron policy of editorial independence, and our reviews give clear buying recommendations.

Clearer design. You need solid information fast. So our designers highlight key elements by using charts, diagrams, summary boxes, annotated photographs etc.

Greater relevance. At Future, editors operate under two golden rules:

- Understand your readers' needs.
- Satisfy them.

More reader interaction. We draw strongly on readers' contributions, resulting in the liveliest letters pages and the best reader tips. Buying one of our magazines is like joining a nationwide user group.

Better value for money. More pages, better quality: magazines you can trust.

Home of Britain's finest computer magazines.

Amstrad Action • Your Sinclair • Commodore Format • PCW Plus • PC Plus • PC Answers • PC Format • Amiga Format • ST Format • Sega Power • Total! • Amiga Power • Amiga Shopper • Super Play • Mega and also Classic CD • Mountain Biking UK • Cycling Plus • Needlecraft • Cross-Stitch Collection • Caravan Plus and others

ABC 35,298

Member of the Audit Bureau of Circulations January-June 1992

Next Month

Coming to a newsagent near you!

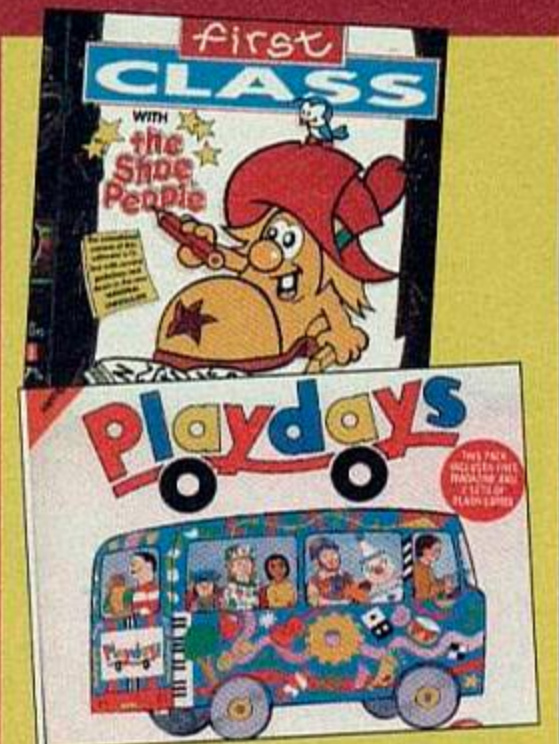

Rod used to live in a bus like that!

More Kids...

The *Fun School* collection, *The Shoe People* and *Playdays* crocodile march on to the CPC (and in to your child's mind).

Get some education!

More Upgrades

The next instalment of Phil Craven's series on boosting your CPC Plus to the skies. Next month 6218 Plus owners can find out how to operate that remote!



Erm, we ran out of pictures of upgrades!

Street Fighter 2

We live in eternal hope, and promise we'll review it next issue. It was delayed this month. We all cried bitterly, but that's the way it is. However, abandon not ye faith! We shall cometh in the future, with fist and foot, to bring you this long-awaited beat-'em-up.



Street Fighter 2 - an artist's impression. What a good artist!

Machine Code (again)

Simon Forrester takes you on a ramble around the innards of your CPC.

FB	CD	43	03	F3	D9	79	CD
CB	91	18	13	79	CB	D9	ED
18	05	F3	D9	F2	CD	5F	BA
0C	A9	4F	18	78	CD	70	BA
2A	01	C0	F5	48	47	FB	E1
D6	B8	46	71	AD	BA	ED	B8
ED	B0	C9	CD	C2	BA	F3	D9
D9	ED	49	CD	59	CB	D3	CB
FB	C9	F3	D9	79	F6	0C	ED

April issue on sale March 25th

MAG*SAVE

I want Amstrad Action!

Dear Newsagent, could you please order me a copy of *Amstrad Action*, starting with the April issue, out on March 25th. *Amstrad Action* is published by Future Publishing, and you can order it from your wholesaler. Thanks.

My name

My address

.....

.....

.....

DATEL Electronics

NOW A TOTAL MOUSE/ GRAPHICS PACKAGE FOR YOUR AMSTRAD AT A TRULY UNBEATABLE PRICE!!

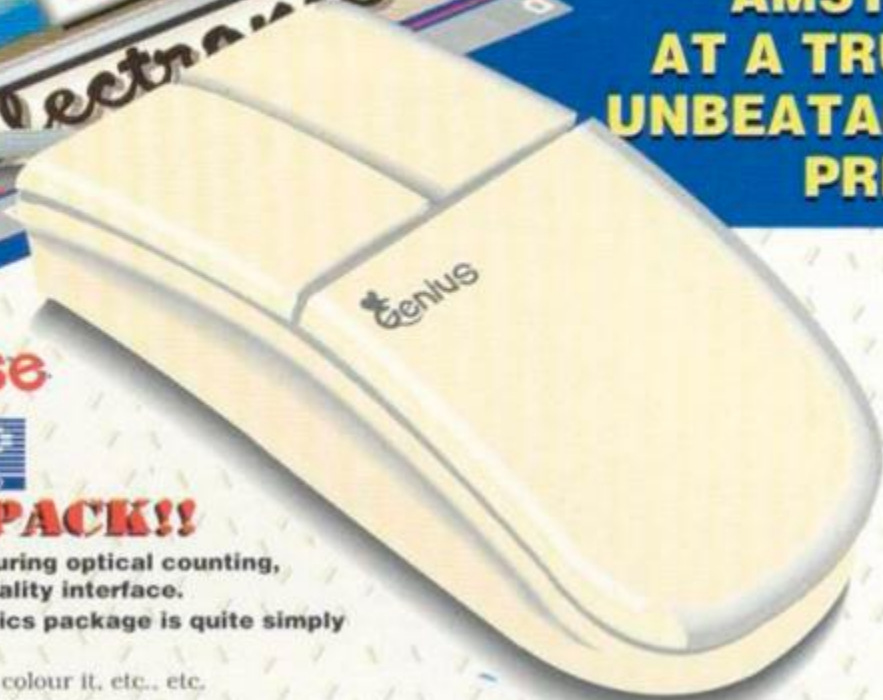

Genius Mouse

COMPLETE WITH



SPECIAL OFFER PACK!!

- Genius Mouse is a high resolution two button mouse featuring optical counting, teflon guides, microswitches, rubber coated ball and high quality interface.
- When combined with OCP Advanced Art Studio this graphics package is quite simply the best system available. The features are unmatched...
- Create an image - shrink it, expand it, move it, rotate it, copy it, colour it, etc., etc.
- Spray patterns or shades, make elastic lines - stretch and manipulate shapes.
- Zoom in to add detail in fine mode. ● Full cut and paste facilities plus excellent printer support.
- Pull-down/Icon driven menus for ease of use. ● Mouse operation, plus joystick and keyboard control.
- 16 pens, 8 sprays, 16 brushes - so flexible anyone can create superb graphics easily.

TAPE OR DISK FOR 464 OR 6128 (PLEASE STATE WHICH REQUIRED) N.B. 464 NEEDS DK'TRONICS 64K RAM PACK

COMPLETE WITH MOUSE INTERFACE



- The Genius Mouse Graphics System comes complete with the special Mouse Interface to allow super smooth control.
- Attractively styled to match your 464 or 6128 design and colour. Simply plugs into Expansion/Joystick port.

ONLY £49.99
TOTAL PACKAGE INCLUDES GENIUS MOUSE, INTERFACE, OCP ADVANCED ART STUDIO PLUS FREE MOUSE MAT AND HOLDER

FREE!
MOUSE MAT AND MOUSE HOLDER (WORTH £12.99) WITH EACH PACKAGE

LC 200 COLOUR PRINTER PACKAGE



NEW

NOW YOU CAN PRINT OUT YOUR PICTURES IN FULL COLOUR!

- The Star LC200 Colour Printer not only prints in Near Letter Quality for your regular jobs but also prints out your pictures from Art Studio, etc., in genuine colour!
- LC200 is a full Centronics printer so it works with other computers (Amiga, ST, etc.).
- Made possible by Datel's unique colour printer driver - now you can have a hardcopy in up to 16 colours!! ● No more to buy - just plug in and print!!

PACKAGE INCLUDES... STAR LC200 COLOUR PRINTER RRP £299.00
CENTRONICS PRINTER LEAD RRP £9.99
DATEL COLOUR PRINTER DRIVER SOFTWARE RRP £19.99
NORMALLY £327.98

COMPLETE PACKAGE NOW ONLY £239.00

COLOUR PRINTER DRIVER AVAILABLE SEPARATELY ONLY £19.99

- If you already have an LC10 or LC 200 Colour Printer we can supply the Driver separately.

dk'tronics



- Simple plug in memory expansion gives instant extra memory.
- Features bank switching software for easy use by the programmer or for use as a data storage area.
- Ideal for use with the CPM 2.2 etc.
- The software also features some extra BASIC commands.
- 64K unit expands 464 to 128K.
- 64K unit brings 464 up to CPC 6128 memory configuration making a much larger software base available. Will work straight off with many programs designed for this unit (including OCP Art Studio - see Ad.).
- Bank switching done automatically by software (cassette 464).

64K MEMORY EXPANSION

ONLY £49.99 64K FOR 464

DATEL Electronics LIMITED

HOW TO GET YOUR ORDER FAST!

TELEPHONE [24Hrs] **0782 744707** CREDIT CARD ORDERS

ORDERS NORMALLY DISPATCHED WITHIN 48 Hrs. ALL CHEQUES-POSTAL ORDERS MADE PAYABLE TO...

DATEL ELECTRONICS

GOVAN ROAD, FENTON INDUSTRIAL ESTATE, FENTON, STOKE-ON-TRENT, ST4 2RS, ENGLAND. FAX 0782 744292 TECHNICAL/CUSTOMER SERVICE 0782 744324

DATEL LONDON SHOP



222, TOTTENHAM COURT RD, LONDON, W1. TEL:071 5806460

WE STOCK EVERYTHING

A SMALL SELECTION FROM OUR WAREHOUSE

	W.A.V.E.	P&P
64k RAM Expansion, CPC464 only	39.84	1.18
3.5" DS/DD Bulk inc Labels PKT 10	4.99	1.18
CPC Centronics Printer Lead 1.5m	7.64	0.59
CPC Centronics Printer Lead 2.0m	8.40	0.59
CPC to Video Lead, state BNC or PHONO plug	7.14	0.59
Expansion Port Adaptor for CPC464+/6128+ plus machines (WIDGIT)	9.40	1.18
Advanced Art Studio, CPC disk (Requires 128k Memory)	16.41	1.18
Genius Mouse + Advanced Art Studio	40.86	3.53
Amstrad, MicroScript Word Processor, CPC464/664/6128 disk	4.99	2.35
40025, 464 Upgrade ROM	25.03	1.18
The Amstrad 12 pack, 12 Games on cassette for the CPC464+	3.99	3.53
Amstrad Soft 158A-DDI-1 Firmware Manual	4.99	3.53
MultiFace 2, for CPC464/664/6128	34.42	3.53
MultiFace 2, for CPC464+/6128+	41.42	3.53
Amcase 3" Disk Filling Cabinet, holds 10 3" disks	2.99	1.18
MicroFile/MicroWord, Database & Word Processor	10.95	3.53
Burning Rubber Cartridge, GX4000	18.49	1.18
Paddle Controller, for CPC464+/6128+ & GX4000	8.34	1.18
System Disk, CP/M plus CPC6128	17.12	1.18
System Disk, Dr Logo & Help CPC6128	13.22	1.18
System Disk, CP/M plus CPC6128+	6.61	1.18
CPC6128 Manual	16.43	2.35
CPC464+/6128+ Manual	15.28	2.35
Service Manual CPC464	11.00	1.18
Service Manual CPC6128	11.00	1.18
Service Manual CPC464+/6128+ & GX4000	5.63	1.18
Service Manual DDI-1 & ED-1	7.50	1.18
Service Manual Amendment & CT-1/MP-3	11.00	1.18
Ribbon DMP2000, PKT 2	3.88	1.18
Ribbon DMP2000, PKT 10	18.00	2.35
Ribbon LC10 Mono, PKT 2	4.70	1.18
Ribbon LC10 Colour	4.23	1.18
Ribbon LC2410/LC24200/LC24100, PKT 2	6.32	1.18
Ribbon PCW8256/8512 Fabric Nylon, PKT 2	5.10	1.18
Ribbon Citizen 120D, PKT 2	5.50	1.18
Ribbon PCW9512 Multistrike, PKT 2	4.72	1.18
Ribbon PCW9512 Fabric Nylon, PKT 2	5.52	1.18
LEAD Amiga 500/600/1200 to CM14 Colour Monitor	14.99	1.18
LEAD Amiga 500/600/1200 to CTM640/644 Colour Monitor, no sound	14.99	1.18
LEAD Sega MegaDrive to CM14 Colour Monitor	12.99	1.18
LEAD Sega Megadrive to CTM640/644 Colour Monitor, no sound	12.99	1.18
LEAD Spectrum +2/+2a/+3 to CM14 Colour Monitor	12.99	1.18
LEAD Spectrum +2/+2a/+3 to CTM640/644 Colour Monitor, no sound	12.99	1.18
CPC Joystick Splitter, allows two joysticks on a CPC464/664/6128	7.99	1.18
Joystick Extension Lead 1.5M	5.99	1.18
MP-1F for CPC464 to allow use of the computer on SCART TV	19.99	4.70
MP-2F for CPC664/6128 to allow use of computer on SCART TV	25.99	4.70
MP-3 for CPC464/664/6128 with CTM644 Colour Monitor, to make monitor into a full colour TV	22.95	4.70
MP-3/PSU for CPC464 with CTM640 Colour Monitor see above	34.95	6.90
MP-3+ for CPC464+/6128+ Colour Monitor see above	39.95	6.90
Amsoft CF2 Disks Box of 10	13.99	1.18
Amsoft CF2 Disks Box of 10 in Hard Plastic Cases	21.95	2.35
CF2 Disks Ex-software House PKT10	9.95	1.18
TASWORD 6128, Word Processor	27.95	2.35
GX4000 Games Console, including burning rubber cartridge	29.99	4.70
GX4000 SCART to SCART TV Cable	14.99	1.18
WAVE CPC Price List disk	1.99	0.59
Money Manager, CPC Home/Small Accounts Program Disk	29.95	2.35

CLEARANCE OFFERS

- PAPERBOY 2 DISK £5.99 + £1.18 P&P
- PP8 - 17 GAME PACK DISK £14.99 + £2.35 P&P
- TEN OF THE BEST VOLUME 1 £8.99 + £1.18 P&P
- TEN OF THE BEST VOLUME 2 £8.99 + £1.18 P&P
- CHARTBUSTERS £8.99 + £1.18 P&P
- 11 GREAT GAMES + WORD PROCESSOR £12.99 + £1.18 P&P
- FUN SCHOOL 1 UNDER 5s £9.99 + £1.18 P&P
- FUN SCHOOL 1 5-7s £9.99 + £1.18 P&P
- FUN SCHOOL 1 8-12s £9.99 + £1.18 P&P
- DISK 50, 50 CPC GAMES £12.99 + £1.18 P&P

ALL CLEARANCE ITEMS ARE DISK BASED

MODIFY YOUR CPC6128 PLUS TO LOAD & SAVE CASSETTE SOFTWARE
All you have to do is send us your CPC6128+ and we will modify it to allow loading from an external cassette recorder (Not supplied)
only £32.50 + £5.88 P&P

MODIFY YOUR DDI-1 INTERFACE TO WORK ON THE CPC464+
All you have to do is send us your DDI-1 interface and we will modify it to work on the 464+
only £15.00 + £3.53 P&P

MINI OFFICE 2

**Complete Word Processor
Database, Spreadsheet
Communications**

All in one package!!!!!!

Cassette Ver. £14.99 + £1.18 P&P
Disk Ver. £19.99 + £1.18 P&P

GX 4000 GAMES AVAILABLE

MYSTICAL • WORLD OF SPORTS
TINTIN ON THE MOON

Games £12.95 + £3.53 P&P each

THIS MONTH ONLY

AMSTRAD CPC+ & GX4000 PADDLES
ONLY £3.99 + £1.18 P&P

WAVE ELECTRONICS

(DEPT AA9303)

1 BUCCLEUCH STREET, BARROW IN FURNESS, CUMBRIA LA14 1SR
Tel: (0229) 870000 (6 Lines), Fax: (0229) 829109