

The Official Amstrad Magazine

August 1986

£1.00

AMSTRAD COMPUTER USER

10.7 86
3 31.00

GLADIATOR

– Domark given the thumbs up

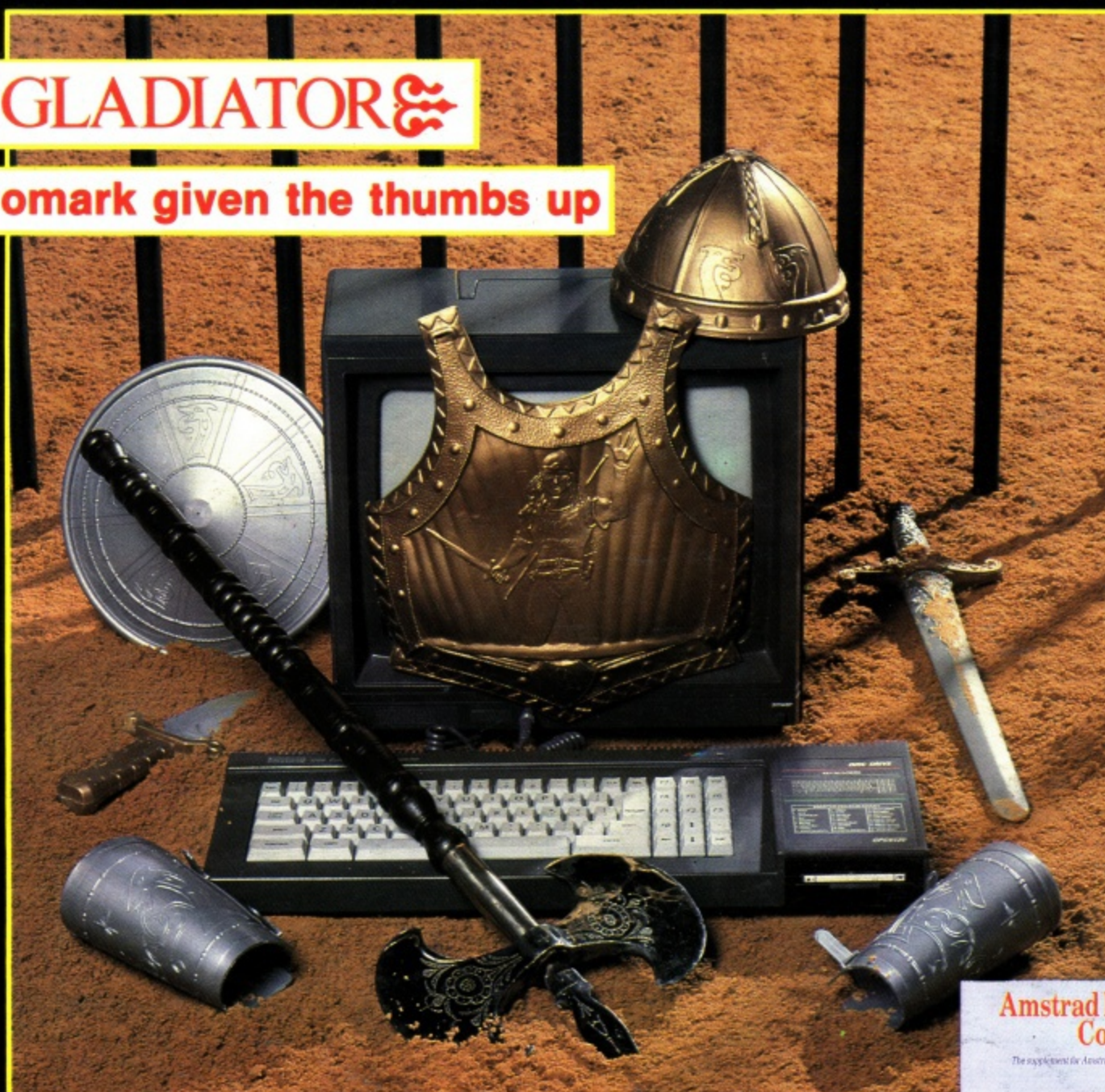

Which printer? Epson v Oki v Citizen

Equinox – full map inside

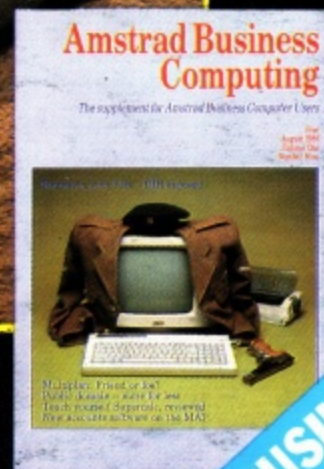

**FREE BUSINESS
SUPPLEMENT**

AMSTRAD

V21/23 MODEM



ONLY
£99.95
inc VAT

In addition to the modem with B.T. connecting plug and lead, you are supplied with a lead to connect to your Amstrad computer RS232 Interface and a voucher entitling you to the 1st quarters subscription to both *Prestel and *Micronet 800 free of charge.

BY **PACE**

AMSTRAD CONSUMER ELECTRONICS PLC.

BRENTWOOD HOUSE, 169 KINGS ROAD, BRENTWOOD, ESSEX CM14 4EF Tel: (0277) 228888



APPROVED for connection to telecommunication systems specified in the instructions for use subject to the conditions set out in them.

S/2982/3/G/500472

micronet
800

REGULARS

- 5 **News**
- 11 **Letters**
- 34 **Gallup and Readers' charts**
- 90 **Least Significant Bit**

FEATURES

- 17 **Adventure column**
Bill Brock pays the Price of Magik
- 23 **Domark**
Fighting back with Gladiator
- 24 **Equinox mapped**
Your guide to the Mikro-Gen megagame
- 37 **Hackers Haunt**
Vax and folks present Hax and pokes
- 67 **Mastertronic unmasked**
Good software at low prices

PROGRAMMING

- 64 **Goin' Loco**
Alexander Martin, a man of many colours
- 75 **Interceptor**
Top-notch shoot-'em-up type-in
- 79 **Space Mania**
The end for the tired finger brigade.

REVIEWS

- 30 **Printers on parade**
Oki takes on the might of Epson and Citizen
- 42 **Midi makes music**
Get your Roland talking to your Arnold
- 47 **Beebug Toolkit**
It pays to be lazy
- 51 **Games software**
Colin, Liz and Nigel do their stuff

ABC

- III **Editorial**
The news you've been waiting for
- V **Supercalc made easy**
Let the computer teach you the Number 1 spreadsheet
- IX **MAP Accounts**
A full accounting package reviewed
- XIII **Public domain software**
There's lots of good software and it's free
- XVII **Multiplan**
An old faithful of the spreadsheets now on CP/M+
- XXI **Tasword 8000**
The promotion of a word processor from the Spectrum to the Joyce takes Jeremy Spencer down memory lane
- XXXI **Forum**
Your letters . . . and who not to listen to
- XXXV **Subscribe**
A new magazine is not to be missed
- XXXIX **Custom built databases Part II**
The bit we didn't print last month
- XLV **Advanced Locoscript for beginners**
Eddie gets out his phrase book
- XLIX **CP/M Command by Command**
DIR. I never knew there was so much in it
- LIII **Introduction to accounts**
Debit and Credit check that you do need a computer

AMSTRAD
COMPUTER USER

The official magazine for users of Amstrad computers

169 King's Road, Brentwood, Essex CM14 4EF.
Tel: 0277-234459 (Editorial); 0277 234434 (Advertising)
Telecom Gold: 72:MAG012

Editor: Simon Rockman
Deputy Editor: Jeremy Spencer
Assistant to the Editor: Alexander Martin
Advertisement Manager: Jane Nolan
Advertisement Assistant: Lorraine Day

News trade distribution: Europress Sales & Distribution Ltd, Unit 1, Burgess Road, Ivyhouse Lane, Hastings, East Sussex TN35 4NR. Tel: 0424 430422.

© Amstrad Computer User: No part of this publication may be reproduced without permission. While every effort is made to ensure the accuracy of all features and listings we cannot accept any liability for any mistakes or misprints. The views and opinions expressed are not necessarily those of Amstrad or Amsoft but represent the views of our many readers, owners, members and contributors. We regret that Amstrad Computer User cannot enter into personal correspondence.

Lazahold Ltd.
trading as

Amsoft

**BUSINESS, EDUCATIONAL AND GAMES SOFTWARE
DIRECT TO YOU BY EASY MAIL ORDER
- PERIPHERALS TOO!**



DON'T FORGET

- 15% DISCOUNT ON PURCHASES
- YOUR OWN MEMBERS' NEWSLETTER
- "MEMBERS ONLY" SPECIAL OFFERS
- THIS MAGAZINE EVERY MONTH TO YOUR DOOR
- PRIVILEGE CARD



Telephone us for a faster, easier service.
Orders using credit card (Access or Visa)
0783 673395 9am-5pm Monday to Friday
9am-12 noon Saturday

Send for FREE information

Complete this coupon and return it to the address shown on the envelope

*Approximate discount on most items, see price list for details.

DELIVERY ONLY WITHIN U.K.

Lazahold Ltd, trading as Amstrad User Club and Amsoft

I would like full details of Amsoft Mail Order and the Amstrad User Club Software Catalogues, Sales Leaflets, and order forms.

Name

Address

.....

.....

..... Post Code

TUBARUBA

ADVANCE
SOFTWARE PROMOTIONS LTD



SUITABLE FOR ALL AMSTRAD AND SCHNEIDER GAMES MACHINES
EXPORT ENQUIRIES WELCOME
0279/22846

Now available from AMSTRAD USER CLUB, Victoria House, P.O. Box 10, Sunderland.

Our show even beat the weather..

The fourth Amstrad Computer Show attracted more exhibitors and visitors than ever before. For the first time it took over an extra floor at the Novotel and despite the wonderful weather the show was very well attended.

The much rumoured Amstrad IBM lookalike was not launched, despite claims from the misinformed that it would be shown. Amstrad have a tight policy of not pre-announcing products and refuse to discuss any products they may be working on. They deny the existence of any new computer.

Amstrad did have one new product, the modem, a re-badged version of the Pace Nightingale. The Amstrad modem costs £99.95 and includes a free subscription to Micronet.

The noisiest stand award goes to Load & Run who had a special offer on the Electromusic Research Midi interface (reviewed this month). Mike Beecher from EMR gave a very impressive demonstration of using the Amstrad to control a variety of keyboards and drum machines.

Loadplan produced a classic game for the PCW - Space Invaders. Software houses have decided en masse to support the Joyce with games. Ocean are to convert Batman and The Edge will be releasing a Joyce version of Fairlight.

CRL already have some PCW games, Castle Blackstar and S.A.S. Raid, although none of these were seen at the show. Cascade used the Amstrad stand to demonstrate their new joystick interface on the PCW.

They hope to set a new standard for the machine and want any software house with games in the pipeline to contact them. The Cascade joystick interface for the PCW 8256/8512 is expected to cost around £20.

Pace had a new hardware add-on for the PCW, a serial and Centronics interface. This scores over the Amstrad version in that it is cheaper and easily available but does not conform to the full RS232 specification since it only outputs 5 volts when the spec requires 12 volts. Still, this will not matter for the vast majority of applications.

Both Quest and Caxton took large stands with which to be very Quest and Caxtonlike. Quest launched three new products including a solicitors' accounting package which rivals systems for many times the price.



Programs for the CPC

DK'Tronics ran a competition to give away a RAM pack. They were selling the software which lets a 6128 use the second bank of RAM as a silicon disc. In the near future - coming real soon now - DK will have a television tuner for the Amstrad colour monitor. This lets you use your computer as a telly.

Just think, you can now have all the arguments that having a dedicated monitor avoided. You can now watch Knight Rider instead of playing it. The unit sits under the monitor and will cost £59.95.

Gultronics proved that the DMP2000 is no longer a rare beast, by having a stand full of the things. AMS still hadn't finished Pagemaker (hurry up Jay and Gary, people are waiting) but at least they were taking orders. So that you can get pictures into Pagemaker, AMS are working on a digitising camera. They had some impressive hardware on the stand, including a Commodore Amiga and a Cannon bubblejet printer.

Grafsales were busy selling the ever popular Graphpad digitising tablet and showing a nearly completed version of the Joyce Graphpad.

Sunshine Books were selling a new book on the 8256, which was "going like hot... well pretty warm... cakes". Timatic is a name from the past. They have been involved in the Arnold project

for a very long time. If you want to connect a funny disc (sic) drive to your computer then they are the people to do it. They produced the most expensive peripheral of the show a £5,000 plotter.

The largest stand was that of NewStar, who were selling lots of expensive CP/M stuff with HiSoft, MML Systems and Ambyte lending a hand.

Mikro-Gen were the only major games software house on the upper floor. They had Equinox on tape and disc, along with Battle of the Planets (a much underrated game) and the Wally progs. Their next release - Stainless Steel will be out in July.

Glentop Publishing produced a new range of books, one on the Joyce and an Advanced Programmers Guide which documents lots of things about the 464 which Amstrad would rather you didn't know.

Mirrorsoft were a major attraction, demonstrating an early version of Fleet Street Editor.

The highlight was a visit from Biggles himself, seen above reading about the Mirrorsoft game. He had just flown in, by helicopter, from Manchester where he had been appearing on the Saturday Picture Show.

The show may not have had very many surprises, but proved to be a worthwhile day out for any Amstrad owner.

Return of Willy's authors

Software Projects, authors of Manic Miner and Jet Set Willy, have been very quiet in recent times. Now they have burst back into the limelight by announcing a new product, Dragon's Lair.

This was originally a laser disc arcade game with cartoons by Walt Disney illustrator Don Bluth. Several people have threatened to produce a home version but now it looks as though it is actually happening.

The game follows a dungeon adventure theme where, according to the direction in which you move the joystick, different sections of animation are displayed.

In the arcades Dragon's Lair was so popular that players queued into the streets. We don't know how Software Projects intend to produce the same effect without a laser disc, but we are quite sure they will do justice to Dirk the Daring as he battles to save the princess.

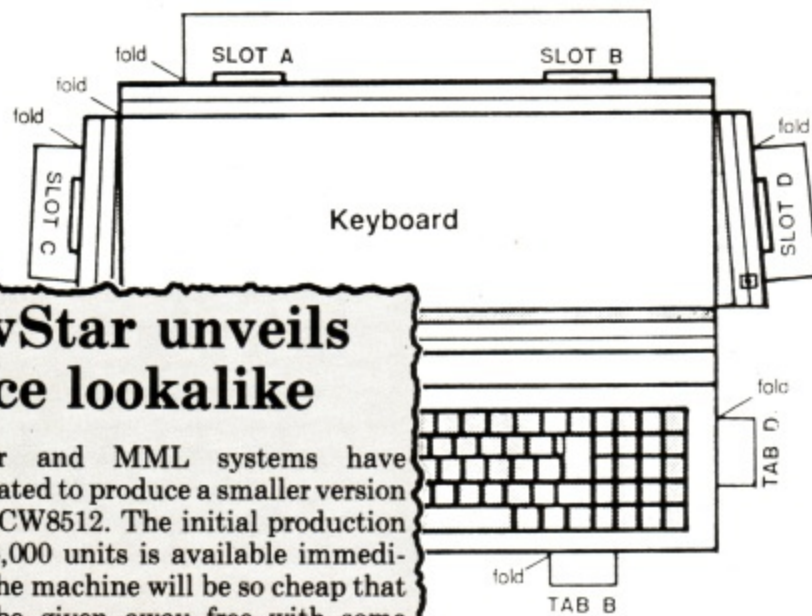
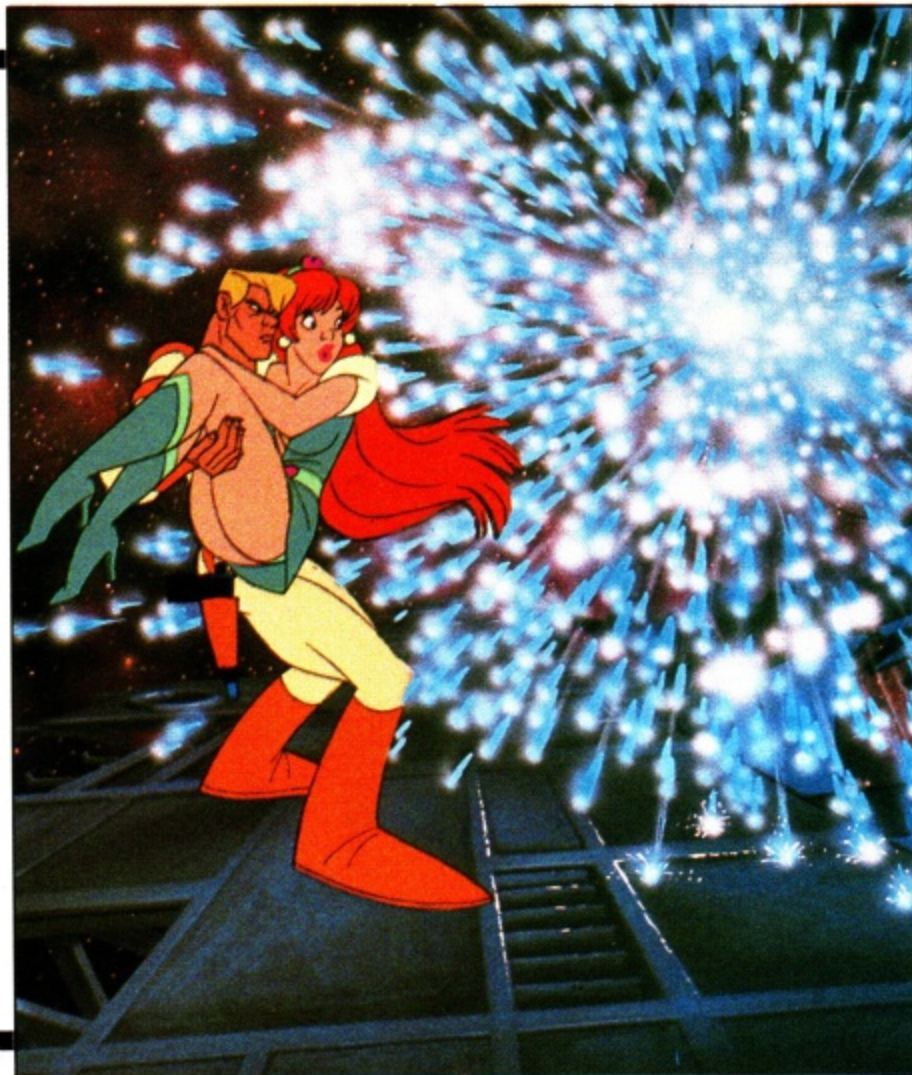

NewStar unveils Joyce lookalike

NewStar and MML systems have collaborated to produce a smaller version of the PCW8512. The initial production run of 5,000 units is available immediately. The machine will be so cheap that it will be given away free with some software.

Called "This is not the PCW8512" the machine comes with two discs and a sheet of paper. More precisely the machine IS a piece of paper—a cardboard cut-out. By cutting along the lines, glueing and folding in best cereal packet style you can build a model Joyce.

William Poel of NewStar sent out press releases to lots of the big computer magazines and the national newspapers telling them of a major new computer launch at the Amstrad show. Next month we will offer a cardboard cut-out of an angry mob! Amstrad customer services have already designed the cut-out CPS8256.

Micronet discovers the Amstrad

It took Amstrad users a surprisingly long time to discover Micronet, but now thanks to the likes of Amstrad, Pace, Cirkit, Honeysoft and others there are lots of eager Amstrad computer users on-line.

Now that they have discovered Micronet, Micronet has discovered Amstrad users and is providing a database for them, to rival the increasingly popular Amsnet run by Viewfax, another Prestel information provider.

The Amstrad Microbase will have news, a technical hotline and some free telesoftware.

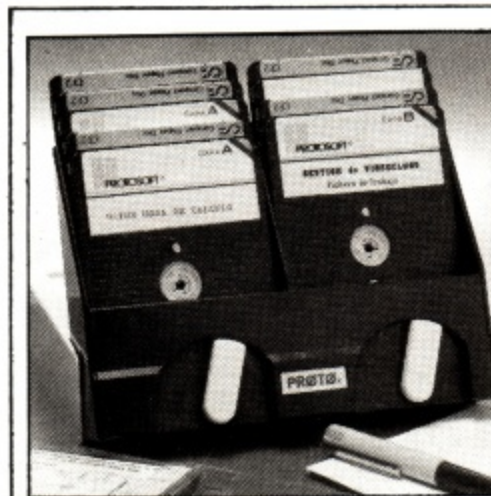

Boxing clever

The world has been waiting for a box to take 3in discs. 5¼in discs fit neatly into a shoebox and there are loads of different types of boxes for 3½in discs but only now is there a box for the industry standard 3in disc.

Made by Protomec of Spain it has a clever little lever which makes it easy to get the discs out.

The box costs £6.95 and holds 10 discs. You can get them from SBS data services of Brighton (0273) 726331.

Try beating our AMDRUM!



AMDRUM
DIGITAL DRUM
SYSTEM
for the
AMSTRAD
464/664/6128

£34.95

As featured on
"Micro Live"
and
"Saturday
Superstore"

- 8 DIGITALLY RECORDED REAL DRUM SOUNDS
- SIMPLE TO USE — UP AND RUNNING IN ONLY MINUTES
- A TRUE DIGITAL DRUM MACHINE
- 'REAL TIME' OR ON-SCREEN PROGRAMMING
- COMPLETE WITH SOFTWARE
- EXTRA SOUNDS CAN BE LOADED FROM TAPE
- CREATIVE, EDUCATIONAL AND FUN
- THE MOST EXCITING PERIPHERAL EVER DEVELOPED
- DYNAMIC FILING SYSTEM — STORE OVER 1000 PROGRAMMED RHYTHMS
- TAPE SYNC FACILITY
- SONGS CAN BE SAVED ON TAPE
- POLYPHONIC
- COMPREHENSIVE MANUAL
- JUST PLUGS INTO MOST HI FI'S

Available from  John Menzies High St. Stores
and all good computer shops or direct
from Cheetah Marketing.

NOW AVAILABLE
Latin Kit & Editor
£3.99
Electro Kit & Editor
£4.99

Cheetah
Marketing 

1 WILLOWBROOK SCIENCE PARK, CRICKHOWELL ROAD, ST MELLONS, CARDIFF
TELEPHONE: CARDIFF (0222) 777337 TELEX: 497455
(Export enquiries — contact Cheetah direct)



WARNING
BUSINESS USERS

COMPUTER BREAKDOWN CAN STOP YOUR BUSINESS IN IT'S TRACKS

CAN YOU WAIT 2 WEEKS OR MORE FOR REPAIRS?

We GUARANTEE to get you back in business in 3 WORKING DAYS!

8256 ONLY £29.95 } FOR 12 MONTHS SERVICE CONTRACT & PEACE OF MIND.
8512 ONLY £39.95 }

We collect by GROUP 4 COURIER at our expense — We receive next morning — We repair and return same day.

Phone or post the coupon for a Service Contract Form — before it's too late! Or send your remittance together with the machines serial numbers and we will return the Agreement with your receipt by return.



FREE SERVICE CONTRACT when you buy your
8256 £458
8512 £573
from us.

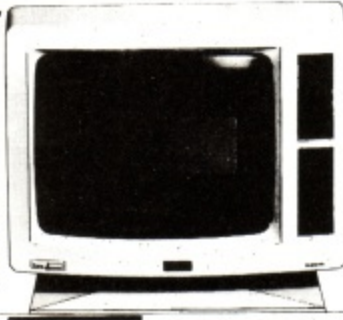

256K UP-GRADE
NOW ONLY **£34.95**

ELECTRIC STUDIO LIGHT PEN
FOR GRAPHIC DESIGN ONLY
£69.95

8256 UP-GRADE £222.00
TO FULL 8512 SPEC
INC. DISC DRIVE & MEMORY.
£179.95
VAT & P.P.

BASIC DRAWING* PACKAGE D.R. DRAW & ELECTRIC STUDIO LIGHT PEN
WAS £129.90 **£99.90**

IBM COMPATIBLE NEW P.C.
PHONE FOR DETAILS

POCKET WORDSTAR
SAVE £15
ONLY **£34.95**

BASIC BUSINESS PACKAGE *
"The CRACKER" Spread sheet & Gemini "Data Gem" Data base ~~£88.95~~
£74.95

HARDWARE

AMSTRAD PCW 8256	£458.85
AMSTRAD PCW 8512	£573.85
RS232/CENTRONICS I/F	£59.95
FD2 (2nd Disc Drive) IN STOCK	£169.95
256K RAM UPGRADE	£34.95
EXTENSION LEAD SET	£14.95
DUST COVER	£14.95
PRINTER RIBBONS PCW 8256/8512	£5.95
3" DISCS SINGLE DENSITY/10	£39.95
3" DISCS DOUBLE DENSITY/10	£59.95
AMSTRAD DMP 2000 PRINTER	£149.95

BOOKS

Mastering the PCW 8256	£8.95
Soul of CPM	£14.95
CP/M Software Bus	£8.95
CP/M Bible	£15.95
Amstrad Word Processing PCW 8256	£8.95
Introduction to Amstrad CP/M	£9.95
Assembly Language	£9.95
Using the PWC 8256	£9.95
CP/M Handbook	£14.95

FREE 3" DISC WORTH £4.95 With any two Software Packages. VALUE MORE THAN £40 EACH EXCEPT ITEMS MARKED WITH *



SOFTWARE DISCOUNTS FOR THE KNOWLEDGEABLE*
OR REGULAR PRICES IF YOU WOULD LIKE TO TAKE ADVANTAGE OF OUR HELPLINE SERVICE.
PLEASE PHONE FOR FREE ADVICE ON THE MOST SUITABLE SOFTWARE FOR YOUR COMPANY.

LEISURE	
Bridge	£17.95
Hitchhikers Guide	£26.95
3D Clock Chess	£17.95
Classic Adventure	£13.45
EDUCATIONAL	
Locoscript Tutorial	£9.95 £7.95
Ian Key Typing Course	£24.95 £22.95
Ian Key Two Finger Typing	£24.95 £22.95
Touch N Go	£24.95 £22.95
Hands-On CP/M Plus	£24.95 £19.95
Hands-On Supercalc	£24.95 £19.95
Hands-On dBase II	£24.95 £19.95
COMMUNICATION	
Sage 'E' Mail	£69.95 £62.95
Sage Viewdata	£69.95 £62.95
Modem with Viewdator OR 'E' Mail	£199.95 £179.95
Modem with Viewdator AND 'E' Mail	£239.95 £214.95
WORDPROCESSING	
New Word	£69.00 £62.10
Pocket Wordstar	£49.95 £34.95
Pocket Spellstar	£24.95 £22.95

DATABASES	
Gemini Data Gem	£39.95 £35.95
Camsoft Cambase	£49.95 £44.95
Pocket Datastar	£49.95 £44.95
Pocket Reportstar	£39.95 £36.95
Cardbox	£99.95 £89.95
Delta	£99.95 £89.95
Sage Retrieve	£69.95 £62.95
Sage Magic Filer	£69.95 £62.95
Microfiler with Microword	£49.95 £44.95
Condor 1	£99.95 £89.95
Matchbox	£29.95 £26.95
D Base II	£119.00 £99.95
NEW Compact Nucleus	£99.95 £89.95
SPREADSHEETS	
Supercalc 2	£49.95 £44.95
Cracker	£49.00 £44.95
Plannercalc	£39.00 £34.95
Multiplan	£69.00 £62.95
Master Planner	£99.50 £89.95
Scratchpad	£69.99 £62.95
Pocket Calcstar	£49.95 £44.95

GENERAL	
Target Task	£99.95 £89.95
Brainstorm	£49.95 £44.95
Smart Key II	£49.95 £44.95
DR Pascal	£49.95 £44.95
DR C Basec Compiler	£49.95 £44.95
DR Draw	£49.95 £44.95
DR Graph	£49.95 £44.95
ACCOUNTS PACKAGES	
Compact Sales & Invoicing	£69.95 £62.95
Compact Sales Ledger	£69.95 £62.95
Compact Stock Control	£69.95 £62.95
Compact Sales Ledger	£69.95 £62.95
Compact Purchase Ledger	£69.95 £62.95
Compact Nominal Ledger	£69.95 £62.95
Compact Payroll	£99.95 £89.95
Compact Integrated Acts	£199.99 £179.95
Compact Daybook	£49.95 £44.95
Camsoft Stock	£49.95 £44.95
Camsoft Sales Ledger	£49.95 £44.95
Camsoft Purchase Ledger	£49.95 £44.95
Camsoft Nominal Ledger	£49.95 £44.95
Camsoft Invoicing	£49.95 £44.95
Camsoft Stock/Invoicing/Sales	£99.95 £89.95

ACCOUNTANTS PACKAGES	
Sage Popular	£99.99 £89.95
Sage Combo	£149.99 £134.95
Sage Super Combo	£199.99 £179.95
Quest Cash Trader	£99.95 £89.95
Quest Cash Trader/Analyser	£149.95 £134.95
Shoobox	£149.95 £134.95
Time & Cost Recorder	£69.95 £62.95
PAYROLL	
Compact	£99.95 £89.95
Cam Soft	£49.95 £44.95
Sage	£69.95 £62.95

ALL PRICES INCLUDE VAT, POSTAGE AND PACKAGING.
EXPERT SYSTEMS
NORTHAMPTON NN1 1BR
Tel: (0604) 24463

Please send me the following items:-

Quantity	Product	Price (inc VAT)	Name Mr/Mrs/Miss	Address	Postcode	Tel. No.	Signed
TOTAL			I enclose (please tick) <input type="checkbox"/> cheque/p.o. or, please debit to my <input type="checkbox"/> Access <input type="checkbox"/> Visa card				

EXPERT SYSTEMS



LONDON'S LARGEST DISPLAY OF PRINTERS MONITORS COMPUTERS AND PERIPHERALS

DON'T TAKE A CHANCE

—COMPARE BEFORE YOU BUY

OVER 40
PRINTERS ON
DISPLAY — MOST ON
DEMONSTRATION

HI VOLTAGE London's Largest Amstrad Dealer

AMSTRAD NETWORK AND 20Mb HARD DISC SYSTEM

Connect up to 100 Amstrad Computers plus printers etc together.
On demonstration now!
Distributor for South London

EXCHANGE YOUR 8256 FOR A NEW 8512

For not much more than the cost of the second disc drive. Phone for details.

South London's best range of
Amstrad Games and Educational
Software — off the shelf

ALL PRICES INCLUDE VAT

PCW 8256/8512 (Joyce)

Software

Accounts

Sage Accounts (A)	£99.95
Sage Payroll (B)	£69.95
Sage Invoice & Stock control (C)	£69.95
Sage Accounts Plus (A+C)	£149.95
Sage Combo (A+B)	£149.95
Sage Super Combo (A+B+C)	£199.95
Camssoft Accounts (D)	£99.95
Camssoft Invoice plus stock and sales ledger (E)	£99.95
Camssoft Combo (D+E)	£149.95
Camssoft Payroll	£49.95
Cash Trader less Analyser	£99.95
Cash Trader inc Analyser	£149.95

Also available Compact and ABCS accounts packages

Word Processors

NewWord	£69.00
Pocket Wordstar	£49.95
Superwriter	£49.95
Microword/Microfile W/P + D/B	£49.95
Polyprint + Polyword	£29.95

Databases

Delta 1.25	£99.95
Dbasell	£119.00
Condor I	£99.95
Cardbox	£99.95
Sage Retrieve	£69.95

Spreadsheets

Super Calc II	£49.95
Cracker II	£49.00
Scratch Pad +	£69.95
Multiplan	£69.00

Graphics

Electronic Studio Light Pen + Graphics Software	£79.95
DR Draw	£49.95
DR Graph	£49.95

Typing Tutors

Touch 'n' Go	£24.95
Iansyst Crash Typing	£24.95
Iansyst Two Fingers	£24.95

Games

3D Clock Chess	£19.95
Bridge Player	£19.95

Tutorial Cassettes

Locoscript	£9.95
CPM plus basic	£9.95

Super Calc II	£6.95
NewWord	£9.95
Multiplan	£9.95

Hardware

PCW8256	£454.13
PCW8512	£569.13
FD2 1MB Second drive	£172.38
CPS Serial/Parallel/F	£68.88
Nightingale modem + comms. s/w	£229.88
Sage chit chat modem plus E. Mails/w	£199.95
Sage chit chat modem plus Prestels/w	£199.95
Maintenance contract for 8256	£41.40
Maintenance contract for 8512	£51.75

CPC6128/464 (Arnold)

Software

	Cassette	Disk
Tasword 464 WP	£19.95	£24.95
Tasword 6128 WP	—	£24.95
Armor Protext WP	—	£26.95
Armor Maxam assem	—	£26.95
(also available on ROM & Cartridge)		
Beebug Soft Rembrant	£13.95	£16.95
Mini Office II	£14.95	£19.95
Laserbasic	£14.95	£19.95
'C' language	£34.95	£39.95
Supercalc II	—	£49.95
Sage Accounts	—	£99.95
Sage Payroll	—	£69.95
Mastercalc	£24.95	£29.95
EasiAMScalc	£19.95	—
Masterfile	£24.95	£29.95
Gemini Office Master	—	£24.95
Gemini Office Mate	£15.00	£17.50
AMX Pagemaker	—	£49.95
Fleet Street Editor	—	£49.95

Hardware

CPC464 Green Monitor	£198.95
CPC464 Colour Monitor	£298.95
CPC6128 Green Monitor	£298.95
CPC6128 Colour Monitor	£398.95
DD1 Disk drive plus cont.	£159.85
FD1 2nd disk drive inc cable	£107.95
MP2 RF modulator	£29.90
RS232I/F	£49.95
AMX mouse	£69.95
Graphpad III	£68.95
Nightingale modem plus commstar plus RS232I/F	£172.38

DAISY WHEEL PRINTER PACKAGE FOR PCW8256/8512

£199.96 + VAT
(£229.95 inc VAT)

Everything you need to produce letter quality print from the Amstrad PCW range:

- Silver-Reed EXP400 High quality daisy wheel printer
- PCW Parallel/Serial interface
- Parallel Printer Cable
- NEW Tasword 8000 Word Processor Software

Extra for Pocket Wordstar W/P **£25 inc VAT**

Extra for Newword W/P **£45 inc VAT**

DOT MATRIX PRINTERS

Citizen 120D NLQ	£179.95
Epson LX80 NLQ	£229.88
Epson FX85 NLQ	£425.38
Epson LQ800 NLQ	£574.88
Canon PW1080A NLQ/Kaga	£310.38
Canon PW1156A NLQ/Kaga	£420.78
Oki-Mate 20 Colour	£229.88
Seiksha SP1000 NLQ	£229.88
Star NL10 (IBM) NLQ	£279.90

All popular interfaces, cables, etc. available from stock. Custom cables made to order. Let our experts match your computer to the printer of your choice.

Printers — All models parallel-centronics interface Serial RS232C available at same or slightly higher prices.

**EXPORT CUSTOMERS
SUPPLIED TAX FREE
ASK FOR OUR
EXPORT LIST**

Mail Order + Export Hot Line Phone 01-686 6362



Delivery by Securicor (4 day) please add £5.75 per item.
Delivery by Securicor 24 hour please add £9.95 per item.



Send off or order by 'phone quoting your Access, Visa No. 'Phone 01-686 6362.
Immediate despatch on receipt of order or cheque clearance. Or you can Telex your order on: 946240 Attn 19001335

OPEN MONDAY - SATURDAY 9 AM - 6 PM

OPEN MONDAY - SATURDAY 9 AM - 6 PM

ALSO VAST RANGE OF DISK DRIVES, JOYSTICKS, DISK BOXES, INTERFACES, SHEETFEEDERS, ETC.

HI VOLTAGE 53-59 High Street, Croydon, Surrey CR0 1QD. Tel: 01-681 3022

Prices correct at copy date. Subject to change without notice due to currency fluctuations etc. E. & O.E.

Small Business Accounts & V.A.T. made Simple.

Accounts and V.A.T. **made simple** is the answer for your business

- Professional business software on a single drive Amstrad, (but better with 2 drives).
- Over 1500 Users on many other computers.
- Cash Book accounting made simple
- Control of Unpaid Bills.
- Single entry — no knowledge of book-keeping required.
- Produces VAT Return for Special Schemes 'A' to 'J' and Pharmacy Scheme 'B'.
- Trading and Profit and Loss Account at any time.
- Very simple to operate weekly accounts.
- Fully accepted by Customs & Excise.
- User Club and 'HOTLINE' support team.
- Ideal for all Retailers and other cash businesses.
- £99.95 inc. VAT on Sale or Return.
- Invoicing and Customers Accounts **made simple** available soon.

YES — Clip the Coupon now or telephone 0625 615375 and we will rush you a copy "Sale or Return" on receipt of your cheque. If not suitable we will refund your money in full within 28 days.



Micro Simplex is a Division
of Sandhurst Marketing p.l.c.

Please return coupon & cheque to:
Micro Simplex, 8 Charlotte St. West, Macclesfield, Cheshire SK11 6EF

Name

Company Address

.....

Telephone

Type of Business

Please bear in mind that the views expressed herein are not necessarily those of Amstrad or Amsoft. Be assured that all your views are given thorough consideration. This letters section is the Amstrad Computer User's own forum.

Write to reply

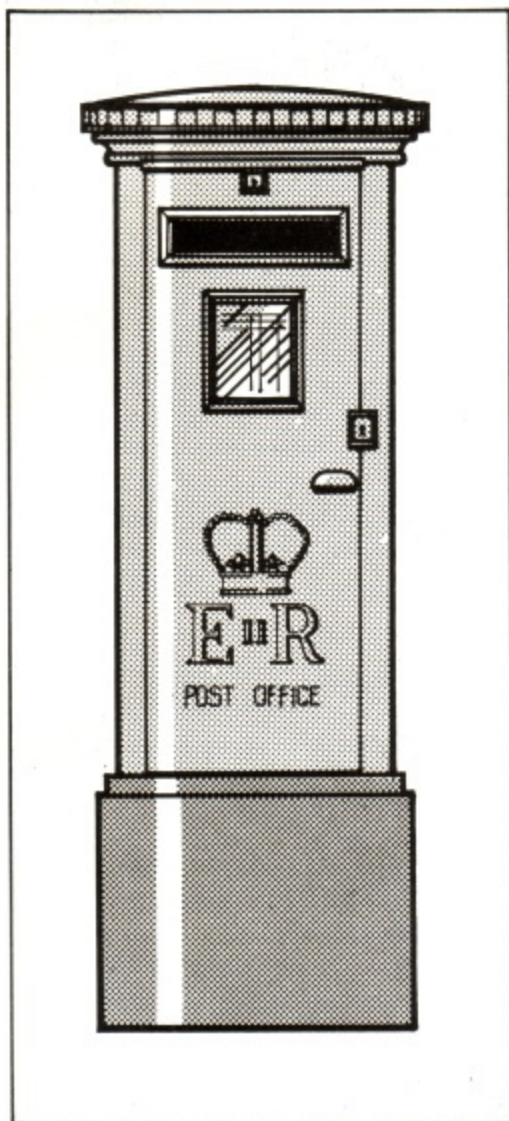

Screen stealing

I have read *ACU* since its introduction and have found much interest in the articles and listings, many of which I have typed and run successfully.

As I don't own a printer could you please tell me if I can use the events and screen dumps program in the March 1985 issue to save a picture to cassette? I would be very grateful for your help.

David Dukes,
Newcastle,
Staffs.

ACU: Yes, you can adapt the events part of the program to save a screen but the registers which control the colours are write-only so you will not be able to save those.

Cut off Quickshot

In the May issue of *ACU* there was a review on joysticks. One of those

mentioned was the Quickshot II which you said had problems with the autofire.

I bought a Quickshot II about a year ago and found the same problem but now I have a simple solution. All you have to do is remove the bottom of your Quickshot and remove the red wire from the side of the circuit board, then tape over or cut off the end of the wire.

Crawford Alves,
Bearsden,

Glasgow.

ACU: Thanks for the tip. What you didn't say was that this modification only stops the auto-fire from crashing the computer - it doesn't get the auto-fire to work.

A different sort of character

In the June issue of *ACU* I found a letter from a nice Amstrad-enthusiastic teacher.

She had a problem which was that the foreign characters of French, Spanish, and German wouldn't come out on her DMP1 printer, only on the screen.

But your help to the teacher was not very nice - you recommended her to buy a Joyce, and that was not a very friendly move. There is a solution - the program Tasprint from Tasman Software is a very impressive program for the Amstrad. It is 100 per cent compatible with Tasword/Amword and some Basic programs. It can make a lot of foreign characters in five very handsome styles, on a lot of printers, including the DMP1.

Those were the bad things . . . and now the good ones. *ACU* is the best computer magazine I have ever seen, keep it going like that, and I will read it to my dying day. It is professional, funny and very interesting.

Rene Hjorth,
Helsingø,
Denmark.

ACU: We didn't know that the editor had any relative in Denmark. Thanks for writing.

Questions, questions, questions

First things first - could you tell me if there is any book on the market which deals entirely with music on the

Amstrad? And also what is the best listings book? (*Try Music & Sound on your Amstrad from Melbourne House - we can't recommend a general listings book.*)

Now here's a few hints for your magazine, excellent though it is. (*Creep.*)

1. Less of ABC (*That's not what the Joyce owners say.*) 2. Keep up the Hairy Hacker's Haunt, as it's very good. (*Blush, blush - compliments passed on to Vax & co.*) 3. Fewer adverts, there are too many. (*In the main it is the adverts which pay for the magazine, the more ads the more pages overall.*) 4. How about a software company top 20 chart? (*If there is the demand we will try.*) 5. Your software reviews are excellent, keep them up, especially your colour screen shots. (*Thanks.*) 6. How about doing a software mailing system, where we can buy any game reviewed in all your issues? (*The administration for this would be very difficult - besides it looks a little fishy if we review things and then try to sell them to you.*) 7. Keep printing listings with screen shots if possible. (*Point taken.*) 8. Could you maybe lower the price of your listings tape? (*With the small production runs we have on the tape and the administration and postage costs involved, it really is as cheap as is practical.*)

Andrew Duff,
Ross-shire,
Scotland.

Welsh accent

Following on from Susanne Lees' letter - and your reply - why won't my PCW8256 Locoscript permit me to produce grammatical Welsh? With the current emphasis here on bilingualism (my driving licence and all official forms are supplied in both English and Welsh - if they aren't, they go on the fire) can't the half-million of us who understand the language find a way around this problem?

It is crucial to be able to produce the letter w and y with a circumflex, or a "to bach". For example, I can type the name of the town Cwmbrân correctly, but when I try it with my own address it comes out as Tŷ Clwyta Cottages - not good enough!

At least the PCW8256 doesn't insult us

as much as the newspaper computers in use down here, which all seem to delight in splitting and hyphenating the dd, ff and ll – which, of course, are single letters in the Welsh alphabet.

It may not seem important to you, but it does to us – the word for a choir is *côr*, but if you leave off the circumflex it translates as dwarf. And if you're writing to the Welsh Water Authority, the word for water is *Dôwr* – without the circumflex, it can translate as a heap of manure. Pob hwyl.

Mick Tems,
Mid Glamorgan,
Wales.

ACU: I hope we got all the accents and things right printing your letter. The number of Welsh users does not justify the cost of producing a special manual and software.

Novel use for 464

The Rev. Allan Webster's one line word processor reminds me of a similar program I wrote two years ago. I used it on my 464 – one of the very first batch – while I waited for the Amsword word processor to appear.

I used it to write a fantasy novel, Finnglas and the stones of choosing (Lion Publishing, £1.50).

Fay Sampson,
Exeter.

ACU: It is normal for us to charge for advertisements – still we'll let you get away with this plug.

High speed discs

Ten days ago I purchased a PCW8256. Since then I have tried in vain to obtain spare CF2 discs locally. Yesterday lunchtime I picked up the phone and called Squirrel's Byte Leicester, and the discs arrived this morning 9am. Thank you Squirrel's Byte and the Post Office.

J.M. Ambler,
Seamer,
Scarborough.

Master of the sprites

I am fairly new to computing and I was wondering if there is any way to get multicoloured sprites using the SYMBOL command.

Richard Devlin,
Derry,
N. Ireland.

ACU: We had a great article on multicoloured characters in the December issue, but it is a shade (ouch!) more complicated than just using the SYMBOL command. See the back issues coupon on Page 85.

Software con

Referring to my letter published in April's edition of ACU I cannot accept or understand your remarks that software is expensive to produce, unless there is a figure relative to the risk. Writing this letter is an expensive exercise. The statement is meaningless unless relative values against financial risks are considered.

Expecting a customer like me to pay £300 for a common everyday program like Wordstar, without the feeling that I've fallen for the three card trick, has got to be a joke. Because if companies like Dixons can give it away free, then it is because the suckers – of which I will not be one – are subsidising the promotion of a computer which they do not support without realising it. These are the real pirates in the computer world, not me.

All I want to do is pay a fair price and not feel a ripe plum ready for the taking.

Walter Parsons,
Royston,
Herts.

ACU: We concede that £300 for Wordstar and similar programs is too much, but you have to look at the history of the products. When a CP/M system cost £5,000 there were not nearly as many customers as there are now that a similar system costs £500. A game takes between three months and two years to write, and will sell in the thousands. Writing a program like Wordstar is a risk – you have to guess how many copies you are likely to sell and average the cost of development out over the sales.

With Wordstar MicroPro guessed wrongly and overpriced it – although at the time the competition also sold at similar high prices. Similar arguments could be put forward on the games scene – sometimes volume will more than compensate for low margins. If there is the demand then the product should be cheap, if not you will have to pay more. Remember you can't expect the same amount of support with a £30 program as you get with a £150 program.

Disc dearth

Why do most software companies treat CPC6128 and 664 owners like they have the plague? What I mean is because I have a disc drive I feel like an outcast. Let me give you an example.

I purchased both a copy of Arnhem and Desert Rats from CCS on tape as this is the only format available. Being a basic machine code programmer I worked out that both programs can be converted to disc properly if the AMSDOS workspace is moved.

Now this is beyond me so I wrote to

CCS requesting if they could transfer both programs – for a fee – or provide technical information. They told me that Desert Rats was released before the disc drive CPCs – which is not true – and that they had finished with Desert Rats and were moving on to other programs.

This is the standard reply I seem to receive from software houses on this matter. This type of treatment of users should be stopped and maybe your magazine could lead the way towards this.

The standard reason for not providing certain software on disc is the lack of supply of this format, which is a lot of rubbish because they can provide a version on the tape which can be transferred to disc. The software house's reply would be that it makes it easy to copy its programs. The fact of the matter is that I have yet to come across a program that I cannot backup on to the same format – tape or disc. For example, Strike Force Harrier and The Music System which have been designed so that they cannot be copied are dead easy.

Mr H.P. Boyle,
Uxbridge,
Middlesex.

ACU: Just because you are clever enough to copy most of the discs around is no reason for software houses to give everyone a leg-up in pirating their products. I doubt that you can copy all the discs about – have you tried Tomahawk or Working Backwards?

Most new titles are available on disc either direct or through the Ambyte scheme. The Mirage Imager will transfer most things from tape to disc if you really want a particular program which is only available on tape. A program which backs itself up on to disc is a licence to print money – playground piracy is a huge problem and everything that software houses can do to eliminate it should be applauded.

Rabbit, rabbit

I have spent many busy hours typing Splatch in from your November and December issues and although I am a professional programmer I am not very good at playing computer games.

I find Splatch quite addictive although I have only recently reached screen E. I cannot get past this because on my version there are only 15 carrots on the screen whereas the total given on the top right is 16. When I have eaten all the carrots the program is still expecting me to find one more.

Linda Johnson,
Lanark.

ACU: You need to drop an acorn on to a squirrel – this will turn into nine more carrots.

SPEEDYSOFT

024 026 3703 (24 HRS)

ALL ORDERS NORMALLY DESPATCHED
THE SAME DAY WE RECEIVE THEM

SEND £1 (refunded with first order) for 48-PAGE ILLUSTRATED
CATALOGUE.

BATMAN NEW!

"AN ALL-TIME CLASSIC." (C&VG)
"Colourful, fun-packed arcade adventure ... destined to become an all-time classic."
(Computer & Video Games 05/86)
464/664/6128. (Ocean) Cassette £8.95 Disc £14.95

FOUR ADVENTURES

"EXCEEDINGLY GOOD VALUE FOR MONEY." (Crash! 04/86)
RING OF DARKNESS by Wintersoft. THE CASE OF THE OBSCENE MURAL by Nic Ford. THE MICROMAN by T. Kemp. GALAXIAS by Fergus McNeil.
464/664/6128. (Global) Cassette £7.95

ALIEN HIGHWAY NEW!

"THIS GAME IS EXCELLENT." (Amix 06/86)
"The graphics are verging on perfection and the game itself is no pushover ... very addictive, almost like an adventure when you get further into the game ... I thought it was marvellous." (Amix 06/86)
464/664/6128 (Vortex) Cassette £8.95 Disc £13.95

COMMANDO NEW!

"Provides the same kind of excitement I felt when I first played Elite ... I shall go back to it time and time again." (Micro User 06/86)
464/664/6128. (Elite) Cassette £8.95 Disc £14.95

"STUNNING SPEED, FANTASTIC SERVICE."
(H. CHIN HO SAN, MALAYSIA)

EQUINOX NEW!

"HOURS OF MANIC ACTION." (Your Computer 06/86)
"The unusual combination of arcade adventure and shoot-em-up had this reviewer hooked from the start ... if you've got an Amstrad and you haven't got a copy of this, you must be stark, raving mad." (Computer & Video Games 06/86)
464/664/6128 (Mikro-Gen) Cassette £9.95

GET DEXTER! NEW!

THE FRENCH NUMBER ONE GAME.
"Superbly detailed and colourful graphics ... there are many crafty puzzles to get your teeth into ... an excellent game which I can heartily recommend." (Computing with Amstrad 06/85)
464/664/6128 (PSS) Cassette £9.95 Disc £14.95

STRIKE FORCE HARRIER

GREAT FLIGHT/BATTLE SIMULATOR.
"The graphics are excellent ... the flying simulation will test your skills and the combat and mission will give you plenty to keep working at." (Amstrad Action 04/86)
464/664/6128. (Microsoft/Amsoft) Cassette £9.95 Disc £14.95

HEAVY ON THE MAGICK NEW!

THE DEFINITIVE ADVENTURE.
"Gargoyle has yet again done everything right. The graphics are, as usual, superb and evocative ... I found plenty to do, with examinable objects galore." (Popular Computing Weekly 05/86)
464/664/6128. (Gargoyle) Cassette £9.95

"YOUR NEW CATALOGUE IS BRILLIANT!"
(C. GRIMSHEI, NORWAY)

MOON CRESTA NEW!

WIN A "MOON CRESTA" ARCADE MACHINE!
"Hand/eye co-ordination is all, with a quick trigger finger being the difference between success and oblivion ... one of the classic coin-up games of all time." (Computer Gamer 06/86)
464/664/6128. (Incentive) Cassette £7.95 Disc £12.95

THE STICK NEW!

"With about half an hour's practice, you will be able to beat all your high scores, due to the extra fast response. The Stick excels in the sports games." (Compunet)
464/664/6128. (Lightwave) The best joystick ever: £13.00

TAU-CETI

"If Tau-Ceti is an excellent game, then the special edition is an incredible game. No Amstrad disc owner should be without it." (Computer Gamer 06/86)
464/664/6218. (CRL) Cassette £9.95 Enhanced Disc version £14.95

HOW TO ORDER

UK prices include VAT. Export prices are the same, because of the extra work involved. Remember to add postage & packing: UK £1 per order; Europe £1.50 per program; Outside Europe £2.00 per program. Satisfied customers in 64 countries. To order quote reference 'AMU17'.
BY PHONE: Call 024 026 3703, 24 hrs a day. Leave your name, address, phone number, order, computer type, credit card number, expiry date.
BY POST: Send your order to SPEEDYSOFT, The Blacksmiths, Radnage Common, Bucks HP14 4DH, England. Make sterling cheque/PO payable to Speedysoft. Don't forget to add p.p.

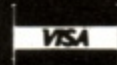

VISA
ACCESS
EUROCARD
MASTERCARD



AMSTRAD MAIL ORDER SPECIALIST

AMSTRAD HARDWARE	BUSINESS SOFTWARE
AMSTRAD 464 with colour monitor £299.00 Plus £100 of software free	AMSOF Supercalc II £43.95 AMSOF Cashbook Accounts £29.95 AMSOF Micropen (464) £43.95 AMSOF Microscript (464) £43.95 AMSOF Nominal Ledger System £29.95 AMSOF Purchase Ledger System £29.95 AMSOF Devpac £26.35 AMSOF Micro File/Micro Word £43.95 CAXTON Brain Storm £43.95 CAXTON Cardbox £87.95 CAXTON Cardbox Plus £171.60 CAXTON Touch 'n' Go £21.99 CAXTON Scratch Pad Plus £61.50 CAXTON Smartkey £43.95 CAXTON Condor 1 £87.95 HISOFT 'C' Compiler £39.95 HISOFT Write Hand Man £29.95 HISOFT Pascal 80 £39.95 HISOFT Font 64 £12.95 HISOFT The Knife £12.95 HISOFT The Torch £12.95 HISOFT Catalog £14.95 TASMAN Tasword £21.95 TASMAN Tasprint £11.35 TASMAN Tas_Spell £14.50 TASMAN Tas_Copy £11.35 TASMAN Tas_Copy (cass) £8.71 GEMINI Office Mate (cass) £13.20 GEMINI Office Master (cass) £22.00 GEMINI Data Gem £22.95 DIGITAL RESEARCH Draw £43.95 DIGITAL RESEARCH Graph £43.95 DIGITAL RESEARCH Pascal/MT+ £43.95 DIGITAL RESEARCH C-Basic Compiler £43.95 SAGESOFT Invoicing £61.50 SAGESOFT Retrieve (database) £61.50 SAGESOFT Payroll £61.50 SAGESOFT Magic Filer £61.50 SAGESOFT Popular Accounts £87.95 SAGESOFT Popular Accounts Plus £131.95 SAGESOFT Accounts & Payroll combo pack £131.95 MICRO-PRO Pocket Wordstar £43.95 FLEXIFILE £43.95 DATABASE SOFTWARE Mini Office (cass) £5.23 DATABASE SOFTWARE Mini Office II (cass) £13.15 DATABASE SOFTWARE Mini Office £17.55 MULTIPLAN £61.50 COMMSOFT Delta £87.95 NEW WORD £61.50 RATIONAL SOLUTIONS AtLast £43.95 ASHTON TATE dBase II £104.75 THE CRACKER I £43.95 MASTER PLANNER £61.50 PLANNER CALC £34.32 HISOFT Devpack 80 £39.95 ARNOR Protex Word Processor 6128 (rom) £43.95 ARNOR Protex Word Processor 6128 £26.35
AMSTRAD 464 with green monitor £199.00 Plus £100 of software free	
AMSTRAD 6128 with colour monitor £399.00	
AMSTRAD 6128 with green monitor £299.00	
AMSTRAD 8256 Word Processor system £458.00	
AMSTRAD 8512 Word Processor system £573.00	
AMSTRAD 6128 RS232-Centronics I/face £49.95	
AMSTRAD 8256 RS232-Centronics I/face £67.85	
AMSTRAD PL-1 Light Pen £19.95	
AMSTRAD FD-1 2nd Disc Drive £99.95	
AMSTRAD DD-1 Disc Drive + Interface £159.95	
AMSTRAD FD-2 2nd Disc Drive for 8256 £169.95	
AMSTRAD MP-2 Modulator-Power Supply £29.95	
AMSTRAD SA-1 Speech Synthesiser and stereo amplifier with speakers £29.95	
DOT MATRIX PRINTERS	
DMP 2000 (Tractor-Friction feed - NLQ 20cps - Draft 100cps, 2k Buffer - Centronics) £159.95	
STAR NL-10 (Tractor-Friction feed - NLQ 30cps - Draft 120cps 5k Buffer - RS232c/Centronics - Reverse feed) £269.00	
JUKI 5510 (Tractor-Friction feed - NLQ 30cps - Draft 180cps 2k Buffer - RS232c/Centronics - Reverse feed) £239.00	
JUKI 5520 4 COLOUR PRINTER (Tractor-Friction feed - NLQ 30cps - Draft 180cps 7k Buffer - RS232c/Centronics - Reverse feed) £395.00	
PANASONIC KX-P1080U (Tractor-Friction feed - NLQ 20cps - Draft 100cps 1k Buffer - Centronics) £179.95	
CANON 1080 (Tractor-Friction feed - NLQ 30cps - Draft 180cps 2k Buffer - Centronics/RS232c - Reverse feed) £269.00	
DAISYWHEEL PRINTERS	
JUKI 6100 (LD 20cps - 2k Buffer - Pitch PS, 10, 12, 15 p. inch Centronics/Optional RS232c/Tractor Feed) £295.00	
JUKI 6200 (LD 30cps - 3k Buffer - Pitch PS, 10, 12, 15 p. inch Centronics/Optional RS232c/Tractor Feed) £499.00	
PRINTER RIBBONS	
AMSTRAD DMP-1 £7.50	
AMSTRAD DMP-2 £5.95	
AMSTRAD PCW 8256/8512 £4.95	
TAXAN KAGA/CANON £7.50	
EPSON LX-80/FX-80/RX-80/MX-80/MP-185 £6.75	
JUKI 5510, 6100 £4.95	
PRINTER PAPER	
2000 11" x 241mm (80gm) White Fan-Fold £16.50	
1000 Self Adhesive Address Labels Single sheet fan-fold 89mm x 36mm £6.95	
2000 Self Adhesive Address Labels Twin sheet fan-fold 89mm x 36mm £9.95	
COMMUNICATIONS	
SAGESOFT Chit-Chat Modem with optional: E-Mail or View Data £199.99	
SAGESOFT Chit-Chat combo pack Modem with E-Mail and View Data £230.00	
SAGESOFT Chit-Chat Optional E-Mail £61.50	
SAGESOFT Chit-Chat Optional View Data £61.50	
COMMTEL-X RSC Communications scoop	
1. PRISM MODEM 2000	
2. RS232/Centronics Interface	
3. Low cost worldwide telex utilizing Electronic Mail	
4. Full screen off-line text preparation and editing	
5. Simple to use On-line/Off-Line menus	
6. Automatic time and date Recording on incoming/outgoing messages	
7. Supports Prestel and other viewdata services	
8. Telephone 'Hot-Line' Backup	
RSC Super Special offer all for £230.00	
AMSTRAD's IBM PC Model #1. 128k Ram single 5 1/4" disc drive Mono monitor £399.00 + VAT Model #2. 256k Ram twin 5 1/4" disc drive Colour monitor £499.00 + VAT	
GRAFPAD II Replaces Mouse, Joystick, Touchpad Trackerball, Lightpen, Keyboard Accuracy -1, +1 pixel Repeatability -1, +1 pixel RSC Super snap £59.95	
MEMORY UPGRADE Make your PCW8256 into a 512k As Easy as ABC RSC Super Scoop only at a mere £37.50	
3" DISCS in 10's CF-2 Double sided-single density £39.95 CF-2DD Double sided-double density £59.00 (for the PCW second drive)	
DISC BOXES DD-40L 3" - 3 1/4" Disc Box with lock £14.95 RSC-40L 3" Disc Box with lock £17.50	
EXTENSION LEADS RSC-CPC 53 Centronics Printer lead £9.50 RSC-CPC 44 Power Extension Lead £4.95 RSC-CPC 43 Monitor Extension Lead £4.95 RSC-CPC 55 CPC to Disc Drive Lead £7.95 RSC-PCW 03 Power Extension Lead £4.95 RSC-PCW 04 Printer Extension Lead £12.50 RSC-INT 99 Centronics to Centronics £12.50	
GRAPHICS AMX Mouse £69.95 DKTronics Graphic Light Pen £19.95	
COPY HOLDER Desk resting and shelf clamping versions these two units hold your paper by magnetic ruler & clip Desk £19.95 Shelf £12.95	
ALL PRICES INCLUDE VAT + POSTAGE ALL ENQUIRIES & PAYMENTS MADE TO:	
RSC Ltd 75 Queens Road, Watford WD1 2QN. Tel: (0923) 43301 Telex: 265871 MONREF G Ref: CJJ128	
All prices subject to change without notice. All products are offered subject to availability.	

OPUS WILL MAKE YOU A BETTER ORGANISER FOR ONLY £60

If your micro system is starting to get out of hand a smart organiser could be the solution to your problems.

At just £59.95 the Organiser desk from Opus Supplies will help to organise your system beautifully. It's purpose built to provide plenty of storage space and because it's produced alongside our range of executive computer desking it offers a level of quality you'll appreciate.

Shelving accommodates your monitor, printer, computer, disc drive or cassette recorder and software, and the teak-finished unit is fitted with castors to make it fully mobile. The Organiser's assembled dimensions are: H. 31", W. 40¼" and D. 26".

And our price includes VAT and FREE DELIVERY.

The Organiser desk is suitable for use with all leading home micros including the BBC, Amstrad, Commodore and Sinclair computers.

Getting organised couldn't be easier. Phone us on 0737 65080 or simply post the coupon below.



To: Opus Supplies Ltd,
55 Ormside Way, Holmethorpe Industrial Estate, Redhill, Surrey.

Please rush me the following:
(PRICES INCLUDE VAT AND CARRIAGE)

_____ Organiser Desk(s) at £59.95 each (inc. VAT)

I enclose a cheque for £_____ or please debit my
credit card account with the amount of £_____

My Access Barclaycard (please tick) no. is: _____

Name _____

Address _____

Telephone _____

ACU8/86

Opus.
Opus Supplies Ltd.

The
MASTER Disk
Distributor

3" MICRODISKS

**10 Amsoft 3" CF2
Microdisks**

Suitable for **all** Amstrad
Disk Drives

Only
£34.95
Inc. VAT

Officially Appointed Distributor
For AMSOFT 3"CF2 Microdisks



**1 MEGABYTE
DISKS**

**10 Amsoft
3" CF2-DD
1 MEGABYTE
Microdisks**

Suitable for your PCW 8256
Second Drive or PCW 8512

Only
£59.95
Inc. VAT

Officially Appointed Distributor
For AMSOFT 3"CF2 Microdisks

**»NEW«
FIVE PACKS**

**5 Amsoft CF2
Microdisks
Only £19.95**

**5 Amsoft CF2-DD
Microdisks
Only £34.95**

...FREE 48HR Delivery in the UK...Same Day Despatch.

Hotline
0602 413258



SJB DISKS LTD [Dept]

City House · Maid Marion Way · Nottingham · NG1 6BH
Tel: 0602 413258 · Fax: 0602 413820 · Telex: 377844 ABCPLC Ref: SJB





PROTEXT

FOR AMSTRAD
464/664, 6128

THE ULTIMATE AMSTRAD WORD PROCESSOR!! SPELLING CHECKER AND MAIL-MERGE NOW AVAILABLE

PROTEXT is without doubt the most sophisticated word processor you will find on any home micro. It is of comparable standard to business packages costing over £200 but has been developed for the AMSTRAD 464/664 and 6182 machines and is 100% machine-code. We know that PROTEXT is the fastest program of its type currently available (eg. global search and replace on a three page file in under a second!). Bearing in mind the range of features included and their ease of use, this package is rightly acclaimed as the No. 1 word processor for Amstrad owners. Compare these features and benchmarks with any other similar products.

PROTEXT FEATURE SUMMARY

- File commands** — Super fast Load, Merge and Save, Cat, Print (to printer/screen/file)
- Cursor Movement** — By character/word/line/paragraph/screen, to start or end of line, to start or end of text, to line number, to place marker, to margin.
- Inserting and deleting** — Insert/overwrite mode, insert character or line, delete character forwards or backwards, delete word. Delete to end of line.
- FIND and REPLACE** — Wildcards, all or part of text, case specific, whole word or part of word, find control codes.
- Block commands** — Move/copy/delete/save/print/format.
- Markers** — 2 block markers and 10 place markers may be set anywhere.
- Formatting** — Word wrap, right justify, variable left and right margins.
- Ruler lines** — Unlimited number of ruler lines to define margins and tabs. Decimal tabs.
- Print options** — Headers/footers, page numbers, variable line spacing, variable page length and margin sizes, conditional page throws, odd and even page features, continuous or single sheets, multiple copies.
- Printer features** — Including emphasized, condensed, double-strike, elite, italics, enlarged, pica, NLQ, subscript, superscript, underline. Built in Epson printer driver, ability to easily define your own printer driver and save to disc.
- Help feature** — Optional on screen command summaries.
- Built in character sets** — Danish/French/German/Italian/Spanish/Swedish.
- Other features** — Non break space, display tabs, returns and hard spaces, soft hyphens, word count, case conversion, copy ruler, 60 page easy to read manual with full index and glossary of terms.

"I AM STUNNED AT PROTEXT—IT KNOCKS POCKET WORDSTAR INTO A COCKED HAT" — AMTIX ISSUE 1 "DON'T MISS IT. IT IS SUPERB"
— POPULAR COMPUTING WEEKLY "MILES AHEAD OF THE AMSWORD TYPE PROGRAMS" — AMSTRAD USER

BENCHTESTS

A standard file of 775 words (4,785 characters) was used to carry out the following benchtests (all timings are in seconds):

	PROTEXT	TASWORD/AMSWORD
1 LOAD text file	4.7	10.2
2 SAVE text file	4.9	18.9
3 Re-FORMAT paragraph (85 words)	0.4	15.3
4 Re-FORMAT entire text	2.5	Not Possible
5 Move directly to start of text	under 0.1	2.2
6 Move directly to end of text	0.2	2.2
7 REPLACE 'the' with 'THE' (45 occurrences)	1.7	34.1
8 SCAN entire text	2.2	7.2
9 MERGE file to centre of text	4.0	Not Possible
10 MERGE file to end of text	3.8	12.4
11 MOVE 85-word paragraph	under 0.1	6.8
12 PROGRAM LOAD TIME		
DISC	12.9	14.6
ROM	Instant	Not Available

PROMERGE/PROMERGE PLUS

This major addition to the PROTEXT word processor combines a fully flexible mail merge program allowing PROTEXT to produce individualised documents in one single print run.

PROMERGE — COMPREHENSIVE MAIL MERGE

- Read data from file or keyboard.
- Merged files of varying lengths are automatically reformatted.
- File merge — insert file while printing.
- Conditional printing — select from input data (eg. you could print letters to all customers whose name is not Smith).
- Print file direct from disc or memory.
- Auto configuration — you can set up a disc to configure PROTEXT to your preferred options with a single keystroke.
- Typewriter mode — for envelopes etc.

PROMERGE PLUS — PROTEXT ENHANCEMENTS (ROM version only)

- All the features of PROMERGE together with —
- Background printing — edit one file while you print another.
- Two file editing — switch between two files in memory.
- Cut and paste — any block of text can be moved to any position — allows multiple column layout.
- Tasword users — automatically converts your old text files.
- Calculator — a simple on screen calculator for those invoice totals etc.
- *6128 OWNERS***
- PROMERGE PLUS MAKES full and sensible use of your extra 64K memory but also functions with smaller files on the 464 and 644 machines.
- Also uses D K Tronics 64K RAM expansions.

PRICES

	DISC	ROM
PROTEXT	26.95	39.95
PROMERGE	24.95	—
PROMERGE PLUS	—	34.95
PROSPELL	24.95	34.95

(ALL INCL. VAT, P & P)

PROSPELL

- ★ Checks your spelling ★ Proof reads your documents ★
- ★ Solves your word puzzles ★

— How to use PROSPELL —

The spelling checker can be called directly from within PROTEXT to check the current file in memory or any file on disc. Alternatively, PROSPELL will check any ASCII file produced by other Amstrad word processors, including Wordstar type files.

— Features available —

Add words to the dictionary/Correct word/ignore word/Look up correct spelling/View word in context/Delete words/List words/Initialise new dictionary...PLUS...

— Word Puzzle Features —

The 30,000 word Dictionary can be used in a number of useful ways.

FIND WORD — You can enter a word pattern using ? for an unknown letter and * for a group of unknown letters. PROSPELL will list all words in the dictionary which match this pattern.

ANAGRAMS — PROSPELL will even list all anagrams of any word pattern you type in.

Together these features will prove invaluable to crossword solvers and compilers.

— THE POWER OF PROSPELL —

Some spelling checkers work as slowly as 150 words per minute. PROSPELL works at up to 2000 w.p.m.

Some spelling checkers limit your dictionary size. PROSPELL will work with an unlimited number of dictionaries, each of which can hold around 45,000 words.

N.B. All ROM software requires a ROM expansion system. We recommend and supply the new SUPERPOWER 8-WAY ROM BOX at £34.95 (Incl. VAT, P & P).

PROSPELL requires at least one disc drive.

Available from selected branches of



WHSMITH

and all good computer stockists, or directly

FROM: **ARNOR LTD**
118 WHITEHORSE ROAD
CROYDON
CRO 2JF
01-684 8009

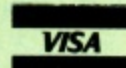



SEEK AND YE SHALL FIND...

Into adventures with Bill Brock

Long ago – well last year anyway – Level Nine produced a program which added the use of spells to the usual adventuring requirements, Red Moon was an outstanding success. Later in 1985 the same group gave us The Worm in Paradise, a science fiction adventure that had a quite remarkable vocabulary of more than a thousand words and which recognised input commands such as Up, Examine all but the helmet and go East.

Their latest marvel, The Price of Magik, is set in the same magical world as Red Moon and has the extended operating system of The Worm. All three additionally feature multitasking which allows you to type in commands while the pictures are being drawn. This may not sound very important but if you are repeating a series of moves it saves time and helps maintain a feeling of continuity.

Each Amstrad cassette has three versions of the game – text and graphics, extended text and graphics or extended text but no graphics. Only the first and last of these options are available to machines with 64k of memory. CPC6128s and 464s with additional memory may choose any version.

All have the same number of locations and the same puzzles but machines with larger memories have two additional commands at their disposal – RAM SAVE and OOPS. RAM SAVE enables the player to rapidly save and subsequently restore the game position to or from a section of the computer's memory. This is a particularly useful feature as its regular use can ensure a known base to return to if you get lost or meet something you would rather not.

Although RAM SAVE – or QUICKSAVE – has appeared in some other game, OOPS would seem to be a Level Nine first. (Infocom has a different type of OOPS – Ed). It simply undoes your last command and returns you to your last location – very useful if you are attacked by a werewolf or punctured by an exploding chest! Regular 64k Amstrad owners will have to use the tape save and restore commands as usual.

This is the first adventure game to be protected against piracy by using the Lenslok system. A plastic prismatic lens is supplied with each game that converts a load of rubbish on the screen into a readable two letter code. The code is entered, and if correct, the program continues. If not then you have to try again until you get it right.

The characters seem to be fairly easy to identify but look after that plastic lens – it will cost quite a bit to replace it. Just take care, read the instructions, get the lens the right way up and all should be well.

Enough of the mechanics, let's look at the game itself. The action takes place in and around The House of the Red Moon, with the object of the game being to find and defeat the sorcerer Myglar. For years he has been the

guardian of the source of magical power – the red moon crystal of Baskalos.

As time passed he has become more aware of his own mortality and has perverted the crystal's power to his own ends. If he continues, there will be no magic left in the world. You must stop him.

There are plenty of places to explore and interesting things to find and use. None of these are treasures in the normal sense but they will help you learn how to use the 18 spells necessary to reach and destroy Myglar.

Learning to use each spell requires knowledge of both the name of the spell – BOM, FLY, ZAP and so on, and an object that will enable you to focus your power on



The Price of Magik: Level Nine's best yet

performing that particular magic. Clues found along the way will supply the names and CAST XXX will tell you if it has worked, or if not, what else is needed.

No score is given, but type in SCORE and you will get a report on your present sanity and apparent age. Get too old and you are done for! Your stamina is also important, as there are several unpleasant creatures you may meet who will not let you past without a fight.

A weapon and some form of armour are useful finds before you get too involved. Death in this place, so full of the powers of magic, will release an avenging ghost, so it is wise not to be too bloodthirsty unless absolutely necessary. It is also possible to control some of these creatures, but that spell may not be so easy to find.

This adventure is surely Level Nine's best yet. Graphics are drawn quickly and the text is up to the usual high standard. Finding spells and making them work is a clever variation on treasure seeking and the usual game puzzles. There are plenty of clues – if you know where to look – and Level Nine's own brand of humour is never far away.

If you have any problems, remember that the group

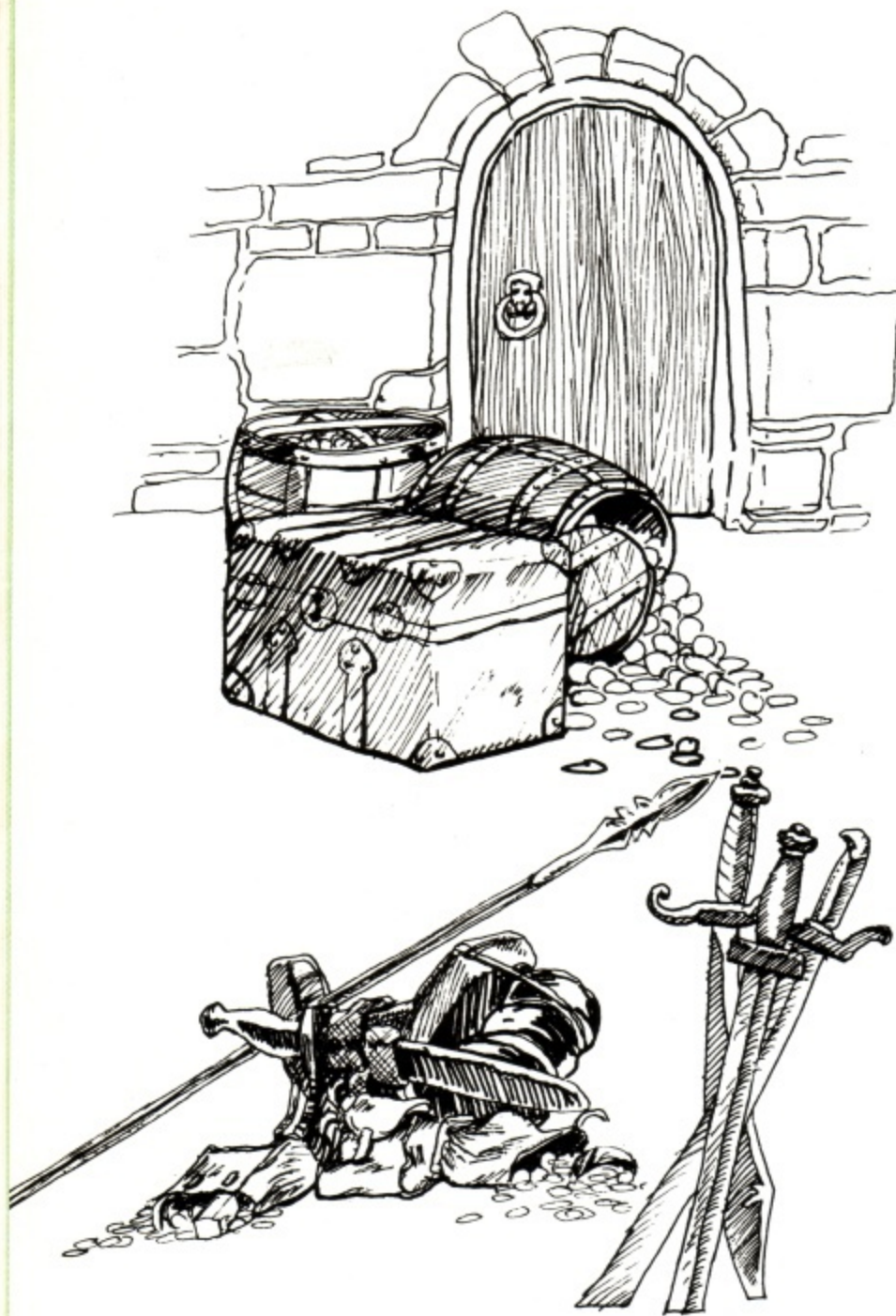

provides those marvellous clue sheets on receipt of a stamped addressed envelope and the hint request that comes with every game.

A highly recommended game for expert or beginner – colourful, inventive and full of interest. One can only hope that Level Nine can sustain such quality in the future.

No high flyer

Melbourne House has quite a reputation for adventures, starting with *The Hobbit* which broke so much new ground that the adventure game field has never been quite the same since. Its latest release is *Redhawk*, a graphical adventure with a difference. The graphics are in the form of a comic strip, which is quite relevant as the game is all about a comic type superhero – Redhawk.

Text entry directs Kevin Oliver – Redhawk's alter ego – out from the hospital, where he finds himself at the start of the game. Around the town he searches for a job as a crime photographer and then on into whatever adventures you like to give him.

He has lost his memory and you have the choice of



Redhawk: Disappointing comic strip adventure

making him act as either a superhero or supervillain. Redhawk's popularity rating is shown graphically, giving you something to aim for. This rating also affects how other characters will interact. To solve the strange goings on it seems best to aim for the hero rather the villain.

Type in SAY – or SHOUT – “KWAH”, not forgetting the quotes, and Kevin will change into the formidable Redhawk, able to fly and generally do most things superheroes are claimed to do in their sleep with one hand tied behind their back. The only snag is that in Redhawk's form, his energy output is high and his reservoirs of power fairly low. So a return to being plain Kevin is very necessary after a short interval.

The location descriptions are almost non-existent as they are all included in the comic strip shown at the top of the screen. This consists of three panels or frames that scroll across the screen from right to left as each command is actioned. You would think that this would show the present and two previous scenes but this is not the case.

Each command entered, if understood, is repeated by the Kevin in the strip and only then is that command actioned – two frames for one command. This would not be so bad if the frames were drawn quickly but they are not. It is quite painful if all you want to do is go from location A to location B but it is even worse to have to wait for the frame to be drawn to be told that Kevin looks for a way north but can't find one.

The game is played in real time and there is a digital clock ticking away the seconds as you wonder what to do next. Quite rightly the clock is stopped if Kevin does not understand what you are trying to get him to do. Unfortunately this seems to happen all too often – his understanding of normal adventure talk is sadly lacking.

His inability to understand the command “Open door” brought up the response that “open” confuses Kevin. Another departure from normal practice is the use of the word Examine. Here it literally means a body search – it is not surprising that a young lady, met early on in the game, objected quite strongly when I told Kevin to examine her!

Fairly complex sentences are understood and the game also has STORE, a version of rapid saving of the

game position to the computer's memory. Normal tape save or load to cassette is used for a more permanent record.

A disappointing game and boringly slow when you consider that you are waiting for minimal text and very mediocre graphics. The game puzzles are not bad but the lack of any real atmosphere destroys what could have been a really innovative production.

Lost . . . frustrated?

I have had quite a few letters from readers with something in common . . . help. Now we all have problems solving adventure games and the pleasure obtained in playing them would soon be lost if they were all easy to solve. This present spate of "help me" letters comes, not from regular adventurers who know the ropes, accept all the challenges inherent in starting a new game and who are stuck for a vital clue, but from beginners to the field altogether.

Often they are new to the Amstrad itself and several say they have become so frustrated that the computer has been returned to its box and put away in a drawer. (*A big drawer if they are packing the monitor away - Ed*). Local help lines have been tried and local computer clubs contacted, even the software houses themselves have not been able to materially assist these poor souls.

The questions vary of course from game to game but two things seem to be common. First is the operating system - not the game's but the player's! Second, the question of which games I would recommend for the beginner.

Those of us who have had some success in solving adventure games tend to forget what it was like the first time we were lost in a strange land with nothing but our wits to help us get out. Although we covered this subject only a few months ago, perhaps a brief recap will help those who are planning to write.

1. Draw maps of where you go. Most games have their locations laid out on a grid pattern. A series of boxes drawn on a sheet of paper with a very brief description of the location and what you find there will serve. A series of lines joining the boxes will indicate which location is to the North, East, West, South West and so on of each location.

2. Keep a separate note of all objects you find scattered around. Most games are logical, even if that logic seems strange at times. A list of objects may help you spot a link between one of them and a puzzle you are trying to solve.

3. Examine everything you can see - many useful objects will most likely be hidden in or behind something else. On the same lines, try moving statues, logs and the like.

4. save your game position fairly often. There is nothing more frustrating than having to repeat lots of moves because your character got killed by doing the wrong thing.

5. If you find yourself in a maze of locations all with the same description - stop and load your last saved position. Then enter the maze carrying all the objects you can. Drop something at each new location so that you can identify where you are when you return to that

same place. Map mazes carefully on a separate sheet of paper.

6. Now you have an operating system for yourself, learn to understand the game. If you come across: "You are to the West of a hut in the forest", do you get inside by typing In, Enter hut, Open door, Go hut or just East? Each game has its own idiosyncrasies - learn what they are and use them to your advantage.

This brings us to the second point - which adventures give the novice the best possible start? Ideally you do not want to spend too much time trying to make the computer understand what you want to do. So look for a game that has a good vocabulary and that will accept commands in much the way you would speak them.

Some games have a clearly defined plot that means you have to solve one part before you can tackle the next. Mindshadow from Activision is such a game. It is not that easy, but everything you find has a purpose and the uses of most of the items found are reasonably logical. Mindshadow also has a training program that will help explain the general rules of adventure games.

Other very good starters would be the latest Level Nine games, Red Moon and The Price of Magik. These adventures are fun and have a good dose of humour, but they can be quite devious. They are good for beginners on several counts, the most significant being the excellent hint sheets available for the cost of a single stamped addressed envelope.

These sheets contain many hundreds of numbered clues, some of which are total red-herrings! They are split up into objects, places and answers. Look up an object and you will be directed to at least two further numbered answers. These are written in no special order, so it is not difficult to only read what you want to know and not something that will spoil any future game play.

Having these hints to fall back on serves two purposes. You do not become totally frustrated by being unable to solve a puzzle and more importantly, you learn how adventure game puzzles are built up. Next time you may not need a crib sheet.

Offers of help

If you have solved any adventures and are willing and able to tell others how to get past the tricky bits, please let me know. We can either publish your name address and telephone number, together with the games you have solved, or pass them on to those in desperate need.

One such offer has come from Pat Winstanley, who has completed Red Moon, Worm in Paradise, Snowball, Subsink, Gremlins, The Hobbit, all Nemesis and all Interceptor (except Warlord).

Pat's address is 18 Hollington Way, Wigan WN3 6LS. If you write for help, please send a stamped addressed envelope. She is also interested in writing adventure games using GAC and would be very interested in others doing the same - why don't you send one for me to review?



pride utilities



UNIT 14, WHITE HILL HOUSE, 6 UNION STREET, LUTON, BEDS LU1 3AN
THE UTILITY PEOPLE TEL (0582) 411686

FOR YOUR AMSTRAD 464-664-6128

TRANSMAT

£7.95 £11.95
CASS DISC

Easy tape to disc transfer. This professionally used and respected utility has set the standard in tape to disc transfer that others attempt to mimick. Rated highly by the computer press.

Transmat's many features include • Easy operation • Auto or non auto modes • Relocator for programs which overwrite the disc area • Erase • Catalog files • Rename • Disc header reader • Select user area • A or B drive working • Transmats itself.

Also available on ROM only £19.95.

GOLDMARK SYSTEMS (TIE)

The full TRANSMAT support service. Offers • transfer solution books (over 100 solutions) • monthly fact sheets • tape to disc transfer service • a genuine HELP line. For further information write to: GOLDMARK SYSTEMS (TIE), DEPT AU, 51 COMET RD, HATFIELD, HERTS, AL10 0SY or Tel 07072 71529 weekdays 1800-2100 & Saturdays 1500-2100.

£6.95 £10.95
CASS DISC

SYS X

An RSX program offering more than 30 Basic commands for your Amstrad. An ideal programming aid.

£17.50

8 BIT PRINTER PORT **NEW!**

A full 8 bit Printer Port obtained with this adaptor. This simply connects between the standard port and the printer lead, no other connections necessary. Will enable the user to have full graphics possibilities, definable character sets, etc.

£12.95 £19.95
DISC ROM

NOW ON ROM ODDJOB

STILL THE BEST DISC UTILITY PACKAGE.

A complete disc utility with all the programs YOU have told us you wanted all together in one amazing package. A total of 39k of disc space used.

Just look at some of the features:

- A complete directory editor with which you can examine the disc directory and easily alter the contents.
- Recover erased programs.
- Hide programs from the directory.
- A complete sector editor to examine and/or alter the contents of files in HEX or ASCII.
- Map out your disc and locate where files are on the disc.
- Prevent programs from accidentally being erased.
- An intelligent disc copier that can copy those damaged/non-standard sectors on a single or twin-drive system.
- Format in half the time on either drive. Ideal for 5.25 inch second drives.
- Transfer your little used programs/files from disc onto tape to reclaim expensive disc space.
- Increase the speed of your disc drive by up to 20%.
- Load and list protected BASIC programs.
- All instructions are supplied on disc on a separate help menu.
- Simple to use with single-key selection.
- Makes full use of the disc drive. A to A, A to B, B to A, etc.
- Compatible with all AMSTRAD CPC computers.

All this for the incredible price of £12.95 on disc only ODDJOB is constantly upgraded—check with us the current version No. and if you wish, return the disc with £2 for upgrade. NOW A ROM VERSION ODDJOB AVAILABLE – £19.95.

FIDO

NEW!

£11.95
DISC

A general file and disc organiser. If you can never find the program you want, then FIDO is your answer. Its many featur will allow you to completely organise all your files/discs and manipulate them using a specially designed database. This menu-driven disc can store up to 200 discs or 2,150 progrms. Full disc utility section • security password system (to protect your database) • Separate programs runner • Will search and list • Sort into alphabetical order • Printer option • Finds free space • Very Simple to use • Well up to Pride's usual high standards.

TOMCAT & RSX SYCLONE 2

Special offer
£7.00 CASS

A double cassette pack for 464 owners comprising TOMCAT the ultimate tape-to-tape back up program which even handles headerless programs usually in one go, and RSX SYCLONE 2 a tape-to-tape utility allowing you to • load and list protected BASIC programs • choice of seven saving speeds • comprehensive header reader.

SPIRIT

£5.95
CASS

The perfect advanced software complement to Transmat for those knowledgeable in computing—Spirit offers all the tools you need in one economic package to transfer those genuine headerless programs onto disc.

To use Spirit you need a disassembler and some knowledge of machine code.

PRINTER PAC II

NEW!

£7.95 £11.95
CASS DISC

The screen copier. The complete printer utility for most popular dot matrix printers including the DMP2000 • full proportional shading • full size dumps • variable buffer option to release the computer • text dumps • all modes catered for.

SUPER SPRITE

NEW!

£7.95 £11.95
CASS DISC

Create fast moving animated games easily. An extremely powerful and versatile piece of software at a realistic price. SUPER SPRITE is a menu-driven friendly program which will offer you hours of enjoyment designing your own sprites. Included is a demo to show you the possibilities of designing and writing your own animated software. The complete instruction book gives examples of how to create and animate sprites for your own programming.

SPECIAL OFFER!

Buy 2 or more titles and receive free a real time digital alarm clock or ZEDIS, our editor/disassembler. Please state choice. Does not apply to double cassette pack offers.

SPECIAL END OF SERIES!!!

PRINTER PAC 1 & SCRIPTOR

£7.00
CASS

A double cassette pack for possessors of the DMP-1 Amstrad printer. SCRIPTOR offers • 6 definable character fonts • lower case descenders • futuristic • italics • joined writing • bold and heavy • contains DESCRIBE allowing you to define your own characters.

PRINTER PAC I allows screen dumps in all modes • text dumps • specify background inks • abbreviated codes to printer • 3 new type styles for DMP 1.

IF YOU'VE WRITTEN A UTILITY UP TO OUR HIGH STANDARDS PLEASE CONTACT US.

AU

ORDER FORM

All prices include VAT and P&P. For Europe add £1 per title. For Australasia add £1.75 per title. For rest of world add £1.50 per title. INC AIR MAIL CONTRE REMBOUSEMENT + £2.50 EUROCHEQUES accepted in Sterling

NAME _____

ADDRESS _____

	Cass	Disc	Rom	Port
TRANSMAT				
SYS X				
PRIDE PRINTER PORT				
SPIRIT				
TOMCAT & RSX SYCLONE 2				
FIDO				
PRINTER PAC II				
SUPER SPRITE				
PRINTER PAC 1 & SCRIPTOR				
ODDJOB				

AVAILABLE AT ALL GOOD COMPUTER SHOPS

When the press use such words as 'Phenomenal', 'Outstanding', 'Ideal' and 'Worth Every Penny', they've obviously discovered something rather special.

But when that something special turns out to be a product in which they are already expert, then it must be something very special indeed.

The object of their enthusiasm is AMX Pagemaker - a revolutionary software program that will produce newspapers, posters, leaflets, notices and hand-outs - in fact anything where text and graphics are required, to an extraordinary professional standard.

It's a complete graphics design system and word processor rolled into one. It has real time graphics with fast continuous scrolling up and down an A4 page and uses Mode 2, the highest graphics resolution on the Amstrad CPC computers.

READ ALL ABOUT IT.

You can type directly onto the screen, with any of the 16 typefaces supplied or design your own, alternatively, you can load in any ASCII file or a word processor file, from programs such as Tasword, Amword, Maxam, or Protext, with fully automatic on-screen text formatting during loading.

'Word processing' facilities such as centering, ragged right and literal justification are all available. There is full pixel resolution control over text and graphics. Also included is a micro spacing facility.

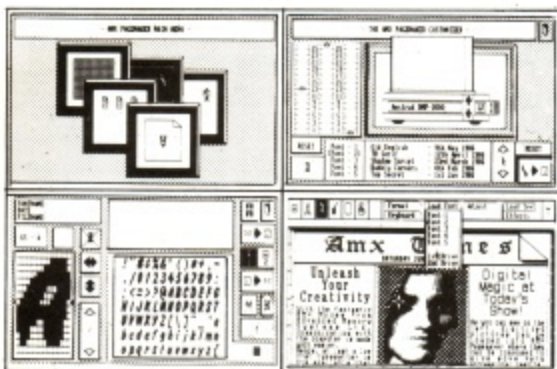

WORKS WITH
KEYBOARD JOYSTICK
OR MOUSE

The program that's making front page news.

EXTRA, EXTRA.

There are outstanding facilities for drawing, spraying and painting, using either the patterns supplied, or your own pattern designs. A screen conversion routine is included allowing screens created in Mode I and O to be used within the Pagemaker. The cut and paste facilities include copying, moving, rotating, stretching and a fantastic zoom is also available.

The previewer allows you to view three A4 pages at any time before work is output to a wide range of dot matrix printers including: Amstrad DMP 1000-2000, Epson FX/RX/LX/LQ, Canon PW-1080, Kaga KP810, Mannesman Tally MT-80+, Seikosha SP-1000A, Star Delta, Star SG10 and any that are compatible with the above.

The AMX Pagemaker requires: a) Amstrad CPC618 or b) Amstrad CPC664+64K Minimum add-on Ram or c) Amstrad CPC464+64K Minimum add-on Ram + disc drive, DK 'tronics Ram boards or compatible.

Let's leave the last word to the press.

"'Pagemaker' is phenomenal - it lends itself to creating anything where text and graphics are involved - notices, posters, leaflets, hand-outs, newsheets. Packages like this have been the province of the 16-bit micros until now, this product is worth every penny of £49.95."

AMX MAGAZINE MAKER - WE THOUGHT IT WAS ABOUT TIME WE PUT YOU IN THE PICTURE.

A combination of AMX Pagemaker and the AMX video digitiser. Using any video that provides a composite signal and the digitiser, images from a camera or TV can be converted into a graphic screen on the Amstrad Micro. They can then be used within AMX Pagemaker to illustrate magazines or newsletters. The digitiser connects into the expansion port and scans a complete picture in only 5 seconds.

A special print dump routine is also included with the driver programs. This is specially designed to produce fast, correctly proportioned pictures, with reduced 'Contouring' resulting in a very accurate reproduction of the image.

Features offered by this package include:

- Dot resolution 256 by 256
- Standard 1 volt composite video input
- 10 bit A/D convertor gives 32 grey scale output
- Low IC count
- Contrast and brightness control
- No external power unit required

These packages are your opportunity to join the desktop publishing revolution.

The AMX Pagemaker costs only £49.95, software is supplied on 3" disc and a fully illustrated

operating manual, AMX Digitiser only £89.95 including software on 3" disc, and AMX Magazine Maker (including AMX Pagemaker and AMX Digitiser) at any £129.95.

These superb packages are available from all good computer dealers or direct using the Freepost order form below.

*Educational Computing, January 1986.

PLEASE RUSH ME POST FREE THE FOLLOWING AMX PACKAGES

Quantity _____ AMX PAGEMAKER @ £49.95 each
 _____ AMX DIGITISER @ £89.95 each
 _____ AMX MAGAZINE MAKER @ £129.95 each

ALL INCLUSIVE OF VAT AND P&P
 I ENCLOSE CHEQUE/POSTAL ORDER FOR £ _____
 OR DEBIT MY ACCESS or VISA
 (tick as appropriate) CARD NO. _____

EXPIRY DATE _____

SIGNATURE _____

NAME _____

ADDRESS _____

POSTCODE _____

AMX PAGEMAKER

IMAGINATION AT YOUR FINGERTIPS

SEND TO: ADVANCED MEMORY SYSTEMS LTD.,

ACU 8/86 FREEPOST, WARRINGTON WA4 1BR.

☎ FOR INSTANT ACCESS OR VISA ORDERS RING 0925-413501/2/3

DUST COVERS

464/6128 Keyboard	£3.75p
Monitors	£4.50p
PCW 8256	£9.99p

LIBRARY CASES

£5.55p
p&p 50p

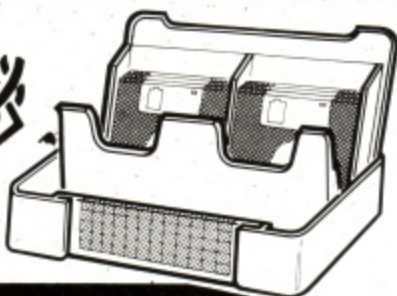

Holds 10 3" disc
without cases

JUMBO BOX
£17.00 ADD
HOLDS 40 £1.00

£13.25
ADD £1 P&P

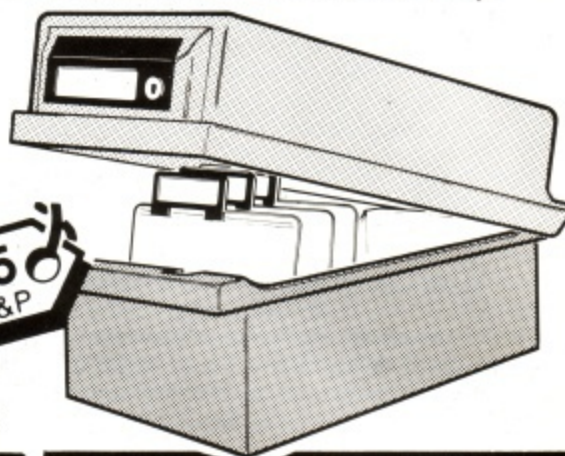

WORDPROCESSING

TASWORD D 464-664-6128

Wordprocessing program complete with full screen prompts and tutor. This program will allow you to produce letters forms etc fully compatible with all printers. Features include page numbering, search and find, search and replace, block copy, block move and mail merge. The tutor will give full training on the use of the above functions.

464 Cassette	£19.95p
464/664 Disc	£24.95p
6128 Disc	£24.95p

TASPRINT

The Tasword style writer allows you to print 5 extra fonts with dot matrix printers including COMPACTA bold and heavy for emphasis, DATA-RUN a futuristic script LECTRA LIGHT clean and pleasing to read Median a serious business like script, Palace Script a distinctive flowing font.

CASSETTE	£9.90p	DISC	£12.90p
----------------	--------	------------	---------

TAS SPELL

This is a spelling checker for Tasword D word-processor. The dictionary contains 20,000 words and grows as you use it, simply select the "K" option the Tasword menu.

DISC	£16.50
------------	--------

SCREEN COPIES

TASCOPY

This program will allow you to copy your screen with shaded printing, including poster size screen copies using 2 or 4 sheets.

CASSETTE	£9.90p	DISC	£12.90p
----------------	--------	------------	---------

DATABASES

MASTERFILE

This database has set the standard for micro computers. With 100% machine code it will allow 240 characters per field 40 fields record 34000 characters per file. This will enable you to keep a record of 500 full names and addresses. Features include full search facilities, sort in ascending or descending order, column totals, 1 or 22 records per screen.

Masterfile 464 cassette	£21.25p
Masterfile II disc	£33.00p
Masterfile III disc	£39.95p

MASTERFILE EXTENSION

For those who want to stretch Masterfile, this packed import, export files to Tasword, merge files, data handling and many other features allowing calculations between fields etc.

CASSETTE	£9.95p	DISC	£13.95p
----------------	--------	------------	---------

DISC-DRIVES

Disc drive without controller	£99.00p
Disc drive complete with controller	£159.00p

COMPUTER AND MONITOR

Amstrad 464 64k complete with green monitor and cassette	£199.00p
Amstrad 464 64k complete with colour monitor and cassette	£299.00p
Amstrad 6128 128k complete with green monitor and disc	£299.00p
Amstrad 6128 128k complete with colour monitor and disc	£399.00p
Amstrad 8256 complete with green monitor and disc	£458.85p

SPREAD SHEET

MASTERCALC

Spread sheet program from the same software house as Masterfile. Features include 3000 cells 8 byte floating precision 40-80 column display, direct totals and sub totals 3 bar histograms, cursor direction keys, add or delete columns-rows high resolution screen copies on Epson compatible printers.

CASSETTE	£21.25p	DISC	£25.45p
----------------	---------	------------	---------

MASTERCALC EXTENSION

Allows you to transfer data from MasterCalc to Tasword and user access to MasterCalc data.

CASSETTE	£9.95p	DISC	£13.95p
----------------	--------	------------	---------

PRINTERS

	Ex VAT	Inc VAT
Brother M1009	£163.00p	£187.45p
Epson LX80	£199.00p	£228.85p
Taxan Kaga KP810	£250.00p	£287.50p

DAISY WHEEL PRINTERS

Brother HR10	£245.80p	£282.67p
Brother HR15	£349.00p	£401.35p

Please add £5.75p delivery.

PCW8256-6128 SOFTWARE

Sage popular Accounts	£99.99
Sage popular Payroll	£69.99
Payroll with Accounts	£149.99
Supercalc 2	£49.95p
Sales Ledger Invoicing, Stock Control	£84.15p
Purchase Ledger	£28.05p
Nominal Ledger	£28.05p

£199.00
plus VAT

EPSON LX80

- Near Letter Quality
- 100 characters per second
- 1k buffer
- Friction feed
- Tractor feed (optional extra)
- Sheet feed (optional extra)

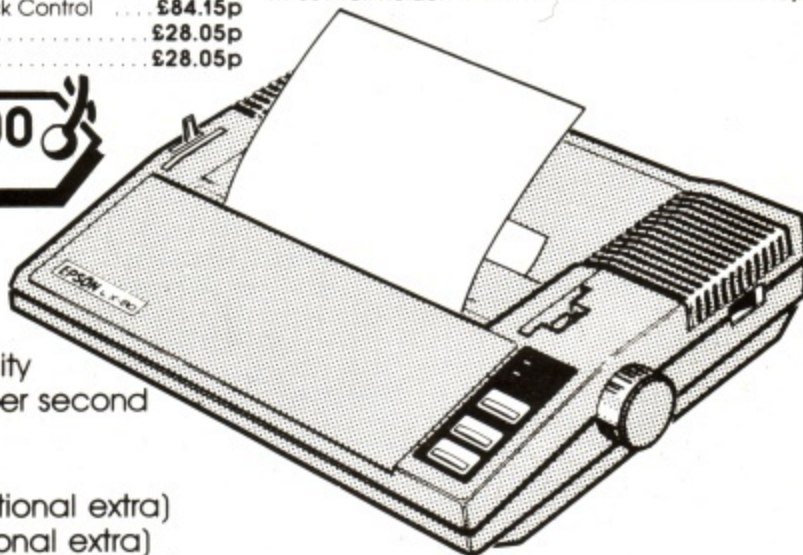

MEMORY EXTENSION

Extend your 464/664 to 6128 with this memory extension

£49.95

DISPLAY LANGUAGE

DLAN

Advertise your products, services with this program by Campbell Systems. The print facility allows you to produce leaflets, labels, menus using 15 different fonts.



CASSETTE	£9.95p	DISC	£13.95p
----------------	--------	------------	---------

ACCESSORIES

ACCESSORIES

Centronics Lead	£9.90p
3" discs	£4.95p
Modulator	£29.95p
RS 232 interface	£49.95p
Epson LX 80 tractor feed	£20.70p
Epson sheet feed	£55.00p
M1009 tractor feed	£15.18p
M1009 roll holder	£7.18p



Domark has had more ups and downs than the Otis (*A make of lift - Ed*) which takes you to the *Amstrad User* office. It has always had a high profile – the image of good marketing helping mediocre software.

Its first program was Eureka, an adventure written by Andromeda software which took the player through a myriad of different times but this was never converted for the Amstrad. It came out just after the Arnold, offering a huge cash prize to the first player to finish. If no one managed this the £25,000 would be split among everyone who bought a copy. This was an excellent deterrent to piracy and an incentive to play the game – “I can't have my tea now Mum – I want to win £25,000”.

Just as the deadline was looming a schoolboy told Domark that he had finished the game and left last year's PCW show with a cheque and a large grin. Even for the people who didn't win, Eureka was good value for money.

Double Oh Seven

The first Domark program to appear on the Amstrad was *View To A Kill* based on the James Bond film. While the music by Duran Duran was doing very well in the singles chart the game did less spectacularly in the software stakes. *View To A Kill* was rushed and it showed. This was not helped by lots of magazines being offered an exclusive.

Domark has never worried about what prudes might think. Friday 13th was a very successful horror film. It was certainly scary, I trembled through part two, walked out of part one, and avoided part three – in that order – but then I'm just a coward. Still a lot of people like being scared silly and were very popular.

The game of the same name caused the kind of trouble on which Domark seems to thrive. There were calls for it to be withdrawn, the advertisement had to be changed and Domark claimed that it was all in the best possible taste. Unfortunately the game was not as scary as watching an undead attack two teenagers in a VW Beetle. It was too easy by far. All you had to do was grab the spear and throw it enough times.

Domark seems to look for controversy. One of its newest releases, *Splitting Image*, has annoyed the people at Central Television so much that the name has had to be changed to *Split Personalities*, but fortunately the game – a block puzzle program – is good enough to weather the storm.

Gladiator, their newest release, has none of the usual Domark traits. No big name tie-ups, no rumours or scandal, it is just a good down-to-earth combat game. The Amstrad conversion has been written by Mike Moscoff who was part of

Controversy behind, Domark settle for battle



The combat game market is hotting up. The latest pugilist to enter the arena is *Gladiator* from Domark. Simon Rockman looks at the company and the program.

the original Spectrum programming team.

Mike is a programmer working on big IBM mainframes but was attracted to the micro world by the graphics. He complains that the mainframe world is all accounting and no fun but that games programming is much much more time consuming. The conversion from Spectrum to Amstrad had taken over three months.

It was originally intended to be a Mode 1 game but the lure of extra colours and

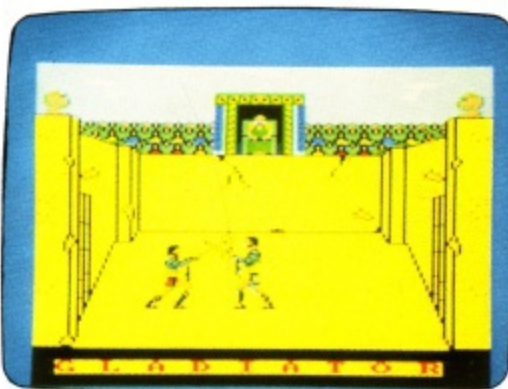

This shows the gladiator graphics. A score will be added.

the quest for speed led to a switch to Mode 0 one month into the project. This meant that the all-important sprite routines had to be re-written.

When I saw *Gladiator* the code was nearly finished but the graphics were still being finished by an artist the other side

of London. The smoothness of the graphics is partly due to the use of a buffer to the screen which allows the whole area where the fighting takes place to be updated in one fell swoop.

The key combinations got very complicated with the Spectrum and Spectrum 128 versions so Mike has simplified the options for the Arnold. You still have just as many weapons to choose from and can still throw your sword or dagger but the key combinations have been made easier.

A useful hint for players is that the trident is the most powerful weapon (Mr Reagan believes that too). You can use two tridents despite the software recommending that you select a shield. There are many types of weapon including a ruler, which Mike says is there because of the ruler fights he used to have at school. You could arrange a fight to the death with rulers.

If you get really bored you can set the computer to fight itself, gambling on the outcome. In fact once you have defeated the champion you have to defeat the champion you have to do this to win your freedom – yes I've seen Sparticus as well.

Gladiator is not a typical Domark game but it is good, there are elements of the other combat games but more of an atmosphere, but the thing which really sets it apart is the lack of hype. I look forward to seeing the finished program.

EQUINOX

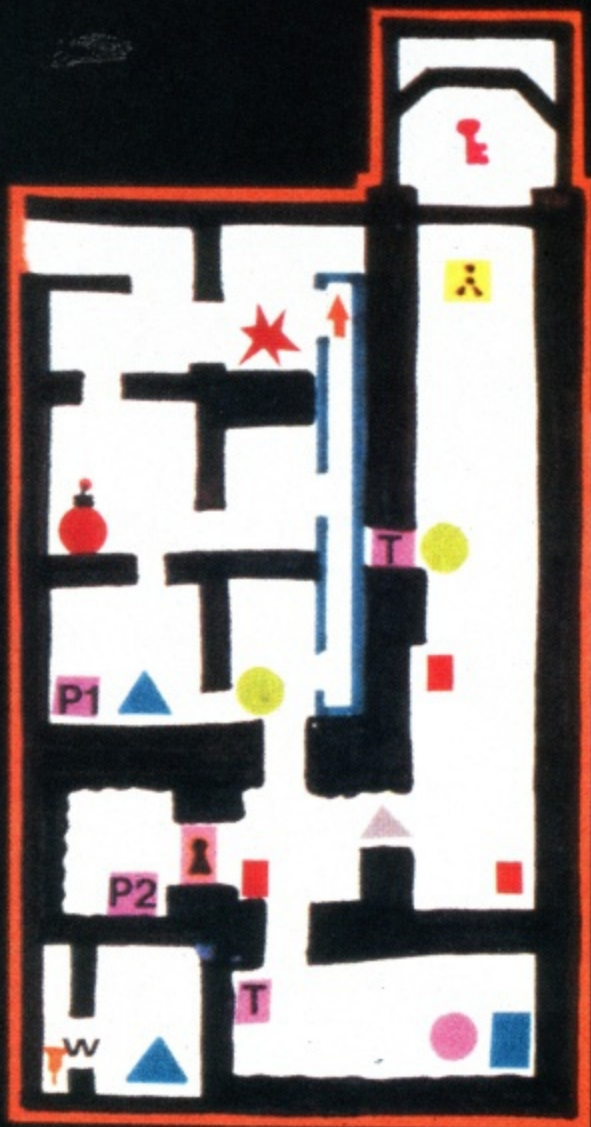



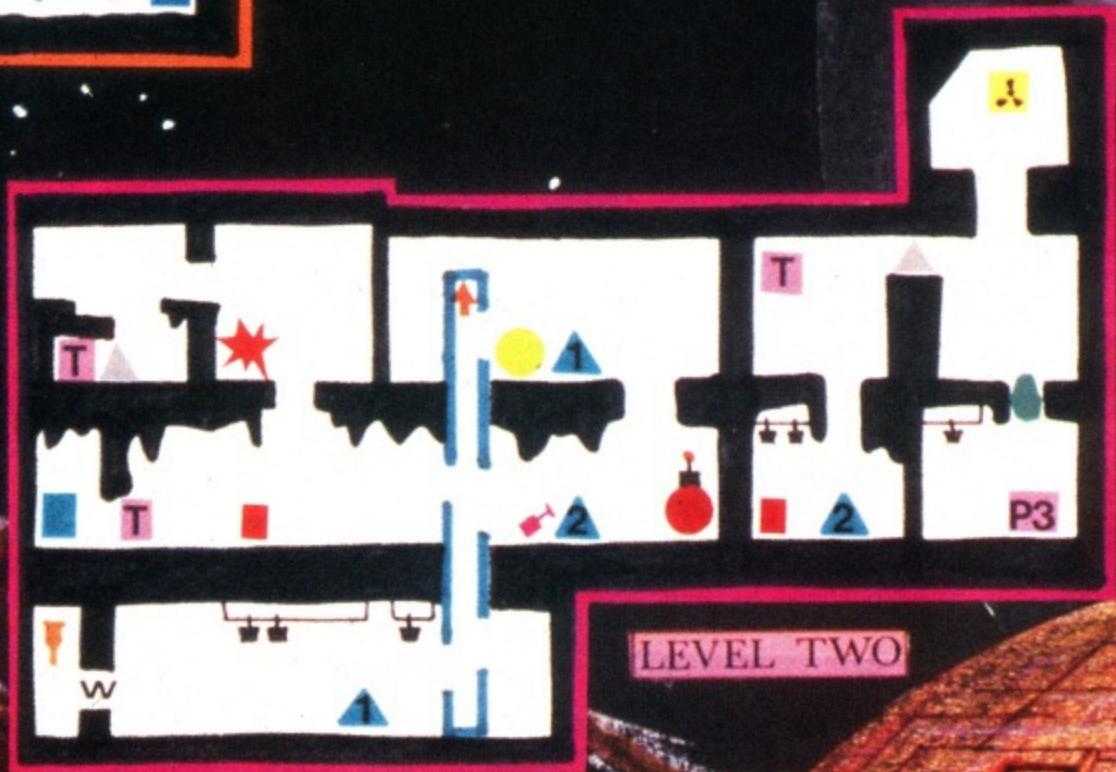















LEVEL ONE



LEVEL TWO



-  Bomb
-  Spade
-  Transporter
-  Lift Pass
-  Fire Power Battery
-  Fuel
-  Waste Disposal
-  Drill
-  Credit for Transporter
-  Magnet
-  Explosives
-  Rockfall/Blockage
-  Radioactives
-  Key
-  Lock
-  Pete?!
-  Lift to Next Level
-  Green Jelly Rock
-  Fuse

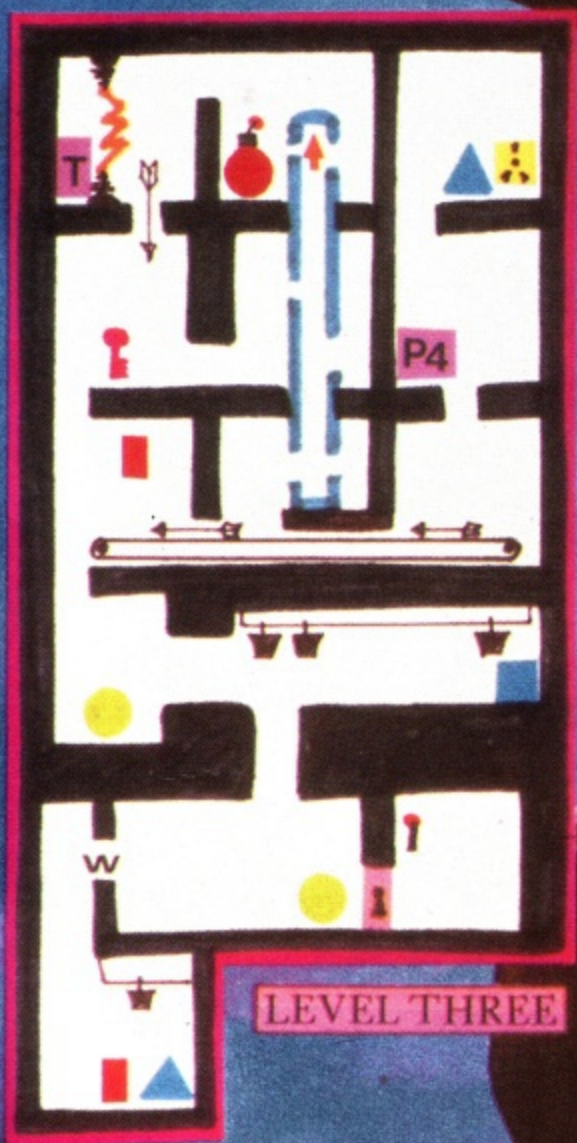

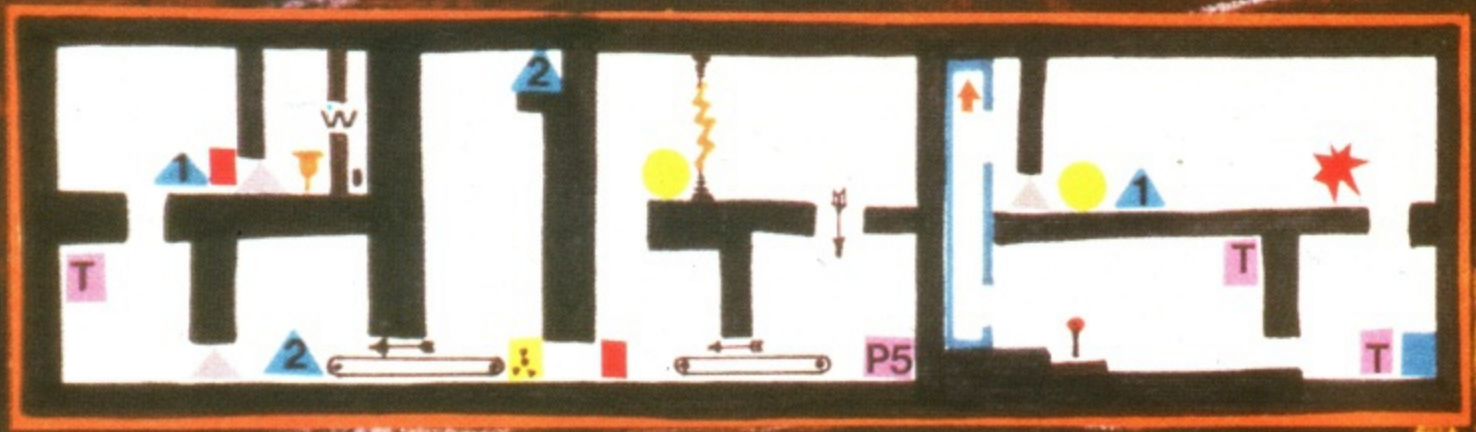

LEVEL FOUR

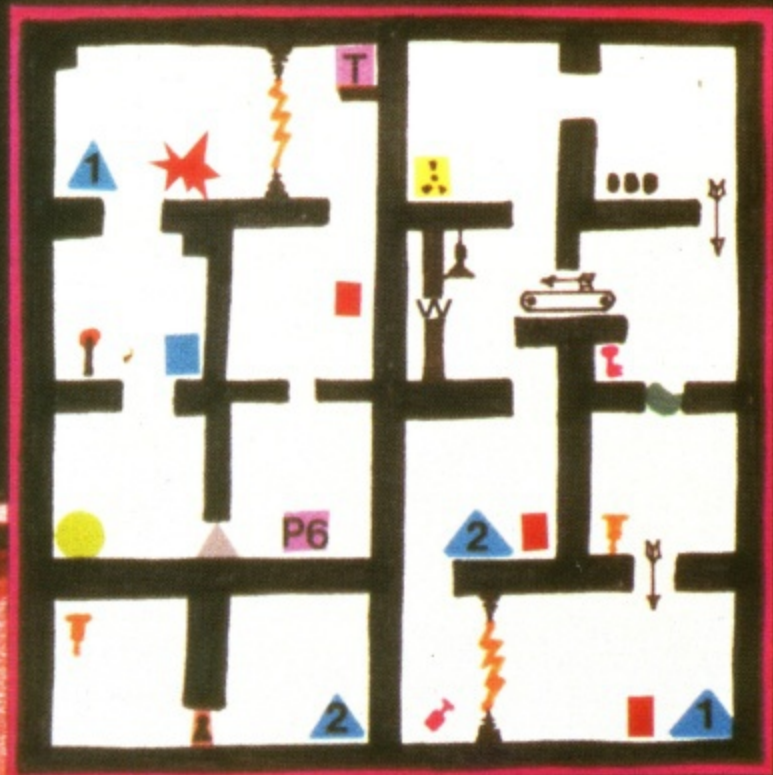
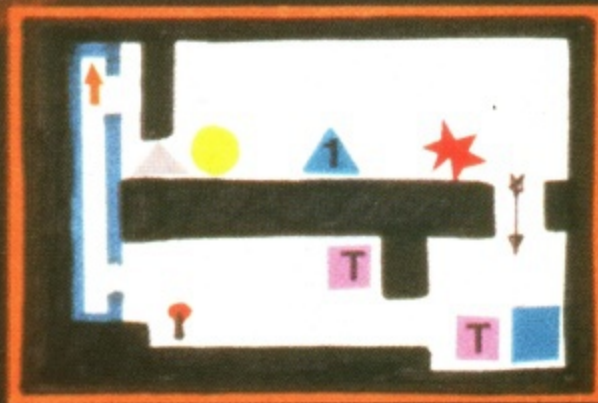

LEVEL FIVE

FUEL

95-OCTANE

DANGER
RADIOACTIVES

ALEX

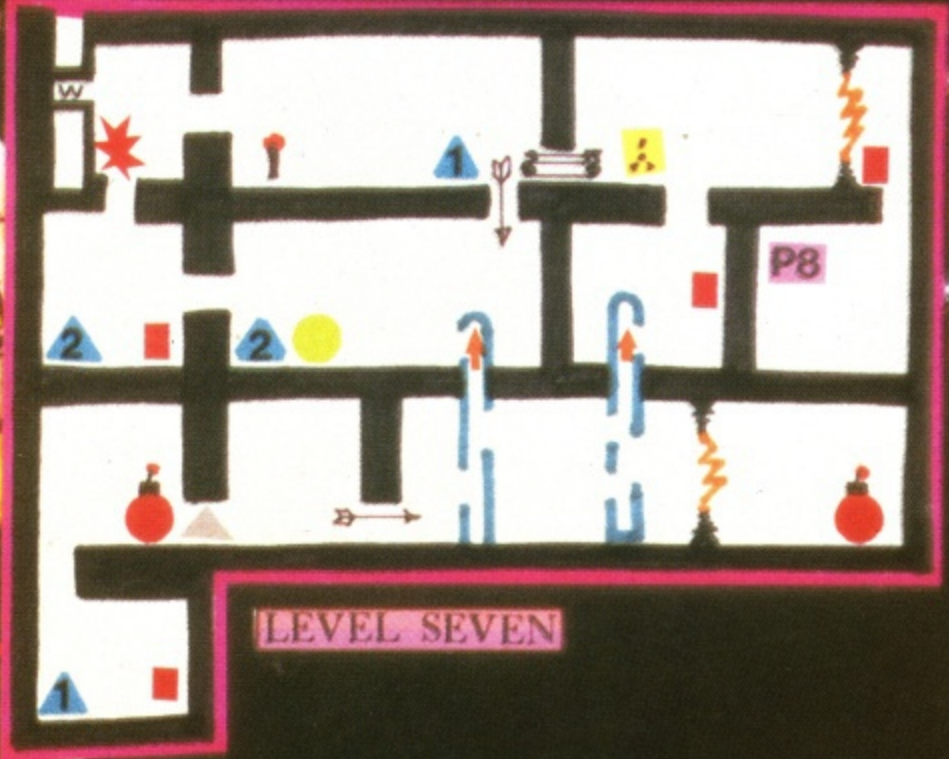
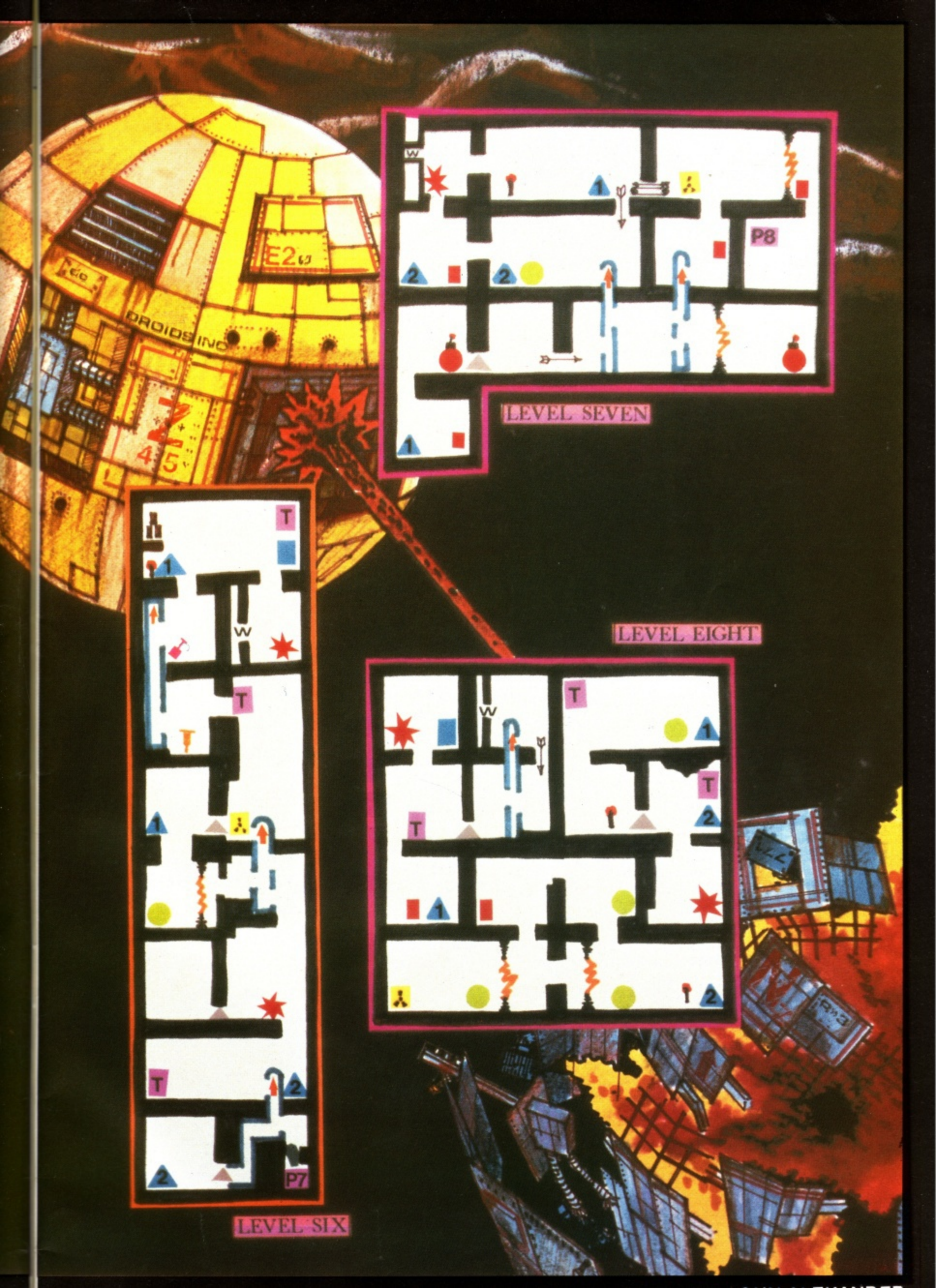

LEVEL SEVEN



LEVEL SIX

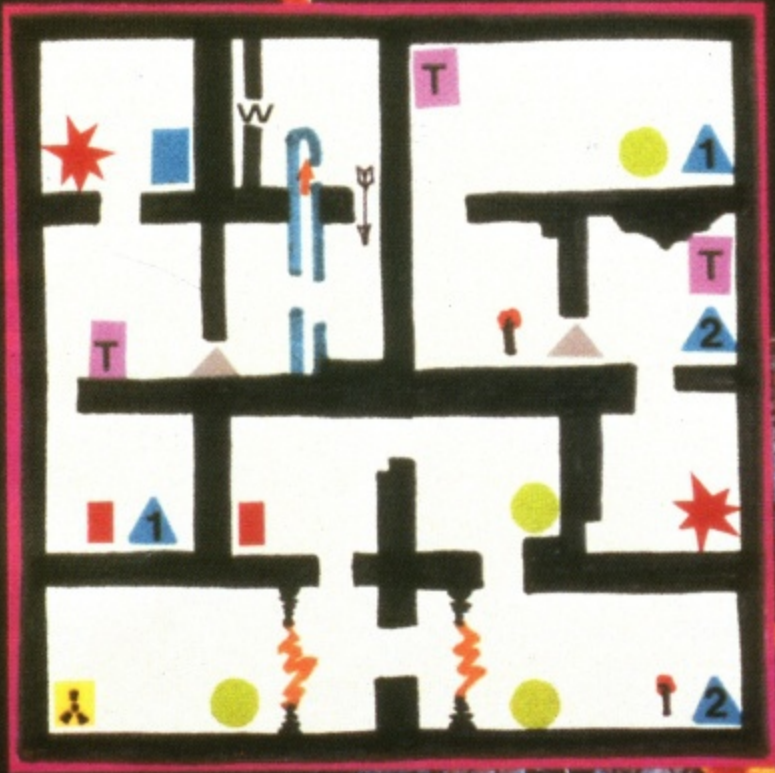

LEVEL EIGHT

256K SILICON DISC



• This is the fastest storage system available for Amstrad CPC computers and is compatible with CPM 2.2, CPM+ and all DK'Tronics peripherals including the 64K/256K memory expansions. When used with CPM+ and our 256K memory the edition disc

capacity is a massive 442K (more than the PCW 8512 Ram Disc). It automatically logs on as drive B or drive C in two drive systems and does not require extra power supply.

- The 256K Silicon Disc is designed to be used with at least one normal disc drive attached. When fitted the directory uses 2K thus leaving 254K for storage, over 70K more than the normal discs.
- Data and programs can be exchanged between the Silicon Disc and a normal disc, application programs can then work on the data at vastly increased speed especially on systems with only one normal drive.
- Software is contained in an expansion ROM and there are two environments in which the Silicon Disc can be used, BASIC under AMSDOS where all the normal AMSDOS commands are fully supported LOAD, SAVE, MERGE, CAT etc and within CP/M 2.2 CP/M+ where commercial programs are designed to run on multi drive systems.

£99.95 including VAT (464 and 6128)

64K and 256K MEMORY EXPANSIONS

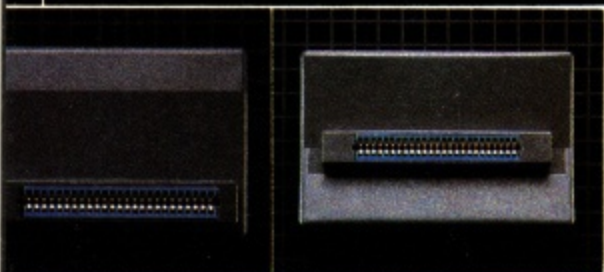

• The memory expansions increase the Amstrad 464's internal memory to give a total of 128K or 320K. The 621's memory is increased to 320K. It is compatible with all DK'Tronics peripherals including the 256K Silicon Disc.

- It is supplied with bank switching RSX software (464 software on cassette 6128 on disc.
- The software adds some BASIC commands which makes it possible to use the second 64K (or 3rd or 4th and 5th in the case of 256K) for storage of screens, windows, graphics and basic arrays. This ability means that you can write much larger basic programs and sophisticated programs that use pull-down menus with ease.
- With an expansion fitted on the 464 it then has the same memory configuration as the CPC 6128. It will then run CPM+ with its massive 61K T.P.A. area, opening up an even larger software base to 464 users. When using either of the expansions with CPM 2.2 on the 464 and 6128 computer the T.P.A. is increased to 61K.
- The RAM is accessed by means of bank switching using a single I/O port. Memory is actually switched in and out of the 64KZ80 address space in 16K sub blocks (as are the ROMS). The port determines which particular combinations of the original four 16K sub blocks and any new sub blocks from the expansion RAM will occupy the 64K address space at any time. All of this switching is done automatically by the software supplied.
- The contents of the expansion RAM are retained if the computer is reset and if the RAM is used for machine code the contents will remain even if the computer crashes.

64K £49.95 including VAT (464 only)
256K £99.95 including VAT (464 and 6128)

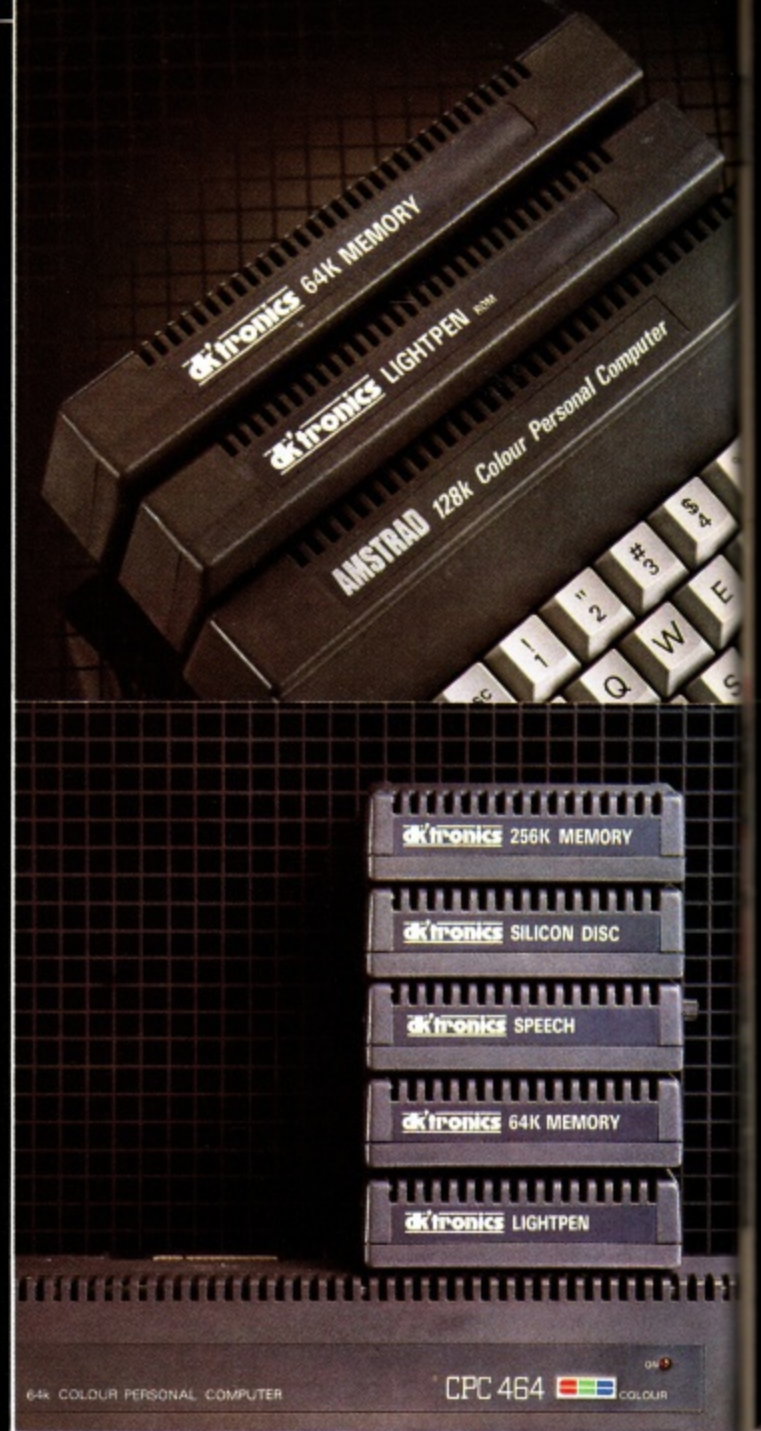

LEAD FROM

DK'Tronics have produced this range to enlarge the potential of the 464 and have been designed to com





GRAPHICS LIGHT PEN

The sophisticated graphics package includes a colour palette, nudge control for one pixel accuracy, brush choice, text handling and user defined characters.

- It can magnify, shrink, colour fill and create circles, rectangles, lines and curves.
- Complex pictures can be easily edited at pixel level using a scratch pad which is magnified to the full screen.
- There is picture storage and retrieval, and a pen calibration utility and there is also an Amstrad/Epson compatible printer dump utility supplied on cassette.
- There is a cassette version for the 464 and a ROM version for the 464 and 6128.

Cassette **£19.95** including VAT (464 only)
ROM **£29.95** including VAT (464 and 6128)

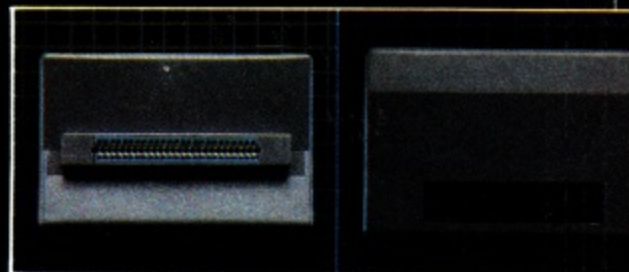

SPEECH SYNTHESISER

- This simple to use speech synthesiser includes a powerful stereo amplifier and two high quality speakers which greatly improves the sound quality of the internal mono speaker.
- It uses the popular SPO/256 speech chip and has an almost infinite vocabulary.
- It is supplied with a text to speech converter software for ease of speech output creation. Everything you wish to be spoken is entered in normal english without special control codes or characters making it extremely easy to use.
- The voicing of the words is completely user transparent and the computer can carry on its normal running of a program whilst the chip is talking. The speech output from the SPO/256 is mono and directed to both speakers.
- There is a cassette version for the 464 and a ROM version for both the 464 and 6128.

Cassette **£29.95** including VAT (464 only)
ROM **£39.95** including VAT (464 and 6128)



DOING BEHIND

A range of powerful peripherals to complement their style and colour.

dktronics
POWER BEHIND YOUR AMSTRAD

DK-Tronics Limited
Gorleston, Great Yarmouth, Norfolk NR31 6BE.
Phone 0493 602926 (24 hours), Telex 975408.

HOW TO ORDER

DK-Tronics products are available in all good computer stores but may be obtained by completing the order form below and returning it to DK-Tronics or by telephoning and quoting your Barclaycard or Access number.

Orders are normally despatched within 24 hours and if you have any further queries concerning our products do not hesitate to give us a ring or send us a large stamped addressed envelope for our latest free 84 page technical manual covering our Amstrad product range.

Please send me

Name _____ Signed _____

Address _____

I enclose Cheque/PO/Cash for:- Total _____
or debit my Barclaycard/Access number _____

--	--	--	--	--	--	--	--	--	--	--	--	--	--	--	--	--	--	--	--

CP/M+ is a registered trademark of Digital Research Inc.

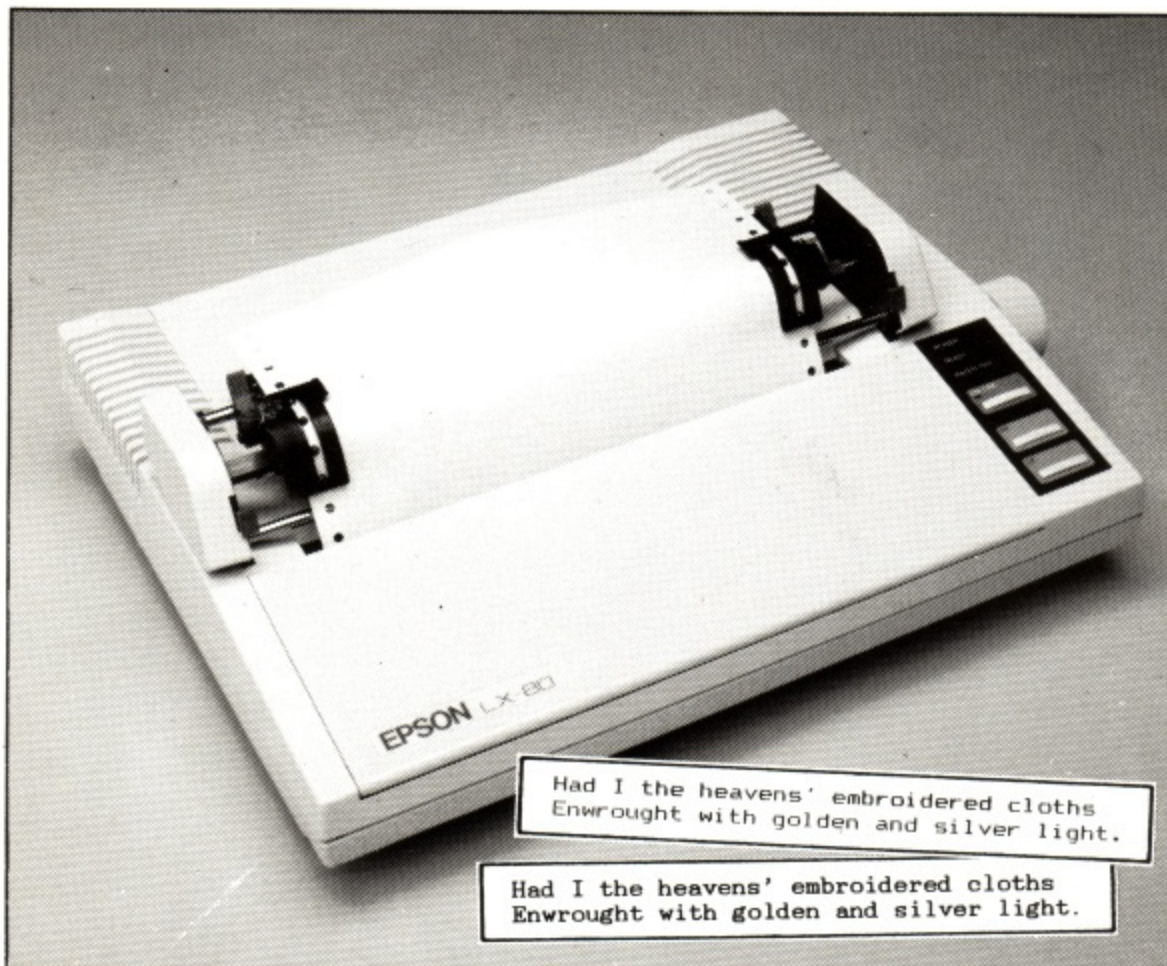

Epson LX-80

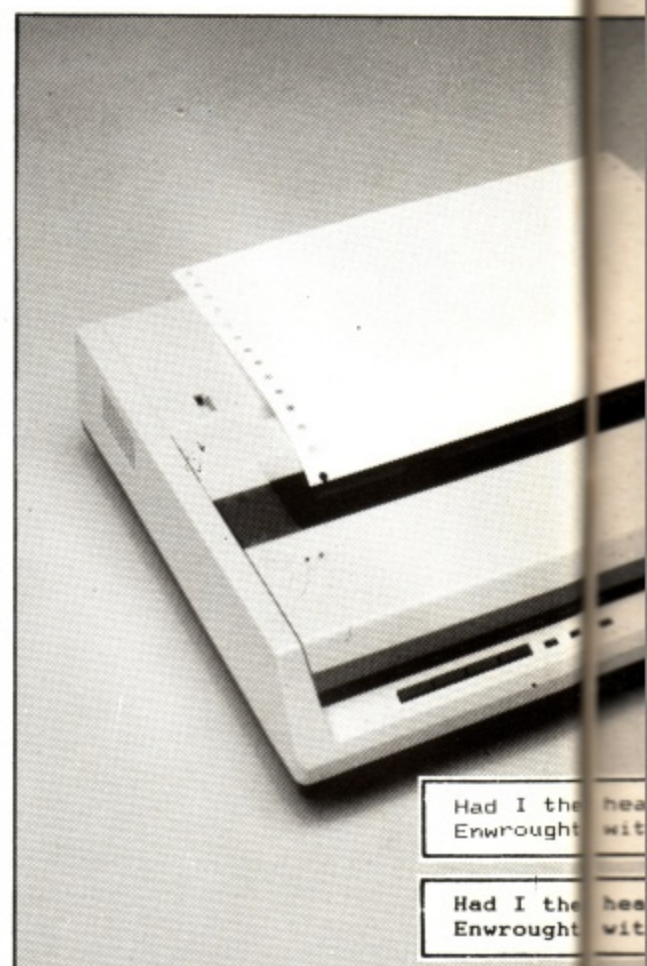

OKI Microline 182

Buying a printer is just like buying a computer. Before deciding which model to buy, you have to ask yourself what you want it for.

There are three main reasons for buying one. Firstly, it will print out long program listings. Secondly, it will produce letters and correspondence. Thirdly, it will output graphics.

Graphics and letter-quality print are usually produced by application programs which will have installation procedures to tell the program what printer it is being used with.

Daisywheel printers, while producing super letter-quality characters, are usually pretty slow – unless you're willing to pay about £1,000 – and can't handle graphics. When dot matrix printers were first available the print quality was poor and you could clearly see that the characters were made up of dots. They were fast and cheap, so they were perfect for spooling off reams of listings. But they didn't produce very professional looking letters.

Nowadays dot matrix printers have a mode often called NLQ, or Near Letter Quality. The reason the manufacturers don't go all the way and call it Letter Quality is partly because, although they're good, they're not as perfect as daisywheel printers. The other reason is that they're saving the name LQ for a new generation of dot matrix printers that really will make daisywheel printing redundant.

For this review, I tested three dot

Printers on parade

Dot matrix printers have improved dramatically over the past few years with the hottest competition in the sub-£300 area. Robert Schifreen looks at the three leading contenders

matrix printers. Each is capable of graphics, and will also print in draft mode (fast) and NLQ mode (not so fast). Each costs between £215 and £275 for a model with a Centronics interface, capable of linking to any Amstrad micro.

Having used many printers over a number of years, you get to like some features and despise others. I used to keep a list of which features impressed me on a particular model, and which were so annoying that they almost made me change back to an older printer.

For this review, I dug out that list and applied each of its entries to the printers under test. The printers under scrutiny

were the Epson LX-80 with tractor feed unit, priced £275, the Citizen 120-D at £235 and the OKI Microline 182 costing £215.

These are the official retail prices for the models tested. Like any piece of equipment, it is well worth shopping around. For example, one advertisement recently quoted an LX-80 at under £200.

Physical appearances

Each printer comes packed in a protective box with a manual and mains lead. Removing the packing revealed three good looking machines. The OKI is

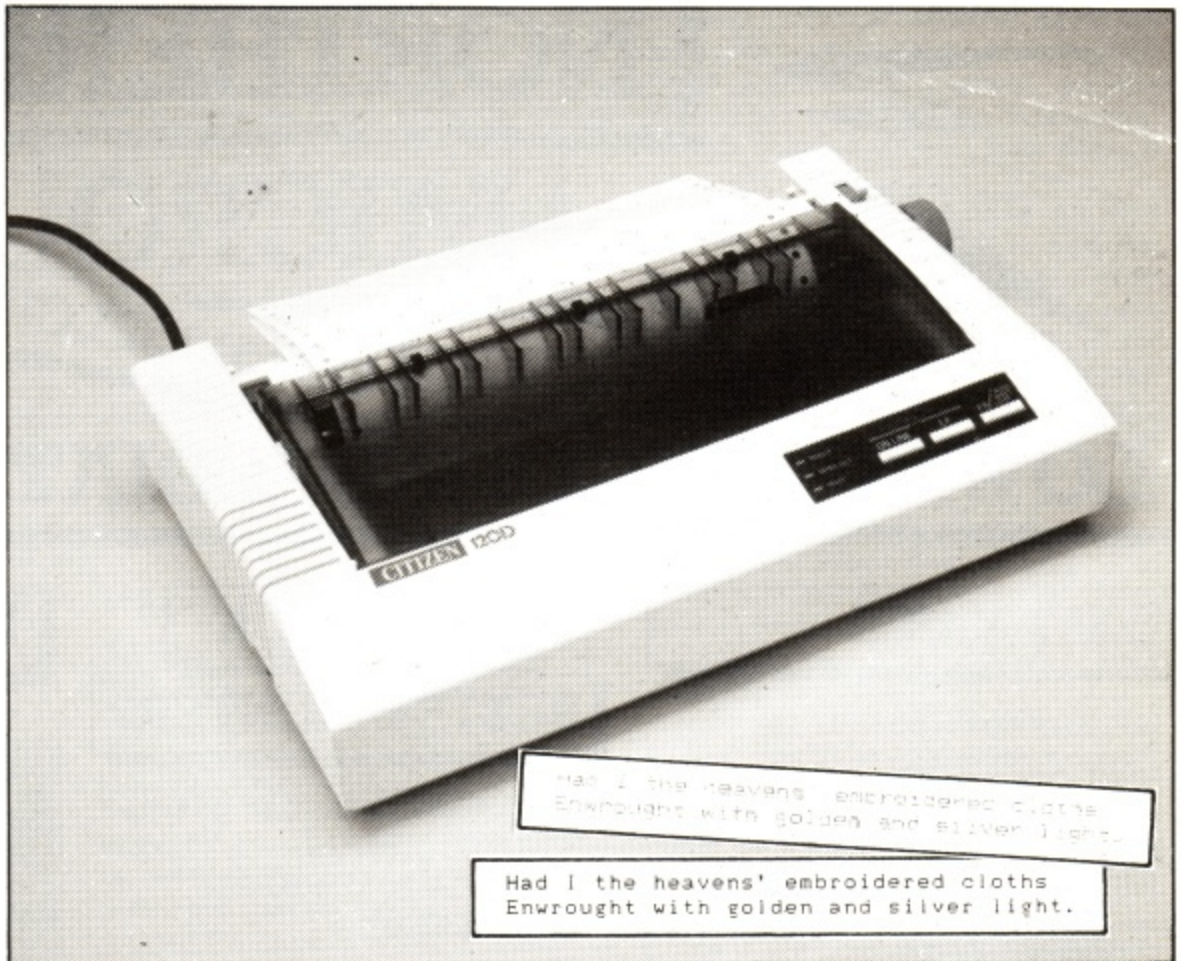
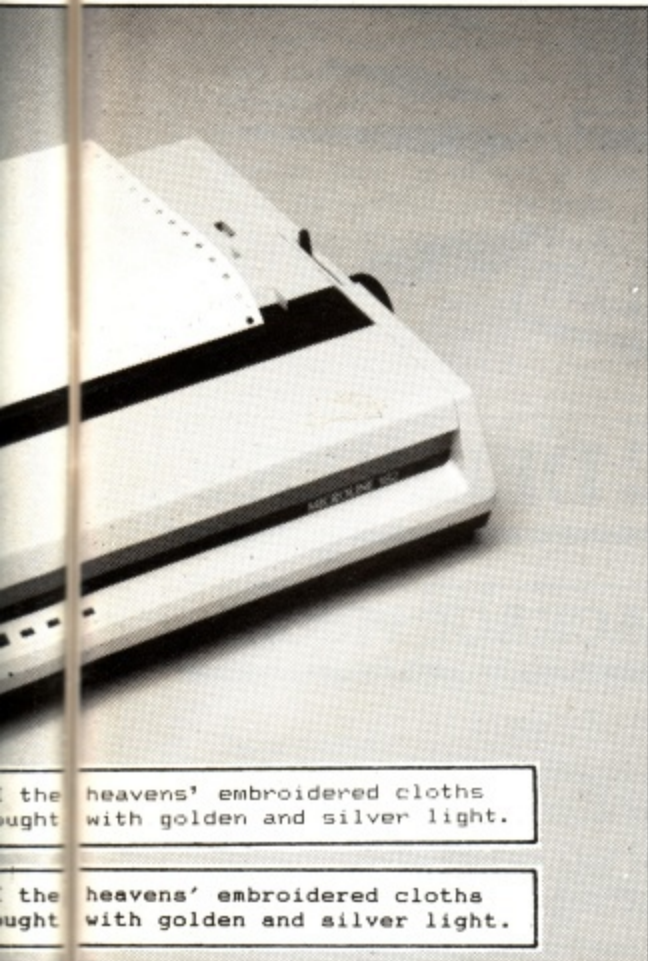

Citizen

(Print samples: Top, draft mode. Bottom, Near Letter Quality)

the smallest and lightest of the three. Its tractor unit is built in and doesn't add to the total height of the printer. The additional tractor feed units on the Citizen and Epson models almost double their overall height.

Speed trials

The first thing I did after unpacking the printers was to test them for speed. Adverts usually measure print speed in characters per second. This doesn't take into account the time taken for a line feed - when the end of a line is reached and the paper has to be moved up through the printer by one line.

I produced a test file on a disc - the contents of my Telecom Gold mailbox. This file was around 11 pages long and contained some long lines, some short lines and one or two form feed characters

(where the paper is advanced by one whole page).

I printed out this file on all three printers, both in draft and NLQ modes. All three print bidirectionally in draft mode. In NLQ mode, though, the Epson and Citizen print in one direction only. This is because NLQ print is produced by printing each line twice - one on top of the other - and there are difficulties in making sure that the second pass lies exactly on top of the first unless you only print in one direction. OKI, though, seems to have found a way round the problem - its NLQ print is bidirectional and shows no loss in quality. It also makes the machine much faster.

Incidentally, although the OKI is capable of NLQ print, it seems that the person who wrote the manual wasn't aware of the fact. The details were on a single sheet of paper inserted in the box

so, if you buy an OKI, don't throw away the packing until you've checked it carefully.

Print quality

You can judge for yourself the quality of the output from the samples on this page. My opinion is that in the draft mode the OKI wins because the dots are closest together. But it's still easy to tell that the output was produced by a dot matrix printer.

For NLQ quality the Epson wins hands down although some of the diagonal lines are a little jagged. OKI's NLQ mode is second and, taking speed into consideration as well, may be a better deal than the Epson.

With the Citizen in draft mode it was easy to see the individual dots in the characters. Its NLQ typeface looks like the ones used to produce gas bills, for example, and I wasn't a great fan of it. Before you completely rule out a Citizen, though, see the section on graphics.

Documentation

Printer manuals have always had a bad reputation. If a subject was important it probably wouldn't be in the manual, and if it was you wouldn't be able to find it.

Epson started the ball rolling in producing decent documentation, and it's clear from looking at other manufacturers' efforts that they have studied Epson's theories in detail.

The quality of English in the Epson

	Draft mode		NLQ mode	
	Minutes	Seconds	Minutes	Seconds
Epson LX-80	6	27	25	33
OKI Microline 182	4	47	11	24
Citizen	4	54	19	16

Timing in minutes and seconds



LOWEST PRICES IMMEDIATE DELIVERY

DATABASES

CARD BOX £86.50
 CONDOR 1 £86.50
 SAGE RETRIEVE £59.95
 MAGIC FILER £59.95

UTILITIES

SMARTKEY £44.85
 BRAINSTORM £44.85
 TOUCH N' GO £21.70

COMMUNICATIONS

CHIT CHAT E-MAIL £64.85
 CHIT CHAT VIEWDATA £64.85
 Either of above with
 V21/23 Modem & Cable £173.00

AMSTRAD 8512 only £485.00
AMSTRAD 8256 only £375.00

REQUIRE A

BETTER PRINTER?

Top Quality Printers for 8256/512
 JUKI 5510 £199.00
 EPSON LX 80 £229.00
 DX100 £399.00

SPECIAL OFFER

QUENDATA 1120
 DAISYWHEEL PRINTER £159.00
 20 cps QUME COMPATIBLE

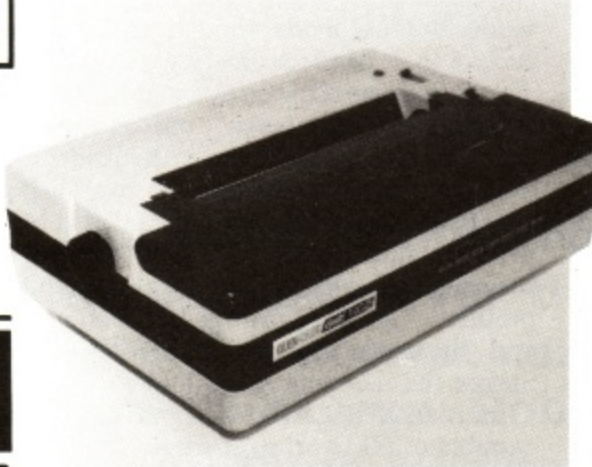

PACKAGE PRICES

We offer extra
 Discounts on 8512
 and Printer Purchases
 and 8512 and Software
 Purchases - call for a quote.

SPREADSHEETS

SCRATCH PAD PLUS £59.95
 CRACKER £43.50
 SUPERCALC £43.00

WORD PROCESSING

NEW-WORD £64.85
 POCKET WORDSTAR £45.00

ACCOUNTS

SAGE ACCOUNTS £86.00
 SAGE INVOICING £60.00
 SAGE ACCOUNTS PLUS £130.00
 SAGE PAYROLL £60.00
 SAGE COMBO £139.85
 SUPER COMBO £184.85

3" Disks Prices Falling Daily
 Please Call

CPS Printer Interface
 and Lead £59.00

**156, LONGWOOD GATE
 LONGWOOD
 HUDDERSFIELD
 HD3 4XF.**

**OPEN 9am-5.30pm Mon-Fri
 9am-1.00pm Saturday**

**GOVERNMENT
 OFFICIAL AND
 OVERSEAS ORDERS
 WELCOME**

All prices include V.A.T. (except pcw's)
 Delivery - Printers (via Securicor) £10
 Other (1st class post) £3.00



**TEL
 HUDDERSFIELD
 646048/9**

Tel Orders - Visa/Access despatched
 same day

and OKI manuals is reasonable. Citizen's was translated from Japanese, and many sections have lost a lot in translation.

The Citizen and Epson manuals assume that the printer is going to be used by a Basic programmer. All the examples are in Microsoft Basic (à la IBM PC). The OKI manual is similar, but does have a chapter on installing the printer specifically for Wordstar, Visicalc, Superwriter and Supercalc.

Epson has a chapter on using the LX80 with certain computers and is the only one with a troubleshooting section in case the printer doesn't always do what the manual says it will.

For me, the most useful part of a manual is the index at the back. Having the information in the manual is one thing, being able to find it is another. The OKI manual has no index so relying on

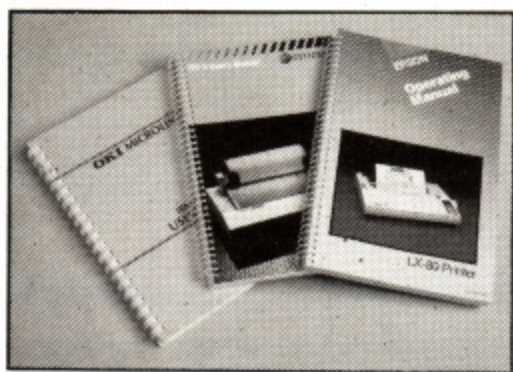

The manuals

the contents list at the front will get you nowhere fast. The Citizen manual is a little better, with a pull-out reference card at the back. This contains a very brief note on each command, and a page reference too.

Epson's manual is the best. While the information may not be arranged in the most logical order (DIP switch settings are at the back, for example), the index is quite good and contains a full list of all commands. There's a pull-out reference card too, though this one doesn't have a page number reference on it.

DIP switches

DIP switches are the tiny switches you need to set according to certain characteristics of your micro, such as whether an extra line feed character is added to carriage returns. You can also specify such things as the size of paper you are using, whether you want the buzzer to sound when the machine runs out of paper and so on.

You'll set the DIP switches when you first buy the printer and will never need to alter them, unless you have more than one machine, or you want to change the settings occasionally. This used to be easier said than done, as Epson was infamous for putting the DIP switches in such a place that you had to take the printer apart to alter them. What's more, any optional interface boards that you

had installed would need to be removed as well.

Luckily, things are now easier. The switches on the Epson are at the back of the printer. With the Citizen, they are on the pull-out interface and on the OKI you have to remove a small cover at the back of the machine to reveal them.

Ribbon life

If you plan to use your printer frequently you'll want one with a long ribbon life. All three ribbons are in throw-away cartridges which are easy to replace but fairly expensive. All are quoted at being able to print around two million characters. None is re-inkable.

Paper feeding

All three printers were fairly easy to load with paper. The OKI, though, has a lid through which the paper passes on its way out of the printer. This means that you can't really lift the lid to see what's happening while the text is being printed as you have to wait until it has moved up by around six lines before the print passes out through the lid.

Once the paper has left a printer, it seems to have a mind of its own. According to the shape of various devices on top the paper will curl up in front of the printer, or behind it, or will get tangled and start to feed itself back into the printer and jam up. This latter case describes perfectly the Epson LX80.

With continuous paper, it's very hard to keep it coming out smoothly without giving it a helping hand after every page or so. When printing a long document I didn't feel confident enough to leave the machine unattended. The same goes for the Citizen, although this machine was quite happy as long as you didn't mind the paper coming out and piling up behind the printer. Trying to make the paper feed out forwards was difficult.

Only the OKI gave me enough confidence to leave it printing, happy that it would not tangle up its paper. What's more, it is the only printer with a straight edge to the lid that lets you tear off the paper once the job has finished.

Noise

In a quiet room or office, any printer sounds noisy. It's not so much the actual amount of noise it makes that bothers people, but the pitch. A high noise is easier to hear, and the Epson's was the highest, OKI was the lowest. Even so, with any of the printers going, I could not comfortably carry on a telephone conversation in the same room.

Graphics

Each machine allows you to produce graphics and special characters. Graphics mode means that, instead of printing whole characters that are made

of dots, you can control each dot individually to make your own designs. Some applications programs use this facility to produce graphs, for example, though doing it yourself from Basic is time consuming.

It is well known that the Amstrad micros have only a 7 bit parallel interface. This means that Ascii characters with codes greater than 127 cannot be sent to the printer. This is not normally important when printing text, but is crucial with graphics. If you intend to produce your own, you will need to consider a printer that can control the eighth bit. What this involves is having a command on the printer which basically says: "Until I say otherwise, add 128 to all the Ascii characters that I send". So to send a character 129 you would send the eighth-bit command followed by a character 1.

Only the Citizen printer has this feature, which should be borne in mind if you intend to do a lot of graphics work. The Citizen and Epson printers allow you to set various typestyles by tapping out various combinations on the control panel.

The OKI's most useful button is TOF, which stands for top of form. Pressing this tells the printer that it is at the top of a sheet, so it can then work out where the bottom of the sheet is in word processing. Without this button, you have to turn the printer on and off again to set the top of form position.

Buffers

The Citizen has the largest buffer fitted as standard. It will store about a minute's worth of text after the computer has finished sending. The Epson and OKI printers store only a couple of lines.

The verdict

I started by saying that before buying a printer you have to know what it's going to be used for.

If it's mainly for producing letters and correspondence, the Epson's NLQ is the best of the three.

For printing mainly program listings, or where quality is not vital, the OKI wins on speed and performance. A very impressive printer, and good value.

For general printing purposes, again I would say that the OKI represents the best value for money. Its NLQ face is only very slightly inferior to the Epson's and the printer is a fast all rounder. However, its commands are not as widely used as the Epson standard, and some applications software may not support them.

The Citizen is good, and fits comfortably between the Epson and OKI. Its main advantage is being able to control the eighth bit, which is essential for graphics.

GALLUP SOFTWARE CHART

	TITLE	PUBLISHER	Last month		Months in chart	Market strength
1	BATMAN	Ocean	new	▲	1	1000
2	GET DEXTER	PSS	5	▲	2	951
3	COMMANDO	Elite	15	▲	2	842
4	SPINDIZZY	Electric Dreams	3	▼	3	727
5	THEY SOLD A MILLION (2)	Hit Squad	7	▲	2	717
6	LAST V8	Mastertronic	1	▼	3	680
7	INTO OBLIVION	Mastertronic	2	▼	2	624
8	TOMAHAWK	Digital Integration	new	▲	1	545
9	TURBO ESPRIT	Durell	9	▶	2	509
10	COMPUTER HITS 10 Vol. 2	Beau Jolly	6	▼	3	479
11	WINTER GAMES	Epyx/US Gold	new	▲	1	467
12	FORMULA ONE SIMULATOR	Mastertronic	8	▼	8	461
13	BOUNDER	Gremlin Graphics	new	▲	1	418
14	BOMB JACK	Elite	new	▲	1	406
15	SABOTEUR	Durell	14	▼	2	388
16	ZOIDS	Martech	new	▲	1	351
17	WAY OF THE TIGER	Gremlin Graphics	4	▼	3	339
18	ALIEN HIGHWAY	Vortex	16	▼	2	327
19	FINDERS KEEPERS	Mastertronic	10	▼	11	322
20	CAVES OF DOOM	Mastertronic	12	▼	7	320

READERS'

Chart

Your chance to vote for your favourite games.

This is the second month of our readers chart where you get to vote for the games you think are best, not just the ones that make the Gallup chart. We haven't had a full month's response to our first chart but by the next issue we should have things running smoothly.

We don't want votes for games that aren't available yet, any of these will be disqualified. Last month we published the Editor's Top Ten all time favourites, this month it's Alex's turn.

There is a prize for the first form pulled out. This month we have awarded a prize of a Dk'Tronics speech synthesiser to Mr A. Watson, of Inverness, Scotland.

Don't forget to vote for the Amstrad Turkey, the worst game you've seen on the Amstrad.

Alex's All Time Top Ten

- 1 Sorcery - Virgin
- 2 Tomahawk - Digital Integration
- 3 Tankbusters - Design Design
- 4 Starquake - Bubble Bus
- 5 Equinox - Mikro Gen
- 6 Batman - Ocean
- 7 Marsport - Gargoyle Games
- 8 Defend or Die - Alligata
- 9 TLL - Vortex
- 10 Bruce Lee - Ocean

Amstrad Turkey Award -
3D Invaders - Amsoft

VOTING SLIP

You only get three votes - please use them wisely. The first form pulled from the hat wins a prize.

Game 1 _____

Game 2 _____

Game 3 _____

Amstrad Turkey _____

Name _____

Address _____

Age (optional) _____

August Chart

- 1 Commando
- 2 Rambo
- 3 Covenant

Alex says send your votes to:
169 Kings Road, Brentwood,
Essex CM14 4EF.

FLEET STREET

CITY OF LONDON EC4

Editor

PUBLISHING TYCOONS START HERE!

FLEET STREET EDITOR is designed to give you everything you need to produce professional-looking printed materials – in one package!

GRAPHICS FEATURES INCLUDE:

- Ready-made adaptable graphics library
- User-definable pens, brushes, and fills
- Variable-size enlargement and reduction
- 90 degree rotation
- Text on graphics available in horizontal and vertical planes
- Superimposed screen ruler
- Full mouse compatibility with dual cursor

TEXT FEATURES INCLUDE:

- Scrolling window for text input and page make-up
- 1, 2 or 3 column layout
- Rubber-banded text box can be placed anywhere on the page
- Variable line leading
- Right and centre justification
- Block moving of text
- Micro spacing, hyphenation, and wordwrap

The different stages in newspaper and other types of print production are represented by different 'departments' in the program. Following these stages and using the comprehensive manual will enable you to blend words and pictures to produce printed materials for a wide range of applications.

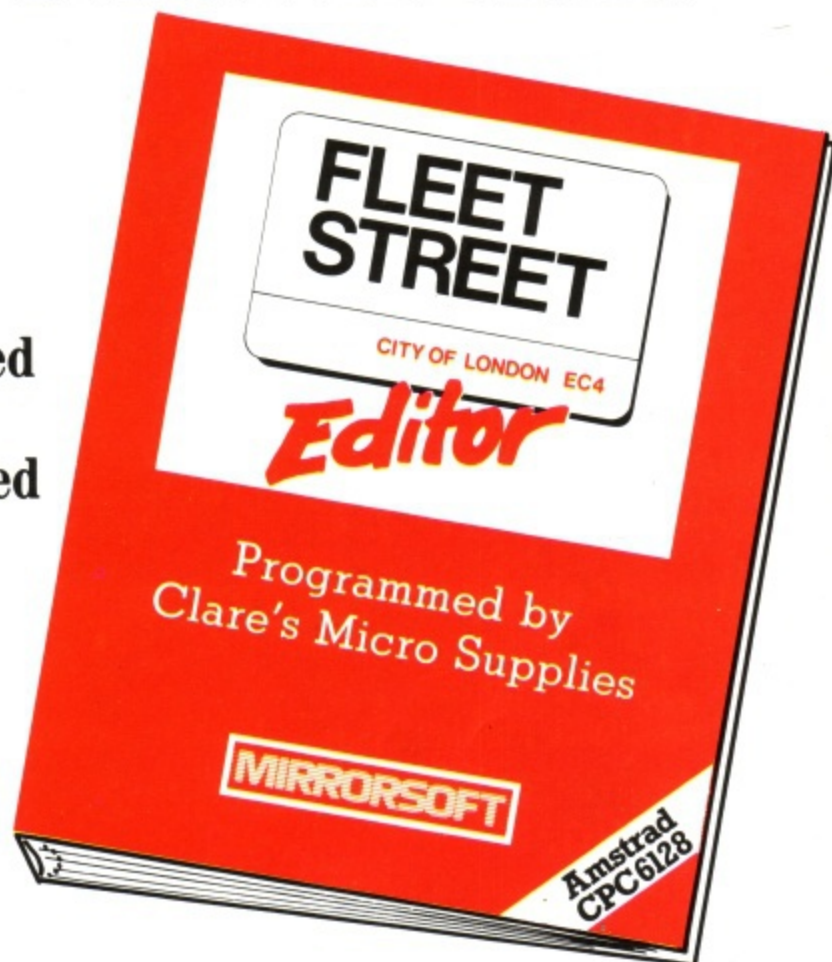

By now, megalomania should be setting in – so jump to it and get the coupon off to us for more details now!

FLEET STREET EDITOR will be available late June/early July for the CPC 6128, price £49.95 (disk only)

MIRRORSOFT

Purnell Book Centre, Paulton, Bristol BS18 5LQ
Tel: (0761) 413301

Please rush me details of Fleet Street Editor

Name

Address

..... Post code

Mirrorsoft Ltd



THE TWO MOST POWERFUL UTILITIES AVAILABLE ON THE AMSTRAD

★ UTOPIA ★

ADDS 50 NEW COMMANDS TO BASIC INCLUDING A 27 SHADE GRAPHICS SCREEN DUMP (FOR EPSON/DMP2000 PRINTERS)

FOR DISC USERS: FORMAT, COPY, DELETE, LOAD DUMP, TYPE, LIST, DEDIT (full disc sector editor) DISCCOPY, ACCESS, INFO, SAVE, SPOOL . . . PLUS MORE

FOR PROGRAMMERS: FIND, REPLACE, VARS ARRAYS, FNS, CALL, MEDIT (full memory editor), MOVE, STATUS, TOKENS, NOKEYS, C (calculator), MDUMP . . .

FOR PRINTING: GDUMP, PRINTON, CDUMP, PRINTOFF . . .

FOR ROM MANAGEMENT: HELP, HELPR, ROMOFF, ROMON, U, XROM . . .

"A powerful range of commands at a bargain price"
- Popular Comp. Wkly

**ROM
£29.95**

★ PLUS ★
USEFUL
FUNCTION
KEY
DEF'NS

"This piece of software should be held up as an example of what can be done by programmers who care it is brilliant"
- Electronics & Computing

**DISC
£26.95
ROM
£39.95**

MAXAM IS NOW RECOGNISED AS THE INDUSTRY STANDARD ASSEMBLER/MONITOR/EDITOR FOR THE CPC MACHINES, USED BY LEADING SOFTWARE HOUSES, COMPUTING MAGAZINES AND WIDELY THROUGHOUT INDUSTRY

★ **EDITOR** ★ Full screen editor of word processor standard incl find/replace, block operations, add/remove line numbers.

★ **ASSEMBLER** ★ Assemble from memory or file nested conditional assembly expression evaluation.

★ **MIX MACHINE CODE WITH BASIC** ★ Source code in a basic program - assembled, run and tested from basic.

★ **PLUS** ★ Unlimited breakpoints, disassembler, memory editor, relocater, memory search and much more!!

**24 HOUR HOTLINE
ACCESS VISA
01-688 6223**

★ MAXAM ★

Arnor Ltd 118 WHITEHORSE ROAD CROYDON CR0 2JF



**HAIKY
HACKERS
HAUNT**

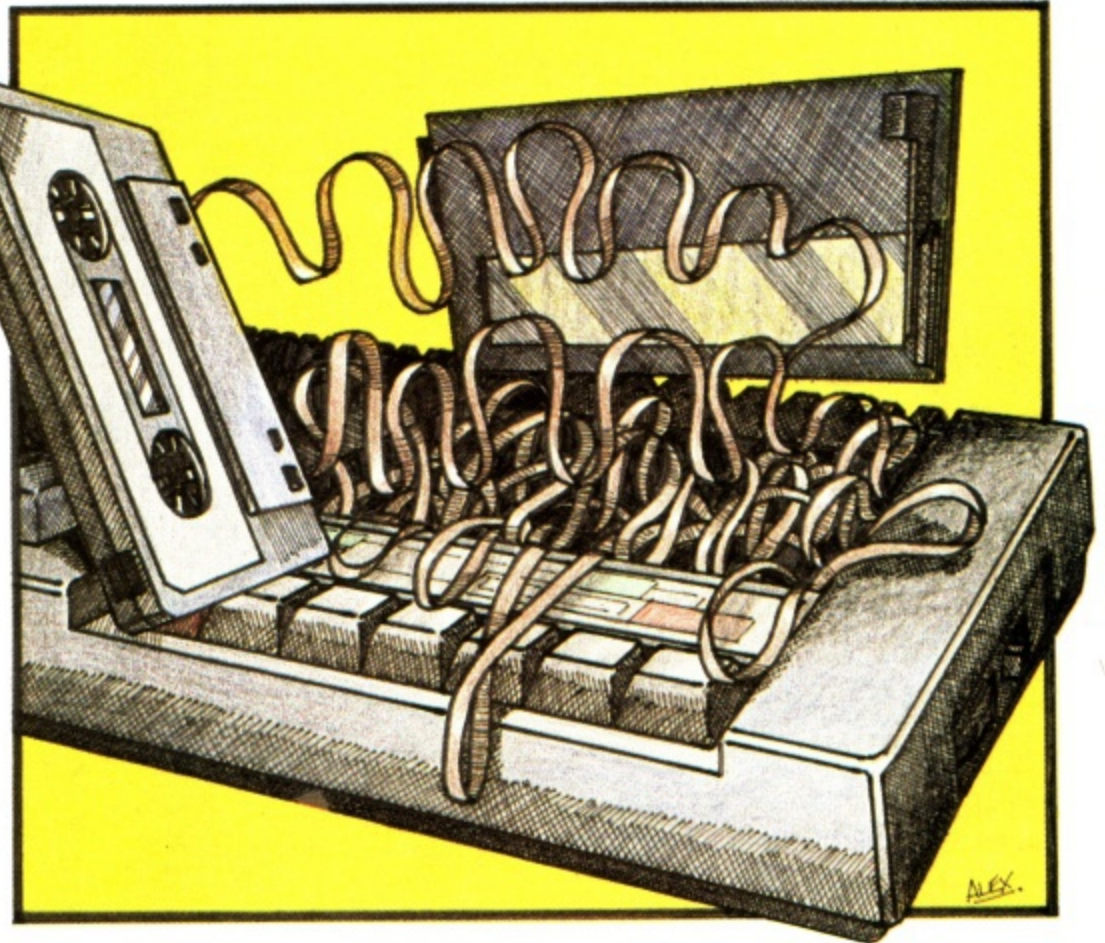

Printers, pokes and proggyettes

**VAX, the man with the axe
carries on his mad hacking**

As I sit here, among the mugs of soup, beer cans, pussycats and old copies of *ACU*, I study my joint (the one I have just made with my soldering iron) and rejoice. It is now three months and the Runcorn Hospice for the Slightly Bonkers have not tracked me down yet, so prepare to endure another column by the Hairy Hacker. Serves you right for buying *ACU*, dunnit?

Nonterraqueous has been about for a little while, and so has this poke, sent in by someone who can't spell infinite (sic). Don't forget to wind past the loader:

```

1 REM Cheers to P.R. Fowler, from yonks
  back.
10 INK 0,0: BORDER 3: MODE 0: OPENOUT "!" : MEM
  MORY 2999: LOAD "!" : 3000
20 CALL 3003, &FFFE, 16383
30 CALL 3003, 40956, 37000
40 POKE &1E0B, 0: REM Infinite bombs
50 POKE &1080, &C3

60 POKE &1081, &97
70 POKE &1082, &10: REM Infinite psyche
80 POKE &10BA, 0
90 POKE &10BB, 0
100 POKE &10BC, 0
110 CALL 4000
    
```

As happens from time to time, this type of infinite lives poke can kill you. That is, you can get caught in a situation

that would normally kill you outright, but now keeps on killing you until your Z80 decomposes.

Now a little proggyette to churn all the output to the screen out on a printer. This means everything, including control codes, so when the screen clears you will get a form feed. You run it (save it!) and then use `ISPON` and `ISPOFF` to turn the screen print on and off. I'll let you figure out which does what:

```

1 REM * Screen to printer program.
2 REM * Written in desperation, BASIC &
  Z80 by VAX.
3 REM * Use ISPON to start printer,
4 REM * and ISPOFF to stop it.
5 REM * Mups! Didn't mean to tell you t
  hat.
6 REM
9 OPENOUT "id": MEMORY HIMEM-1: CLOSEOUT
10 MEMORY HIMEM-112: i=HIMEM+1: REM *** A
  ddress for patch
15 ini=i
20 READ a$: IF a$="END" THEN CALL ini: END
30 IF a$<>"*" THEN POKE i, VAL("&" + a$): i=
  i+1: GOTO 20
40 READ a$: v=ini-&4000+VAL("&" + a$)
45 IF v<0 THEN v=1+NOT v
50 POKE i, v-256*INT(v/256): POKE i+1, INT(
  v/256)
60 i=i+2: GOTO 20
1000 DATA 01,*,400a,21,08,00,09,c3,d1,bc
1010 DATA *,4016,c3,*,4020,c3,*,403c,00,
  00,00,00,53,50
1020 DATA 4f,ce,53,50,4f,46,c6,0,21,d9,b
  d
1030 DATA 11,*,406c,cd,*,402f,21,d3,bd,1
  1
1040 DATA *,4060,06,03,4e,1a,eb,71,12,eb
1050 DATA 23,13,10,f6,c9,21,*,4060,3e,c3
1060 DATA 77,23,11,*,4059,73,23,72,21
1070 DATA *,406c,3e,c3,77,23,11,*,4063
1080 DATA 73,23,72,c3,51,bb,e5,f5,cd,2b
1090 DATA bd,f1,e1,c3,*,4059,e5,fe,1f,f5
1100 DATA dc,2b,bd,f1,e1,c3,*,4063
1110 DATA END
    
```

Hackers may be interested in line 45, which has my version of how to stop a well-known problem with Basic. All hex

numbers above &8000 get turned negative when you un-hex them. My bit turns them positive in a cryptic fashion.

For those with hacked joysticks, here are a few second-fire pokes:

Soul of a Robot:

```
10 INK 0,0:BORDER 0:INK 1,24:INK 2,12:INK
K 3,6:OPENOUT"":MEMORY 999:LOAD "!",1
000:CALL 1003,&FFEE,16383:CALL 1003,4
1500,40000:POKE 8083C,&10:POKE 80844,
&4D:CALL 2000
```

This puts your jump increase or decrease on the second fire button.

Covenant:

```
10 MODE 0:MEMORY 4999:LOAD"!COVENANT":PO
KE &2C12,&4D:POKE &2C76,&4D:POKE &2D9
F,&4D:POKE &2D0B2,&4D:CALL 10887
```

That one lets the score screen switch out on the second fire, so that you can boost your ego more regularly. If anyone is interested in converting the Quickshot II joystick to dual fire, drop us a line and we may make an article of it.

Now here's some stuff from a hacker who really knows where his breakpoints are, none other than Stewart C. Russell of Glasgow, d'ye ken? His contribution to the column rates the accolade of Hack of The Month. So, Stewart, send a letter by Royal Snail to me at The Hairy Hackers Hovel and tell us what games tape you would like as a bribe, er, reward.

Any rookie hackers reading this might like to try their luck next month, eh?

Winning the easy way

The hack in question is a little life-lifter for Who Dares Wins II. To use it, RUN the tape as per normal. Stop it after the peedleplung noise and hit Esc. Type or load the following program (without resetting it, twit!), RUN, and all will carry on as before but with an awful lot of men and grenades. Now any wally can make it to the enemy HQ. Here's the clever bit:

```
80 REM The first hack of the month to
90 REM Mr. Stewart Russell.
100 MODE 1
110 FOR s=0 TO 46
120 READ aS
130 POKE &C7D0+s,VAL("&"+aS)
140 NEXT s
150 CALL &C7D0
160 DATA 21,40,00,11,30,60,3e,63,cd,a1
170 DATA bc,d4,00,00,21,70,60,11,90,50
180 DATA 3e,11,cd,a1,bc,3e,00,32,c1,60
190 DATA 3e,00,32,1a,63,c3,10,a0,53,43
200 DATA 52,33,2f,32,2f,38,36
```

By the way, this one doesn't get on well with Maxams and the like. You will doubtless hear more from the hacking Scotsman, he has many more POKES in his sporran (almost a poke hero, geddit? Poke, sounds like folk. Never mind).

Some of you may have acoustic couplers on your modems. If you have a Hayes-compatible, auto-dial, auto-answer, self-scanning, WS4001 thing, go read a more upmarket column, otherwise here are some tips.

Put it on top of a towel. All hackers have to know where their towel is. Towels are immensely useful things, you can wrap them round you for warmth, put them round your head to ward off the ravenous Bugblatter Beast of Traal or even dry yourself with them. They also stop vibrations travelling through the table from heavy lorries, furious pounding at the keyboard and eggs exploding in the microwave, up into the modem.

Pubs leave just the right sized towels on top of the bar, but have the courtesy to buy a pint or two first (before asking, of course).

Well done ZZ

This is something from that highly professional poker ZZKJ, who really knows where his towel is. This month his offering to the Great God Glitch is a way of mangling Fairlight. It don't mean taking an axe to your synthesiser.

This little program should solve any problems you may be having with the game. These are the options which it gives you. First, no loss of energy from contact with the bad guys, none of the doors are locked anymore and there are no longer any carrying weight restrictions. Although you can still only carry five items, these can be anything - even five barrels (they weigh a tun).

The next option, which is my favourite, allows you to see the rooms as they are being drawn. This makes the game look less like it's crashed and you can see that Bo has got one hell of a fast fill routine! Next is the option to blindfold the baddies, which means they wander around completely oblivious to your presence, or do nothing if they normally chase you.

The last pokes make the list of objects shift over to the left hand side of the screen for those who prefer to have all

your character's info in one place. The only problem with this is that the start up screen listing your control keys gets shifted to the right a bit. So, when the game starts up and you notice the screen is not as it should be, don't panic!

Here's the business end:

```
10 'FAIRLIGHT HACK BY ZZKJ for ACU.
15 'DULY SNAFFLED FROM THE ED. FOR THE
16 'HAIRY HACKERS COLUMN
20 OPENOUT"D":MEMORY 1660:MODE 1:INK 0,0
30 INK 1,2:INK 2,25:INK 3,6:BORDER 0
40 LOAD"!PIC",&C000:LOAD"!FCD",1661
50 FOR N=40000 TO 1E+09:READ AS
60 IF AS="END" THEN CALL 40000,1267
70 POKE N,VAL("&"+AS):NEXT
80 DATA A4,5A,5A,4B,4A,21,40,9C,11,5F
90 DATA 9C,06,43,1A,CB,41,2B,03,86,18
100 DATA 01,AE,12,1C,10,F3,23,0D,F2,48
110 DATA 9C,84,F8,A5,54,F8,E9,A4,6E,D4
120 DATA 08,3F
```

```
130 DATA BD,63,B9,25,82:'NO ENERGY LOSS
140 DATA 84,AE,F0,B5,A7:'NO LOCKED DOORS
150 DATA BD,A7,B9,49,FE:'NO WEIGHT LIMIT
160 DATA BD,AC,B9,17,97:'SEE ROOM DRAW
170 DATA 84,33,FF,B5,AC:'BLIND BADDIES
180 'THE NEXT THREE LINES OF DATA MOVE
190 'YOUR LIST OF OBJECTS TO THE LEFT
200 DATA 84,6E,DE,B5,83,4E,B5,06,A4,E8
210 DATA 33,08,2C,5B,0D,4F,08,FC,B6,4C
220 DATA A0,08,2C,0D,87,5B,08,FC
230 DATA AE,6F,DE,END
```

Anyone typing this into a PCW8256 is going to have fun trying to load the tape.

In the usual way, key it in, save it for future use and delete any lines containing any features you don't want. For instance if you don't want all doors unlocked, delete line 140. If you don't want to have the objects on the left, delete lines 180 to 220 inclusive. You can delete as many of the program's features as you like, as long as you don't touch lines 10 to 120 and line 230. When you have all that you want, just RUN the program and play the tape from the start. The game will now load and play as normal - except for the added features.

Two quickies before I go. Number one is from Colin at Firebird, who says that if you hold the keys T H I N G down, you get a much better survival rate. Quickie number two is that the same happens in Three Weeks in Paradise if you hold down the keys K A T H. Does anybody else know any more like this that they wish to share?

Well, that's all folks! (© 1957 Looney Tunes Ltd). I leave you with the verbage off the sticker on my BT approved modem: Hackers do it down a 'phone line.

ACU

ocean

**WORLD PUBLISHER OF
COMPUTER SOFTWARE
OFFERS YOU A GREAT
CHANCE TO**

KEY INTO SUCCESS

With tremendous opportunities for
FIRST CLASS PROGRAMMERS

in the fields of
SOFTWARE DEVELOPMENT
PROGRAM TRANSLATION
GAMES DESIGN

Expansion in all the Group's activities
requires constant HIGH QUALITY SOFTWARE
and we now

URGENTLY REQUIRE

products for Autumn/Winter 1986.
If you would like to work with the Best for
Maximum Reward either Directly or on a
Freelance Basis contact in confidence:
Software Development Manager

ocean

6 Central Street, Manchester M2 5NS.

Tel: 061 832 6633 Telex: 669977

Completed programs also wanted for:
SPECTRUM · AMSTRAD · COMMODORE 64 · C16
ATARI · BBC and ELECTRON Micros

Cash or Royalty Payments · Immediate Decision

CONTACT US TODAY!

AMSTRAD 3" DISKETTES

LARGE STOCKS AVAILABLE



SUPERCALC 2
£45 INC PLUS
1 FREE PRINTER
RIBBON OR 1
FREE DISK

PCW8256
RIBBON
£5.95 EACH
INC

FREE NATIONWIDE DELIVERY



24 HOUR
CREDIT CARD
HOTLINE

0273 726331 (10 Lines)

ACCESS AND VISA CARDS ACCEPTED

Special offer subject to availability.
1 free offer per order.



**SBS
Data Services Ltd**

Unit 3, Clarks Industrial Estate,
Newtown Road, Hove,
East Sussex BN3 7BA.
Telephone: Brighton (0273) 726331
Telex: 878226



**If you want to update
your office, here's a tip.**

The electric typewriter's days are numbered.

Because now there's a machine that puts real wordprocessing power within everyone's reach.

The Amstrad PCW 8256 is a complete wordprocessor and a powerful computer in one unit.

And its unbelievably low price includes a screen with built-in disc drive, keyboard, printer and wordprocessing software.

— **It's a complete wordprocessor** —

The PCW 8256 is totally equipped for wordprocessing. It has a high resolution screen with 90 columns and 32 lines of text.

That's 40% more usable display area than most PC's.

There's a high speed RAM disc that allows you to store and retrieve information instantaneously, as you're creating a document.

There's also an optional combined serial and parallel interface that gives you access to modem, additional printers and other peripherals. And you can even add an extra 1 M byte drive.

— **Training** —

The PCW 8256 comes with a comprehensive user guide that tells you, in simple language, how to master its wordprocessing and computer capabilities.

But if you want to get to grips with it even quicker, there are now a great number of training courses available throughout the country.

— **On-site maintenance** —

Amstrad computers are exceptionally reliable.

But many business users find it reassuring to know that nationwide on-site service and maintenance contracts can be arranged.



The 82 key keyboard is specifically designed for wordprocessing. Its special function keys allow you to refer to 'pull down' menus as you work, so you don't have to memorise complicated codes.

And the PCW 8256 has an integrated printer with compatible software that gives you a choice of letter quality and high speed drafting capabilities.

Finally, there's an automatic paper load system, as well as tractor feed for continuous stationery.

— **It's a powerful computer** —

The PCW 8256 is also a purpose built computer with an enormous 256k memory.

For computer buffs, the Mallard basic, Dr Logo and GSX Graphics system extensions will mean you can write your own programs.

All of which puts the ordinary office typewriter firmly in its place.

The place featured on the opposite page.

Please send me some more information about the PCW 8256

Home user Office user (Please tick)

Name _____

Address _____

Tel: _____

Company _____

Amstrad PCW 8256

Amstrad, P.O. Box 462, Brentwood, Essex CM14 4EE.

Tel: (0277) 230222.

ACUB/86

Now you can connect your CPC to a whole host of musical instruments. David "Dolby" Radisic looks at the Midi interface from Electromusic Research

Making sw

The computer world has RS232, a standard which means that any bit of equipment can be connected to any other. Even if it isn't standard most computers have an RS232 interface as an option.

The music world has its own standard – Midi, which stands for Musical Instrument Digital Interface. Midi instruments can be networked, so that they can all be controlled from a central computer. This may mean that you can play a drum machine from a synthesiser keyboard or one keyboard from another.

Going on first impressions Electromusic Research, who designed the EMR Miditrack, have done a very good job. Although I have come to disregard first impressions I was not wrong with this interface and software. I thought the manual was very brief and didn't really go into enough detail in most areas, but

they do tell me there is a booklet which does just that, called Midi, Micros and Music, which gives a good description of using Midi instruments with computers.

What you get

The interface consists of two small plastic boxes connected through a small length of ribbon cable. This allows the main interface to lie flat on the table without putting too much strain on the micro's edge connector. It also solves the problem of designing a box which fits the back of a 464, 664 and 6128. Unfortunately there is no through connector so the interface cannot be used with a 464 and disc. I suppose that EMR assumes that

if you have a 464 you will be using the tape-based software.

After setting up the interface and turning on the computer, and of course running the software, just to see what happens, an orange, pink, blue, black and white screen appears containing six windows and a flashing right-facing-arrow (the cursor).

In the square window . . .

The layout is neat and tidy with the bottom of the screen contain-



Sweet music with Midi

ing a wide three-line Response window giving information on all that happens. If a directory is asked for, rather than the complete directory whizzing through a line at a time is displayed and a key press steps to the next line giving you time to read each entry – very neat.

The left-most window has six columns of information for each of the eight tracks. This includes, from left to right, Play which sets whether the track is being used or

set to "mute" (off) and Channel, which allows each of the tracks to be set to an individual Midi channel. This means the data will be sent to only those instruments set to that particular channel, that is, instruments could receive exactly the same data or entirely different data from each of the other instruments depending on their channel settings. A four-channel polyphonic synth, for instance, could have four individual tracks playing different voices or combinations of tracks to give an orchestral effect.

The next in the line-up is Loop which is very good for base-lines

or rhythm generators as a track can be set to loop either a number of times – from once to 254 times – or set to loop continuously. The Control feature can be used to select what type of information is retained from your Midi instrument. If you happen to be one of those lucky people who have access to a DX1 with pressure sensitive/after touch and all that, then you can select to save everything (this does however eat up the memory very quickly) or to save on memory store just the notes played. Pitch follows Control and is a very nice feature allowing transposition, if your instrument can handle it, of notes in a nine octave range in steps of between -12 and +12 semitones.

The last column in this window isn't selectable by the user and is only used during Playback or Record mode and shows which tracks are in operation by flashing



a blob opposite the track number.

Below this Track window appears two smaller windows showing the amount of free space available for storage. The manual says 8100 notes can be stored with no velocity and 6500 with velocity – pretty good going. The other small window shows the Stopbar or last bar in current Playback or Record. This can be anywhere from 1 to 999.

The right part of the screen consists of another window, split in two. The right-hand half holds the selections for disc or tape such as directory, verify, load and save data. The left section contains a Metronome which, unlike Rainbird's TMS system, doesn't act like a real metronome swinging to and fro, but you can't have everything! This can be set up to output to Midi channel 1 at any velocity and pitch setting.

Count-in – obvious really – gives up to nine beat count in (you know, a-one a-two a-three altogether now . . .) Below this is a clock which doesn't tell the time but has selection for connecting an external clock (Sync-out signal) from any Midi interface, or you can stick to the internal EMR clock. Tempo settings allow between 40 and 360 beats a second, Plays enables the composition to be played from one to 254 times or (if set to 255) can play continuously. The Time signature – another obvious one – can be set from 1/4 timing to 9/4 timing. Last in the window comes Start bar which allows you to start playing from any bar from 1 to 999.

Up and running

Well, that's the layout and operation of the software dealt with. Now let's get down to the nitty-gritty of using the stuff. Linking up the EMR to my Roland JX3P was quite easy, although the 5-pin DIN leads I had were mirror wired whereas the EMR manual says "The wires should not be mirror wired". A quick trip to my local Tandy shop sorted that problem out. Once this was all connected (my set-up included a drum machine and bass line unit) I went through the "getting started" section of the manual

that mainly relies on three demos included on the disc. These include Spycatcher by Mike Beecher, Sky by Mike Beecher again, and a little tune that my set-up couldn't do justice to as much as it tried – Beethoven's Moonlight Sonata.

Each of these has a small piece of text displayed in the lower window explaining what each of the eight tracks were set up for. Beethoven consists of tracks 1 and 2 followed by 3 and 4 set up for the piano solo, track 5 for the double bass, track 6 for the flute, 7 for strings and 8 for the brass. My little trio of instruments played together very well with



the JX3P doing each of them individually but because I had no eight-track recorder I didn't get to hear them all together. Why couldn't anyone have lent me more synths, such as the DX1?

After about an hour of listening to individual tracks and messing about with the demos I decided to venture into deeper water and try my own compositions. Now I'm no Peter Gabriel or Jean Michel-Jarre but I got some very good music out of it all, especially when I got the hang of the Arrange function. This enables you to make up to 64 different arrangements of the tracks for recording. Because this was such a nifty feature I decided to try and scrounge a multitrack recorder off one of my friends. I managed to find a four-track – better than nothing I suppose – and started

recording my compositions almost immediately. The Arrange feature gave me the ability to record pieces which were longer than I had actually played, by allowing me to make different arrangements from each of the tracks. It is a very interesting feature and I used this quite a lot.

There is another feature I found that I thought was needed – especially with my playing – Time correction. This corrects the length of notes as they are recorded and so the playback sounds a lot better.

Having considered this a great deal I have just thought of a nice addition to the EMR range – a track editor. One thing I found was that if I mis-keyed I would have to start playing from the beginning but if an editor was available then changing individual notes would be easy and also this would mean a printout of the music could be made which could even lead to full Fairlight CMI capability. Oh well, the system as it stands is a very good one and gets 10 out of 10 from me. I look forward to any future products from EMR as they are bound to be as good as, if not better than, the Midi.

I certainly enjoyed using the system quite a lot and didn't really want to part with it upon finishing the review – I will definitely buy one now. So the only conclusion I can come to is that if you're looking for a Midi for your Amstrad this is a very good set-up and works very well with Rolands and Yamahas. I didn't get the chance to test anything else myself but the Midi standard should ensure that everything else will work. The end result I had was some very good compositions.

The EMR Miditrack is available from Electromusic Research, 14 Mount Close, Wickford, Essex, SS1 8HG. (0702) 335747. The interface and software costs £129.95.

The other equipment was kindly loaned by Monkey Business, (Musical Equipment), 66 Victoria Road, Romford, Essex RM1 2LA (0708) 25919.

SUPERPOWER

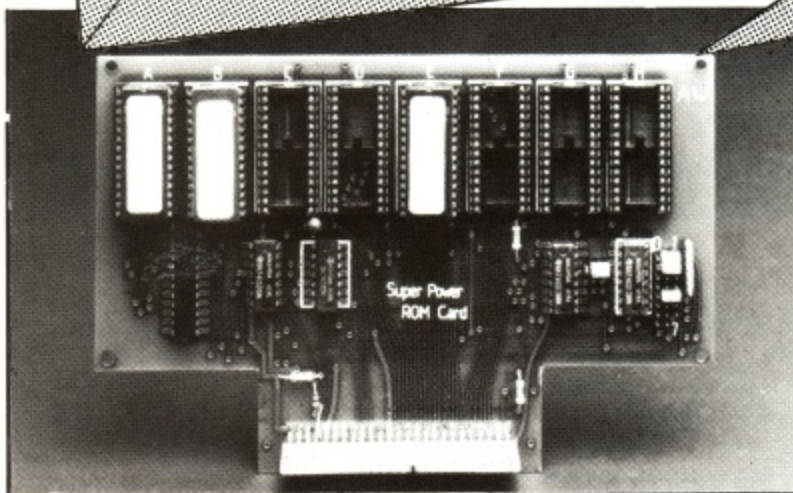

NEW Bigger, Better ROM-CARD
NEW 'Lightning' Assembler Package
NEW Staggering Price Reductions
NEW Disc-based programs
NEW 6128 and 664 versions

NEW SUPERPOWER ROM-CARD

Eight sockets, addressable 0 to 7, 8 to 15, 16 to 23 etc.; cased unit plugging neatly to expansion port; through connector.

ASSEMBLER, DISASSEMBLER & MACHINE-CODE MONITOR

Over 30 commands in both Assembler and Monitor. Tokenised source code accelerates development time. Assembly at 24000 lines per minute (as many as 8 times faster than competition); large source and object files can be held in memory. Disassembled files can be edited and re-assembled. Comprehensive Monitor with Single-step, conditional breakpoints etc. Rom version held in two 16K chips.

PROGRAMMER'S TOOLBOX & BASIC EXTENSIONS

DIRECT COMMANDS — Character; Compact; Editor; Find; Kill; Medit; Picture; Soundlab; Tidylis; Xref.

PRINTER COMMANDS — Cdump; Dump; Echo.on; Echo.off; Ltron; Ltroff.

GRAPHICS COMMANDS — Circle, Turtle.
 (CPC 464 Additional. Fill. Graphics Paper/Graphics Pen. Frame. Mask.)

SCREEN COMMANDS — Double Height; Underline; Normal; Page.on; Page.off; Screen; VDU.

FILE COMMANDS — Baud; Info; Unprotect.

GENERAL COMMANDS — Assemble (simple assembler within Basic); Keyboard; Roms; Tune.

SUPERPOWER DISK USER'S UTILITIES

Program allows detailed inspection and modification of information held on disk and is of particular use for recovering data from corrupted disks. Individual sectors can be read from and written to. All data can be output to the screen and/or printer. Program also contains a number of functions of use to assembly language programmers.

TABULATE DIRECTORY: Displays directory and enters EDIT mode. **READ DISK SECTOR:** Read sector and enter EDIT mode. **LOAD DISK FILE:** Load first sector into buffer and remainder to memory for fast access. Enter EDIT mode.

LOAD ROM: Catalogues resident roms, prompts for rom selection and enters EDIT mode. **EDIT MEMORY:** Displays current buffer. Data displayed is Buffer Address, Hex and ASCII. Comprehensive editing facilities. 'COPY' key gives Intelligent

Data Copy. 'TAB' key gives printer output. **WRITE:** Write sector to disk. **DISASSEMBLE:** Disassembles code from specified address, giving address, object code, mnemonics and ASCII. Screen and/or Printer output. **SEARCH MEMORY:** Search sector or a complete file for ASCII string or series of Hex codes. **UTILITIES:** Includes Format, Hex/Decimal conversions, jump calculations etc. **SCREEN UTILITIES.** Select from four display modes; choose background and foreground colours.

MAILING LIST AND CLUB MEMBERSHIP PROGRAMME

Program handles thousands of name and address records (label and non-label fields). Twenty classification indicators make possible sophisticated selective examination, counting and printing of records. Alphabetical order is dealt with on data entry, allowing user to select 'key' word. Works with single and double disks as well as cassette.

Main Commands . . . **ENTER:** Data entry(*). **GET:** Load new file. **COUNT:** Selective Count. **FIND:** Find 'Name' or any String(*). **LIST:** List current file on screen(*). **PRINT:** Print label data or whole records selectively. **MERGE:** Merge and Sort files. **SAVE:** Write a file to disk or cassette. **RESET:** Reset colours, label sizes, class definitions, string constants etc. (*Editing facilities available).

NEW SUPERPOWER ROM-CARD	ONLY £34.95	
Original Rom-Card (464 only)	£25.00	
SUPERPOWER SOFTWARE	ROM	DISC
Assembler, Disassembler, Monitor (ADM)	£29.95	£29.95
Programmer's Toolbox & Basic Extensions	£19.95	£19.95
Disc Users Utilities	£19.95	£19.95
Mailing List & Club Membership	£19.95	£19.95

HOW TO ORDER: Phone or Write to:

Micro Power Ltd.,
 Northwood House, North Street,
 Leeds LS7 2AA
 Tel: (0532) 434006/458800

Also available from Dealers.
 Ring for latest catalogue and nearest stockist.

WHEN ORDERING PLEASE NOTE:
 There are different versions of the Roms and Discs for each machine. State, therefore 6128, 664 or 464! Please add 0.75p per order Post & Packing.



Great News from GARWOOD

We have added more than 25 new products to our free Catalogue of Amstrad Business Software & Supplies

Trade enquiries are now handled through our sister company Garwood Distribution Ltd.

☎ Chelmsford (0245) 460788 (3 lines)

Telex: 99468 GARWD G

Freepost: Garwood (Wholesale) Ltd, Freepost, BRENTWOOD, Essex, CM15 OBR

Unbeatable Service. Quality Branded Goods

CP/M Software on 3" Disc (Amstrad PCW8256/8512 & CPC6128)

FINANCIAL MODELLING:

POCKET CALCSTAR	£39.95
SUPERCALC 2	£49.95
CRACKER 2 (with graphics)	£49.00
MULTIPLAN	£69.99
SCRATCHPAD + FREE SMARTKEY	£69.99

WORD PROCESSING:

NEW WORD 2 (Mailmerge & Spelling Checker)	£69.00
POCKET WORDSTAR (with Mailmerge)	£49.95
POCKET WORDSTAR DELUXE (MailMerge & Spelling Checker)	£69.00

SPECIAL:

MICROFILE/MICROWORD (+ Mailmerge)	£49.95
MICROFILE TEMPLATES	£29.95
FLEXILABEL	£29.95
BRAINSTORM	£49.99

PROGRAMMING LANGUAGES:

DR PASCAL/MT+	£49.95
DR CBASIC COMPILER	£49.95

GRAPHICS:

DR DRAW	£49.95
DR GRAPH	£49.95

ACCOUNTS/PAYROLL:

AMSOF ABCS (from £33)		Details on application
CAMSOF (from £49.95)		
M.A.P. (from £49.00)		
SAGE (from £69.99)		
CASH TRADER	£99.95	
CASH TRADER with ANALYSER	£149.95	

DATABASE MANAGEMENT SYSTEMS:

CAMBASE (CPC6128 only)	£39.00
CAMBASE 2	£49.95
CARDBOX	£99.99
CONDOR	£69.99
DBASE II	£119.00
DELTA	£99.95
POCKET INFOSTAR	£69.95
POCKET SUPERSORT	£49.95
SAGE RETRIEVE OR MAGIC FILER	£69.99

COMMUNICATIONS:

SAGE CHIT-CHAT RANGE (from £69.99)	Details on application
------------------------------------	------------------------

TRAINING:

TOUCH 'N' GO	£24.99
IANKEY Crash Course or Two Fingers	£24.95
AUDIO TUTORIALS (inc. Locoscript, Newword 2, Supercalc 2, Multiplan, and CBasic)	£ 9.95

SPECIAL OFFERS

FREE ACCO LIBRARY FILE (worth £3.33) with every Software Order

FREE PCW8256/8512 DUST COVER SET (worth £11.45) with every Software Order over £100 OR 2 pieces of software ordered

NEW PRODUCT Superb Quality PCW8256/8512 Dust Cover Set £11.45

Branded 3" Compact Discs

Single Sided (reversible), Double Density CF2 - Box of 10 **£36.95** Double Sided, Quad Density CF2-DD - Box of 10 **£59.50**

SPECIAL OFFER - 10 CF2 Discs **£34.50** when ordered with software

DISC STORAGE AND OTHER ACCO PRODUCTS

ACCO disc storage box (holds up to 50 3" discs) **£19.95**

ACCO Library file (holds 7 3" discs) **£3.33**

UNIQUE **ACCO** EASYSTRIP (for clean separation of perforations) **£11.38** or **FREE** with Printer Stand

ACCO Screen Filter **£37.67** **ACCO** Printer Stand **£42.15**

RIBBONS

DMP1 **£3.95** (5 for £16.95)

DMP2000 **£5.50**

PCW 8256 **£5.50**

COMPUTER LABELS

FULL RANGE OF SIZES IN STOCK e.g. - 1,000 3¹/₂" x 1⁷/₁₆" LABEL TRACK IN FLIP TOP DISPENSER - **£5.75**

- 2000 3¹/₂" x 1⁷/₁₆" LABEL TRACK (2 ACROSS) IN PLASTIC TRAY - **£11.00**

LISTING PAPER

WE STOCK A FULL RANGE OF LISTING PAPER AT HIGHLY COMPETITIVE PRICES

e.g. 2000 Sheets of 11" x 9¹/₂" 1pt. 60g. Plain with micro perforations **£14.95**

ALL PRICES INCLUDE VAT & POSTAGE

Special Offers Close 2nd August



Garwood Software

A member of the Garwood group of companies

Registered Office: 45 Plovers Mead, Wyatts Green, Essex CM15 0PS



Amstrad Business Computing

The supplement for Amstrad Business Computer Users

Free
August 1986
Volume One
Number Nine

Regiment your files – DIR exposed



Multiplan: Friend or foe?
Public domain – more for less
Teach yourself Supercalc, reviewed
New accounts software on the MAP



The Database Manager and Reporter.

You know that Caxton only publish superior software products. Cardbox is the world's best-selling simple electronic card index. BrainStorm is the world's first ideas processor. ScratchPad plus is the only enhanced Virtual Memory Spreadsheet available for your Amstrad. And Touch 'n' Go is the UK's most highly respected disk-based typing Tutor.

Now we present Condor 1 – Mainframe computing for your Amstrad.

Condor 1 is an extensive database management and reporting system for the non-programmer. You can begin by creating simple databases in a matter of minutes. Then, as you learn more with our comprehensive step-by-step tutorial and reference-guide, Condor 1 gives you the power to create all-singing, all-dancing, menu-driven systems.

You will enjoy using Condor 1. You design the screen layouts yourself and then manipulate the information you've entered through a series of English-like commands – For example "sort invoices by value". And with thirty-five commands as standard, Condor 1 should be flexible enough to satisfy all of your data-management requirements.

Finally, don't forget Condor 1 is a Caxton Product. This means it's so simple to use we are able to offer you FREE and UNLIMITED telephone support. Should you need help with Condor 1 just call us.

Your call will be welcomed and your query will be answered in a pleasant, helpful and efficient manner – because that's the sort of people we are.

**Condor 1
is £99.99
(inc VAT).**

Available for
Amstrad 8256
and 8512.



Caxton Software Limited
10-14 Bedford Street
Covent Garden
London WC2E 9HE
Tel: 01-379 6502.
Telex: 27950 ref 398

The Condor 1 Commands – They couldn't be simpler!

Database Creation and Maintenance
DEFINE Create, redefine or describe a database
DESTROY Eliminate a database or file
FORMAT Create or revise a form or HELP screen
REORG Reorganize the structure of a database; add or delete items

Information Input and Update
APPEND Attach records of one database to another
EMPTY Eliminate all data in a database
ENTER Insert new data into a database
POST Update entries in one database with those from another
UPDATE Change entries in a database meeting specified conditions

Information Processing and Report Writing
COMPARE Compare entries in two databases for (not) matching conditions and create a RESULT database
COMPUTE Compute entries in a database
LIST Display database records in sequential order
PRINT Print database records in sequential order
PRINTER Printer output control and redirection
SELECT Select database records meeting specified conditions, creating a RESULT database
SORT Sort database records by entries
STAX View or print statistics of entries
TABULATE Summarize specified entries. Print or save the result
TITLE Print report headings

Operation Aids
HELP Assist operator in selecting procedures
INSTALL Saves SET and PRINTER options
RESTART Continue processing interrupted commands
RUN Process and execute a command procedure with options for command modification

Interfaces
READ Transfer records from an ASCII file to an existing database
WRITE Transfer records from a database to an ASCII sequential file

Utilities
COPY Copy a database or file
DATE View or enter date
DIC View entries in the data dictionary
DIR View the list of files in the disk directory
LOGDISK Log a new disk in the computer
RENAME Change the name of a database or file
SAVE Save a RESULT database
SET Set operating parameters
SYSTEM Exit from Condor 1 back to operating system
TERM Defines the computer (not needed on Amstrad)

At last - our very own staples!

Judging by your letters you're all going to be very pleased by this month's news - *Amstrad Business Computing* is going it alone. With a smart new logo to highlight our smart new name - *Amstrad Professional Computing* - and our very own staples, *APC* will be seen standing proud on newsagents' shelves throughout the land.

This move towards independence is justified by the huge interest in using the Amstrad machines for business. *APC* is just the magazine to satisfy this new and diverse market's hunger for information.

The early computers were the province of enlightened, spotty-faced youths who had a penchant for things technical. The serious computing market is dominated by people who are using computers for all manner of useful tasks, often employing software which is as complex as it is powerful. The PCWs, especially, aren't only used in place typewriters. They also run spreadsheets, databases, statistics packages - and even games.

The PCW is the model of diversity. It can be found in the strangest of places performing the weirdest of jobs - doing field work in the Arabian Desert or converting analogue signals in the North Sea. Have PCW will travel.

The diversity of uses to which Amstrad 6128s and PCWs are being put makes for an interesting life, magazine wise. The scope for *APC* in the future is nothing short of fantastic. Already it seems quite clear from the survey forms that have been returned that there is a great deal of interest in activities beyond the day to day applications. Many of you want to learn more

about the different programming languages, about new ways in which your machine can be used, and about the fascinating world of computer communications. Perhaps even more surprising is the underlying interest in computer games.

Introducing you to all these topics will be *APC's* pleasure. But at the same time we recognise the one single factor which separates the Amstrad user from other business computer users - an Amstrad is a powerful machine but the users are in the main novices.

There may be a strong desire to learn more about computing but there is no escaping from the fact that we are dealing with a complex and jargon-ridden world. It's going to be very difficult presenting subjects pitched at a level to satisfy all of our readers but this has to be a case for applying the lowest common denominator.

The extra space we will enjoy as a magazine in our own right means that we can go on from just introducing subjects to running comprehensive courses over a number of issues and presenting product reviews which are designed to draw easier comparisons with reviews published in earlier issues.

One last point before I set off to slave over a hot keyboard trying to fill all the extra pages - if you haven't sent in your completed survey form from last month's issue of *ACU*, please do so. We don't just put them into a rusty filing cabinet, you know - we use them to get a better understanding of your interests.

If you want to influence the contents of *APC* then the survey is one of your opportunities for doing so.

Jeremy Spencer

CONTENTS

III	EDITORIAL <i>The news you've been waiting for.</i>
V	SUPERCALC MADE EASY <i>Let the computer teach you the Number 1 spreadsheet.</i>
IX	MAP ACCOUNTS <i>A full accounting package reviewed.</i>
XIII	PUBLIC DOMAIN SOFTWARE <i>There's lots of good software and it's free.</i>
XVII	MULTIPLAN <i>An old faithful of the spreadsheets now on CP/M+.</i>
XXI	TASWORD 8000 <i>The promotion of a word processor from the Spectrum to the Joyce takes Jeremy Spencer down memory lane.</i>
XXXI	FORUM <i>Your letters . . . and who not to listen to.</i>
XXXV	SUBSCRIBE <i>A new magazine is not to be missed.</i>
XXXIX	CUSTOM BUILT DATABASES PART II <i>The bit we didn't print last month.</i>
XLV	ADVANCED LOCOSCRIPT FOR BEGINNERS <i>Eddie gets out his phrase book.</i>
XLIX	CP/M COMMAND BY COMMAND DIR. <i>I never knew there was so much in it.</i>
LIII	INTRODUCTION TO ACCOUNTS <i>Debit and Credit check that you do need a computer.</i>

ABC ADVERTISERS' INDEX

Amstrad	LVI	John Bevan Associates	XXX
Analytical Engines	LII	MAP Computer Systems	XII
Arnor	XXXVIII	Matmos	LIV
BBD Dust Covers	L	Microcal	L
Burlington Software	LIV	Microway Computer Centre	LII
Camsoft	XXII	Minerva Systems	XXXII
Caxton Software	I, VIII, XIV, XXVII, LV	Mirage Microcomputers	L
Celcom	XLVIII	Nabitchi Computing	XXXV
Clarity Guides	LIV	Newstar	XXVI
Compact Software	XLVII	Proteus Computing	XLVII
Computer One	XI	Pulse Software	XXXII
Cornix Software	LIV	Quest International	XXVIII-XXIX
Davis Rubin Associates	IV	Rational Solutions	XXXIV
Dimension Computers	VII	Rugby Micro Spares	LIV
Electric Studio	XXXVI-XXXVII	Sandpiper Software	XX
Finerground	IV	Siren Software	XXXIV
Grafsales	XXIV	Software City	XVI
I.D. Love Computer Services	LIV	Solicoms	XV
Integer Computer Systems	LIV	Speedysoft	XXX
Interlock	LII	Teleguide	LIV
		WP Training	XIVIII



CP/M & PC DOS SOFTWARE FROM DRA



CP/M ← MICROPRO

POCKET PROSTAR SUITE £149

Includes Pocket WordStar, Pocket CalcStar, Pocket InfoStar-DataStar and ReportStar – PLUS the DRA independent Pocket ProStar Guide. Available from Amstrad 8512/8256, 6128 (two drives), BBC Z80 etc.

- Pocket WordStar for word processing and mail merging **£49.95**
- Pocket CalcStar spreadsheet for calculations, projections and analysis **£39.95**
- Pocket InfoStar-DataStar database and ReportStar, the powerful report generator and sorting program **£69.50**
- Pocket SuperSort – a comprehensive sorting program **£49.95**

PRODUCTS → PC DOS

PC DOS DATA SUITE £159

Includes CalcStar, InfoStar-DataStar and ReportStar. Available for IBM PC and clones. File compatibility between PC DOS and CP/M versions.

- CalcStar spreadsheet for calculations, projections and analysis **£59.00**
- InfoStar-DataStar database and ReportStar, the powerful report generator and sorting programs **£115.00**
- InfoStar PLUS – InfoStar plus StarBurst a comprehensive menu generator **£139.00**
- SuperSort – a comprehensive sorting program **£69.00**

THE DYNAMICS OF PROSTAR – The comprehensive GUIDE to MICROPRO SOFTWARE **£18.00**

FREE SOFTWARE HANDBOOK PLUS 70 PROGRAMS ON DISC 5.25" disks/book set **£35.00** 3" disks/book set **£39.95**

- CP/M and PC DOS/MS-DOS Editions available
- A comprehensive selection of favourite Public Domain programs – with excellent documentation in the form of the Handbook
- Chapters on Family Fun, Directory Assistance, Useful Utilities, Libraries and Catalogues, Communications, and a Hacker's Toolbox.

CP/M BASIC programs require Mallard or Microsoft Compatible BASIC
DOS BASIC programs require IBM BASIC or compatibles

Send Cheque (or VISA/ACCESS number) to:

DAVIS RUBIN ASSOCIATES LTD

1 Canonbourne, Weston Sub Edge, Glos. GL55 6QH

VISA/ACCESS orders: TEL (0386) 841181

All prices include VAT and Postage

★★★★ SEND FOR OUR FULL LIST ★★★★★

AMSTRAD 8256/8512

Mobile Computer and Printer Stand



- ROTATABLE THROUGH 360 DEGREES
- HEIGHT IS ADJUSTABLE (32"-42")
- STURDY CONSTRUCTION
- EXTREMELY STABLE
- HEAVY DUTY CASTORS
- COMPLETELY MOBILE
- COMPLETE WITH PRINTER STAND
- A SUPERB PIECE OF FURNITURE
- SOLD DIRECT FROM FACTORY



£99.95 + P&P £7.50



Desk Console and Desk Printer Stand



- TRANSFORMS YOUR PCW
- RELIEVES NECK/BACK ACHE
- ANGLED KEYBOARD
- RAISES VDU TO EYE LEVEL
- WHITE LEATHER GRAIN FINISH
- PRINTER LEVEL WITH CONSOLE
- PRINTER STAND DETACHABLE
- SUPPLIED WITH PAPER TRAYS (extra cost)

Purchase both console and printer stand for **£39.95 SAVE £4**

As separate items. Console **£29.95**
Printer **£12.95** Plus P&P **£2.50**

FINEGROUND LTD.

Computer Hardware Div., Unit 3D Herald Industrial Estate, Hedge End, Southampton
TEL: 04892/88175

ABC

REVIEW

Training aids have become a very important part of the Amstrad scene – after all, software might be getting cheaper but that doesn't make it any easier to learn. Perhaps Microcal's tutor can help you. It promises to do for SuperCalc users what GEC flight simulators do for Jumbo pilots.

Mastering SuperCalc

There are a number of different routes to program proficiency. The most common is where the user relies on the manufacturer's manual, which more often than not will have some form of tutorial section. These can be tedious at best, and useless at their worst. Yet the supplied documentation is often all that the user has to go on, that and a little wit.

If you are a computer novice the chances are that your confidence will be pretty low to begin with and every snag or misunderstanding will cause it to ebb a little more, until you feel like throwing in the towel. This is a great pity because confidence is all important when it comes to learning about computers. More often than not one finds that once a novice has mastered one application, mastering others becomes much easier.

The personal touch

In the last issue of ABC we looked at a tape tutor for NewWord. Tape tutors are intended to act as your personal teacher, guiding you from the beginning, explaining everything in detail. Of course they can't tell when you make a mistake – that's up to you to work out when you notice that what you have on the screen isn't quite how the voice in the recorder described it. Tape tutors aren't totally interactive. You respond to it but it cannot respond to you.

The Microcal approach relies on a software solution. Their products simulate the program you are learning, with explanations and instructions being pasted on the screen on top of it – like a series of exhaustive help screens. The immediate advantage is that the software tutor is interactive. It will know when you make a mistake and can instruct you accordingly – unless the blunder was so mighty that you managed to kill off the program that was teaching you.

Morning assembly

Hands on SuperCalc comes with a little booklet and two discs. The booklet explains that you are expected to be at least able to switch on the computer and load the operating system, in this case CP/M.

The opening screen asks you to "enter

a name by which you would like to be known." I should imagine most people would type in their first name. After a brief explanation of the tutor's workings you are given an explanation as to what SuperCalc is and why you should want to bother with it in the first place.

The very first lesson starts off by showing the difference between a large matrix calculation, done with pen and paper, and the same problem transferred to a spreadsheet. Of course the spreadsheet looks exactly like SuperCalc, and so long as you do as you are asked, it behaves like SuperCalc.

This emulation technique is the strength of the MicroCal system. You can interact with the product you are being trained to use, being gently led through all of the functions, corrected if you get it wrong and reminded if you make a mistake – and yet all the time you are working with a simulation so you become accustomed to the layout and feel of the real thing.

Before you are asked to do anything a little window appears to tell you what it is that you're going to do, and why. You might be asked to enter some text into a cell, in which case the window will tell you what has to be entered. The actual entries are performed on the command line, and the text will shoot up into place after a Return, just like the real thing. Towards the end of each session the system will come up with a little question for you to answer. Your performance doesn't affect your progress through the tutorial – you won't be sent to the bottom of the class, you'll just be asked to do it again, and again, until you get it right.

The time table

The course is claimed to last for four hours, one hour on each disc side. That may seem quite a long time but then there's a lot to get through. The tutorial is divided up into 13 topics, the first being concerned wholly with the workings of the tutorial. Topics 1 and 2 introduce the trainer and SuperCalc, its basic concepts and applications.

Topic 3 is about getting started, including status, help, scrolling and GOTO. Topic 4 describes building a worksheet, entering information and editing.

	JAN	FEB	MAR	APR	MAY	JUN
RECEIPTS-CASH	7200	7200	8000	12000	5400	5400
-CREDIT	800	800	800	2000	8000	600
TOTAL RECEIPTS	8000	8000	8800	14000	13400	6000
EXPENDITURE						
-CASH	2940	2940	7350	3675	2205	2205
-CREDIT	3000	3000	3000	7500	3750	2250
WAGES/EXPENSES			2000	2000	2000	2000
TOTAL			12350	13175	7955	6455
START BANK BAL.			-930	-4400	-3655	1790
ADD RECEIPTS			8000	14000	13400	6000
LESS PAYMENTS			7870	9520	9745	7790
END BANK BAL.			-4400	-3655	1790	1335

Imagine this is a manual worksheet of a hypothetical company's predicted cashflow.

	JAN	FEB	MAR	APR	MAY	JUN
RECEIPTS-CASH	7200	7200	8000	12000	5400	5400
-CREDIT	800	800	800	2000	8000	600
TOTAL RECEIPTS	8000	8000	8800	14000	13400	6000
EXPENDITURE						
-CASH	2940	2940	7350	3675	2205	2205
-CREDIT	3000	3000	3000	7500	3750	2250
WAGES/EXPENSES			2000	2000	2000	2000
TOTAL			12350	13175	7955	6455
START BANK BAL.			-930	-4400	-3655	1790
ADD RECEIPTS			8000	14000	13400	6000
LESS PAYMENTS			7870	9520	9745	7790
END BANK BAL.			-4400	-3655	1790	1335

Now you see how this example might look as a computer worksheet.

Figure 1: This isn't a spreadsheet, but the program's example of how a problem might be looked at manually

Figure 2: Now the same problem but this time how it would appear in SuperCalc

Topic 5 looks at the Format command, including loading, defaults and directory. Topic 6 covers Copy and Replicate, while topic 7 is about Blank and Edit, with the Escape key functions.

Topic 8 explains using simple formulae and topic 9 the global command, including altering the display and the way in which calculations are performed. Topic 10 shows how to insert, delete, move and protect.

Topic 11 describes Titlelock and window - splitting the worksheet into windows. Topic 12 is about arithmetic functions, including arithmetic and preference operators and keyword functions. Finally, Topic 13 describes phasing and printing.

As you can see there are a lot of topics. Of course if you are used to using SuperCalc and only need help with some of the more complicated functions then you might prefer not to work your way through from Topic 1.

In fact it's quite simple to jump straight into the area you want to study - just load the correct side of the disc and, by using the browse function, select the topic from the group. You will find that as you progress further through the course the system will prompt you less

and less. All through the first disc it will remind you that you need to precede a command with a / symbol. Later on you will just be asked to perform the task, unless you get it wrong in which case the program will remind you of the proper procedure.

Suitability

How you get on with this course will depend on your patience and knowledge of SuperCalc. Certainly there is a case for claiming that the less you know about the program the better. An informed user will always be tempted to stray off and have a wander round. You can do that with an audio tutor because it has no control over what you are doing, so it is easy to get a bit smart and have a play - before you know, you are out of sync with the tape.

This simulation tutor will force a pace on you, but the fact that you are living with a simulation is rammed home when one starts being a little creative. I was told to move the cursor to B2, instead I thought I would send it to B3 (well, it's the same thing, almost). I know I should do as I'm told but entering data becomes very artificial when your entries are

rejected time and again because there's a space difference between what you typed in and the phrase on the window.

Only two other small points caught my notice. Firstly Joyce owners aren't going to see SuperCalc as it should appear on their own screen because the tutor only works in 24x80 mode. Secondly the error reporting might have been a little more useful. When a mistake is made a prompt is generated on the little window. Should the same mistake be made, and it's all too easy, the prompt remains exactly the same. Life just seems to leave the tutor after a second mistake.

Conclusion

So is it all worthwhile? My immediate reaction has to be yes. This is an easy way to learn - like tape tutors it isn't perfect, but it isn't far off. After only a short time I had learnt quite a lot and I am going to use the thing to help me master SuperCalc just as soon as I am allowed to go home. - JS

*Hands on SuperCalc
MicroCal,
Slough.*

	JAN	FEB	MAR	APR	MAY	JUN
RECEIPTS						
CASH	7200	7200	8000	12000	5400	5400
CREDIT	800	800	800	2000	8000	600
TOTAL RECEIPTS	8000	8000	8800	14000	13400	6000
EXPENDITURE						
CASH	2940	2940	7350	3675	2205	2205
CREDIT	3000	3000	3000	7500	3750	2250
WAGES/EXPENSES			2000	2000	2000	2000
TOTAL EXPENDITURE	7940	7940	7940	7940	7940	7940
START BANK BALANCE	-1050					
ADD RECEIPTS	8000					
LESS EXPENDITURE	7940					
END BANK BALANCE	-990					

Let's imagine that we're ready to start entering information into column H.
Using the GOTO command, move to cell H1 now.
You've forgotten the '=' prefix.

Figure 3: Just a gentle reminder because I forgot how to use GOTO

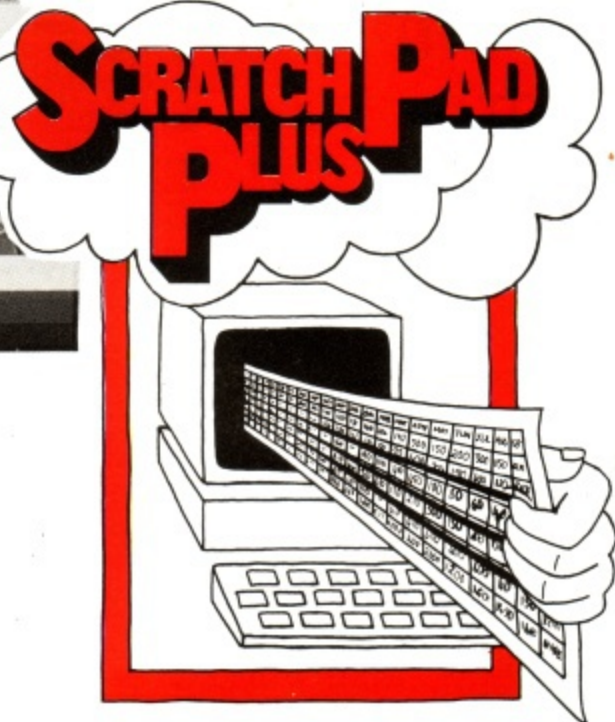

Accept no substitutes.

At a recent exhibition we met several unhappy spreadsheet users. They had visited their local Amstrad dealer and requested a copy of ScratchPad Plus. Whereupon they were told that "one spreadsheet is much the same as another" and by coincidence, the one the dealer happened to have in stock would be "just what they required".

When they eventually saw ScratchPad Plus demonstrated, they discovered that what they had been told was rubbish. By then though, it was too

late and they were left with the irritation of a substitute.

They wished they had stuck to their guns.

So if you require an **Enhanced Spreadsheet** with

- Virtual Memory Capability
- Variable Spreadsheet dimensions
- Multiple windows
- Keyboard prompt-card
- Specific function keys
- Amstrad specific manual

– And like the sound of Caxton, specify ScratchPad Plus. Most informed dealers are now recommending it, but one or two dealers may try to fob you off with a substitute.

Stick to your guns.

In the unlikely event that you will need any help with ScratchPad Plus, just telephone us. Our support is completely **FREE OF CHARGE**. We will welcome your call and answer your query in a pleasant, helpful and efficient manner – because that's the sort of people we are.

ScratchPad Plus is £69.99 (inc VAT).

Available for Amstrad 6128, 8256/8512, IBM PC and all compatibles.

Caxton Software Limited
10-14 Bedford Street
Covent Garden
London WC2E 9HE
Tel: 01-379 6502.
Telex: 27950 ref 398



ABC**REVIEW**

Putting MAP on the Joyce

The MAP suite is a fairly well known package which has recently been transferred to the Amstrad machines. To say that it is big is an understatement. The total suite takes up two full discs for the programs alone. It runs under CP/M Plus and, although it could conceivably be run on a single drive system, it would require an awful lot of disc changing on the part of the user. We suggest that a twin drive system is needed here (or a RAM drive – here is a case where an expanded drive M: would be a definite asset).

The complete suite comprises sales, purchase and nominal ledgers, a stock control module and a set of utilities. It comes with a manual of more than 150 pages, bound in a vinyl cover which folds back to provide an integral stand so that you can read the manual at ease, while sitting at the keyboard – just one example of the thought that has gone into this package. The manual itself is very comprehensive, with lots of screen shots and sample printouts, and it includes some model data collection forms which you can photocopy at will.

The documentation goes to some lengths to explain what is happening and why it does things in a certain way but, should you feel the need, there is hot-line telephone support or a full training course available – at extra cost. All entries are done by means of unambiguous screen prompts and you may amend any data at the end of each screenful, by specifying which line you wish to edit.

Barry Pickles and John Burke investigate an exciting new accounts package which has done sterling service on some very expensive machines.

Integration – the modular approach

Each module can be operated as a stand-alone program, but it is the ability to integrate the data which makes accounting packages so much of a boon. In case you were wondering, “integration” means that the data provided when using one module will, automatically, be transferred to any other relevant module.

For example, posting a sale to a particular customer’s account in the sales ledger will also post the same item in the nominal ledger to a sales account, a debtors control account and the VAT account, without you having to repeat

the information. full double-entry book-keeping is enforced throughout the package and the program will not allow you to proceed if it detects an error. Figure 1 shows how the modules are related.

All modules offer password protection at various stages of the procedures. At the setup stage you are asked to estimate the number of customers or suppliers and the average number of transactions per accounting period so that the system can reserve disc space. However you are allowed to exceed the number of accounts, providing there is enough disc space. You are not allowed to exceed the average number of transactions but, since it is an average, you can trade off numbers between accounts. This is an eminently more sensible approach than some packages, which just give up if you try to go beyond the specified estimates.

The nominal ledger

The nominal ledger summarises all the financial transactions of a company. These are grouped together under a type heading (account) and up to 250 of these are allowed by the system. In addition, should you wish, up to 99 departmental cost-centres may be allocated to each account.

During the “period end” process, each group of accounts is totalled and produced in a format that shows the profit or loss for that month, either by company or by cost-centre. The system produces four main types of report – a trading account, profit and loss account, balance sheet and a contribution account.

The latter may not be familiar to many of you – what it does is to summarise, by individual sales/purchase type, the contribution that each has made to the overall profit or loss. Each account may also be allocated a budget figure and accruals, prepayments and journal entries are also catered for.

Optional reports available at the year end are – account code listing, transaction listing, trial balance, listing of accruals/prepayments and actual versus budget performance. All these may be produced for any cost-centre. The nominal ledger requires around 100k for

data storage – more if you use the cost-centre option.

The sales ledger

The sales ledger can cope with around 200 customer accounts on a single-sided Amstrad disc. It provides automatic posting to the nominal ledger and can link into the stock control module. When setting up the customer accounts you are allowed, as well as the usual details, fields for contact name, customer type (up to 99), credit limit and discount allowed. The module provides an invoicing option which links into the VAT account, and you may format invoices in any manner you wish – there is a dummy run option to check that the formatting is to your liking. Up to six VAT rates are allowed and these will be calculated automatically by the invoice option, if you desire. Another option allows you to process invoices individually or in batches, with a control total. Finally, customer statements are run off and you may request an aged debtors report.

The purchase ledger

The purchase ledger comes on the same disc as the sales ledger, as it seems to share some of its sub-programs. Again, you are allowed 200 suppliers on a single-sided disc and posting to the nominal is automatic. As well as remittance advices, the module can also produce cheques – this is unusual on a package selling at this level – and, again, you may obtain an aged creditors report. Note that this ledger does not integrate with the stock control module. All data from this ledger needs to be posted by hand to the stock ledger.

And lastly stock control

The final module, stock control, is quite sophisticated – even more so, perhaps, than the other parts of the suite. It can cope with quite a large inventory, needing only around 30k for 100 lines. You may specify three levels of sales price, five levels of cost price, 20 stock movement types, 99 sub-headings for sale units, as well as minimum stock levels and fixed re-order quantities.

As you might imagine, this leads to very comprehensive reports, including stock cards, valuation, current stocks, price list per item, stocks having nil movement in the period, stock below minimum quantity, new stock allocated and on order, cost of sales, and inventory list for manual stock take. As noted, this module will integrate with the sales ledger, but not the purchase ledger.

The remainder of the suite is taken up with a group of utilities which allow you to set up the system to your own configuration and to alter account headings and the like. Having used this

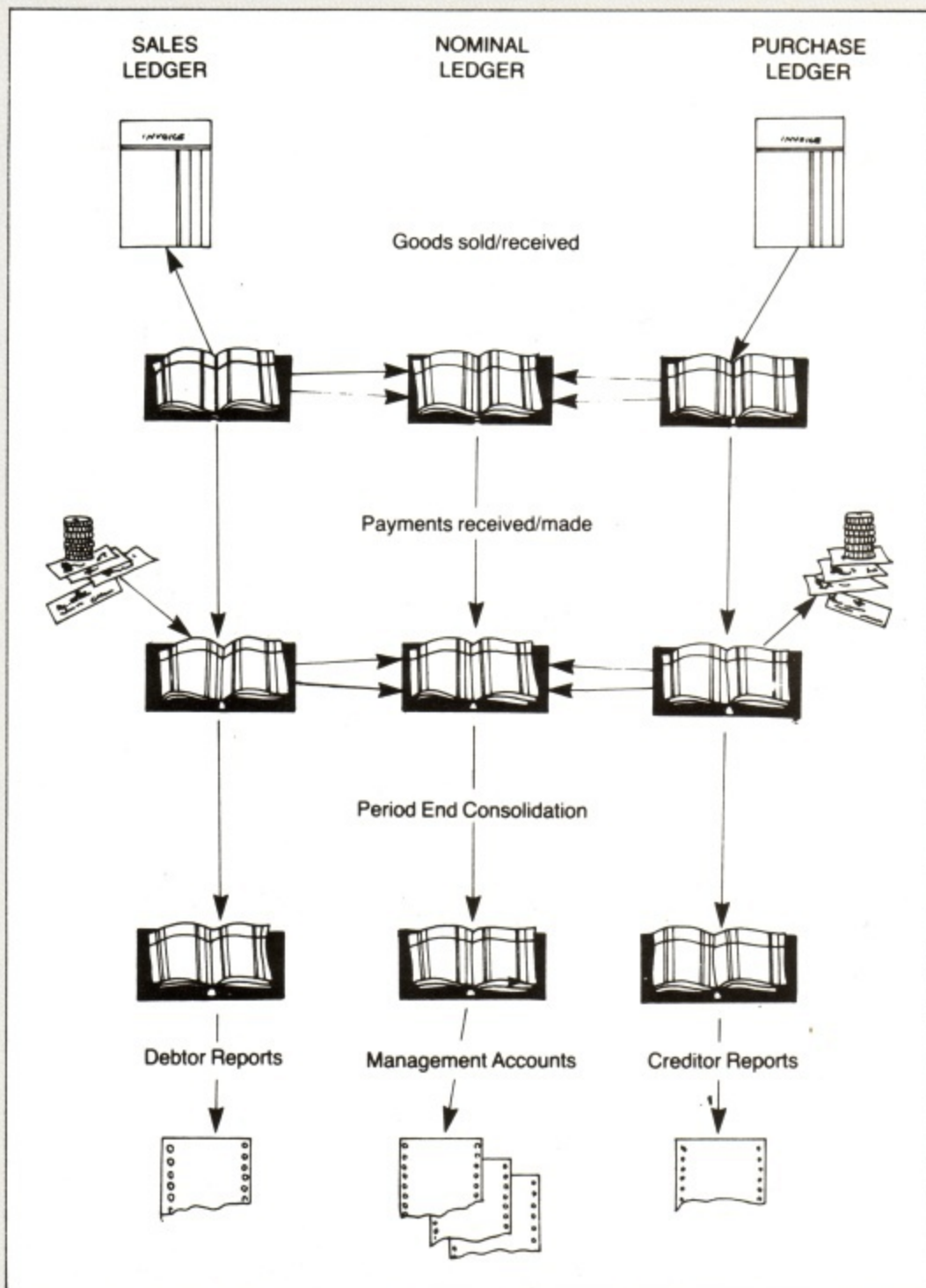

Figure 1: Sales, Purchase and Nominal Ledgers – Overview

system for some time now, we are most impressed. The manual is quite detailed, but the average bookkeeper will have no difficulty at all in operating the system.

It is apparent that whoever programmed these packages knew what they were about. The screens are clear in their intent and input tightly defined. Yes, you can crash the system if you are really determined, but error trapping is good and you have to do something really stupid to defeat it.

As you can see, this is a very comprehensive package, but don't be put off by the depth of its sophistication. You don't have to use all the facilities, but if you are at the level where you are requiring detailed analysis, it is highly likely that you are using a trained bookkeeper/accountant. If so, you may rest assured that they will find themselves very much at home with the way the suite operates and they will be delighted by the reports that it can

produce.

Nor should the small trader be afraid of using this suite. The more comprehensive the information put into it, the more detailed will be the reports – but you can start at a very easy level and build up to the more sophisticated features as your business expands. One thing's for certain, by the time you outgrow this suite, you will be in dire need of a larger computer setup!

The price might be a shade on the high side for the average Amstrad owner, but it will prove to be a very worthwhile investment. This is no toy package. It can hold its own among the Peachtrees and the Pegasus. Highly recommended.

£150 MAP Ltd,
105-107 Windsor Road, Oldham
OL8 1RP

all in one...

computer ONE



TYPING TUTOR

An invaluable learning package to help you touch-type on the Amstrad 8256/8512 word processors.

Based on our best-selling **Computer One Typing-Tutor**, this new improved Amstrad package is destined to be another best-seller!

In a series of carefully designed exercises using the established and successful Pitman's method, the **Computer One Typing-Tutor** will help you master the true touch-typing method in as little as 24 hours. Computer One's revolutionary new approach involves a powerful graphical demonstration of the keyboard and a series of graded and structured lessons that enable the user to progress through the exercises at his/her own pace. *It is also fun to use!*

The **Computer One Typing-Tutor** already has a proven user base on a number of other computers including BBC micro, Sinclair QL, ICL One Per Desk; and is widely used by many major education institutions around the world.

This 23 lesson package includes:

- Keyboard familiarisation
- LocoScript*-style menus
- Optional results printout
- Save position feature

and a number of unique features:

- Free Typing game
- 'Head-up' keyboard display
- 'Typewriter' action

only
£24.95
inc VAT & P&P

TYPING TUTOR provides an excellent piece of Super-Basic software . . . is good fun and probably the first addictive program . . .
Sinclair User

HOTLINE ... (0223) 862616

SPELLING CHECKER

Throw away your dictionary . . .
. . . let **Spelling-Checker** do the work!

The **Computer One Spelling-Checker** is a professional software package specifically designed for your Amstrad 8256/8512 word processor. Based on a proven algorithm using fast and efficient searching techniques, this package will quickly and simply locate spelling errors/typos in your reports and documents in front of your own eyes!

From a dictionary of over 41,000 words, the program is able to check your text against its own intelligent dictionary. Additional features enable you to create your own personal dictionary of new or special words that are not held in the standard package.

FEATURES:

- Fully LocoScript* compatible
- 41,000 + word dictionary
- Fast checking program
- Anagram facility
- Suggests closest match
- Free crossword puzzle solver
- Compatible with both 8256 and 8512 models

only
£34.95
inc. VAT & P&P

Discounts available to educational establishments.
Clip the coupon or contact your Amstrad Dealer to order.

Computer One reserves the right to alter the specification of the product without notice
* LocoScript is a trademark of Locomotive Software Ltd

Amstrad 8256/8512

computer ONE

TYPING TUTOR ...

SPELLING CHECKER ...

Please send me further details

CREDIT CARD SALES: UK BUYERS ONLY
PLEASE ALLOW 28 DAYS FOR DELIVERY inc VAT & P&P

A2

TOTAL AMOUNT £ _____

enclosed with order
by cheque or P.O. (no cash) and made payable to **COMPUTER ONE**, or by charge card

No.

NAME _____

ADDRESS _____

SIGNED _____

TICK ORDER

Access

VISA

Send to: **COMPUTER ONE, SCIENCE PARK,
MILTON ROAD, CAMBRIDGE CB4 4BH**



YOU KNOW THE REVOLUTIONARY AMSTRAD RANGE IS TOTALLY EQUIPPED FOR WORD PROCESSING. BUT DID YOU KNOW THAT SOFTWARE FROM MAP, ONE OF BRITAIN'S LEADING ACCOUNTANCY SOFTWARE PRODUCERS, CAN TRANSFORM YOUR AMSTRAD TO PROVIDE THE COMPLETE BUSINESS ACCOUNTING SOLUTION?
OUR COMPLETE **£149*** PACKAGE PROVIDES:

INVOICING & SALES LEDGER

Keeps track of your goods and services on credit, VAT, and offers complete invoicing facilities.

PURCHASE LEDGER

Keeps track of your purchases, retains files on all suppliers, and money owed.

NOMINAL LEDGER

This gives you an instant summary of all your company's financial transactions. Trial balance profit and loss account balance sheet

STOCK CONTROL

This powerful and versatile system controls movement and levels of your company's stocks.

INDIVIDUAL PACKAGES ARE JUST £49 (INC VAT) EACH

MAP's Amstrad Payroll package is just £49 (inc VAT).

WE GIVE YOU FREE AFTER-SALES support for one month, to familiarize you with all the facilities the package offers. Twelve months support is just £50 (inc VAT).

FOR MORE INFORMATION, ENQUIRIES ON BULK PURCHASES, MAP DISTRIBUTORSHIPS OR DIRECT MAIL ORDER SALES JUST FILL IN THIS COUPON AND SEND TO US.

FOR IMMEDIATE ACTION RING SHEILA GREEN ON 061 624 5662



PLEASE SEND ME:

- Further Details
- Invoicing & Sales Ledger (£49)
- Purchase Ledger (£49)
- Nominal Ledger (£49)
- Stock Control (£49)
- Payroll (£49)
- Complete Pack (£149) (Does not include Payroll)

I enclose: £ _____

Name _____

Company _____

Address _____

All prices INCLUDE VAT

MAP COMPUTER SYSTEMS LTD
105-107 Windsor Road, Oldham, Greater Manchester
Tel: 061-624 5662/3 AU2

ABC

CP/M

Clarke's Corner

ACU aren't the only people with a Hairy hacker – we have one too, though ours is a lot hairier and considerably more hacked about. He answers to the name of Andrew Clarke and can witter on for hours about public domain software.

It is probable that the most widely used communication program in the country is Modem7. It is in the public domain, meaning that the author has allowed it to be copied and used by anyone, but has specifically forbidden it to be sold for profit.

There are many other communications programs, but Modem7 is, I think, the essential one. It lacks a few facilities, such as an auto-dial directory, but essentially it gives you all you need to communicate with other computers through the telephone line or through a serial link. The fact that it is free is just a bonus.

Once you have got over the novelty of using a modem and have tired of Prestel and Telecom Gold, you will want to send files to other people via the telephone line, download programs, or explore the immense undergrowth of bulletin boards. Let no one hoodwink you into believing that you need a fancy modem or an expensive communications program. All you need is Modem7 and a nice cheap modem that will run at 300 baud. Telecommunications does not need to be an expensive activity.

Getting hold of Modem7 or UKM7, the UK rewrite, should present no problem, particularly if you belong to the CP/M User Group. It should be configured to run on your hardware, but versions that run on the Amstrad micros are available ready to run.

If, like me, you have several micros, all with different disc formats, then it is a great boon to have a version of UKM7 configured for each, so that one can transfer files between them merely by connecting them together with the appropriate serial cable. Incidentally this is one of the easiest ways of transferring files between Amstrads as well.

UKM7, which is the state of the art, is the end result of years of development. Originally a program called Modem was written by Ward Christensen for the Chicago Area Computer Hobbyist Exchange. This was an early user group that eventually begat the CP/M User Group in the States.

Ward Christensen devised a reasonable way of sending files so that the integrity of the contents was virtually guaranteed. This was necessary because

the telephone line was never designed for transmitting data and its use for such purposes is fraught with compromise.

If you get noise, glitches, crossed lines or static, the result is fairly obvious. Instead of the recipient getting such stuff as "Dear Sir, I write to complain about the recently purchased . . ." and so on, he would be puzzled to get such things as "Dear Sir, I uU@@@!&A&R&Gomplain about the recently NrG94ynjI . . .". This makes for difficulties, and could lead to misunderstandings. If you are sending a program rather than text, the result could be more serious.

Modem7 works by chopping a file into easily digestible chunks or packets. The sending program keeps repeating the transmission of each packet until it has a positive acknowledgement from the receiving program that it got there all right. On a good day you may notice that the occasional packet is repeated but on a bad day transmission can be very slow because of the need for extensive retries.

Distance does not seem to be significant – I have exchanged files via modem with people in California and Saudi Arabia without any data corruption at all. Sometimes I get terrible trouble on a local line to the next village. Anyway, with Modem7 you need not worry because the program looks after everything.

You may think that a communication protocol would be easy to design. This is not the case, however, because of the number of things that can go wrong, and the different uses to which a utility like Modem7 can be put. It is important that the program should be able to retrieve itself from all sorts of unpleasant situations.

Imagine you are sending a sizeable file over a long distance. All has gone well until the last sector, at which point you get a crossed line. The other party, as is often the case, misinterprets the whistling of the modems as static and fails to get off the line for a while. Unless your program is well constructed, it will fail and ditch the whole file – an expensive action.

It is important to retrieve as much as possible when errors occur. Modem evolved over the years to deal properly with more and more of the things that can happen. The original then evolved

into Xmodem which, in turn, developed into Modem7.

The protocol used by the program has become the industry standard because it works well and is well documented. Every commercial comms program worth its license fee is able to emulate it. All the leading programs such as Lotus 123, PC Talk, and Crosstalk and all bulletin boards that support CP/M do so. The protocol is often referred to as Xmodem, which more exactly should refer to an old version of the program that has a rather less robust error checking system and could only transfer one file at a time.

Like any program that knocks around for a bit, and is improved by a number of people, it started to look rather tatty. At this point, David Back of the UK CP/M User Group took the program in hand, pulled out yards of superfluous code and generally tidied the whole plot up considerably. It is this version of Modem7 which is generally used here in the UK.

I sometimes get people phoning me to complain that it does not work properly. This is absurd. It works very well indeed. It is usually the case that the complainant has got a wrongly configured version, has forgotten to plug it into his modem, or has managed to clobber the file. When it is properly set up, it is an efficient and reliable program that does the job for which it was intended. Who could ask for more?

Modem7 in use

Here is how to send a file, using UKM7. Unwrap your shiny new modem – a nice cheap one will do. One lead is plugged into your serial port, and the other lead plugs into the dual outlet adapter that you have in your line jack unit. Plug your phone into the other socket of the adapter. Switch on your computer. Set the baud rate to 300, using the Device program. You may need to read The Amstrad CP/M Plus for details on how to do this.

Put your comms disc, containing UKM7, in the drive. Type UKM7 followed by T in response to the initial menu, to put you into terminal mode. Dial up your favourite bulletin board (The UK CP/M User Group uses Alan Walker's BB on 0767 50511).

You will hear the ringing tone, hopefully followed by the call being answered. You will then hear a high pitched whistle called the carrier. Set your modem to originate mode, and switch it on. You should then hear your modem whistle in return, in a slightly different tone. At this point, you can put down the handset and pop over to the computer.

Yes – if you have done everything right, the welcoming screen from the bulletin



board is scrolling up your own screen. If this is not so, then you have blown it. Lift the receiver. Can you hear both the warbling whistles? If you cannot hear yours, the modem is not working for one of several reasons. If your modem is whistling properly but does not warble when you press a key – make sure you are in UKM7 terminal mode – then something is amiss in the connection between micro and modem.

If you cannot hear any carrier from the other end of the line, then you may have got a wrong number and a perplexed subscriber is hearing a curious whistling sound with occasional uncouth profanities from a fumbling micro amateur. If both whistling sounds are at the same frequency, you have probably set the modem to answer instead of originate. Have you set the baud rate properly?

If all is well, then read the instructions that appear on Alan's BB. Try a few things – download all his bulletin board numbers, leave me a message in my message box, and ogle the free software. Do not wait around too long as other people may be waiting to access the BB. When you feel confident, then download CP/M programs into your micro, using UKM7. You need to switch into Xmodem mode from terminal mode, which is all explained in the board.

Using a modem with UKM7 is a matter of gaining confidence. There is no real skill involved but it is just that there are one or two things to remember.

Now you are communicating, what use is it? If you are using it in a small business context, then the telex service run by MicroLink on Telecom Gold is invaluable. One does not use the full capabilities of UKM7, just terminal mode. You will need to subscribe, but the

cost of sending telexes (less than £1 a time) makes such a thing practical for a small business. Telexes are received in a message box and you have to dial in to read them. Other messaging facilities are useful, but inessential.

Unless you have an auto-answer modem and a computer with fancy software switched on all day, the receiving of text or other material via the modem is tricky. This is where the bulletin boards or commercial messaging facilities, are so useful. You can use one or more to collect all your messages and when you next switch on you can get your mail and your act together.

You can send to a bulletin board without worrying whether the final destination is awake and functioning. I can send text or programs all round the world – expensive but immediate. If only more people had modems, then it would be easier to use them in the commercial context for ordering goods or sending correspondence.

Even so I have never regretted the expense of a modem – micro telecommunications has a tendency to become indispensable if one starts using it.

Just watch those phone bills though – British Telecom charges a great deal more than Ma Bell in the States, where bulletin boards were invented. Until we get a sensible off peak rate we will need to linger as little as possible in the fascinating special interest bulletin boards.

Do as much preparation as you can off line, save the board's help file and print it out so you can refer to it next time. As one gushing manual to a stateside comms package once burred: "Welcome to the world of telecommunications". Well said.

ABC

WE'LL SHOW YOU A SWEETER WAY TO EXPAND YOUR PCW8256/512 COMPUTER

EXAMPLE 1:

DIY Memory upgrade kit for the 8256 to 512K: £22.00
Installation by experts if required: £10.00

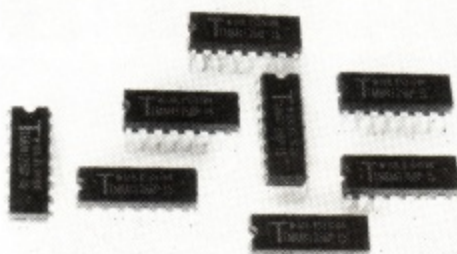

EXAMPLE 5:

BATTERY backed Real Time Clock can be used to stamp DATE and TIME on CP/M files, to store security code and machine options £23.00

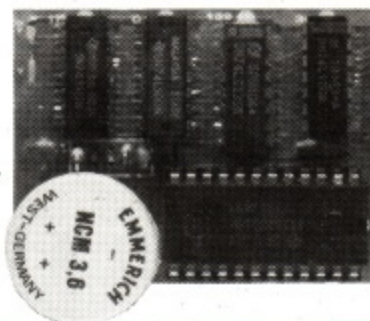

EXAMPLE 2:

JUKI 6100 Daisy Wheel Printer, 20CPS, with Smart Printer lead, plugs directly into the expansion port: £230.00. Works with CP/M and the latest version of Locoscript.



EXAMPLE 6:

Combined Serial and Parallel IN/OUT interface, takes DAISY WHEEL printer and MODEM £30.00. MOUSE port (ATARI type) £5 extra.
Combined Serial, Parallel IN/OUT interface and TELETEXT COLOUR with dedicated RGB output for colour monitor £55.00. UHF MODULATOR for colour TV: £10.00 extra. MOUSE port £5.00 extra



EXAMPLE 3:

3" double-sided 80-track disk drive and leads for the 8256, fits into drive slot in the monitor: £140.00
External 3.5" double-sided 80-track disk drive and leads for the 8256, cased: £100.00
External 5.25" double-sided 80-track disk drive and leads for the 8256: £110.00



EXAMPLE 7:

Mains powered, BABT approved MODEM, with software to connect to Viewdata (PRESTEL) and GOLD £30.00. Requires Serial Interface.
Same MODEM with Smart Serial Lead, plugs into expansion port and VIEWDATA (eg for PRESTEL) software on disk £55.00



EXAMPLE 4:

Winchester hard disk with SCSI controller and separate PSU, capacity: 20 Megabytes formatted, hard disk BIOS, parallel printer interface, plugs into the expansion bus: £600.00

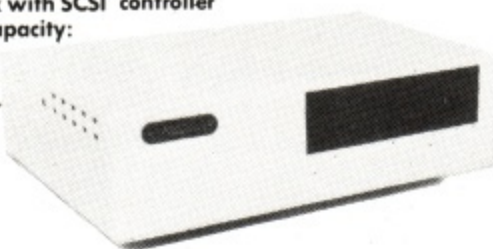

We accept orders by phone ACCESS and VISA. All prices quoted are exclusive of VAT (currently at 15%) and delivery

Send to: SOLICOMMS LTD,

17 Sweyne Avenue, Southend-on-Sea, Essex SS2 6JQ

TELL ME MORE ABOUT YOUR PRODUCTS FOR THE 8256/512

NAME

COMPANY

POSITION

ADDRESS

MY SYSTEM COMPRISES

We reserve the right to alter prices and specifications for improvement without notice.



Software City

THE UK'S NO. 1 SOFTWARE DEALER LTD.

Also runs
on 6128

dBASE II

dBASE II is one of the most powerful information management tools available for your computer. Regarded as an industry standard, it is now available to Amstrad PCW 8256 and 8512 users at only

£119.00 inc. VAT

(Suitable for one or two drives)

AVAILABLE NOW

STOP PRESS! RS232 Parallel Serial Interface £59.95

dBASE II BOOKS

Advanced techniques in dBASE II	£22.95
Advanced dBASE II Users Guide ..	£25.95
Developing Applications in dBASE II	£11.95
Everymans Database	
Primer dBASE II	£16.95
Understanding dBASE II	£22.95
Users Guide to dBASE II	£13.95
Using dBASE II	£19.95
Working with dBASE II	£9.95
dBASE II Explored	£7.95
dBASE II for Every Business	£16.95
dBASE II for the First Time User ...	£16.95
dBASE II in English I	£9.95

THE ELECTRIC STUDIO LIGHT PEN £79.95

for PCW8256 and 8512
Just plug it in and draw
Well worth seeing Now!

3 Piece Dust Cover **£9.99**

DKTronics PCW8256 RAM
upgrade
to 512k for only **£39.95**

All Prices include VAT
and UK Delivery

HANDS-ON



Hands-On CP/M
£24.95
Hands-On Supercalc
£24.95

(Both products come as
two tutorial disks
starting from basic
concepts)

SUPERCALC

Now Available
Hands-On dBASE II
£24.95

Unlock the power of
dBASE II with this
tutorial to get you
started.

HANDS-ON



CP/M PLUS

DR CBasic Compiler	£49.95
DR Graph (G)	£49.95
DR Pasca/MT+	£49.95
DR Draw (G)	£49.95
Caxton Cardbox (D)	£99.95
Caxton Touch 'N' Go (T)	£24.95
Caxton Scratchpad (S)	£69.95
Caxton Smart Key II	£49.95
Caxton Brainstorm	£49.95
The Cracker (S)	£49.00
Saxton Flexi-File (D)	£49.95
Comsoft Delta (D)	£99.95
Supercalc II (S)	£49.95
Locoscript Tutorial (T)	£9.95
Clock Chess	£19.95
New Word with Spell Plus (W)	£69.95
Pocket Wordstar (W)	£49.95
Pocket Spellstar (W)	£24.95
Pocket Calcstar (S)	£49.95
Pocket Datastar (D)	£69.95
Pocket Reportstar (D)	£49.95

SAGESOFT

1 Accounts (A)	£99.95
2 Payroll (A)	£69.95
3 Invoicing and Stock Control (A) ...	£69.95
Accounts Plus 1 + 3 (A)	£149.95
Combo 1 + 2 (A)	£149.95
Super Combo 1 + 2 + 3 (A)	£199.95
Statement Paper per 1000	£40.00
Payroll Payslips per 250	£12.50
Retrieve Database (D)	£69.95
'Chit Chat' Viewdata (ie. Prestel)	£69.95
'Chit Chat' E Mail	£69.95
'Chit Chat' Combo	£99.95
Modem with Viewdata or E Mail ...	£199.95
Modem with Viewdata and E Mail	£239.95
Magic Filer (D)	£69.95

W = Wordprocessing S = Spreadsheets
D = Databases A = Accounting
G = Graphics T = Tutorials

ABCS Sales and Invoicing (A)	£99.00	Multiplan (S)	£69.95
ABCS Nominal (A)	£33.00	Super Writer (W)	£49.95
ABCS Purchase (A)	£33.00	NewWord Tutorial (T)	£9.95
Cashbook Accounts (A)	£49.95	Supercalc II Tutorial (T)	£6.95
lansyst Typing Courses (T)	£24.95	CPM and Basic Tutorial (T)	£9.95
Cash Trader without Analyser (A)	£114.95	Multiplan Tutorial (T)	£9.95
Cash Trader with Analyser (A)	£149.95	Matchbox (D)	£29.95
ELS Light Pen for the PCW8256/8512 available now at only	£79.95	Caxton Condor (D)	£99.95
		Polyprint with Polyword (G)	£29.95
		Polyplot (G)	£24.95

Mastering the 8256/8512	£9.95
Using the 8256 and 8512	£9.95
CP/M Plus Handbook	£9.95

**382 Kings Road
Chelsea
London
SW3 5UZ
Tel: 01-352 9220**



**14 Thames Street
Kingston Upon Thames
Surrey
KT1 1PE
Tel: 01-541 4911**



**47 Cheap Street
Newbury
Berkshire
RG14 5BX
Tel: 0635 31696**

STOP PRESS !!!

dBASE II Run-Time Module and Compilers coming soon

ABC**REVIEW**

Microsoft Multiplan has, for a long time, been recognised as an industry standard on minicomputers and has now been given a new lease of life following its release for operation under CP/M 3.0 on the Amstrad range of machines.

Slow but powerful spreadsheet giant

The Multiplan package contains a single disc, a manual, a quick reference guide and a set of photocopied sheets that detail the installation on Amstrad machines. The notes contain an excellent guide to making a working copy, which seems to be the stage that confuses most people, and describes the function key assignments. The quick reference guide, not surprisingly, contains a summary of all commands and operations available and proves invaluable once you've attempted to wade through the whole manual.

The manual is clear, concise and easy to follow. There are two separate sections. The first is a tutorial which introduces you gently to Multiplan, and provides some basic examples of setting up a spreadsheet. The second section is a reference guide that describes the syntax and operation of the commands in detail, as well as describing the menu structure.

So what is it like to actually use? The program is executed by means of SUBMIT files on both the CPC6128 and the PCW8256/8512, with an option on the latter to copy the program to the memory drive. The opening screen format is a standard matrix, very reminiscent of SuperCalc. The first difference that you notice, however, is the menu options presented at the bottom of the screen. Instead of the rather harsh reminder of the alphabet given with the Cracker, or the general lack of anything with SuperCalc (until you press the appropriate key), there is a rather reassuring list of words that look as though you might have a chance of understanding what they are there for.

The number in the top left hand corner of the screen is an indication of the window that is currently in use – more of this later.

Menu selection can be achieved either by moving the highlight block to the relevant option and then pressing Return, or by pressing the initial letter of the option.

On-screen help is available at all times either by selecting the Help option from the menu, or by pressing the ? key. The help screen displayed is relevant to the current operation. For example, when in the middle of copying a block the ? key will display information about copying – logical, eh?

Data can be entered in two formats – as text or a value. Text entries have a

numeric value of zero and can be up to 255 characters long, depending on the width of the column in which they appear. The value format is used for entering both constants and formulae. Multiple data entry is possible by using the cursor keys to finish entry into one cell and move to the next.

One of the most useful facilities available from Multiplan is naming of groups of cells. Suppose, for example, that you were constructing a simple home budget calculation, and you had split it into two sections – outgoings and incomings. The totals of each section could be labelled as Outgoings and Incomings. The overall cash flow line could then be labelled as Total. The clever bit is that you can now reference these labels from within a formula. Here we could type:

**TOTAL = INCOMINGS -
OUTGOINGS**

which is obviously a lot more readable than A15=A10-A5.

You can jump to a particular group of cells by using the GOTO NAME command, which moves the cursor to the top left hand corner of the cells referenced.

A major disadvantage, which is a feature of the implementation on the Amstrads, is that the screen update is slow – almost painfully so. This is particularly noticeable when scrolling the screen, which obviously happens a lot once your spreadsheet becomes larger than the screen area. Multiplan does come installed for the full screen on the PCW versions, which goes some way to alleviating the problems but by no means overcomes them.

The screen display can be split using the windowing facility, which permits up to eight windows on screen at any one time. Each window has a # character marking the top left hand corner, making it simple to determine at a glance the location of each window. The individual windows can be linked together so that scrolling one will scroll the linked window as well. This technique allows you to look at different areas of income, for example, in the same month, with the month column scrolling automatically. Title columns and rows can be locked, so that scrolling the sheet does not remove the text entries from the screen.

There is a very versatile print output

facility that permits full use of the printer via entry of control codes. Print output can also be directed to a data file on disc, for later viewing or for examining with a word processor.

Probably the single most versatile feature is the facility to link spreadsheets. Suppose, for example, that you were preparing a forecast for the next fiscal year. It is likely that the forecast would take the form of a detailed analysis month by month, accompanied by an overall analysis giving a summary of the year's performance.

Multiplan will allow you to generate each monthly assessment as an individual sheet, and then to automatically transfer the totals from the individual sheets to a separate annual summary sheet. The linking is simply achieved by naming the cells that you wish to read data from in the monthly sheets – these are termed “supporting sheets” in Multiplanese – and then using the external copy command in the annual sheet (the “dependent sheet”) to read these values in.

Checks are made in the dependent sheet to ensure that the external link is being made to a blank cell, to ensure that data is not being overwritten. Whenever the dependent sheet is loaded a “copying” message is displayed to inform the user that the supporting sheets are being accessed to read in the data.

Each supporting sheet is referenced by both a name and a drive indicator, so that the sheets do not have to be all located on the same disc.

The related spreadsheet facility really comes into its own when you are performing “What if” projections. In our example we could change the figures for January (say by increasing the advertising budget) and then go back to our annual projection to see the effect on profits without having to transfer any data between the two sheets.

There is no restriction on the number of links that can be made in this way, and so a very complex network of sheets may be set up. Care must be taken in this case to ensure the integrity of the data

produced. Suppose that we introduced a third level of analysis to our projection – a quarterly analysis. The annual sheet could then derive its values from each of the four quarters.

If we now make a change in the January figures, this will be picked up if we load our quarterly sheet. If, however, we load the annual sheet first there will be no apparent change – this is because the quarterly sheet will not update its totals until it is loaded. This can be overcome by loading the sheet with the lowest priority first, followed by the next priority and so on until the overall analysis is reached.

The moral of this is that the links between sheets should be carefully planned to avoid the potential chaos and confusion. Microsoft has very generously included a feature to unravel the mess that is bound to ensue – the external list command – which produces a list of the name of spreadsheets and their dependencies.

Referencing

The referencing of groups of cells can be achieved by various techniques. Firstly there is a straightforward absolute referencing, where the coordinate location of the required cell is given in full (such as R1C2). Secondly there is a relative reference where a cell location is defined by its offset from the current cell. For example R(-2)C points to the cell in the current column that is two rows before the current cell. These two forms of referencing individual cells can then be defined to specify groups of cells.

The simplest technique is to specify a rectangular block of cells by giving the top left and bottom right coordinates, so that R(-4)C(-2):R(-2)C defines a block of four cells. Alternatively you can reference the intersection of two blocks by separating their specifications by a space – R1C3:R5C5 R3C1:R6C8 actually defines the block R3C3:R5C5.

Finally the definitions may be combined in a list separated by commas. This is particularly useful when assigning one variable name to a set of cells that may not necessarily be physically located together on the sheet.

The mathematical facilities provided are fairly standard – arithmetic calculations as well as logarithmic and trigonometric functions. In addition there is a STDEV (standard deviation) and a NPV (net present value) function for basic statistical calculations. The DOLLAR function converts a figure into a financial format (two decimal places with negative values enclosed in parentheses).

Data can be protected by LOCKing the cells in which it is contained. LOCKed cells cannot be written to until

they have been UNLOCKed (believe it or not). There is an option to lock either an entire range of cells or only those that contain formulae, which still allows data to be changed for “What if” calculations.

The COLUMN function returns the number of the column that the formula is placed in. For example, COLUMN would return the value 5 if placed in R1C5. This is very useful for formulae that are defined once and then copied to different areas of the sheet.

Two commands are provided for tabular work – INDEX and LOOKUP. INDEX returns the value contained at a particular location in a table. For example, INDEX(R1C1:R8C8,3,3) would return the value held in R3C3. LOOKUP returns the nearest value that is less than or equal to the number specified, from within a row or column. Suppose that column 5 had the following contents:

C5
100.00
125.00
234.00
250.00
500.00
630.00

then LOOKUP (C5, 130) would return 125.00 and LOOKUP (C5, 629.25) would return 500.00 – handy for calculating tax returns from a set of tables.

Conclusion

Multiplan is, undoubtedly, one of the most powerful spreadsheet programs currently available for the Amstrad. It is well documented and easy to use, with more than adequate help facilities. The option to relate spreadsheets is a definite boon, particularly when you consider that there is less than 30k available for each individual spreadsheet, which makes serious projections almost impossible with the likes of SuperCalc.

However, the screen update is slow to a painful degree which makes movement around large sheets tedious. There are no date calculations, which are useful when doing projections and the statistical facilities are limited.

Exchanging data with other programs is not as easy as it might be. The output format is unique to Microsoft, and so unless you are using another Multi-product it ain't gonna be easy. There is an option to print to a disc file, however, so with a bit of jiggery-pokery it is possible as long as you've got the patience.

In the final analysis, it is a trade off between the power of the related spreadsheets and the speed of use – there are an awful lot of happy Multiplan users out there, albeit on IBMs.

ABC

#1	#2	1	2	3	4	5	6
		January	February	March	April	May	
3	Sales	\$20000.00	\$20000.00	\$20000.00	\$20000.00	\$20000.00	
5	Cost:						
6	Material	\$4000.00	\$4000.00	\$4000.00	\$4000.00	\$4000.00	
7	Labor	\$7000.00	\$7000.00	\$7000.00	\$7000.00	\$7000.00	
8	Overhead	\$4000.00	\$4000.00	\$4000.00	\$4000.00	\$4000.00	
10	Total Costs	\$15000.00	\$15000.00	\$15000.00	\$15000.00	\$15000.00	
15	Gross Profits	\$5000.00	\$5000.00	\$5000.00	\$5000.00	\$5000.00	

COMMAND Alpha Blank Copy Delete Edit Format Goto Help Insert Lock Move
Name Options Print Quit Sort Transfer Value Window Xternal
Select option or type command letter
R3C2 20000 96% Free Multiplan SP/N/CEP

Example of multiple windows

InfoWorld

Software Report Card

Cardbox

	Poor	Fair	Good	Excellent
Performance	<input type="checkbox"/>	<input type="checkbox"/>	<input type="checkbox"/>	<input checked="" type="checkbox"/>
Documentation	<input type="checkbox"/>	<input type="checkbox"/>	<input type="checkbox"/>	<input checked="" type="checkbox"/>
Ease of Use	<input type="checkbox"/>	<input type="checkbox"/>	<input type="checkbox"/>	<input checked="" type="checkbox"/>
Error Handling	<input type="checkbox"/>	<input type="checkbox"/>	<input type="checkbox"/>	<input checked="" type="checkbox"/>

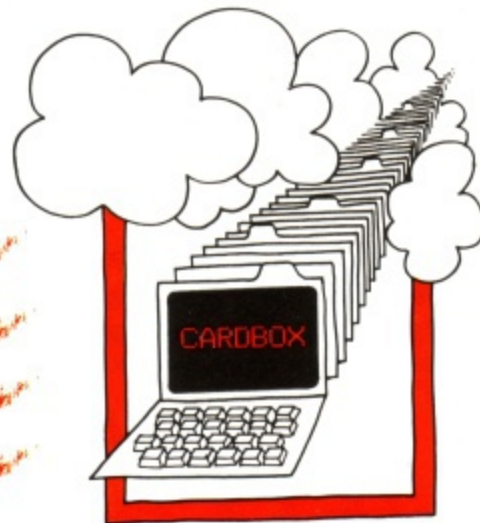

Why settle for less?

OK – so you've never heard of InfoWorld. That's hardly surprising because it's published in America. It does however happen to be one of the most widely-read software magazines in the world.

When we launched Cardbox several years ago, we sent a copy to the editor. Because the Americans have software products coming out of their ears, it was an honour when he decided to publish a review for us. Even more of an honour when we discovered what he thought of it! Over the past five years you could probably count on your fingers the number of products that have achieved this sort of acclaim.

Cardbox is simply an electronic card-indexing system – a replacement for the cards on your desk.

It's famous for the speed, and flexibility with which it can find cards for you. Unlike the cards on your desk, you can have any number of keywords on the card, anywhere in the entire file. Personal Computer World said "...from my initial tests, the fastest of any package I've evaluated so far..."

But it's not only fast. You can design the layout of the cards completely to your own requirements and find cards easier than by any other method. In fact, Computing Today proclaimed "This product is totally idiot-proof!"

You wouldn't use Cardbox to design an invoicing system, or produce calculated reports – it wasn't designed for that. But you would use it for keeping track of your enquiries, customers, suppliers, product details, membership

records, library details – or just about any other type of information you need to find quickly and easily. And because Cardbox links with CP/M word-processors like WordStar and New Word, if you require an easy to use, but superior mailing list facility, there's nothing better.

Furthermore, because Cardbox is so easy to use, we are able to offer you FREE and UNLIMITED telephone support. Should you need help just call us. Your call will be welcomed and your query will be answered in a pleasant, helpful and efficient manner – because that's the sort of people we are.

Cardbox is £99.99 (inc VAT).

Available for Amstrad 6128, 8256/8512,
IBM PC and all compatibles.

Caxton Software Limited
10-14 Bedford Street
Covent Garden
London WC2E 9HE
Tel: 01-379 6502.
Telex: 27950 ref 398



HOW TO TURN YOUR PCW8256/8512 INTO A BUSINESS WORKSTATION

SANDPIPER ACCOUNTS

A SIMPLIFIED INTEGRATED ACCOUNTING SYSTEM

Each transaction need only to be entered once,
all relevant ledger postings happen automatically at the time of posting.

Specially written for PCW8256

Utilizes the RAM Disk to eliminate the need for changing disks during the day.

Personalized Invoices/ statements/remittances

Produces Professional Documents with Full Business Details on Inexpensive blank paper thus improving your company's image. Designed to fit standard window envelopes.

Large file capacity

Sufficient Sales, Purchase, and Nominal Ledger Records may be kept for most businesses on 1 data disk.

Easy to use - Designed for inexperienced Users

Full instructions for use appear on the screen. The comprehensive manual need only be used for reference.

Full customer telephone support - available if required.

Sales Ledger

Invoice Posting
Cash Receipts
Debtors List
Statements

View Account

Purchase Ledger

Bill Posting
Cash Payments
Creditors List

Remittances
View Account

Name & Address Labels

Nominal Ledger

Lists of Accounts
Reports
Periodic Transactions
N.L. History

Cashbook

Bank Statement Entry
Full Reconciliation
Periodic Transaction
View

(gives TRUE cash status)

VAT Returns Invoicing/ Credit Notes

Single Drive System:

200 Accounts
(Sale, Purchase)
1000 Transactions
200 Nominal Accounts

Dual Drive System:

1000 Accounts
(Sales, Purchase)
4000 Transactions
200 Nominal Accounts

Management Reports

- 1) Stock Report
Value of Stock
Cost of Sales
- 2) Assets including
Depreciation
- 3) Prepayments &
Postpayments
- 4) Expenses
- 5) Profit & Loss
- 6) Balance Sheets

SANDPIPER PAYROLL

A SIMPLIFIED INTEGRATED PAYROLL SYSTEM

designed to be fully compliant with all current tax/National Insurance guidelines.

High capacity

up to 100 employees per data disk.

Department management

up to 100 departments may be held on each payroll data disk.

Tax compatible

handles all H, L, P, V, BR, D, NT, F tax codes both normal and week 1/month 1.

National Insurance compatible

contains N.I. tables A-C.

S.S.P. compatible

handles all S.S.P. rates and caters for full attendance records and automatic calculation of S.S.P. qualifying days and S.S.P. to be paid.

Additions and deductions

the system caters for 13 additions - pre and post tax - each of which may be pre-set (e.g. union) or entered for each period (e.g. expenses). The post tax tax deductions may also be factored on a sliding scale from the pay this period.

Overtime rates

caters for the 7 normal overtime rates.

Pension schemes

the system incorporates most pension schemes on fixed value or sliding scale.

Holiday pay

caters for statutory, unpaid and holidays at two rates with full records for the year.

Documents

the system caters for P35 and P60 prints as well as full employee details prints.

Annual updates for TAX and N.I. changes are available together with full software support if required.

SANDPIPER SOFTWARE LTD.

24 Abbot Street, Wrexham, Clwyd LL11 1TA. Tel: 0978 358832

Please send Sandpiper Accounts

Single Drive System **£129.95** inc VAT

Dual Drive System **£149.95** inc VAT

Please send Sandpiper Payroll

Single Drive System **£ 69.95** inc VAT

Dual Drive System **£ 79.95** inc VAT

Sandpiper Combination Packs:

Sandpiper Single Drive System Accounts &
Sandpiper Payroll **£179.95** inc VAT

Sandpiper Dual Drive System Accounts &
Sandpiper Payroll **£199.95** inc VAT

Please send for details: Sandpiper Accounts

I enclose cheque made payable to: Sandpiper Payroll

Sandpiper Software Limited

Please debit my ACCESS/VISA

Name _____

Address _____

Tel. No. _____

SANDPIPER

S O F T W A R E

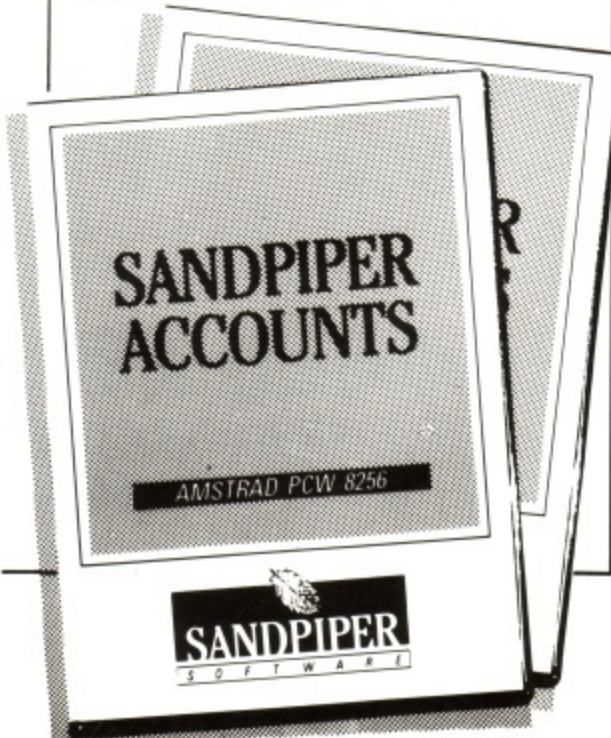



Tasword 8000, a speedy flexible friend

Tasword 8000 £24.95
Extra Fonts £14.95
Spellchecker £16.95 (available soon)
Tasman Software, Springfield House, Hyde Terrace, Leeds LS2 9LN

What you get in this package is the word processor, a mail merge program and a version of Tasprint which can produce all manner of fancy fonts – two of the eight available fonts are supplied with the package, the other six are supplied separately.

Getting in and on

The program is loaded under CP/M by typing TASWORD. You cannot load the files into the M: drive because that's where the program stores your text. Before the RAM drive is configured to hold the text the program first checks for typefaces on the program disc. Any that are there are loaded into memory. There is a long pause while the RAM disc is set up and then you're off.

One of the advantages of the original Tasword was its relative ease of use. The commands, be they cursor control or toggles for insert, justification and so on, were all quite logical. What's more you only had to glance up at the help window at the top of the screen to discover the command you needed and whether it was invoked using the Shift or Ctrl key. Tasword 8000 is altogether more powerful with many more features even than the 6128 version. The result is that the help menu is quite crowded and the Extra key is needed as well as the Alt and Shift. At first I thought things were getting a little out of hand but control of this beast is only a matter of familiarisation.

Editing

The edit page will be the first to greet you when you load Tasword. The chances are

the first file you will load will be the tutorial which is a very helpful chunk of text, well worth reading. As you work your way through it you are introduced to the different facilities of the program which are explained and demonstrated.

The tutorial file is 18k long and the loading time 19 seconds. Moving the cursor around the screen is quite fast – moving it from column 1 to column 80 took just over 3.5 seconds. Scrolling down 100 lines takes nearly 11 seconds. That time is for moving the cursor, although the screen can be scrolled up 100 lines in nine seconds using the fast scroll command.

Tasword 8000 stores text in the memory drive so depending on the size of your RAM disc you will have a maximum capacity of 100,000 characters (16,000 words) or 300,000 (48,000 words). Those who envisage using large text files might be interested in some timings. Rather than sit down and write a 100,000 character file I merged tutor into tutor until it was a file of 20,893 words or 114,000 characters in length. Getting around a document of this size would be quite problematical with Locoscript but Tasword laps it up.

Two commands are very useful, GOTO LINE and GOTO PAGE. Moving from page 1 to page 20 took 3.9 seconds. Using the line command was just as fast – line 1 to line 2100 took 3.5 seconds. Moving from the top to the bottom of the text file took the same 3.5 seconds.

Now for the all important save. Of course it goes without saying that a file this size can only be saved once on a 170k disc. There won't be room to have a back up so the old file would have to be deleted before the new one could be saved. On a clean disc the operation took 2 minutes and 54 seconds. Loading it back in took one minute less.

The range of editing commands are vast – have a look at the screen picture which shows the entire Help page, which gives you an idea of the facilities available. One notable feature is the Unerase command, which can only cope

The first version of Tasword 464 soon turned into 464 D when the Amstrad drives came on tap. When the 6128 machine appeared Tasman Software were right on its heels with the beefed up Tasword 6128. Now we have a Tasword for Joyce machines – Tasword 8000.

CAMSOFI

SOFTWARE PRODUCTS FOR MICROS

YOUR GUIDE TO SELECTING BUSINESS SOFTWARE FOR THE AMSTRAD 8256 / 8512

STEP 1. READ THE REVIEWS

"CAMBASE stands head and shoulders above the other two (Microgen and Ultrabase) in terms of what it can do. The serious user who requires a couple of hours each week with their database is invited to contact me if they know of a superior product. I certainly do not know of one for the Amstrad."

BUSINESS COMPUTING WITH AMSTRAD May 1986

STEP 2. LISTEN TO OTHER USERS

"My congratulations on the best system for micros (Integrated Accounts) I have experienced. The programmes are well documented, screen information superb, fast in file access and operation. Other software I have used in the past or tested often had severe limitations, yours excels all claims in your brochures."

V.A. Rose, Great Yarmouth

"I can't praise the program and your efforts enough. The word Database must be synonymous with Cambase."

F.V. Richard, Newton Abbot

STEP 3.

Visit one of our dealers, who will have CAMSOFT demonstration software to show you, and will be happy to discuss your business requirements.



BERNARDINI
GROUP OF COMPANIES

CAMSOFI's A to Z Guide on where to get help:-

ADSLIT	Birmingham, 021 622 5385	MICRO COMPUTER	Swynedd, 0492 623492
AZTECH COMSOFT	Reading, 0734 755234	MICRO HOME COMPUTERS	Drkney, 0856 5303
BASIC ENTERPRISES	Kettering, 0536 511115	MICROTECH	Bury, Lancs., 061 7976415
BELPER OFFICE MACHINES	Belper, 077 382 6692	MICROWAY	Rainham, Kent, 0634 371901
BUSINESS COMPUTER CENTRE	Telford, 0952 501754	MICRO SHOP	Great Yarmouth, 0493 842697
C.A.B. SYSTEMS	Bolton, 0942 815754	MICRO WISE	Reading, 0734 591816
CASTLE COMPUTERS	Lancaster, 0524 81133	MICRO WORLD	Huddersfield, 0484 846117
CELCOM SYSTEMS	Lancaster, 061 834 2808	MICRO WORLD	Downham Market, 0366 382123
CHIPBITS	Southampton, 0703 36048	MIDLAND COMPUTERS	Worcester, 0905 611072
CINEMA ONE	Derby, 0332 702988	MIDSMIRE	Crewe, 0270 589191
COMPTERBASE	Plymouth, 0752 672128	MIRAGE MICROCOMPUTERS	Stratree, 0376 48321
COMPUTER CENTRE	Hornchurch, 040 2475613	MODELS PLUS	Boston, 0205 65102
COMPUTER SOLUTIONS	Grimsby, 0472 43475	NORTHWICH COMPUTERS	Cheshire, 0506 47883
COMPTERWARE	Exeter, 0392 210507	OFFICE INTERNATIONAL	(Host Scottish Towns)
COMPUTING WORLD	Beverly, 0482 881831	OXFORD COMPUTER SUPPLIES	Oxford, 0865 716137
DIXONS	(contact your local branch)	PENORIGH COMPUTER REIGATE	Surry, 07372 21510
DONCASTER MICROS	Doncaster, 0302 742823	OTH COMPUTERS	RAINTON
EUREKA MARKETING	Keighley, 0535 680222	R.D. COMPUTER	ROGER BOOTH
EUSHAN MICROS	Evesham, 0385 49647	SEVEN COUNTIES	NEWCASTLE ON TYNE, 031 2811899
EXECUTIVE R & B	Hanchester, 061 228 1637	SHARP BUSINESS CENTRE	Rochester, 0709 548108
FAST FORWARD	Banbury, Oxon, 0295 4757	UPDATE OFFICE & RENTALS	West Lothian, 0506 847514
FOCUS POINT	Aldershot, 0252 333010	SOFTWARE ENCOUNTERS	Wills, 0843 295377
FORUM	Chard, Somerset, 0787 80240	TROUBRIDGE COMPUTER SHACK	Margate, 0202 888407
GATEWAY COMPUTERS	Halstead, Essex, 0792 893311	THANET COMPUTERS	Wimbome, 0329 239953
GORSEINON COMPUTING	Swansea, 0792 893311	THOUGHTWARE	Fareham, Hants, 0272 623861
GRAYFIELD	Aberdeen, 06516 446	TIMATIC SYSTEMS	Bristol, 0272 623861
HOBBYTE	St Albans, (and Luton) 0727 41396	TRYN DATA SUPPLIES	Stanford, 0780 65574
HONEYSETT COMPUTERS	Hereford, 0432 275404	ZEBRA MICRO	
INTER COUNTY	Letchworth, 0462 625609	CAMSOFI Approved Mail Order Suppliers:-	
IMPULSE COMPUTER	Sheffield, 0742 73594	GARWOOD (WHOLESALE)	0245 460788
KINGDOM BUSINESS	London SE22, 01 693 0266	GARWOOD (DISTRIBUTION)	0245 460788
LES COMPUTA	Aylesbury, Bucks, 0295 81458	GEN DISTRIBUTION	0279 444615
LEATHERLAND	Nottingham, 0602 412222	MICRO AIDS	092 576 2613
LECTRAC	Birmingham, 021 742 0622	NEUSTAR SOFTWARE	0277 220573
LINDEN COMPUTERS	Chichester, 0243 793746		
LIVSEY AUDIO VISUAL	Dartford, Kent, 0322 73128		
LOAD & RUN	Wolverhampton, 0902 25907		
MICRO BUSINESS	Merseyside, 051 6306973		
MICROBYTE			

The Camsofi Business range includes the following systems:-

CAMBASE DATABASE SYSTEM	£49.95
PAYROLL SYSTEM	£49.95
STOCK CONTROL SYSTEM	£49.95
INVOICING SYSTEM	£49.95
SALES LEDGER SYSTEM	£49.95
PURCHASE LEDGER SYSTEM	£49.95
NOMINAL LEDGER SYSTEM	£49.95
FULLY INTEGRATED SYSTEM CONSISTING OF STOCK CONTROL, INVOICING & SALES LEDGER	£99.95
FULLY INTEGRATED SYSTEM CONSISTING OF SALES, PURCHASE & NOMINAL LEDGER	£99.95
FULLY INTEGRATED SYSTEM CONSISTING OF STOCK CONTROL, INVOICING, SALES LEDGER, PURCHASE LEDGER & NOMINAL LEDGER	£149.95

All prices are inclusive of VAT and Carriage.

Cambrian Software Works Ltd, Unit 2, Maenofferen, Blaenau Ffestiniog, Gwynedd, Wales, U.K.
Telephone: 0766 831878
Telex: 666102 BB CO G. for Camsofi.

Name _____
Position _____
Company _____
Address _____

CAMSOFI
SOFTWARE PRODUCTS FOR MICROS

Cambrian Software Works Ltd
Unit 2, Maenofferen,
Blaenau Ffestiniog,
Gwynedd, Wales, UK
Telephone 0766 831878
Telex: 666102 BB CO G. for Camsofi

Please send me full details of your accounting systems.

AUB

with a line of text at a time but none the less it's nice to have it at hand.

A point to note is that Tasword 8000 allows you full control over the disc drives and the user areas on them. Moving from one user area to another is as simple as one could hope and for those with twin disc Joyces this can be a pretty useful facility.

Two features worth special mention are the note pads and custom text keys. From the editing screen the user can load into any one of the 20 keys up to 250 characters, so a total of 2,000 characters can be shared out among the keys. These can be used for storing your name and address and other chunks of text which you frequently use in documents.

The note pads are scribble areas, ideal for jotting down phrases or ideas which you may want to use later in a document but might forget in the meantime.

A special line mode has been added to aid the construction of tables and charts. Once you have switched into the mode you just use the cursor keys to draw the lines – a neat and useful utility.

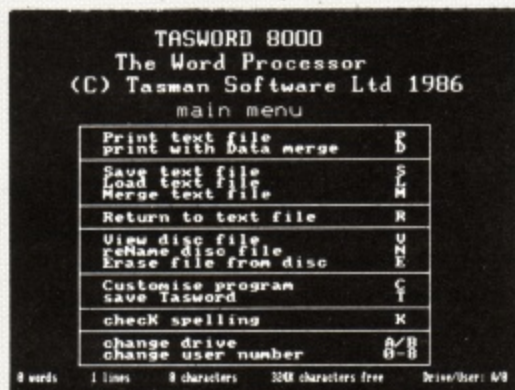

Tasword's main menu page

The main menu

Pressing exit from the editing page takes you to the main menu and from here you can get at the rest of Tasword's features. We'll take a quick look at each in turn.

Printing. This command will print out the current file. As with the earlier versions you are given a whole range of options which can be set up to meet a wide variety of requirements. Not only can you specify the part of a document to be printed in terms of page numbers (page 1-6), but the range can be set in terms of lines. So you could ask for only lines 34-76 of a document to be printed.

Other options let you set the number of copies, line spacing, printing headers or footers as well as page numbers. Further options let you specify the positions of these items on the page. Most of the options have default settings so you can either alter them as you please or just whiz past, hitting Return for each option. Alternatively pushing Copy will set the defaults and get straight on with the printing.

Printing is one of Tasword's strengths. It works very well with the Amstrad

DELETE/INSERT		CURSOR MOVEMENT	
DELETION: 3DEL to line end	3DEL to line start	↖ start of text	↗ left margin
↖ DEL word	↗ DEL line (un=CAN)	↘ end of text	↙ right margin
↘ CUT para	↙ DEL clear text	↖ start of line	↗ scroll up
↘ CUT block	↙ DEL clear text	↘ end of line	↙ scroll down
INSERTION: ↖ line/char	↗ insert on/off	↖ word left	↗ start of para
↘ COPY n/pad	↙ auto on/off	↘ word right	↙ end of para
merge-file		↖ goto line	↗ goto page
FORMATTING		MARGINS	
↖ move text left	TAB tab	↖ set left margin	↗ put marker
↘ centre line	↖ TAB reverse tab	↘ clear margins	↙ goto marker
↖ move text right	↗ TAB set tab	↖ set right margin	↗ and put marker
↘ rejustify paragraph	↖ TAB clear tab	↘ get ruler	↙ and next marker
↖ hard rejustify para	↗ reset tabs	↖ save ruler	↗ and prev. marker
↘ rejustify line	↖ clear tabs		
↖ unjustify line	↗ TAB numeric tab		
NOTEPADS		SPECIAL CHARACTERS	
↖ STOP notepad mode on/off	↗ mark start	↖ SPACE printer control char.	↗ SPACE extra char.
↘ DEL clear notepad	↖ mark end		
↖ STOP show all notepads	PASTE move		
↘ COPY text to notepad	COPY copy		
↘ COPY text from notepad	CUT delete		
FIND AND REPLACE		OTHER	
↖ R find and replace	↗ R find next	↖ get, ↗ put footer	↘ right justify on/off
		↖ get, ↗ put header	↘ Word Wrap on/off
		↖ get, ↗ put user key	↘ Insert mode on/off
		↖ lower to upper case	↘ Auto insert on/off
		↖ upper to lower case	↘ Page display on/off
		↖ transpose chars	↘ Numeric pad on/off
		EXIT save, load, print	↘ Help on/off
PRINTER CONTROL CHAR.		TABSTOP OPTION	
emphasised	superscript	1/6 line spacing	median
backspace	subscript	1/8 line spacing	lectura
condensed	italic	7/72 line spacing	compacta
double strike	underline	proportional	data run
elite	condensed-enlarged	high quality	palace
form feed	enlarged		outline
			ranchero
			breaker
			Tasprint off
			emph. double
			box inverse
			underline

The five main help screens all in one go

printer but should be able to fly just about any other make. The codes used to set up the variety of different types – enlarged, underline, condensed and so on – can be changed from the Customise Print menu, as can the printer initialisation code.

This technique may not be as simple as installing the program for a printer as with NewWord or SuperWriter, but it is just as effective and can often be more flexible.

Setting up a page with a variety of print styles is simplicity itself, and the overall page layout can be customised and saved.

Data merge. The mail merge capabilities of Tasword 8000 are a lot better than you might expect. Not only can the program maintain its own data files but

it will accept data files from other databases.

Conditional merging is permitted allowing you to print letters or invoices selectively from a large data file. A merge file can also accept input from the keyboard during the printing process as well as sequentially numbering the output documents using a NUMBER command. Label printing is made easier by Tasword's ability to send printer codes to the printing device.

Housekeeping. Tasword 8000's disc facilities have been enhanced by the commands which allow the user to view the contents of a file even while another is being edited – the effect is rather like using the type command from the main menu. Disc file can also be renamed or deleted. Changing drive or user area can

TASWORD 8000
The Word Processor
(C) Tasman Software Ltd 1986
Printer Control Characters

emphasised	27	69	a	27	70
backspace			b		
condensed	15		c	18	
double strike	27	71	d	27	72
elite	27	77	e	27	80
form feed	12		f	12	
superscript	27	83	g	27	84
subscript	27	83	h	27	84
italic	27	52	i	27	53
underline	32	27	j	27	45
condensed-enlarged	14	15	k	28	48
enlarged	14		l	28	18
1/6 line spacing	27	50	m	27	50
1/8 line spacing	27	48	n	27	50
7/72 line spacing	27	49	o	27	50
proportional	27	112	p	27	112
high quality	27	109	q	27	109

type letter (just RETURN if finished) █

This is where you learn to talk printer language

DID YOU KNOW YOUR PCW 8256 COULD DO THIS?

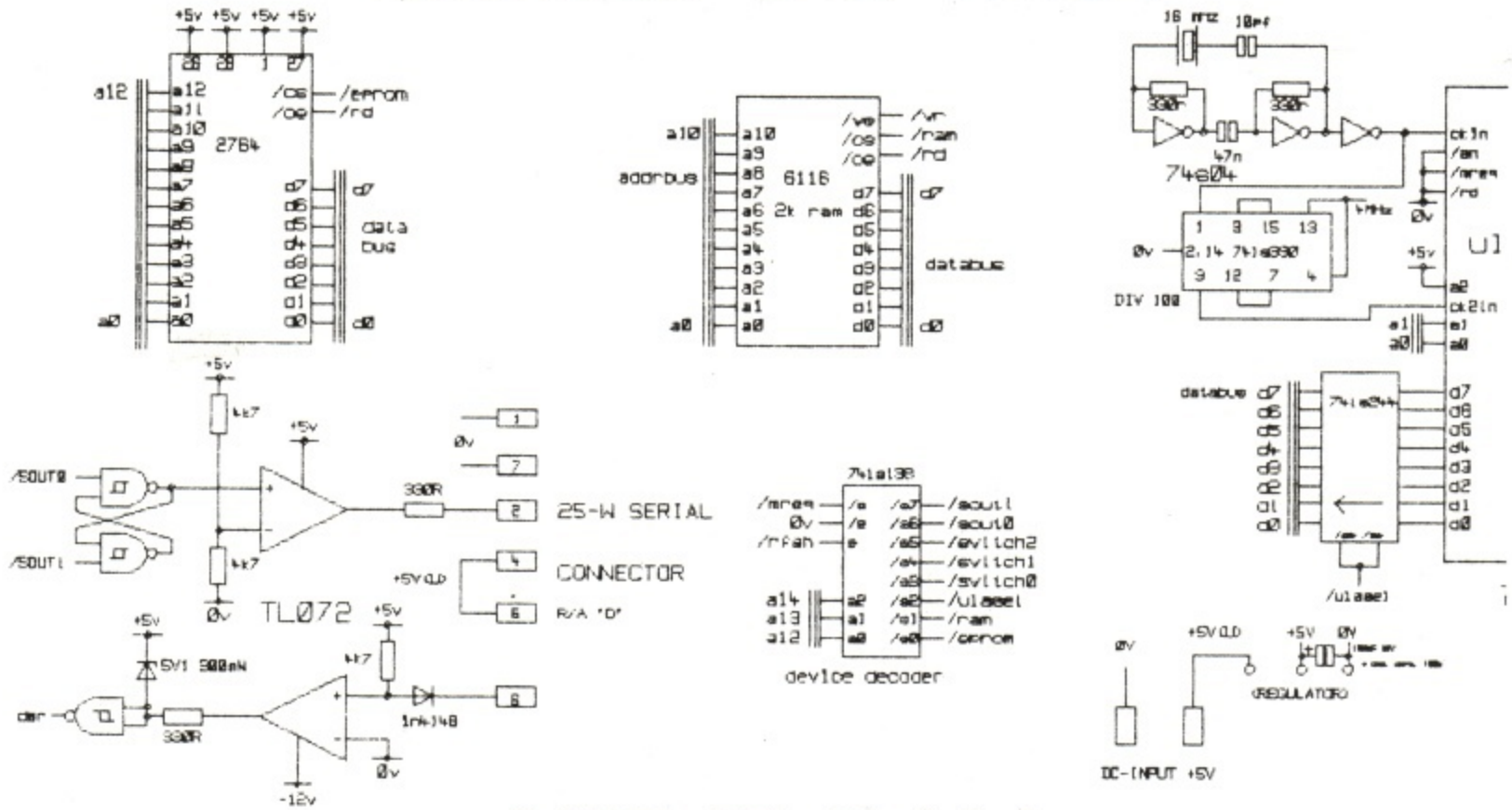

YES IT CAN

Because GRAFSALES Have Done It Again.

A unique Low Cost A4 Digitiser Tablet and C.A.D. Software package for use with the Amstrad PCW 8256 and 8512 Microcomputers. Together they form a complete draughting system representing an unprecedented Price/Performance breakthrough in the Computer Aided Design/Engineering Market.

The G3 Software which makes up this package is our own comprehensive C.A.D. programme. The programme is totally menu driven, the menu printed on the tablet overlay. Items are selected by moving the pen to the desired function on the menu and closing the Pen switch.

This sophisticated programme has built-in routines for Line drawing, Rectangles, Circles, Arcs, Zoom in and out,

Panning in all directions, Rotate and Tilt. Cursor co-ordinates are shown at all times for accurate placing of all the drawing functions.

Also included in the programme are facilities for Layers, Structures, Symbols etc. Because all the functions are selected from the Pad, almost the whole screen is available as a drawing area.

Hard copy of the whole or part of the drawing can be made using the Dot matrix printer supplied with the Amstrad Microcomputer or, with the aid of additional plotter driver routines, by a range of flat bed plotters.

This total package has been designed to ensure a powerful, easy and LOW COST entry into C.A.D.

GRAFPAD 3.
comprising the A4 Digitiser Tablet and G3 Software.

£149.50 INC. VAT

Grafpad 3 is available from your Amstrad dealer or direct from:
Grafsales Ltd., Unit Q2, Penfold Works, Imperial Way, Watford, WD2 4YY.

TO: GRAFSALES LIMITED, Unit Q2, Penfold Works, Imperial Way, Watford, Herts, WD2 4YY. Telephone: (0923) 43942 Telex: 946024.

Please supply me with _____ GRAFPAD 3(s) for my PCW 8256/8512 Micro at £149.50 plus £2.50 p&p, or plus £10 for Datapost delivery.
Please allow 28 days for delivery.

NAME _____ ADDRESS _____

I enclose cheque value £ _____ If you prefer to pay by Access or Barclaycard, please state which...

BARCLAYCARD ACCESS please tick box.

Card No. _____

be done from the main menu, or after the load or save commands have been selected.

Customising Tasword. There are so many features in Tasword which can be changed to suit your personal requirements or taste, I suspect many users will make changes to their working copies on a weekly basis.

From Page Layout you can set the number of lines to a page, the size of headers and footers, the codes obeyed as carriage return, line feed and form feed useful for cranky printers and making text files compatible with other word processors.

With Normal Print Characters Tasword 8000 allows you to assign up to 12 codes to any one normal character. When that character is sent to the printer it is the sequence selected by you which will actually be sent. This facility can be used to print all manner of weird characters.

For example, if you wanted to print a plus and minus sign you would assign the code for minus to a character followed by a backspace code and then the code for a plus. Advice for using this facility to get graphics out of the PCW is given in the manual.

Extra Character Set Print Characters is similar to the previous option but this time the codes are assigned to the second character set, the one with all the funny symbols that people seem to want these days.

The printer control codes option was mentioned earlier. If your printer can do it, this facility will make it.

The change program section allows the user to define the shape and type of the cursor, select the language for the different keyboard layouts found on international PCW machines and a few other wonderful things besides.

Overall

Overall I'm overawed except for a number of reservations which, as a user, I would learn to live with, rather than not use the package.

I dislike not being able to insert text without having to open up a line first. Tasword does have an automatic insert mode but it is appallingly slow and only really works for minor alterations. The mail merge is very good but it's a shame it can't reformat text where merged in data has thrown the original format. Nor will it keep a count on the lines if the number has increased due to merged in text, so the page starts shown on the screen will not necessarily correspond to the actual printout.

Tasword scores by being a better than average word processor with a useful mail merge, but its real strengths rest in its ability to control any printer and place just about any character, in a wide range

PRINTER CONTROL CHARACTERS			TABPRINT OPTION	
emphasised	superscript	1/6 line spacing	median	ranchero
backspace	subscript	1/8 line spacing	lectura	breaker
condensed	italic	7/2 line spacing	compacta	tasprint off
double strike	underline	proportional	data run	emph. box
elite	condensed-enlarged	high quality	palace	double inverse
form feed	enlarged		outline	underline
(capitals for on, lower case for off)				

Line 24|Col 1|Page 1|R/J on |W/W on |Insert off|Paging off|STOP for help|Numeric off|RB

From the screen to paper - the Tasword transformation

This is the median typeface

This is median emphasised

This is median in a box

Yes you guessed it, this is underline

Median in double strike

Median inverted which could be called Naidem

The rather flashy type face called compacta And now inverted.

THIS IS DATA RUN, YOU SEE SOMETHING LIKE THIS ON YOUR CHEQUES

This is outline but it isn't going to help you lose any weight

BREAKER BREAKER, THIS IS THE TYPEFACE FOR THE CB GANG

WANTED Dead Or Alive!

Simon Rockman for malingering

Rancho is just the face for writing the odd wanted poster.

of typestyles, on the paper. With very little work you could produce some exciting looking documents.

Tasword 8000 is faster than Locoscript and much more flexible if not quite as neat. There is a place for this word processor if only because of the immense

and precise control it gives the user over what actually gets on to the paper and the speed at which the thing works, plus the simple fact that the entire package is such good value for money. - JS



SOFTWARE Ltd
200 North Service Road
Brentwood, Essex
CM14 4SG

tel 0277 220573
tlx 995194 NEWSTA G
fax 0277 232637



Phone your order directly,
or ask at Amstrad dealers
displaying the NewStar
sign

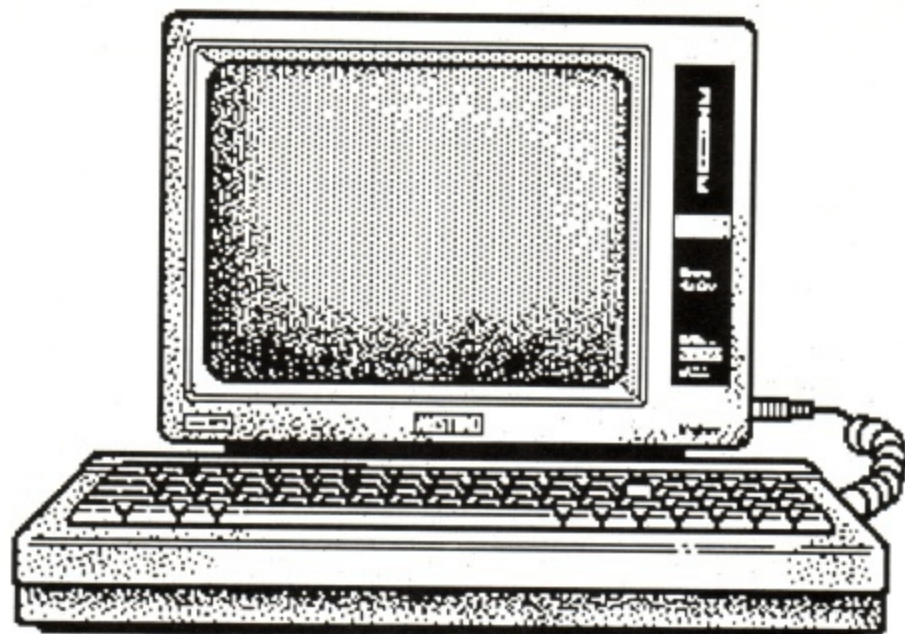

Choosing and buying software for the PCW 8256/8512
couldn't be easier. Get your copy of the *new* NewStar
Colour Software catalogue: packed with 40 pages of facts,
figures and useful product descriptions.

And remember: many NewStar products are designed to be
command and data-compatible with the IBM™ PC (and
compatibles), so your knowledge and data entry is
transportable if/when you upgrade!

General price list: all prices
include VAT. Please use the
stock codes when ordering

DATABASES

	Stk	Code	£.p
CAMBASE	031	090 510	£49.95
MICROFILE IBM	033	100 530	PO.A
MICROFILE PCW/CPC	035	100 530	£49.95
CARDBOX	035	110 520	£99.99
ATLAST	031	120 540	£49.95
TAS PCW	031	130 550	£99.95
TAS IBM	033	130 550	£199
DELTA 1.25	031	140 560	£99.99
dBASE II	031	150 540	PO.A
SAGE DATABASE	031	180 460	£69.99
EXECUTIVE FILER	033	070 640	£49.95
CONDOR 1	031	110 560	£99.99

SPREADSHEETS

MULTIPLAN PCW/CPC	025	030 310	£69.99
MULTIPLAN IBM	023	030 310	PO.A
CRACKER 2 PCW/CPC	025	040 320	£49.00
CRACKER 2 IBM	023	040 320	PO.A
SUPERCALC 2 PCW	025	050 330	£49.95
V P PLANNNER	023	070 250	£99.00
NUMBER WORKS	023	070 620	£29.95
SCRATCH PAD PLUS	025	110 660	£69.99

COMMUNICATIONS

COMM PLUS	051	130 520	£86.25
NEWCOMM C-STAM PCW	051	040 530	£49.95
NEWCOMM C-STAM IBM	053	040 530	£49.95
NEWCOMM DATAMAIL	051	040 540	£39.95
CHIT-CHAT E-MAIL	051	180 310	£69.99
CHIT-CHAT VIEWDATA	051	180 320	£69.99
CHIT-CHAT COMBO	050	180 330	£99.99

GRAPHICS

POLYPLOT	011	010 110	£24.95
POLYPRINT TYPEFACE 1	011	010 120	£29.90
POLY TYPEFACES 2 & 3	011	010 310	£19.95
FULL POLY SYSTEM	011	010 130	£59.80
DR DRAW	015	020 340	£49.95
DR GRAPH	015	020 350	£49.95
DRAW IT IBM PC	013	070 650	£24.95

WORDPROCESSING & UTILITIES

NewWord 2 PCW	071	080 410	£69.00
NewWord 2 CPC	072	080 420	£69.00
NewWord 2 CPM80	074	080 430	£99.00
NewWord 2 16 BIT IBM	073	080 440	£149.00
NewWord 2 16 BIT CPM80	074	080 440	£149.00
NewWord 3 16 BIT IBM	073	080 450	£249.00
NewWord 3 16 BIT CPM86	074	080 450	£249.00
NewWord Example DISC 1	075	080 310	£9.95
NEWSPOOL	tba		£19.95
NEWMAIL	075	080 620	£29.95
NEWTAG	075	080 630	£14.95
NEWSEARCH	075	080 640	£14.95
NEWFILE MANAGER	075	080 650	£29.95
SUPERWRITER CPM 80	075	340 660	£49.95
EXECUTIVE WRITER	073	070 620	£49.95
PAPERBACK WRITER	073	070 630	£29.95
PAPERBACK SPELLER	073	070 640	£39.95
POLYMAIL	071	010 210	£19.95

PLANNERS AND ORGANISERS

BRAINSTORM	085	110 520	£49.95
TARGET TASK	081	060 530	£99.99
PC OUTLINE	083	200 550	£69.00
PERTMASTER	080	350 530	£69.00

GAMES

HITCHHIKER'S GUIDE	065	260 320	£29.95
HITCHHIKER'S HINTS	060	260 330	£5.75
CLASSIC ADVENTURE	065	270 440	£14.95
with MORDON'S QUEST			
3D CP-CHESS	061	280 450	£14.95
CYRUS II CHESS	tba		£14.95

TUTORIALS

LOCOSCRIPT Audio tutor	090	160 210	£9.95
NEWWORD Audio tutor	090	160 220	£9.95
CP/M & BASIC Audio tutor	090	160 230	£9.95
SUPERCALC 2 Audio tutor	090	160 240	£9.95
MULTIPLAN Audio tutor	090	160 250	£6.95
TOUCH 'N' GO	095	110 260	£24.95
CRASH COURSE	095	290 260	£24.95
TWO FINGERS	095	290 240	£24.95

ACCOUNTS CAMSOFT

INVOICING SYSTEM	041	090 110	£49.95
STOCK CONTROL	041	090 120	£49.95
SALES Ledger	041	090 130	£49.95
PURCHASE Ledger	041	090 140	£49.95
NOMINAL Ledger	041	090 150	£49.95
PSPN	041	090 160	£99.95
PSIS	041	090 210	£99.95
PSIL	041	090 220	£149.95
PAYROLL	041	090 230	£49.95

COMPACT

SALES INVOICING PCW	041	190 110	£69.99
SALES Ledger PCW	041	190 120	£69.99
PURCHASE Ledger PCW	041	190 130	£69.99
NOMINAL Ledger PCW	041	190 140	£69.99
STOCK CONTROL PCW	041	190 150	£69.99
PAYROLL PCW	041	190 160	£99.99
ACCOUNTS PCW	041	190 240	£199.99
DAYBOOK PCW	041	190 440	£49.95

MAP for the PCW series:-

PAYROLL	041	220 210	£49.95
SALES Ledger + Invoicing	041	220 220	£49.95
PURCHASE Ledger	041	220 230	£49.95
NOMINAL Ledger	041	220 240	£49.95
STOCK CONTROL	041	220 250	£49.95
SALES Purchase, & Nom	041	220 560	£99.95
STOCK Invoicing & Sales	041	220 660	£99.95
INTEGRATED ACCOUNTS	041	220 310	£149.95
JOB COSTING	041	220 550	PO.A

SAGE

POPULAR ACS PLUS	041	180 340	£149.99
POPULAR SUPER COMBO	041	180 350	£199.99
STOCK AND INVOICING	041	180 360	£69.99
POPULAR PAYROLL	041	180 410	£69.99
POPULAR ACCOUNTS	041	180 420	£99.99
POPULAR COMBO	041	180 430	£149.99

MISC:-

ABCS COMBINED	041	050 430	£99.00
ABCS NOMINAL	041	050 440	£33.00
ABCS PURCHASE	041	050 450	£33.00
SAXON CASHBOOK	041	100 460	£49.00
MICRO Simplex Cashbook	041	250 140	£99.99

Sections reprinted
with kind permission of

Punch
WEEKLY 65
March 28, 1984

“...What you all need is BrainStorm, a remarkably intelligent notion from Caxton Software...The principle behind the program is so obvious that one wonders why it hasn't been thought of before. It is this: when you start thinking about something which is eventually going to be structured and ordered, you initially think in random jumps. Unconnected ideas flash into the brain...

Then begins the long slow laborious business of putting them together in some sort of order. Does this bit go with that bit or the other? Have I already made that point? Do I need to remind them of this when I mention that a second time? How much longer can I walk around scratching my bum and smoking before someone asks why haven't I finished?...

BrainStorm answers all these questions with great simplicity. Essentially it is a *list organiser*. You start with a more-or-less blank screen. You can either plan your main headings now, or start entering jottings at random. Most people go for a half-way house; perhaps you can put down "Beginning, Middle, End", as your three headings. Then start putting down your ideas. Pretty soon BrainStorm will follow your thoughts and start making interconnections on the basis of word-matches...

Using it while writing this review has been a salutary experience. Couldn't manage being without it now, whether for organising production schedules for these pages, planning our longer articles elsewhere in the magazine, or writing speeches...

Hitch-hiker wizard *Douglas Adams* is said to be delighted with his...

Takes about 30 minutes to learn to use it...

Because our products are so simple to use, we are able to offer **FREE** and **UNLIMITED** telephone support on all of them. Should you need help with BrainStorm just call us. Your call will be welcomed and your query will be answered in a pleasant, helpful and efficient manner – because that's the sort of people we are.

BrainStorm is £49.99 (inc VAT).

Available for Amstrad 6128, 8256/8512, IBM PC and all compatibles.

Caxton Software Limited
10-14 Bedford Street
Covent Garden
London WC2E 9HE
Tel: 01-379 6502.
Telex: 27950 ref 398



“There is
no other
way of
doing the
job nor
any other
program
which
does it”

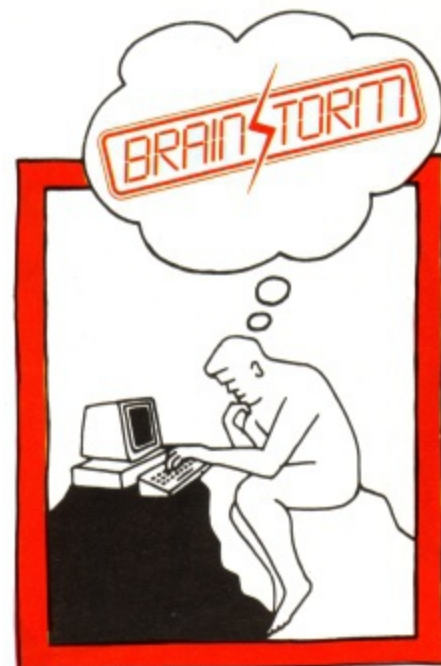

The Ideas Processor

Our Software works to end your paperwork

If you run a small business you'll know, only too well, how much unproductive time you spend on that necessary evil, paperwork.

Quest Business Software for the AMSTRAD, IBM and COMPATIBLES and most CP/M micros will, quite simply, relieve you of the paperwork millstone and can PAY FOR ITSELF in as little as ONE MONTH by dramatically increasing your efficiency and profitability.

Since our award winning CASH TRADER was published last year we've considerably expanded our range of Business Software to save you time on accounting, searching through files, typing letters and producing reports.

As many of our packages are available for evaluation prior to outright purchase, you've everything to gain by ordering today. Just because our software costs less it doesn't mean that we've cut corners or skimmed on detail – thousands of users, world wide, will testify to that!

All Quest Business Software is very easy to use and we've paid particular attention to provide detailed documentation, and, should you need it, Ongoing support.

You could say that we haven't slept ...
... So you can.

Z Z Z Z
Z Z Z Z
Z Z Z Z

AMSTRAD BUSINESS CONTROL SYSTEM* QUEST BUSINESS CONTROL SYSTEM*

THE LOW-COST FULLY INTEGRATED ACCOUNTING SYSTEM WITH
OVER 30,000 USERS WORLDWIDE!

"Behaves like much more expensive software, and is well structured" 'What Micro' Feb. '86.

These accounting systems designed for the Amstrad, IBM (and compatibles) and most CP/M micros put the power of fully integrated accounting within even the smallest budget. The three modules, of which the system comprises, are Sales Ledger/ Invoicing/Stock Control : Purchase Ledger : Nominal Ledger. Modules may be purchased independently if required and full software support is available.

All packages are fully documented

EVALUATION COPY ONLY £19.95!

CASH TRADER*+

"If your paperwork tends to be somewhat haphazard, Cash Trader is brilliant at creating order out of chaos" – 'What Micro' Feb. '86.

Cash Trader has sold over 5,500 copies since its launch last year and has been universally acclaimed. Designed for business people – not accountants – Cash Trader is as easy to use as a Cashbook with the added advantages of automatic totalling and cross costing, the ability to produce printed reports for VAT and Auditors' requirements and the tremendous benefit of accepting ANY TYPE OF ENTRY in ANY ORDER – eliminating tedious manual paperwork sorting.

Additional reports from CASH TRADER may be simply produced with ANALYSER – a low cost add-on module.

Cash Trader and Analyser are supplied with full documentation and software support, if required.

... "an outstanding and original contribution to business profitability and efficiency" The Standard Micro Business Awards. Sept. 1985.

EVALUATION COPY ONLY £19.95!

* For Amstrad PCW8256/8512, CPC6128, 664 and 464 (Twin Drive)

** IBM, Compatibles and most MSDOS or CP/M micros, Cash Trader can run on a single drive.



JOHN BEAVAN ASSOCIATES
PROFESSIONAL SOFTWARE for
PROFESSIONAL USERS for the PCW8256
and PCW8512. For the systems you need
to make your business more profitable.

DATABASES

Caxton Cardbox	99.99
Sage Database	69.99
Delta	99.99
dBase II	119.00

SPREADSHEETS

Supercalc	49.99
Multiplan	69.00
Scratchpad Plus	69.99

WORDPROCESSING

Pocket Wordstar	49.95
Pocket Wordstar Professional	69.95
Superwriter	49.95
SPECIAL Superwriter PLUS Supercalc	95.00

COMMUNICATIONS

	S/W	+ Modem
Chit-Chat 'E-Mail'	69.00	199.99
Chit-Chat 'Viewdata'	69.99	199.99
Chit-Chat Combo (both of above)	99.99	239.99

ACCOUNTS

Sage Popular	99.99
Sage Popular Payroll	69.99
Sage Stock and Invoicing	69.99
Sage Popular Plus (accounts & invoicing)	149.99
Sage Popular Combo (accounts & payroll)	149.99
Sage Combo Plus (accounts, invoicing & payroll)	199.99

LANGUAGES

DR CBasic compiler	49.95
DR Pascal/MT+	49.95

All our prices include VAT and postage. There is nothing extra to pay.

For advice or more information ring our Bristol office on 0272 540024 or our London office on 01 441 7581. Or fill in the coupon and send it to John Beavan Associates, 63 York Road, Montpelier, Bristol BS6 5QD.

Callers by appointment only please.

Please send me the following items

Quantity	Product	Price (inc VAT)
_____	_____	_____
_____	_____	_____
TOTAL		_____

Name _____
 Address _____
 Postcode _____ Day Tel _____
 Signed _____

Send to **John Beavan Associates**
63 York Road, Montpelier Bristol BS6 5QD

SPEEDYSOFT

024 026 3703 (24 HRS)

ALL ORDERS NORMALLY DESPATCHED
 THE SAME DAY WE RECEIVE THEM

SEND £1 (refunded with first order) for 48-PAGE ILLUSTRATED CATALOGUE. 3" BLANK DISCS: £4 EACH or £37.50 for 10

AUDIO TUTORS ... NEW!

Each tutor contains two sound cassettes with 4 x 45-minute lessons which teach you as you listen and operate your computer. Order from 1. AUDIO LOCOSCRIP, 2. AUDIO CP/M PLUS AND BASIC, 3. AUDIO SUPERCLAC2, 4. AUDIO NEWWORD. Each audio tutor is for 8256/8512 and costs £9.95.

BRAINSTORM NEW!

"Essentially it is a list organiser ... couldn't manage without it now, whether for organising production schedules, planning our longer articles or writing speeches ... takes about 30 minutes to learn to use it." (Punch) 8256/8512. (Caxton) Disc £49.99

3D CLOCK CHESS

THE CHOICE OF THE BRITISH CHESS CHAMPION
 "An excellent chess program that will test even stronger players." (Amstrad Action 06/86) "I can confidently recommend this to all lovers of the Royal Game." (Jon Speelman, British Chess Champion)
 8256/8512. (CP Software) Disc £19.95

DATAGEM NEW!

The only database actually designed for the Amstrad. The state-of-the-art and uses all the features of your computer to their best advantage.
 8256/8512. (Gemini) Disc £30.95

"GREAT SERVICE, FASTEST YET!"
 (A. BONES, SCOTLAND)

GRAPHIC ADVENTURE CREATOR

"The most astounding program I've ever encountered on an 8-bit machine ... those who want to write adventures will find there is no better value-for-money product on the market." (Amix 12/85)
 464/664/6128/8256/8512 (Incentive) Cassette £22.95 Disc £17.95

THE KNIFE NEW

THE DISC SECTOR EDITOR.
 "If you need to repair your disc, examine other people's discs, or simply learn about how CP/M and AMSDOS use the discs, then this package is for you." (Amstrad User 06/86) 464/664/6128/8256/8512 (Hisoft) Disc £12.95

PROTECT/PROSPELL/PROMERGE

THE COMPLETE AMSTRAD WORD PROCESSOR KIT.
 "IT IS SUPERB. (PopCompWkly) "An excellent program" (Amstrad Action)
 464/664/6123. PROTEXT word processor: Disc £26.95. PROSPELL spelling checker: Disc £24.95. PROMERGE+ mailmerge: Disc £24.95.

SIMPLE ACCOUNTS NEW!

THE SIMPLES ACCOUNTING PACKAGE OF ALL.
 "Most definitely, this system removes most of the chore from doing the books, including the dreaded VAT." (Computing with Amstrad 12/85)
 464/664/6128/8256/8512 (Cormix) Disc (versions differ) £34.95.

"EXCELLENT CATALOGUE."
 (P. PUMFORD, CLWYD)

SUPERCALC 2

THE PERFECTLY SIMPLE SPREADSHEET
 "There is little to challenge Supercalc2 which is another extremely famous and respected business program, but sold at a giveaway £49.95." (Popular Computing Weekly 04/86)
 6128/8256/8512. (Amsoft/Sorcim/IUS) Disc £49.95.

TOUCH 'N' GO

"My typing has certainly improved ... arcade addicts could do worse than try this if they want faster fingers." (Computing with Amstrad 06/86)
 6128/8256/8512 (Caxton) £24.99

TAPE/DISC TRANSFER

TRANSMAT Disc works best for only £11.45. SPIRIT will transfer headerless programs to disc for £5.95 (cassette only.) And ODDJOB is the complete disc utility for only £12.95. All program by Pride.

HOW TO ORDER

UK prices include VAT. Export prices are the same, because of the extra work involved. Remember to add postage & packing: UK £1 per order; Europe £1.50 per program; Outside Europe £2.00 per program. Satisfied customers in 64 countries. To order quote reference 'AMU16'.
 BY PHONE: Call 024 026 3703, 24 hrs a day. Leave your name, address, phone number, order, computer type, credit card number, expiry date.
 BY POST: Send your order to SPEEDYSOFT, The Blacksmiths, Radnage Common, Bucks HP14 4DH, England. Make sterling cheque/PO payable to Speedysoft. Don't forget to add p&p.



VISA
 ACCESS
 EUROCARD
 MASTERCARD



ABC

FORUM

From next month we will be running letters in two sections. Forum will continue to be the area for airing your opinions, praise and grievances but please address any technical queries and tips to: TechLet, ABC, 169 Kings Road, Brentwood, Essex CM14 4EF.

Ears only for me . . .

After reading your magazine for the past few months I came up with a few things that seem to me quite important. So here they are:

1. Don't listen to reader Geoff Barnard with his benchmark timings for Digital Research's C-Basic Compiler (ABC Forum March). His timing may be accurate for test programs that do not define numerical variable as integers, but if they are defined as integers then Wham! - this is where you get the speed.

He remarks that the same rewrite would probably improve the timings for Mallard Basic too. However this is not the case. The improvement in speed in Mallard is nowhere near so great as when integers are used in C-Basic.

I nearly didn't buy the package after reading Mr Barnard's comments but I'm glad I did. The package is excellent. But if you want speed, use integers!

2. Don't listen to reader W.G. Crampton's comments on Digital Research's DR Draw package (ACU Write to reply, April). Again, as a result of reading this letter I almost forsook buying it. W.G. Crampton comments: "The instructions for preparing an operating disc were beyond my limited comprehension". Perhaps this was an older release because setting up the package as far as I was concerned was quite simple. Take the DR disc, stick it in, type M: then type A:SUBMIT AMAKE8256, and watch it go. Of course a blank disc is needed too. Hardly complicated. I thought the way the package installed itself was brilliant.

I'm not getting at W.G. Crampton, but I think potential buyers of DR Draw ought to know that it's not as bad as it's made out to be.

3. Don't listen to reader B.L. Hanks (REMs, June) when he asks for "less ABC". There are an awful lot of Joyce owners around who are dying for information on programs, routines and so on - especially me! The articles on GSX are great. Let's have more - how about a series of articles on CP/M Assembler?

Talking of CP/M Assembler, be careful of Ian Sinclair's new book, *Introducing Amstrad CP/M Assembly Language*. Although it says that it can be used with the Joyce, this is not entirely true. One gets the impression that it was written for the CPC6128 and when the Joyce became popular references to that machine were thrown in.

A Joyce owner would probably be puzzled by references to the ROM in his or her machine. Also, some programs in the book - the best ones - are for the CPC6128 only, so watch out. I get the impression that Ian Sinclair quickly searched through the proofs adding "or PCW8256" to all the references to the CPC6128.

4. Don't listen to Stuart Cole in his article on Jetsam (June issue) when he implies that the return value of ADDREC can be used to ascertain if the disc is full. ADDREC can return four values and not one of them will tell you that the disc is full.

If you try adding a record to a Jetsam file and the disc is full you will receive error number 61 (yes, you've guessed it, "Disc full"), the file is marked inconsistent and you've lost the file forever. I know, I've tried it many times.

What Jetsam does is to mark the file as inconsistent and then close it. If you try re-opening it you will receive error number 115 - "Inconsistent files". As the manual so charmingly puts it, "The user should turn to the latest back-up copy". The only way round the problem, as far as I can see, is to check that there's enough room on the disc before adding records.

5. Don't be fooled into thinking that adding an extra 256k of memory to your Joyce is a straightforward task if you've got an earlier model. I sent off for eight extra chips from Addons of Southampton thinking that all that would be required would be to open up the machine and stick them in the empty sockets.

Not so. I can handle taking the circuit board out to get the chips in, but when I also had to get out my ageing soldering iron to remove a link and solder it on the board elsewhere I nearly threw a wobbler! I did it, but I can tell you - I didn't half sweat! Apparently, later models have a switch that can be simply thrown, but the earlier models don't. So be careful all you Joyce owners without soldering irons, because the adverts don't tell you about it.

Well, that's all the don'ts I can think of for now. On a positive note, I would like to say that I think ACU is excellent, but I think it would be even better if there were more Joyce owners in it. How about enlarging ABC by a few pages?

Phil Meager,
Anglesey,
North Wales.

ABC: Well, after reading this I wonder why I bother to get out of bed. Then I wouldn't have to listen to anyone (especially if the landlord can keep Rockcake at bay). Thank you for the advice Phil, I'm sure it will be welcomed by many.

Many thanks as well for your comments on ABC - the news about the staples should please you and this does mean we will have room to publish the ding dong that's bound to follow this letter. Hear from someone soon no doubt.

Games please

I have recently bought a PCW8256 and I am slowly learning to carry out only the

IT'S HERE
the simple to use

FIRST DATABASE

for the Amstrad PCW 8256/8512

Written as an easy to use introduction into the Database world — to help you discover exactly what your needs are — it may be that this database will cover them all!

- * Merge with the resident Amstrad wordprocessor
- * Fast access by Key Field * Search and Sort
- * Reports and Totals * Over 250 Fields
- * Outputs ASCII files for transfer in the future to more complex databases (including Minerva developments)

£29.95

INSTANT ACCESS

another innovation from Minerva Systems
programming utilities for the Amstrad CPC series

- * Provides random access filing which is lacking in the Amstrad CPC computers
- * Programmable from within your applications
- * Proven techniques as used in our own random access database
- * Professional style editors — sector editing and error handling commands
- * BASIC enhanced commands include IEXEC to evaluate BASIC statements from within your program.

£29.95



Prices include VAT & P.&P to U.K.



THE ALL POWERFUL RANDOM ACCESS DATABASE

for the Amstrad CPC 6128/664/464

- * Finds records in seconds not minutes!
- * Outdates, out-performs databases twice the price!
- * Mix 80 & 40 chrs on screen and to the printer
- * True Random Access operating with 170K disc storage * 6000 records (2970 on 664 or 464)
- * 40 fields per record * Over 250 chrs in each field
- * Extensive calculations * Multiple print formats, letters, labels, lists, etc. * Versatile sorting * Written in machine code and BASIC for speed & flexibility.

£39.95



MINERVA
69, SIDWELL STREET, EXETER, DEVON. EX4 6PH
Telephone: 0392 37756

PLEASE RUSH ME BY RETURN POST :

First Database R.A. Database Instant Access

Cheque/Access No.

Signed

OR I NEED MORE DETAILS FAST FOR :

Amstrad 8256 8512 6128 664 464

Name

Address

Ref.AA86

Pulse Software

AMSTRAD DEDICATED BUSINESS SOFTWARE SPECIALISTS

SAGESOFT		DIGITAL		CAXTON	
Accounts	79.00	Pascal MT+	45.00	Brainstorm	36.00
Accounts+	120.00	C Basic	45.00	Smartkey	36.00
Combo Pack	127.00	DR Graph	45.00	Touch 'n' Go	20.00
Super Combo	167.00	DR Draw	45.00	Cardbox	75.00
Invoicing	50.00			Scratchpad+	56.00
Magic Filer	57.00	COMPACT		HISOFT	
Payroll	50.00	Daybook	42.00	Pascal 80	32.00
Retrieve	59.00	Accounts	185.00	Devpac 80	32.00
Chit-Chat:		Sales Ledger	55.00	C Compiler	32.00
Viewdata	50.00	Sales Invoicing	55.00		
E Mail	50.00	Purchase Ledger	55.00	MISC.	
Combo Pack	80.00	Payroll	85.00	Supercalc II	37.00
Viewdata with Modem	180.00	Nucleus	85.00	D Base II	99.00
E Mail with Modem	180.00	Nominal Ledger	55.00		
Combo Pack with Modem	210.00	Stock Control	55.00		
		Interfacer	55.00		

ALL PRICES INCLUDE VAT AND POSTAGE

Pulse Software, Leyton Industrial Village, Argall Avenue, Leyton, London E10 7QP.

Callers by appointment only.

Telephone: 01-558 7100

most basic of tasks. I would be very interested to learn, however, whether or not there are any games available on software suitable for this machine.

I am well aware that the hardware is designed for rather more practical matters but I would also like to be able to entertain myself with some of the excellent software currently available. Alternatively, is it possible to write one's own games programs using the CP/M software?

Any help you can give will be most welcome.

Peter J. Moorhouse,
Nottingham.

ABC: I presume you are interested in games other than adventures, which are quite plentiful on the Joyce. Apart from a couple of chess games and a PacMan game - currently under development at a secret location - I can think of no others.

However the chess games (one from CPS and another from Amsoft, reviewed next month) have excellent graphics - much better than I would have thought possible - so there is hope.

There might be a shortage of arcade games but there is no shortage of rumours about such games being developed. Now that the games software houses (Melbourne House to name one) are waking up to the fact that there is a demand I am certain it is only a matter of time before some reasonable products reach the market.

One other source worth exploring is the public domain network. There are a variety of games written to work under CP/M (strategy games mostly) and they are all free.

If any bright spark among you has written a game perhaps you might let me know - perhaps we could have a competition.

● Stop Press: Ocean have released Batman.

Bamboozled

I am the proud owner of the inventory licensed trade computer control system run from an 80k Husky Hunter computer, storage being made to a Cristie cassette recorder and printing on to a Riteman II 80-column printer.

I am considering buying a CPC6128 and I am wondering if I can use the printer mentioned with this machine. I would be grateful for any information you can give me including communication between my Hunter and the CPC6128.

J. McNulty,

Glenrothes.

ABC: Ashamed as I am to admit it, I know nothing at all about the Husky micro. As far as communications between it and an Amstrad are concerned you might be in with a chance if your

Husky has a serial interface (RS232). You will need to acquire said interface for the Amstrad as well.

I believe I am correct in thinking that a Riteman is Epson compatible in which case you shouldn't have any problems. I notice that the Riteman printer comes with a Centronics input as standard so that should match up with the Centronics port on the 6128.

After Locoscript, the world

I am one of the many people who bought a PCW8256 specifically because of its word processing facilities. At the time I had absolutely no intention of using the personal computer facilities. However, having sorted out the problems involved in making Locoscript function, I am now prepared to tackle the personal computer potential. The challenge of solving the Locoscript bugs has given me the confidence to feel that "computers" are not so hard or boring to learn to use after all.

Nevertheless I have found it difficult to find a source of general advice on programming that is suitable for the non-expert. There does not seem to be a book available that can advise one on the merits and disadvantages of different programming languages and database management systems.

It has been suggested to me that rather than spend a great deal of time learning how to come to grips with Basic, I would be better off with the database management system Dbase II. I would therefore be grateful if you could explain the difference between a programming language and a database management system.

C.M. Pulteney,
Somerset.

ABC: Your references to programming and sorting out Locoscript problems got me wondering. Surely you haven't rewritten the thing?

I suppose it's reasonable to talk about Basic and Dbase II as both being computer languages in that they are both high level - nearer to the way humans communicate than the way computers do - means of imposing our desires on a computer. But Dbase II is limited because it has a specific application in life, namely to coordinate and process computerised data. Basic (Beginners All-purpose Symbolic Instruction Code) is much easier to learn and far more flexible. Not only could you write some reasonable games in Basic but you could write a limited database as well.

If you are learning programming for the first time then either Basic or Pascal is ideal. You already have a pretty smart Basic, namely Mallard. It's ideal for

producing a wide range of applications but the fun you can derive from it is limited by the 8256's own shortcomings - no sound or colour.

In the not too distant future we will be running articles about the various languages available for running under CP/M Plus but in the meantime if you fancy dabbling with Pascal or even C then I suggest you get in touch with Software ToolShop who would be willing and able to set you straight.

Reading backwards

As a PCW8256 owner I find that the middle section of your magazine is practically the only part of relevance to me, since I suspect that the other programs listed only apply to the CPC machines - why can't the articles say CPC ONLY at the top?

So I am disappointed that ABC forms such a small part of the magazine, and I would like to see this considerably expanded, with a lot more articles plugging the gaps in the inadequate documentation supplied with the system. I think that knocking off the serifs from the VDU display is a skill one least needs to acquire, but I suppose it does give some insight into the capabilities of the Joyce.

Why can't you have a series of articles which start at the beginning, rather than assuming that your readers know something about PCW assembler? Where is one supposed to acquire this knowledge when the documentation doesn't come supplied with the machine?

Is it possible to get back numbers of ABC only, which should be free or considerably discounted to PCW owners? Are there any listings available for the PCW? What public domain software exists, and how is it acquired?

Practically all the products available at discounts to members of the user club, which I recently joined, are for CPC computers. There seems to be practically no advantage at present for a Joyce owner joining this club. Are there so few that this minority interest is of little concern to Amstrad?

J. Charlton,
Orpington,
Kent.

ABC: No doubt your complaint about the size of ABC has been resolved. We might be having a coming out party but I'm not sure if the tea kitty could stand it.

I thought all our articles began at the beginning - you must be reading them back to front! Seriously though, I sympathise but there have always been too many questions for too few pages. I think you must admit that there is trend towards material which is easy to understand, so articles like Command by

Command and Intro to Accounts are pitched at a non technical level. There will be a lot more in the future dealing with a wide variety of subjects.

Back issues of ABC are available free to all Joyce owners. They come free inside ACU which only costs £1.25 (couldn't resist that!). You'll find an order form in the back of each issue.

I can't tell you what public domain software is available because such a list would fill the next three issues. You can get it from a variety of sources. Either write to R. Smith, 138 Holyte Road, East Grinstead, Sussex RH19 3EA, or - if you have the technology - you can download software from one of the many bulletin boards. Barry Pickles has promised me a list of such boards bearing Amstrad CP/M goodies so I'll publish that next month.

Your last point about discounts for club members is a little unfair. There is quite a range of software for the 8256 machine, but games software will always outnumber application software.

Printing problems continued . . .

I have had the same problem as R. Jones has with SuperCalc (ABC June 1986)

except mine concerns Multiplan.

I cannot get it to accept alternative printer instructions to vary the typeface in the printer - options setup position. Just how can I make it recognise printer codes? Your suggestion concerning SuperCalc 2 does not work with Multiplan.

Steven Richford,
Cambourne,
Cornwall.

ABC: The same control codes are used to change the typestyle, that is, Alt 0 for condensed and Alt R for normal. But they have to be entered in a different way. You must type EXTRA and U instead of using the Alt key. To enter an Esc code, type EXTRA and U followed by [(open square bracket).

And continued . . .

I have also bought Supercalc 2 for my PCW8256, and I can't get the printer setup codes to work either! You sit there trying Alt 0 or Exit release Shift+M or Exit Shift M all together until you go blue in the face. The machine cheerfully ignores all your efforts and carries on printing the standard typestyle regardless.

What does "(CR when done)" mean on the setup screen and can you give us the

exact sequence of key strokes?

G.C.McD. Baillie,
Stevenage,
Herts.

ABC: The reply we published two months ago was quite right - it's just that it didn't go the whole way. The problem is that the distribution version of SuperCalc is installed to reset the printer and switch it into condensed mode, as well as selecting 66 lines of continuous stationery, at the beginning of every printout.

The result is that no matter how hard you try to select a new print style, your efforts are lost when the printer is reset.

The only way round this is to reinstall the SC2.COM file to only send the following sequence for the printer initialisation:

1B 43 42 1B 63

which will select 66 line continuous stationery.

Once you have done this, the procedure we outlined before will work correctly. Type Alt 0 followed by Return for condensed, and Alt R followed by Return for normal - "CR WHEN DONE" is just another way of saying press Return when you've finished.

Appendix D of the manual has all the gen on installing the program.

ABC

SIREN SOFTWARE

**PCW
8256
8512**

DISC MATE

Can you afford to be without this program?
Have you ever erased a file that you did not want to?
Have you ever lost a program whilst copying?
DISC MATE allows to:

Recover erased files
Protect files from accidental erasure
Hide files from the directory
Show hidden files
Etc.

As well as the above mentioned features, DISC MATE contains FILECOPY program that allows you to easily and quickly copy files/programs from one disc to another. FILECOPY is extremely user friendly easy to operate.

Also on the disc is ZIPDISC which will speed up your disc drive by upto 20%. ZIPDISC uses no memory and is compatible with all software.

ALL THIS ON ONE DISC. DISC MATE is available for the Amstrad PCW8256, 8512 and also the CPC6128.

Available directly from SIREN SOFTWARE at only **£24.99** inc VAT.

SIREN SOFTWARE
76 Bridge Street, Manchester M3 7QE.
Tel: 061-796 6874

SIREN SOFTWARE

ATLAST

A versatile and friendly multi-file database program that doesn't cost an arm and a leg and doesn't require you to learn a new language.

ATLAST a rational database program that does what you want

ATLAST I gives you:

- Huge capacity. Up to 10 files open, 32,000 records each
- Relational-style referencing
- Compact. Will run happily on a single drive computer
- 9 (repeat NINE) data types, including dates, numerics, pre-defined constants and automatic serial numbers
- Up to 5 indexes, automatically maintained per file: **NO TEDIOUS SORTING REQUIRED**
- Flexible selection conditions for listings in any index order
- User-definable data entry screens and report forms
- Full screen editing of data with cursor control
- Import/Export of ASCII (i.e. text) files: Links to WordStar and New Word or other CP/M word-processor (including MAIL-MERGE), spreadsheet or graphics
- Fully menu-driven with helpful screens throughout: No new language to learn
- Applications virtually unlimited: simple accounting, estate agents, genealogy, bibliography, club membership/subscriptions, course/student/tutor records and so on . . .

When you're fed up struggling with inadequate tools, you need ATLAST

ONLY £49.95 (inc. VAT and P&P Europe)
for AMSTRAD PCW8256/512 and CPC6128

Order now from: **Rational Solutions**

9 Rosehill Road, London SW18 2NY.
Tel: 01-874 6244

Or any good Amstrad dealer.

All payments in Sterling drawn on a UK account.
ACCESS accepted. Callers please ring first.

Don't miss out!

AMSTRAD PROFESSIONAL COMPUTING

Amstrad Professional Computing is going to be required reading for professional Amstrad users. Just like Amstrad Business Computing it will be full of articles, hints and tips for the businessman (and woman) and anyone else who's interested in the more serious uses for Amstrad computers.

There is bound to be a huge demand for this new title, but as with any new magazine it is not always possible to make sure that every newsagent in the land buys enough copies. Just think how dreadful it would be if your WH Smiths, John Menzies or corner shop ran out. You would be starved of the informed comment from our experts. There would be no more forum to read, and you would even miss the exploits of Eddie, Pete and Julie.

Fear not! There is a way to make sure that you don't miss APC - by taking out a subscription. If you fill out the coupon opposite you can make sure of every copy of APC right from issue one.

Just to show how much we appreciate you we are offering a FREE BINDER to every founder subscriber. This is a sturdy wire bound job with a blue PVC cover, which will keep your copies clean, and the Amstrad Professional Computing logo embossed on the spine to distinguish it from the ACU binders you already have.

SUBSCRIPTION ORDER

£ p
 £15 UK and Eire 8500
 £23 Europe 8501
 £38 Overseas 8502
 Free binder (UK only) 8503

Please indicate method of payment (✓)

Access/Mastercharge/Eurocard/Barclaycard/Visa

Expiry date /

Card No. _____

Cheque/PO made payable to Amstrad Professional Computing

Name _____ Signed _____

Address _____

Post to: Amstrad Professional Computing, FREEPOST,
36 St Petersgate, Stockport SK1 1HL.

Order at any time of the day or night

Telephone Orders:
061-429 7931

Orders by Prestel:
Key *89, then 614568383

MicroLink/Telecom Gold
72:MAG001

Don't forget to give your name, address and credit card number

ENQUIRIES ONLY: 061-480 0171 9am-5pm.

ACUB

PCW
8256
8512

SOFTWARE
AND
HARDWARE

PCW
8256
8512

NEW
EXBASIC.

ADD
THE MISSING
COMMANDS TO
YOUR
MALLARD BASIC

- NO TRICKS
- NO PENS
- NO COMPLEXITY

- JUST WORKS!
- ONLY £9.95

Includes:
Plot/Draw/Circle/
Save Screen /
Load Screen and more.

£
LOW PRICES.

IF YOU SEE ANY PRICES LESS
THAN OURS IN THIS ISSUE TELL US!

COMPUTERS		P.O.A.
New Amstrad Business Micro		
Amstrad PCW8512	£469.00	(delivery £8.00)
Amstrad PCW8256	£373.00	(Delivery £8.00)
8256 Memory Upgrade	£28.00	(Delivery Free)
8256 2nd Disk Drive	£130.00	(Delivery Free)
CF2 3" Disks	£3.40	(Delivery Free)
CF2-DD 3" Disks	£4.70	(Delivery Free)
RS232/ CENTRONIC PRINTER RIBBONS MISC		
8256/8512 Interface	£55.00	(Delivery Free)
8256/8512 Printer Ribbon	£4.17	(Delivery Free)
(Printer Ribbon minimum order Qty. 2)		
8256/8512 Dust Cover	£7.45	(Delivery Free)
8256/8512 Anti Slip Mat	£2.50	(Delivery Free)
40 x 3" Disks (Lockable)	£9.25	(Delivery Free)
DISK STORAGE SOFTWARE		
Large range of software at sensible prices (Send A5 S.A.E. for catalogue)		
STATIONERY		
Wide range of computer stationery available (Send A5 S.A.E. for catalogue)		
PRINTERS		
Large range of printers at sensible prices (Send A5 S.A.E. for catalogue)		
COURSES		
Two day word processing course	£60.00	
(Locoscript or Wordstar Professional with Mailmerge)		

ALL PRICES QUOTED ARE EXCLUSIVE OF VAT

EVEN LOWER PRICES TO STUDENTS/EDUCATIONAL USERS

£
OFFER.

HELLO TO QUWAIT

THEY SAID IT COULD NOT
BE DONE!
BUT WE HAVE!

ADD A REAL DAISYWHEEL
PRINTER TO LOCOSCRIPT!

A)
1 x A4 PRINTER
1 x INTERFACE
1 x PRINTER CONNECTOR CABLE
1 x "LOCO-PRINTER-INTERFACE"
SOFTWARE
£215.00

B)
1 x A3 PRINTER
1 x INTERFACE
1 x PRINTER CONNECTOR CABLE
1 x "LOCO-PRINTER-INTERFACE"
SOFTWARE
£295.00

SOFTWARE DESIGN
SERVICE AVAILABLE

ALL AT

NABITCHI

tel.
051-708-0123. (9am-5pm)

NABITCHI COMPUTING
131 Mount Pleasant, Liverpool L3 5TF
Amstrad "HELP LINE" 051-708 0123

NEW!

**PCW 8256
8512**

**LIGHT UP YOUR
SCREEN
WITH
THE
STROKE
OF A
PEN**



ORDER FORM

Please rush me the complete package, consisting of LIGHT PEN (with interface), GRAPHICS PROGRAM (on disc), & USER MANUAL for the price of **£79.95**.

**TRADE/EXPORT
ENQUIRIES WELCOME**

DIRECT ORDER HOTLINE

0582 595222



Name

Address

.....

.....

Cheque/P.O. for £ is enclosed

Debit my Access/Visa Card No:

.....

Expiry Date

Signature

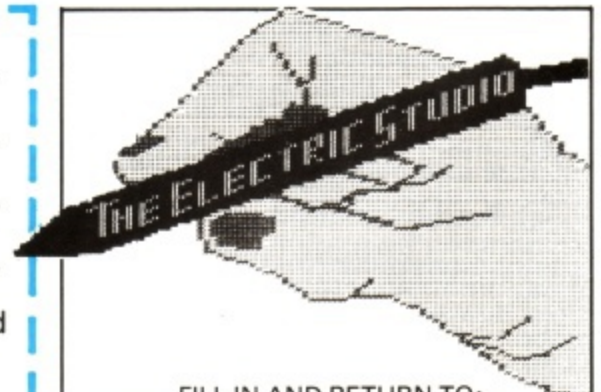

FILL IN AND RETURN TO:

THE ELECTRIC STUDIO

**P.O. BOX 96
LUTON LU3 2JP
TELEX: 825585 PSL G**

LIGHT PEN & GRAPHICS PACKAGE

ACTUAL SCREEN PHOTOS
Showing examples of work
produced
(NO PROGRAMMING
KNOWLEDGE REQUIRED)

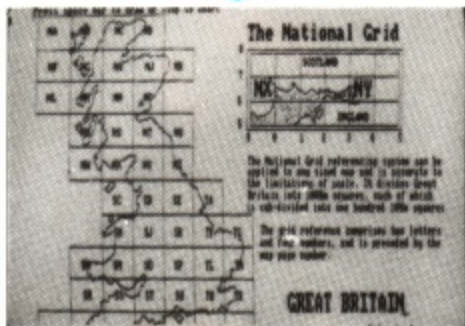

Mix text and graphics



Multi size text with
Horizontal/Vertical Printing



Window selection with
On-Screen prompts



Full size screen facility
once menu is removed



Portrait composition uses
vertical print dump

FEATURES

- ★ The Light Pen plugs directly into the expansion port at the rear of the monitor; it is supplied complete and **REQUIRES NO FURTHER INTERFACE.**
- ★ The Light Pen simulates a "real world" pen by allowing the user to accurately freehand draw directly onto the screen.
- ★ Supplied with the pen is a Graphics/Art program, which has a user-friendly **ICON/WINDOW** system for selection of functions, with on-screen prompts to guide the user through the program. **SIMPLY PLUG IN AND DRAW!**
- ★ Amongst the many features of the program are:
PENCIL, MULTI-SIZE PAINT BRUSH, SPRAY CAN, ELASTIC SHAPES (Rectangle/Triangle/Cube/Circle/Ellipse/Polygon), ELASTIC LINE, PINNED LINE, RAYS, ERASER, CLEAR SCREEN, INVERSE IMAGE, COPY IMAGE, MOVE IMAGE, SET POINTS, and many others.
- ★ **PAINT FILL** or **BRUSH** from the Texture Palette, giving an almost infinite variety of shading.
- ★ **MULTI SIZE TEXT** with horizontal/vertical/forward/backward print facility.
- ★ **STORE PICTURES TO DISC** for future use.
- ★ Program allows you to produce hard copy by outputting screen images to PCW8256 printer in 3 sizes (single or double density).
- ★ Suitable for **ARTWORK, LETTERHEADS, PLANS, DESIGNS, MAPS, DOCUMENT COVERS, LOGOS, PCB LAYOUTS,** and many more applications.
- ★ **GSX DRIVER** included on disc for installing the Light Pen to use with DR DRAW.

GSX and DR DRAW are
Registered Trade
Marks of Digital
Research Inc.

£79.95
Price includes VAT, Postage &
Packing

THE ELECTRIC STUDIO

FOR THE AMSTRAD PCW 8256/8512:

PROSPELL

**HAS
ARRIVED!**

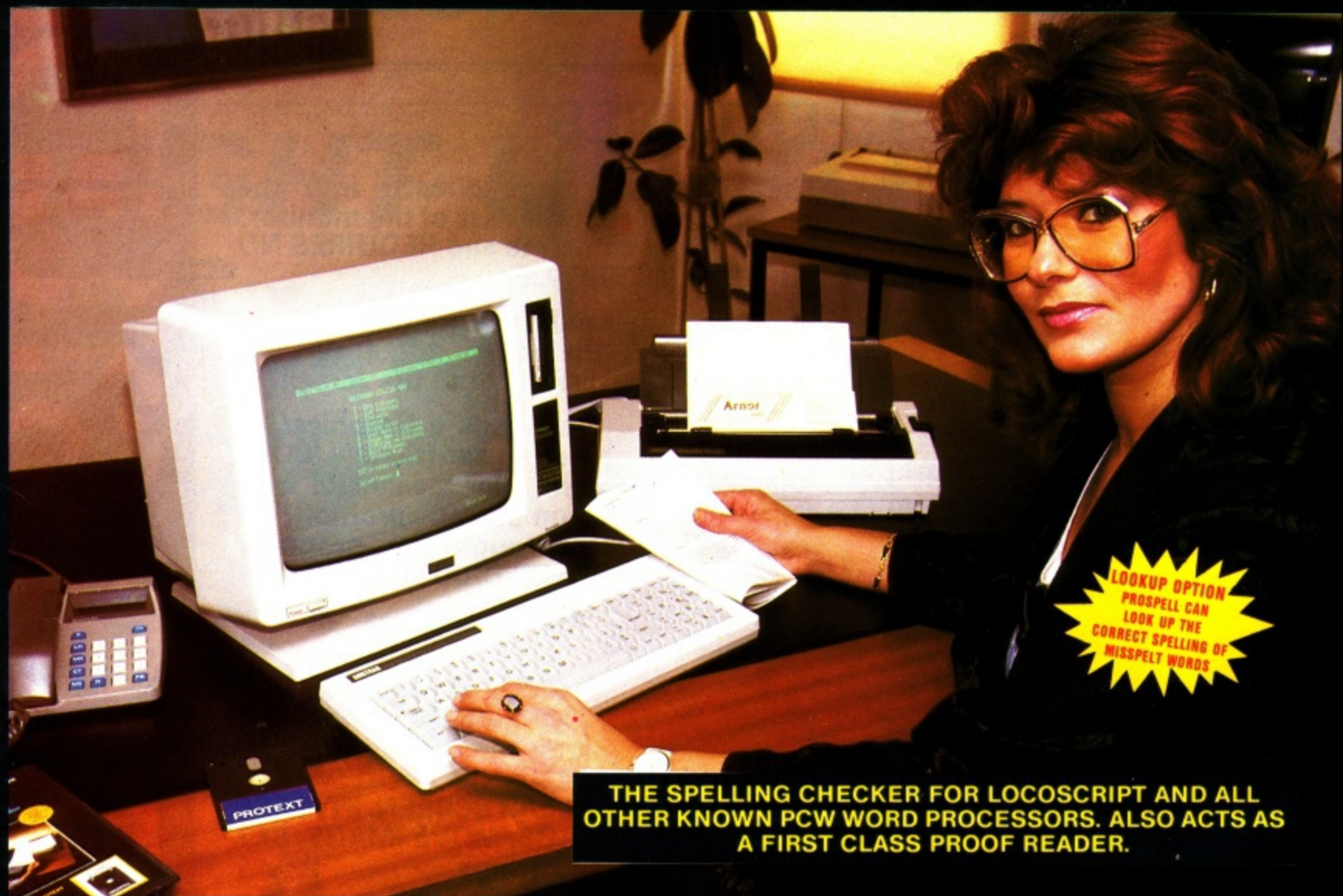

- INCLUDES MASSIVE 32,000 WORD ENGLISH DICTIONARY ● CHECKS UP TO 2000 WORDS PER MINUTE ● BUILD, EDIT, LIST DICTIONARY ● UNLIMITED DICTIONARY SIZE ●

EXPANDABLE BY USER

PLUS :- FINDS WORDS WITH UNKNOWN LETTERS AND CAN LIST ANAGRAMS OF A GIVEN WORD — IDEAL FOR PUZZLE SOLVING

"AN OUTSTANDING BUY"
- POPULAR COMPUTING WEEKLY

"LOOK NO FURTHER"
- AMSTRAD USER

ONLY £29.95

(INCL VAT, P&P)



CPC VERSION ALSO AVAILABLE WHICH WORKS WITH ALL KNOWN AMSTRAD WP'S

DISC £24.95

ROM £34.95



ARNOR LTD
118 WHITEHORSE ROAD
CROYDON
CR0 2JF
24 HR 01-684 8009

ABC

PROGRAMMING

Digging deeper into databases

I described the basics of writing a database and the difficulties that you can meet last time. The article also introduced some special purpose disc handling commands in Locomotive Software's Mallard Basic and how they can be used to write a very simple database for your PCW8256/512 or CPC6128/664/464+DDI.

The programs described could create a database and then add and retrieve records from it. But they left out a number of functions and features that you might include in a "real" program. This month I will extend the programs to provide extra facilities, and introduce more of Mallard's Jetsam commands on the way.

How Mallard stores its data

The reason Mallard is so good at database applications is that in addition to its normal Basic commands it includes special commands that give each record a label we can readily remember. These are called keys, and typically might be a person's name or national insurance number. The commands are known as Jetsam commands for keyed file access.

We saw last month the special Jetsam OPEN and CLOSE commands to start and finish working with the database, and the BUFFERS command to make the program work efficiently. We also used the FIELD command to define the layout of our database records, LSET to put the data in, ADDREC to add the record to the database, and SEEKKEY followed by GET to retrieve records. Before we can use any further Jetsam

commands it's necessary to know a bit more about how it actually stores the data.

Last month I showed how keyed files are actually in two parts – the index file (which contains keys) and the data file (which consists of your records). Let's now look at the files in a little more detail.

Each record in the data file is a normal Basic random record. If you're not sure what that is, it doesn't matter. What is important is that your data can be read or written by first telling Basic which record you want to access, and then using standard Basic commands such as GET or PUT to actually read or write the data. How to use these commands is described later.

The index file contains the keys by which we refer to the records in the data file together with details of which record each key refers to.

We can represent these files as shown in Figure 1.

Each record in the index file just consists of the key value itself plus a pointer to the appropriate record – the record number. An individual index entry can only point to one data record but a number of index entries can point to the same data record.

Mallard keeps special track of the last key and the last record that the program accessed. These are called the current key and current record respectively, and are used in a number of Jetsam commands.

The order of the records does not matter, it's the alphabetical or numerical order of the keys which does. In fact whether a record exists or not is

The second part of Stuart Cole's series on Mallard Basic adds extra facilities to last time's database and introduces some jetsam commands

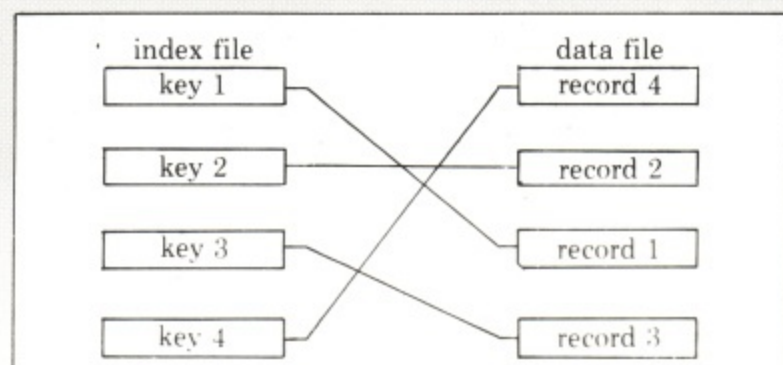

Figure 1.

less important – to Jetsam, not you – than whether a key does. This gives an insight into how to delete records we no longer want, as we shall see below.

Deleting an entry from the database

To delete a record simply to delete its key. This can be illustrated as in Figure 2. The record is deleted too, as shown in Figure 3.

The data in the record is actually still in the file, but next time Jetsam adds a record to the database it might use that (now empty) slot to put the data into. See Figure 4.

To show how this works in practice, let's add this feature to the database program we wrote last time (shown again in Listing 1). This treats names and addresses as one 20 character name and five lines of address with 20 characters per line.

To be able to delete entries from the database we just need to extend lines 500 and 600 to read:

```
500 INPUT "Add, Retrieve, Delete or Quit
: Type initial letter "; keyread$
600 IF keyread$="A" THEN GOSUB 3000 ELSE
IF keyread$="R" THEN GOSUB 4000 ELS
E IF keyread$="D" THEN GOSUB 5000
```

and add the subroutine at 5000 to delete a record. The subroutine at 3000 already adds a record and the one at 4000 retrieves a record.

The subroutine must first identify the record to be deleted and follow this by an instruction to delete the key. The simplest way to identify the record is to use our existing retrieve subroutine, and a special Jetsam command can then delete the key. This command is DELKEY. It has two different forms – the simpler one deletes the current key, and the other deletes a specified key.

The effect of the retrieve subroutine is to make the retrieved key the current key, so we can use the simpler form of DELKEY.

```
DELKEY (keyfile, 2)
```

where keyfile is the name we used for the file reference of our keyed file. 2 is another of the magic numbers which is explained later in this article.

The subroutine we will use to delete a record is:

```
5000 '
5100 ' Delete a record from the database
5200 '
5300 GOSUB 4000: REM - look u
p record to delete
5400 IF rcX<>0 THEN RETURN: REM - exit i
mmediately if look up failed
5500 rcX = DELKEY (keyfile, 2): REM - de
lete the current record
5600 IF rcX > 103 THEN PRINT "Failed to
delete record" ELSE rcX=0
5700 RETURN
```

Note how once more it checks the return code after deleting, and it checks that it did retrieve a record successfully

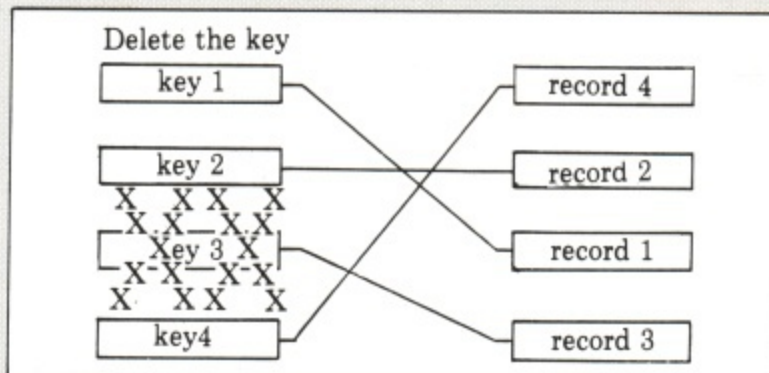

Figure 2.

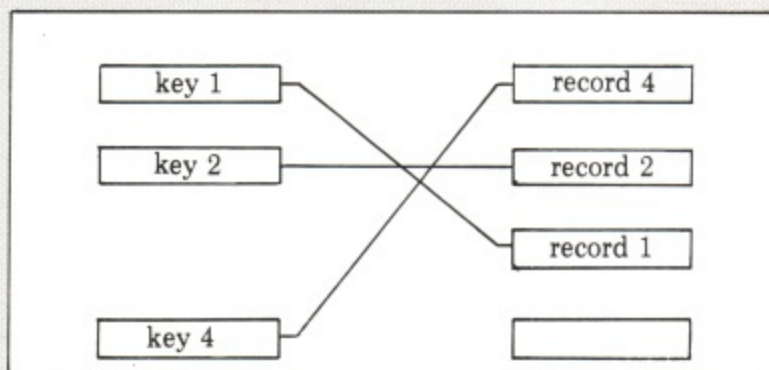

Figure 3.

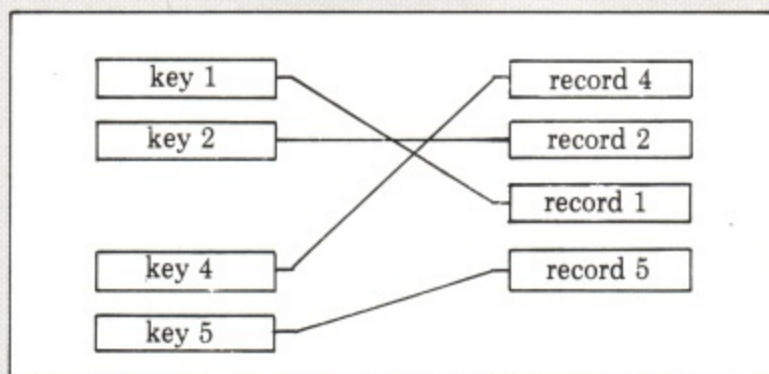

Figure 4.

before trying to delete it. In this case, however, a non-zero return code can mean success! So the program checks for all successful return codes (up to 103). If it was successful, the subroutine sets the return code to zero, so that other parts of the program can continue simply to assume that a non-zero return code means failure.

Now we are deleting records it is important to check that we are being consistent in what we use as the key. The Line INPUT command will accept almost anything, so if, for example, we typed a space at the end of the name, this would become part of the key and we'd always need to type the space when referring to that person.

We can get round this by using LSET again, this time to make our keys a fixed length padded with spaces. So we need to change lines 1300 and 4300 to read:

```
1300 LINE INPUT "Name "; temp$
1310 pername$ = SPACES(20): LSET pername
$ = temp$
```

```
4300 LINE INPUT "Type name to look up: "
; temp$
4310 pername$ = SPACES(20): LSET pername
$ = temp$
```

Changing an entry in the database

This is really two different problems, depending on what we are changing. The simplest is when we are just changing a part of the record that we don't use as a key, say if Mr Jones moves house. In this case we can just change the data. However if the item we are changing is part of the key, say if Miss Smith gets married and changes her name, then we have to re-index the entry too.

First, let's consider the simple case of someone moving house – the address changes, but nothing else does. We must add another item to the list of choices for the user of our program:

```
500 INPUT "Add, Retrieve, Change, Delete
or Quit:Type initial letter "; keyr
ead$
600 IF keyread$="A" THEN GOSUB 3000 ELSE
IF keyread$="R" THEN GOSUB 4000 ELS
E IF keyread$="D" THEN GOSUB 5000 EL
SE IF keyread$="C" THEN GOSUB 6000
```

and another subroutine to carry out the change.

As before, we'll use the retrieve subroutine to make the record we want to

work with into the current record. So our subroutine will start:

```
6000 '
6100 ' Change a record in the database
6200 '
6300 GOSUB 4000: REM - Look u
p record to change
6400 IF rcX<>0 THEN RETURN: REM - exit i
mmediately if look up failed
```

Now we have to change the current record. Our program will need to ask for the new address and set up the field strings. In fact, this part of the program is almost identical to the commands we used in the Add Record subroutine to set up the record in the first place. So now is a good time to take the main part of the Add Record subroutine and make it a new subroutine in its own right:

```
10000 '
10100 ' Set up a record's field strings
10200 '
10300 GOSUB 1000: REM - read in new name
and address
10400 GOSUB 2000: REM - display it to ch
eck it's OK
10500 INPUT "Is that correct "; nameok$
10600 IF nameok$ = "N" GOTO 10300: REM -
loop and ask again if not OK
10700 LSET namefld$ = pername$
10710 LSET addrfld1$ = peraddr$(1)
10720 LSET addrfld2$ = peraddr$(2)
10730 LSET addrfld3$ = peraddr$(3)
10740 LSET addrfld4$ = peraddr$(4)
10750 LSET addrfld5$ = peraddr$(5)
10800 RETURN
```

and replace lines 3300-3750 with:

```
3300 GOSUB 10000: REM - accept new name
and address
```

and add to the change subroutine:

```
6500 GOSUB 10000: REM - accept
name and changed address.
```

Whereas in the Add subroutine, we used ADDREC to add both the record and its key to the database, here we only want to change the record's data. As the record is the current record we can use a standard Basic command, PUT. This puts the data we have set into the field strings into the current record of the file we specify. So the complete subroutine to change the address is:

```
6000 '
6100 ' Change a record in the database
6200 '
6300 GOSUB 4000: REM - Look u
p record to change
6400 IF rcX<>0 THEN RETURN: REM - exit i
mmediately if look up failed
6500 GOSUB 10000: REM - accept
name and changed address.
6600 PUT keyfile
6700 RETURN
```

Changing and re-indexing an entry

The more difficult case of changing a record is when this changes the value that we are using as a key. In such cases, there are two approaches:

1. Change the data in the record as in the simple case, then re-index.
2. Delete both record and key, and add again from scratch.

The second of these two approaches is simpler and easier to write. We could program it by just changing a couple of lines in the code above:

```
6000 '
6100 ' Change a record in the database
6200 '
6300 GOSUB 5000: REM - look u
p and delete record to change
6400 IF rcX<>0 THEN RETURN: REM - exit i
mmediately if look up failed
6500 GOSUB 10000: REM - accept
name and changed address.
6600 rcX = ADDREC (keyfile, 2, 0, pernam
e$): REM - replace new details
6650 IF rcX <> 0 THEN PRINT "Replacing r
ecord failed, Return Code "; rcX
6700 RETURN
```

But this approach is less efficient and what is worse, it won't always work. One case when it fails is when there is more than one key indexing a particular record.

The first approach is rather more complicated. We have to save the old name – and any other field we were using as an index – and note if it changes. If it does, we first change the data and we then change the key. If it doesn't we just change the data as before. So, the subroutine becomes:

```
6100 ' Change a record in the database
6200 '
6300 GOSUB 4000: REM - Look u
p record to change
6400 IF rcX<>0 THEN RETURN: REM - exit i
mmediately if look up failed
6450 oldname$ = pername$: REM - save o
ld name
6500 GOSUB 10000: REM - accept
name and changed address.
6600 PUT keyfile
6700 IF oldname$ <> pername$ THEN GOSUB
11000: REM if key changed reindex
6900 RETURN
```

In order to re-index a record, you simply add the new key and delete the old one – in that order. If you try deleting the old key first (and it's the only key) this will delete the record too. We have just used precisely this effect to delete records from the database!

Once again our subroutine can make use of the current key and current record values. But this time we'll have to keep a note of the key to delete and use the more complicated form of DELKEY. Adding the key will set the new key as the current key, so if we use the simple form of DELKEY, we'll just delete the new key – which would be pointless! The subroutine is:

```
11000 '
11100 ' Change the current key to pernam
e$
11200 '
11300 oldrec = FETCHREC (keyfile): REM
- remember current record
11400 rcX = ADDKEY (keyfile, 2, 0, perna
me$, oldrec): REM - add new key
11500 IF rcX = 0 THEN rcX = DELKEY (keyf
ile, 2, 0, oldname$, oldrec): IF rc
X<=103 THEN rcX=0: REM - Delete o
ld key & tidy rcX
11600 IF rcX <> 0 THEN PRINT "Changing k
ey value failed, RC = "; rcX
11700 RETURN
```

This uses a number of new commands. They are:

FETCHREC – which requires as a parameter the number of the file we're using and returns the record number of the current record. This record number is needed in the next command, which adds a new key pointing to that record.
 ADDKEY – a Jetsam function, similar to ADDREC, but where ADDREC added a record to the database and made an

index entry for it, ADDKEY takes the record as an extra parameter, and simply makes an index entry for it with the new key.

DELKEY – the same Jetsam function we used earlier, but this time it is the complicated form. It takes some extra parameters which are another magic number – the value of the key we are going to delete – and the record number it points to. We have to specify both the key and the record number as there could be two keys with the same value pointing at two different records, say two Mr Browns. Note that, once again, we convert all successful return codes into zero.

Magic numbers

In both last month's and this article, I have mentioned some parameters you have to give special values, but without saying what these mean.

The BUFFERS command which we need at the beginning of the program requires one parameter. I suggested 6. This is the number of 128 byte parts of the index which Jetsam can keep in memory at once (the number of buffers). The bigger the number, the more likely Jetsam is to find the record in the data file corresponding to a key without first having to read in part of the index file.

The value of this number should be 6 or more. The drawback to setting it to something very big is that the space available for your program is reduced by 128 bytes per buffer.

A number of the Jetsam commands needed one or two numbers, typically given values 2 and 0 above. For example:

ADDKEY (keyfile, 2, 0, pername\$, oldrec)

If you look in the Mallard Basic reference manual, you'll see that these numbers, 2 and 0, are the lock and rank respectively.

The lock parameter is really there for more advanced computers than the Amstrads. Some of these, called multi-user systems, can allow several programs to run simultaneously. A network of IBM PCs is a good example of a multi-user system.

There is a special version of Mallard which runs on multi-user systems so that several programs can access the same database. On these systems it is necessary to prevent two programs changing the same record at the same time, since otherwise chaos would result. This is where the lock parameter comes in. It's a way of reserving part of the database for a particular purpose. The value 2 means a "write lock" and is the severest. If you use this (as the program we've written does), then your program will work on a multi-user system too.

The rank parameter is for when you are

indexing a database in several ways, for example by a person's name and by post town. It indicates to which index or rank you want to add a key. All keys in our program were in index 0. If we were to index by post town as well, then we'd use ADDREC for the first index as above, and add an ADDKEY command for the second index, with rank 1. All I've given you here is an introduction

to Mallard Basic's very powerful data handling commands. There's obviously more to writing a real program than I've covered in these two articles, but the program I've described does cover all the essential commands for a working prototype.

As I said at the start, don't just sit there - type in the program I've described, or better still write a program

to try these commands out for yourself. All these commands are described in detail in the Mallard Basic reference manual, together with a number of extra Jetsam commands.

So once you've made your program work, see how easy it is to improve it and give it extra features. Things you might try are to print out the whole database, or to index it by first name and by surname.

```

10 BUFFERS 6
20 keyfile=1: recleng=122
30 OPEN "K", keyfile, "ADDRESS.DAT", "ADDRESS.KEY", 2, recleng
40 FIELD keyfile, 20 AS namefld$, 20 AS addrfld1$, 20 AS addrfld2$, 20 AS addrfld3$, 20 AS addrfld4$, 20 AS addrfld5$
50 DIM pername$(5)
100 '
200 ' MAIN PROGRAM LOOP
300 ' =====
400 '
500 INPUT "Add, Retrieve, Change, Delete or Quit: Type initial letter "; keyread$
600 IF keyread$="A" THEN GOSUB 3000 ELSE
   IF keyread$="R" THEN GOSUB 4000 ELSE
   IF keyread$="D" THEN GOSUB 5000 ELSE
   IF keyread$="C" THEN GOSUB 6000
700 IF keyread$ <> "Q" GOTO 100: REM - loop until "Q" is typed.
800 CLOSE keyfile
900 END
1000 '
1100 ' Subroutine to read Name and Address
1200 '
1300 LINE INPUT "Name "; temp$
1310 pername$=SPACES(20): LSET pername$=temp$
1400 FOR ix = 1 TO 5
1500 LINE INPUT "Address Line "; peraddr$(ix)
1600 NEXT ix
1700 RETURN
2000 '
2100 ' Subroutine to display Name and Address
2200 '
2300 PRINT pername$
2400 FOR ix = 1 TO 5
2500 PRINT peraddr$(ix)
2600 NEXT ix
2700 RETURN
3000 '
3100 ' Add a record to the database
3200 '
3300 GOSUB 10000: REM - accept new name and address
3760 rc% = ADDREC (keyfile, 2, 0, pername$, oldrec)
3770 IF rc% <> 0 THEN PRINT "ADDREC FAILED, Return Code "; rc%
3900 RETURN
4000 '
4100 ' Retrieve record from database
4200 '
4300 LINE INPUT "Type name to look up: "; temp$
4310 pername$=SPACES(20): LSET pername$=temp$
4400 rc% = SEEKKEY (keyfile, 2, 0, pername$, oldrec)
4410 IF rc% <> 0 THEN PRINT "Failed to seek "; pername$, "RC "; rc%: RETURN
4420 GET keyfile
4430 pername$ = namefld$
4440 peraddr$(1) = addrfld1$
4450 peraddr$(2) = addrfld2$
4460 peraddr$(3) = addrfld3$
4470 peraddr$(4) = addrfld4$
4480 peraddr$(5) = addrfld5$
4500 GOSUB 2000: REM - display retrieved record
4900 RETURN
5000 '
5100 ' Delete a record from the database
5200 '
5300 GOSUB 4000: REM - look up record to delete
5400 IF rc%<>0 THEN RETURN: REM - exit immediately if look up failed
5500 rc% = DELKEY (keyfile, 2): REM - delete the current record
5600 IF rc% > 103 THEN PRINT "Failed to delete record" ELSE rc% = 0
5700 RETURN
6000 '
6100 ' Change a record in the database
6200 '
6300 GOSUB 4000: REM - look up record to change
6400 IF rc%<>0 THEN RETURN: REM - exit immediately if look up failed
6450 oldname$ = pername$: REM - save old name
6500 GOSUB 10000: REM - accept name and changed address.
6600 PUT keyfile
6650 PRINT "<";oldname$;"> <"; pername$;">"
6700 IF oldname$ <> pername$ THEN GOSUB 11000: REM if key changed reindex
6900 RETURN
10000 '
10100 ' Set up a record's field strings
10200 '
10300 GOSUB 1000: REM - read in new name and address
10400 GOSUB 2000: REM - display it to check it's OK
10500 INPUT "Is that correct "; nameok$
10600 IF nameok$ = "N" GOTO 10300: REM - loop and ask again if not OK
10700 LSET namefld$ = pername$
10710 LSET addrfld1$ = peraddr$(1)
10720 LSET addrfld2$ = peraddr$(2)
10730 LSET addrfld3$ = peraddr$(3)
10740 LSET addrfld4$ = peraddr$(4)
10750 LSET addrfld5$ = peraddr$(5)
10800 RETURN
11000 '
11100 ' Change the current key to pername$
11200 '
11300 oldrec = FETCHREC (keyfile): REM - remember current record
11400 rc% = ADDKEY (keyfile, 2, 0, pername$, oldrec): REM - add new key
11500 IF rc% = 0 THEN rc% = DELKEY (keyfile, 2, 0, oldname$, oldrec): IF rc%<=103 THEN rc%=0
11600 IF rc% <> 0 THEN PRINT "Changing key value failed, RC = "; rc%
11700 RETURN

```

MicroLink

Your personal passport to the world of communications with

TELECOM GOLD

Telecom Gold is a trademark of British Telecommunications plc

What it offers the Amstrad user . . .

Electronic mail is much cheaper than the post

Sending mailbox messages to other subscribers, whose numbers are rapidly growing, is the cheapest form of communication possible. You can send a message of any length to another mailbox for less than the cost of a first-class stamp. And it doesn't cost a penny more to send the same message to 500 different mailboxes! Even a message sent to a mailbox on the other side of the world only costs 30p.

The biggest bulletin board of them all

The number of bulletin boards is growing rapidly. The only snag is that the vast majority are single-user boards – which means lots of other people are also trying to make contact and all too often all you get is the engaged tone. But with the MicroLink bulletin board there is no limit to the number of people using it at the same time. And no limit to the number of categories that can be displayed on the board.

Give your micro mainframe power

With MicroLink your micro becomes a terminal linked directly to the Telecom Gold mainframe computer, and able to tap its tremendous power and versatility. Right away you'll be able to use giant number-crunching programs that can only run on a mainframe.

The mailbox that is always open

MicroLink is in operation 24 hours a day, every day. That means you can access your mailbox whenever you want, and from wherever you are . . . home, office, airport – even a hotel bedroom or golf club! No-one needs to know where you are when you send your message.

We're only a local phone call away

The majority of MicroLink subscribers can connect to our mainframe computer in London by making a local phone call. This is possible because they use British Telecom's PSS system, which has access points all over Britain. A local phone call is all you need, too, for direct access via MicroLink to all the other countries belonging to the international Dialcom system.

Telemessages – at a third off

The modern equivalent of the telegram is the telemessage. Send it before 10pm and delivery is guaranteed by first post the following day (except Sunday). The service was intended for people phoning their message to the operator, which costs £3.50 for 50 words. But you can now use it via MicroLink, for only £1.25 for up to 350 words! For an extra 65p your message can be delivered in an attractive greetings card.

Go teleshopping on your micro

With MicroLink you can study the British Rail timetable – and then buy your ticket in advance. You can book theatre tickets. And even order a bouquet of flowers. It's all part of the teleshopping revolution!

Send and receive telex messages

With MicroLink you can turn your micro into a telex machine, and can send and receive telex messages of any length. You will be able to communicate directly to 96,000 telex subscribers in the UK, 1½ million worldwide – and even with ships at sea via the telex satellite network. Business people can now send and receive telexes after office hours, from home or when travelling.

What does it all cost?

Considering all the services you have on tap, MicroLink is remarkably inexpensive. You pay a once-only registration fee of £5, and then a standing charge of just £3 a month. On-line costs are 3.5p a minute (between 7pm and 8am) or 11p a minute during office hours. There is an additional 2.5p a minute PSS charge if you are calling from outside the 01-London call area. Charges for telex, telemessages and storage of files are given on the next page.

How much it costs to use MicroLink

Initial registration fee: £5.

Standing charge: £3 per calendar month or part.

Connect charge: 3.5p per minute or part - cheap rate; 11p per minute or part - standard rate.

Applicable for duration of connection to the Service. Minimum charge: 1 minute. Cheap rate is from 7pm to 8am, Monday to Friday, all day Saturday and Sunday and public holidays; Standard rate is from 8am to 7pm, Monday to Friday, excluding public holidays.

Filing charge: 20p per unit of 2,048 characters per month.

Applicable for storage of information, such as telex, short codes and mail files. The number of units used is an average calculated by reference to a daily sample.

Information Databases: Various charges. Any charges that may be applicable are shown to you before you obtain access to the database.

MicroLink PSS service: 2.5p per minute or part (300 baud); 3p per minute or part (1200/75 baud).

Only applies to users outside the 01-London call area.

Telex registration: £10.

Outgoing telex: 5.5p per 100 characters (UK); 11p per 100 (Europe); 18p per 100 (N. America); £1.25 per 400 (Rest of world); £2.75 per 400 (Ships at sea).

Deferred messages sent on the night service are subject to a 10 per cent discount.

Incoming telex: 50p for each correctly addressed telex delivered to your mailbox. Obtaining a mailbox reference from the sender incurs a further charge of 50p.

It is not possible to deliver a telex without a mailbox reference. If a telex is received without a mailbox reference the sender will be advised of non-delivery and asked to provide a mailbox address.

Each user validated for telex and using the facility will incur a charge of 6 storage units a month. Further storage charges could be incurred depending on the amount of telex storage and the use made of short code and message file facilities.

Telemessages: £1.25 for up to 350 words.

Telemessages can be sent with an illustrated greetings card for 65p extra.

Radiopaging: No charge.

If you have a BT Radiopager you can be paged automatically whenever a message is waiting in your mailbox.

International Mail: For the first 2,048 characters - 20p to Germany and Denmark; 30p to USA, Australia, Canada, Singapore, Hong Kong and Israel. For additional 1,024 characters - 10p; 15p.

These charges relate to the transmission of information by the Dialcom service to other Dialcom services outside the UK and the Isle of Man. Multiple copies to addresses on the same system host incur only one transmission charge.

Billing and Payment: All charges quoted are exclusive of VAT. Currently all bills are rendered monthly.

Software over the telephone

MicroLink is setting up a central store of software programs which you'll be able to download directly into your micro. The range will include games, utilities, educational and business programs, and will cover all the most popular makes of micros.

Talk to the world - by satellite

MicroLink is part of the international Dialcom network. In the USA, Australia and a growing number of other countries there are many thousands of users with electronic mailboxes just like yours. You can contact them just as easily as you do users in Britain - the only difference is that the messages from your keyboard go speeding around the world via satellite.

What you need to access MicroLink

You must have three things in order to use MicroLink: a computer (it can be any make of micro, hand-held device or even an electronic typewriter provided it has communications facilities), a modem (it can be a simple Prestel type using 1200/75 baud, or a more sophisticated one operating at 300/300 or 1200/1200 baud), and appropriate communications software.

MicroLink

in association with

TELECOM GOLD

Application Form

I/We hereby apply to join MicroLink

ACU 8

I enclose my cheque for £5 payable to Database Publications as registration fee to MicroLink.

I also wish to use Telex. I authorise you to charge an additional £10 to my initial bill for validation.

I confirm that I am over 18 years of age.

I confirm that I accept the terms and conditions for the time being in force, a copy of which are available on request.

Signature _____

Date _____

FOR OFFICE USE ONLY:

Mailbox assigned _____

Start date _____

Password _____

SEND TO:

MicroLink
Database Publications
Europa House
68 Chester Road
Hazel Grove
Stockport SK7 5NY.

* Telecom Gold is a trademark of British Telecommunications plc.

Name

Position

Company

Address

Postcode Daytime telephone

Commencement of Service

Please indicate month of commencement

Allow 10 days for validation of mailbox

19

Payment

Whilst Database Publications Ltd is the supplier of all the services to you, the commission and billing thereof will be handled by Telecom Gold as agents for Database Publications Ltd.

Date of first payment to be on 15th of month following commencement.

Please complete billing authorisation form A, B or C below:

A. Direct Debiting Mandate (Enter full postal address of Bank Branch)

To

I/We authorise you until further notice in writing to charge to my/our account with you on or immediately after 15th day of each month unspecified amounts which may be debited thereto at the instance of British Telecommunications plc - TELECOM GOLD by Direct Debit. Bills are issued 10 days before debit is processed.

Name of Account to be debited

Account Number

B. Please debit my/our Access/Visa/*American Express account number

* Overseas subscribers only

I/We authorise you until further notice in writing to charge to my/our account with you on or immediately after 15th day of each month unspecified amounts which may be debited thereto at the instance of British Telecommunications plc - TELECOM GOLD. Bills are issued 10 days before charge is applied to your account.

Signature _____ Date _____

C. Please invoice the company/authority.

If you select this option, which is ONLY AVAILABLE to government establishments and Public Limited Companies, you will be sent an authorisation form for completion which will require an official order number to accept unspecified amounts.

ABC
SPECIAL



Advanced Locoscript for beginners

Eddie, Pete and Julie work inside an 8256. A recent promotion for Julie has aroused Pete's interest.

"Eddie..." "Yes Pete", said Eddie without looking up, expecting another of Pete's really seaching questions about Locoscript.

"Why does your office always look so untidy?" Eddie looked around him, startled by Pete's attack on his working environment. "It's probably 'cos you're always here asking stupid questions, stopping me from tidying up". Eddie carried on scribbling on his notepad. Pete was quiet for a while then said: "Eddie..."

"Yes Pete", said Eddie scribbling away. "Wouldn't it be a good idea if you got some shelves to store some of these

things?" "Hm, possibly", murmured Eddie still scribbling.

"A bit like blocks and phrases in Locoscript", ventured Pete. "Ahh ha!" Eddie threw down his pen on to the desk. "I knew you were trying to wheedle some information out of me". "What me? No—still, while you've raised the subject, perhaps you could cast a few pearls of wisdom in this direction concerning blocks and phrases".

"Pearls before swine, is that what you mean?" Pete pulled his hurt expression at Eddie's sarcastic remark. "Why the sudden interest in blocks? It couldn't have anything to do with Julie starting to

work in that department, could it? Or anything to do with the huge guy with muscles who moves the blocks around?"

Pete scowled. Eddie chuckled "Ha ha, what do you want to know?" Pete was still scowling. "I want to know about blocks and phrases", he muttered sulkily.

"Okay, I'll tell you about them. To introduce the idea of handling blocks and phrases let's first talk about using the Cut key. You know that to cut an area of text from the document, the cursor is moved to the place to begin cutting and Cut is pressed". Pete nodded.

"Then you use the cursor keys", Eddie continued, "to select the area to cut. This area is highlighted so that it shows up

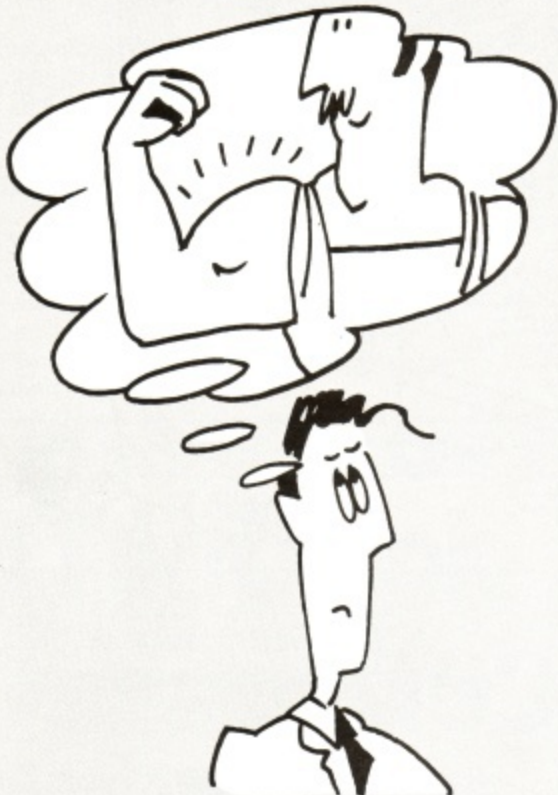

clearly. Cut is then pressed again and the text is removed and the document reformatted. It is a special feature of Locoscript that it allows text to be appointed in either direction, up or down. And the highlighted area expands or contracts accordingly".

"I've always thought that was good" said Pete.

"Once the area of text has been selected the Cut key is pressed and whoosh, whoosh, whoosh, the text disappears. As well as using the cursor keys the text movement keys can be used to position the cursor. A useful short cut - gedit - to remove an unwanted template when a document has just been created, is Cut Page Cut.

"The next stage is cutting and saving the text. Instead of using the Cut key the Copy key is used. Text is highlighted in the same way and then Cut is pressed. On line 3 of the screen, which is where most screen prompts appear, the prompt is asking for the text to be placed in either a block 0 to 9 or a phrase A to Z. Say, for

example that the 3 key was pressed. This places the text that is cut from the screen into block 3 for temporary storage.

"A neat feature of Locoscript is that when it is asking for a number, the keys on the numeric keypad change from working like cursor keys and so on, to working as a numeric keypad. Once the text is stored the cursor can be moved to the place where the text is to be reinserted and Paste and 3 will trundle out the saved text.

"This feature of Locoscript is intended for chopping and changing the order of paragraphs and lines within the text. Once the text has been stored, Paste will trundle it out as many times as wanted". Eddie paused for breath.

"But where does the stored text go?" asked Pete.

"I'm coming to that, all in good time. After pressing Copy there is the choice of pressing Cut to save and remove the text, or Copy again, to simply save the text. This is so that useful paragraphs of text can be shovelled up and stored away for future use.

"Now, you asked where the blocks are stored, knowing that it is possible to define a large area, and also knowing that sort of thing requires storage space somewhere. In fact blocks are stored on to the ramdisc, drive M, and they are only limited in size by the amount of free space on the ramdisc.

"There's something important you should know about blocks. When editing a document is finished, all the blocks are thrown away. However there is a mechanism for storing blocks permanently and this can be used to transfer blocks of text between documents. This is accomplished by pressing F8 (save a block), and pressing the appropriate number".

"How do you know which blocks are being used?" butted in Pete.

"Because the F8 menu tells you which blocks and phrases are used by displaying their number or letter".

"And how can you get the block back after it has been saved?"

"To get the block back, the function key F7 is used and then Insert Text. The disc manager screen appears and the block is picked up. Doing this does not reload the block so that it can be pasted once more. It must be stored again using Copy as before".

"Can you edit a block saved on disc?" Pete asked.

"A block is not a document so it can't be edited".

"So what is the difference between blocks and phrases?"

"Blocks are for large chunks of text, paragraphs and such like. A phrase is a little friend of a block for storing useful sentences and words. It is possible to save up to 26 phrases (in a similar manner to blocks), each one beginning with a letter.

It is useful to store phrases under the appropriate letter such as J for Julie".

"Or M for mnemonic" suggested Pete.

"Phrases have a limit. There is space for around 500 characters for all the phrases combined to fit into. This storage space is within the main memory and once defined the phrases are available to all documents until switch off. On the Locoscript disc supplied with the machine is a file called Phrases.std. When Locoscript is first booted, this file is read into the phrase store and is available to any document created".

Pete was wandering around the office and picked up a stapler to fiddle with. "So useful phrases such as owwwww-ooww-ooww!" "I don't think that's a very useful phrase" said Eddie calmly. "I got my finger caught in the stapler" replied Pete.

"Yes, you can have your whole life story chopped into pieces and stored for instant recall. Such as 'clumsy idiot', 'good for nothing', 'thick as two short planks'."

"Do you have a plaster?" asked Pete. "If I could only find it, in this untidy office", said Eddie without sympathy. "I'm bleeding", stated Pete. Eddie handed him an ash tray and continued.

"There is a Phrases.std file supplied on the Locoscript system disc and this is full of useful phrases for estate agents".

"Estate agents?" queried Pete. "Yes, estate agents. But it's possible to save the phrases that have been stored since Locoscript was booted. Pressing F8 for blocks and moving to Save All Phrases and pressing Enter saves the phrases. This happens when the document is exited and the file is saved on to the ramdisc under the name 'Phrases.std'. It is up to the user of Locoscript to copy or move the Phrases.std file across to a floppy disc before switching off the computer, to prevent it being lost.

"The Locoscript system disc, supplied with the machine, contains a file of useful phrases for correspondence. This is in addition to the Phrases.std file which is used for examples in the manual. The correspondence phrases are held in a file called Phrases.let and this can be used by copying and renaming the file.

"Phrases files cannot be edited but using F7 and Insert Text, a phrase file can be read into a document and all the phrases can be seen. And that, my friend, is about all there is time for today", finished Eddie.

"Thanks Eddie", said Pete, "I'll see you tomorrow". Pete trotted off in search of a plaster for his wounded finger. Eddie gazed round his chaotic office. "I'll tidy this up tomorrow", he thought. "Well, if I'm not too busy, I will. Maybe what I need is a bigger desk".

LOGICOM

THE NEW RANGE OF LOGICOM PRODUCTS FOR THE AMSTRAD 8256/8512

QMAIL RRP 29.95 Available Soon
A mailmerge program that works with Locoscript files! Each name and address stored in the special database can have 5 extra User-defined fields for additional information. And, an attribute field allows each name and address to be coded for accurate mailshots.

ROTATE RRP 24.95 – It turns printing problems around.
If you have ever wished that the Amstrad 8256/8512 printer was 132 columns wide, because your print-outs won't fit across the page. Rotate prints files sideways down the page. So, all those wide spreadsheet models can now be printed in one go. Rotate prints any ASCII file, so it will work with Spreadsheets, Wordprocessors, databases and some Accounts packages on the Amstrad. Rotate also has additional fonts to choose from. Files can be printed out in the normal way as well.

PRINTER STAND RRP 14.95 – specially designed for 8256/8512.
The printer stand is 3.5"/7.5 cm high. You can store fanfold paper neatly under the printer. It's business-like and made of strong light metal with 'non-slip' rubber feet. The colour matches the Amstrad printer flap.

Proteus are exclusive distributors for Logicom products, as well as distributors for several other publishers of 8256/8512 software. Our range includes: Amsoft, Arnor, Caxton, Compact, CP Software, Digital Research, Hisoft, MicroPro, Microcal, Sage and Tasman.

For further information telephone John Fontana, on 748-2302. Telex: 957485 ROBINC G. Trade & Export enquiries are welcome.

Post to John Fontana, Proteus Computing Ltd.,
2 Iffley Road, London, W6 0PA.

PLEASE TICK APPROPRIATE BOXES:-

- I am an End User, please send me the address of my nearest dealer.
- I am a Dealer.
- Please send information on LOGICOM products.
- Send me a full list of Amstrad Business Software.

Name (Mr/Mrs/Miss/Ms)

Company Name

Address

Post Code Tel No.

Please use BLOCK CAPITALS.



COMPACT ACCOUNTING SOFTWARE from £49.45 for the AMSTRAD PCW 8256

*Award Winning Compact Software with over 12,000 packages already in use in businesses large and small has been tested and recommended by leading British accountants. The incredible value and success of Amstrads PCW 8256 Business Computer has enabled Compact to offer its proven packages at a fraction of the normal cost

- **DAYBOOK £49.45** our entry level system for the retailer or small trader includes everything necessary to imitate manually kept books. ie. Sales Daybook, Purchase Daybook, Cash Book, Nominal Ledger
- **COMPACT ACCOUNTS £199.99** is our easy to use Complete Accounting System including Sales Ledger, Invoicing, Purchase and Nominal Ledger. It produces Invoices, Statements also Debtors and Creditors Analysis, provides Credit Control Functions, Budgeting, VAT Analysis and Reporting. Full Audit Trails Product Profitability Analysis and Comprehensive Management Reporting to Trial Balance
- **COMPACT PAYROLL £99.99** Deals with weekly, fortnightly, 4 weekly and monthly payrolls and conforms to all the latest N.I. and S.S.P. requirements. If you only require a single ledger ie. Sales ledger or Nominal Ledger each can be purchased separately at **£69.99** inc. VAT. All Compact packages can transfer data to **SUPERCALC, NEWWORD MULTIPLAN CRACKER, WORDSTAR**. So you can prepare cashflow charts with Supercalc or write to your customers using Newword without re-entering data already created in your accounting system. So don't delay **order today and let Compact start helping your business now!**

What the Papers say:- "COMPACT is a very well written system, extremely good value for money and very powerful". PC USER January 1985 – "COMPACT ledgers offer some excellent features for the small company". MICRO DECISION December 1985. *In 1984 COMPACT SOFTWARE won the "RITA" award which is to the information technology world what the "Oscar" is to the film industry.

- | | | | |
|---|--------------------------|--|--------------------------|
| COMPACT DAYBOOK
inc. VAT + p&p = £52.90 | <input type="checkbox"/> | COMPACT ACCOUNTS
inc. VAT + p&p = £203.00 | <input type="checkbox"/> |
| COMPACT PAYROLL
inc. VAT + p&p = £103.00 | <input type="checkbox"/> | SINGLE LEDGERS
inc. VAT + p&p = £73.00 | <input type="checkbox"/> |
- (state which Ledger)

I enclose cheque payable to COMPACT SOFTWARE LTD. for

Return to COMPACT SOFTWARE LTD.
1 Ensburry Park Road, Bournemouth, Dorset BH9 2SQ

NAME ACU7

COMPANY

ADDRESS

TEL NO. Please allow 28 days for delivery

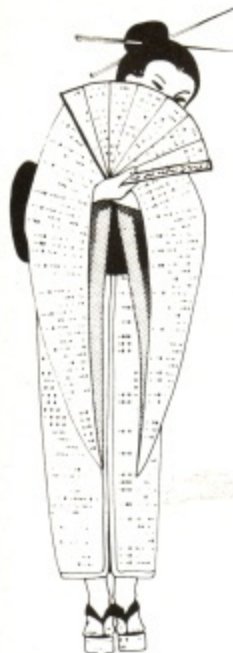

This means YOU!

Imagine a program listing. A listing for an amazing action game, about 3k or 4k long. Mostly it is written in Basic but it might have a few machine code routines to do some of the things that need speed. It works on the 464 (with or without disc drive), 664 and 6128. It might run (using Mallard Basic) on the PCW8256. Did I hear you say you have one right here in your pocket? I did? Hand it over. We want to print it!

Yes, that's right, we want lots of shortish programs for our readers to type in. They don't have to be games - we just have a preference for them. They can be anything that we find interesting. The things we don't find interesting are biorythm programs, pools predictors, simple databases, or anything to do with quadratic equations - unless they are written in one line, cello-taped to half a million quid or draw a pretty picture on the screen.

There are a few golden rules for submitting programs. Remember that you are writing a program for publication. Make your program easy to debug. Don't include unlistable characters in the program. Document start addresses and length of code when using machine code. Send the program on tape or cassette and include a SAE if you want it back. If you think the program does something particularly clever, write an explanation of the routine that does it. Don't include commands that work only on one particular machine. Now you know what to do, get cracking! Send off your program today to:

Liz Ting
Amstrad Computer User
169 Kings Road
Brentwood CM14 4EF

LIZTING



LEARN LOCOSCRIPT FROM A to Z!!



University Professors, Authors and Secretaries are among the many delegates who have attended WP Training courses over the past few months, and each and every one of them has left with the confidence and ability to utilise the full power of the remarkable Amstrad PCW with LocoScript. Our experience has taught us that even with the best professional training

LOCOSCRIPT CANNOT BE LEARNT IN ONE DAY!!

We know that we are in an aggressive market-place so we have followed the AMSTRAD philosophy of offering the best value-for-money by creating a new intensive no-compromise course at an unbeatable price!

TWO FULL DAYS of professional training which will teach you all there is to know about LocoScript (and that's a promise!) for only £75.00 + VAT. At the end of this course you will be able to release the full power of your Amstrad PCW.

There is a maximum number of four delegates on any course, so there is a great deal of individual tuition. Each delegate is assigned an AMSTRAD PCW and will take away full documentation.

For your free information pack on all our courses telephone:

01-555 5796

(24 HOUR ANSWERING SERVICE)

NOBODY DOES IT BETTER THAN WP TRAINING!!

MAILING LISTS

A simple to operate mailing list program for the PCW
Up to 6,000 records on the 8512, using multiple disks

Up to 1,000 records on the 8256

Five user defined selection codes

Alphabetic (indexed) fast retrieval of records

Prints 1, 2 or 3 labels across

IDEAL FOR CLUBS AND SMALL BUSINESSES

£19.95 (ex VAT, P&P)

Send cheque for £23.95 to:

MULTILINK NETWORK SYSTEMS

Monksilver House, Rose Mount, Oxton, Birkenhead L43 5SW

Tel: 051-652 5371



MICRO MAIL

53 FENNEL STREET
MANCHESTER M4 3DU
TEL: 061-834 5780

AMSTRAD

	RRP	OUR PRICE
CPC6128 Colour	£399	£379
CPC6128 Green	£299	£284
PCW8256	£459	£439
PCW8512	£574	£549
RS232 for 464/664/6128	£49.95	£44.95
RS232 for PCW 8256/8512	£69.95	£59.95
DMP 2000	£159.95	£149.95
SSA1 Speech Synthesiser	£29.95	£26.95
MP2 Modulator	£29.95	£26.95
JY2 Joystick	£14.50	£12.50
Modem	£136.85	£126.00
PCW8256 Modem & Sage Software	£189.95	£172.00
	each	Box of 10
CF2 3" Discs	£3.99	£37.50
	each	Box of 10
CF200 3" Discs	£5.99	£55.00
FDI 2nd Disc Drive	£89.95	£84.95
DDI Disc Drive	£159.95	£149.95

AMSTRAD CPC6128/PCW 8256/ PCW 8512 SOFTWARE

Personal Assistant	£94.95	Touch 'n' Go	£24.95
Pocket Wordstar	£99.95	Mastercalc 128	£34.95
(Please state whether for 6128 or 8256)		Pyradev	£29.95
Flexifile/Flexiwrite	£49.95	Protext	£26.95
Supercalc 2	£49.95	Promerge	£24.95
3D Clock Chess	£19.95	Prospell	£24.95

ALL LESS 10%
SHOWROOM NOW OPEN

SAGESOFT		CAMSOFT	
Pop. Accounts	£99.99	Stock Control	£49.95
Pop. Accounts/ Payroll	£149.95	Payroll	£49.95
Pop. Accounts Plus	£149.95	Invoicing	£49.95
Payroll	£69.95	Database	£49.95
Invoicing/Stock Control	£69.95	PSIS Stock, Inv. & Sales	£99.95
Database	£69.95	PSIL Stock, Inv., Sales, Pur, Nom	£149.95
Chit Chat E. Mail	£69.95	CAXTON	
Chit Chat		Cardbox	£99.99
Viewdata	£69.95	Scratchpad Plus	£69.95
Magic Filer	£69.95	Brainstorm	£49.95
Retrieve	£69.95	Touch 'N' Go	£24.95
Accounts		Smartkey	£49.95
Super Combo	£199.95	DIGITAL RESEARCH	
HISOFT		DR Draw	£49.95
Pascal 80	£39.95	DR Graph	£49.95
Devpac 80	£39.95	Basic Compiler	£49.95
"C"	£39.95	Pascal MT+	£49.95
Keyboard Tutor	£24.95	Printer Extension	
Pocket Cash		Cable 8256/8512	£12.95
Trader	£99.95	Covers	
Masterfile II	£33.00	8256/8512 set	£12.95
Microfile/ Microword	£49.95	6128 set	£12.95
Bridge Player	£19.95	464 set	£12.95
Hitch Hikers' Guide to the galaxy	£28.95	256K Expansion kit for 8256	£49.95

ALL DISC GAMES LESS 10% OFF RRP.
JUST SEND YOUR CHEQUE OR P.O. WITH A NOTE STATING WHICH TITLE YOU WANT. LESS 10%.

Post and Packing: FREE. ALL Computers ADD £6 for value UNDER £250
All payments cheque or P.O. to: I.M. PRIESTLEY.
ALL PRICES INCLUSIVE OF VAT.



ABC

TUTORIAL

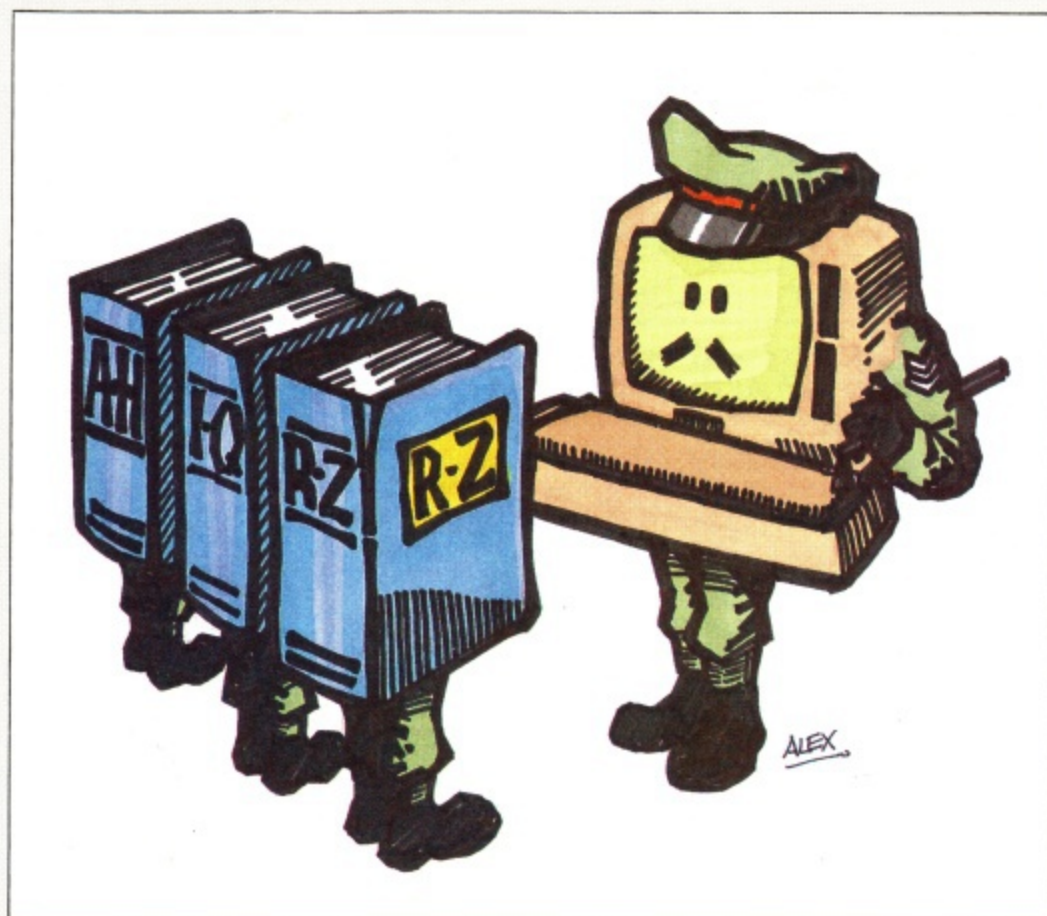

At first sight CP/M might seem ghastly. Yet once elements of it have been mastered and its logic appreciated, it takes on a certain charm. Those willing to poke around and explore will find there are always more commands waiting to be discovered. This series is intended to explain the CP/M commands in detail, dealing with each in turn.

Command by command

DIR

To get an idea of what's in a book you would look at the contents page or the index. An overall picture of a volume could be gained by quickly flicking through the pages. Alas, discs aren't quite so easy. Open the shutter if you dare, but all you are going to see is the magnetic film inside.

To find out what files are on a disc you will have to use the DIR command which will have a look at a disc's contents for you and tell you what it finds. Of course, all it can report back with is the filenames you allocated, probably meaningful when you created them but rendered obscure by time.

The value of DIR is often frustrated by meaningless filenames – you have eight characters and three to pack as much sense into a name as you can.

What DIR does when you invoke it is to read a track of the disc reserved just to hold the directory information. This track doesn't only keep the names of files, it also lists their location on the disc so the computer can find the contents. It's useful to remember that this all

important track is created when a disc is formatted. If you try to DIR an unformatted disc CP/M will report "track 0, sector 1 missing address mark" and award you four silly points. Sometimes a disc can be formatted but empty, in which case DIR will report "No File".

In use

The prompt shows the current logged-on drive. If you have B> on the left of your screen then you are currently logged-on to drive B:. Just typing DIR at the prompt will give you the contents of the logged-on disc. It isn't necessary to log-on to a drive just to get a directory of it. If you wanted a directory of the M: drive without moving from A: you would type:

DIR M:

After the directory you will notice that control returns to A: not M:. A useful, but little known CP/M command, allows you to chain commands together so you could move to the M: drive and get a

HANDS-ON

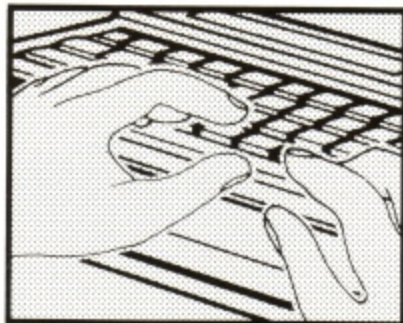

TRAINING

A collection of training programs on disk to help you get the most from your **Amstrad PCW 8256** or **8512**.

Titles include:

- HANDS-ON CP/M PLUS
- HANDS-ON SUPERCALC
- HANDS-ON dBASE II
- HANDS-ON LOCOSCRIPT (available soon)

Other non-Amstrad specific titles also available.

DON'T SETTLE FOR LESS. Check with your retailer or send order with £24.95 per title to:

Dept. A8, MicroCal Limited,
PO Box 561, Slough, SL3 9DP
Telephone: (0753) 75991
Telex: 849462 TELFAC G

microcal

DUST COVER SETS

Amstrad PCW8256/8512 £11.95 per set

In pale grey-proofed nylon, treated with an anti-static inhibitor, MONITOR & PRINTER covers piped in green.
Computer name hot foil printed on KEYBOARD cover.

Amstrad CPC 6128/464/664 £7.00 per set

Matching dark grey proofed nylon, treated with anti-static inhibitor, MONITOR cover piped in RED for 464, 664 and 6128.

Popular Printer Covers to match above

AMSTRAD DMP2000 BROTHER M1009 CANON PW1080A, EPSON FX80, RX80, LX80, MANNESMAN MT80, SHINWA CPA80, TAXAN P810 ALL £4.50
Large range of other printers available on request.

Prices inc. postage in UK, overseas customers please add Europe 50p, others £2.00 (air-mail), please state model and colour or monochrome.

BBD COMPUTER DUST COVERS



The Standish Centre, Cross Street
Standish Wigan WN6 0HQ.
Telephone: 0257 422968



BUSINESS SOFTWARE FOR YOUR AMSTRAD PCW8256/8512 AND CPC6128

LANGUAGES

Devpac 80	39.95
DR CBasic Compiler	49.95
DR Pascal/MT+	49.95
Pascal 80	39.95

PAYROLL

Camssoft	49.95
Compact	99.99
Sagesoft	69.99

INTEGRATED PACKAGES

Amsoft ABCS	from 33.00
Camssoft	from 49.95
Camssoft PSIL	149.95
Camssoft PSPN	99.95
Compact Accounts	199.99
Sagesoft Popular Combo	149.99
Sagesoft Super Combo	199.99

INVOICING & STOCK CONTROL

Amsoft ABCS	99.95
Camssoft	from 49.95
Camssoft PSIS	99.95
Compact Sales Invoicing	69.99
Compact Stock Control	69.99
Sage Popular	69.99

DATABASES

Camssoft Cambase	49.95
Caxton Cardbox	99.99
Caxton Condor 1	99.99
Compsoft Delta	99.99
Magic Filer	69.99
Microfile/Microword	49.95
Sagesoft	69.99
Ashton-Tate dBase II	119.99
AtLast	£49.95

SPREADSHEETS

Cracker	49.00
Multiplan	69.95
Scratchpad Plus	69.99
Supercalc 2	49.95

GRAPHICS

DR Draw	49.95
DR Graph	49.95
Polypoint	24.95
Polyprint	29.95

WORD PROCESSING

NewWord	69.95
Pocket Wordstar (6128)	49.95
Pocket Wordstar (8256/8512)	69.95
Superwriter	49.95

UTILITIES

Brainstorm	49.99
Smartkey	49.99
Touch 'N' Go	24.99
Compact Interfacer	69.99
Compact Nucleus	99.99

COMMUNICATIONS

One to One Mailbox Fee	57.50
(supplied FREE with every modem pack)	
Sage Chit Chat Combo	99.95
Sage Chit Chat E Mail	69.95
Sage Chit Chat Viewdata	69.95
Sage Modem with E Mail	199.95
Sage Modem with Viewdata	199.95
Sage Modem with V and E	239.95

ACCOUNTS

Amsoft ABCS	from 33.00
Camssoft Nominal	49.95
Camssoft Purchase	49.95
Camssoft Sales	49.95
Compact Daybook	49.99
Compact Nominal	69.99
Compact Purchase	69.99
Compact Sales	69.99
Sage Popular	99.99
Sage Popular Plus	149.99

90 DAY HOT-LINE support on all Sagesoft FREE OF CHARGE

Locoscript Training Courses by qualified word processing personnel. Details on request
Demonstrations available. All prices include VAT & Postage.

FULL RANGE OF AMSTRAD HARDWARE, SOFTWARE AND PERIPHERALS IN STOCK

MAIL ORDER
WELCOME



24 Bank Street
Braintree
Essex CM7 7UL
Tel: (0376) 48321

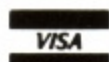

YOUR AMSTRAD BUSINESS CENTRE FOR EVERYTHING AMSTRAD

directory in one swoop – try this at the prompt:

M: !DIR

Again you get the contents of M: but now you are logged-on to the M: drive. The exclamation mark is great, especially if you have a number of commands you want to repeat over and over again with Alt W (Alt is the same as Ctrl on a Joyce and Ctrl W repeats the last CP/M command entered).

DIR doesn't necessarily tell the whole story. Filenames can have attributes which alter the way a file is treated by CP/M. For example, a read only (RO) attribute can be appended by SET.COM and result in a file which you will not be able to delete, until it has been restored to read and write (RW) status.

Other attributes will affect the way a file is accessed by DIR command. By default, files have a DIR attribute and will show themselves after the DIR command. But if a file has a SYS attribute, then you must use DIRSYS (shortened to DIRS if you like). Although files with a system attribute will be hidden from DIR you will be warned of their presence, if they have a .COM extent, with the message "System File(s) exist". Try a DIR on the Locoscript side of your system disc, then a DIRS.

Transient commands

So far we have only examined DIR as a built-in command. Notice how the command is always to hand without your having to load in a COM file. Built-in commands are always resident while transient commands, like PIP, are loaded and then executed. DIR is like ERASE, TYPE and RENAME – it is both a built-in command and transient. As a transient command DIR has many more powerful tricks to offer.

To use any of the following commands you must have DIR.COM on the logged drive, or you must route the command via a drive which does have the COM file: **A>DIR a:[full]** produces a directory of A: drive using DIR.COM on the A: drive **A>b:DIR M:[user=all]** sends CP/M off to the B: drive (though A: remains as the logged on drive).

If you use an option which needs DIR.COM you will be reprimanded if it isn't available. Don't worry about the bits in the square brackets – I'm coming to those.

CP/M switches

Options, or switches as some prefer to call them, are the parameters contained within square brackets. You're going to meet these frequently during this series. The switches are the means by which you tell a transient command exactly what it is you want done. Listed below are most

of the available switches for DIR.COM together with their explanations and some examples of use.

Date

CP/M version 3 allows files to be marked with the date and time of creation or alteration – more on that soon. This switch will reveal the date stampings on each file:

DIR A:[date]

Drive = all

Neat this one. If you want a directory of all drives this is the chap. Used with the masking facilities of DIR it's great for seeking out files. If you prefer you can use DISK instead of DRIVE, the effect is the same. It works on the M: drive as well: **DIR [drive=all]*.COM** lists all COM files on all drives.

DIR [drive=(a,m)]*.COM lists all COM files on drives A: and M:.

Masking

Wild cards are invaluable in any operating system. They allow you to designate groups of files which conform to a template defined using either the * character or a ?.

* can be used to replace a number of characters whereas a ? replaces just one. For example, T*.* means any file name beginning with T and having any extent.

???Tha*.C?? is a template for any file name having THA as the fourth, fifth and sixth letters and an extent starting C and any two letters.

Master wildcards the most useful things since sliced sectors.

Exclude

Masking allows you to search for list files which fit within a specified format. Exclude allows the masking to work in reverse. Instead of specifying the type of file you want to see, Exclude lets you specify those you don't want to see.

DIR A: [exclude]*.COM shows all files on A: except for .COM files

FF

This sends a form feed command to the printer – useful when listing a directory to the printer after using Ctrl P to toggle the printer on.

Full

This switch shows the size of a file in kilobytes, the number of 128 byte records allocated to it as well as the files attributes. If applicable this switch will also show the password protection mode and the time stamps.

No page

With a large directory DIR will display the information one screen at a time, just so you don't miss it. However when echoing output to the printer with Ctrl P you might not want "Press Return to continue" to keep appearing on your

No sort

By default DIR sorts files into

alphabetical order before it lets you see them on the screen. If you are awkward you might want the files listed in order of their appearance on the disc directory.

RO

Displays just those files which have been set to read only.

RW

Same as RO but this time just shows the files set to read write.

Size

Lists files with their size in kilobytes. Like Full this switch also gives information on the disc as a whole by telling you the total bytes, total 1k blocks, total records (128 byte) allocated, number of files and the number of used or maximum allowed directory entries.

SYS

Same as DIRS in that this displays all files having a SYS attribute.

User=all

Rather like drive except rather than specifying drives this switch specifies user areas:

DIR [user=all]*.com lists COM files in all user areas on the default drive.

DIR [user=1,5,8] lists all files in areas 1, 5 and 8.

User areas

These can be treated in the same way as drives. The default directory is 0A:, the 0 being the user area. To change to user area 4 just type 4: and the prompt will change to 4A: If you are in 0A: and want a directory of user 5B: do this:

A> dir 5B:

The user area can be listed without having to use transient DIR, but if you want to use switches on a user area make sure that the DIR.COM file is at hand.

Combining switches

As shown by the example directory of my three drives, switches can be combined simply by separating each switch with a comma. The following is complicated but quite legal:

DIR [drive=all,user=all,full, nopage,rw]*.jul *.jun*.bak

Work it through and you can see that what I get is a full directory of all drives and all user areas but only of files ending in either JUL, JUN or BAK with a read write attribute. The list is to be scrolled without pausing at pages. Simple?

Next time

In the next article it's the turn of PIP.com. We haven't finished with directories quite yet – Andrew Clarke will be discussing some of the public domain software which can make keeping track of files a great deal easier. If you thought DIR had a lot going for it just wait and see what you can do with the PD stuff.

PCW8256 512K MEMORY/368K RAMDISC UPGRADE (DRIVE M:)

NOW ONLY £26.80

Upgrades the internal memory to 512k and increases the ramdisc (drive m:) to 368k. Simple installation and operating instructions supplied. Why not write for a quotation to have your upgrade installed on your premises.

WorkFORTH FOR 464(disc)/664/6128/PCW8256/512

WorkForth forms the heart of a powerful FORTH software development family. Includes a full screen editor and macro assembler.

WorkForth **39.68**

View-Trace debugger **35.00**

Floating Point **35.00**

WorkFORTH, View-Trace,

Floating Point **95.00**

MPE/Nautilus Cross Compiler

(needed only once) **250.00**

Target Processor **175.00**

(please state PDP11 6502 6511Q 8080/5 Z80

8086/8 Z8 1802 8070 6801-6803 6809 68000 99xx)

GRAPHICS

Polyplot	20.80
Polyprint	24.80
Polyprint type fonts	16.80
DR Draw	41.80
DR Graph	41.80

SPREADSHEETS

Multiplan	58.80
Cracker2	40.80
SuperCalc2	41.80
PlannerCalc	32.80
MasterPlanner	83.80
FastPlan	83.80
VP Planner	83.80

WORDPROCESSING

Newword inc Word Plus	57.80
Wordstar	41.80
Tasword 8000	20.80
Tasprint 8000	12.80
Prospell	24.80

DATABASE

Cambase	41.80
Flexifile	41.80
Cardbox	83.80
AtLast	41.80
TAS	83.80
Delta	83.80
dBase II	99.80

PLANNERS, ORGANISERS

Brainstorm	41.80
Pertrmaster	57.80
Target Task	83.80
Staffflow	179.80

TUTORIAL

lansyst Crash Typing	20.80
lansyst Two Fingers	20.80
Touch 'n' Go	20.80

COMMUNICATIONS

BSTAM	145.80
StarComm	41.80
Comm+	72.80
Sage Chit-Chat	84.80
E-Mail Chit-Chat	58.80
Viewdata Chit-Chat	58.80

ACCOUNTS SOFTWARE

Camsoft Stock Control	41.80
Camsoft Sales Invoicing	41.80
Camsoft Sales Ledger	41.80
Camsoft Purchase Ledger	41.80
Camsoft Nominal Ledger	41.80
Camsoft Stk. Inv. Sal	84.80
Camsoft Sal, Purc, Nom	84.80
Camsoft Stk. Inv. Sal, Purc, Nom	126.80
Payroll	41.80
COMPACT Sales Invoicing	58.80
COMPACT Stock Control	58.80
COMPACT Sales Ledger	58.80

COMPACT Purchase Ledger	58.80
COMPACT Nominal Ledger	58.80
COMPACT Payroll	84.80
COMPACT Stk. Sal, Purc, Nom, Inv	169.80
MAP Sales Invoicing	41.80
MAP Stock Control	41.80
MAP Sales Ledger	41.80
MAP Purchase Ledger	41.80
MAP Nominal Ledger	41.80
MAP Sal, Purc, Nom	84.80
MAP Stk. Inv. Sales Ledger	84.80
MAP Stk. Sal, Purc, Nom, Inv	126.80
Payroll	41.80
SAGE Popular	84.80
SAGE Payroll	58.80
SAGE Combo	126.80
SAGE Invoicing	58.80
SAGE Super Combo	168.80
MICRO SIMPLEX	84.80

LANGUAGES

Assemblers

HiSoft Devpac80	33.80
Microsoft Macro80	155.80

C Language

HiSoft C	33.80
BDS C	96.80
Aztec C Personal	126.80
Aztec C Commercial	233.80

BASIC Language

DR CBASIC Compiler	36.80
Mallard BASIC (464/664/6128)	56.80
Nevada BASIC	33.80
ZBASIC	75.80

FORTAN Language

Nevada FORTRAN	33.80
ProFORTRAN	72.80

Pascal Language

HiSoft Pascal	33.80
TurboPascal	52.80
Turbo Tutor	29.80
Turbo Database Toolbox	49.80
ProPascal	72.80
DR Pascal/MT+	41.80

COBOL Language

MicroFocus CIS-COBOL	84.80
Nevada COBOL	33.80
Microsoft COBOL Compiler	536.80
HiSoft Modula2	58.80
Nevada PILOT	33.80
LPA MicroPROLOG	66.80
Catalog from HiSoft	11.80
Write Hand Man	24.80
The Knife from HiSoft	11.80
The Torch from HiSoft	11.80
3D Clock Chess	16.80
3D Bridge	16.80

Digital Research CP/M Plus Manuals: complete set consisting of User's Guide, Programmer's Guide, Utilities Guide, SID Reference, System Guide supplied in two quality binder/cases 69.95
The Amstrad CP/M Plus by Clarke & Powes-Lybbe 18.80
Starting FORTH by Leo Brodie (best selling tutorial) 17.80

Prices include VAT & P&P

ANALYTICAL ENGINES LTD
PO Box 35 Eastleigh, Hampshire SO5 5WU

MICROWAY

Computer Centre

DBASE II £119.00 (ring for availability)

PCW8256/8512 + CPC6128

Software, Hardware, Books & Accessories

DATABASE SYSTEMS

Cardbox	£99.99
Delta 1.25	£99.99
Cambase	£49.95
Sage	£69.99
Magic Filer	£69.99
AtLast	£49.95

SPREADSHEET

Supercalc 2	£49.95
Scratchpad +	£69.99
Cracker	£49.00
Multiplan	£69.00

COMMUNICATIONS

Chit-Chat 'E-mail'	£69.99
Chit-Chat 'Viewdata'	£69.99

FUN

8256 3D Clock Chess	£19.95
8256 Bridge Player	£19.95
Hitchhikers Guide	£29.95

BOOKS

The Amstrad CP/M Plus	£19.95
Mastering the PCW8256	£8.95
CP/M Software Bus	
(with CP/M+)	£8.95
CP/M Bible	£16.95
Soul of CP/M	£16.95
Z80 Assembly Prog	£19.95
Delta, Data & You	£11.95
Working with dBASE II	£9.95
Multiplan Models	£14.95
PCDos & MSDos	£18.95
Wordstar Manual	£12.95
dBase III Handbook	£18.95

ACCOUNTING

Sage Accounts	£99.99
Stock + Invoicing	£69.99
Accounts Plus	£149.99
Payroll	£69.99
Camsoft modules	£49.95
Compact Daybook	£49.95

UTILITIES

Dr Draw/Graph	£49/£49
Dr CBasic/Pascal	£49/£49
Hisoft Pascal	
80/"C"/Devpac	£39.95
Polyprint + Polyword	£29.95
Polyplot	£24.95

WORD PROCESSING

Pocket Wordstar	£49.95
New Word	£69.00

HARDWARE/

ACCESSORIES

PCW 8256/8512	£458/£573
8256 2nd Drive	£184.95
RS232 CPS 8256/512	£67.85
CPC 6128 Gn/Col	£299/£399
DMP 2000 Printer	£159.95
Pace N'gale Modem	£136.85
8256/512 Cover Set	£13.95
Extension Lead Set	£14.95
3" Storage Box (x40)	£15.95

8256 to 8512
RAM UPGRADE **£39.95**

We also stock a large range of CPC464/6128 software, ROMs hardware, books + accessories - including Armor, Program Power, Beebugsoft and Tasman products - Please call. UK prices inclusive of VAT, P&P Hardware £8, other £1.00.



MICROWAY COMPUTERS
39 High Street, Rainham, Kent.

Tel: **0634 376702**

UNLOCK YOUR

PCW 8256/8512

MASTER KEY * (The Ideal Utility package, comprising of)

CARDEX

The EASY to use database, menu driven, fully user definable, multiple record files on a single disc, access by single or multiple keys, search by ambiguous reference, etc, etc.

THE KEY

Purpose designed disc directory editor that allows amongst its many features, the UNERASING of accidentally erased files so simple to use, full on screen information.

Master Key utility pack only £39.99

**** Also available, to while away the idle hours! ****

Doctograph	£49.95
Doctordraw	£49.95
Heros of Khan	£17.99
3D Clock Chess	£19.95
Hitch Hikers Guide to the Galaxy	£24.95

Prices include packing and postage Overseas orders please add £1



INTERLOCK SERVICES LTD

123b Brent Street, London NW4 2DX

Tel: 01-202 8727

(Personal callers welcome)



ABC

REVIEW

Hanging on to your sanity

In the first part of this series we posed three questions that users should answer before introducing a computer to their business. We shall now explore these questions in depth, beginning with the first – will a computer really help my business?

The answer to this question is, more often than not, a positive one. However a number of conditions need to be met.

Collectively the sales, purchase and nominal ledgers form the principal books of account for any company, which is why they are so often grouped together in account suites and provide a complete picture of the state of a company's affairs. A good ledger system gives you a breakdown of where money has been made, where it has been spent, how much is owed and how much you owe to creditors.

It follows, therefore, that a bad manual system will produce a bad computer system. In the industry there is a mnemonic for this – GIGO (Garbage In, Garbage Out).

Since most of you will have neither the time nor the capability to produce your own custom accounts package, you will need some guidance on what's available commercially. This is one of the purposes of magazines such as *ABC* – to separate the pure metal from the dross. So now let's look at what a computer system will not do, so that we can have a clearer picture of how it can help your business.

A computer cannot produce accurate accounting if the manual system is itself inaccurate. On the contrary, a computer will highlight any deficiencies in your existing system. For example, if a trial balance is taken out and single entries have been made without posting the corresponding double-entry, then the account will not balance, and no computer system available will ever make it do so until you correct the original mistake.

In the same vein, to take a more common error, if items are improperly analysed, say sales of fixed assets are posted as credit sales, the computer cannot normally differentiate and will accept the entry. Here you will successfully produce a trial balance – because arithmetically all the entries are correct – but the profit and loss report will be incorrect because sales are overstated (therefore, profit is overstated) and the fixed assets will also be overstated, because the balance sheet will show an asset being earned which

has been sold!

On the plus side, if your opening balances are indeed accurate, then the good commercial packages will introduce you to more accurate accounting methods with the minimum of effort.

Owners of small businesses – and the smaller they are, the more this applies – quite often lack the necessary expertise to devise sophisticated accounting analyses and may not have the resources to take on an experienced bookkeeper. A good commercial package will enable such users to produce detailed reports, which an accountant can use to offer in-depth advice and guidance.

Horses for courses

You should also closely examine the number of transactions processed in each ledger – sales, purchase, nominal or payroll – to decide if the expense is actually justified for your type of business. The nature of the business itself will also determine whether it is worthwhile.

Since this is very much a matter for individual assessment we can only offer broad guidelines, but, for example, if your business sells high-cost products with only a handful of sales during the year, then obviously you really don't need a sales ledger module.

On the other hand, a company which buys and sells on credit and cash, employs 50 people, sells 10,000 units a year and has 50 suppliers would benefit substantially from computerisation. As to the nature of the business, a market trader who operates one day a week selling a small number of lines, with a turnover of less than £10,000 a year, might not get all that much benefit from a computer.

It's very much horses for courses, but as a broad rule of thumb, if you already have a good manual system that produces accurate and comprehensive figures (and your accountant agrees with this!) and if you can produce such reports by hand as quickly as could be done by computer, and if you can do so at any time, with the minimum of disruption, then you will not benefit from adding a computer. (By the way, can we borrow your bookkeeper for a year or two?)

● *That's a lot of ifs and, as often as not, the balance falls in favour of the computer. So next month we will move on to the question of what the machine is actually going to do.*

ABC

Debit and Credit make their second appearance with some more advice on computerising your business. This month it's time to ask yourself some probing questions. (Debit and Credit appear courtesy of Barry Pickles and John Burke.)

SCREEN PROGRAMMING EDITOR

SPED is a powerful screen editor ideal for program development on the PCW8256/8512.

- Written in machine code and only takes up 7k of your disk.
- Edit over 1000 lines at a time (ie 47k).
- Editing done in ASCII and thus compatible with WORDSTAR & NEWWORD.
- Automatic line-numbering for BASIC users.
- Screen 28 rows x 90 cols plus reverse video User Strip.
- Fast file load, and save file commands.
- Comprehensive cursor/screen control.
- Extensive global find/replace facilities.
- Block move/copy/delete/print.
- File insertions anywhere in text.
- All the usual text editing commands.
- CUT and PASTE commands, wrapped lines.
- On-line User Guide/Reference manual.

UK Cheque/PO for £18.95 (inc. p&p)

BURLINGTON SOFTWARE,

Suite 14a, Burlington Chambers, 118 New St., Birmingham B2 4JH.

PCW PROGRAMS

Fed up with packages which only provide 50% of your requirements? Have programs written to your own specification by expert programmers. We can provide fast, efficient programs at low cost very quickly. Ring for free quotation.

0373 72039 evenings and weekends.

PCW 8256/8512 GUIDE

The Clarity Guide to word processing with LocoScript on the PCW 8256/8512 gives detailed key-by-key instructions for all operations and clear jargon-free explanations which, with the quick reference index, save much time and puzzlement for both learners and experienced users. The book also contains many useful tips, a helpful layout procedure chart, and some notes on the technique of touch typing.

"One of the simplest and best helping hands" Daily Mail

Only £4.95 inc p&p. Refunded if not delighted.

Prompt despatch.

Clarity Guides (ACU),
Broadwood, Lifton, Devon PL16 0ER.

WORDSTAR

with mailmerge, for your Amstrad;
manuals included;
installed for the PCW8256;
available for other models.

£39.95 plus VAT

(£46.92 including VAT and postage)

Send cheque or Access or Visa number to:

Matmos Ltd., 1 Church Street, Cuckfield,
West Sussex RH17 5JZ. Tel: 0444-73830
OR: **Computer Appreciation, 111 Northgate,**
Canterbury, Kent CT1 1BH.



SIMPLE ACCOUNTS

Book-Keeping Made Easy For The Small Business

- Full Analysis of Income and Expenditure
- Constant Update of Creditors and Debtors
- Quarterly Totals for VAT Returns
- Monthly and Year to Date Reports
- Printer or Screen Output

"Most definitely this system removes most of the chore from doing the books, including the dreaded VAT" ... CWTA, Dec. 1985.

Only £29.95 including VAT & Carriage (£34.95 on Disc).

CORNIX SOFTWARE LTD.

Spirella Building, Bridge Road, Letchworth, Herts. SG6 4ET. Tel: 0462 682989

Rugby Micro Spares

HARDWARE

PCW8512 £489.00
PCW8256 £389.00
CPC 6128 G/S £255.00
DMP 2000 £139.00

SOFTWARE

CAMSOFT
Stock Invoice Ledgers £130.40
Sage Popular Plus £130.40
Sage Super Combo £173.00
Sage Magic Filer £60.86
Supercalc 2 £43.44

Amsoft DISCS Amsoft

10 x CF2 £33.00
10 x CF2DD £59.50

PAPER

11" x 9 1/2" Plain Microperf.
500 £5.49 1,000 £8.49 2,000 £14.25

ALL PRICES INCLUDE DELIVERY. ADD VAT AT 15%

RUGBY MICRO SPARES 0788 71643

30 Oxford Street,
Rugby, Warwickshire CV21 3NF.

CALLERS BY APP.
24 HR ANS.

ALL GOODS IN STOCK AT TIME OF GOING TO PRESS

CASHBOOK

Put an end to your VAT problems with the latest program from the writers of TAXCOMP.

- * Up to 99 nominal codes.
- * Full audit trail by nominal code.
- * Produces trail balance.
- * Full VAT analysis.
- * Easy input/amendment of transactions.
- * Menu driven design.

WATCH OUT FOR
RELEASE OF
DATABASE
SOON!!

Cashbook has been designed for use by a small business or by accountants/bookkeepers on behalf of clients.

Available for 8256/8512

Only £69.95 including VAT & carriage

INTEGER COMPUTER SYSTEMS
430 Bury New Road, Prestwich, Manchester M25 5BB
Tel: 061-798 7307

Evaluation copy available for £9.95 (Refundable if not satisfactory)

GETTING STARTED WITH LOCOSCRIPT

A ONE HOUR VIDEO TUTORIAL
on the PCW 8256/8512 Word Processor

SAVE YOURSELF HOURS WITH YOUR OWN
IN-HOUSE "TUTOR"

£16.10 incl p&p

For full details listen to our 24 hour line

01-675 4019

GATEWAY VIDEO TUTORIALS
68A Dornton Road, London SW12 9NE.

Two more ways to make your Amstrad sing and dance.



Touch 'n' Go

The UK's most highly respected disk-based typing tutor.

"Performance – Excellent...Ease of use – Excellent...To use the program itself couldn't be simpler...I have not seen a piece of software as carefully done as this one." – InfoWorld

£24.99

(inc VAT).



SmartKey

SmartKey has the power to dramatically improve the way your Amstrad computer works for you by customising and automating your keyboard and software. It allows you to assign any long, repetitive, or difficult-to-remember set of keystrokes to any single key on your keyboard. Press this key once and SmartKey (the electronic assistant) will do the work for you. Have any number of "Smart" keys on your keyboard and use them with any of your other CP/M programs.

"Excellent" – InfoWorld

£49.99

(inc VAT).

Touch 'n' Go and SmartKey are available for Amstrad 6128, 8256/8512, IBM PC and all compatibles.

And don't forget they are both Caxton products. This means they are so simple to use we are able to offer you FREE and UNLIMITED telephone support on them. If you need help, your call will be welcomed and your query answered in a pleasant, helpful and efficient manner, because that's the sort of people we are!

Monitor

Personal
Computer
Word Processor

PCW8256

OA Office
Automation

Brightness



Caxton Software Limited
10-14 Bedford Street
Covent Garden
London WC2E 9HE
Tel: 01-379 6502.
Telex: 27950 ref 398



SuperCalc²



Thursday

8/18/1983

Check Amount	Deposit Amount	Balance
		\$1,150.00
930.00		\$220.00
140.00		\$80.00
100.00		(\$20.00)
	250.00	\$230.00
		\$165.00
		(\$85.00)
	900.00	\$815.00
1,485.00	1,150.00	(\$335.00)

Thursday

8/18/1983

Number	Date	Description	Check Amount	Deposit Amount	Balance
		Balance			\$1,150.00
	2000	ny			\$220.00
	2001				\$80.00
		store			(\$20.00)
		pany			\$230.00
					\$165.00
					(\$85.00)
				900.00	\$815.00
20: Totals			1,485.00	1,150.00	(\$335.00)

SuperCalc² is a powerful spreadsheet and financial planning tool that helps solve the most complex 'what-if' financial modelling questions. The program includes inbuilt formulae and functions including Net Present Value, Sum and Average as well as more powerful features such as Column/Row sorting, Calendar functions and Lookup tables. SuperCalc² is easy to use, including an on-screen 'Help' facility, and comes complete with comprehensive manuals and documentation.

CP/M Plus only.
Sorcim Soft - 07028 Disc only.
Suitable for use with CPC 6128 and PCW8256/8512

£49.95 r.r.p.

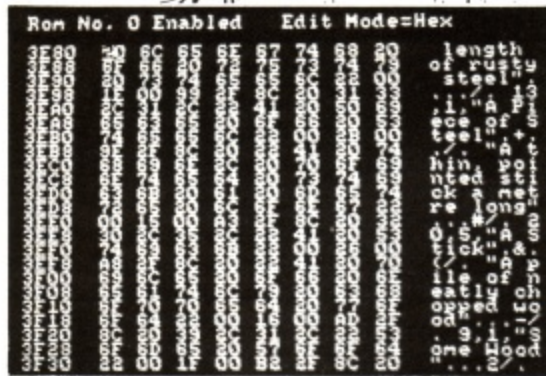

No Amstrad should be without one!

Pete Freebreg finds that it pays to be lazy

One thing indelibly printed on my personal memory banks comes from when I was at school. We had a cheerful Welsh mathematics teacher whom we called Taffy – of course – and one of his favourite sayings was "... the best mathematicians are lazy". The inference was that we should not slog away with pages of figures when a little thought would present us with a short, elegant solution.

What has this to do with toolkits? Well, I often write fairly long programs and any aid that can help me concentrate on the program and free me from a lot of tedious key pushing is a must. This is the idea behind a toolkit – it supplies a suite of short, elegant utility routines that you wish the computer manufacturer had supplied in the first place. Routines that enable you to be as lazy as possible!

The Beebugsoft Toolkit for the Amstrad (CPC 6128, 664 or 464) comes on cassette, disc or ROM. All three versions have the same routines, the only differences are the cost (£14.95, £17.95 and £29.95) and the fact that the cassette and disc versions take up some of the computer's memory space.

This last aspect could be a problem if you are writing long programs, so Beebugsoft include two additional programs on the cassette and disc versions. These each contain about half of the routines, so releasing about 4k extra memory for your programming. Knowing what you want to do, you can load the appropriate set of utilities before loading in your own program.

Although the ROM version is by far the most convenient, it will not plug directly into the Amstrad. You will need to buy an external ROM socket attachment – which will push the price up. Once Toolkit has been initialised in ROM or loaded from cassette or disc, the computer may be used quite normally and the routines called as needed.

Each is accessed by a bar command as and when required. IHELP will list all 30 bar commands together with an indication of what parameters have to be specified for each command.

ITOOLS displays a menu from which most of the routines may be called by just pressing a single key (A-X). ITOOLS also assigns often used commands to the numeric keypad (MODE 1, MODE 2, IHELP, IFREE, ITOOLS and so on.)

All toolkit routines may be called as a

bar command either directly or from within a program. Most will be used in the direct mode either as programming aids or as tools to make debugging much easier. Bar commands on the CPC464 cannot accept any text within quotes (file names or search strings). The use of ITOOLS overcomes this problem and is also very easy to use, as you are prompted for all information on any parameters required.

Focus on ease

The whole idea of a toolkit is to make writing and debugging programs easier for the programmer. One of the first routines that obviously fulfils this intention is IKON. This allows the entry of many Basic keywords in a very abbreviated form. The form used is quite logical and is therefore easily remembered, for example: L.100 for LIST 100, N. for NEXT, E.200 for EDIT 200 and LO. for LOAD. Note that with abbreviated forms you do not have to enter a space after the keyword.

Later listings of the program do not appear in this form because Toolkit converts all these abbreviations into the normal Amstrad Basic format automatically. IKOFF switches this routine off if you want to revert to the old laborious method of typing everything in full.

Often you will wish to use a similar routine several times within a program. The normal approach here is to use the routine as a subroutine accessed by a GOSUB. Sometimes this is not possible as even though the structure of the routine is very similar, you may have to alter certain parameters within it.

LCOPY can save time by copying a specified set of Basic lines to a new position. You can then make any needed alterations to the new set of lines rather than having to type them in all over again.

ILMOVE will perform a similar operation but will move a specified block of lines to another specified position

within the program. At first sight these two routines seem extremely powerful and very useful but sadly there is another consideration – the routines also renumber the program to keep everything neat and tidy.

This sounds good but it is quite diabolical! If you are writing any program you will have assigned your line numbers in some form of logical order. Perhaps starting all the key operations at lines 1000, 2000, 3000 and so on. After using either of the two commands ILCOPY or ILMOVE you will find the program completely renumbered and your carefully chosen line numbers have been changed.

While on the subject, you will no doubt have cursed the Amstrad command RENUM for a similar thoughtless operation. Toolkit has an improved renumberer – IRENUM – that allows renumbering just a specified block of lines and not also all the following lines.

Toolkit does have the means to overcome the faults of ILCOPY and ILMOVE in the guise of IPARTSAVE. This routine allows the saving – to disc or tape – of a specified block of lines. Having done this, you could then renumber your routine as required and then use the normal MERGE command to insert the routine back in your main program.

Additional programming aids are there in the shape of IKEY and IKEYDEF. The former will list the commands assigned to the function keys which are displayed on the screen and may be edited in the normal Amstrad manner to suit your requirements. But remember that ITOOLS will reassign these keys!

IKEYDEF lists what codes any group of keys have been set to. This display is also given in a form that may be edited and gives information on key number, auto repeat, Ascii code, Ascii code with Shift and Ascii code with Ctrl. An asterisk by any display indicates a definition that has been changed from the default setting.

Lost and found

Two routines that are extremely useful in both writing and debugging programs are :SEARCH and IREPLACE. If you are in the middle of writing a long program and want to use an additional variable – what do you use? Ideally you have made a note of all variables and should have no problem. Sadly we all forget to do this sometimes and confusion sets in, especially if we come back to a program after a rest period of a few days or weeks.

I:SEARCH will readily check through a program in memory and list all lines with the specified variable, keyword, or number. If for any reason you do not want to search the entire program, you may specify a block of lines. It will find anything you have entered in your programs with equal ease and together with IREPLACE recognises ? and * as wild cards. If you search for A?\$, it will find AB\$, AC\$, AD\$ and so on. Search for CO* and it will find words like SCORE and COPPER. As it will look for exactly what you type in, check that you type in the correct case – searching for COPPER will not find Copper.

Should you wish to replace a variable, number or string with another, then I:REPLACE is very powerful and easy to use. In fact IREPLACE is quite the most versatile routine of this type I have ever seen in a toolkit. You may find and replace, either globally or selectively. Global will change every occurrence of the specified string. Selective will list the line and seek confirmation before proceeding.

This selective option is very sensible on occasions. Change 960 to 970 (there is no need to specify GOSUB 960) and you may well find that 9600 becomes 9700. The routine is also intelligent enough to know that changing IN to OUT should not result in the keyword PRINT being changed to PROUTT.

Toolkit will also find the variables you have used in another way – IXREF. Calling this routine will display a remarkable amount of information about selected groups of variables. Many toolkits will only display variables after the program has been run and the variables have been assigned a value or string.

Not so IXREF, you need only LOAD a program, for all the numeric and string variables, arrays, functions and GOSUBs or any mixture thereof, to be displayed together with the line numbers where they occur to the screen or printer. Once the program has been run, IREF will also display what each variable contains (numeric or string), including each element of all arrays.

Another excellent debugging tool is the trace facility ITRON. This is a far

superior version to the Amstrad's normal TRON function. It may be called to operate over a limited number of lines and program operation may be slowed down by holding down Shift or temporarily halted by pressing the spacebar.

What makes it so much more acceptable than the Amstrad's TRON, is that line numbers are displayed in one small window and not scattered all over the screen. You may even define the position of the window so that it does not clash with your program's display.

Kwick print

Toolkit has a couple of useful routines to enable you to get hard copies from your programs more easily. To get an output to a printer from an operating program, the Amstrad requires special PRINT commands to be written into the program. IPRON will allow all outputs to go to both screen and printer. As all Toolkit routines are usable from within a program, a very simple Basic subroutine can be included to ask the user whether hard copies are required.

The second printer routine is IDUMPA (or DUMPE) and will produce a screen dump to either the Amstrad DMP1 or an Epson type printer. The dump will work in any screen mode and represents up to 16 ink colours by using different types of shading.

Memory lane

Delving into a computer's memory can be a hacker's delight, but it can also teach you a fair bit about the computer and how Basic programs are stored and operate. IEMEM will display the contents of the memory and allow you to edit what you find there. These contents are displayed in a standard format showing the Hex address, the Ascii contents of that address and any printable character represented by that Ascii code.

IBMOVE allows you to move a Basic program to a different place within memory. It also alters the start address so that the computer knows where to find and action the program. ISTART will specify the starting address for a Basic program.

These two commands seem to have little real use other than to allow two or more programs to be stored in memory and operation to be switched between them. There would be difficulties in passing any variables between different programs and you will have to keep your wits about you as you compile this multiple program.

There are better utilities available to access, write to and manipulate the Amstrad's memory but the routines within Toolkit are as good a place to start

as any – especially when you consider all the other useful commands it includes.

Finally in this section there is IPMEM, which will print a block of memory in the form described under :EMEM to your printer. Again this can be instructive, allowing you to examine various machine code programs at your leisure.

Odds

Have you got a program that is getting so large you wonder if you can get it all into the memory? Then consider IPACK. This is a very powerful command that will compact a Basic program in several different ways. Any or all of the following can be implemented – remove all REMs, remove all unwanted spaces, replace all variable names with ones of the shortest possible length and finally rewrite groups of Basic lines as single multistatement lines – whew!

The routine is intelligent, so if you have inadvertently got a GOTO that directs the program to a REM, it will not remove that REM. As the routine works, the display is continuously updated with the number of bytes being saved. You may hardly recognise your program after it has had the whole treatment and quite amazing savings can be made.

I:FORMAT gives you an easy to use disc formatting routine that offers the option of system, data or IBM formats. I:LIST enables you to list another program directly from cassette or disc without affecting any program in the Amstrad's memory.

I:FREE displays information concerning any program in memory – start and end addresses, size, HIMEM, free memory and so on. I:ROM lists details of any ROMs present and IRSX lists any system extensions – these are any bar commands resident in RAM – for instance all the Toolkit commands.

Beebugsoft is always considering improvements to its utilities and Toolkit is no exception. Latest versions will have an added command IFAST that increases the speed of screen handling. This means all your program listings, the memory displays for IEMEM and most other screen displays will be noticeably speeded up. The company has even taken note of my criticisms regarding ILCOPY and ILMOVE so if you have a valid comment, let me know.

Conclusion

If you write your own programs and have not got a toolkit, you just do not know what you are missing. The Beebugsoft Toolkit for the Amstrad should definitely be on your shopping list – no computer should be without one.

ACU



THIS IS ALL YOU NEED TO MAKE THIS MORE THAN A WORD PROCESSOR



A program from Britain's leading software publisher for the Amstrad PCW 8256 and 8512.

Choose from Accounts, Payroll, Invoicing, Data Management and award winning Communications programs. All simple to use, highly effective and yours from **£69.99** incl. VAT with 90 days after sales support absolutely free.

But if you're still in any doubt about the best way to make your Amstrad more than a word processor, consider this. In an independent survey 91% of Sage users said they would recommend our programs.

Facts which have not escaped the 25,000 users of our software.

Faced with the facts what will you do?

AVAILABLE FROM
BOOTS·DIXONS·LASKY'S·JOHN LEWIS·MENZIES
OFFICE INTERNATIONAL·WH. SMITH
WILDINGS AND MOST COMPUTER RETAILERS.

FOR MORE INFORMATION

Fill in the details below and post to:
Sagesoft plc, NEI House, Regent Centre, Gosforth,
Newcastle upon Tyne NE3 3DS.

Name _____
Company _____
Position _____
Address _____

Post Code _____
Tel. No. _____

SAGE
BETTER SAGE THAN SORRY

A.C.U. 8/86



ALSO AVAILABLE
CASSETTE 50 £9.95 / £14.95
DISK 50

DISK 50 ANOTHER GREAT FROM
VALUE PACKAGE



50 · GREAT · GAMES · ON · ONE · DISK

DISK 50

Cascade Games Ltd.,
Harrogate, HG1 5BG,
England.

FOR THE AMSTRAD 464, 664 and 6128
Menu driven with instant access to every game

Available from all good software suppliers or direct from Cascade — 24 hour ordering Service on (0423) 504663

SPIKY HAROLD

I actually preferred the French name, Henri Lapointe, but I guess Spiky Harold is more descriptive of a game in which the character you control is a hedgehog. Not just any old hedgehog, mind you – he is without doubt quite the cutest little chap you'll probably ever have the opportunity to control with your joystick or keyboard.

The first surprise comes before the tape has fully loaded. A feature that will be new to anyone who hasn't bought a recent Firebird game such as Rasputin is that music is played while the majority of the game is loading. The music is An English County Garden and is probably the best on an Amstrad yet. It's played in full three-part harmony with an almost piano-like envelope. This music alone would probably justify the price tag but the best has yet to come.

Once loaded there are just two options – you can either redefine the keyboard keys or start the game. While you make your mind up that Rimsky Korsakov classic – The Flight of the Bumble Bee buzzes away in the background. Perhaps not as good as the loading tune but still a pretty recognisable rendition.

Once you start you find yourself in control of the original Harold "cute as apple pie" Hedgehog. He can be moved left and right or he can be persuaded to jump. Whether jumping is an attribute available for all hedgehogs is questionable, but who cares if it helps Harold get through the 57 screens where he will find various food objects that must be collected to help him through hibernation. The sharp frost that is due in 24 hours imposes a time limit on the game but it is more likely that you will have all your 20 lives knocked off before then. There are extra lives to be found and even glasses of wine to make Harold a little tipsy so that control becomes a little erratic.

Everything isn't exactly sweetness and light at the bottom of



the garden, though. There are some pretty mean insects, worms, ghosts (?), clouds and probably anything else you care to mention.

Some of the screens are fiendishly tricky and require many "lives" of practice before you finally work out the best way through to the food item and final exit.

The game uses the same four colours in Mode 1 throughout to quite good effect. However all the sprites are drawn in the same colour – partly made up for by their animation. In particular the gobbling mouth of Harold when he finds an item of food is a real gem.

Author: Firebird
Price: £1.99

Colin

There are many games that aren't even half as good as this which are being sold for the full price of £7 or £8. You would have to be some kind of nutcase not to buy a copy of this game if only to enjoy the loading music or the joys of Harold gobbling an item of food.

Sure, I suppose it is really just a platform and ladders sort of a game but it has to be one of the best examples of

the genre. I'm amazed that the authors have managed to create such a cute looking central character in such a relatively small sprite and just one colour but even people who thought Thing on a Spring had an amiable little man could be surprised. The humour of the other sprites is also very good and I remain amazed that you are getting so much value for two quid.

18/20

Liz

Hedgehogs used to be the flat things you find on motorways – annoying and flea ridden. Meeting Harold has changed my mind, he is a cutie. The music is brilliant and the animation excellent. It is tempting to say that this should be a full price game but I don't think it would quite be good

enough for that. One complaint is that the tunnels are not quite big enough for the sprite, or perhaps that should be that the sprite is too big for the tunnels. This is a real Amstrad program – the graphics don't show any sign of being quickly converted from the Spectrum. I like it.

18/20

Nigel

This game is worth £1.99 just for the loading music. When it comes round to January and we're all looking back at what's been happening during the year, we can reflect on the trend that started in 1986. This is where budget software becomes good software.

Spiky Harold is a good example of this trend. It is well programmed and has a professional quality and playability about it. When budget software was new, the

games were not much better than magazine listings but now games like this threaten the more expensive titles in quality of programming. Here the animation is better than most Ocean games and the screens are well thought out and prettily designed.

It is not the sort of game I would sit and play for a long time 'cos you only need half a brain cell to play it, but as a wander-round-the-screens-getting objects game, it scores quite highly.

16/20

BONZO MEDDLER

AMSTRAD CPC SERIES

A FANTASTIC NEW UTILITY
devoted to TAPE to DISC transfer.

TRANSFERS all standard BASIC, BINARY and even ASCII Files.
Can cope with some HEADERLESS and some FLASHLOADERS!!

FULL status display during transfer. "HANDS OFF" operation.
Offers EXTENDED CATALOGUE, RENAMES to suit AMSDOS.

AUTOMATICALLY RE-LOCATES BINARY as required.

CUTEDISC also INCLUDED! On tape, transfers itself to disc!

By return post, just ...

£5.00 inclusive from

NEMESIS (ACU)

10 Carlow Road, Ringstead, Kettering, NORTHANTS NN14 4DW
IDLE MEDDLER still available at £4.50 inc.

FREELANCE TRAINER REQUIRED

NORTH STAFFS AREA

Must have full training experience on Amstrad 8256 and 8512. Estimated work 1-2 days per week.

Write with full details: Mr B. Young,
Managing Director, Amstrad Distribution Ltd.,
P.O. Box 299, Newcastle, Staffs ST5 7QS.

AMSTRAD

FOR AMSTRAD 8256 ROTATE

**Now you can print your Locoscript
text and spreadsheets sideways**

ROTATE enables anything you can save in an ASCII
format to be rotated through 90°.

So you can now print sideways spreadsheets like
SuperCalc and Multiplan - no more need to 'cut &
paste'. ROTATE also allows you to print in a variety
of fonts.

ROTATE only costs £21.70 plus p & p and VAT.

For your copy send £25.95 to:
Trinity Business Systems, 52 Queens Road, Hethersett,
Norwich NR9 3DB. Tel: 0603 812195.

ROTATE

ASTROLOGY for beginners

Teach yourself astrology using your Amstrad

A Starter Pack comprising a simple program to calculate a horoscope, an introductory
booklet and 2 self-teaching programs (how to interpret the horoscope)

£11.50 cassette £15.50 disc

No previous knowledge required

Also many other programs for more experienced astrologers

Please send the Astrology Starter Pack for my Amstrad
464/664/6128/8256. I enclose a cheque/PO, U.K. for
£11.50/£15.50 (inc p&p). Outside UK add 50p; or, I enclose a
large sae for free catalogue.

Name

Address

**ASTROCALC (Dept A) 67 Peascroft Road
Hemel Hempstead, Herts HP3 8ER Tel: 0442 51809**

COMPLETE PRESTEL LINK

FOR YOUR AMSTRAD

**ONLY
£35.99**



Enter the world of data communication with the
Cirket Prestel Link.

A complete package for the CPC464, 664 and 6128
computers consisting of Modem, Interface and
Software for only **£35.99**

The software supports full Prestel features including
dynamic frames and up to 16 colours.

Terminal mode allows access to BT Gold, bulletin
boards etc.

Extensive documentation of the RSX software is
supplied to enable the RS232 compatible interface to
be used with your own programs.

The acoustically coupled Modem is very reliable with
baud rates at 1200/75 and 1200/1200 half duplex
and has full BT approval.

Prestel Link Pack

£35.99 (Software on Tape)

£43.99 (Software on Disc)



Telesoftware Downloading At last we have the long awaited enhanced
software package. This has been a long time coming but the wait has been worthwhile,
it provides not only telesoftware downloading facility and text dump, but many other
improvements such as off-line editing of Prestel frames, user-defined function keys, the
option to configure for other modem and, in terminal mode, true ASCII or XMODEM
file transfer, plus compatibility to spool text to disc. Available on tape or disc.

On Tape £14.95 On Disc £19.95 PRICES inc VAT and P&P

VISA

Cirket Distribution Ltd.

**Park Lane, Broxbourne, Herts EN10 7NQ.
Telephone (0992) 444111 Telex 22478**



SAI COMBAT

Originally, Sai Combat was the sensible way to use your body and weapon as one in defence. Through the ages it was stylised and became more of an art form and method of Zen contemplation. Now these contemptible barbarians have the impudence to take this ancient and noble art, only to put it on a despicable Korean-manufactured heap of ... sorry about that, but the game gets to you after a while.

This looks remarkably like the Commodore 64 version of Kung Fu. The characters involved in combat are very large sprites, moving rapidly and gracefully across the screen. Sai is not usually limited to any particular weapon, but in this case the Japanese quarterstaff or bo has been chosen. The combatants swing them about in circles and an aggressive manner when not really doing anything else particularly violent. Unless, that is, you happen to count approaching someone while swinging a quarterstaff as violent.

One or two players can take part in the ancient art of trying to take someone's eye out with a blunt stick or a kick in the head, or fighting your way through the nth Dan, fluorescent orange belt and so on under the watchful eyes of two wizened Sai masters. Apparently they ignore the small amount of shuriken or fighting stars that get thrown about – but not by you – in the higher levels.

The only problem I found – apart from not being able to get past grey belt – was that any strike that went off one side magically appeared on the other, but I think we can forgive them that.

Either player can use keyboard or joystick to inflict perfectly harmless GBH on each other, or get creamed by the computer. The amount of oomph you have remaining is shown as two dragons' heads. One is clearly very ill (yours), and goes green rapidly. The other (the computer's in the solo game), seems to have high blood pressure and slowly turns red.

After being kicked in the neck for the last time in that round, you can gamble a bit and go to the last level, but with only three falls left. Saves a bit of grief velly occasionaly.

Author: Mirrorsoft

Price: £8.95 tape, £13.95 disc



Colin

I'm not normally a fan of this sort of game, but this one is as good as the Exploding Fist, if not better. Music and sound effects, together with the changing scenery, help hold interest when your spirits and energy levels are low. It is very easy to build

up a graceful and effective routine of attack. Knowing that certain hits cause the other guy to back off a bit, you strike close, then further away.

Velly leckomended for a bruddy good punch-up.

18/20

Liz

Just as I was starting to get bored with combat games, Mirrorsoft produces the most playable one yet and fires up my enthusiasm. Sai Combat may not have the pretty backgrounds of Way of the Tiger but it is better than all the predecessors. The

sprites move smoothly and accurately, so much so that it almost hurts when the computer pokes you with his bo.

There are odd problems with the sprites not being sure who should be in front but that may be finger trouble on my part and doesn't affect the gameplay.

15/20

Nigel

Sai Combat is Exploding Fist with a stick. It takes a while to pick up all the moves that can be made, like all these martial art games, but once mastered the game really takes off. The sound effects in the game are very good with a realist squish when your stick makes contact with your opponent's eyeball. (I think I'm gonna be sick.) One of the best

features of the game is the ranking system where defeating your opponent at one level promotes you to the next. Being defeated by your opponent brings you down a level. I think this is the best combat game of this genre that I've seen and you should all go out and buy it.

16/20

ROOM 10

What is the hoariest old chestnut of an idea you can think of for a game? Space Invaders? Breakout? Pong? Promise you won't stop reading this when I tell you what sort of game this is? Cross your joystick and swear on your infinite life? Okay, it's a version of Pong.

What, still with us? Good. Room 10 is the latest CRL game and is a follow up to Tau Ceti, the shoot-em-up planet exploration game. Obviously Pete Cooke, programmer of Tau Ceti, wanted to do something a little different this time but still keep the theme going. So he's turned his Pong game into a recreational activity for Galcorp space pilots to play after a hard day zapping droids.

It's quite simple to explain. Room 10 is where it all takes place. The game is essentially 3D Pong, and each player has a bat with which they must return a ball. The ball can bounce off the side walls, ceiling and floor, but if it reaches the end wall behind a player, the player concedes five points. The first player to reach 35 points wins.

When playing the game, there are two views of the court shown. The top half of the screen shows player one's view of the court, while the bottom half shows player two's. The bats are very large, being about a quarter of the area of the rear wall. Your view is looking through your own bat at the action taking place. The bats and the room are shown in wire frame graphics with the ball and floor being solid.

As you move the bat with a joystick, or the keyboard, you will notice that the bat has inertia. Well of course, because the game takes place in zero gravity and your bat colliding with the wall makes a crashing sound.

You can select whether to play against a human or computer opponent. Against a computer opponent there are three levels of difficulty. The game can be played at several speeds although there seems very little difference between them. The computer opponent is quite cunning and at medium and high skill levels is tricky to beat. The closer the ball hits the edge of

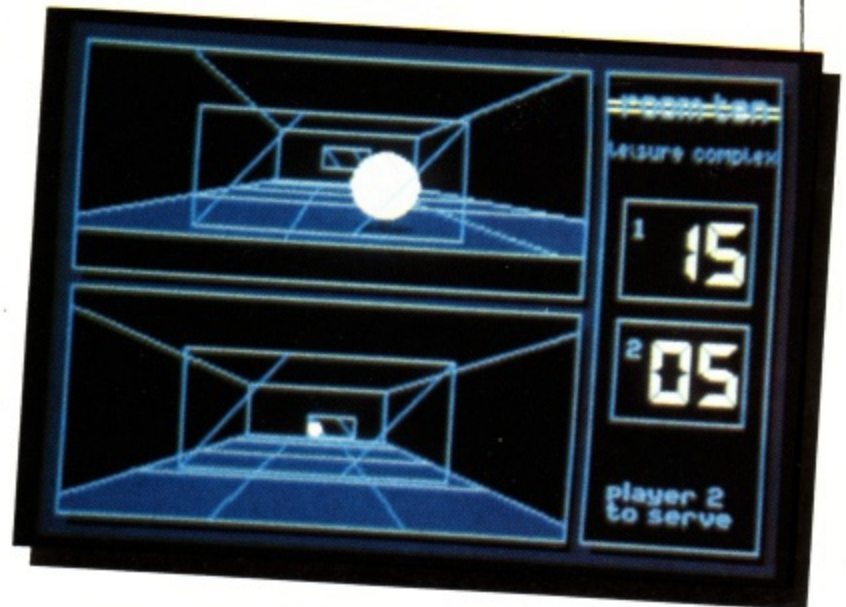

the bat, the more acute the angle the ball travels away. The computer opponent, given a simple return, will always line up an edge to make the ball bounce back off the walls and ceiling. Floor to ceiling is a short distance for the ball to travel, so getting an angle to bounce the ball off the floor makes it a difficult shot to return.

There are many options in the game. I have mentioned changing the speed and skill levels but it is also possible to select whether to be player one or two and whether player one or two is a human player or the computer. This seems a bit confusing but it means you can set the game up and play against one of your friends or sit back and watch the computer play itself. The keys are fully redefinable but initially the joystick is not set up.

Author: CRL
Price: £7.95

Colin

When I first saw the name Room 10, I imagined it would be a game involving a large maze and lots of rooms. Wrong again. However the idea of a hi-tech 3D ping-pong game is certainly a novel one and is quite a step up from the very first arcade game Pong. The game looks as though a great deal of effort has been afforded in every detail and plays very well.

My only gripe is that the amount of deflection

imparted to the ball when it is hit nearer the edge of the bat should have been greater. Some rallies can go on for quite a while before a mistake is made.

The provision of faster levels does make up for this, though, and so I wouldn't hesitate to recommend the game, particularly if you can find another person to play against.

17/20

Liz

If you have ever wondered what life is like for a table tennis bat then Room 10 is the place to be. The bat control is a little sluggish but some rallies still get the blood pressure up. The roof and walls make Room 10 look like real tennis or a sort of cross between squash and tennis. If you play against several

other players and swap from the top to bottom you can easily lose track of which part of the screen you are supposed to be looking at.

With its roots so firmly in the past of computer games Room 10 is surprisingly up to date.

17/20

Nigel

It's nice to see an old idea reworked into an up-to-date game. Room 10 is very playable. The 3D effect is very nearly state of the art giving the old Telly Tennis idea new life. The sound effects are a bit dull though and after a while the game begins to pall. There are lots of options, but

unfortunately none have much effect on the game. I would have liked something to liven it up a little when playing the computer.

Room 10 is great for two players and has much scope for mini tournaments when you've got a crowd round.

15/20



ONLY THE BRAVEST FLY ...

TOMAHAWK

AMSTRAD

464, 664, 6128,
COLOUR OR GREEN SCREEN

TOMAHAWK – a stunningly realistic flight simulation that puts you in command of an Apache Advanced Attack helicopter. Flying low over a spectacular 3D real world display with over 7000 ground features – TOMAHAWK puts you in the hot seat.

Ground attack and air-to-air interception is the challenge – day or night in the thick of the battlefield. Your combat mission is to locate and destroy enemy ground forces. It could be science fiction – it isn't – the Apache is for real ... the meanest, deadliest combat helicopter ever. You have the weapons, the machine ... climb in and prepare for take off!

BY D.K. MARSHALL
ADAPTED BY DARRELL D.
Cassette 9.95 Disk 14.95

- Spectacular 3D cockpit view with over 7000 ground features
- Authentic aerobatic performance
- Ground attack and air-to-air interception, with laser guided missiles, rockets and 30mm gun
- Doppler navigation and target tracking
- Day/Night vision systems
- Cloudy, Crosswinds, Turbulence
- Pilot ratings – Trainee to Ace
- Impressive sound effects
- Pilots Notes



Also available on Spectrum

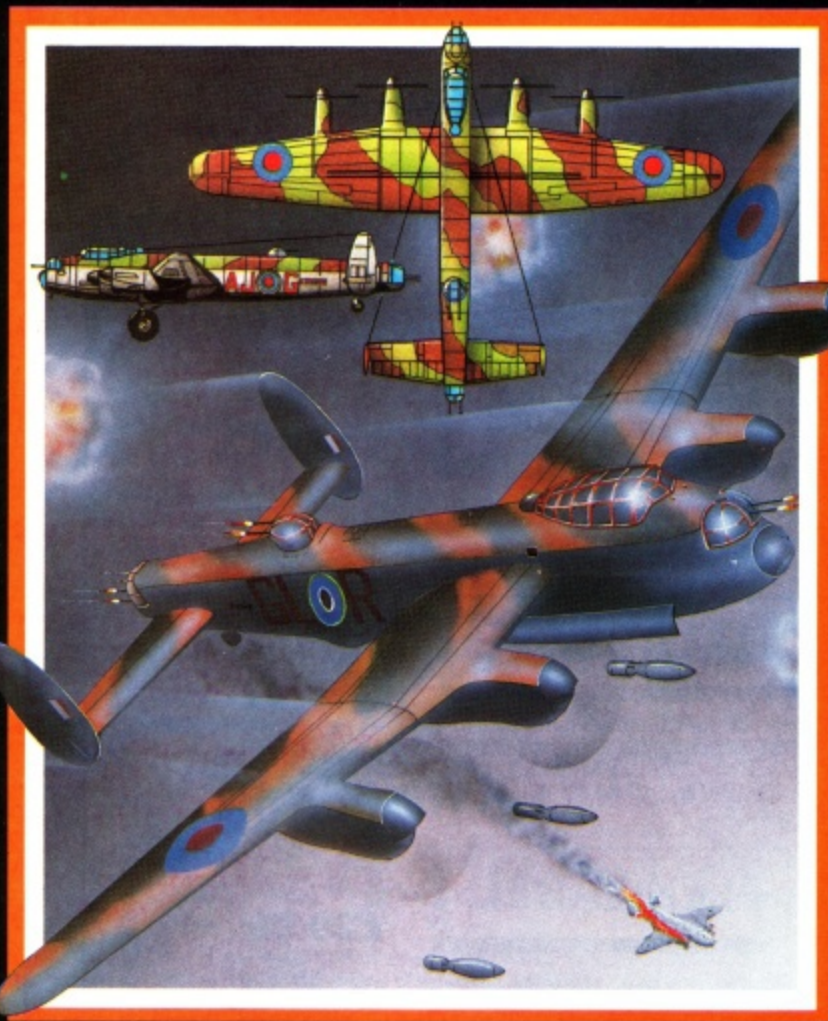

ONLY ACES SURVIVE IN ...

NIGHT GUNNER

AMSTRAD

464, 664, 6128,
COLOUR OR GREEN SCREEN

NIGHT GUNNER – The amazing air battle scenario that stretches you to the very limit – guns blazing, enemy fighters attack from all directions – 3D ground attack sorties and there's still the flight back home.

BY R.J. SWIFT
ADAPTED BY TIM MOORE
Cassette 7.95 Disk 13.95

NIGHT GUNNER is an action packed arcade game based upon a Second World War scenario. You are the gunner and bomb aimer whose task is to defend your plane against enemy attack and destroy the ground forces in each of the challenging missions. The rewards are high for the expert marksman, but beware! The battle becomes tougher with each new mission.

- 30 ground attack missions
- Realistic 3D effects
- Explosive sound
- 1 or 2 players each with 4 levels of difficulty
- High score table with medals
- Self demonstrating title page



AMSTRAD CPC 464, 664, 6128

- | | | |
|--------------------|--------------------------|--------|
| Night Gunner | <input type="checkbox"/> | £7.95 |
| Night Gunner Disk | <input type="checkbox"/> | £13.95 |
| Tomahawk | <input type="checkbox"/> | £9.95 |
| Tomahawk Disk | <input type="checkbox"/> | £14.95 |
| Fighter Pilot | <input type="checkbox"/> | £8.95 |
| Fighter Pilot Disk | <input type="checkbox"/> | £13.95 |
| ATARI | | |
| Fighter Pilot Disk | <input type="checkbox"/> | £12.95 |
| Fighter Pilot | <input type="checkbox"/> | £9.95 |

SPECTRUM

- | | | |
|---------------------|--------------------------|--------|
| Night Gunner 48K | <input type="checkbox"/> | £6.95 |
| Tomahawk 48/128K | <input type="checkbox"/> | £9.95 |
| Fighter Pilot 48K | <input type="checkbox"/> | £7.95 |
| COMMODORE 64 | | |
| Speed King Disk | <input type="checkbox"/> | £12.95 |
| Speed King | <input type="checkbox"/> | £9.95 |
| Fighter Pilot Disk | <input type="checkbox"/> | £14.95 |
| Fighter Pilot | <input type="checkbox"/> | £9.95 |

VAT and p.&p. inclusive within UK (overseas inc. 55p per cassette)

Tele Sales (0276) 684959



Please debit my Access/Visa card no.

Expiry date _____

Cheques made payable to Digital Integration Ltd

I enclose a cheque/P.O. for _____ Total

Please send to

DIGITAL INTEGRATION

Watchmoor Trade Centre,
Watchmoor Road,
Camberley, Surrey
GU15 3AJ

Trade and Export enquiries welcome. Lifetime Guarantee.

Name _____ Address _____

**NEW TAPE AND DISC
CPC464/6128 UTILITIES**

Yes LERM, famous for our SPECTRUM programs, now has vital utilities for AMSTRAD owners. We also offer on ALL our products:

- A FULL MONEY BACK GUARANTEE.
- AN UPDATE SERVICE to get the latest version at a reduced price.

TAPESPEED TWO (TS2)

ESSENTIAL FOR ALL 464 AND 6128 OWNERS

Convert your slow loading software from 1000 to a max. of 3600 baud. Stop and study programs. We believe TS2 to be the most comprehensive backup program of its type.

- AMAZING! — now converts many of the "CLICKY" leader programs, some will load into 6128 for the first time.
- Fully automatic. It loads in continuously up to 44k.
- Save at range of 9 speeds.
- Permanent display of HEADER plus STATUS information.
- Motor on/off. Insert PAUSE. Removes protection.
- Handles HEADERLESS files.
- Handles Amstrad programs with Spectrum loaders — convert to Amstrad for study and conversions. Speed (Baud rate) detector.
- VERY SIMPLE TO USE — FULL MANUAL.

DISC MANAGER ONE

Essential to help you manage your AMSTRAD drive. No risk — try it and see how useful it can be.

- Does a CAT which can then be used to do repeat ERASURES very easily. Gives disc type. Memory free/used.
- 2 Disc editors — edit or study sectors of a disc.
- Recover ERASED files.
- Simple and fast whole disc or sector BACKUP copier.
- Send outputs to printer (CAT, sector contents, etc).
- Unsecured for easy adaptation/drive transfer.
- Menu driven - FULL manual.

ALL INCLUSIVE PRICES:

Tapespeed two: £6.99 Disc Manager £5.99 State 464 or 6128

(Overseas: add £1 within Europe, £1.50 others)
SAE for more information.

**LERM, DEPT AU, 10 BRUNSWICK GDNS,
CORBY, NORTHANTS NN18 9ER**

AMSTRAD

CPC 6128 Green	P.O.A.
CPC 6128 Colour	P.O.A.
PCW 8256	£399 + VAT
PCW 8512	£499 + VAT
CF2 Floppy Disc	£3.75 + VAT
CF2 DD Floppy Disc ...	£5.00 + VAT



Prices include Postage & Packing.



**CYCA
LTD.**

**287 Caledonian Road,
London N1 1EG.**



01-700 4004



SOFTWARE for PCW8256/8512 & 6128

MICROFILE/MICROWORD

Formerly FLEXIFILE/FLEXIWRITE and now adopted by AMSTRAD under new names (Soft 07053).

MICROFILE is the FASTEST database around for the PCW8256/8512 allowing you to use a whole disk (drive A or B) for data storage. The programs reside in the RAM disk for convenience and speed of operation. Features include user defined screens, reports and multiple selections, redefine database, import and export data, calculations and more. Records can be up to 1600 characters and files can have up to 65,000 records if you have the disk space!

MICROWORD is a WORDSTAR (tm) work alike word processor with built in MAILMERGE, fast scrolling, external printer support, sorting, ASCII files and many extra features. Can use MicroFile export data for mailmerge.

**BOTH PROGRAMS FOR
JUST £49.95**

Microfile/Microword/Flexilabel
Purchased together **£69-95**



All prices include VAT and postage — NO EXTRAS
Send for our brochure for full program details
Guaranteed 48 hour despatch

Saxon Computing

11 Arram Road, Leconfield, BEVERLEY, Humberside HU17 7NP
Telephone for BROCHURE or ORDERS **0401-50697**

**CASH BOOK
ACCOUNTS**

£29.95

Accounting for cash retail businesses to VAT Scheme D. Includes regular management reports. (PCW 8256 only).

DATABASES

£29.95

Ready built database templates for use with FlexiFile or AMSOFT's MicroFile. Applications for ESTATE AGENTS, DRIVING INSTRUCTORS, FARMERS, COLLECTORS, GARDENERS*, COMPANY DETAILS*, SALES PROSPECTING & more. (* includes data).

FLEXILABEL

£29.95

Flexible label handler producing multiple copies of mail list labels. Can read FlexiFile and Flexiwrite files or use direct input. Has both preset and user definable label sizes & formats.



GREEN BERET

After Who Dares Wins II, Commando and Rambo another of the arcade warfare games makes the transition to the small screen. Unlike the others this one gives a rather more 2D view of the action and your task is to move to the right rather than up the screen. However the overall concept is quite similar – you are the sole representative pitted against unthinkable odds whose task is to kill as many of the opposition as get in your way while trying to get as far as possible in order to release captured allies.

You start armed only with a knife while some of your opponents have rifles. Contact with any of the heathen masses means instant death, the consequent loss of one of your lives and return to the start of the current section.

In the first part of the game you have to battle across a number of linked bridges. As you reach the right hand edge of the screen the action ceases temporarily while the screen is scrolled to the left bringing the next screen in to view. On each screen there are two levels, periodically linked by ladders. You can sometimes climb or descend these ladders in order to avoid a bullet or one of the other soldiers.

Movement is either by redefinable keyboard option or joystick. Upward movement while not at the base of a ladder causes your man to jump, which again is useful for avoiding death. Downward movement causes your man to lie flat on the ground which can be useful for avoiding a flying drop kick.

There are three types of foe. First are the rather dim greeny/brown clothed soldiers who stick to one level and travel in only one direction. They are quite easily avoided if you are not being chased and points can be gained by stopping for a second and using the fire button to thrust your knife into them. It is not absolutely necessary to stop, but it does make the timing of your thrust easier to judge. This first type of baddy look a bit like rather fat landlords from a German bierkeller and it is difficult to take them as a serious threat.

The orange/blue outfitted soldiers look a lot more serious and they are certainly a greater threat. Not only do they carry rifles and periodically stop to shoot a bullet at you, but they will also turn to follow you and will even go up and down ladders after you. The third soldier you see early on is the Commandant who looks more like a plumber in blue overalls, but it is as well that you can spot him. Killing him gives you one of the heavier weapons (initially a flame thrower) which comes in handy at the end of a stage when things get hectic.

Once past the bridges, the background changes to missile carrying trucks and this is followed by ICBMs on their

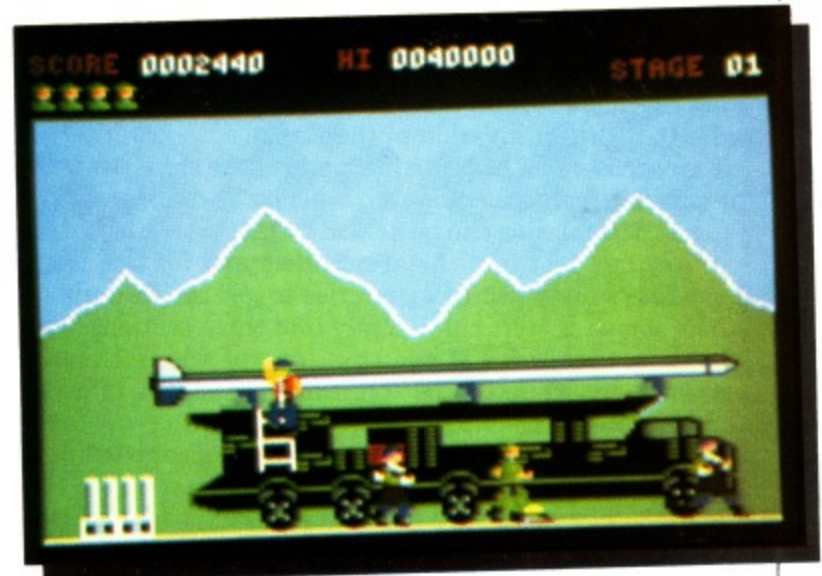

launchpad. It's any one's guess what comes after this, though I'm sure people are bound to find out.

Author: Imagine Software
Price: £8.95 tape, £14.95 disc

Colin

I thought Who Dares Wins II was quite a good battle game but I think this one might just have the edge. The gameplay isn't identical but anyone who loves killing anything that moves is going to like this.

The outfits of the opposing soldiers sometimes look quite comical but I love the drop kicking Cossacks at the end of the bridge section.

As always, I think the game might have looked better

in the higher resolution Mode 1 but good use is made of the colours in Mode 0. The sound was nothing to write home about but I can't say I'm ever that bothered about it anyway.

The game is certainly very addictive and although I haven't got too far yet I still keep going back to see if I can get a little further. I think I'll have to find an infinite lives poke before too long.

Liz

I think that taking on an infinite number of soldiers armed only with a flame thrower is a lot of fun. You can fire a ball of flame and then follow it so that lots of men get killed. Not a game for the squeamish.

Nigel

This game has the manic quality of a real arcade machine. The constant action requires enormous concentration and fast reflexes. I think it's all too much for me. I just can't get anywhere.

V

V is a new game from Ocean loosely based on the popular TV series. The idea is that you play the part of Donovan and you must complete several tasks on board the alien mothership in order to avert an invasion of the Earth.

Explosives must be set in key parts of the ship – water inlet, air purifier, central computer, nuclear reactor and docking hangar. The mission can be helped by getting the lethal (to the reptiles) red dust into the atmosphere and for this Donovan must first visit several laboratories to get the formula.

The screen is split horizontally into three sections. The top two show two levels of the ship, one of which Donovan is currently on, while the bottom third has status information and the control panel.

Joystick or keyboard are used to move Donovan left or right. Upwards movement causes him to forwards roll in the current direction unless he is standing on a red beam pad in which case he will go up a level. If he is in front of a lateral door then he is taken to the next plane of the ship. In a laboratory the same movement picks up a piece of the red dust formula while in an arms dump it will rearm his laser. Downwards movement has several effects. At a lateral door it takes him back one plane. On a red beam pad it takes him down a level and if pressed with fire it allows the communiputer to be used.

The communiputer is a multipurpose device whose chief function is to locate the important parts of the ship.

On reaching a security door, Donovan activates the communiputer and it is then possible to arrange a code to match the correct one shown above. Working from the right it is first necessary to identify the next code symbol in the correct code. This same symbol must then be identified in the lower code. The cursor is moved beneath it and the fire button pushed so that it is switched with the symbol at the left hand end. The cursor is then moved beneath the position where this code will go and fire is pushed again. Working along the code in

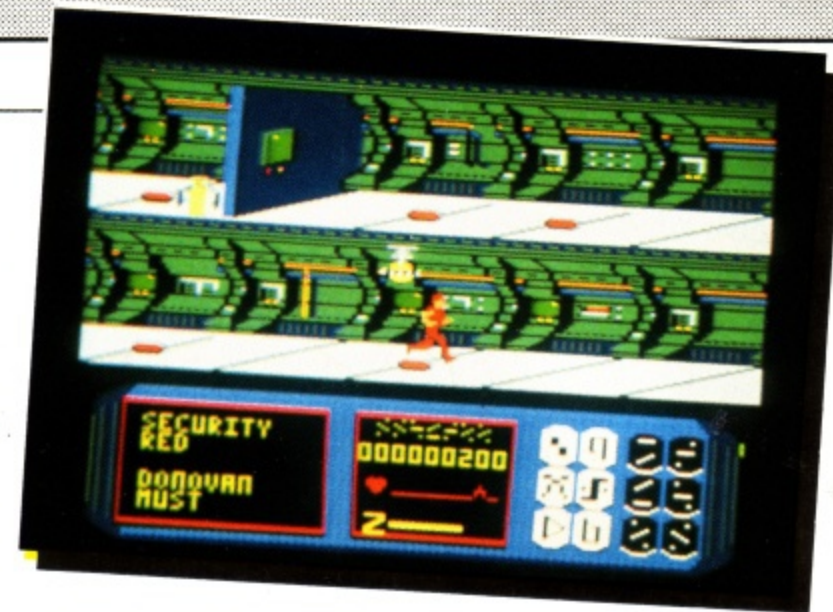

this way it soon becomes a simple matter to quickly get through a security door.

The huge game map is divided into an X, Y grid in which the X position is given by the current sector number (increasing to the right) and the Y position by the level number (increasing downwards). A third dimension, the current plane, also exists. Travel between planes can only be made by means of a lateral door. In each of the five planes there is a laboratory and it is only when they have all been visited that the red dust formula can be fully deduced.

There are yellow surveillance robots that report your position to the other robots, green maintenance robots and the kamikaze security robots that come straight for you. You have a laser to defend yourself but it runs out quite quickly. Each time you come into contact with a robot, the static charge it carries increases your heart rate until it becomes lethal. A period of rest allows it to return to normal rate.

Author: Ocean

Price: £8.95 tape, £14.95 disc

Nigel

As probably the world's greatest fan of V, the TV series, I awaited the computer game with great interest. Unfortunately my initial reaction was a little disappointing. Some of the truly magic touches of the TV series, like the cardboard dialogue and outrageous happenings were missing.

However if you try to ignore the tie-in and just look at the game on its own merits then perhaps it isn't too bad. Certainly the map size (I would guess at least 5 x 25 x

25) is pretty good and should keep map makers busy for ages.

Robots following you don't always appear to be consistent though this does mean that you can avoid them by out running them. While I remain disappointed that there isn't a great crunching sound effect as you bite the head off a white rat I think the game is still worth a look.

9/20

Liz

V, the television programme, was so dreadful it was brilliant. V the computer program is so dreadful it is boring. Running around the spaceship is a bit like being lost in the London underground, and the communiputer is about as much use as one of those maps with lights at the big underground stations. Donovan jumps and tumbles to

avoid the robots but seems to lose weight in mid-air. Opening the combination locks is frustrating before you know how to do it and tedious after. The TV show was so full of spaceships, street fighting, espionage and general excitement that it is hard to see how Ocean mucked this one up.

9/20

Colin

I was a huge fan of the series – I never missed an episode – and was really looking forward to the game.

What do we get? Dross! What a load of old rubbish. Plant the bombs in the visitors' spaceship. Find the red dust. How many lizards in this game? None. How many little furry animals get eaten? None. How many lasers

get fired? None – I don't call Donovan's pathetic gun a real laser.

How many robots did you see in the series? None. How many points out of 2,000 do I give this game? None. Why don't Ocean throw this in the bin and write something resembling the series.

14/20

Your key to communications!

**NEW AMSTRAD
DATABASE**



PRESTEL

PRESTEL is a trademark of British Telecommunications

FREE Electronic Mail . . . International Telex . . . 10 National Chatlines (Interactive Bulletin Boards) . . . 70,000 users across the UK . . . Teleshopping . . . Multi-User Interactive Strategy Games

Instant computer news . . . Hardware and software reviews . . . Technical features . . . Hints and tips . . . On-line business advice and features

FREE and discounted quality software to download direct to your micro - **24 hours a day**

300,000 pages of information on the huge Prestel database

for just 20p a day

Micronet 800-
The ultimate peripheral

Micronet 800
8 Herbal Hill, London EC1R 5EJ
Telephone: 01-278 3143

To: **Micronet 800, 8 Herbal Hill, London EC1**
Please send me a brochure on Micronet 800

Name _____

Address _____

_____ Telephone No. _____

Age _____ Micro _____

AMU 8/86

TASWORD 6128

THE WORD PROCESSOR FOR THE AMSTRAD CPC 6128

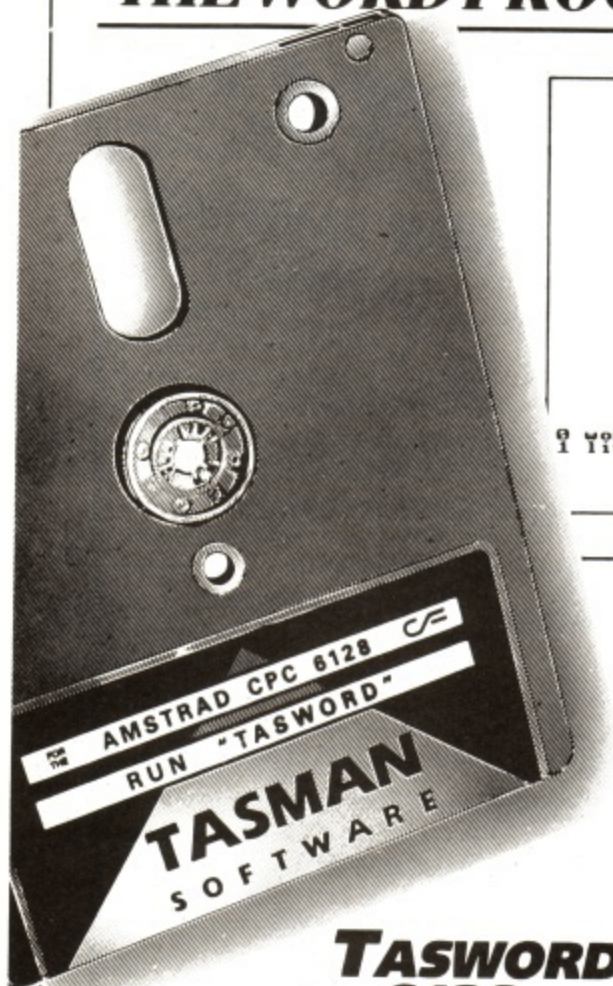

TASWORD 6128

THE WORD PROCESSOR

TASWORD 6128 for the Amstrad CPC 6128
disc £24.95

Brilliant value for money.

AMSTRAD ACTION December 1985.

A powerful and easy to use word processor and a superb data merge program.

AMTIX December 1985.

TASWORD 6128 is the word processor especially developed to utilise the extra memory in the CPC 6128.

The program uses ALL the additional 64K of memory in the CPC 6128 as text space. This means that text files can be around ten thousand words long.

TASWORD 6128 includes a built-in data merge program. Mail merge, in which a letter is printed any number of times, each individually addressed to a different person, is just one of the applications of this powerful facility.

The notepads are a unique feature of TASWORD 6128. Four separate notepads are available. Typing reminders and storing letter headings are just two possible applications for the notepads.

Up to one thousand characters can be stored in ten user definable keys allowing commonly used words, sentences, or even paragraphs to be typed with a single keypress.

TASWORD 6128 has comprehensive customisation features. These allow many of the program facilities to be changed to personal requirements. A customised program can be saved and includes the notepads and user definable keys.

TASWORD 6128 is fully compatible with TAS-SPELL and TASPRIINT. It will also read in data from Masterfile 6128. It can even be used to enter and edit your own Basic programs.

With all standard and many extra word processing facilities TASWORD 6128 is the most powerful of the TASWORDS, for the Amstrad CPC computers.

TASWORD 6128
The Word Processor
© Tasman Software Ltd 1985

Print text file	P
print with Data merge	D
Save text file	S
Load text file	L
Merge text file	M
Return to text file	R
Customise program	C
save Tasword	T
Erase file from disc	E
into Basic	B
check spelling	K
Install Taspriint	I

9 words
1 lines

9 characters
65276 characters free

Drive A

```

^ move text left      ^ delete word      ^ start of text     ^ fast scroll up
^ centre line        ^ delete line      ^ end of text      ^ fast scroll dn
^ move text right    ^ undelete line   ^ start of line    ^ word right
^ justify para (00) ^ clear text      ^ end of line     ^ word left
^ rejust line (00-0) ^ insert line/char ^ scroll up        ^ scroll down
    
```

Mr J H Shears
17 High Street
Lockton Bay
Lancashire LA7 6LX

3rd February 1986

Dear John,

Thank you for your letter of the 31st January. I have corrected the first draft of the article and incorporated your suggested changes. It is a good thing TASWORD has a find and replace facility! You will see from the enclosed print out of the corrected draft that I have also made some other changes and I hope that you agree that they are an improvement.

Line 16[Col 50]B/J on [W/M on [Insert off][Paging off][C for help]NORMAL CHARS

TASWORD 464-D

THE WORD PROCESSOR - WITH MAIL MERGE!

TASWORD 464-D disc £24.95

This is the new TASWORD especially developed to utilise the capabilities of the CPC 464 and 664 disc drives. The additional facilities include a larger text file size and automatic on-screen disc directories during save and load operations. A major new feature is the mail merge facility. This gives multiple prints of your standard letters, forms, etc., with each copy containing, for example, a name and address automatically taken from a disc file containing the data. This data can be entered using TASWORD 464-D, or created using the Masterfile Program Extension package. A powerful and useful conditional printing facility is included - parts of a document can be printed according to user-specified criteria. TASWORD 464-D will only run on, and is only supplied on, disc.

TAS-SPELL

THE SPELLING CHECKER

TAS-SPELL disc £16.50
for the Amstrad CPC 464 and 664 running
TASWORD 464-D and for the CPC 6128 running
TASWORD 6128

Spelling mistakes and typing errors spoil any document whether it is a private letter or your latest novel. With TAS-SPELL you are free to be creative in the confident knowledge that your spelling won't let you down.

TAS-SPELL checks the spelling of TASWORD 464-D and TASWORD 6128 text files. TAS-SPELL has a dictionary of well over twenty thousand words which it compares with the words in your text. If a word is not recognised then the relevant part of your text is displayed with the suspect word highlighted. You can correct the word, ignore it (it might be a name), or even add it to the TAS-SPELL dictionary.

Please note that TAS-SPELL will only work with TASWORD 464-D and TASWORD 6128.

TASWORD UPGRADES

TASWORD 464 and Amstrad owners: send your original cassette or disc (not the packaging) as proof of purchase and £13.90. Your original will be returned together with TASWORD 464-D or TASWORD 6128 on disc.

TASPRIINT 464

THE STYLE WRITER

TASPRIINT 464 cassette £9.90 disc £12.90

A must for dot-matrix print owners! Print your program output and listings in a choice of five impressive print styles. TASPRIINT 464 utilises the graphics capabilities of dot-matrix printers to form, with a double pass of the printhead, output in a range of five fonts varying from the futuristic DATA-RUN to the hand-writing style of PALACE SCRIPT. TASPRIINT 464 drives the dot-matrix printers listed below and can be used to print AMSPRINT/ TASWORD 464 text files. TASPRIINT 464 gives your output originality and style. Completely compatible with the 664 and 6128.

TASWORD 464

THE WORD PROCESSOR

TASWORD 464 cassette £19.95

"There is no better justification for buying a 464 than this program"
POPULAR COMPUTING WEEKLY,
NOVEMBER 1984

Your 464 becomes a professional standard word processor with TASWORD 464. Supplied complete with a comprehensive manual and a cassette which contains both the program and TASWORD 464 TUTOR. This teaches you word processing using TASWORD 464. Whether you have serious applications or simply want to learn about word processing, TASWORD 464 and the TUTOR make it easy and enjoyable.

TASCOPY 464

THE SCREEN COPIER

TASCOPY 464 cassette £9.90 disc £12.90

A suite of fast machine code screen copy software for the CPC 464, 664 and 6128. Print high-resolution screen copies in black and white and also large 'shaded' copies with different dot densities for the various screen colours. TASCOPY 464 also produces 'poster size' screen copies printed onto two or four sheets which can be cut and joined to make the poster.

TASPRIINT 464 and TASCOPY 464 drive the following dot-matrix printers:

AMSTRAD DMP1 MANNESMANN STAR DMP501/5/515 SHINWACP-80
EPSON FX-80 TALLY MT-80 BROTHER HRS COSMOS-80
EPSON RX-80 BROTHER M1009 DATA PANTHER AMSTRAD DMP2000
EPSON MX-80 TYPE III NEC PC-8023B-N DATA PANTHER II

TASWORD 8000

THE WORD PROCESSOR FOR THE AMSTRAD PCW 8256 AND 8512

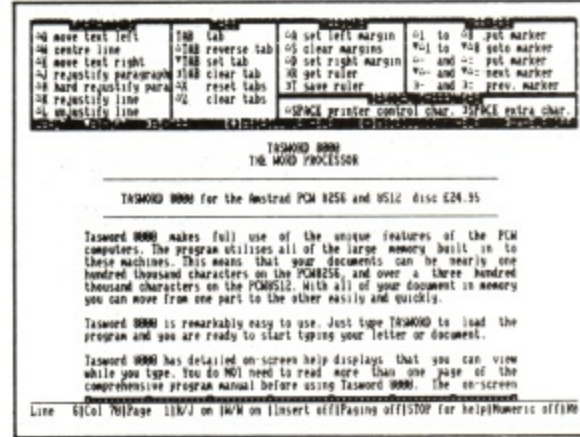
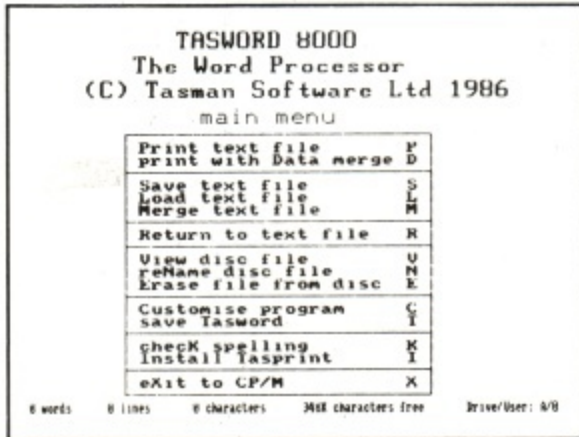

TASWORD 8000

THE WORD PROCESSOR

TASWORD 8000 for the Amstrad PCW 8256 and 8512 disc **£24.95**

TASWORD 8000 makes full use of the unique features of the PCW computers. The program utilises all of the large memory built in to these machines. This means that your documents can be nearly one hundred thousand characters long on the PCW 8256, and over three hundred thousand characters long on the PCW 8512. With all of your document in memory you can move from one part to the other easily and quickly.

TASWORD 8000 is remarkably easy to use. Just type TASWORD to load the program and you are ready to start typing your letter or document.

TASWORD 8000 has detailed on-screen help displays that you can view while you type. You do NOT need to read more than one page of the comprehensive program manual before using TASWORD 8000. The on-screen help information, and the interactive TASWORD 8000 Tutor supplied with the program, means that you can be using TASWORD 8000 to produce your own work just as soon as you get it.

MAILMERGE. TASWORD 8000 includes the powerful TASWORD mail merge facility. You can keep a list of names and addresses on disc and TASWORD will print your letter, individually addressed, to each of your intended recipients. The TASWORD mail merge is open-ended and flexible—the keeping of names and addresses is just one possible application. You can keep any sort of information as mail merge data (your record collection, stock information, recipes) and TASWORD will include the information into your letters and documents on your command.

TASPRINT. As well as mail merge TASWORD 8000 includes the TASPRINT program and two of the TASPRINT fonts (Lectura Light and Median). This gives you two new unique typesets on the PCW printer. These two TASPRINT fonts give your printed letters a very special appearance and they also have great impact when used as headings in other documents. The range of typesets available can be increased still further by obtaining TASPRINT 8000 which has an additional six fonts.

The Check Spelling option shown on the screen picture above requires the program TAS-SPELL 8000 which will be available in the Autumn of 1986. TASWORD 8000 will load Locoscript and other standard ASCII files and will also drive all other printers in addition to the PCW printer.

TASPRINT 8000

THE STYLE WRITER

TASPRINT 8000 for the Amstrad PCW 8256 and 8512 disc **£14.90**

TASPRINT 8000 consists of a further six fonts that can be used with TASWORD 8000 to extend and enhance the variety and appearance of your printed documents. In addition, with TASPRINT 8000 you can print files from disc onto the PCW printer in one of the eight TASPRINT 8000 fonts. TASPRINT 8000 utilises the graphics printing capability of the PCW printer and the printed text is double the height of normal text—ideal for notices, posters, and for headings within documents.

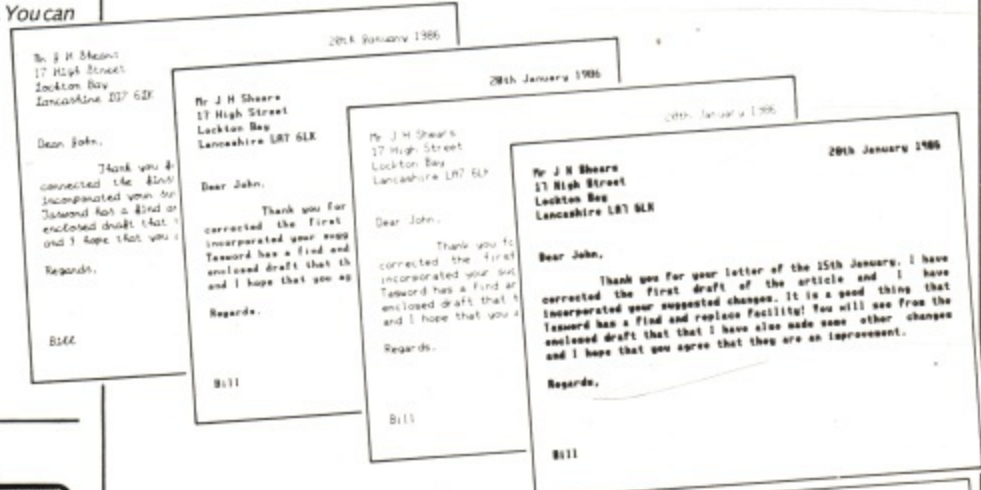

Available from good stockists and direct from:

Tasman

SOFTWARE

Springfield House, Hyde Terrace, Leeds LS2 9LN. Tel: (0532) 438301

If you do not want to cut this magazine, simply write out your order and post to: TASMAN SOFTWARE, DEPT AU, SPRINGFIELD HOUSE, HYDE TERRACE, LEEDS LS2 9LN

I enclose a cheque/PO made payable to TASMAN SOFTWARE Ltd OR charge my ACCESS/VISA number:

NAME	ITEM	PRICE
_____	_____	£ _____
_____	_____	£ _____
_____	_____	£ _____
_____	_____	£ _____
_____	_____	£ _____
TOTAL £		_____

Outside Europe add £1.50 per item airmail.

Telephone Access/Visa orders: Leeds (0532) 438301



Please send me a FREE Tasman brochure describing your products for: the Amstrad CPC 464, 664 and 6128 , the Amstrad PCW 8256 and 8512 .

AU

Overseas: The following distributors of Tasman products may be contacted for the address of local suppliers. Many products are supplied in translated form. FRANCE & SWITZERLAND: Semaphore Logiciels, CH 1283 La Plaine, Geneva. SCANDINAVIA: Kelly data, Postboks 43, Refstad, Oslo. NETHERLANDS: Filisoft, PO Box 1253, 9701 BJ Groningen. GERMANY: Profsoft, Sutfhauser Str 50/52, D 4500 Osnabrück. BELGIUM: Easy Computing, Avenue Guillaume Lefevre 30, 1160 Brussels. PORTUGAL: Informova, Campo Grande 284 A, 1700 Lisbon. AUSTRALIA: Dolphin Computers, Unit 2, 7 Waltham Street, Artarmon, New South Wales 2064. NEW ZEALAND: Software Supplies, PO Box 865, Christchurch. U.S.A.: Ramex International, 17620 26 Mile Road, Washington MI 48094.

All TASMAN 464 software is fully compatible with the 664 and 6128
All prices include VAT, postage and packaging.

AMSTRAD PCW 8256/8512 and CPC464/6128

Created in consultation with International

**Grandmaster
and British Chess
Champion
Jon Speelman**

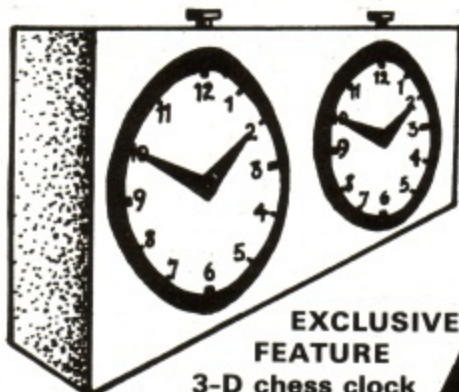

**EXCLUSIVE
FEATURE**
3-D chess clock
gives tournament realism

FAST with unique method of setting levels by time. 'Play against the clock' and 'matching time' modes.

PENETRATING at tournament levels looks at least seven moves deep.

FRIENDLY every possible feature. Ideal tutor for beginner and expert alike.

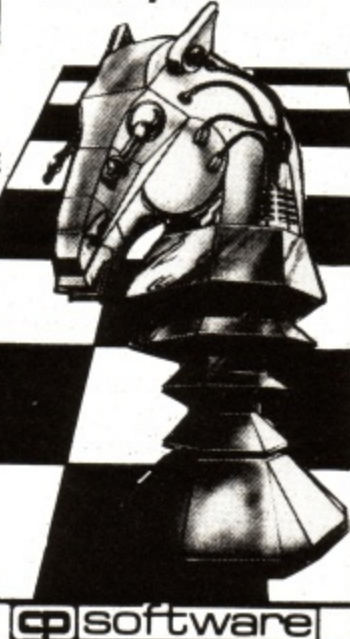

The definitive, challenging and realistic
BRIDGEPLAYER

VERSATILE
bidding routines give you a really worthy opponent.

POWERFUL
bidding and play to appeal to the most experienced player whilst being an excellent tutor for beginners.

COMPREHENSIVE
on-screen displays, keep you informed at all times



8256/8512 BRIDGE PLAYER is the ultimate refinement in home computer versions of this sophisticated card classic. SPECIAL FEATURES include:

- Option to specify point count ● rebid/replay
- Self-play mode ● move to next hand

3-D CLOCK CHESS - £19.95 8256/8512 BRIDGE PLAYER - £19.95

ALSO AVAILABLE for AMSTRAD CPC464/664/6128

3-D VOICE CHESS disc **£15.95** cassette **£12.95**
BRIDGE PLAYER 3 disc **£15.95** cassette **£12.95**

DRAUGHTS cassette **£8.95**
BACKGAMMON cassette **£8.95**
PINBALL WIZARD cassette **£8.95**

MAIL ORDER: Cheque, P.O. or ACCESS/VISA. Telephone for instant credit-card orders.

CP software

15 DESPARD ROAD, LONDON N19 5NP
Tel: 01-272 2918.
Telex: 57784 MCCL G

**STOP
PRESS**

8256 MEMORY/RAM DISC UPGRADE TO 368k £49

5 1/4" DISC DRIVES

NEW FOR THE 464-664 (with CPM+) & 6128

1 MEGABYTE (800K Formatted) 5 1/4" Double Sided Disc Drive £249

supplied with several standard 5 1/4" formats including ICLP2, GEMINI accessible under CPM+

Unlike others this drive can also be used under CPM2.2 and CPM+ AMSDOS to READ & WRITE to a 360K formatted Disc. This means that you still have a standard format throughout your three operating systems.

NO CHANGES TO THE AMSTRAD CIRCUITRY REQUIRED.

3" 2nd Drive all CPC's **£89**
5 1/4" 2nd Drive Standard Capacity **£149**
All Drives have Power Supply, Case, Mains Lead and Connecting Cable and Instructions.

NEW FOR 8256

Turn your 8256 into an 8512 and more.

RAM Disk upgrade makes drive M: 368K.

The CORRECT memory chips for your 8256 kit with full instructions **£49 inc. VAT**

5 1/4" High Capacity Drive - the same data capacity as the 8512 with our new implementation. Runs all business programs as they were designed to be run.

Simple fitting. Stands beside the machine. **£209**



Special Offer. UPGRADE FROM 8256 to FULL 8512

1 x Memory Expansion 1 x 5 1/4" Disc Drive
10 x Blank 5 1/4" Discs **£259**

X ROM EPROM PROGRAMMER/SIDEWAYS ROM CARD FOR THE

464/664/6128 with 4 x Sideways ROM sockets - Programmes 2764 and 27128 Eproms **£79.00**

8256 in stock 8512 in stock 6128 in stock

OVER 500 AMSTRAD CASSETTE TITLES OVER 200 NOW ON DISK IN STOCK.

FULL BUSINESS SOFTWARE RANGE includes:
6128, 8256, Software - Inc - Wordstar, £49.95

Neword	£69.95	Sage Chit-Chat	P.O.A.
Supercalc II	£49.95	Sage Popular Accounts	£99.95
Cardbox	£99.95	Sage Payroll	£69.95
Turbo Pascal	£69.00	Cash Trader	£114.95
Nevada Fortran	£39.95	Camsort Payroll	£39.00
Cobol	£39.95	Database	£39.00
Pascal	£39.95	Invoicing	£39.00
Dr. Pascal	£49.95	Brainstorm	£49.95
Quest ABC, Business Suite	£149.95	Touch and Go	£29.00

Many other Titles in Stock, Please enquire.

SIDEWAYS ROM

Arnor Prospell (Eprom) now available **£34.95**
Arnor Maxam Assembler on Rom **£49.00**
Arnor Maxam Rom (Fits Timatic Interface) **£39.00**
Arnor Disc Utility on Rom **£29.95**
Arnor Word Processor on Rom **£39.95**
MicroPro Rom Card **£39.00**
MicroPro Programmers Toolkit Rom **£39.00**
Prestel Rom (Fits Timatic Interface) **£19.95**

All the latest games as soon as released.
Speech Synthesizers - From **£29.95**

TAPE TO DISC TRANSFERS
MODEMS, CPC 464, CPC 664, CPC 6128, PRINTERS
AMSTRAD RS 232 - **£49.00**
8256 - RS232/CENT - **£59.00 + VAT**

Please send sae for full list to:

TIMATIC SYSTEMS LTD

Mail order welcome,
All Prices include VAT.



DEALER ENQUIRIES WELCOME



FAREHAM MARKET
FAREHAM, HANTS
Tel: FAREHAM (0329) 236727
(0329) 239953

SHOGUN

Shogun is a novel by James Clavell telling the story of 17th century mariner John Blackthorne. Blackthorne is shipwrecked off the coast of Japan and finds himself in the middle of a local power struggle. The conflict is between Lord Toranaga on one side and Lord Ishido on the other, both trying to gain the position of supreme military commander, Shogun. Blackthorne is threatened not only by the whims of his captors but by the presence of the Spanish clergy who are busy exporting the 17th century equivalent of transistor radios and motorbikes.

The game, written by Virgin's Gang of Five, steers a course away from the main stream of the book. The object is for you to become Shogun. The default is that you take on the role of Blackthorne although it is possible to select a peasant or samurai character to play. The game is not so much arcade adventure like Sorcery – also by Virgin – but more an arcade strategy game. There are lots of screens as there are in Sorcery, and a character to move around, but there is more to do than moving and zapping.

You start by selecting your character and then appearing on the beach. The screens are very similar in appearance to Sorcery screens although not as nicely designed. At this point you are likely to meet the first character in the game. You can either choose to smile or attack him or her. This is done by first pressing the spacebar to select an icon. The joystick is then used to move a cursor to the required icon. Pointing at the smiling sun and pressing fire selects smile mode. Now you can shoot smiling suns at the character to befriend him. If this appears to have no effect then select the knife icon and you will go into attack mode. Unless the character is exceptionally good at fighting or not a peasant or servant, you should win the fight. At this point he becomes a follower and you can order him around. The idea of the game is to gain 20 followers before seeking an audience with the Emperor.

Ordering someone is done by selecting the exclamation mark in a speech bubble and pointing a cursor at the character you want to command. If the character is a follower you may



order him to either assassinate one of the other characters, get an object, or protect a character or guard an object. There are several objects dotted around the game like swords, shields, helmets, money and food. Money can be accumulated and spent on bribes. Food is picked up and eaten to replace strength lost in fights and movement. The other objects can be given to other characters to gain their loyalty.

Among the other icons that can be used are functions for examining characters and objects, pausing the game, saving a position, giving away an object, and surrendering in a fight.

Initially you will spend your time exploring the many screens in Shogun. I counted more than 100 so it's quite a big game.

Author: Virgin Games
Price: £9.95

Colin

If you ignore the bad bits of Shogun there is quite a good game lurking underneath. I like this type of icon-driven game but they do take a lot of getting into.

There seems to be a strong moral aspect to this game

with smiling and giving gifts to win people over. Of course, if that fails you cut 'em up a bit. I have to admit that I didn't spend a great deal of time playing the game as I found the jerky movement put me off.

14/20

Liz

The first thing to realise is that Shogun is a strategy game. This is a brilliant way of presenting a strategy game but it is a two-edged sword. Zapp 'em merchants are likely to buy it and be disappointed while the brainy types who would enjoy the program will give it a miss once they see that it is full of sprites. This is where the book tie-in may come in handy.

If people buy the game because they liked the book then they will be the type to get hooked by the game.

I'm sure that if I had a little more patience then I would be much more enthusiastic but, as with Lords of Midnight, it was too much work to get started. OK, so I'm lazy.

13/20

Nigel

Sorcery fans beware! Shogun is quite good in its own way but it isn't Sorcery II. Gone is the smooth animation and nice effects to be replaced by icons and jerky flickering sprites. There are dozens of screens but a lot of them are naff. Worse than this the program is full of bugs. Ladies turn into Lords

halfway through the game and sprites get duplicated in rivers. Having said that, none of these things stop it being a playable game. I managed 10 followers before I pushed my luck and attacked a samurai. Maybe I should have given him a shield.

14/20

GOING LOCO

Alex Martin
thinks about
ink switching

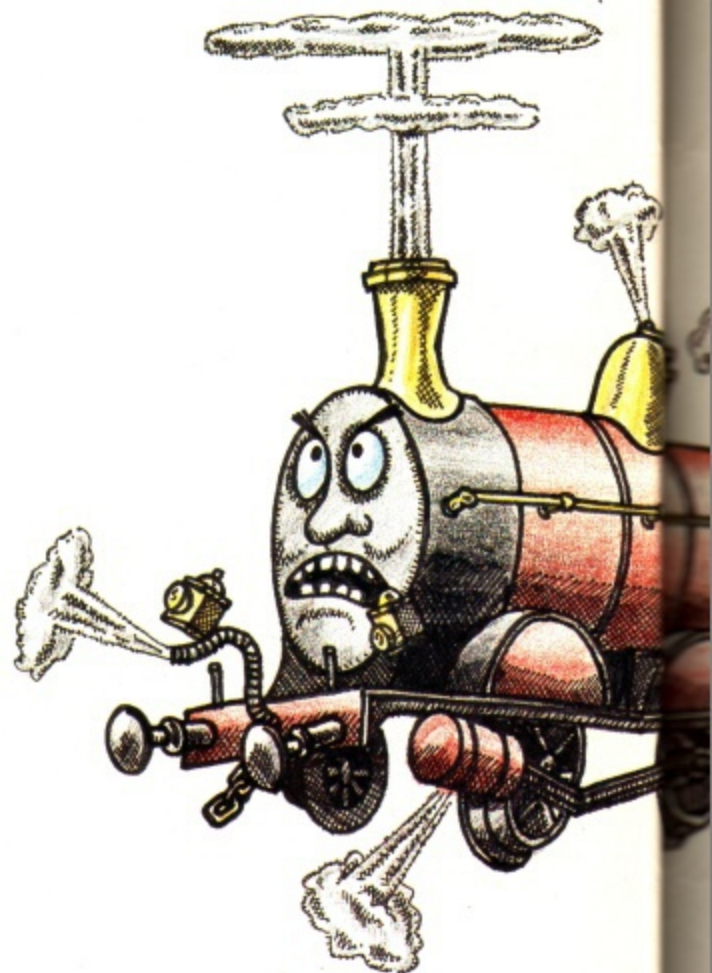

First, matters arising from the June Goin' Loco. Quite a lot of the article was devoted to extolling the virtues of using statements like:

```
10 ON INSTR("ZX",UPPERS(INKEYS)) GOTO 20
,30
```

But as Paul Davies of Newport, Essex and John Durst of Swerford, Oxon, pointed out, this doesn't work. The reason it doesn't work is because the function Instr will return the value 1 if the string that is being searched for is a null string containing no characters.

As the Inkey\$ function returns a null string when no keys are pressed, the program will go to the first line number in the Goto list. The following shows the value returned from the Instr:

```
10 PRINT INSTR("ZX",UPPERS(INKEYS))
20 GOTO 10
```

This will print out a stream of 1s until a key is pressed. If X is pressed, the program will print a 2 and any other key will print a 0. It is interesting to note that pressing Z also produces a 1.

There are two ways of getting round this problem and converting the key press to something useable. The first is to alter the list so that the first entry in it is disabled in some way. The simplest thing to do is send it back to the start of the line:

```
10 ON INSTR("*ZX",UPPERS(INKEYS)) GOTO 1
0,20,30
20 PRINT "Z pressed":STOP
30 PRINT "X pressed"
```

The asterisk is used because whatever character appears first in the list will

always return the same value as a null. If a character is duplicated in the list the first occurrence is the one found by Instr. An asterisk put later in the list will do no good, so effectively you've knocked the poor old asterisk on the head. The second method is to alter the Inkey\$ statement to ignore null strings. This is an example of how to do that:

```
10 ON INSTR("ZX",LEFTS(UPPERS(INKEYS)+"*
"),1) GOTO 20,30
20 PRINT "Z pressed":STOP
30 PRINT "X pressed"
```

In the above program the resulting string, used as the string to search for, is the leftmost character of a two character string created by adding an asterisk to the Inkey\$. If the Inkey\$ returns a null string then the asterisk becomes the character being searched for in the Instr command.

On to more exciting things

Well, that took quite a bit of tidying up didn't it? In recent months I've been concentrating on characters and data handling - pretty boring stuff to those among you keen to produce the odd game or two. The rest of this month's space will be devoted to ink switching, a technique which enables smooth animated effects to be created by changing the colours of the inks.

Inks, pens and colours on the Amstrad are one of the most easily misunderstood aspects of the computer, which is a good reason for not trying to explain them here. I will, however, relent and give you a brief idea of what they are about.

Forget all the preconceptions (*ideas*

you've had before - Ed) that you have about the terms pen and ink, Okay, I know it means something else in Cockney rhyming slang. On the Amstrad, pen refers to the implement with which you are currently writing. This fictitious pen puts on to the screen the ink that the pen is loaded with.

As we all know, real ink is water with pigment in it. Consider the ink that is put on your computer's screen as being equivalent to water. It is transparent and invisible. Only when the ink is pigmented can you see it. There are various commands on the Amstrad which control these functions.

Pig pen

The command PEN is used to select the ink to put into a pen. Only a certain number of inks are permissible depending on the screen mode and these always start from zero and work up. The command PAPER is equivalent to PEN but sets the ink to use for the background. PEN is specific to text (printing characters). There is no command on the 464 to set the graphics equivalent of the text pen but it is possible to set it using the graphics commands.

through every colour the Amstrad can produce:

```
WHILE -1:WHILE INKEYS="":WEND:ORDER n:n
=(n+1) MOD 27:WEND
```

The animating ink show

Enough of all that. It's time to take a hard look at switching inks. We'll start off with a short listing.

Here it is:

```
10 ON BREAK GOSUB 150
20 MODE 0
30 FOR n=1 TO 15
40 MOVE 100+(10*n),100
50 DRAWR 0,100,n
60 INK n,0
70 NEXT n
80 :
90 n=n+1:IF n>15 THEN n=1
100 INK n,20
110 WHILE INKEYS="":WEND
120 INK n,0
130 GOTO 90
140 :
150 INK 1,20:STOP
```

The first line is there to help you. When you break out of the program, it goes to line 150 to change INK 1 to something legible after the program has altered it. The next few lines put the micro into 20-column mode and draw 15 vertical lines, one in each ink. Each ink used is then set to black.

The second part of the program loops round adding to the number of the current ink (n). The current ink is then changed to 20 (bright cyan), and a key press is waited for. When the key press comes, the current ink is put back to black (0) and the program starts the loop again. Pressing a key and holding it will produce the animation effect.

The above listing shows how to produce ink switching animation using graphics. To do the same with text, you need to use the command PEN. This is illustrated in this program, similar to the above.

```
10 ON BREAK GOSUB 140
20 MODE 0
30 FOR n=1 TO 15
40 LOCATE n,10:PEN n:PRINT CHR$(143);
50 INK n,0
60 NEXT n
70 :
80 n=n+1:IF n>15 THEN n=1
90 INK n,20
100 WHILE INKEYS="":WEND
110 INK n,0
120 GOTO 80
130 :
140 INK 1,20:PEN 1:STOP
```

You may be unimpressed by these examples – surely the same can be done without complex fiddling with inks? The advantage of doing it this way is that large areas of screen can be altered in colour within a fraction of a second. The last two programs show a little of the scope of ink switching. I'm not going to attempt to explain how they work. The first is a simple demo while the second is

the old reaction testing game with a new twist:

```
10 ON BREAK GOSUB 150
20 MODE 0
30 FOR c=1 TO 25*20
40 PEN (c MOD 16)
50 PRINT CHR$(143);
60 NEXT c
70 :
80 n=n+(RND*15)+1
90 IF n>15 THEN n=0
100 INK n,20
110 WHILE INKEYS="":WEND
120 IF (RND*100)>50 THEN INK n,0
130 GOTO 80
140 :
150 PEN 1:INK 1,20:INK 0,0:MODE 2:STOP
```

Radioactive reactions

Here's the game. You are the attendant of a super fusion power cell. The cell has a spinning shield with a gap in it. You must squirt a jet of coolant on to the cell every so often to prevent the cell going critical. If you miss the gap and hit the shield you will damage it making the cell explode.

If you don't cool the cell before the meter reaches max, the cell will explode anyway. Oh, there's just one other thing, whenever the cell is hit by coolant, the foreman increases the output of the cell and the shield spins faster. Yes, I know it's nonsense but it's also a good illustration of ink switching.

```
10 DEFINT a-z:DEFREAL t:INK 0,0:INK 1,23
20 ENV-1,2,20,2:ENV 1,-13,25,-9,4000
30 MODE 0:DEG:a=3:b=2:onn=6:off=0:delay=
50:x=320:y=30:y1=130
40 FOR n=2 TO 15:INK n,onn:NEXT
50 WINDOW #1,1,1,25:LOCATE 2,23:PRINT
_max":GOSUB 320
60 ORIGIN 320,200:PLOT 0,-400,1:TAG:MOVE
-16,-190:PRINT"":MOVE -16,0:PRINT
"":TAGOFF
70 :
80 :
90 FOR n=14 TO 372
100 i=n/25.7+1:MOVE SIN(n)*100,COS(n)*1
00:DRAW SIN(n)*120,COS(n)*120,i
110 NEXT
120 ORIGIN 0,0
130 :
140 :
150 a=a+1:b=b+1:IF a=16 THEN a=2
160 IF b=16 THEN b=2:MOVE 0,hot:DRAW 10
,0,1:hot=hot+2:IF hot=32 THEN DRAW 10
170 INK a,off:INK b,onn:t=TIME:WHILE t+d
elay>TIME:WEND:CALL &BD19
180 IF INKEYS<>"":THEN GOSUB 220
190 SOUND 1,delay,5,7:GOTO 150
200 :
210 :
220 IF a=8 THEN delay=delay-1:MOVE x,y:0
DRAWR 0,y1,1:MOVE x,y:CALL &BD19:DRAW
R 0,50,0:DRAWR 0,20,8:DRAWR 0,60,0:s
core=score+1:hot=0:CLS#1:GOSUB 320:R
ETURN
230 MOVE x,y:DRAWR 0,50,1
240 FOR n=15 TO 2 STEP -1:n=n+(n=a):INK
n,26,24:NEXT
250 FOR n=50 TO 1 STEP -1:t=TIME:WHILE t
+30>TIME:SPEED INK 5,n:WEND:SOUND 12
9,n,20,7,0,1,10:NEXT:SOUND 129,0,100
,1,1,0,31
260 IF score>highscore THEN highscore=sc
ore
270 hot=0:CLS#1:delay=50:score=0:GOSUB 3
20:MOVE x,y:DRAWR 0,50,0:FOR n=2 TO
15:INK n,onn:NEXT
280 WHILE INKEYS<>"":WEND:WHILE INKEYS="
":WEND
290 GOTO 150
300 :
310 :
320 LOCATE 2,1:PRINT USING "HI #### SCO
RE ####":highscore,score:RETURN
```



Red ink

The command INK is used to select the colour an ink displays. There are at least two parameters to an INK command. The first specifies the ink to set and the second the colour, which will be a number from 0 to 26. A third parameter allows a second colour to be specified. This will make an ink alternate between the two colours. The technical term for this is flashing.

There are no limitations on what colours inks can be set to. If you want, you can set all the inks to display red. That would mean, when the program finished, it would print a red Ready on red. Of course you will not be able to see it – or anything else subsequently printed on the screen – unless you set the ink, which the text pen has used, to something else.

South of the border

A useful thing to remember when playing with inks and pens is that the border is completely independent of inks and only understands colours. This means that you can test a colour number at any time without upsetting whatever you have on the screen. The following program cycles

Farewell to Amstrad Business Computing...

Good luck - Amstrad Professional Computing!

If you have read the editorial in this month's *ABC* you will know that *Amstrad Business Computing* will no longer be with us. It is off to bookshelves new. To reflect the type of user who will benefit from this new publication the name will be changed to:

AMSTRAD
PROFESSIONAL
COMPUTING

The new magazine will concentrate on all aspects of computing for the serious user. But we know that the interests of our readers are not limited to business computing. So while *Amstrad Professional Computing - APC* to its friends - will cover a wide range of topics of concern to the serious user, you can be sure that it won't all be non-entertainment articles. There will be the odd games reviews as well as tutorials and the latest news and reviews of new software, peripherals - and, of course, any future Amstrad computers.

AMSTRAD
COMPUTER USER

So where does that leave *Amstrad Computer User*? As the official magazine for all Amstrad computers, we will continue to support the whole range of existing Amstrad machines and lead the way with any new ones. There will be something for everyone. Of course we won't be as business orientated as our friends at *APC* but then we won't ignore all the useful things you can do with your computer.

Amstrad Computer User will continue all its popular regular features - the Adventure column by Bill Brock, Goin' Loco, Hackers Haunt and others. There will be more programming articles. Colin, Nigel and Liz will give you the lowdown on the latest releases and Least Significant Bit will be as contentious as ever.



The Mastertronic team hard at work on their ultimate executive toy

'We are the kings of budget'

In just two years Mastertronic has come a long, long way. The company that created the £1 game and then went on to drag itself up from its bargain basement roots, now dominates the charts and boasts sales of well over five million tapes. Not bad in anybody's books.

Tucked away to the east of the City of London, the company's offices house the usual collection of micros. Commodores share desks with Spectrums and, of course, the all important Amstrads, while redundant machines retire under benches.

Not that much programming goes on here, but there's a lot of program evaluation to be done. Mastertronic has no trouble tempting programmers to submit their latest offerings.

This is where the company's day to day business is conducted and it's here that I'm to interview Martin Alper, Alan Sharman and John Maxwell about the phenomenal rise of the company which dared challenge the spiralling price of software.

The room contains the usual office paraphernalia plus a Bally Space Invaders pinball table. This provides invaluable therapy when the going gets tough – the ultimate executive toy. It's

Mastertronic has conquered the software scene by creating low cost titles. Jerry Muir went to see what goes on at its London HQ.

surely a sign of Mastertronic's success that a second table is to be ordered.

At the time of our conversation it was just two days before the Mastertronic team packed their bags for a week at the Chicago Consumer Electronics Show. Everyone was busy making last minute arrangements and news had just come through that they had won awards for three of their programs, to add to the two prizes from 1985.

In the midst of the phone calls and the rejoicing I asked Martin Alper, one of the original three directors, how the idea of pocket money software came about.

"We launched in April of 1984 and we go back six months before that. The idea stemmed from a friend who had a duplication plant for data cassettes. We were in discussion with him about the cost of duplicating computer games and we started to do some research into the market and found that what was costing a low price was in fact ending up in the shops at a very high price". That friend now provides Mastertronic's in-house duplication.

"We took a bold marketing decision, that if we were to go strictly for volume we could bring the cost down to a budget

level, although we had no intention of bringing the quality down”.

None of the original triumvirate had been involved in computers. “As we were planning the launch we approached a software company, which John Maxwell was part of, to source a product. We’d tried to source it in the States and found it was very expensive at that time, and that the royalty rates being asked were too high, so we turned back to the UK.

A matter of marketing

At this stage Alan Sharman drags himself from his constantly ringing telephone to tell me about the search for those first releases.

“Initially we looked through the magazines and contacted almost every software house that was there to see if there was anyone who would be willing to let us publish their programs. We found some, had some samples sent up to us, and then selected from there.

As Martin recalls: “We were all three of us involved in successful businesses already and it was strictly a marketing exercise. We had no idea how successful it was going to be. And it effectively happened within eight weeks. We were more than just successful – we were incredibly successful.

“We had taken one or two very bold marketing moves. We contacted the main retailers well ahead of our launch warning them that the price of software was about to crash. Some major retailers listened and were very interested. And we realised, after discussion with them, that it was more likely to be a success than a failure.

“We then decided to put a lot of money and effort into it and we spent a lot of time developing the packaging, logos and point of sale material. This was all thought out well in advance”.

Dealing with distribution

Less dramatic than the sudden drop in price, though equally important in the marketing strategy, was the use of alternative forms of distribution. Martin already had a team of salesmen for his video products and decided to call a sales conference. Everybody was enthusiastic about the idea and suggested other reps. A 62-strong sales team was created, freeing Mastertronic from the existing distribution channels.

“We approached the main retailers and all the independents direct and decided to pitch at unusual forms of distribution – unusual to the software

industry but not to others. We took a leaf out of the record industry’s book and went for newsagents, where budget records are distributed. And that was very successful”. In the two years since then Mastertronic’s patterns of distribution have hardened and today most of its product goes through mainstream retailers.

Martin still sees the full price labels as separate from the budget ranges. “We’re an impulse buy and people who walk into a petrol station or a newsagent are there



John Maxwell – making sure the buyers remain impulsive

to spend £2 on a packet of cigarettes or a magazine. People who are going to spend £10 or £12 on a piece of software go into a computer shop and want specialist advice, maybe needing a lot of coaxing to buy it. It’s premeditated purchase”.

The man who’s responsible for making sure the buyers remain impulsive is John Maxwell, who joined the company in July 1984 to oversee the development of products. When I describe some of the early programs as “less than inspiring” there is much laughter. “We haven’t had such flattery for a long time”, John says.

However, more seriously he adds: “Assessing a program is a very subjective thing. All the programs we published had something going for them. Some lacked graphics but had playability. Overall we have made our mistakes but if you consider the number we’ve published, which is something in the region of 150 titles, and look through our sales records

you’ll find very few have sold badly”.

The initial thrust was at the arcade gamers, though soon after the group moved into adventures. In the first year two million £1.99s passed across the counters of Britain. Martin says the graph of sales is a 45 degree upward slope! “This year I would expect us to sell well over six or seven million units which makes us one of the largest software producers in the world”.

The speedy initial growth caused a few problems in itself but, as Martin says: “Although the industry viewed us like lepers, the public viewed us like Robin Hood. They forgave us some of our mistakes and we very, very quickly built up a substantial operation”. The three directors left their previous companies and became full time board members.

“We had one advantage over most other software companies of the time. We had money behind us and we had researched the market. We didn’t do this as an ad hoc thing and knew what our contingency plans were. We had our own in-house duplication facility, our own distribution facility and our own warehouse within a few weeks. We weren’t beholden to anybody. And when Websters and the other major distributors came on stream, which they did after a few months, everything slotted into place”.

When the time came to enter the Amstrad market, Mastertronic already had some strong titles. Finders Keepers was the first of David Jones’s Magic Knight adventures with their brilliantly simple pull down menu control system. Chiller shot up the charts, helped by a little controversy and a speedy name change from Thriller when representatives of Michael Jackson made angry noises. John Maxwell is quite happy about this though. After all – no publicity is bad publicity!

Charting success

When it comes to the charts, Martin doesn’t think Mastertronic has always been fairly represented. “The problem is that we were always outselling most other games but the method of assessing the charts means we had to be in certain distribution points which we weren’t. So although we were outselling in terms of volume we weren’t appearing until we began to make an impact in Boots. We were probably always there, from eight weeks of launch”.

The constant appearance of Mastertronic titles riding high is all the more amazing because sampling comes primarily from computer shops, which do not provide its main outlets. And further

problems have occurred with MicroScope's chart, often taken as the industry standard, which has tried to exclude budget priced games. This low price ghetto has created problems of its own – the only titles that appear are Mastertronic. MicroScope is now requesting that the £2.99 games are listed under Mastertronic's Mad name to break the monotony.

Mad games were launched last October with a lavish Thames boat trip which nobody who was present will forget – and which cost slightly more than £1.99. The thinking behind the range was that it should be an outlet for more ambitious programs, not that there are difficulties maintaining the £1.99 price.

"We wanted a marketing experiment to see if we could put extra effort into programming", Martin says, "and we truly believe that our £2.99 games are the equal of any full price software. But to get that standard of programming takes an extra few months and extra capital investment and that can't be recouped at £1.99".

Programming success

Soon programmers were coming to Mastertronic, according to John Maxwell. "We had quite a lot of publicity because of the price breakthrough and quite a few programmers sent in work for assessment". There are distinct benefits for the person who comes to the company. "He joins a very successful and knowledgeable team, and generally is paid more profitably than some of the other software companies. The volume makes up for the amount of royalty and quite a few programmers have earned considerable sums from Mastertronic".

"One team of two programmers", adds Martin, "in one year earned more than £200,000. The correlation between volume and royalties is something that some programmers don't understand. We give them a vast volume for perhaps a lower royalty. We also give them far greater exposure. But more important, we back our programmers. We help them. We pay our royalties extremely promptly – often before we've been paid for the goods we've shipped".

Such loyalty is demonstrated by David Jones, who has remained with Mastertronic for his two subsequent Magic Knight adventures. "It's a very small industry. Programmers talk to each other and we guard our good name jealously.

"I don't think we've ever lost a programmer – maybe just one. They're happy with what we offer them – providing they're top class. We're looking all the time for better and better



Rad-Zone, the latest release

programmers. We still have an incredible appetite for games writers – we don't get enough".

Best sellers

Currently Finders Keepers and Nonteraqueous are selling well, but probably the best seller of all time for the company



Martin Alper – a one way ticket to the States

is Formula One Simulator, a program which has gained a new lease of life from its budget re-release after very lukewarm reactions to its initial full-price launch. "Ridiculed or not, the fact is that we've sold more than 400,000 copies", says Martin.

This isn't the only Mastertronic title to

receive a less than favourable critical reaction – Action Biker gathered some bad reviews too. But Mastertronic has ridden such criticism. Perhaps this can be explained by people taking a chance with a £1.99 game, which they wouldn't with a full priced product.

"And we have a very loyal following", Martin tells me. "We get sacks full of letters. They collect every game we publish. They can buy five games of ours for the price of a mainstream product. If one of those is bad or they don't like it they're still streets ahead".

There's still a problem of prejudice though. "Critics can be very unkind to us. There is still a little bit of snob in the software industry. We constantly ask to be judged not on our price or value for money but the quality of our software. It has to be good. That's John's criteria for publishing software, and that's how we're trying to be judged in the States too".

Across the pond

The move into the notoriously difficult US market was planned from the start. As early as 12 weeks after its launch, Mastertronic was exhibiting at the Chicago CES. "We'd made a dedicated decision to go for the American market as well. Now that takes a lot of bottle and a lot of capital investment. We're the only British company to sit it out.

"It's taken a lot longer in the States. They weren't just sitting there waiting for an English company to come and take the market apart. But I think that in just two years we've achieved the most remarkable results. And we're now being besieged by a flood of imitators. Everyone is trying to jump on the Mastertronic bandwagon out there.



It's a Mad world for Alison Beasley

Again we've established a very big lead. We are the kings of budget".

Alan again breaks away from his last minute Chicago planning. "It's a very different operation from doing full price software, which people don't realise". The average price of games in the States is \$35 - £24 for the same games they can buy here. We're selling there for \$9".

"American taste is totally different from ours. Our success is in the strict arcade format. They don't tend to go in for animated arcade adventures or anything too complex. They do like very cleverly programmed, skilful arcade games".

Martin's trip to the States will be a one way affair - he's going to take over the American side of the operation. "It's already being run effectively by remote control by the three of us here, but it does need one of us full-time over there to make the day to day decisions".

One problem he's preparing to face is scale. "Almost every phone call you make is long distance. If you say, 'I'll pop over to see you', even in a State the distances may be two or three hundred miles. That's considered near. Distribution is a severe headache and they won't take anything second rate".

The American operation provides a two-way trade and one reason for Martin's Californian base is to be nearer the centre of programming activity. "There is an enormous pool of very skilful programming talent in the States, but it's difficult to tap because of the distances and it's difficult for a UK software house to use it because talking about programs on the telephone, even using modems, isn't very effective. You need to discuss your ideas face to face".

While Americans might be slow to accept British software the same isn't true the other way around. "All software will sell over here. The British have an incredible appetite for software whereas the American market is very blinkered".

When it comes to British competitors for the budget crown Martin says, "It's a game strictly for professionals. Most of the other people who've tried it are restrained by the fact that they're trying

to run a full price software label as well. That's their big headache. There's always a conflict between which way you're going to go.

"Mastertronic won't be going in for more expensive software because it's not an idea we believe in. We consider full price software to be our price".

This also stops Amstrad disc-based

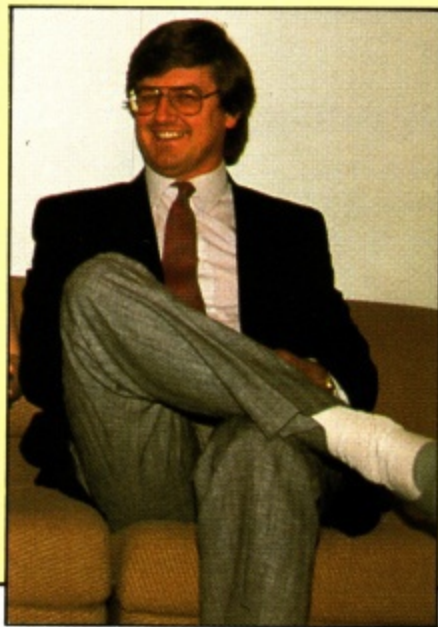

Alan Sharman - "American tastes are totally different from the British".

software appearing, at least in the near future, because of the cost of the discs themselves. It's a pity because the Ski Writer word processor is one of this year's Chicago triumphs.

Into the future

Looking ahead, the end of 1987 will see another major step forward for Mastertronic when it goes public, selling shares in the company. A few days earlier the third director, Frank Herman, had told me over the phone that they would be looking for capitalisation to develop new projects, which could include the use of laser discs as a storage medium.

Martin tells me that the company

watches all technological developments but only gets interested when it can produce them cheaper than anybody else. As John says, laser discs are the subject of much research, especially in Japan. "You can see the ultimate computer game of the future being like taking an active role in a film".

Another area the company will be prepared for is the 16-bit revolution. According to Martin all the best American programmers are working for these machines now and he adds: "We're already doing ST software. Whether it's going to be released in the UK remains to be seen". John reckons that "It's bound to happen eventually over here, probably in about 18 months. Somebody will develop a computer with the right marketing and the right quality at the right price". I'd bet that Alan Sugar is a prime contender for this role and Martin's question to me about the IBM-compatible would suggest that his mind is working along similar lines.

The Chicago CES products include Digital Integration's Speed King, English Software's Electra Glide and even Ocean's World Series Baseball, going by the name of Slugger and selling at \$9 compared with the \$30 prices of competing baseball games. Not surprisingly it has been a great success. Other companies are clearly finding it profitable to take advantage of Mastertronic's positioning in the US.

As the interview nears its end I'm treated to a preview of two new releases for the Amstrad by PR person, Alison Beasley. First up is Radzone, a very attractive collecting game in which you have to gather radioactive isotopes from a planet before they eat through your radiation suit. It's a strangely relevant topic, but Alison denies that the company masterminded Chernobyl as a publicity stunt!

The other program was in a very early state, but even this preview was enough to thrill. Storm is a version of the arcade cult, Gauntlet. What really sets it apart is that as well as providing a one player hunt through the mystical castle, there's also a two player mode, allowing for a more accurate recreation of the full size machine's cooperative gameplay. Amazingly it will sell for only £1.99.

Looking ahead Mastertronic aims, according to Martin, "to consolidate our position in the market and grow steadily upwards. We're not greedy. We just want to establish a principle that £1.99 and £2.99 are the definitive prices and any software of any standard can be produced within those points".

**THIS IS NOT JUST A MODEM,
BUT A COMPLETE SYSTEM, NOTHING ELSE TO BUY
'COMMUNICATOR'**

£153

PROHIBITED from direct or indirect sale to public communication systems. Action may be taken against anyone supplying the equipment.

Why pay extra for the features that the COMMUNICATOR offers as standard?
NOT A BITS and PIECES SYSTEM..... THIS IS A DEDICATED MODEM Compatible with the
464,664 and 6128

***** NOW WITH THE LATEST SOFTWARE *****

Software control of all options via the inbuilt SERIAL and PARALLEL interfaces Features include:

AUTO DIAL and AUTO ANSWER.
SOFTWARE included on SIDEWAYS ROM
Through connector for further expansion.
Contact BULLETIN BOARDS, PRESTEL, MICRONET 800 and BT GOLD ETC...
Prestel software includes the FULL 8 COLOUR DISPLAY,
DYNAMIC Frame handling and TELESOFTWARE DOWNLOADING.
Options accessible from BASIC using the Amstrad Bar Commands.
NO LESS than 50 Bar commands are available to the BASIC programmer.
Also selectable from the NUMERIC KEYPAD while ON LINE.
Twin seven segment LED to display digit being dialed and mode selected.
RX and TX indication within the LED display.
SOFTWARE SELECTABLE BAUD RATES... 300/300 (ans or orig), 1200/75,75/1200 full duplex, 600 and 1200 half duplex. BELL and EUROPEAN rates.
SPOOL ALL incoming data to... Tape, Disc or Printer.
X-ON and X-OFF selectable when SPOOLING to tape or Disc.
DOWNLOAD or UPLOAD files using the XMODEM protocol.
Wordprocessor FILES or PROGRAMMES can be Read from tape or disc and sent directly DOWN LINE.
RECEIVE or SEND complete blocks of code to/from anywhere in the computers memory.
RE-DIRECT ALL print - 8 listings to the modem and reset to CENTRONICS.
Selectable size BUFFER to store data using the TEXT EDIT facility, received data or LOADED from tape to disc.
Buffer contents can be SAVED to tape or disc, directed to PRINTER or TRANSFERRED down line.
SEND, PRINT or SAVE SCREENS. (ASCII characters).
AUTO CHANGE OVER from TX and RX selectable when in HALF DUPLEX.
Single bytes can be received or sent using the GET and PUT commands.
Selectable LINE FEED code can be sent to... SCREEN, PRINTER or DOWN LINE.
Local and Received data ECHO Facilities.
Local dimensions (in inches)... 1.5 High - 6.5 Wide - 9.5 Deep A 90 day unconditional warranty is included (subject to misuse).



* In terms of value for money it's EXCELLENT * Amstrad User Magazine.
AMSTRAD SET THE STANDARD FOR ALL IN ONE SYSTEMS
K.D.S. CONTINUE THAT WITH THE COMMUNICATOR
DON'T DELAY ... ORDER TODAY.
FREE Subscription to Microlink with every modem.

PARALLEL PORT £22

Twin 8 bit input/output ports, operates from Basic or M/C, TTL outputs, (uses Z80APIO).

RS232 SERIAL PORT £34

For connection to modems, printers, and other computers. Split baud rates, standard 25 way "D".

SIDEWAYS ROM BOARD £26

Now! new 5 way board. Takes 8 or 16K ROMs.

8 BIT PRINTER PORT £17

Send all character codes (i.e. 0 to 255) to your printer, uses standard print £8 etc. Unique design, no power input needed.

PRINTER "T" SWITCH £22 ** NEW **

Connect 2 printers to your Amstrad, software controllable changeover between printers i.e. invoices on one labels on the other with manual over-ride.

POWER CONTROLLER £40 ** NEW **

Featuring 8 switching relays handling a massive 5 amps AC or DC upto 240 volts AC. Control lights, fans, robots, etc etc. Plugs into the centronics port, uses BASIC OUT command.

***** NEW FOR THE PCW8256 *****

A version of our DEDICATED modem 104 now available for the PCW8256, see opposite.

RS232 AND CENTRONICS INTERFACE £53

SERIAL and CENTRONICS ports for the PCW8256. Connect to other printers, modems, computers.

15 HILL STREET, HUNSTANTON, NORFOLK PE36 5BS. TEL:(04853)2076 Please add VAT to all prices.

SIREN SOFTWARE

NEW ** MASTER DISC ** NEW

The only Disc Utility Package you will ever need. This disc does it all!

- IMAGE** - Back up your discs (including funny formats etc.)
- DIRECTORY EDITOR** - Unerase files, show hidden files, secure files etc.
- SPEEDFORM** - Lightning fast formatter.
- SECTOR EDITOR** - Complete sector editor.
- DE PROTECTOR** - DeProtect Basic programs.
- DISC HEADER** - Display start, length, execute addresses etc.
- TAPE HEADER** - As disc header but for tape.
- TRANS FILE** - Transfer individual files from disc to disc/disc to tape.
- DISC MAP** - Displays how files are stored on disc.
- TYPE FILE** - Displays on screen/printer any Ascii file.
- DUMP FILE** - Display in Hex/Ascii format the contents of a file.
- ZIP DISC** - Speed up your drive by upto 20%.

464/664/6128 DISC ONLY £12.99

WHAT THE REVIEWS HAVE SAID

- "The Master Disc utilities disc from Siren Software is a definite must for all disc owners" Amtix June '86
- "Some of the utilities are excellently done" Popular Computing Weekly
- "The package seems to work quite well on the full range of machines" Amtix, June '86
- "This Siren package really does offer you quite a lot for your money" Amstrad Action, June '86
- "Each section is fully documented with clear and precise instructions" Amtix, June '86

DISCOVERY - Tape to Disc Transfer

The only tape to disc transfer program to handle Turbo Loaders and alters Basic programs.
Adds relocaters, automatic and manual mode. Catalogue, full catalogue, erase, rename etc.
Tape header reader.
"Probably the best of the tape-to-disc copiers" Amstrad Action, March.
"Discovery does it best across the widest range of games" Amstrad Action, Feb. '86

464, 664, 6128 DISC £11.99 TAPE £7.99
- DISCUS 5 now available £2

This program will allow you to run more programs from disc than any similar program.

**** 464 OWNERS ****

Load in your software at upto 4 times the normal speed. Tape Utility V3.4 allows you to back up the majority of your software (about 90%) and load it back in 4 times faster. Extremely easy to use, no knowledge required.

CPC 464 only £6.99

For speedy delivery send your cheques/P.O.s etc. to:

SIREN SOFTWARE
76 Bridge Street, Manchester M3 2RJ. Tel: 061-796 6874 Please add £1.00 for overseas orders.



SIREN SOFTWARE

MICROPOWER

YORKSHIRE'S LEADING AMSTRAD SPECIALIST

COMPUTERS PCW 8256 Word Processing Package incl. computer, disc drive and printer. **£458.85**
 2nd Disc Drive **£182.85**
 Parallel/Serial Interface **£67.85**
 CPC 6128 with 128K memory, 3" drive and colour monitor **£399.00**
 With green screen monitor **£299.00**
 CPC 464 with 64K memory, built-in cassette and colour monitor **£299.00**
 With green screen monitor **£199.00**
 2nd Disc Drive (6128/664/464) **£99.95**
 1st Disc Drive (464) **£159.95**

PRINTERS Epson LX80, Amstrad DP 2000, Samleco DX86, Citizen 120D, Juki 6000, Juki 6100, NEC etc.

ACCESSORIES — Speech Synthesis, Light Pens, RS232, TV Modulators, AMX Mouse, Dust Covers, Leads, Printer Ribbons, Paper (ask for details).

SUPERPOWER New Rom-Card (6128/664/464) **£34.95**
 Assembler, Disassembler, Monitor (Disc or Roms) **£29.95**
 Disc Users Utilities, Programmer's Toolbox & Basic Extensions, Mailing List (Disc or Rom) each **£19.95** (please state computer model).

SOFTWARE — Sagesoft, Delta Database, Supercalc, Amsoft Business Control. Large selection of Games.

SHOWROOM/MAIL ORDER
MICRO POWER LTD.,
 Northwood House, North Street,
 Leeds LS7 2AA.
 Tel. 0532 458800/434006



ACCESS/VISA Welcome. Postage/carriage — small items 95p/total order; Computers/printers etc. £5.00 per item in UK. Eire/Channel Islands/Export at cost.

UNLOCK YOUR

AMSTRAD 464/664/6128

SNAPSHOT ● Tape backup utility for normal and headerless tapes

Powerful tape utility that will back up your tape based software, so simple to use it's child's play! On screen details of program length. Easy push-button selection for your choice of saving speed. The next best thing to a disc drive.
Tape £6.99

AMSHELP ● Transfer tape software to disc

Better than most, AMSHELP will even transfer ASCII files. Also automatically adds a relocater for those programs that overwrite the disc memory area.
FREE Disc utility load and list protected programs etc.
Tape £6.99 Disc £10.99

LOCKSMITH+ ● Disc utility collection

The most user friendly utility of its type, this disc includes the functions that our customers have asked for. The many options include: DISC TO DISC: Including Discs with 42 tracks! (YES 42!). DIRECTORY EDITOR: Allows easy alterations including UNERASING. FAST FORMATTING: Very fast and simple. DISC TRACK EDITOR: Allows editing of disc Display in HEX & ASCII. FILE DETAILS: Location & Length etc, for loading or TRANSFERRING to TAPE. DISC MAP: Displays where the files are. Display to SCREEN or PRINTER. DISC DRIVE SPEED-UP: DISC DEPROTECT: TAPE DEPROTECT: Easy Renaming, making INVISIBLE files VISIBLE, ETC, ETC. This utility will even show hidden programs and allow you to back up discs with bad or illegal tracks and sectors (unlike some imitations) all functions are easy to use, full on screen information.
Disc £10.99

Overseas orders please add £1 for postage.
 Personal Callers Welcome.



INTERLOCK SERVICES LTD
 123b Brent Street, London NW4
 Tel: 01-202 8727



DOUBLER

HAVING PROBLEMS BACKING UP THE LATEST LOADING TECHNIQUES? **DOUBLER+** Will solve ALL your problems

After enormous success on the CBM 64 and Spectrum we now have "Doublor" available for the CPC464. Designed by DRAYSOFT, inventors of the infamous "Interface III", this superb unit will operate with 100% success GUARANTEED. It requires the use of an auxiliary cassette deck.

Simply plug in the "Doublor" on the expansion port, connect a tape player to it with the lead supplied. LOAD the software supplied in the normal way and you are ready to start. Using digital techniques "Doublor" will create a brand new machine back up of ALL software. 100% success GUARANTEED.

As a bonus "Speedcop" is included in the package. This is a superb conventional back up copier that will handle all normal AMSTRAD loaders. It has all the usual options like choice of save speed deprotect basic etc.

Solve all your back up problems in one move, remember we guarantee success.

ONLY £16.95

Evesham Micros

THE UTILITY SPECIALISTS

3" DISCS
 Usually Available
 @ £39.00 for 10
 inc. P. & P.



TAPE TO DISC MADE SIMPLE

At last, a hardware "device" that will allow you to transfer those tediously slow loading cassettes to disc. "Disc Wizard" operates on the working memory of the computer, hence it is unaffected by the loading method used. It is brought into operation by the simple press of a button. A working version of the program in memory is then saved to disc and the program will restart. The saved version, when reloaded, will start from exactly the point that the button was pressed [very useful]. In most cases the process is then complete. With some programs it will be necessary to make one or two adjustments to the saved programs using a Simple routine supplied. However, this will also allow you to make certain custom alterations to the programs, e.g. screen size, windows, etc.

"Disc Wizard" is a hardware interface that fits the expansion or floppy disc port of the 464/664/6128. It is equipped with a through port and is supplied complete with simple instructions. At the time of going to press we have been unable to find even one, memory resident, program that the "Wizard" has been unable to handle.

ONLY £39.95

Please Note: This product is intended for archival purposes only. Programs transferred require the unit to be present for reloading. Software to enable saved versions to stand alone will be available in the future.

DISCMASTER V1.0

At last a POWERFUL disc backup and utility package for the 464/664/6128 series. Incorporates the following:

"DUPLICATOR" . . . A new standard of protected disc backup for the Amstrad. A very powerful program that will operate with one or two drives. We aren't saying that it will copy every disc available but our extensive tests have been unable to find one that it won't. We are sure that the DUPLICATOR is the best disc backup program available. Make no mistake many similar utilities are very limited. Future updates will be available as and when necessary at nominal cost.

"MENU MAKER" . . . A tremendously useful utility that allows you to make a menu on all your own discs completely automatically. You select which files are to be included on the finished menu and all the rest is done for you.

"RECOVER" . . . This program allows you to recover any files that may accidentally be erased from a disc. Very useful in case of accident.

"EXTENDED CATALOGUE" . . . Gives an extended CAT that includes the start address and length in bytes of both BASIC and machine code files.

ONLY £19.95

WARNING: Do not be misled by other adverts. There is only one "DUPLICATOR", it is the most powerful program of its type.

SUBJECT TO AVAILABILITY. ALL ORDERS DESPATCHED THE WORKING DAY AFTER RECEIPT

All prices include P&P and VAT. Send cheque, Postal Order or Credit Card No. Credit Card orders accepted by phone. Callers welcome. Wide range of goods stocked. Trade enquiries welcome. European orders send price as advertised. Outside Europe £2.00 for airmail. Mail order to Evesham please.

EVESHAM MICROS
 BRIDGE STREET, EVESHAM,
 WORCS. WR11 4RY.
 Tel: 0386 41989



MICRO CENTRE
 1756 PERSHORE ROAD,
 COTTERIDGE, BIRMINGHAM.
 Tel: 021-458 4564



In Australia contact: MICRO ACCESSORIES of S.A., 39b Anderson Walk, Smithfield, South Australia 5114. Tel: (08) 254 6284

Advantage

The Independent Computer User Group BUSINESS ADVANTAGE

Do you use or plan to buy an Amstrad computer for your business? Need advice on the hardware, the software, business applications or data communications? Then take advantage of our professional consultancy services. We will also consider writing special applications programs to fulfil your needs. No enquiry is too small or too big - write for details and competitive terms now!

THE COMPLEAT CP/M UTILITY SUITE

A comprehensive set of 21 utilities for all CPC and PCW computers. Includes a Full Screen Text Editor; 20 function File Manager (multiple erase, rename, hide, squeeze, unsqueeze, print etc); Disc Sector Editor; Unerase erased programs; Z80 Assembler, Reverse Assembler, Linker & Library; Keyboard Definer; File Scanner, Editor, Compare; String Search; Bad Sector Eliminator; Typewriter Emulator; plus improved versions of PIP, DDT, LOAD, SUBMIT, DIR, DUMP TYPE. On-disc documentation provided.
PCW & CPC Compatible DISC £11.95 (UK) £9.95 (Advantage Members) Overseas please add £1

LIGHT ENTERTAINMENT FOR PCW OWNERS

CP/M GAMES COMPENDIUM including the famous Colossal Cave Adventure with game save feature, Chess, Othello, Golf Simulator, Biorythm Calculator, Word-Search Puzzle Maker, Calendar Generator, Maze Designer & Banner Printers. On-disc documentation provided.
PCW & CPC Compatible DISC £9.95 (UK) £7.95 (Advantage Members) Overseas please add £1

"C" COMPILER FOR ONLY £13.95

Contains all the files and programs to help both the novice and experienced programmer write and compile C language programs. Includes * Powerful compiler * Full screen program editor * 25k of on-disc documentation * Worked examples * The complete source code for the compiler * Utilities * Game * User Support
PCW & CPC6128 Compatible Disc £13.95 (UK) £11.95 (Advantage Members) Overseas please add £1

17 CP/M PROGRAMS FOR £11.95

A collection of application programs and utilities including Inventory Manager/Database; Full Screen Text Editor, Word Count, Spelling Checker with Dictionary which can be easily edited, Alphabetical Sort; Library Utility for organising and cataloguing files, getting more data on disc using less space, simplifying directory (includes four programs); Password, File Scrambler, Unspooler for continuing work while printing; File Squeeze and Unsqueeze saving up to 40% disc space thus saving discs; Help Organiser plus improved Directory. All programs fully documented on-disc.
PCW and CPC Compatible DISC £11.95 (UK) £9.95 (Advantage Members) Overseas please add £1

NATIONAL & INTERNATIONAL USER GROUP

Advantage is the leading independent user group supporting the Amstrad range of computers. Membership includes monthly Newsletter, user-support, the opportunity to share views, programs and ideas, plus access to software at special prices. Fee is £8.95 per year (UK) or £13.95 (Overseas)

Advantage (DEPT U9) 33 MALYNS CLOSE CHINNOR OXFORDSHIRE OX9 4EW

CP/M packages contain some Public Domain Software which is supplied free of charge.

SOFTWARE MAINTENANCE: Purchasers of earlier versions can upgrade by returning original plus £1.95

NOTE: ALL PRICES INCLUDE POST PACKING AND VAT AT 15%

BrunWord

* including a 'Spelling Check' routine!

"I was interested to see how BrunWord stood up against Amword, Mini Office and the pricey Wordstar... easy to use, easy on the eye and easily my choice as the best all rounder on the market. (Computing with the Amstrad, March 1986)"

BrunWord 6128 or 464

BrunWord has now been extended to operate equally well in both 80 and 40 column modes and many new features have been added. The true format is always displayed in the 80 column mode but the display can be switched to 40 columns with the touch of a key, keeping the same cursor position and with paragraphs made longer so that text does not go sideways off the screen.

The right margin is justified using a complex process that adds spaces after punctuation and then between words alternating left and right towards the centre of the line. (Tasword always adds spaces right to left which makes the left side look cramped).

Insert/Overwrite, variable margins, right justify whole text or one paragraph, block save, move, copy, delete, word delete/undelete, search routines, word wrap. True display super/subscript numbers, col/line/page, word count, free memory. Embedded printer commands, multiple copies, page throw markers, odd and even page headers and footers, page numbers, sequence printing of files with correct paging. Help menus, RAM disc feature, security code. File size ten pages. Recognises CPC464 with Dktronics 64K or 256K memory.

BrunSpell 6128 or 464

This ultra fast spelling checker has a 22,000 word dictionary (expandable to over 30,000) and takes just 15 seconds to check a 450 word page. When a possible error is found "Help" will display the nearest words it can find, taking only a few seconds. NECESAY is near enough for NECESSARY. (Spelling checker takes 60 seconds on CPC464 with no memory expansion. Cassette version has 8,000 word dictionary expandable to about 12,000 and takes 15 sec).

Both programmes together:

Disc **£24.95**. Cassette **£17.95**
For CPC464, CPC664 or CPC6128
(state which machine)



Send Cheque/Postal Order To:

Brunning Software

34 Helston Road, Chelmsford, Essex, CM1 5JF.
Telephone: 0245 252854 (24 Hours)

THE TOP PEOPLES CHOICE



125
The
Explosive Joystick from Cheetah

- Compatible with ZX Spectrum, Commodore 64, Vic 20, Amstrad, Atari, MSX, etc.
- Four extremely sensitive fire buttons.
- Uniquely styled hand grip.
- Auto fire switch. • 12 months warranty.

Prices include VAT, postage & packing. Delivery normally 14 days. E-gift orders at no extra cost. Dealer enquiries welcome. Cheetah products available from branches of

Cheetah
Marketing



CHEETAH MARKETING LTD
1 WILLOWBROOK SCIENCE PARK,
CRICKHOLLOW ROAD, ST MELLONS, CARDIFF
TEL CARDIFF (0222) 777337 TELEX 497455

ONLY
£8.95

Kempston Data

Now available the Kempston Mouse system for the Amstrad CPC6128 at **£69.95** including VAT and P&P. The system consists of a dedicated interface and 2 button optically encoded Mouse.

The design protocol is compatible with major software releases including Fleet Street Editor from Mirrorsoft and Art Studio from Rainbird.

KEMPSTON DATA
10 OBERON COURT
SHAKESPEARE ROAD
BEDFORD MK40 2EB

Access/Visa orders Tel: 0234 327544
Telex: 82392 ROBINS G

SOFT INSIGHT (DISCOUNT SOFTWARE)

ALL PRICES INCLUDE FREE FAST DELIVERY IN THE U.K. ONLY. PLEASE ADD 70P PER TAPE ON EUROPEAN ORDERS AND £1.00 PER TAPE ELSEWHERE.

New titles arriving every day, please ring for details

Access orders/enquiries tel: 01-305 0521.

AMSTRAD CASSETTES	RRP	Our Price	RRP	Our Price	RRP	Our Price		
Price of Magik	9.95	7.46	Spin Dizzy	9.95	7.46	Battle of Britain	14.95	11.50
Heavy on the Magik	9.95	7.46	Commando	9.95	7.46	Scrabble	14.95	11.50
Movie	9.95	7.46	Fair Light	9.95	7.46	Theatre Europe	14.95	11.50
Batman	8.95	6.71	Rambo	9.95	7.46	Spy Vs Spy	14.95	11.50
Bomb Jack	8.95	6.71	Spy v Spy	9.95	7.46	Fighter Pilot	14.95	11.50
Tomahawk	9.95	7.46	3 Weeks in Paradise	9.95	7.46	Cyrus II Chess	13.95	11.50
Shadowfire	9.95	7.46	Battle of the Planets	9.95	7.46	3D Grand Prix	13.95	11.50
Sold a Million 2	9.95	7.46	Runestone	7.95	6.20	Raid	13.95	11.50
Hits 10 Volume 2	9.95	7.46	Back to the Future	9.95	7.46	Pyradev	29.95	22.95
Doomsday Blues	9.95	7.46	Critical Mass	8.95	6.71	6 Computer Hits		
Monty on the Run	9.95	7.46	Saboteur	8.95	6.71	Vol 2	14.95	11.50
Bouncer	8.95	6.71	Turbo Esprit	8.95	6.71	Strike Force		
Green Beret	8.95	6.71	Forbidden Planet	8.95	6.71	Harner	14.95	11.50
Moon Crestor	7.95	6.20	2112 AD	8.95	6.71	Green Beret	14.95	11.50
Meltdown	8.95	6.71	Spitfire 40	9.95	7.46	V	14.95	11.50
Colossal Adventure	9.95	7.20	Tau Ceti	9.95	7.46	Strangeloop +	14.95	11.50
Adventure Quest	9.95	7.20	Lazer Basic	14.95	11.95	Tank Commander	14.95	11.50
Dungeon Adventure	9.95	7.20	Lazer Compiler	19.95	15.95	Zoids	14.95	11.50
Snowball	9.95	7.20	Mini Office II	14.95	11.95	Heavy on the		
Lord of Time	9.95	7.20	Way of the Tiger	9.95	7.46	Magick	14.95	11.50
Return to Eden	9.95	7.20	Get Dexter	9.95	7.46	Equinox	14.95	11.50
Emerald Isle	6.95	5.40	Equinox	9.95	7.46	Single CF2DD 3" Disc		6.50
Red Moon	6.95	5.40	Max Headroom	9.95	7.46	Box of 10		60.00
Bridge Player (C.P.)	9.95	7.40	Nick Faldo's Golf	9.95	7.46	8256 SOFTWARE		
Fighter Pilot	9.95	7.46	Glass	8.95	6.71	Bridge Player	19.95	15.95
Combat Lynx	8.95	7.00	The 5th Axis	9.95	7.46	Fairlight	19.95	15.95
Scrabble	9.95	7.46	V	8.95	6.71	SuperCalc 2	49.95	44.95
Monopoly	9.95	7.46	DISC BASED SOFTWARE			DR Graph	49.95	44.95
3D Grand Prix	9.95	7.46	Monopoly	14.95	11.50	DR Draw	49.95	44.95
Cyrus Chess	9.95	7.46	Cleudo	14.95	11.50	Hitch Hikers Guide to the		
Zoids	8.95	6.71	Mini Office 2	19.95	15.95	Galaxy	24.95	22.95
Battle of Britain	9.95	7.46	Spin Dizzy	14.95	11.50	3D Clock Chess	19.95	15.95
Elite	14.95	11.21	Fairlight	14.95	11.50	C Compiler	49.95	44.95
Maarsport	9.95	7.46	Ping Pong	14.95	11.50	Pascal MT/+	49.95	44.95
They Sold a Million	9.95	7.46	Tau Ceti	14.95	11.50	Card Box	99.99	90.00
Cauldron	8.99	6.71	Get Dexter	14.95	11.50	Touch-N-Go	24.99	21.99
Nightshade	9.95	7.46	Doomsday Blues	14.95	11.50	SAGE SOFTWARE		
Who Dares Wins 2	9.95	7.46	Way of the Tiger	14.95	11.50	Popular Accounts	99.99	89.00
Worm in Paradise	9.95	7.46	Tomahawk	14.95	11.50	Popular Payroll	69.99	59.00
Theatre Europe	9.95	7.46	Bouncer	14.95	11.50	Popular Combo		
Cleudo	9.95	7.46	Batman	14.95	11.50	Pack	149.99	129.99
Lord of the Rings	15.95	12.00	Single CF2 3" Disc		4.50	Stock Control &		
Computer Hits 10	14.95	11.50	Box of 10		40.00	Invoicing	69.99	59.00
Comic Bakery	8.95	6.71	Masterfile	29.95	24.95	Popular Plus	149.99	129.99
Ping Pong	8.95	6.71	Mastercalc	29.95	24.95	Super Combo	199.99	170.00
Mike	8.95	6.71	Graphic Adv. C'tor	24.95	19.95	* DENOTES NEW TITLES THAT ARE AVAILABLE IN THE NEAR FUTURE. PLEASE RING FOR CONFIRMATION.		
The Music System	14.95	12.00	Sold a Million	14.95	11.50			
Winter Games	9.95	7.46	Computer Hits 6	14.95	11.50			
Contraption	8.95	6.71	Dun Darach	14.95	11.50			
Rescue from Fractalus	9.95	7.46	Marrsport	14.95	11.50			

WHY NOT COME AND PICK UP YOUR SOFTWARE PERSONALLY FROM OUR DISCOUNT SHOP AT: 3 STATION CRESCENT, WESTCOMBE PARK, BLACKHEATH, LONDON SE3 7ER. RIGHT OUTSIDE WESTCOMBE PARK RAILWAY STATION ON THE SOUTHERN REGION. OPEN ON SATURDAYS ONLY FROM 10.30 TIL 6.00PM.

3 STATION CRESCENT WESTCOMBE PARK BLACKHEATH SE3 7ER.

The UPGRADE

PCW 8256 to 512k RAM and 368k RAM DISC

Plug in 8 chips and change a link. Its easy!
The simplest, most comprehensive step-by-step instructions available assume no prior knowledge, experience, or skill.
We supply jig preformed chips - NO BENDING REQUIRED - plus a spare 'practice' chip to give you confidence.

Worried about your guarantee? Amstrads are very reliable but in the unlikely event of yours going wrong, you can always temporarily remove the 8 extra chips!

We are convinced that our Kit is the best available. You may find cheaper but you won't find better. However, IF YOU SEE A LOWER PRICE WE WILL MATCH IT providing it's sensible and the advertiser has stocks.

Our best selling Upgrade Kit is ONLY **£34.95**
UPGRADE TO FULL PCW 8512 SPECIFICATION

Genuine Amstrad 2nd Disc Drive ONLY £129

With Amstrad's fitting instructions plus our notes. Why pay a shop over £40 for a young lad to do a job that you can easily do yourself?

3" Discs

1-2 pieces **£3.95**, 3-9 pieces **£3.75**, 10+ **£3.45** inc.
5¼" DISKETTES DS/DD 96TPI. Box of 10 **£10.95**

EPROMs High quality HITACHI (or NEC)

NEC 2764C Plastic, once only programmable. 3+ pcs **£1.75** each

Hitachi 2764 1-2 pieces **£2.45**, 3+ pcs **£2.30**

Hitachi 27128 1-2 pieces **£3.45**, 3+ pcs **£3.25**

Prices INCLUDE VAT & FIRST CLASS POST
Normally by return. Discs subject to availability

Send UK cheques/Money Orders/LA or Gov't orders to:

SILICON CITY

Dept. C, Mithian, St. Agnes, Cornwall TR5 0QE.
Access/Visa orders: Telephone 087 255 2112

TYPESETTING AMSET

£199.98 + VAT

For the first time
a major suite of Typesetting software
is available to the Amstrad user.

PROFESSIONAL typesetting.

Package includes H & J, kerning, indents, multicolumn, depth count, character count, rules.

20 FOUNTS from 4½-72 point.

Digital setting on Linotron 202N.

QUALITY

Typeshare - The nation's biggest bureau service

TUTORIAL

comprehensive step by step tuition is included.

EXPANSION

- AMCOM Error free comms.
- AMCOUNT Counting Ad. Pack.
- AMAT Advanced Typography.

TRIAL OFFER

£40.00 +VAT for trial pack.

*Phone for brochure

Typeshare

Typeshare Ltd, Alan House, 55-59 Saffron Hill
Hatton Garden, London EC1N 8QX. 01-405 7937.

"THE VILLAGE"

HOUSE OF COMPUTERS
THE Amstrad Specialist in Kent

THE BIGGEST RANGE OF SOFTWARE AND PERIPHERALS FOR AMSTRADS IN KENT -
PCW 8256 - CPC 6128, 464, 664

PCW 8256
PCW 8512 AVAILABLE NOW

RS232/CENTRONICS INTERFACES NOW IN STOCK **£59 +VAT**
RAM UPGRADES FOR 8256 **£43.50 + VAT**
FD2 2ND DRIVES NOW AVAILABLE **£159.95 + VAT**
MODEMS, COMMS, SOFTWARE - Full Range **£59.95 to £239.95**

DBASE II now in stock £119.95

UNBEATABLE PRICES ON CAXTON SOFTWARE

CARDBOX ~~£99.95~~ **£79.95**
SCRATCH PAD PLUS ~~£69.95~~ **£59.95**
BRAINSTORM ~~£49.95~~ **£39.95**
SMARTKEY ~~£49.95~~ **£39.95**
TOUCH 'N' GO ~~£24.95~~ **£19.95**

PLUS EXTENSIVE RANGE OF OTHER TITLES

ALL ABOVE SOFTWARE ALSO RUNS ON 6128

CPC 6128, 464, 664

OVER 400 SOFTWARE TITLES (Games, Business, Education)
ALL THE NEW RELEASES

GRAFPAD II Now in stock (Tape or Disk)
AMX MOUSE - **£69.95**, additional software now in stock.
LIGHTPENS - ESP, Dk'tronics, Amstrad. Speech Synthesisers all makes.
DMP2000 - In stock and available
ROMs and ROM BOARDS - Amnor, Micropower, Beebug
DK'TRONICS RAM PACKS - full range in stock
MODEMS - Nightingale + Commstar Pack, Modem House, Thorn EMI etc
RS232C INTERFACES - Amstrad, Skycom, Skywave, Multiport
CONSUMABLES - 3" x 5¼" Blank discs, paper, ribbons, daisywheels, dust covers, storage boxes, etc, etc

All this plus knowledge and service that's second to none.
Mail Order welcome just ring for a quote

EVERYTHING FOR THE AMSTRAD FROM THE PEOPLE WHO KNOW
ACCESS & VISA WELCOME

Up to £1,000 instant credit (A.P.R. 31.3%) - Subject to status
87 Beckenham Lane, Shortlands,
Bromley, Kent BR2 0DN
Tel: 01-460 7122

Here's this month's helping of listing for you to type in. This is a flight combat game where you pilot a high powered fighter jet to intercept marauding enemy aircraft.

You see the pilot's view through the cockpit screen and you have controls to move left and right, up and down and fire missiles. There is only a certain amount of time before your fuel runs out and of course your supply of missiles is limited.

There is only one part to the listing, but it does contain some machine code so type in the whole program and save it before you try to run it.

We've altered the program to work with a joystick so if you want to put it back to its original state - using the keyboard - you'll need to change these numbers in lines 140-180. Sensibly, Kevin Freeman has used Inkey so it is easy to change from one to the other.

Change	To
72	69
73	71
74	46
75	38
76	47

Kevin writes - The majority of the program runs in Basic with an RSX to increase printing speed, in the form ISPRITE,x,y,p.X(0-39),y(0-24) referring to a position on the Mode 0 screen. p is a pointer to a memory position containing data for a sprite - the first two bytes being the x,y dimensions.

Note that this sprite handler does not plot over odd numbered pens giving the illusion of depth in the game. If the sprite is plotted at the same position twice then it will erase itself.

```

10 REM ..... INTERCEP
TOR .....
20 REM .....Mfi
tten by K.Freeman .....
30 REM .....all REM's
removable.....
40 GOSUB 1210:GOSUB 1310
50 LOCATE 8,20:PEN 3:PRINT"press SPACE t
o accept":WHILE INKEY(47)<>0:WEND
60 SYMBOL 42,124,198,198,199,199,198,124
70 SYMBOL 48,124,198,198,198,199,199,124
80 GOSUB 700:GOSUB 860:hi=200
90 fl=999:mn=25:ms=0:sc=0
100 XX=10:YX=10
110 GOSUB 790:GOSUB 660
120 REM .....contro
l.....
130 WHILE fl>0 AND mn>0
140 IF INKEY(72)=0 THEN yX=yX+1
150 IF INKEY(73)=0 THEN yX=yX-1
160 IF INKEY(75)=0 THEN xX=xX-2
170 IF INKEY(74)=0 THEN xX=xX+2
180 IF INKEY(76)=0 AND m=0 THEN m=1:SOUN
D 2,200,70,12,,,6
190 IF m>0 THEN GOSUB 500
200 GOSUB 580:GOSUB 760
210 IF fl=75 THEN INK 13,24,6:SOUND 4,50
0
    
```

INTERCEPTOR

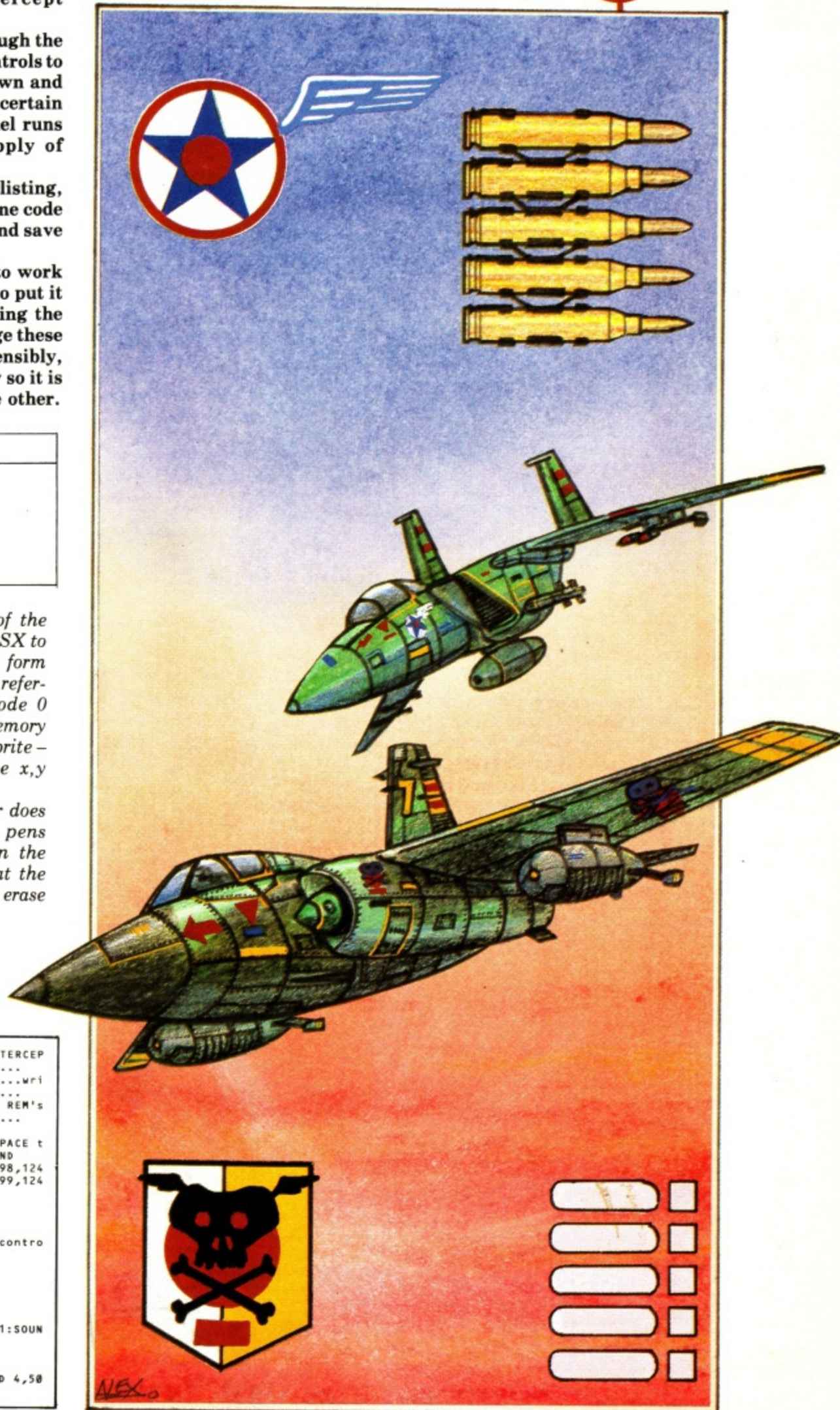



```

220 IF mn=5 AND ms=0 THEN INK 15,24,6:50
    UND 4,400:ms=1
230 IF hit=1 THEN GOSUB 330
240 IF SQ(1)=4 THEN SOUND 1,100,3000,4,,
    4
250 WEND
260 SOUND 129,0:SOUND 1,1000
270 WHILE INKEY$<>"":WEND:PEN 9:INK 9,8,
    12:LOCATE 7,2:PRINT"disengage"
280 FOR t=1 TO 900:NEXT:LOCATE 7,2:PRINT
    "p to play"
290 WHILE INKEY(27)<>0:WEND:GOSUB 660:IN
    K 13,5:INK 15,13:INK 9,15
300 LOCATE 7,2:PRINT"":GOTO 90
310 END
320 REM .....hit.....
.....
330 SOUND 2,400,100,10,,4
340 ISPRITE,17,10,ex:FOR t=1 TO 90:NEXT
350 ISPRITE,15,11,ex:ISPRITE,19,11,ex:IS
    PRITE,17,10,ex
360 ISPRITE,15,11,ex:ISPRITE,16,12,ex:IS
    PRITE,19,11,ex:ISPRITE,15,13,ex
370 FOR t=1 TO 100:NEXT:ISPRITE,16,10,ex
    :ISPRITE,18,14,ex:GOSUB 660
380 ISPRITE,16,12,ex:ISPRITE,15,13,ex
390 FOR t=1 TO 75:NEXT:ISPRITE,16,10,ex:
    ISPRITE,18,14,ex
400 ISPRITE,10,10,ex:ISPRITE,24,15,ex:IS
    PRITE,7,15,ex
410 FOR t=1 TO 75:NEXT
420 ISPRITE,5,10,ex:ISPRITE,10,10,ex:ISP
    RITE,35,15,ex:ISPRITE,24,15,ex
430 ISPRITE,5,10,ex:ISPRITE,7,15,ex
440 FOR t=1 TO 60:NEXT
450 ISPRITE,5,10,ex:ISPRITE,35,15,ex:ISP
    RITE,5,10,ex
460 sc=sc+(fl/25):GOSUB 810
470 xX=RDND*20+10:yX=RDND*10+2
480 FOR t=1 TO 50:NEXT:hit=0:GOSUB 660:R
    ETURN
490 REM .....missi
    le.....
500 IF m=1 THEN 530
    
```

```

510 ISPRITE,20,17-m,mpointer(m-1)
520 IF m=6 THEN m=0:mn=mn-1:PEN 15:PAPER
    1:LOCATE 7,24:PRINT USING "**";mn:G
    OTO 550
530 ISPRITE,20,16-m,mpointer(m)
540 m=m+1:RETURN
550 IF (yX>8 AND yX<11) AND (xX<20 AND x
    X>14) THEN hit=1:RETURN
560 RETURN
570 REM .....aircra
    ft.....
580 xX=xX+RDND-RDND:yX=yX+RDND-RDND
590 IF xX>20 THEN xX=xX+1 ELSE xX=xX-1
600 IF xX>30 THEN xX=30
610 IF xX<0 THEN xX=0
620 IF yX>20 THEN yX=20
630 IF yX<0 THEN yX=0
640 IF xX=x1 AND yX=y1 THEN RETURN
650 ISPRITE,x1,y1,air
660 ISPRITE,xX,yX,air
670 x1=xX:y1=yX
680 RETURN
690 REM .....set spr
    ite pointers.....
700 DIM mpointer(5)
710 RESTORE 720:FOR t=1 TO 5:READ d:mpoi
    nter(t)=d:NEXT:ex=&A1CA:air=&A076
720 DATA &A168,&A197,&A197,&A1bb,&A1c5
730 RESTORE 740:FOR t=0 TO 15:READ ik:IN
    K t,ik:NEXT:ORDER 0
740 DATA 1,0,18,23,11,4,6,8,9,15,20,2,19
    ,5,16,13
750 RETURN
760 fl=fl-1:PEN 13:PAPER 1
    
```

```

770 LOCATE 15,24:PRINT USING "**#";fl
780 RETURN
790 PEN 15:LOCATE 5,24:PRINT CHR$(239);"
    :25:"
800 PEN 13:LOCATE 13,24:PRINT CHR$(166);
    ":500"
810 PEN 7:LOCATE 9,3:PRINT USING "**#H";
    sc
820 IF sc>hi THEN hi=sc
830 PEN 5:LOCATE 9,1:PRINT USING "**#H";
    hi
840 RETURN
850 REM .....draw screen
    .....
860 MODE 0:DEG
870 ENT -7,20,1,1,20,-1,1:SOUND 1,200,99
    99,10,,7
880 FOR t=1 TO 90
890 PLOT 288=COS(t),112+250*SIN(t),1
900 PLOT 286=COS(t),110+250*SIN(t),3
910 PLOT 640+288=COS(180-t),112+250*SIN(
    t),1
920 PLOT 640+286=COS(180-t),110+250*SIN(
    t),3
930 NEXT
940 PEN 1:PAPER 0
950 a$=CHR$(143)+CHR$(143)+CHR$(143)+CHR
    $(215)
960 b$=CHR$(214)+CHR$(143)+CHR$(143)+CHR
    $(143)
970 FOR t=1 TO 4
980 LOCATE 1,18+t:PRINT RIGHT$(a$,t)
990 LOCATE 21-t,18+t:PRINT LEFT$(b$,t)
1000 NEXT
1010 b$=LEFT$(b$,2):c$=RIGHT$(a$,2):a$=L
    EFT$(a$,2)
1020 LOCATE 10,18:PRINT a$
1030 LOCATE 9,19:PRINT b$:c$
1040 LOCATE 9,20:PRINT a$:a$
1050 LOCATE 8,21:PRINT b$:a$:c$
1060 LOCATE 7,22:PRINT b$:a$:c$
1070 FOR t=1 TO 10:s$=s$a$:NEXT
1080 LOCATE 1,24:PAPER 8:PRINT p$:PAPER
    0
1090 FOR t=23 TO 25:LOCATE 1,t:PRINT s$:
    NEXT
1100 LOCATE 5,1:PRINT RIGHT$(ss,12):LOCA
    TE 6,2:PRINT RIGHT$(ss,10)
1110 LOCATE 9,3:PRINT RIGHT$(ss,4);
1120 LOCATE 1,1:PRINT CHR$(212):LOCATE 2
    0,1:PRINT CHR$(213)
1130 LOCATE 1,1:PRINT CHR$(22);CHR$(1):
    PAPER 1
    
```

```

1140 PEN 7:LOCATE 12,22:PRINT CHR$(232);
    CHR$(233)
1150 PEN 3:LOCATE 10,20:PRINT CHR$(230):
    LOCATE 10,21:PRINT CHR$(226);
1160 PEN 9:LOCATE 12,21:PRINT CHR$(190):
    LOCATE 8,22:PRINT CHR$(202);CHR$(20
    2);
1170 PRINT CHR$(22);CHR$(0);
1180 SOUND 129,0
1190 RETURN
1200 REM .....title pa
    ge.....
1210 MODE 1:PEN 2
1220 LOCATE 13,5:PEN 3:PRINT "INTERCEPTO
    R"
1230 LOCATE 1,8:PEN 2:PRINT"MISSION:"
1240 LOCATE 9,9:PEN 1:PRINT"Intercept an
    d destroy enemy"
1250 LOCATE 6,10:PRINT"fighter-bombers,a
    ttempting to"
1260 LOCATE 6,11:PRINT"penetrate air spa
    ce."
1270 LOCATE 6,14:PEN 2:PRINT"limited fue
    l & missiles"
1280 LOCATE 1,24:PEN 3:PRINT"control:";
    
```

```

1290 LOCATE 1,25:PEN 1:PRINT"A=up Z=dow
    n N=left M=right SPACE=fire";
1300 LOCATE 1,1:RETURN
1310 SYMBOL AFTER 256:MEMORY &9FFF:SYMB0
    L AFTER 32
1320 RESTORE 1440
1330 FOR t=&A000 TO &A075:READ d$
1340 d=VAL("&"d$)
1350 POKE t,d
1360 NEXT
1370 CALL &A000
1380 RESTORE 1510
1390 FOR T=&A076 TO &A20B:READ D:POKE T,
    D:NEXT
1400 RETURN
1410 REM .....sprite c
    ontroler.....
1420 REM .....double check be
    fore running.....
1430 REM .....save program
    first !!.....
1440 DATA 01,0E,A0,21,0A,A0,CD,D1,BC,C9,
    00,00,00,00,13,A0,C3,1A,A0
1450 DATA 53,50,52,49,54,C5,00,CD,19,8D,
    11,50,00,21,00,BF,DD,46,02
1460 DATA 04,19,10,FD,DD,7E,04,07,5F,16,
    00,19,DD,56,01,DD,5E,00,1A
1470 DATA 47,13,1A,4F,13,C5,E5,E5,05,11,
    75,A0,3E,00,12,7E,CB,7F,20
1480 DATA 05,F5,3E,AA,12,F1,CB,77,20,04,
    1A,F6,55,12,EB,D1,1A,A6,E1
1490 DATA AE,77,23,13,10,0B,E1,01,00,08,
    09,30,04,01,50,CB,09,C1,0D
1500 DATA 20,CA,C9,00
1510 REM .....aircraft
    sprite data .....
1520 DATA 16,15
1530 DATA 0,0,0,0,21,0,0,0,42,0,0,0,
    0,0
1540 DATA 0,0,0,0,21,0,0,0,42,0,0,0,
    0,0
1550 DATA 0,0,0,0,21,0,0,0,42,0,0,0,
    0,0
    
```

```

1560 DATA 0,0,0,0,21,0,0,0,42,0,0,0,
    0,0
1570 DATA 0,0,0,0,21,0,0,0,42,0,0,0,
    0,0
1580 DATA 0,0,0,0,21,0,0,0,42,0,0,0,
    0,0
1590 DATA 0,0,0,0,21,0,0,0,42,0,0,0,
    0,0
1600 DATA 0,0,0,0,21,0,17,10,0,42,0,0,
    0,0
1610 DATA 0,0,0,0,63,0,39,48,0,62,0,0,
    0,0
1620 DATA 0,0,0,0,21,60,43,24,33,23,60,4
    2,0,0,0,0
1630 DATA 0,0,0,3,62,57,61,3,3,62,54,61,
    3,0,0,0,0
1640 DATA 3,3,3,3,62,51,61,3,3,62,51,61,
    3,3,3,3
1650 DATA 0,0,0,0,62,57,61,51,51,62,54,6
    1,0,0,0,0
1660 DATA 0,0,0,0,21,60,42,0,0,21,60,42,
    0,0,0,0
1670 DATA 0,0,0,0,63,0,42,21,0,63,0,0,
    0,0
1680 REM .....missile
    sprite data .....
1690 DATA 3,15
1700 DATA 0,17,0,0,17,0,0,51,34,0,50,34,
    0,50,34,0,50,34,16,50,50,16,57
1710 DATA 56,0,60,42,20,60,40,21,61,61,0
    ,62,60,0,60,40,0,61,0,0,21,0
1720 DATA 2,10
1730 DATA 17,0,17,0,17,0,51,34,50,34,52,
    32,62,42,61,40,62,40,20,0
1740 DATA 2,6
1750 DATA 0,34,0,34,62,62,20,40,20,62,40
    ,40
1760 DATA 2,4
1770 DATA 20,40,62,62,61,61,21,40
1780 DATA 1,3,60,61,60
1790 REM .....explosi
    on data .....
1800 DATA 8,8
1810 DATA 0,20,20,0,0,0,0,21,0,36,40,0
    ,20,42,40
1820 DATA 0,0,1,20,0,0,40,23,61,0,0,60,6
    3,60,0,0
1830 DATA 0,40,20,61,22,40,20,42,0,0,6
    0,40,61,0,20
1840 DATA 20,21,0,62,0,40,0,0,0,40,0,2
    0,20,0,0
    
```

AMBYTE

Solves the Disc Dilemma!

Games on disc too expensive? Can't get the games you want?

Don't worry, AMBYTE has come up with a neat little scheme which will solve all of your problems - it's called custom compilation. You can have any of the games listed on this page put onto disc and yet you only pay the equivalent cassette price for each one. All we ask is that your order has two games on it which have a combined value of over £15.00. Once you have selected the two games you can order as many others as you please and we'll put them onto a disc(s), wrap them up with the cassette inlays and whisk them off to you.

AMBYTE offers you a fast and efficient service - as well as the chance to get more out of your software - quicker.

MASTERTRONIC

MA001 Finders Keepers	1.99
MA002 Chiller	1.99
MA003 Nonterraquous	1.99
MA004 Locomotion	1.99
MA005 Soul of a Robot	1.99
MA006 Formula One Simulator	1.99
MA007 One Man And His Droid	1.99
MA008 Caves of Doom	1.99
MA009 Into Oblivion	1.99
MA010 Spell Bound	2.99
MA011 The Last V8	2.99
MA012 Kane	1.99* NEW
MA013 Radzone	1.99* NEW
MA014 Five A Side Football	2.99* NEW

GREMLIN GRAPHICS

GR001 Thing On a Spring	8.95
GR002 Way of The Tiger	9.95
GR003 Super Sleuth	8.95*
GR004 Bounder	8.95 NEW
GR005 Monty on The Run	8.95* NEW

PSS

PS001 Theatre Europe	9.95
PS002 Battle For Midway	9.95
PS003 Battle of Britain	9.95
PS004 Swords and Sorcery	9.95

ELITE

EL001 Frank Bruno Boxing	8.95* NEW
EL002 Commando	9.95* NEW
EL003 Bomb Jack	8.95* NEW

US GOLD

US001 Beachhead 2	9.95*
US002 Impossible Mission	9.95*
US003 Winter Games	9.95
US004 Return to Oz	9.95*
US005 Bruce Lee	9.95
US006 Goonies	9.95*
US007 Zorro	9.95*
US008 Bunfight	9.95* NEW
US009 Dambusters	9.95* NEW
US010 Kung Fu	9.95* NEW
US011 Bounty Bob	9.95* NEW

PALACE

PA001 Cauldron	8.99
PA002 Cauldron II	8.99* NEW

FIREBIRD

FI001 Rasputin	7.95
FI002 Runestone	7.95*
FI004 Costa Capers	7.95
FI005 Chimera	7.95
FI006 Thunderbirds	3.95
FI007 Willow Pattern	3.95
FI008 Don't Panic	3.95
FI009 Subunk	1.99
FI010 Shorts Fuze	1.99
FI011 The Comet Game	7.95*

CCS

CC001 War Zone	6.95
CC002 Arnheim	9.95
CC003 Desert Rats	9.95

MIKRO-GEN

MK001 Battle of The Planets	9.95
MK002 Three Weeks in Paradise	9.95
MK003 Herberts Dummy Run	9.95

MARTECH

MT001 Zoids- The Battle Begins	8.95
MT002 Brian Jacks Superstar	8.95
MT003 Geoff Capes Strong Man	8.95
MT004 Samantha Fox Strip Poker	8.95

KUMA

KU001 Star Avenger	6.95
KU002 Galaxia	5.95
KU003 Rock Raid	6.95
KU004 Fruity Frank	6.95
KU005 Caverns of Mars	6.95
KU007 Argo Navis	6.95
KU008 Renegade	6.95

BRITANNIA SOFTWARE

BR001 Play Your Cards Right	7.95
-----------------------------	------

CRL

CR001 Endurance	7.95
CR002 Juggernaut	7.95
CR003 Formula 1	7.95
CR004 Blade Runner	8.95
CR005 Genesis	9.95*

DESIGN DESIGN

DD001 Tank Busters	7.95*
DD002 Dark Star	7.95*
DD003 On The Run	7.95*

ALLIGATA

AL001 Who Dares Wins 2	8.95
------------------------	------

MIRRORSOFT

MS001 Dynamite Dan	8.95
MS002 Boulderdash	9.95

ORDERING

Please remember that an order can only be accepted if it is for a minimum of two games which have a combined value of #15 pounds or more. You can order as many games as you like and the order can be made on plain paper so long as it includes the details requested below. Games marked with a * (splat) were not available when we put the catalogue together. Please phone (0277) 220573 and say that you are making an AMBYTE inquiry and give the title of the game you are interested in. You will be told if the game is available, and if not, advised when it might be.

Code Number	Title	Price

Total Order Value

Name _____

Customer Code (if you have one please use it, it saves time)

Address _____

Post Code _____

Cheques and postal orders should be made payable to AMBYTE. All orders should be posted to AMBYTE, 200 North Service Rd, Brentwood, Essex. CM14 4SG

MASTERFILE III

FOR THE AMSTRAD CPC 6128 (ALSO CPC 464/664 WITH DK TRONICS 64K RAM)

RATHER ENHANCED ...

We are pleased to announce the third major issue of MASTERFILE. This is no mere update, but a thoroughly enhanced and streamlined re-design of MASTERFILE 128, packed with new features, and a delight to use. We included some of the best ideas which our earlier MASTERFILE customers contributed. We sent prototypes out to our eager "test" users, and they kicked it as hard as they could, and came up with even more ideas. We spent several weeks further honing MASTERFILE III. Then we sat down and totally rewrote the manual.

SOMEWHAT POWERFUL ...

For the benefit of newcomers to the CPC machines, MASTERFILE III is a very powerful and flexible data filing and retrieval system. All "database" systems require that your data is organised into fields and records. But unlike most, MASTERFILE does not commit you to field lengths or formats, since ALL data is variable-length and optional. Files are not pre-formatted, and only used bytes are saved to disc. Also, unlike the rest, MASTERFILE allows multiple user-defined ways of viewing/printing your data. And unique in its price range, MASTERFILE offers RELATIONAL FILE options, whereby common data can be entered just once and shared by many records. Maximum field size is 240, maximum fields per record is over 50, and maximum file size is 64K. Room for 1,000 full names and addresses, for example. Only one disc drive is required. It is menu-driven throughout, and comes with detailed illustrated manual, and example files.

EVER SO FAST ...

Just about Any kind of information can be handled by MASTERFILE. You can Export the data to other systems (e.g. PROTEXT/MERGE and TASWORD). You can even merge your own USER BASIC to MASTERFILE for customised file processing. You can build new files from other sources — e.g. transfer data from Spectrum MASTERFILE. The speed of Search of MASTERFILE is second to none. We even get calls from customers who say that "The search did nothing"; they simply blinked and missed the revised status saying how many records had been found! Records can be sorted ascending/descending, character or signed numeric, even embedded keys such as surnames. We simply don't have room to list all the features; give us a call if you are still in doubt of the power of MASTERFILE III.

PLEASINGLY PRICED ...

How much does it cost? Just £39.95. Our test customers all say this is far too low — but then we didn't charge them this! However, we appreciate that many of you are "home" users who do not want to pay a "business" price. So we kept to a realistic figure. But don't be fooled by the low price. This is no toy written in Basic, nor is it a lumbering CP/M dinosaur. This is real machine-coded computing power. We have had IBM and Apricot users beg us for a MASTERFILE for their machines — when they had seen the earlier CPC MASTERFILE. They are going to be more frus-

Description	Maker	Model	Value
Microcomputer, 64K RAM + 32K ROM	Amstrad	CPC 464	£199.00
Microcomputer, 128K RAM + disc	Amstrad	CPC 6128	£299.00
Disc interface and 1st drive, 3"	Amstrad	DBI-1	£149.95
Dot-matrix printer 50cps 80col	Amstrad	DMP-2000	£159.95
Executive briefcase	Amstrad	ATO109	£42.00
Wire paper clip	Antler	BMC	£8.01
Answering machine	British Steel	BT2836	£185.00
Photocopier, single-feed	British Telecom	PC-10	£658.00
String ball of	Canon	POS-Exec	£8.40
Executive notebook	IBM	Cloud-Cuckoo	£5,200.00
Typewriter, electric	Lebar	Delerra 36	£130.00
Dictation machine	Olivetti	510	£190.00
Coffee maker	Philips	NDS349	£119.00
Parcel scale	Philips	25BP	£123.95
Microcomputer, 48K	Salter	Truspec	£10.00
Letter scale	Silicarn	375KL	
	Maymaster		£5,202,294.26
Totals:			

Top record = 0001 (H) for menu
 Records:0016 Selected:0016 Parents:0000 RAM used:02K from 64K
 File: FILE2

trated now. So are the PCW plodders. Alas, many of you pay a lot more, because you buy one database after another before you throw them all out for MASTERFILE. The trick is to ask around, read the reviews and choose MASTERFILE III first time. Try telephoning our competitors and ask to speak to the programmer for technical information. Then try us. We think you will spot the difference!

For those of you who already have an earlier MASTERFILE, we tempt you with some of the extras that "III" has:

Three Times faster disc load/save than MASTERFILE 128/II. Twice the screen speed. Total +/- values. Merge all/selected. Save all/selected. Disc file erase options. Implicit record numbering, both physical and selected. GOTO selected record number. Simpler but more powerful search. Full data name prompting. Print report width up to 160 columns. Page numbering. Insert records anywhere. Record Cursor for direct update within a display page. Smart new text editor. Format printing. Extended User Basic options. Compatible with all earlier CPC MASTERFILE files. Field-to-Field Calculations.

MASTERFILE III complete costs £39.95. We can provide an UPDATE onto your original MASTERFILE 464/128/II disc for £19.95 — inclusive of the new revised manual. If your original MASTERFILE 464 is on tape, we ask £22.95 for the exchange.

We also have one of the fastest and friendliest spread-sheet programs around, MASTERCALC 128. For this we ask £33.00. But as a SPECIAL OFFER to customers who buy MASTERFILE III complete and MASTERCALC 128 together, we offer the spread-sheet at £10 OFF, just £23. (£62.95 in total for both programs.)

All prices include VAT and P&P to anywhere in Europe. Outside Europe please add 20% for air-mail service. ACCESS/VISA/MASTERCARD welcome, written or telephoned. Please quote your card expiry date if ordering via credit card. If paying by cheque, make out to "Campbell Systems".

Our normal response is return of post, 1st class.

CAMPBELL SYSTEMS, 57 Trap's Hill, Loughton, Essex, IG10 1TD, England. Tel: 01-508 5058

SPACE MANIA

By Neil Kolban

Here is the final episode of Space Mania. Once it is all typed in and run together as explained in Part One you should have a super game.

Unfortunately in last month's issue we mangled some lines - line 1390 moved to the bottom of the first box. This does not matter because all the lines will sort themselves out once the listing is typed in.

Good luck and happy typing. Please note that Space Mania does not appear on any of the listing discs.

```

2840 DATA 8B3A349FA7C45095, 1000
2850 DATA CDB098CD8F93ED4B, 1340
2860 DATA 089FED43059F3A0A, 703
2870 DATA 9F32079FCD6C5530, 821
2880 DATA 30CD3793FEFF2005, 1001
2890 DATA CDA28B1824FE1E20, 882
2900 DATA 0B3A2A9FA7283618, 552
2910 DATA 18FD3600FEDD352A, 901
2920 DATA F5CDA556F1FE2728, 1275
2930 DATA 0E3E00110100CD64, 399
2940 DATA 93CD28EC3918A3A, 1224
2950 DATA 299FCB27F6013229, 780
2960 DATA 9FDD363464010606, 599
2970 DATA CD38BC18E4010000, 724
2980 DATA CD38BC3E05110100, 534
2990 DATA CD6493CD239EDD36, 1125
3000 DATA 0F01DD3610003A00, 373
3010 DATA 9FCD1F8E3A0F9FFE, 1023
3020 DATA 012024CD5A8F1600, 529
3030 DATA CDCD8D0C498DCD00, 1351
3040 DATA 98CD8F93CD28EED, 1425
3050 DATA 40089FED43059F3A, 768
3060 DATA 0A9F32079F18CF3E, 678
3070 DATA 03CDA192DD362828, 870
    
```

```

3080 DATA CD5A8FCD098CD8F, 1319
3090 DATA 933A0A9FED40089F, 853
3100 DATA CD2456CDC28EDD35, 1142
3110 DATA 2820E53E01C9E13E, 852
3120 DATA 00C9DDCB2946C0E1, 1153
3130 DATA 060AC5CDC28EC110, 963
3140 DATA F9CDCA933E02C93E, 1130
3150 DATA 13CDA1923E26320A, 691
3160 DATA 9F32079F060A0E00, 565
3170 DATA ED43059FED43089F, 939
3180 DATA CDA556ED40089F04, 939
3190 DATA 78FE462818ED4300, 823
3200 DATA 9F11059FCD088ECD, 1108
3210 DATA 8F93CDC28E2A089F, 1040
3220 DATA 22059FCD469418DB, 864
3230 DATA CD1E8ACD208A2A3F, 866
3240 DATA 9F2B223F9F7CB520, 803
3250 DATA 3ECD18CCD1395CD, 1146
3260 DATA 2D95CD498DCDD294, 1176
3270 DATA CD2B92CD08F93CD9D, 1251
3280 DATA 94ED40089FED4305, 936
3290 DATA 9F3A0A9FCD6C5530, 832
3300 DATA CDDDCB294620C7ED, 1208
3310 DATA 40089F3A0A9F5C5D, 871
    
```

```

3320 DATA A556C1CD649DC93E, 1169
3330 DATA 00110200CD64933E, 533
3340 DATA 03CDA192ED40089F, 994
3350 DATA 0478FE48301DE043, 831
3360 DATA 089FCD498DCDD294, 1149
3370 DATA CDBF93ED40089FED, 1211
3380 DATA 43059FCD2B92CDC2, 1024
3390 DATA 8E18D9DD362832ED, 985
3400 DATA 40089F3A0A9FCD24, 710
3410 DATA 56CD2B92DDE5CD46, 1205
3420 DATA 94DDE1CDC28EDD35, 1409
3430 DATA 2820E4CD18553E01, 677
3440 DATA C9CD24B8CB27CB27, 1113
3450 DATA E60C571E003E45CD, 695
3460 DATA 1EBB2802C0D23E47, 805
3470 DATA CD1EBB2802C0D23E, 909
3480 DATA 39110000CD2400CB, 705
3490 DATA 472004CB672802CB, 658
3500 DATA E2CB572802CBCACB, 1166
3510 DATA 5F2802C0C23E47CD, 872
3520 DATA 1EBB2802C0C3E3F, 789
    
```

```

3530 DATA CD1EBB2802C0C23E, 923
3540 DATA 15CD1EBB2802CBE2, 914
3550 DATA 18003E4FCD1EBB28, 627
3560 DATA 02C0C33E17CD1EBB, 907
3570 DATA 28243E3ECD1EBB28, 662
3580 DATA 02C0C33E3CCD1EBB, 952
3590 DATA 2802CBE03E43CD1E, 844
3600 DATA BB2802CBE33E26CD, 964
3610 DATA 1EBB2802C0F33E1B, 794
3620 DATA CD1EBB2802C0F33E, 940
3630 DATA 22CD1EBB2802C0DB, 920
3640 DATA 3E42CD1EBB2C489, 1077
3650 DATA C911059FCD088EC9, 1146
3660 DATA ED40089F7AE603FE, 1088
3670 DATA 032827CB4A280F78, 534
3680 DATA A7280053A0A9FEE, 688
3690 DATA 01F680320A9FCB42, 863
3700 DATA 281078FE4D300004, 570
3710 DATA 3A0A9FEE01E67F32, 873
3720 DATA 0A9FCB52800879FE, 877
3730 DATA 0338030D00DCB5A, 394
3740 DATA 280D79FEA230000C, 658
3750 DATA 0C0CDD341F1804DD, 577
3760 DATA 361F00ED43089F3A, 614
3770 DATA 0A9FCB7F20020404, 541
3780 DATA 79C6054FC5CD4255, 956
3790 DATA C17EA7C879C6044F, 1088
3800 DATA CD42557EA7C83A06, 913
    
```

```

3810 DATA 9F32099FC93A0F9F, 810
3820 DATA FE052827FE01200C, 637
3830 DATA 6BDA7AE6FCDD610, 1444
3840 DATA 57C3508DFE04200F, 808
3850 DATA DD35112804CBD218, 772
3860 DATA E9DD360F0118E1CB, 976
3870 DATA 6220DDDD361109DD, 673
3880 DATA 360F04DD721018E0, 672
3890 DATA A7CA508DFE022005, 883
3900 DATA CBCAC3508DFE0320, 1110
3910 DATA 05CBC2C3508DC93A, 1077
3920 DATA 0F9FF04C83A089F, 857
3930 DATA C05A92A7C0ED4000, 1120
3940 DATA 9F79C6124F04CD42, 850
3950 DATA 557EA72809FE3020, 761
3960 DATA 27DD360F00C92B7E, 699
3970 DATA A7201523237EA720, 615
3980 DATA 0F3A0F9FF0E1C8DD, 923
3990 DATA 360F01DD361000C9, 562
4000 DATA 3A0F9FF0E1C018D9, 920
4010 DATA FE702005DD360F02, 695
4020 DATA C9FEB02005DD360F, 958
4030 DATA 03C9FE602005DD36, 866
4040 DATA 0F05C9FEFC20D0DD, 1188
4050 DATA 360F00ED40089F04, 552
4060 DATA 78E6FC4779C6184F, 1095
    
```

```

4070 DATA C5CD4255C17EA720, 1071
4080 DATA 05DD00D18F21603, 335
4090 DATA 1E043600231D20FA, 434
4100 DATA 15C80CD5C5CD4255, 999
4110 DATA C1D118ECCD1B0B38, 1137
4120 DATA FBC9CD00B0ED5B59, 1276
4130 DATA 9FA7ED527DFE1438, 1100
4140 DATA F1CD00DD22599FC9, 1131
4150 DATA 2A009F7323722322, 545
4160 DATA 009FDD340EC921F2, 933
4170 DATA 8E068111FC8ECCD7, 1108
4180 DATA BCC9FEB100B20081, 1127
4190 DATA FC8E00303A0D9FCB, 875
4200 DATA 47C03A0E9FA7C8CD, 1066
4210 DATA 09B9F53A0D9FF601, 916
4220 DATA E6FD320D9FDD5D0D, 1376
4230 DATA 21009F2A009F2B56, 533
4240 DATA 2B5E22009F626B4E, 624
4250 DATA 2346237E23E5CDA5, 900
4260 DATA 56E14E2346237EFE, 909
4270 DATA FF2803CDA556DD35, 1028
4280 DATA 0E280C3A0D9FEE02, 536
    
```

```

4290 DATA 320D9FCB4F20CCDD, 961
4300 DATA CB0086DDE1F1CD0C, 1254
4310 DATA B9C9FD210024FD7E, 1087
4320 DATA 00FEFFC8FE042803, 1010
4330 DATA A7207CFD4E06F071, 1026
4340 DATA 03FD4607FD7004FD, 955
4350 DATA 7E08FD7705FD7E09, 899
4360 DATA A7281EFD35002015, 607
4370 DATA ED44FD770957FD7E, 1152
4380 DATA 0DFD770BF07E08EE, 1021
4390 DATA 80FD77087A81FD77, 1131
4400 DATA 06FD7E0AA7281EFD, 885
4410 DATA 350C2015ED44FD77, 795
4420 DATA 0A57FD7E0EFD770C, 874
4430 DATA FD7E08E08FD7708, 1133
4440 DATA 7A00FD7707FD7E00, 1008
4450 DATA FE042808FD7E08EE, 931
4460 DATA 01FD7708FDE5D113, 1091
4470 DATA 1A6F131A67E5FDE1, 992
4480 DATA 13CDD88EC35E8FFE, 1268
4490 DATA 012008FD7E08FD77, 800
4500 DATA 0518DCFD6E01FD66, 968
4510 DATA 02E5FDE1C35E8F21, 1174
4520 DATA 002D22479FCDD0E90, 672
4530 DATA 2A479F36FFC93A20, 872
4540 DATA 9FCB2721002F856F, 725
4550 DATA 7CCE00677E23666F, 807
4560 DATA 4E234623ED43089F, 689
    
```

4570 DATA ED43059F7E23320A, 689
 4580 DATA 9F32079FFD210024, 697
 4590 DATA 7E23FD7700FEFFC8, 1242
 4600 DATA FE07D2F390FE0428, 1156
 4610 DATA 03A720484EFD7103, 721
 4620 DATA FD71062346FD7004, 846
 4630 DATA FD7007237EFD7705, 910
 4640 DATA FD7708237EFD7709, 922
 4650 DATA 237EFD770A237EFD, 957
 4660 DATA 770BFD770D237EFD, 929
 4670 DATA 770CFD770E237EFD, 1034
 4680 DATA D17BC60F5F7ACE00, 968
 4690 DATA 57FD7301FD7202D5, 1038
 4700 DATA FDE118A4FE01202B, 996
 4710 DATA FDE5D17BC6095F7A, 1238
 4720 DATA CE00574E2346237E, 637
 4730 DATA 23FD7103FD7106FD, 1029
 4740 DATA 7004FD7007FD7705, 865
 4750 DATA FD7708FD7301FD72, 1116
 4760 DATA 0218CCFE043029FE, 831
 4770 DATA 022003D0342AFDE5, 834
 4780 DATA D17BC6065F7ACE00, 959
 4790 DATA 57FD7301FD72024E, 903
 4800 DATA 23FD71034623FD70, 874
 4810 DATA 047E23FD7705189F, 725
 4820 DATA C33890FDE5FD2A47, 1243
 4830 DATA 9FFD7700FE08283C, 893
 4840 DATA FE0720564E23FD71, 858
 4850 DATA 034623FD70047E23, 638
 4860 DATA FD77057E23FD7706, 916

4870 DATA FD77077E23FD7708, 920
 4880 DATA 7E23FD7709FDE5D1, 1233
 4890 DATA 3E0A835F7ACE0057, 713
 4900 DATA FD7301FD7202ED53, 1058
 4910 DATA 479F181E4E23FD71, 763
 4920 DATA 034623FD70047E23, 638
 4930 DATA FD77057E23FD7706, 916
 4940 DATA 7E23FD7707FD7708, 920
 4950 DATA 18C6FDE1C3389021, 1128
 4960 DATA 00247EFEFFC8235E, 1000
 4970 DATA 235623D54E234623, 587
 4980 DATA 7ECDA556E118EBCD, 1271
 4990 DATA 14BC3A209F3C11B4, 714
 5000 DATA 00214C2F193D20FC, 526
 5010 DATA 0E0006005623E57A, 492
 5020 DATA CB3FCB3FCB3FCB3F, 1064
 5030 DATA A72809C603D5C5CD, 1032
 5040 DATA A556C1D178C60447, 1046
 5050 DATA 7AE60F2807C603C5, 812
 5060 DATA CDA556C1E178C604, 1196
 5070 DATA 47FE5020CF79C609, 972
 5080 DATA 4FFE238C5C93E00, 1011
 5090 DATA CD59BCCD99983E00, 1054
 5100 DATA CDA192CD22933E01, 961
 5110 DATA CDA192CD0593D0CB, 1293
 5120 DATA 2C4628053E08CDA1, 595
 5130 DATA 92DDCB2946C83E06, 949
 5140 DATA CDA192C911005006, 816
 5150 DATA 40CD0055FEA230F9, 1067
 5160 DATA 1213CD0055E67F3C, 744
 5170 DATA FE5030F6121310E9, 914
 5180 DATA DD364A402100504E, 604
 5190 DATA 234623E5CD42553E, 787

5200 DATA 50AE77E1DD354A20, 978
 5210 DATA EE189B210050DD36, 805
 5220 DATA 4A404E2346E5C5CD, 952
 5230 DATA 42553E50AE77C105, 784
 5240 DATA 200A064F3E4F856F, 512
 5250 DATA 7CCE00672B3E50AE, 792
 5260 DATA 77E17023DD354A20, 871
 5270 DATA D9C9FE513803D651, 1107
 5280 DATA C8D609C8D818FA11, 1130
 5290 DATA DA00210002CDABBB, 944

5300 DATA 3EDA210080F5E5CD, 1120
 5310 DATA A8BBE1F13CC81100, 1106
 5320 DATA 001918F1FE30DA5A, 900
 5330 DATA BBFE3A3005C6C4C3, 1141
 5340 DATA 5A8BFE41DA5A8BFE, 1345
 5350 DATA 5BD25A8BC699C35A, 1214
 5360 DATA BBCB27218D58856F, 935
 5370 DATA 7CCE00677E23666F, 807
 5380 DATA 7E23A7C8FE7F2809, 958
 5390 DATA FE7E2842CD849218, 993
 5400 DATA EF5CD938BCDDEBB, 1621
 5410 DATA CD78BB16007C3DCB, 922
 5420 DATA 27CB27CB27CB27CB, 968
 5430 DATA 12CB27CB125F2600, 614
 5440 DATA 3E1A95CB27CB27CB, 924
 5450 DATA 27CB27CB146FCDC0, 1012
 5460 DATA BB3E01CD63BB3E01, 804
 5470 DATA CD59BCE118B23E00, 971
 5480 DATA CD63BB18A806410E, 771
 5490 DATA B43A009FE6035F7B, 848
 5500 DATA A7C81DC5D53E00CD, 1073
 5510 DATA A556D1C178C60547, 1047
 5520 DATA 18ED211607CD75BB, 832
 5530 DATA 211A9F06047EC630, 600
 5540 DATA CD84922310F7C9FD, 1235
 5550 DATA 210024FD7E00FEFF, 957
 5560 DATA C8FE02280BFD6E01, 871
 5570 DATA FD6602E5FDE118EB, 1323
 5580 DATA FD4E03FD4604FD7E, 1040
 5590 DATA 05C5CDF155C130E5, 1203
 5600 DATA FD7E05C9211D9F86, 940
 5610 DATA FE0A3805D060A2B34, 644
 5620 DATA 23772B78B6FE0A38, 774
 5630 DATA 05D60A2B3423772B, 521
 5640 DATA 7A86FE0A3805D060, 805
 5650 DATA 2B342377C32293CD, 830
 5660 DATA 46943A0E9FA7C818, 840
 5670 DATA F6D53E04CDA192CD, 1242
 5680 DATA 4694CDC18CCB4BC4, 1230
 5690 DATA B593CB5B28F13E05, 970
 5700 DATA CDA192D1C9D53A29, 1234
 5710 DATA 9FEE0132299FCB47, 922
 5720 DATA 3E0620013CCDA192, 673
 5730 DATA D1C9CD0055D0365F, 1070
 5740 DATA C80100C01180FFDD, 1014
 5750 DATA 365E50673A5F9F2E, 689
 5760 DATA 01FE6538012D7C20, 627
 5770 DATA 2C28020AAC022D2C, 359
 5780 DATA 28021AAC120313DD, 501

5790 DATA 355E20EB7CF5D5C5, 1193
 5800 DATA CD4694CD3A94C1D1, 1236
 5810 DATA F1DD355FC8F521B0, 1264
 5820 DATA 07097CF6C0474D062, 824
 5830 DATA 6B115008A7ED527C, 822
 5840 DATA F6C0575D3A5F9FE6, 1160
 5850 DATA 07200C2150000944, 241
 5860 DATA 4D2100FF19545Df1, 984
 5870 DATA 189D051100091D20, 481
 5880 DATA FD1520FAD1C9DDCB, 1390
 5890 DATA 2C46CDD0E5CD6185, 1191
 5900 DATA DDE1C9DDCB2C46C8, 1385
 5910 DATA DDCB2C86D5DDE5CD, 1470
 5920 DATA 0085D0E13E09CDA1, 1016
 5930 DATA 92D1C9DDCB2C46C8, 1286
 5940 DATA DDCB2CC6D5CDA7BC, 1439
 5950 DATA 3E08CDA192D1C911, 1009
 5960 DATA 06002100247EFEFF, 710
 5970 DATA 2807FEFE28001918, 655
 5980 DATA F4E5FDE1FD3606FF, 1519
 5990 DATA C9E5FDE1C9DD3520, 1428
 6000 DATA C0DD362D06CDD0055, 808
 6010 DATA 47ED5FA8FE9A30F5, 1272
 6020 DATA 4F064BCD7F94FD71, 1006
 6030 DATA 00FD7103FD7001FD, 988
 6040 DATA 7004CD0055E601C6, 835
 6050 DATA 24FD7702FD7705C3, 982
 6060 DATA A556FD210024FD7E, 952

6070 DATA 00FEFFC8FEFE282C, 1301
 6080 DATA FD4E03FD7100FD7E, 1079
 6090 DATA 04FD77013D3D3DFE, 814
 6100 DATA FD280FAFEA200CFD, 1104
 6110 DATA 3600FE180FFD3605, 659
 6120 DATA FF1800FD7704FDE5, 1137
 6130 DATA D1CDD88E110600FD, 1048
 6140 DATA 1918C3CB43C29E8B, 1005
 6150 DATA CB53C49993CB4BC4, 1256
 6160 DATA B593CB63C46B94CB, 1284

6170 DATA 6BC45394C92A539F, 1019
 6180 DATA ED40089F79BD3800, 853
 6190 DATA CB522804D0D0D0D0, 381
 6200 DATA BC3008CB5A28040C, 593
 6210 DATA 0C0C0CED43089FC9, 708
 6220 DATA DD3534280D3A349F, 648
 6230 DATA FE14C0010006CD38, 745
 6240 DATA BCC901000BC38BC, 861
 6250 DATA 3A299FCB3F32299F, 774
 6260 DATA C9060021F857E57E, 938
 6270 DATA 23666F111A9F0E04, 468
 6280 DATA 1ABE2808300BE123, 583
 6290 DATA 2310EBC923130D20, 586
 6300 DATA EFD5C5CD4694C1D1, 1474
 6310 DATA E122419F05DD7044, 889
 6320 DATA 281E2106585E2356, 412
 6330 DATA D521055878CB274F, 780
 6340 DATA 0600545D1313EDB8, 642
 6350 DATA 2A419F23D1722B73, 782
 6360 DATA 2A419F5E2356211A, 540
 6370 DATA 9F01040ED0B0CD02, 992
 6380 DATA 95C9D5CDB8CECD14, 1323
 6390 DATA BC3E00CD96BB3E0C, 866

6400 DATA CDA1922178583E07, 822
 6410 DATA DD964447CB278085, 1013
 6420 DATA 6F7CCE006706037E, 679
 6430 DATA 23CD849210F93E22, 879
 6440 DATA 260216112E111E17, 195
 6450 DATA CD44BC3E30260416, 635
 6460 DATA 0F2E131E15CD44BC, 592
 6470 DATA 3E00CDA1923E00CD, 854
 6480 DATA 90BBE1060AE5C5CD, 1203
 6490 DATA 4694C1E1CD090B38, 1093
 6500 DATA 173E20DDCB456E28, 760
 6510 DATA 023E3FC05ABB3E08, 679
 6520 DATA CD5ABDD0344518DD, 1069
 6530 DATA FE7F201578FE0A28, 858
 6540 DATA D43E10CD5ABB3E08, 845
 6550 DATA E5CDA192E1042B18, 1037
 6560 DATA C4FE0D200678A7C8, 988
 6570 DATA 360DC9FE2038064F, 871
 6580 DATA 78A728B179FE6138, 1032
 6590 DATA 06FE7B3002D62077, 798
 6600 DATA CD84922305189EC9, 906
 6610 DATA 117800218E013E0F, 390
 6620 DATA C3D3973E00010000, 620
 6630 DATA C5F5CD32BCFC1C13C, 1379
 6640 DATA FE1020F4C9CD14BC, 1160
 6650 DATA 010000CD38BCCD93, 802
 6660 DATA 96CD8896AFCD96BB, 1358
 6670 DATA 3E05CD90BB210620, 644
 6680 DATA E5CD75BB060821F8, 1833
 6690 DATA 575E2356230E041A, 381
 6700 DATA 13C630CD84920D20, 793
 6710 DATA F63E30CD84923E20, 933
 6720 DATA CD5ABDD05ABB0E0A, 988
 6730 DATA 1A13FE0D2806CD04, 695
 6740 DATA 920D20F4545DE12C, 881
 6750 DATA 2CE5CD75BB0626B10, 1003
 6760 DATA C8E13E10CDA19221, 1048
 6770 DATA 9001223F9FD03620, 708
 6780 DATA 32DD364601CDDFF8F, 999
 6790 DATA CD5F913A0A9FED4B, 984
 6800 DATA 089FCDA556CDBCE, 1158
 6810 DATA CD1855010000CD38, 576

LISTINGS

6820 DATA BCCD359ECD09BBD, 1225
 6830 DATA 8999D8CD19BDCD5A, 1220
 6840 DATA 8F3A099FDD8646FE, 1048
 6850 DATA 4B20123A469FED44, 717
 6860 DATA 32469F3A0A9FEE80, 872
 6870 DATA 320A9F1807FE0528, 549
 6880 DATA EA32099F11059FCD, 838
 6890 DATA D88ECD8F933A0A9F, 1080
 6900 DATA 32079FEE01320A9F, 674
 6910 DATA ED4B089FED43059F, 947
 6920 DATA 2A3F9F2B223F9F7C, 687
 6930 DATA B520A9C33E982180, 952
 6940 DATA 2F11812F36000132, 345
 6950 DATA 00ED00C9D034493A, 1018
 6960 DATA 538957CD0055E61F, 858
 6970 DATA BA38039218FA0E02, 681
 6980 DATA 5F21802F856F7CCE, 877
 6990 DATA 00677EA728111C23, 516
 7000 DATA 7BBA38F621802F1E, 849
 7010 DATA 000D20EE3E63C936, 699
 7020 DATA 017BC9323F9FD5E5, 1039
 7030 DATA 3E00CD59BCE1D13E, 1040
 7040 DATA 01CD63BB0608D5E5, 948
 7050 DATA CDC0BB78FE012002, 993
 7060 DATA 3E06CDEBB3A3F9F, 962
 7070 DATA CDA192C5CD4694C1, 1325
 7080 DATA E1D11B1B1B1B2B2B, 628
 7090 DATA 10DC3E00CD63B0C9, 990
 7100 DATA E5CD4694E12D20F8, 1202
 7110 DATA 2520F5C9CDCA93CD, 1274
 7120 DATA 14BC117800212C01, 423
 7130 DATA 3E0FCDD397117800, 781
 7140 DATA 2196003E0FCDD397, 827
 7150 DATA 210005C31098CD07, 613
 7160 DATA 8ACD1E8A3E003220, 655
 7170 DATA 9FCD1C98CD7791CD, 1218
 7180 DATA 99983E1111E0021, 664
 7190 DATA 3200CD0397CDF8F8, 1220
 7200 DATA CD5F91ED4B089F3A, 982
 7210 DATA 0A9FCDA55621A000, 818
 7220 DATA 223F9FCD09BBD8CD, 1078
 7230 DATA 19BDCD5A8FCDB098, 1185
 7240 DATA CD8F932A3F9F2B7C, 926
 7250 DATA B520E53A5389673A, 881
 7260 DATA 209F3C8C20B0C3A5, 1007
 7270 DATA 963E04CDD0EBB214A, 937
 7280 DATA 00110000CD0BB21, 634
 7290 DATA 0000117C02C3F9BB, 774

7300 DATA FD21002DFD7E00FE, 964
 7310 DATA FFC8FE082839FE07, 1075
 7320 DATA 207CFD4E03F04604, 817
 7330 DATA CD4255FD4608FD4E, 1018
 7340 DATA 0579AE772310FAFD, 973
 7350 DATA 35062010FD7E07FD, 746
 7360 DATA 7706FD7E09ED44FD, 1071
 7370 DATA 77091852FD7E03FD, 869
 7380 DATA 8609FD77031847FD, 866
 7390 DATA 4E03FD4604CD4255, 764
 7400 DATA FD4609FD4E0579AE, 963
 7410 DATA 77CC60867FE8030, 982
 7420 DATA 0BF6C0677DC6506F, 1066
 7430 DATA 7CCE006710E8FD35, 987
 7440 DATA 072010FD7E08FD77, 814
 7450 DATA 07FD7E06ED44FD77, 1069
 7460 DATA 06180BFD7E04FD86, 811
 7470 DATA 06FD77041800FD5E, 753
 7480 DATA 01FD5602D5FDE1C3, 1228
 7490 DATA B498CD8E97CDB8CE, 1365
 7500 DATA 3E2ACD5ABB0D6999, 1049
 7510 DATA 215389BE30EC3220, 809
 7520 DATA 9FDD5CD0085DDE1, 1393
 7530 DATA C9CD7A99CB274FCB, 1205
 7540 DATA 27CB27814FCD7A99, 969
 7550 DATA 81C9CD06B0CD5ABB, 1210
 7560 DATA D63038F6FE0A30F2, 1118
 7570 DATA C9F53E42CD1EBBC2, 1190
 7580 DATA C489F1C9CD14BC06, 1194

7590 DATA 0A0E64ED43089FED, 832
 7600 DATA 43059F3E42320A9F, 578
 7610 DATA 32079FCD4A556060F, 693
 7620 DATA 0E64ED434E9FED43, 959
 7630 DATA 409F3E4332509F32, 702
 7640 DATA 409F3E4332509F32, 702
 7650 DATA 02DD36520121038F, 539
 7660 DATA 22539FC93E14CDA1, 925
 7670 DATA 923E4206280E96CD, 689
 7680 DATA A5560664C5C0C28E, 1095
 7690 DATA CD4694C110F6CD94, 1231
 7700 DATA 99CD691CD799ACD, 1386
 7710 DATA A18CCD1395CD2095, 1073
 7720 DATA 3A089F21059FBE28, 652
 7730 DATA 0611059FCD088ECD, 955
 7740 DATA 379A114B9FCDD88E, 1023
 7750 DATA CD8F93CD9E9AFAFF, 1521
 7760 DATA C8CDE29AED40B09F, 1264
 7770 DATA ED43059FED4B4E9F, 1017
 7780 DATA ED434B9FC3F799ED, 1370
 7790 DATA 4B4E9F3A519F814F, 818
 7800 DATA FEB330093A519FFE, 866
 7810 DATA 80300D1810FE9838, 691
 7820 DATA 0C3A519FE803005, 745
 7830 DATA ED4432519F3A529F, 894
 7840 DATA 8047FE023006DD36, 784
 7850 DATA 52011808FE4A3804, 503
 7860 DATA DD3652FFED434E9F, 1153
 7870 DATA C9DD365500064016, 653
 7880 DATA 031E0A0E00DD3455, 415
 7890 DATA 3E44D5C5CDA556C1, 1189
 7900 DATA D179C6104F1D20ED, 921
 7910 DATA 04041520E4C9ED4B, 802

7920 DATA 4E9F78FE32D8C603, 1078
 7930 DATA 4779C6044FC5CD42, 941
 7940 DATA 55C17EA7C83A529F, 1070
 7950 DATA ED4432529FCB0879, 1048
 7960 DATA E6F04F3E44CDA556, 1135
 7970 DATA DD3555280A3E0111, 489
 7980 DATA 0000CD6493AFC93E, 890
 7990 DATA 00110001CD64933E, 532
 8000 DATA FFC9ED4B4E9F78FE, 1379
 8010 DATA 022837FE0D2803FE, 661
 8020 DATA 0EC03A089F91C610, 790
 8030 DATA FE00D8FE19D01E00, 987
 8040 DATA FE0530041E021812, 385
 8050 DATA FE0A30041E01180A, 381
 8060 DATA FE0F30041EFF1802, 632
 8070 DATA 1EFEDD7351DD3652, 1058
 8080 DATA 01C9E1C921569F36, 960
 8090 DATA 01233603233600CD, 387
 8100 DATA 3D9BCD00DD112C01, 685
 8110 DATA 1922509FC9211803, 570
 8120 DATA CD75BB21569F3E30, 897
 8130 DATA 8623CD84923E3ACD, 977
 8140 DATA 5ABB3E308623CD84, 893
 8150 DATA 923E3086CD84923E, 935
 8160 DATA FFC9CD00BDE05B5B, 1282
 8170 DATA 9FA73EFFFED52D0CD, 1383
 8180 DATA 0DBD112C0119225B, 414
 8190 DATA 9F21589F35F23D9B, 950
 8200 DATA 36092B35F23D9B36, 671
 8210 DATA 052B35F23D9BAFC9, 935
 8220 DATA CD14BC11C800217C, 787
 8230 DATA 013E12CDD3973A5D, 799
 8240 DATA 9F215D9F347CAB7, 1048
 8250 DATA 8B3DCAD4993DCA23, 1065
 8260 DATA 9C3D18F20600CD42, 760
 8270 DATA 550E04062878E60F, 514
 8280 DATA F6C0E6AA57CB3FB2, 1369
 8290 DATA 7723772310EF1100, 756
 8300 DATA 07197CF6C0670D20, 742
 8310 DATA E2C9010000CD38BC, 877
 8320 DATA CDC69106280E8CEB, 985
 8330 DATA 43089FED43059F3E, 764
 8340 DATA 4A320A9F32079FCD, 714
 8350 DATA A55606230E143E4D, 465
 8360 DATA ED430624ED430924, 695
 8370 DATA 320824320B24CDA5, 561

8380 DATA 563EFE320C240E74, 630
 8390 DATA CDB49BDD360F00CD, 1035
 8400 DATA 8896C9ED7362003E, 999
 8410 DATA 15CDA1923E4D0628, 718
 8420 DATA 0E96CDA5560664C5, 923
 8430 DATA CDC28ECD4694C110, 1173
 8440 DATA F6CD14BCCDDA9BCD, 1442
 8450 DATA C18CCD1395CD7F9C, 1194
 8460 DATA CD498DCD849D0DC3, 1313
 8470 DATA 9CCDCD9DC08F932A, 1260
 8480 DATA 089F22059F2A0324, 446
 8490 DATA 2200242A09242206, 197
 8500 DATA 243A0B24320824CD, 440
 8510 DATA C28ECD469418C8ED, 1220
 8520 DATA 4B089FCB4A280405, 568
 8530 DATA 200104CB42280678, 472
 8540 DATA FE4A300104ED4308, 693
 8550 DATA 9FCB62C49F9C93A, 1230
 8560 DATA 0F9FA7C03E4B3202, 722
 8570 DATA 24320524ED4B089F, 606
 8580 DATA 040479D0644FED43, 730
 8590 DATA 0024ED430324DD36, 654
 8600 DATA 0F01C93A0F9FA7C8, 816
 8610 DATA FE012012CD08F93ED, 1037
 8620 DATA 4B03243A0224CDA5, 580
 8630 DATA 56DD360F02C9ED4B, 891
 8640 DATA 032479FE7820350E, 633
 8650 DATA 74CD42557EA72836, 859
 8660 DATA CD8F93ED4B032479, 967
 8670 DATA D604E6FC4FCD4255, 1135
 8680 DATA 060436007CC608F6, 640
 8690 DATA C06710F6DD360F00, 847
 8700 DATA CD8F93ED4B03243E, 908
 8710 DATA 4BC3A55630083E4B, 714

8720 DATA CDF155DA3D9DED4B, 1279
 8730 DATA 032479D0604FE1838, 712
 8740 DATA DB4FED4303241100, 658
 8750 DATA 24CDD88EC9C08F93, 1295
 8760 DATA 110500AFC064933E, 711
 8770 DATA 4BED4B0324CDA556, 882
 8780 DATA 3A0B24ED4B0924C5, 659
 8790 DATA CDA556C1CD649DED, 1348
 8800 DATA 786200C91E193E4C, 615
 8810 DATA D5C5F5CDA556CD46, 1386
 8820 DATA 94CD28EF1C1C5F5, 1565
 8830 DATA CDA556F1C1D1EE80, 1465
 8840 DATA 1D20E5C9ED4B0924, 848
 8850 DATA 78210C248647CB7E, 735
 8860 DATA 2806FE05301A1804, 407
 8870 DATA FE4638147EED4477, 950
 8880 DATA 79C604FE6430144F, 824
 8890 DATA 3A0B24EE80320B24, 568
 8900 DATA ED430924110624CD, 613
 8910 DATA D88EC9CD8F93ED4B, 1366
 8920 DATA 089FC53A0A9FCDA5, 961
 8930 DATA 56C1C35C9D3A0F9F, 955
 8940 DATA A728063A0324FE60, 660
 8950 DATA D0064E0E74CD4255, 778
 8960 DATA E5545D131A014F00, 531
 8970 DATA EDB812E17CC60867, 1097
 8980 DATA FE8030ECC9113C00, 944
 8990 DATA 210C00CD0BB1184, 778
 9000 DATA 00210000CDF9BB11, 691
 9010 DATA 0000211600CDF9BB, 696
 9020 DATA 117CFF210000CDF9, 883
 9030 DATA BB11000021EAFCD, 931
 9040 DATA F9B0C93E01110000, 717
 9050 DATA CD6493CD4694CD79, 1201
 9060 DATA 9BA720EFC90100BC, 983
 9070 DATA 1E003E01ED797004, 578
 9080 DATA 03ED79051CD5C5F5, 1049
 9090 DATA CD4694F1C1CD3A94, 1268
 9100 DATA CD3A9401FE2820E2, 1172
 9110 DATA C9010000CD38BCCD, 856
 9120 DATA 14BCCD88963E16CD, 988
 9130 DATA A192063CC5C0C28E, 1111
 9140 DATA CD4694C110F6C900, 1079

ACU

DRAUGHTSMAN & GRAFMAN

Explore the true graphic potential of your
AMSTRAD CPC 464/664/6128.

Using cursor control keys, joystick, lightpen or graphics tablet you can work in all 3 modes using selected colours. Draw in solid, dash or dot/dash lines, circles, arcs, ellipses, polygons, etc. Recall regular shapes from memory. Draw in one or two point perspective. 3 cursor speeds. 3 types of erasers. Constant readout of X,Y coordinates, drawing and cursor status, distance measure, fix position, on-screen prompts. Hatching and fill facilities. Design sets of symbols (sprites) for use in your drawings/diagrams eg. electronic circuits. Print characters at any pixel position. Save/load symbols. Save/load screens. User screen dump option.

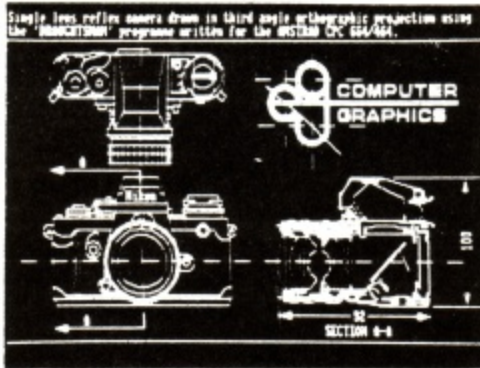

Written by a qualified designer this program is very versatile and user friendly. Your AMSTRAD has excellent graphic facilities. Why not put them to work?

"... an extremely good graphics aid".
"... the program is easy to use, the manual is easy to follow, and the presentation is professional". - Computing with the Amstrad, Nov. '85.
"... it is nice to see E.G. Computer Graphics adopt a different approach to the problem of creating a user friendly graphics package".
"... a strong favourite when compared to the fashionable icon system".
"... provides a very fast and efficient way of accessing a multitude of functions and drawing routines..." - Amtix! Jan. '86.

GRAFMAN is a powerful and versatile function plotter. Developed by a qualified physicist this program is capable of drawing any DEFINABLE function. User access to an extensive range of 'built-in' functions: generalized polynomials, trigonometric, exponential/logarithmic, irrational and inverse. Choice of X-Y scale is wide ranging and specific ranges can be defined to display any portion of a curve. Areas of high curvature can be 'magnified' allowing the user to 'home-in' on real roots to a high degree of accuracy. Save/load screen. User screen dump option. Despite the complexity of the program it is very user friendly. On-screen instructions carefully explain each step making this a truly valuable and educational utility.

For further information send S.A.E.



COMPUTER GRAPHICS

Draughtsman (disc)	£24.95
Draughtsman (tape)	£19.95
Grafman (disc)	£15.95
Grafman (tape)	£11.95

EG COMPUTER GRAPHICS, Orange House, Orange Street, Uppingham, Leics. LE15 9SQ.

INITIATOR LTD

SPECIALISTS IN THE PCW 8256

If you use Locoscript for letters then this Label Creator is ideal for printing self adhesive labels!

- Data Base storage & retrieval.
- 8 separate groups per disk.
- Variable size labels.
- Mail-Shot or multiple labels.
- Menu Driven & Easy to Use.

Only £29.95

Digital Research

DR Draw	£45.00
DR Graph	£45.00
DR Pascal	£45.00
DR CBASIC Compiler	£45.00
Pocket Wordstar	£45.00

3" CF2 Disks £3.99 each
£39.00 for 10

SuperCalc2: £45.95

All prices inc VAT & p&p

INITIATOR LTD. Tel. 0305 60010
2 DUKES AVE
DORCHESTER
DT1 1EN

7 Coniston Road, Melton Mowbray,
Leicestershire LE13 0NE

Squirrel's Byte

Tel: (0664) 63617

COMPUTERS - CARRIAGE FREE!

CPC 6128	294.00	PCW 8256	439.00
CPC 6128 colour	399.95	PCW 8512	569.50

PRINTERS - Carriage £7.00

Amstrad DMP2000	154.00	Juki 5520 (colour)	399.50
Star NL10	259.00	Daisy Junior	209.50
Citizen 120D	199.95	Juki 6100	345.00
Epson LX80	239.00	Brother HR15	382.95
Seikosha SP1000	229.00	Epson H180 plotter	389.00

CABLES - Carriage free!

1 metre	9.95	Printer extension cable set for PCW8256/8512	11.50
2 metre	10.95		

RIBBONS - CARRIAGE FREE!

Amstrad PCW8256/8512	5.50	Amstrad DMP2000	5.50
Shinwa CP80	3.99	Epson MX/FX/RX 80	3.60
Kaga KP810	4.99	Epson FX/RX 100	5.20
Canon PW1080	4.99	Epson LX-80	3.90
Juki 6100 s/s	1.65	Seikosha GP80/100/250	3.75

PAPER & LABELS - CARRIAGE FREE!

2000 sheets per box	Price per 1000 labels		
Exact A4 70 gsm	19.45	3.5" x 1.5" 2 across	6.95
11 x 9.5" 60 gsm	14.95	2.75" x 1.75" 2 across	6.25
12 x 9.25" 60 gsm	17.25"	2.75" x 1.75" 3 across	6.25

MODEMS - CARRIAGE £6.00

Pace Nightingale (for CPC464/664/6128)	161.00	Miracle WS2000 (for 6128/8256)	184.00
(inc. Interface, lead & Commstar)		(inc. RS232 Interface, software & lead)	

UPGRADE FOR PCW8256 - POST FREE!

Set of 8 chips to give 369k on drive M:
- equivalent to 8512 **47.50**
Full fitting instructions included.

DISK DRIVES - CARRIAGE £6.00

Amstrad FD2 (for PCW8256)	175.00
Box 5.25" drive for PCW8256	
360K drive	175.00
720K drive	205.00
Cumana CS002 5.25" drive (for 664/6128)	139.00
(Please state machine type when ordering)	
3" DISKETTES - POST FREE!	
Price per box of 10 CF2 disks	38.75
Price per box of 5 CF2 disks	20.95
5.25" disks also available - ring for latest discount prices	

PERIPHERALS - POST FREE

AMX Mouse	64.50	Joystick	14.95
Serial I/Face 664/6128	49.00	Serial I/Face 8256/8512	62.50
Speech Synth 464	29.95	Speech Synth 6128	38.50
Light Pen	19.95	Grafpad II (disc)	75.00
64K RAM board 464/664	96.75	128K RAM board 464/664	109.00

SOFTWARE - POST FREE!

SAGE Popular accounts	95.50	CAMSOFT (for PCW8256/8512) Cambase database	49.95
Payroll	62.50	Stock Control	49.95
Accounts + payroll	146.00	Sales ledger	49.95
Invoicing & stock	62.50	Nominal ledger	49.95
Database	62.50	Sales/Purch/Nom.	99.95
Chit Chat + combination	95.50	Payroll	49.95
GEMINI Datagem 8256/8512	39.95	Invoicing	49.95
Office Mate (disk)	17.50	Purchase ledger	49.95
Office Master	25.00	Stock/Invoic/Sales	99.95
ARNOR Protext AD2-ROM	49.95	Stock/Invoicing/Sales/	
Protext Eprom	39.95	Purchase/Nominal ledgers	149.95
Protext Disc	26.95	AMSOFT Supercalc II	47.50

AUGUST SPECIAL OFFER

10 AMSOFT 3" CF2 DISKS **£37.95**
5 AMSOFT 3" CF2 DISKS **£19.95**
SAME DAY DESPATCH!



All prices include VAT. Please telephone if you do not see the item you require.

Subscriptions

Cheap discs WOW!

Discs are essential to anyone with an Amstrad disc drive so if you own a DDI-1, CPC 664, CPC 6128, PCW 8256 or even a PCW 8512 you will be interested in this special offer.

Our discs cost less than £2.74 each.

You could pay as much as twice that, the usual price is around £4 per disc. "There must be a catch". Yes, there is - you can only buy four discs at this special rate and you can only qualify for the offer when you subscribe to *Amstrad Computer User*.

This means that for the bargain price of £22.95 you get four 3in CF-2 discs and 12 issues of *Amstrad Computer User*, full of programs, listings, reviews and articles to help you make the most of your computer and discs. For overseas readers the prices are £37.95 for subscribers within Europe and £54.95 for readers outside Europe.

Tapes/Discs

Tapes and discs contain all the major listings from *Amstrad Computer User*. Tapes cost £3.50; discs £6.50. Contents of the latest issues included:

JANUARY: Mode 3, how to use the Amstrad's secret 8k screen mode.

Sorcery plus pokes and sprite editor.
Shaded dump utility for Epson printers.
Pak Caverns machine code and Basic Game.

FEBRUARY: Animation: simple graphic displays.
Roland takes a running jump game and screen designer.
Galaxians Revenge. Space shoot-em-up.

MARCH: Roland takes a running jump source code.
Racer - prize winning listing.

APRIL: Animator, an advanced cartooning program.
Re-defined characters for the PCW 8256.

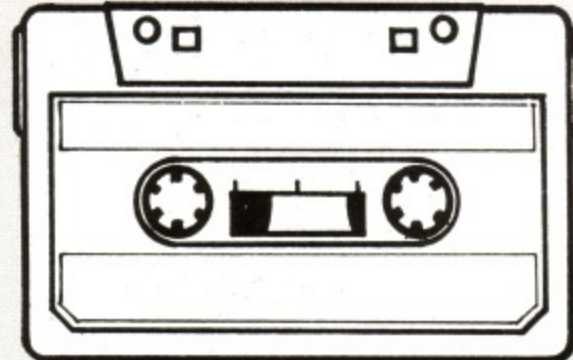
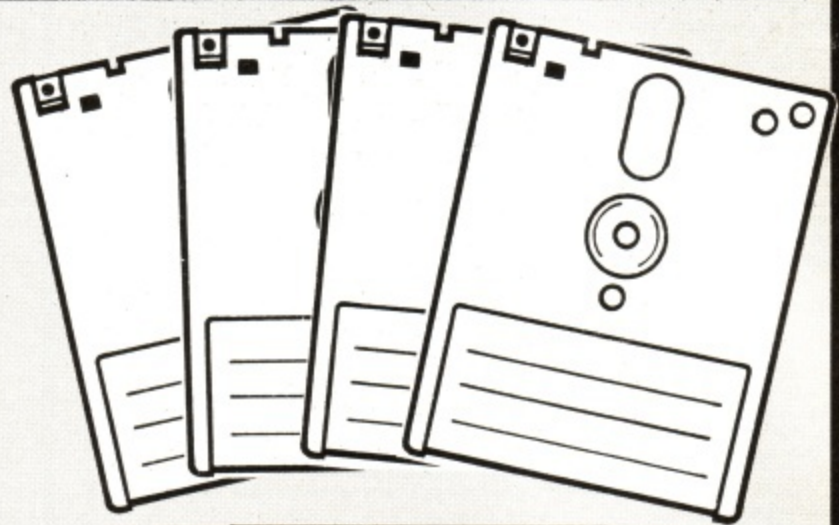

MAY: Homesread, one liners, GSX for 6128/8256.

JUNE: Super arcade game. Simple Music, interrupt driven tunes.

JULY: Battle of the cars, TLL pokes, Goin' Loco and ZX loader.

Back issues

March: Interrupt driven screen dump.
Music explained. Fill routine.

April: Printer reviews. Joystick reviews.
Proportional printing.

May: CPC 664 review. Virgin interview.
Using 5 1/4 inch discs.

June: Maxam assembler review. Rock
Hopper listing. CP/M user group feature.

July: 664 (and 6128) to 464 conversion.
Graphics toolkit listing. Speech syn-
thesisers compared.

August: Screen designers compared.
Technician Ted map. Knight Lore map and
pokes.

September: Double height routine.
Unsung heroes - MEJ. Crazy legs listing.

October: CPC 6128 review. Okimate 20
review. DK'tronics light pen.

November: Amgraph business graphics
listing. DMP - 2000 review. Life program.

December: Everyone's a Wally map and

pokes. Protex review. Enhanced trace
utility.

1986 - January: Mode 3 revealed.
Sorcery plus pokes and map. Shaded
dump listing.

February: Brainstorm review. Graphics
adventure creator. DK'tronics ram expan-
sion review.

March: Communications survey. Laser
Basic reviewed. The Music system
examined.

April: Using the 6845. Screen flipping on
the 6128. Graphic packages reviewed.

May: Max Headroom. Joysticks com-
pared. Teletext adapter reviews. Home-
spread listing. Dummy Run map. CPS
review.

June: Batman Map. Biggles preview. Get
Dexter Map. Music made simple. ABC
Planner calc.

July: Palace interview, Activision, Load
Spectrum screens into an Arnold, Battle of
the cars program.



£1.25
each

Use the order form opposite - no stamp needed

Binders

Your *Amstrad Computer User* is the ideal source of reference for every user of Amstrad computers. Keep your magazines tidy and in tip-top condition by using our top quality binder.

The *Amstrad Computer User* binder holds 12 issues. Each binder is black with the logo embossed in silver.

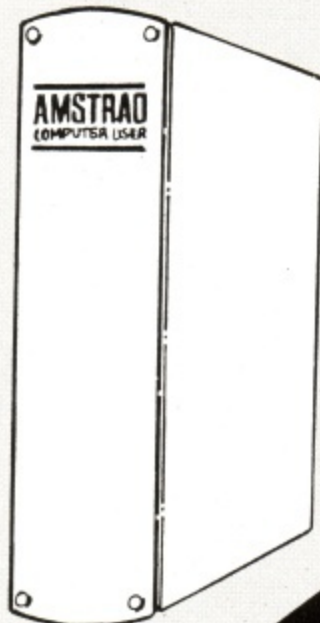

**ONLY
£3.95**

Dustcovers

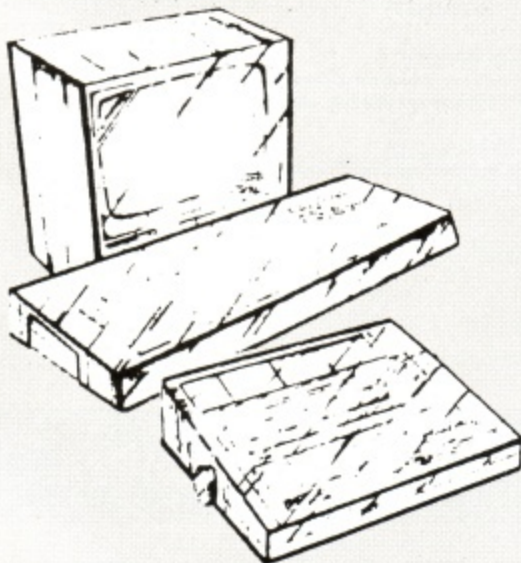

Keep your equipment free from dust and grime with an *Amstrad Computer User* dustcover, made from clear pliable vinyl and bound by strong red cotton and sporting the logo.

CPC 464/664 keyboard cover	£3.95
CPC 6128 keyboard cover	£3.95
Green screen monitor cover	£5.95
Colour screen monitor cover	£5.95
PCW 8256 keyboard, monitor and printer set ...	£11.95

AMSTRAD COMPUTER USER

ORDER FORM

Offers subject to availability

Valid to 31.8.86

All prices include postage, packing & VAT.
All overseas items despatched by air mail.

Subscriptions

£ p
 £12 UK and Eire 8000
 £25 Europe 8001
 £40 Overseas 8002

Commence with _____ issue

Subscription offer †

Four 3" discs £10.95* 8115

*Europe add £2. Overseas add £4

†Only available if accompanied by subscription order.

Back numbers £1.25 each

Jan/Feb '85 ... 8003	N/A	November	8012	<input type="checkbox"/>
March 8004		December	8013	<input type="checkbox"/>
April 8005		January '86	8014	<input type="checkbox"/>
May 8006		February	8015	<input type="checkbox"/>
June 8007		March	8016	<input type="checkbox"/>
July 8008		April	8017	<input type="checkbox"/>
August 8009		May	8018	<input type="checkbox"/>
September ... 8010		June	8019	<input type="checkbox"/>
October 8011		July	8020	<input type="checkbox"/>

Tapes & Discs

Tapes £3.50; Discs £6.50

		Tape	Disc
January '86	8044/45	<input type="checkbox"/>	<input type="checkbox"/>
February '86	8046/47	<input type="checkbox"/>	<input type="checkbox"/>
March '86	8048/49	<input type="checkbox"/>	<input type="checkbox"/>
April '86	8050/51	<input type="checkbox"/>	<input type="checkbox"/>
May '86	8052/53	<input type="checkbox"/>	<input type="checkbox"/>
June '86	8054/55	<input type="checkbox"/>	<input type="checkbox"/>
July '86	8056/57	<input type="checkbox"/>	<input type="checkbox"/>
August '86	8058/59	<input type="checkbox"/>	<input type="checkbox"/>

Dust-covers

CPC 464/664 keyboard	8100	<input type="checkbox"/>
CPC 6128 keyboard	8101	<input type="checkbox"/>
£3.95		
CPC range green screen	8102	<input type="checkbox"/>
CPC range colour monitor	8103	<input type="checkbox"/>
£5.95		
PCW 8256 keyboard, monitor and printer set	8104	<input type="checkbox"/>
£11.95		

Binders

£3.95 UK	8106	<input type="checkbox"/>
£6.95 Europe		
£10.95 Overseas		

European and Overseas readers, please add £2 per item unless otherwise indicated

TOTAL _____

Send to
Amstrad Computer User,
FREEPOST,
36 St Petersgate,
Stockport SK1 1HL.

Telephone orders 061-429 7931 24 hours
Enquiries 061-480 0171 9am-5pm

Please indicate method of payment ()

Access/Mastercharge/Eurocard/Barclaycard/Visa

Expiry date

Signature _____

Cheque/PO made payable to Amstrad Computer User

Name _____

Address _____

PLEASE PRINT IN BLOCK CAPITAL LETTERS
Please allow up to 28 days for delivery

ACUB

**LARGEST COMPUTER CENTRE
IN
MANCHESTER**

**MAIN AMSTRAD STOCKIST
+
ALL LEADING COMPUTERS**

Extensive range of AMSTRAD software, books and addons.

Personal export scheme. Export dealer enquiries welcome

24 hour. U.K. mail order facility.

MIGHTY MICRO

SHERWOOD CENTER 268 WILMSLOW ROAD
FALLOWFIELD, MANCHESTER TEL: 061-224 8117

O. J. SOFTWARE

FAST FRIENDLY SERVICE

**** SPECIAL ORDER TWO OR MORE ITEMS AND DEDUCT AN EXTRA 50p PER ITEM ****

ADVENTURE		ARCADE		ARCADE	
WORM PARADISE	£8.95	YOUNG ONES	£6.95	WORKING BACK DISC	£11.95
HEAVY ON MAGIC	£8.95	2112 AD	£6.95	COMP HITS 8 DISC ONLY	£11.95
LORDS MIDNIGHT (D)	£8.95	MELTDOWN	£7.95	DOORS OF DOOM +	£11.95
SWORDS SORCERY (D)	£8.95	GREEN BERET	£7.95	BUS/UTILITIES	
LORD OF RINGS	£13.95	MONTY ON RUN (D)	£7.95	MINI OFFICE II (D)	£13.50
STRATEGY/SIMULATION		BOUNDER (D)	£7.95	GRAPHIC ADV CTOR (D)	£19.95
W/CUP CARNIVAL (D)	£8.95	V (D)	£7.95	MUSIC SYSTEM (D)	£13.50
PING PONG (D)	£7.95	BATMAN	£7.95	TASWORD 484D/128	£21.45
TANK COMMANDER (D)	£8.95	HYPERSPORTS (D)	£7.95	MASTERCALC 128	£29.50
ROCK & WRESTLE	£8.95	BOMB JACK (D)	£7.95	MASTERFILE (D)	£21.95
TOMAHAWK (D)	£8.95	GUNFRIGHT	£8.95	LASER BASIC (D)	£12.95
FIGHTER PILOT (D)	£7.95	SOLD A MILLION (D)	£8.95	LASER COMPILER (D)	£17.50
ST/FORCE HARRIER (D)	£8.95	EQUINOX (D)	£8.95	ACCESSORIES	
SPITFIRE 40 (D)	£8.95	TAU CETI (D)	£8.95	BLANK DISCS	£4.50
MONOPOLY (D)	£8.95	5th AXIS (D)	£8.95	COMP PRO 5000 J/ST	£15.95
CYRUS II 3D CHESS (D)	£8.95	WINTER GAMES (D)	£8.95	SURESHOT JOYSTICK	£14.95
3D GRAND PRIX (D)	£8.95	SOLD A MILLION II (D)	£8.95	ELEC STUDIO LIGHTPEN	£17.95
SCRABBLE (D)	£8.95	SHOGUN	£8.95	AMSTRAD SPEECH SYN	£27.95

Notes: (D) = £3.50 to tape price for disc version: All tapes run 664/128
Most orders despatched by return (out of stock items usually within 1 week)

Cheques/PO's to O. J. SOFTWARE (Prices incl. U.K. p&p.)
273 MOSSY LEA ROAD, WRIGHTINGTON, WIGAN, LANCs. WN6 9RN.
Write or phone (0257) 421915 for FREE LIST and LATEST RELEASES
Overseas orders. Please add 50p Europe, £1.00 others, per item.

HardSoft • international
46 The Maltings, Stanstead Abbots, Nr. Ware, Herts. SG12 8HG

AMSTRAD BUSINESS SOFTWARE

Amsoft for 6128 & 8256	Inc VAT & Carr £	Accounts. Nominal/Sales/Purchase	ledger	94.99
Supercalc 2. Spreadsheet	45.95	Accounts Plus. Accounts + Stock control & Invoicing	145.99	
Combase for 8256		Combo Pack Accounts + Payroll	145.99	
Combase. Database as used by Rolls Royce.	44.95	Super Combo. Accounts + Stock control. Invoicing & Payroll	189.99	
Payroll. Max. 929 employees (1 disk)	44.95	E-Mail. Modem. Cable. Electronic mail (requires interface)	189.99	
PSIS System. Stock control. Invoicing. Sales ledger	94.95	Viewdata. Modem. Cable (requires interface)	189.99	
PSPN System. Sales/Purchase/Nominal ledger	94.95	All available without modem for Chit-Chat upgrades available for Rational Solutions	49.95	
PSIL System. Sales/Purchase/Nominal ledger + Stock control & Invoicing	144.95	AtLast. Database	49.95	
Caxton for 8256 & 6128		Computer stationary available - send for details.		
Cardbox. Simple to use Database	95.99	Prices shown are for cash with order if you would like to be invoiced there is a surcharge of 2½% on quoted prices.		
Touch 'n' Go. Typing tutor	24.99	Brochures, advice on products and Access orders accepted on 0920 870568.		
Scratchpad Plus. Spreadsheet-256k + Virtual memory	64.99	All goods despatched within 24 hours when available. Overseas orders welcome. Callers by Appointment only.		
Compact for 8256				
Daybook. Purchase/Sales Daybook & Nominal	44.95			
Accounts. Sales/Purchase/Nominal ledger & Invoicing	189.95			
Payroll. Full Payroll with SSP	94.95			
Nucleus. Applications/Report generator	94.95			
Sage for 6128 & 8256				
Database. Electronic filing cabinet	64.99			

SCHOOL SOFTWARE LTD.

MAIL ORDER

Music Invaders (Age 7-Adult) Meadowvale Estate, Raheen, Limerick, Ireland.
Telephone: (061) 27994, (UK) 010-353- 61-27994.

- Magic Maths (Age 4-8)
- Maths Mania (Age 8-12)
- Better Maths (Age 12-16)
- *Better Spelling (Age 9-14)
- *Better Spelling (Age 8-Adult)
- *Physics 1 (Age 12-16) CSE/O' Level
- *Biology 1 (Age 12-16) CSE/O' Level
- *Chemistry 1 (Age 12-16) CSE/O' Level
- Weather/Climate (Age 12-17)
- Playschool Maths/Letters (Age 3-7)

Read our excellent reviews in all the major magazines.

Cassettes £9.95 each. Discs £12.95 each.
48 hour MAIL ORDER
CPC464/664/6128/PCW 8256 (SOON)

* Available for PCW8256

**FOR YOUR AMSTRADS 464/664/6128
FULLY EXPANDABLE INTERFACE UNIT**

* Dual RS232 Channels * 4 Sideways ROM Sockets * 8 Bit User Port * 8 Bit Printer Port	£69.95
* Through Expansion Socket * Software on ROM	£29.95
4 SIDEWAYS ROM UNIT with Expansion Socket	£85.00
3" DISC DRIVE W/O INTERFACE	£19.95
3" AMSOFT CF2 DISCS - PACK OF 5	£34.95
BOX OF TEN	£27.95
UPGRADE YOUR PCW8256 TO 512K With Memory Kit	£2.75
2764 (250nSec)	27128 (250nSec)
Centronics Printer Cable (2m)	£13.50
Serial Printer/Comm. Cable (2m) Supply Details	£10.50
25 Way 'D' Connector: MALE	£1.50
36 Way IDC Centronics: MALE	£4.50
IDC Edge Connector: 34 WAY	£3.75
Ribbon Cable (1m): 34 WAY	£2.40
25 Way 'D' Connector Cover/Headshell	£2.00

ALL PRICES INCLUSIVE OF VAT & CARRIAGE. Send Cheque & Order to:

PANDA ELECTRONICS LIMITED

Unit K, Edison Courtyard, Brunel Road,
Corby, Northants NN17 2LS. Tel: (0536) 201743

S.B.S.

SMALL BUSINESS SOFTWARE
The Amstrad Programmers
54 Bedford Road
Holland-on-Sea, Essex CO15 5LF
(0255) 813069

DATA MASTER

The easy to use information system for data storage.
Menu driven for all facilities.
WHY PAY MORE?

INVOICE MASTER

Save time and money on invoice and statement production with Invoicemaster. Excellent value.

POOLS MASTER

The ideal way to check your football results data for Sun plans includes facilities to enter your own plans.

Prices	Tape	Disc
1 Program	12.00	15.50
2 Programs	24.00	27.00
3 Programs	36.00	38.50
4 Programs	48.00	50.00
Copy Master	6.50	N/A

SMALL BUSINESS SOFTWARE
FOR THE CPC
464, 664, 6128 and PCW 8256

STOCK MASTER

Say goodbye to your stock control problems with our easy to use Stock Master. Covers quantities as well as values.

LETTER MASTER

The quickest way to produce letters, memos, lists etc. with the easy to use Letter Master.

COPY MASTER

Keep your master copies safe with Copy Master the ideal backup copier.

SPECIAL

Save £4 by sending your own disc
FREE Loader Program with each tape/disc.
Personal programming undertaken at competitive rates.
Price on application.
S.A.E. for further details.

S.B.S.

LANGUAGE TOOLS FOR AMSTRAD CP/M

Turbo Pascal 3.0 (inc editor & OVERLAYS)	57.50a
Turbo Toolbox 1.2 (ISAM database tools, etc.)	46.00a,b
Turbo-Amstrad Interface (Turbo to Firmware interface for windows, turtlegraphics, sound, etc.)	14.95c
Turbo Tutor	34.50a
Pro-Pascal (ISO standard compiler)	85.95b
Pro-FORTRAN (ANSI 66)	85.95b
DR Pascal/MT+	49.95b
DR CBASIC Compiler	49.95b
Toolworks C/80 (C compiler)	69.95b
MathPak (floats & longs for C/80)	46.95b
Toolworks LISP/80 (Lisp interpreter)	69.95b
Micro-Prolog (Interpreter & Tutorial)	79.95
Modula-2 Compilers/FTL (inc. editor)	49.95b
Hochstrasser (Zurich)	39.95b

a=Includes FREE sub to One-To-One (worth £50)
b=Not unexpanded CPC464. c=Not PCW8256/512
APPLICATIONS SOFTWARE FOR CPC6128 & PCW8256/512
AtLast, IanKey, Hands On (CP/M Plus, SuperCalc Tutorials), Cracker, Audio Tutors, DR Graph, DR Draw, SuperCalc 2, MicroFile, Sage, Brainstorm, Touch 'n' go, Cardbox, Smart Key, Scratchpad, Compact, hardware, manuals, consultancy... Ask for list

VAT and P&P (Europe) included. Please state model when ordering.
All payments in Sterling drawn on a UK account. ACCESS accepted.
Callers please ring first.

**RATIONAL SOLUTIONS, 9 Rosehill Road,
London SW18 2NY. Tel: 01-874 6244**

TELETEXT ADAPTOR

The Microtext adaptor converts your CPC464 664 or 6128 into a sophisticated Teletext Receiver. Giving you full colour text and graphics display of any of the hundreds of free pages from Oracle or Ceefax. You can save pages too! to disc or cassette, print them on your printer and even access them from your own programs.

PLUS Telesoftware - free software on teletext pages which the adaptor will load for you to save or run. Supplied with a manual, the adaptor is cased with a through connector, it fits neatly on the expansion port. A connecting lead goes to the 'VIDEO OUT' socket of any video recorder - this concept means no complex tuning procedures and saves you a great deal of money!

ONLY £69.95 inc P/P.
Please send cheques/POs to:

MICROTEXT

7 Birdlip Place, Horndean, Hants PO8 9PW
Telephone: 595694

Write-Hand-Man
Enter Choice []

- A - Notepad**
- B - Phonebook**
- C - Calendar**
- D - Dir**
- E - View**
- F - Calculate**
- G - Keys**
- O - Other**

Write Hand Man

This fabulous program sits in the background of your computer ready to spring into action at the press of a key and it doesn't matter what you were doing before, Write Hand Man is always at your beck-and-call.

You're writing a letter and need the pre-VAT price of something; use Write Hand Man's calculator. You're using a spreadsheet and want to make some notes; use Write Hand Man's notepad. Autodial phone numbers with the phonebook. Set up 8 different macro keys with commonly-used phrases or commands. Look at a directory of your disc or view a document while you're editing another document. Write Hand Man is always there to help you.

Write Hand Man works alongside any CP/M 2 or CP/M Plus program on all Amstrads, comes complete with a manual describing how to add your own applications and costs only

£29.95

HiSoft TurboBASIC

At long last there is a fast and powerful BASIC compiler for Amstrad BASIC! HiSoft TurboBASIC is a true compiler of Locomotive BASIC 1.0 on the Amstrad CPC series of computers turning your BASIC statements into machine code programs to be executed whenever you like.

TurboBASIC certainly is fast, just look at the PCW benchmark timings using interpreted BASIC and compiled TurboBASIC.

	BM1	BM2	BM3	BM4	BM5	BM6	BM7
Interpreted	0.116	3.31	9.17	9.62	10.18	19.1	28.9
Compiled	0.0042	0.046	1.13	1.12	1.12	1.39	1.55
Speed up	27	71	8.1	8.6	9.0	13.7	18.6

All timings in seconds

Also, the BYTE Sieve benchmark, which is an example of a whole program and not a somewhat artificial benchmark, executes in 2.56 seconds when compiled with TurboBASIC as compared with 122 seconds when interpreted with BASIC 1.0, a speed increase of 49!

Turbo BASIC is an *integer-only* compiler which means that it only compiles whole-number arithmetic, not floating-point. This allows compiled programs to run with extra speed and, in conjunction with the Amstrad graphics (all of which are supported by TurboBASIC) some pretty amazing games can be written in BASIC instead of machine code. We supply an example space invaders game free with TurboBASIC so you can see for yourself the dramatic speed increase.

HiSoft TurboBASIC £14.95 tape, £19.95 disc

HiSoft 180 High Street North Dunstable Beds LU6 1AT (0582) 696421

HiSoft UPGRADES

We offer an upgrade service if you have an old version of a product and wish to get an up-to-date copy; write or call for more information. We cannot offer an upgrade from one product to another (e.g. if you change your computer or go from cassette to CP/M) because of the substantial effort which goes into creating each product.

HiSoft PRICES

AMSTRAD CPC, PCW8256/8512

PASCAL80 (CP/M 2.2, CP/M Plus) Compiler/editor with GSX graphics	DISC	£39.95
DEVPA80 (CP/M 2.2, CP/M Plus) assembler/debugger/editor	DISC	£39.95
C (CP/M 2.2, CP/M Plus and AMSDOS versions together) compiler/editor	DISC	£39.95
CATALOG (file cataloguing system)	DISC	£14.95
The TORCH (CP/M 2.2, CP/M Plus) CP/M tutorial	DISC	£12.95
The KNIFE (CP/M 2.2, CP/M Plus) CP/M disc sector editor	DISC	£12.95

CPC ONLY

TurboBASIC BASIC compiler	TAPE/DISC	£14.95/£19.95
FONT64 font editor/screen copier	TAPE/DISC	£7.95/£12.95
AMSDOS PASCAL (interactive with line editor and firmware support)	TAPE/DISC	£29.95/£34.95
AMSDOS DEVPA80 (the original AMSTRAD development system)	TAPE/DISC	£21.95/£26.95
ART IN PASCAL (graphics creation program including Pascal source)	DISC	£14.95
C compiler (disc version same as CP/M disc)	TAPE/DISC	£34.95/£39.95

HiSoft ORDERING

All products are available directly from us by mail order or by telephone using Access or Visa. All prices are inclusive of VAT and postage and also include the relevant manual. We always despatch orders by first class post. Please enclose a cheque or postal order made payable to HiSoft. Be sure to tell us exactly **what computer** you have and **what product(s)** you want. Write or call for export prices and shipping details.

HiSoft 180 High Street North Dunstable Beds LU6 1AT (0582) 696421



17 Beam Street, Nantwich, Cheshire CW5 5NA.

PCW 8512	£549
PCW 8256	£434
FD2 Disk Drive	£139
6128 Colour	£385
6128 Green	£285
Memory Upgrade	£32.50
Price List Control Database	£24.00



All Amstrad Accessories Available.

Tel: 0270 629758

Prices include VAT & Delivery

AMSTRAD 512K UPGRADE MEMORY KITS For the PCW 8256 — £39.95!

You can now install a further 256K in your Amstrad PCW 8256 with our upgrade kit complete with simple instruction leaflet. It's so easy!

Please send **£39.95** cash with order, VAT, postage and packing included. Fast despatch of your kit on receipt of your order.



Compatibility Ltd. Connors Yard

Crowborough Hill Crowborough

East Sussex TN6 2DA Tel: (08926) 65326/7

AMSTAT — AMSTRAD STATISTICAL AND MATHEMATICAL SOFTWARE

AMSTAT1 — means, s.devs, t-tests, 1-way-ANOVA, 2-way-ANOVA, correlations, regressions, histograms, scattergrams, transformations, file storage and retrieval, manual.

£14.99 cass. £19.50 disc. (CPC Computers Only)

"An excellent buy for school level". — Tony Kettle, Popular Computing Weekly, 8-14th May 1986.

AMSTAT2 — 27 nonparametric tests in 4 programs providing a "complete Siegel".

£39.95 inc manual. (CPC and PCW Computers).

"I now give it an unreserved recommendation..." Jo Stork, Business Computing with the Amstrad, July 1986.

AMSTAT1 + AMSTAT2 £49.95 (disc or cassette). (CPC only)

FORECASTING — THE ORIGINAL JPC SOFTWARE. (**AMSTAT3**)

An array of business oriented mathematical and statistical software: Linear and Polynomial regression, Trend and Seasonal Variation, Multiple Regression Analysis, Transformations, Exponential Smoothing, Adaptive Filtering, Graphic display, full printout, outstandingly comprehensive manual suited to immediate use and for teaching.

Sales, production planning, work and method study, financial planning, personnel, social work, students, research, whatever your field this package will have something for you.

CPC version £25.95, PCW version £27.95

RESOURCE MANAGEMENT — LINEAR PROGRAMMING MODULE (**AMSTAT4**)

Three programs: General Purpose Linear programming + Specialised Transportation and Assignment variants. Capable of analysing and solving problems of sequencing, scheduling, blending, and allocation of scarce resources. 40 page manual, 18 worked examples.

CPC version £25.95, PCW version £27.95 The complete AMSTAT Range (CPC only) £99.95

All prices include P&P within UK.

Cheques, POs to: **S.C. COLEMAN, 33 LEICESTER ROAD, ASHBY-DE-LA-ZOUCH, LEICS, LE6 5DA.**

Telephone: 0530 415919

Technical Enquiries after 6.00pm or Weekends.

It was NINE years ago that the microcomputer first hit this country, with the first PCW Show — and Kansas was there!

The company has successfully marketed Tandy TRS-80, then BBC and Electron and now AMSTRAD programs.

Whilst the huge bulk of software companies have bitten the dust — and taken their programmers' royalty with them, Kansas programmers are still being paid!

So if you have a good Amstrad Program — game or utility — then submit it to Kansas and get a full 25% royalty, and not until the next hiccup either, but for as long as the Amstrad lasts, and as much as our sheer marketing experience can get . . .

Kansas DISTRIBUTORS THROUGHOUT THE WORLD

Unit 3, Sutton Springs Wood, Chesterfield, S44 5XF

Tel: (0246) 850357



PRE-SCHOOL, PRIMARY, JUNIOR

Education

By a Teacher. Tested by Pupils

Approved by Parents and Schools
For Home use on all CPC models

Also for BBC

£6.00 Per Set

Choice of more than FIFTY programs.

SAE for Lists to:

ARC (ACU 2) 53 Bentley Street, CLEETHORPES,
Stn. HUMBERSIDE DN35 8DL. (0472) 699632

JACKSON COMPUTERS LIMITED

JOIN OUR DISCOUNT CLUB!

Annual membership for £8.50

Software discount of 15-25% off R.R.P.

Hardware discount 5-20% off R.R.P.

All AMSTRAD and other leading makes of software available. Complete computer systems, disc drives, printers, joystick, modems, cables.

AMSTRAD CPC464 with colour monitor £279.95.

AMSTRAD CPC6128 with Colour monitor £379.95.

PCW8256 includes printer, monitor, disc drive for £429.95.

NEW PCW8512 Special price £552 (inc free membership, VAT & P&P).

SPECIAL OFFERS: Any Amstrad CPC or PCW 8256 computer purchase annual membership is FREE. All prices include V.A.T., postage and packing.

NO CALLERS PLEASE MAIL ORDER ONLY

TEL: (01) 651 6244

Send for membership application form and full price list to:
67 Selsdon Park Road, South Croydon, Surrey, CR2 8JF.

'OXSTAT' STATISTICS

PCW8256 PCW8512 CPC6128

includes → → →

£99 + VAT

VAT

inclusive price

£113.85

(includes p&p)

ANALYSIS OF VARIANCE (one & two way)

— CHI-SQUARED (+Fisher+Yates') —

— LINEAR REGRESSION (ten way) —

— MEAN-MEDIAN (max & min) — STANDARD

DEVIATION — PLOTTING — HISTOGRAM &

BAR CHART — T-TESTS — F-RATIO —

SPEARMAN — WILCOXON — CORRELATION

— and others . . .

Data input by SPREADSHEET with usual functions.

For scientists, managers, doctors, teachers, etc.

Medstat Ltd

City House Maid Marian Way, Nottingham NG1 6BH. UK. Tel: (0602) 411120. Telex: 377844 ABCPLS G.

Micro-Aid

Software: CASHBOOK Double Entry bookkeeping	£14.95
MAILING 250 names/addresses for label printing	£14.95
PAYROLL full system with 1, 2 & 4 weekly & monthly, contracted in and out, 3 overtime etc. etc. (PCW & CPC versions)	£49.95
SPECIAL OFFER (Last THREE programs on one disc)	£55.00
***** Protex	£39.95
AtLast Database	£49.95
Printers: CITIZEN 120D NLQ 120 cps Friction & Tractor	£265.00
CENTRONICS GLPII NLQ 100 cps Friction & Tractor	£189.95
IBICO LTR-1 Letter Quality Friction	£113.85
Printer Ribbons: PCW8256/8512	£5.50
Printer Cable suitable for Amstrad to Centronics	£7.95
Disc Drive (2nd) with power supply for CPC machines	£87.95
Discs: 3" Double sided	each £3.95
3" Double sided	box of 10 £35.95
Cassettes: C15 boxed in 5's, leaderless,	10 for £2.50
Listing Paper Box 2,000 sheets 11" x 9.5"	now £12.45
Labels for Mailing, 1,000 3 across 2.75" x 1.4275"	£8.50

Prices include VAT. Add 50p for Postage & Packing.

Micro-Aid (Amstrad),



25 Fore Street, Praze, Camborne, Cornwall. TR14 0JX
or Telephone 0209-831274 with ACCESS or PRESTEL *2582020

LOAD & RUN

THE AMSTRAD SPECIALISTS

LOAD & RUN,
DEPT. ASU
P.O. BOX 123
DARTFORD
DA1 5AA

RING (0322) 73128 FOR ENQUIRIES + LATEST RELEASES

We are continuing our policy of '85 into '86 with this selection from over 400 items in our list.

PCW	RRP	OUR PRICE	P&P
Supercalc II (Amsoft)	£49.95	£39.95	
PCW 8256 (Amstrad)	£458.85	£439.95	£12.00
PCW 8512 (Amstrad)	£573.85	£559.95	£12.00
PCW Printer Ribbon (Amstrad)	£5.95	£5.50	
PCW Cover			
(Set of 3 Mon/Key/Print) (Amstrad)	£9.95	£9.45	
Cambase (Cambrian)	£49.95	£45.95	
Brainstorm (Caxton)	£49.99	£39.95	
Cardbox (Caxton)	£99.99	£79.95	
Touch 'n' Go (Caxton)	£24.95	£20.95	
Scratchpad Plus (Caxton)	£69.99	£59.95	
Popular Accounts (Sage)	£99.99	£79.95	
Popular Accounts + (Sage)	£149.99	£129.95	
Popular Invoicing (Sage)	£69.99	£59.95	
Popular Payroll (Sage)	£69.99	£59.95	
Popular Combo Pack (Sage)	£149.99	£129.95	
Popular Super Combo Pack (Sage)	£199.99	£175.95	
Sage Database (Sage)	£69.99	£59.95	
Pocket Wordstar (Micropro)	£49.95	£45.95	
Accounts (Compact)	£199.99	£185.95	
Nucleus (requires FD 2) (Compact)	£99.99	£85.95	
Dr Graph (D.R.)	£49.95	£45.95	
Dr Draw (D.R.)	£49.95	£45.95	
C Compiler (D.R.)	£49.95	£45.95	
Pascal MT/+ (D.R.)	£49.95	£45.95	
Money Manager (Connect Systems)	£23.95	£21.95	
Teleadd (Cavalier)		£21.95	
Invoicing & Stock Control (Cavalier)		£59.95	
dBase II (Ashton-Tate)	£119.00	£109.00	
Neword (Newstar)	£69.95	£65.95	
Multiplan (Newstar)	£69.95	£65.95	
Two Finger Touch Type (Iansyst)	£24.95	£21.95	
Crash Course (Iansyst)	£24.95	£21.95	
Datagem (Gemini)	£39.95	£35.95	
Hands on CP/M (Microcalc)	£21.95	£19.95	
Hands on Supercalc (Microcalc)	£24.95	£21.95	
Hands on dBase II (Microcalc)	£29.95	£27.95	
All Headline tutorials	£9.25	each.	

BOOKS			
Please enquire - largest CPC & PCW range in UK			
ALL DISCOUNTED			
HARDWARE			
	RRP	OUR PRICE	P&P
A.M.X. Mouse	£69.95	£65.95	
C15 Blank Tape x 10(*)	£4.00	£3.75	
CL1 (cassette interface lead)	£3.95	£3.25	
DDI 1 D/Drive(*)	£159.95	£155.45	£2.50
DL 2 (664 disc drive lead)	£6.95	£5.85	
DMP 1 Printer Ribbon	£6.50	£5.45	
DMP 1 Printer (*)	£159.95	£155.95	£3.50
FD1 Additional disc drive (*)	£99.95	£95.95	£2.00
LP1 Light Pen	£19.95	£18.95	
MP1 & 2 PSU (MOD *)	£29.95	£24.95	£2.00
PL1 Printer Cable	£9.95	£7.95	
RS 232 interface	£49.95	£45.95	£1.00
SSA1 Speech synth (*)	£29.95	£25.95	£1.00
ALSO a range of products by DKS, Cumana, DK Tronics & others			
Midi Music System			Ring for details
AMSOFT 3" DISC x 10		ONLY £37.95	
Lockable Rexel 3" Disc Box			Special Offer £16.50
At last a quality Disc Box we don't mind selling. Made by REXEL in brown with two keys, lift off cover and three dividers. It will take discs either with or without cases.			
DART LIGHTPEN	£39.95	£34.95	
PACE MODEM PACK (includes Commstar on ROM)	£172.50	£165.95	£2.00

CPC CASSETTE SOFTWARE			
	RRP	OUR PRICE	
Commando	£7.95	£6.95	
Countdown	£8.95	£7.55	
Doomsday Blues	£9.95	£7.85	
Frankie Goes to Hollywood	£8.95	£7.45	
Get Dexter	£9.95	£7.85	
Monopoly	£9.95	£8.55	
Moon Cresta	£7.95	£6.95	
Play Your Cards Right	£8.95	£7.45	
Saboteur	£8.95	£7.85	
Theatre Europe	£9.95	£8.65	
Thing on a Spring	£8.95	£7.55	
Tubaruba	£7.95	£6.55	
Turbo Esprite	£8.95	£7.85	
Cluedo	£9.95	£7.95	
Melt Down	£7.95	£6.95	
World Cup Carnival	£9.95	£7.95	
DISC SOFTWARE FOR CPC + PCW (*)			
2112 AD	£14.95	£12.95	
3D Clock Chess (for 8256) (*)	£19.95	£18.95	
Bridge Player (for 8256) (*)	£19.95	£17.95	
Fighting Warrior/Exploding Fist	£24.95	£19.95	
Forbidden Planet	£14.95	£12.95	
Friday 13th	£16.95	£13.55	
Heroes of Karn (for 8256) (*)	£17.95	£15.95	
Highway Encounter	£13.95	£10.95	
Macrocosmica	£13.95	£10.95	
Mastercalc 128	£34.90	£25.95	
Mini Office II	£19.95	£17.95	
Monopoly	£14.95	£12.95	
Office Master	£25.00	£21.95	
Office Mate	£17.50	£15.50	
Promerge	£24.95	£21.95	
Spindizzy	£14.95	£12.95	
Tank Commander	£14.95	£12.55	
Who Dares Wins II	£14.95	£11.55	
Hitchhikers Guide (for 8256) (*)	£29.95	£26.00	
Heavy on the Magick	£14.95	£11.95	
Cyrus II Chess (for 8256) (*)	£15.95	£14.95	

Find our latest prices on PRESTEL!!

UK: All prices include VAT and P&P in UK. Add P&P in brackets for hardware.
For Europe & Overseas: All prices exclude VAT & include P&P in Europe. Elsewhere add 50p extra for P&P hardware outside Europe add £2.50. **E.&O.E.**



DIAL A DISK

NEW

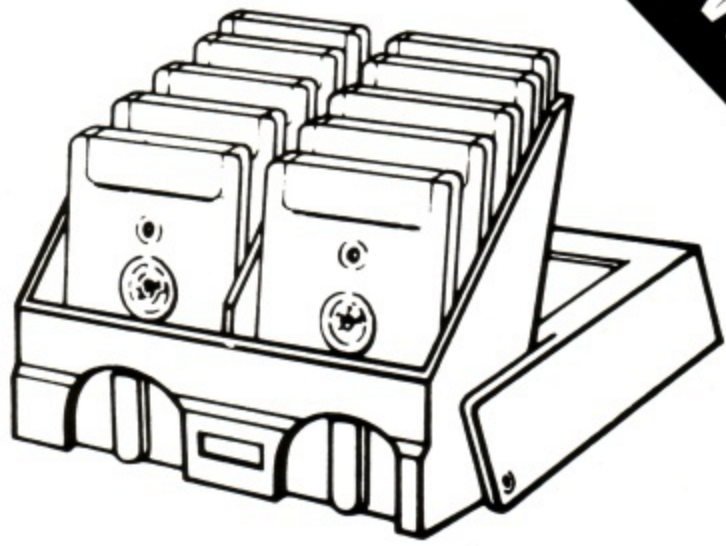

At long last a storage case to file 10 3" diskettes. Simply turn the levers at the front of the case and your 10 diskettes are displayed one above the other providing fast accurate access. This quality case is made in a strong black and white plastic and when closed provides a neat and dust proof environment for your valuable media.

£6.99 Inc. VAT, Packing & Carriage.

Available exclusively from SBS only.



24 HOUR CREDIT CARD HOTLINE

0273 726331 (10 Lines)

ACCESS AND VISA CARDS ACCEPTED

SEE OUR ADVERTISEMENT FOR AMSTRAD DISKETTES & RIBBONS ON PAGE 39

Please make cheques payable to:
SBS Data Services Ltd
Unit 3, Clarks Industrial Estate, Newtown Road, Hove, East Sussex BN3 7BA.
Telephone: Brighton (0273) 726331.
Telex: 878226.
Trade enquiries in writing please.

The Least Significant Bit

Sick as a parrot

When *ACU* received a press release about World Cup football we didn't expect much. Not because it would be a game which would be released to coincide with 22 men kicking an air-filled ball around a bit of grass somewhere in South America, but because games which rely on cashing in on something are not as inventive as those which have grown from the mind of a programmer.

Sometimes the game scores merely through its tie-in. The US Gold game is a slightly enhanced version of Artic's World Cup football of around six months ago, yet thanks to all the hype it shot to number one – even if a lot of disappointed players did then take the game back. It is understood that US Gold looked into buying the rights to Amsoft's Glenn Hoddle Football, but that fell through. Firebird messed up the Comet game by commissioning the program too late and believing that the programmer could make tight deadlines. They missed Halley's comet by one month or 74 years, depending on how you look at it.

Very few tie-ins actually manage to capture the spirit

of the thing they are cashing in on. The Rocky Horror Show managed it, so did Hitchhiker's Guide to the Galaxy, but things like *V* and even *Battle of the Planets* – albeit a great game – fail to capture the atmosphere of the main theme.

The best programs are those which are designed to make the most of the computer, especially those which are designed on the computer they are sold on – conversions are rarely better than the original. *Spindizzy* started life as an Amstrad program. It has now been converted to the Commodore 64 and Spectrum with plans to produce cartridges for the Nintendo games console – there are seven million of those in Japan – and maybe the greatest accolade of all – a *Spindizzy* arcade machine. Yet author Paul Shirley refuses to produce another *Spindizzy* with different rooms for fear of being accused of cashing in.

Spindizzy sells well because it is an excellent game. Budget games sell well because they are cheap but there is a whole range of programs which are good but go unnoticed, like *The Devil's Crown*. If that had been given a name like Simon Le Bon's *Underwater Adventure* with a huge advertising budget it would have been much more successful, but the game would have been no better.

It is a shame that some of the games which are pretty good suffer at the expense of those which are hyped trash. Occasionally a big name game flops – when players don't buy just on the strength of the cover – but the number of big names at the top shows that too often good marketing beats good programming.

ADVERTISERS' INDEX

A B Computers	88	Micro-Aid	88
Advanced Memory Systems	21	Micronet 800	59
Advantage	73	Micro Power	45, 80
Arc Education	88	Micro-Simplex Group	10
Ambyte	77	Microtext	86
Amsoft	4	Mighty Micro	86
Amstrad	2, 40, 41, 56	Mirrorsoft	35
Amstrad Distribution	52	MJC Supplies	80
Arnor	16, 36	Nemesis	52
Astrocalc	52	Ocean Software	39
Brunning Software	73	O J Software	86
Campbell Systems	78	Opus	14
Cascade Games	50	Panda Electronics	86
Cheetah Marketing	7, 73	Pride Utilities	20
Chiltern Computers (New Crown)	73	Printerland	32
Cirkit Distribution	52	Rational Solutions	86
Compatibility	88	RSC	13
Compumart	91	RSD Connections	80
CP Software	52	Sage Soft	49
Cyca	56	Saxon Computing	56
Digital Integration	55	SBS	39, 71
DK Tronics	92	SBS Data Services	86
EG Computer Graphics	83	School Software	86
Evesham Micros	72	Shekhana	80
Expert Systems	8	Silicon City	74
Garwood	46	Silly Software (Hardsoft)	86
High Voltage	9	Siren Software	89
Hisoft	87	SJB Disks	15
Initiator	83	Soft Insight	74
Interlock	83	Speedysoft	13
Jackson Computers	88	Squirrel's Byte	72
JPC Software	88	Tasman	60, 61
Kansas	88	The Village	74
KDS Electronics	71	Timatic Systems	62
Kempston Micro's	56	Transform	22
Lerm	83	Trinity Business Systems	52
Load & Run	89	Typeshare	74
Medstat	88		

Compumart

Megadeals

Amsoft Disks

**10 Amsoft
3" CF 2 Microdisks**

ONLY £32.00
Including VAT

**Limited
Offer**

Ribbons

**Printer Ribbons
For DMP 2000,
8256,8512**

Please Specify with Order

£5.50 ea.

FREE DELIVERY
Same Day Despatch

**ALL Prices
Inc. VAT**

Please send cheques/postal orders to:
Compumart, (DeptAM)
71 Gracedieu Road, Loughborough
Leics. LE11 0QF

24-HR CREDIT CARD ORDER LINE
Access
VISA
0509-233893

...COMPUTER...
0509-262259
HOTLINE...HOTLINE
HOTLINE

POWER BEHIND YOUR AMSTRAD

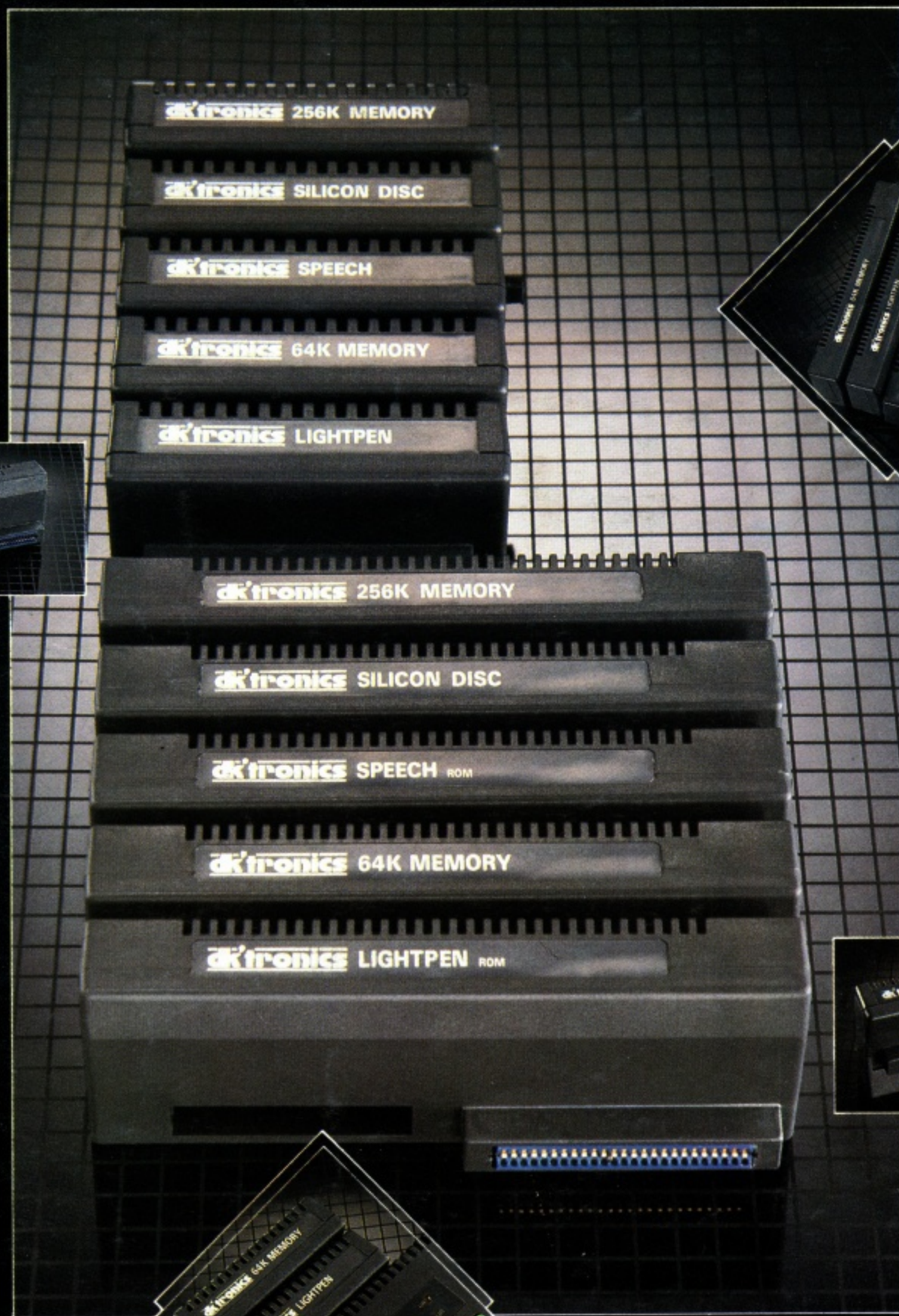

You can order by phone quoting your Barclaycard or Access number, orders are normally despatched in 24 hours.



DK Tronics products are available in all good computer stores. If you have any local problems obtaining them contact us directly.

dktronics

MANUFACTURERS OF POWERFUL PERIPHERALS

DK Tronics Limited
Englands Lane, Gorleston-on-Sea, Great Yarmouth, Norfolk NR31 6BE
Phone 0493 602926 (24 Hours), Telex 975408.