

OCTOBER 1989
£1.25

AMSTRAD COMPUTER USER

THE OFFICIAL AMSTRAD CPC MAGAZINE

THE LAST CRUSADE

INDY RIDES AGAIN

COMPETITION

WIN AN INDY HAT AND WHIP

GAMEPLAN

WE PLAY LICENCE TO KILL,
MIG-29, MINDTRAP AND MORE

REVIEWS

ACU JUDGES THIRTEEN
JOYSTICKS, AN ACCOUNTS
PACKAGE AND A DTP AID

THE REGULARS

FURTHER FUN WITH ALL THE
USUAL CREW

Best value for
your Amstrad

ISSN 0952-3049



9 770952 304006



THE POWER

TAITO COIN-OP HITS

'THE ARCADE COMPILATION OF THE YEAR'

Featuring:

RASTAN

CRASH - "Rastan is slick and compelling"

YOUR SINCLAIR - "So another spanker from Imagine. You'll be a fool if you miss it!"

SLAPFIGHT

COMPUTER & VIDEO GAMES - "Simple. Smooth. Very addictive.

A winner." ZZAP - "A superb arcade conversion and a great shoot 'em up. This is one for the ZAPPERS collection."

RENEGADE

COMMODORE USER - "As conversions go this still takes some beating - literally and metaphorically."

YOUR SINCLAIR - "The graphics are so slick you really feel you're part of an action movie rather than just playing a game."

ARKANOID

ZZAP 64 - "I thoroughly recommend Arkanoid - for the simple reason that it's simply gorgeous playing with it."

COMPUTER GAMES WEEK - "The take home message is simple. You want a great arcade game?"

FLYING SHARK

COMPUTER WITH THE AMSTRAD CPC - "This is an excellent game."

ACE - "Incredibly frustrating playable and addictive."

ARKANOID REVENGE OF DOH

AMTIX - "Excellent - can't fault it. A future number one."

YOUR SINCLAIR - "Immensely impressive and chronically addictive. A Classic."

BUBBLE BOBBLE

AMSTRAD ACTION - "It's a cracker. Definitely a game I should keep coming back to."

GAMES MACHINE - "Packed to the brim with entertainment."

LEGEND OF KAGE

CRASH - "One I won't put down until I get through to the next level."



CASSETTE: £12.95

CASSETTE: £12.95

CASSETTE: £12.95



TAITO

COIN-OP

Hits



PACKS!

**THE
IN-CROWD**
8 SPECTACULAR
GAMES IN
1 SPECIAL PACK



GRYZOR

"If you're looking for a high speed action-packed game that's good to look at and exciting to play - grab Gryzor now!" - Your Sinclair

BARBARIAN

"Its reputation for being the most bloodthirsty computer game ever, means that its phenomenal success will undoubtedly continue." - Sinclair User

COMBAT SCHOOL

"Combat School is brilliant - definitely the best arcade conversion around." - Zzap 64

TARGET RENEGADE

"If you're after some exciting beat 'em up action this is a good excuse to part with all your hard-earned cash." - Crash

CRAZY CARS

"Crazy Cars is a three-dimensional real-time simulation. This must be the ultimate car game." - Sinclair User

KARNOV

"Stunningly colourful screens ... the most accurate conversion of an arcade hit in years." - Your Sinclair

PREDATOR

"Predator is a superb tie-in and really hits the mark." - ZZAP! Sizzler

PLATOON

"Platoon is absolutely superb - a milestone in film tie-ins, and a yardstick by which all others shall be judged." - Zapp 64

GAME SET & MATCH 2

THE GREATEST SPORTS COMPILATION EVER

Score a goal, race on two wheels, compete in the Bob Sled, Ski jump, Slalom and downhill. Match strokes with Nick Faldo, make the winning break against Steve Davies but play a straight bat against Ian Botham, enter the arena in Track & Field as you compete in 100 metres dash, Long Jump, Javelin, 110 metres hurdles, Hammer Throw and High Jump and if that doesn't finish you off then throw jump shots against the basketball aces and go for a touchdown in the NFL Superbowl - then you can sit down ... in the cockpit of a Formula 1 racing car as you compete to take the chequered flag! Check out GSM 2 - the ultimate in sports compilations.



CASSETTE: £14.95



CASSETTE: £14.95



CASSETTE: £14.95

IN-CROWD

ean



ean

Note: SUPERBOWL and WINTER OLYMPIAD are not available on the AMSTRAD version

Gemini Zapping



AMIGA



ATARI ST



AMSTRAD



SPECTRUM

COMMODORE 64

VIRGIN GAMES • 2-4 Vernon Yard • 119 Portobello Road • London W11 2DX

AVAILABLE ON

- Atari ST £19.99
- Amiga £19.99
- C64 Cass £ 9.99
- C64 Disk £14.99
- Spectrum £ 9.99
- Spectrum +3 £14.99
- Amstrad Cass £ 9.99
- Amstrad Disk £14.99

Avralite Publications Ltd
Greencoat House
Francis Street
London
SW1P 1DG
Tel: 01-834 1717
Fax: 01-828 0270

Editor

Guy Matthews

Deputy Editor

Adrian Pumphrey

Chief Sub Editor

Harold Mayes MBE

Reviewers

Andrew Banner

Mark Luckham

Columnists

John Cook

David Foster

Vic Olliver

Phil Craven

John Kennedy

Designers

Paul Ellis

Adrian Hulf

Cartoonist

Julian Sharp

Advertising Manager

Clare Baxter

Advertising Sales

Sharon Green

Production Manager

Nick Fry

Production

Tanya Al-Rais

Group Editor

Carlo Jolly

Publisher

Perry Trevers

Managing Director

Peter Welham

Financial Director

Brendan McGrath

Chief Executive

Richard Hease

Subscriptions

Mike McKenzie

PO Box 74

Kent

TN12 6DW

Yearly rates:

UK £16.20

Europe £23.00

Middle East £23.30

Far East £25.90

Rest of the world £23.80

USA £41.65

Distribution

SM Distribution

Tel: 01-677 8111

Typesetters

Hamilton Press

Preston

Lancashire

Tel: (0772) 733333

Published on 1st Wednesday
preceeding cover date

Amstrad is a registered trade mark and, with the title Amstrad Computer User, is used with the permission of Amstrad plc. No part of this publication may be produced without permission. While every effort is made to ensure the accuracy of all features and listings we cannot accept any liability for any mistakes or misprints. The views and opinions expressed are not necessarily those of Amstrad or Amsoft but represent the views of our many readers, users, and contributors. Material for publication is accepted only on an all rights basis. We regret that Amstrad Computer User cannot enter into personal correspondence.

REGULARS

LETTERS 6

Your chance to take centre stage and tell us what is on your mind.

NEWS 10

Who is doing what, where and when? Read our news and all will be revealed.

MICRO-SCOPE 20

Trevor Cummings consults his crystal ball.

GAMEPLAN 31

The ACU game freaks give their verdict on the latest releases.

HAIRY HACKER 47

The Hacker lets out the clutch and roars through some great pokes.



10 LINERS 52

Small is beautiful with our mini programs.

AUNTY JOHN 54

Everything is relative as the Aunt shows us how to create Space Invaders.

DIRECT LINES 68

ACU's all new merchandising service brings the first of a monthly crop of bargains – from T-shirts to finance packages.

APPLICATIONS ADVICE 70

David Dorn sifts his mailbag for the best of this month's queries.

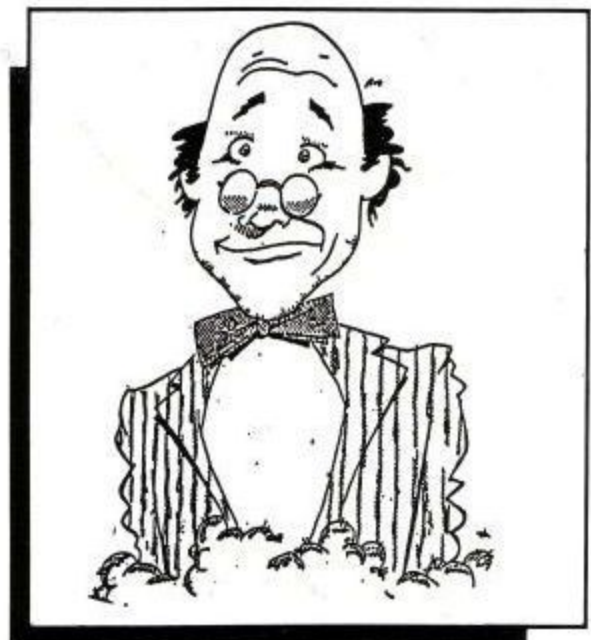

FEATURES

DTP REVIEW 24

Kenn Garroch reviews X-Press, an aid to the popular Stop Press DTP package.

FINANCE FOCUS 26

John Taylor goes over two money management packages from SD Microsystems.

NEW PRINTER 60

Mark Luckham discovers the joys of a bargain 24 pin printer.

JOYSTICKS GALORE 64

We locked Adrian Pumphrey in a room with 13 joysticks – and this was the result.

LETTERS

Cardiff calling

I am writing to enquire if the game *Elite* is available for the Amstrad? If it is could you tell me from whom I could order it or where in Cardiff I could buy it.

S. Mohammad,
Cardiff.

ACU: You are in luck. *Elite* is available on cassette from Microprose, 0666 504326.



Competition winners

The following five people are the lucky recipients of a Thunderbirds T-shirt and video.
Peter Hill, London WC1.
S.J. Lee, Huntingdon.
Miss D. Trent, Cambridge.
J. Puller, London N9.
P. Brockway, Leeds.

Happy owner

I am a happy owner of a CPC 464 and I am writing to you because I think your magazine is the best ever. Keep it up, please.

*Bjornare Ystebo,
Ytre Arna,
Norway.*

ACU: We will.

Frustrated

I have been an avid reader of the magazine for almost two years. My favourite feature is the listings but I cannot boast of ever having typed one in correctly first time. I used to have to check many a syntax error before I got them to work, which could prove very frustrating. With proofcode programs I could at least type in a listing and have it checked as I went along. To my dismay they seem to have disappeared. I think the magazine is great and I enjoy all the features, I think you have the proper balance but please bring back the proofcodes.

*G. F. McGeehan,
Thetford,
Norfolk.*

Kiwi plea

The arrival of the magazine in New Zealand is not very regular. Until the March issue type-in programs were being helped with the ACU proof-reader system; not for the last two months. Please put it back.

*R. M. Briscoe,
Auckland,
New Zealand.*

ACU: Because of popular requests from round the globe we have reinstated the proofcodes and they are here to stay. We have had many other enquiries about our listings and 10-liners. Many readers seem to be having difficulty getting them to work. This can be for a number of reasons – the program does not work, this is unlikely as we check each one;

there is a blemish on the page making a line illegible – that is our fault; the user or the machine is in error; the program works only on certain versions of the CPC. We intend where possible in future to alert readers to this. All those sending listings should indicate on which machines they work. Apologies to all who have suffered inconvenience; we are doing our best to eliminate errors in this popular part of the magazine.

A nice man

In the June issue several readers were having problems getting my *Meteor Storm* and *Arcade Tennis* 10-liners to work. Anyone experiencing any difficulties can write to me enclosing a tape/disc and a stamped addressed envelope and I will send working copies of all my 10-liners in the March, April and May issues – *Catch*, *Valentine*, *3-D Cone*, *Sounds*, *Arcade Tennis*, *Wordfinder*, *Meteor Storm*.

*David Hall,
12 Stothard Road,
Stretford,
Manchester M32 9HA.*

Is Vic there?

Commenting on Vic Barnes' letter in the August issue, I do not think magazines can be criticised for not warning of the difficulties which may be met in trying to run graphics programs on a 24-pin printer. It occurred to me when I was considering buying one that Qualitas might not work because the number and configuration of pins were different. Only by trying your software on a printer before purchase can you find whether or not it will work.

A partial answer to his difficulties might lie in the Brunning new *Brunword Elite*. From the advertisements it seems that it has Qualitas, or something very similar, built into it which will work with 9- and 24-pins. That would take care of his word processing, while the Infoscrypt with it would take care of his database. At £90 the cost is probably less than *Masterfile* and his three *Protex* programs.

*M. Catton,
Gosport.*

Video titling

I have an Amstrad CPC 6128 and would like if possible to use it for video titling with my VCR. Could you tell me how to make the connections from the computer to the VCR and what leads I would need? The VCR is Philips and has telephone plugs for Video in and Video out.

*I. Rayner,
Callington,
Cornwall.*

ACU: You can do video titling on your Amstrad if you use a digitiser which is available from Rombo Productions, 0506 414631.

Amused

While reading the August issue I was amused to read the letter from R. Conway of Middlesex. I, too, have recently bought an Amstrad CPC 6128 and I could not be more pleased with it. I would willingly recommend an Amstrad computer to anyone interested in buying a computer. Mine has given me no trouble. No matter what item or make you buy there is bound to be at least one which is faulty or gives trouble somewhere, so perhaps Conway is just unfortunate in that his computer slipped through the net.

As for being physically disabled I, too, am partially disabled following a serious neck operation, although I am pleased to say I am improving and will get better given time. I managed to get to evening classes run at the local school by our local college. They taught programming in Basic which, although useful, did not go into great detail. There we used BBC machines with a separate disc drive which were not so pleasant to use as the Amstrads.

If Conway would like to write to me I will try to help. Perhaps he could join the Amstrad User Club if not already a member.

With reference to John Cook's article, *Combat Zone Sweet Licks* was in the arcades in our area two years ago, with teenagers playing them the most.

*Miss H. J. Adams,
Boston,
Lincs.*

DATTEL ELECTRONICS

**MIDI
COMPATIBLE**

music machine

THE RAM MUSIC MACHINE IS PROBABLY THE MOST EXCITING MUSIC ADD-ON AVAILABLE FOR ANY COMPUTER.

- ▼ It's a full sound sampling system allowing any sound to be recorded digitally into computer RAM. Once stored the sound can be replayed at different pitches with many varying effects.
- ▼ It's an echo chamber & digital delay line. Create very interesting effects.
- ▼ Various sampled sounds are provided to get you going.
- ▼ The Music Machine can be used as a drum machine - eight drum sounds are provided, but you can easily produce more of your own.
- ▼ The powerful software allows you to compose tunes from individual bars of music. You can edit on screen & Save/Load sounds, instruments & rhythms.
- ▼ It's a two voice music/sound synth.
- ▼ Fully MIDI compatible. The Ram Music Machine supports full MIDI In, MIDI Out & MIDI Thru.
- ▼ Output through your Hi-Fi or Headphones. Comes complete with Microphone.
- ▼ Use a full size MIDI keyboard to play the Music Machine.
- ▼ Sounds produced by the Music Machine can be mixed with a MIDI Synthesiser's own sounds.
- ▼ On screen Sound Editor can produce MIDI data from your own compositions.
- ▼ No other product can offer so much in one unit - it's the total solution!!

**ONLY £49.99 (Cassette)
ADD £5 IF DISK REQUIRED**

**FREE
MICROPHONE AND
HEADPHONES!**



MEMORY EXPANSION

64K AND 256K MEMORY EXPANSION

- ▼ Simple plug in memory expansion gives instant extra memory.
- ▼ Features bank switching software for easy use by the programmer or for use as a data storage area.
- ▼ Ideal for use with the CPM 2.2 etc.
- ▼ The software also features some extra BASIC commands.
- ▼ 64K unit brings 464 up to CPC 6128 memory configuration making a much larger software base available. Will work straight off with many programs designed for this unit (including OCP Art Studio - see Ad.).
- ▼ 64K unit expands 464 to 128K. The 256K unit takes your 6128 to a massive 320K!!
- ▼ All bank switching done automatically by supplied software (cassette 464 - disk 6128).

ONLY £49.99

64K for 464

ONLY £99.99

256K for 464 or 6128 (Please State)

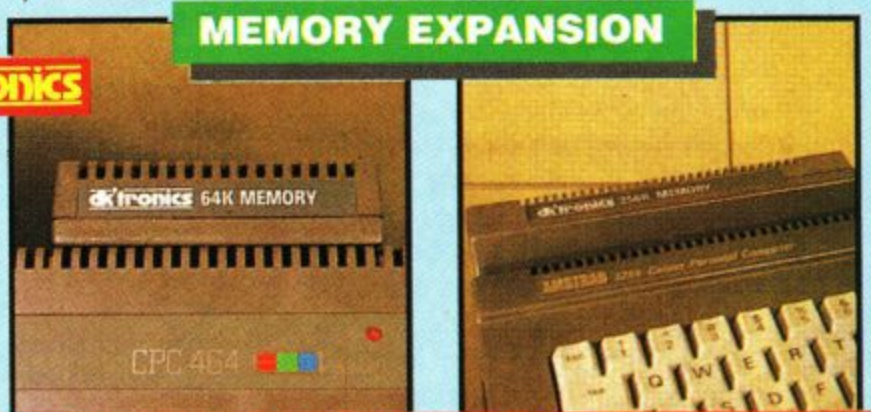

LIGHTPEN/GRAPHICS SYSTEM

- ▼ Complete Lightpen and graphics system lets you create a whole range of effects on screen.
- ▼ It can magnify, shrink, colour fill and create circles, rectangles, lines and curves.
- ▼ Pictures can be edited at pixel level using a scratch pad which is magnified to full screen.
- ▼ Picture storage and retrieval, and a pen calibration feature.
- ▼ Printer dump utilities for Epson/Amstrad printers supplied (on cassette).

**ONLY £14.99
CASSETTE**

OR £24.99

WITH SOFTWARE ON ROM -

NOTHING TO LOAD

464 or 6128 (Please state which)



REALTIME CLOCK

- ▼ A simple but highly useful device.
- ▼ Easy to use realtime clock - battery backed to give the correct time and date always.
- ▼ Also features extra 8bit I/O port for external control applications - very useful.
- ▼ Comes complete with full instructions and set-up software.

ONLY £19.99

464 or 6128 (Please state which)



SPEECH SYNTHESISER & STEREO SOUND BOOSTER

- ▼ This easy to use Speech Synthesiser includes a powerful Stereo Amplifier and two Pod Speakers which is a great improvement on the sound of the internal mono speaker.
- ▼ Using the SPO/256 Speech Chip the unit has an almost infinite vocabulary.
- ▼ Text to speech software is provided in ROM to make speech output simplicity itself.
- ▼ Voicing is transparent to the user and the computer can carry on with other program tasks.
- ▼ Speech output is mono directed to both speakers. Booster gives stereo to internal sound output.

ONLY £29.99

464 or 6128 (Please state which)



SILICON DISK 464/6128

- ▼ This is the fastest storage system available for the Amstrad CPC computers and is compatible with CPM 2.2, CPM+ and all DK Tronics peripherals.
- ▼ The 2516K Silicon Disk is designed to be used in conjunction with at least one normal Disk Drive attached to the system.
- ▼ When the 2516K Silicon Disk is fitted only 2K is used for the Silicon Disk directory, leaving 254K for storage - that's 70K more than a normal Disk Drive.
- ▼ Data and programs can be exchanged between Silicon Disk and normal Disk, application programs can then work on their data at vastly increased speeds. Software is on ROM (nothing to load) and can be used in two modes - Basic under AMDOS with normal LOAD, SAVE CAT MERGE commands etc. and within CPM 2.2 CPM+ where commercial programs are designed to run on multi-drive systems.

ONLY £129.99

464 or 6128 (Please state which)

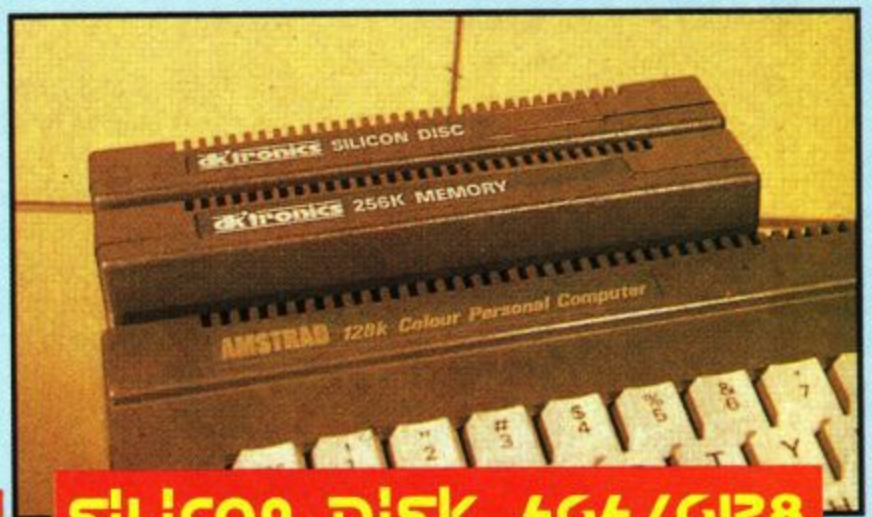

DATTEL ELECTRONICS

THE ULTIMATE GRAPHICS PACKAGE...

SPECIAL OFFER PACK!

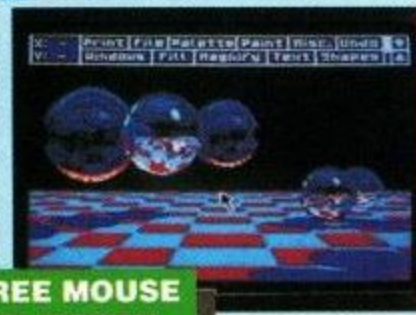

INCLUDES FREE MOUSE MAT/HOLDER WORTH £12.99

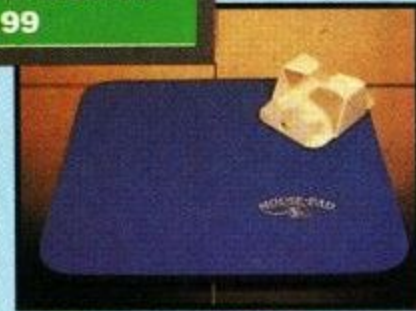

Genius Mouse

COMPLETE WITH

OCP ART STUDIO™

- ▼ Genius Mouse is a high resolution two button mouse featuring optical counting, teflon guides, microswitches, rubber coated ball and high quality interface.
- ▼ When combined with OCP Art Studio this graphics package is quite simply the best system available. The features are unmatched...
- ▼ Create an image - shrink it, expand it, move it, rotate it, copy it, colour it etc., etc.
- ▼ Spray patterns or shades, make elastic lines - stretch and manipulate shapes.
- ▼ Zoom in to add detail in fine mode.
- ▼ Pulldown/icon driven menus for ease of use.
- ▼ Mouse operation, plus joystick and keyboard control.
- ▼ 16 pens, 8 sprays, 16 brushes - so flexible anyone can create superb graphics easily.
- ▼ Full cut and paste facilities plus excellent printer support.
- ▼ Pixel edit, font editor, flip, invert, rotate, solid or textured fill and professional manual make Art Studio simply the best graphics package for the Amstrad CPC.

ONLY £49.99
TOTAL PACKAGE INCLUDING GENIUS MOUSE/INTERFACE MOUSE MAT/HOLDER AND OCP ART STUDIO

TAPE OR DISK FOR 464 OR 6128 (PLEASE STATE WHICH REQUIRED) N.B. 464 NEEDS DK' 64K RAM PACK

NEW SLIMLINE DRIVE

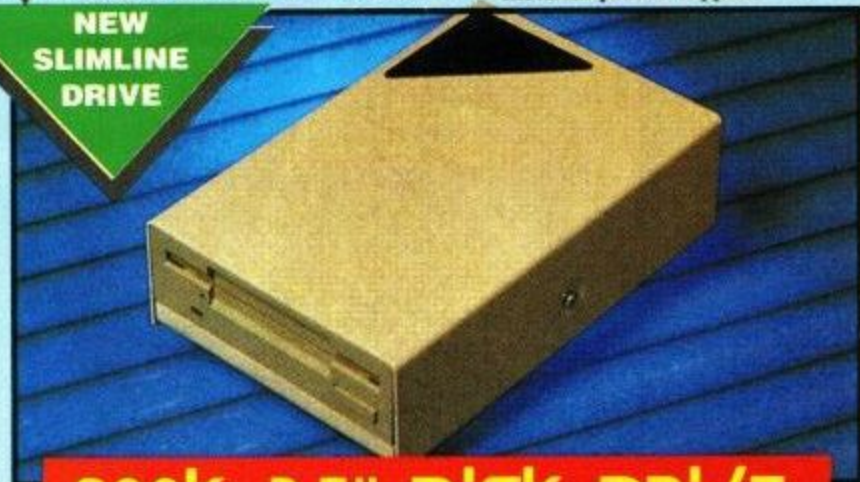

800K 3.5" DISK DRIVE

- ▼ Now you can add a superb top quality 3.5" drive to your CPC Amstrad.
- ▼ 800K of data storage on disks that cost less than £1.00.
- ▼ No need to flip disks.
- ▼ 3.5" disks are fast becoming industry standard.
- ▼ Comes complete with power supply and cables.
- ▼ We supply our drive with the RODOS operating system, giving not only this vast disk capacity but also over 50 new bar commands plus a printer buffer, etc.
- ▼ Easily fitted - full instructions.

464 owners must already have at least one Amstrad drive.

Only £119.99 for Drive and RODOS including PSU/Cables

- ▼ Turn your Amstrad Monitor into a full feature TV set with our TV Tuner System.
- ▼ Latest chip technology gives crystal clear reception on all channels.
- ▼ Built-in speaker.
- ▼ On/Off volume controls.
- ▼ Brightness and colour controls.
- ▼ Channel selector.
- ▼ Attractively styled to match your computer.
- ▼ Why not realise the full potential of your monitor?

ONLY £69.99

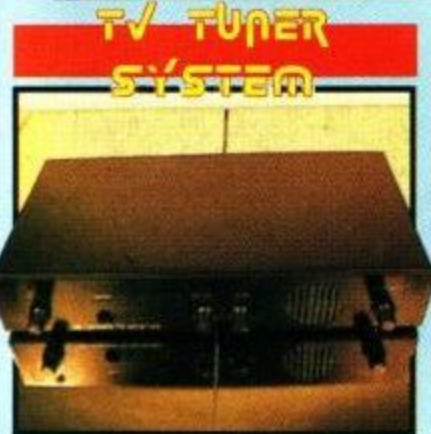

PCW 8256/8512

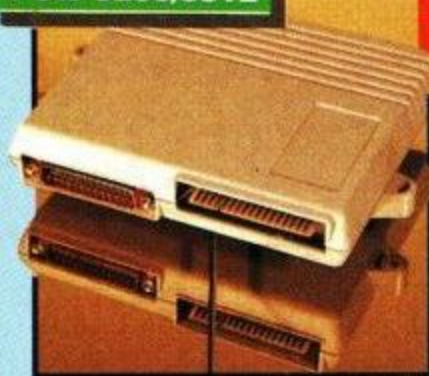

PCW 8256/8512 COMMUNICATOR

- ▼ Complete RS232 and Centronics/Parallel interface for the PCW Amstrad.
- ▼ Simply plugs into rear expansion slot.
- ▼ Attractively styled in computer colours.
- ▼ Full instructions supplied.

Only £49.99 complete

ALL ORDERS NORMALLY DESPATCHED WITHIN 48 HRS

HOW TO ORDER ...

BY PHONE



0782 744707
24hr Credit Card Line

BY POST



Send cheques/POs made payable to "Datel Electronics"

FAX

0782 744292

UK ORDERS POST FREE
EUROPE ADD £1
OVERSEAS ADD £3

PRICES AND SPECIFICATIONS CORRECT AT TIME OF PRESS AND SUBJECT TO CHANGE WITHOUT NOTICE

CALLERS WELCOME - Please reserve goods by telephone prior to visit.

DATTEL ELECTRONICS

DATTEL ELECTRONICS LTD., FENTON INDUSTRIAL ESTATE
GOVAN ROAD, FENTON, STOKE-ON-TRENT, ENGLAND.

SALES ONLY
0782 744707

TECHNICAL ONLY
0782 744324



The Python team - Cleese, Gilliam, Jones, Chapman, Palin and Idle.

Python's parrot revived

A nudge is as good as a wink to a blind bat and you don't need me to tell you that a game based around the zany exploits of the Monty Python team is a sure winner.

Virgin Mastertronic also hold this view and plan to release the game early next year to coincide with a "best of Python" series that will be running on television. Two memorable sketches to be included in the game are, The Ministry of Silly Walks and The Dead Parrot Sketch.

players will enter the computerised 3-D world of Larry. This computerised world has been created by Incentive Software using its Freescape programming system which allows a player total freedom of movement within the computer world.

Anyone interested in taking the Enigma Challenge should write for an application to: Broadsword Television Productions, Anglia TV, Anglia House, Norwich NR1 3JG.

Showing out

The Computer Shopper Show is set to be the Amstrad event of the year. Database Exhibitions is organising the

show and Computer Shopper is sponsoring it. Over 100 of the stands will sell CPC, PCW and PC products making this show a major league Amstrad event.

The show is to be held at Alexandra Palace from November 24th to the 26th.

A magazine on the move

Action Screenplay, the video magazine for computer users, is planning a series of interviews with industry celebrities starting with Mark Strachan and Dominic Wheatley of Domark.

The magazine, which sells for 4.99, aims to show readers of regular computer magazines what their heroes look like in the flesh.

Hotshot, the company behind Action Screenplay, believe the extra dimension that video brings will tempt computer buffs to add the publication to their usual magazine shopping list.

Hotshot boss Jon Beales said "A lot of the people who work in this industry have great personalities and the video medium is best for letting this come across. Action Screenplay provides information for games players when assessing products by capturing animation and sound. If people use both magazine and video they need never be disappointed with a game when they get it home."

Save the world in 3-D

Broadsword Television Productions the company behind Nightmare is looking for contestants for its latest creation, The Satellite Game.

Your task is to guide Larry the robot through the Enigma Challenge which has been set by an alien race to determine humanity's right to a continued existence. When in combat the



The Satellite game.



with agile minds", pits the player against the clock to answer questions on subjects including sport, entertainment, and geography. The object is to move around a board and be first back to the Hi Q Base. The game is available for the CPC priced £1.99.

For information ring Blue Ribbon on (0302) 321134.

Storing

Compumart has gone one step further into the disc storage market with the AMS 30L Deluxe. The disc box has a capacity of 15 cased or 30 uncased discs. The box has an improved hinge system and comes with two keys.

The AMS 30L Deluxe retails for £14.95 and is available from Compumart (0509) 610444.

Printer blues

A user group has been established dealing exclusively with computer printers. The group is the brainchild of Nick Godwin, founder of the first UK printer ribbon re-inking service three years ago.

Godwin envisages the group's activities ranging from a newsletter, meetings, chain letters, an advice hotline and a swap-shop.

He said "There are many problems and pitfalls involved with using computer printers. There is now a need for a user group to be concerned with this important peripheral."

Interested parties should write to Write on Line, 4 Hurkur Crescent, Eyemouth, Berwickshire TD14 5AP.



Storage City, Arizona.

Version city

Qualitas Plus Version 2 is now available. Not only has the manual been improved but special loaders for Masterfile III and Protext/Promerge have been included.

The previously user-defined codes for turning Qualitas on and off have been replaced with ordinary text characters of the user's choice. Further improvements include the font editor with its extra commands for the character editor.

Qualitas Plus Version 2 costs £16.95 although upgrades from version 1 will be cheaper.



More trivia

Blue Ribbon has released a game for quiz buffs who have not yet reached saturation in the pursuit of trivia.

The curiously titled Hi Q Quiz, billed as "a brain testing game for those

Mastertronic gets well 'ard

Virgin Mastertronic, exponent of the budget game, is moving into a new market - that of user wear. For the princely sum of £4.99 you can get your mits on a "well 'ard" T-shirt featuring a man with a rather large weapon, drawn by Jamie Hewlett of Tank Girl, Swifty and Judge Dread fame, and the forementioned text. The T-shirts are available from computer stores or direct from Virgin Mastertronic, 2-4 Vernon Road, London W11 2DX.



INDIANA JONES- THE LAST CRUSADE



We can't all be Indiana Jones but thanks to U.S. Gold we can now share in his exploits with the game and look like him with this fabulous prize of a hand made Indiana hat and a whip plus a T-shirt and a copy of the game.

Sounds great so far, but hang on what about the runners-up. Twenty five of you lucky people will receive an Indy T-shirt and a copy of the game. All you have to do is answer the three simple questions below and don't forget to state whether you require a cassette or disc version.

- 1.** Name all three Indiana Jones films?
- 2.** Name the actor who plays the father of Indiana Jones?
- 3.** Name the character played by Harrison Ford in the film Star Wars?

KNIGHT FORCE



TITUS™

UNIT 4 STANNETS LAINDON NORTH TRADE CENTRE BASILDON ESSEX SS15 6 DJ - PHONE : (0268) 541 126

© 1988 TITUS. KNIGHT FORCE, TITUS AND THE TITUS LOGO ARE REGISTERED TRADEMARKS OF TITUS

BrunWord 6128 £30

BrunWord 6128 is specially written for the Amstrad CPC6128. Months were spent just optimising the routines into their smallest, most efficient form. The result is the fastest, most convenient word processor for this computer, complete with the fastest spelling checker and a card filing programme for mail merging. Whether you are writing a few letters or a complete novel, you will find no better assistant than BrunWord.

The word processor, spelling checker and 30,000 word dictionary, are all loaded into memory by typing RUN "BRUNWORD". The disc drive is then completely free for your data disc.

All other word processors, even the ROM versions, need to access the programme disc to test the spelling. (ROM versions have the dictionary on disc). This is slow and can involve many disc changes. For example, Protex needed the disc to be changed eight times to check the spelling of our test file, whereas BrunWord needed no disc in the drive.

The 40 page BrunWord manual has several detailed examples, starting with step by step instructions to produce and print a simple letter. But your very first step is to load the TUTOR file into BrunWord. This takes even the complete novice straight into word processing and demonstrates the powerful editing and formatting features of BrunWord. There are also examples of printer control, showing how to create headings, to underline or to emphasis, and five deliberate spelling errors for you to correct. The tutor takes about 20 minutes to run through and after that you will feel confident to type in your own text.

BrunWord Features

*40, 80 or 128 column display *Touch typing speed over 200 words/min *True insert or overwrite *Justify or unjustify paragraph or whole text *Justified text has balanced appearance *Instant word wrap *Block save, move, copy, insert and delete *Local editing with word delete/undelete *Adjustable margins and TABs *Column/Line/Page display with file name *True word count *Find and replace *Help menus *Memory filing system *Single character embedded printer commands (18 with 3 printer codes and 21 with 10 printer codes) *Page throw markers *Multiple copies *Odd/even page headers/footers with page numbers *Multi file printing (new page or continuous) *Print specified pages *Works with any printer *True display superscript and subscript numbers *User defined print characters *Load ASCII files from other word processors *Save ASCII files for other word processors *Files can be encrypted *Maximum file size about 9 pages of text.

BrunSpell Features

*Memory resident with word processor *Checks 4,000 words/min *30,000 word dictionary *No American spellings *Add up to 5,000 of your own words *Instant lookup *Helps to find correct spelling *Automatic correction.

DataFile Features

*Alphabetical, numerical, date sorting on any field *User defined headings *Search routine *Data merging into BrunWord *Label printing.

BrunWord Junior

Low cost version of BrunWord 6128 on 3 inch disc, including the spelling checker, 30,000 word dictionary, TUTOR file and manual. Holds just one page of text and cannot save words to the dictionary. Otherwise as BrunWord 6128. Cost £18. Up grade later to BrunWord 6128 for £14.

Tasword Upgrade

Send your original Tasword 6128 disc (not the packing or manual), and £23.00. We will return your programme together with the full version of BrunWord 6128 with BrunSpell and DataFile.

BrunWord

Info-Script £50

The great power of any database is only realised when the data can be put to use. A database system is centred around saving, sorting, finding and displaying the data. Obviously, very essential features but only if there is a purpose to storing the data. That purpose might be names and addresses for mail merging, a stock list of items being sold that generates a buying list, a catalogue of your compact disc recordings so that you can take a printout with you to the shop, a catalogue of recipes so that you can have a print out in the kitchen of the in-season treats, a catalogue of garden activities that gives you a reminder list to hang in the garden shed.....

The common element being the need to take the data away from the computer, in a form that suits your immediate requirement.

We gave considerable thought to this and concluded that the only solution was a proper text handling system within the database itself. In other words, a word processor. We looked into designing a special word processor but quickly realised that BrunWord, with its memory filing system, is ideal.

This is the exciting concept of Info-Script. A comprehensive relational database integrated with a powerful word processor, giving total flexibility to the way that the data is printed. A fast, user friendly combination that has the depth of power to keep up with your needs. A mail shot, a restaurant wine list, a summary of expenses.....

BrunWord Upgrade

Send your BrunWord 6128 disc, BrunWord manual (not the packing) and a cheque for £22.00. We will record Info-Script, test the disc and return with a new manual.

BrunWord Elite £90

A superb programme which has printed this advertisement but the release date has been put back while we resolve problems with certain 24 pin printers. Meanwhile don't despair, buy Info-Script.

Our booklet BrunWord & Printer will need a few changes to the conclusions, so is also delayed.

Comparisons

We have tested BrunWord 6128, Protex (disc) and Tasword 6128 with the same file of 3366 words.

BrunWord scrolled 40% faster than Protex which in turn scrolled 19% faster than Tasword.

Protex was the fastest to justify but needed a separate operation to see the result. BrunWord produced the best appearance of all three and was 30 times faster than Tasword.

Our simulated typing test reached 218 words per minute. Both BrunWord and Protex had no trouble at this speed but Tasword was very slow inserting text into the start of a paragraph and could only handle 16 words per minute.

The spelling test checked all 3366 words. BrunSpell took 52 seconds and needed no disc changes. Prospell took 6 min 24 sec and needed 8 disc changes. Taspell took 18 min 46 sec and needed 3 disc changes.

100 Letters £15

This is a utility for use with Info-Script. It is supplied with over 50 pre-written letters and has a special format that will allow you to add hundreds of your own letters.

For example, you want to place a 'Wanted' advertisement to buy another CPC6128. Insert the Info-Script disc. Type RUN "INFO". Insert your data disc and load your name and address file. Insert the 100 Letters disc. FIND the 'Yellow Advertiser' record from your own file (now in memory). Type LET072 into the ACTION field and CPC6128 into field 17. Press T for Transfer. Info-Script will load letter 072, personalise it with the address of the paper and insert the 'Wanted' item. The letter is then in the word processor and can be edited in the normal way to be exactly what you want, and then printed out. When that is done press <ESC> * and you are back in Info-Script, with the 'Yellow Advertiser' record still selected, ready to address the envelope. You can write as many letters as you like without changing the disc and you will never wait more than a few seconds.

100 Letters is supplied with an operating manual which takes you easily into writing letters and explains, in simple terms, how to create your own letter patterns. An average CPC6128 owner, using easy patterns, can expand the library to about 100 letters but there is no limit.

Letters

I am extremely interested in the sound of your Info-Script. However, as the cost is £50 I am somewhat hesitant in purchasing and would therefore be grateful for any further literature. I am presently using Protex on ROM with Promerge and Pro-filer, but accessing Pro-filer is incredibly slow and long winded. Your advert would indicate that access time to stored data is much superior. Mr G (Nottingham).

Thank you for my recent copy of Info-Script. My euphoria has nearly died down now - it is superb. It is a big improvement on my Protex and Pro-filer in that it combines the two with vastly superior speed and is exactly what I need. Mr G (Nottingham).

May I take this opportunity to express my appreciation of BrunWord. My son has been the main user. After years of torture in school with pen in hand, the use of the word processor enabled him for the first time to concentrate upon the substance of what he wanted to write, and return later to correct and organise. The net result is that a young man who formally struggled at school and hated it, now accomplishes the written components of his course with ease and satisfaction. Mr G (Sutton Coldfield).

I have found it (BrunWord) a very easy word processor to use, and the more I use it the more I like it. The same goes for Info-Script, the more I use it the easier and more flexible it becomes. Mr L (Australia).

Please supply BrunWord 6128. I have both Tasword (used for his letter) and Protex. Why do you think I deserve the discount offered..... my age 76. Mr S (Glasgow). (see ACU Aug 89)

Send cheque/PO/Access number/Visa number to:

Brunning Software

34 Helston Road,
Chelmsford, Essex, CM1 5JF
Telephone (0245) 252854 (24 Hours)



BrunWord 6128 with BrunSpell & DataFile. . . £30.00
BrunWord 464 with BrunSpell & DataFile. . . £25.00
BrunWord Junior 6128 with BrunSpell. . . . £18.00
Info-Script 6128 with BrunWord & BrunSpell. . £50.00
100 Letters (needs Info-Script). £15.00
BrunWord Elite and Info-Script include backup disc.
(All supplied on 3in Disc - state which computer)

All prices are inclusive for UK. Overseas orders sent insured air mail - Europe add £2.50 : Rest add £7.50

The effect of a major electrical event, such as a lightning strike, on sensitive computer equipment is commonly known, however, even relatively small surges or 'spikes' caused by a wide variety of commonplace electrical appliances can corrupt data or even damage hardware.

Bowthorpe EMP Ltd are leading specialists in the field of clean power and, in conjunction with their experts, we have selected three of their products which will give you the fullest possible protection for your equipment and data — at home or work.

For inexpensive protection against surges and spikes we are offering the single plug at £11.95, ideal for combination units or the four-socket strip at only £16.95.

Apart from the problems of other electrical equipment interfering with your computer — you also have the problem of your computer interfering with other electrical equipment!

For example, emergency services radio transmissions of the VHF/FM waves bands.

EEC regulations, now in the pipeline, will insist on high standards of suppression and the Bowthorpe Filter adapter at £29.95 has been chosen by us to get you ahead of the game.

Like all our offers to readers, its price is INCLUSIVE of delivery to the U.K. Mainland and V.A.T. at the current rate.

To take advantage of this special offer of three very useful and potentially valuable devices please fill in the attached coupon and return it to us.

To: 'Amstrad User' Electrical Protection Offer,
Focus Magazines, Greencoat House,
Francis Street, London, SW1 1DG.

Please send me Surge Protector Plug(s) @ £11.95 each.

Please send me Four Socket Strip(s) @ £16.95 each.

Please send me Filter Adapter(s) @ £29.95 each.

Total paid:

Name:

Address:

Payment: Credit Card — Visa/Access/Mastercard/Eurocard Expires: ___/___

Card No.:

Cheques: Payable to Avralite Ltd.

Please allow 28 days for delivery. Offer closes 30th. September, 1989. Offer applies to U.K. only, cost of delivery Overseas on application.



NEW

Jackson Software

BFG DATAFILE

CPC 464 – 664 – 6128

Fax Available – Ring 0228 42373

Disc £15.95 Cassette £10.95

Cheques/PO payable to:

Jackson Software (1989) Ltd

Unit 32, Carlisle Enterprise Centre, James St, Carlisle CA2 5BB

Access/Visa available shortly

LERM SOFTWARE - 280c TOOLKIT.

THE UTILITY FOR ALL MACHINE CODE USERS - ONLY £9.99

"Excellent value for money", "Brilliant package", that is what Your Sinclair said about the Spectrum version of our Toolkit, now available for the Amstrad 464, 664, and 6128. 3 programs in 1. Copies to disc. HAS OUR FULL MONEY BACK GUARANTEE - NOTHING TO LOSE!

- * SUPERB ASSEMBLER - full screen editor - like a word processor. Very fast - has its own monitor.
- * TOOLKIT - shows what happens to registers when running M/CODE, plus disassembler, debugger, etc.
- * CTOS - reverse assembler - changes machine code back into a source file - relocate your M/CODE!

IDEAL FOR BEGINNERS. MANY UNIQUE FEATURES. INCLUDES HEX/DEC, LOADER MODE, SINGLE STEPPER. HALF THE PRICE OF MANY RIVALS! SEE FOR DETAILS. ALL INCLUSIVE PRICE.

LERM, DEPT AC, 11 BEACONSFIELD CLOSE, WHITLEY BAY, TYNE AND WEAR. NE25 3JW. TEL 031-2533615.

STRATEGY SOFTWARE

Strategy games for the Amstrad CPC

THE FINAL CONFLICT — the game is a conflict between Nato and the Warsaw Pact in Europe. Options are either two player or solitaire against the computer. 25 different countries involved, over 160 units, infantry, corps, parachute, armoured, cities helicopters, different strengths, effects, supplies, fuel, casualties status, different seasons, city production levels, millions of troops involved, game lasts for weeks, save game, 18 page manual plus more.

SOCCER 6128 — football strategy game which lets you manage any team in the 4 divisions. Options are buy players, sell players, league programme, fixtures, opposition, play match, instructions, league table, accounts, playing staff, save game, 10 different positions, skill, form, goal scorers, injuries, up to 20 players in squad, sacking, over 2000 players, 80 English clubs, 60 European clubs, FA Cup, League Cup, European Cup, UEFA Cup, Cup Winners Cup plus much more. Reviewed in AMSTRAD ACTION July '88.

KURSK the clash of armour — was the biggest tank battle of WW2 in which the Germans had to beat the Soviet army to stand any chance of winning the war. The options are two player or solitaire against the computer. There are over 125 units which are infantry, armoured, corps, artillery, anti-tank plus cities which all have different effects in combat. There are also supplies like troops, provisions and fuel. The object of the game is to capture the key cities or destroy enemy units. Also save game plus much more.

SOFTWARE HIRE CLUB — we hire out top game titles of strategy and simulation games for the Amstrad CPC. Send a large S.A.E for details.

Title	disk	tape
THE FINAL CONFLICT.....	£8.00	£7.00
SOCCER 6128 For 6128 only.....	£8.00
KURSK the clash of armour.....	£8.00	£7.00

Cheques or Postal orders Payable to STRATEGY SOFTWARE

Send to: STRATEGY SOFTWARE, 32 Albert Street, Seaburn, Co Durham SR7 7LJ.

STOCKMASTER

THE Stock Control System for the Amstrad range of computers

Stockmaster is a highly advanced stock control system ideal for the shop/business with up to around 1,200 stock items. It runs on the CPC 6128/PCW computers, and is fully menu-driven, making it extremely easy for even the absolute beginner to use. It incorporates a highly advanced ordering 'automated' system, allowing orders to be printed in a format suitable for direct mailing to the supplier indicated. File updating is done by a separate batch program, which may be run at a quiet point in the day.

Its file sizes are limited only by disc drive capacity, allowing the system to grow as your company grows. Options also exist to print various reports, to calculate total stock value etc. etc. **STOCKMASTER** is supplied complete with a detailed 43 page user manual, and requires CP/M Plus to run. Send SAE for more details. 'Hurry!' order your copy now by sending a cheque/P.O. for £29.95 to:

Williams Software Services
11 Howard Close, Romiley, Stockport, Cheshire SK6 3BH
Tel. 061-430 5307. Please allow 21 days for delivery

COMBAT ZONE

Go ahead, make his
day. John Cook goes
over the top in
arcade territory.

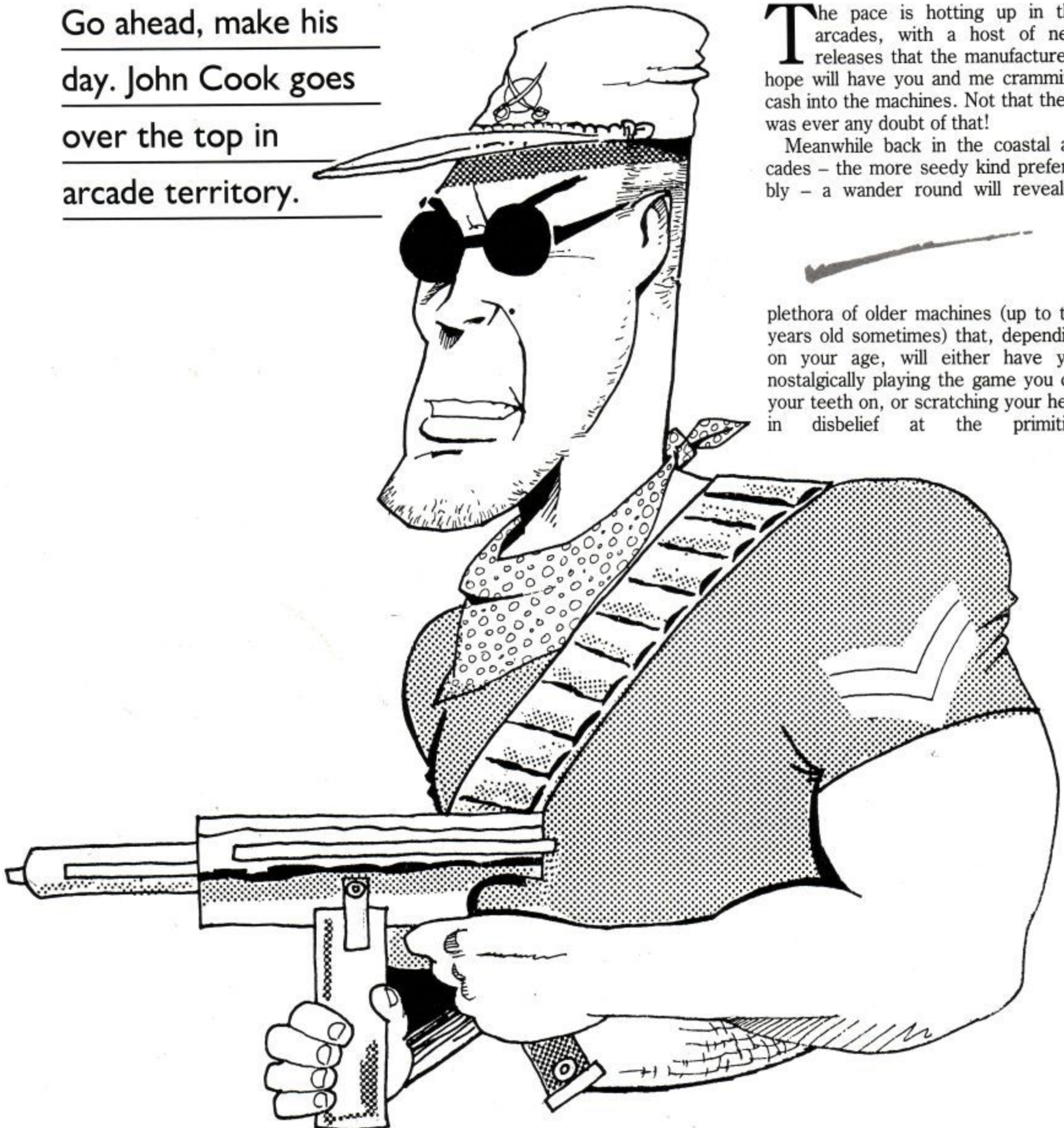

The pace is hotting up in the arcades, with a host of new releases that the manufacturers hope will have you and me cramming cash into the machines. Not that there was ever any doubt of that!

Meanwhile back in the coastal arcades – the more seedy kind preferably – a wander round will reveal a

plethora of older machines (up to ten years old sometimes) that, depending on your age, will either have you nostalgically playing the game you cut your teeth on, or scratching your head in disbelief at the primitive



Willow.



Golden Axe.

graphics . . . wondering how anyone could ever get a kick from playing them!

Ten years sure make a difference. Take Defender, for example, a recognised classic. One of the most successful machines of all time, being the first of the second generation machines, coming after Invaders and Pong.

6809 chip, eight colour screen, less than 64K Ram. Nowadays, if a game has less than 1 Meg of Graphics data, 128 colours out of a palette of thousands, two 68000 chips and vast

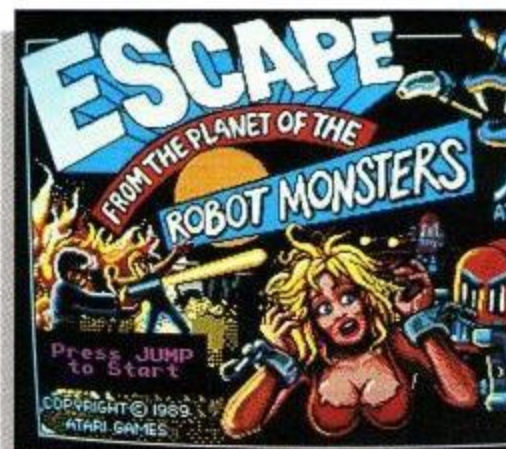

Escape from the Robot Monsters.

amounts of sampled sound – it ain't no good! Come back Juno First (my favourite oldie – borrowed by Jeff Minter when he programmed Gridrunner), all is forgiven!

Perhaps the most interesting of these modern graphic tour de forces this month is a new game from



Secret Agent.

Capcom, called Willow! Do you remember the movie, more famous for its merchandising than the original cinematic release?

The soft focus fantasy plot has a Hobbit-like character trying to save the land from the clutches of an Evil Queen, who has captured a saint-child who is destined to lower income tax, privatise everything in sight, and generally banish all things nasty from sight. Naturally, the tasks are Herculean, and the odds of you not working out what happens before the first

reel ends, high. The good news is that the coin-op is better than the movie!

Using the new Capcom 'mega-board' (the one that cost the GNP of a small South American country to develop), not surprisingly the graphics and sound are impressive, creating a cutsie fantasy environment.

You start off playing the Hobbit-like character, and the game soon reveals itself to be a sideways scrolling jumpy-jumpy, shooty-shooty variant. The controls are simple 8-way joystick controlling up/down, left/right, with fire and jump buttons controlling



Crime Fighters.

those functions. Leave the fire button pressed down for a short time and your fire gets more powerful for that particular shot – as in Nemesis-like games.

Shoot the soldiers that get in your way as you stroll through the countryside and collect the spinning coins that are left behind. It is these coins that you can exchange for extra powers/protection at the shops you'll find along the way.

Make it across a rope bridge, zap the nasties, and you'll find yourself up against a huge end-of-level nasty that grows from a small blue pig to . . . a

rather large fire breathing blue pig, which you have to try and take out.

Beat him and you find that you've freed a brave warrior who will help you on the next level – in fact you soon find yourself in the middle of a tavern brawl controlling him! Jump out of the

upstairs window and you are on the back of a car – driven by the Hobbit – careering through the countryside, and assailed by mercenaries on horseback and trained 'bomber' eagles! It's all go!

As you might gather, there's nothing particularly new about Willow, it's a mainstream release that is designed not to offend, competent rather than inspiring. Still, if you have an affinity for small people with furry feet, you might find yourself drawn into the atmosphere of the thing. Worth a try, shall we say?

I wouldn't say that of Crime Fighters – a newie from Konami. How many beat-em-ups based in the New York subway system have we had now? Do we really want, or need, another one with titchy sprites and the same old slash 'em-up gameplay? No thank you matey – as far as I'm concerned. Avoid!

We talked about a fab PC release from Sega called Golden Axe last

month – well I've been playing that quite a bit over the last 30 days and waddya know? I finished it last week! Mind you, after the third level – set on the back of a massive eagle – it starts to get really difficult, with huge metallic knights moving fast as lightning

and needing more than a few hits before falling.

The final scene has you slugging it out against Death-Adder himself, while the King and Queen that you have set out to rescue are hanging up by their heels in the background!

If you manage to dispatch The Big Guy, they are set free . . . Then the game goes into a novel victory sequence which shows you playing the machine in an arcade – it blowing up – and all the enemy sprites chasing you out into the street and across the city.

Now there's something interesting here. In that scene, when it shows you a shot of the cabinet, the name of the game shown on the attract display above the unit is not Golden Axe, it's something else!

To help you along, I've got a few hints. You'll notice that each of the three characters in Golden Axe (you have to choose one) has different magical powers. Dwarf has Lightning

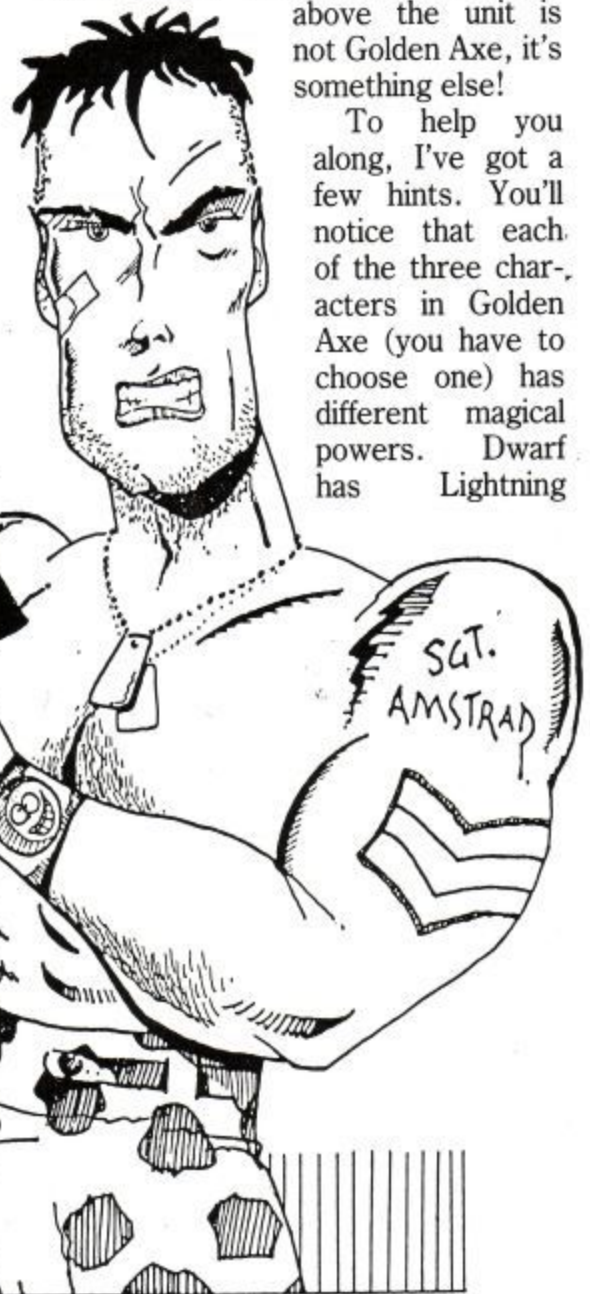

... WE JOIN OUR HEROES ON THE SURFACE OF PLANET X WHERE A RESCUE MISSION IS IN PROGRESS.

ORBITING PLANET X

BEAM UP SURVIVORS!

THE REPTILONS HAVE ENSLAVED HUMANS STATIONED THERE.

THEY ARE BEING USED TO CREATE AN EVIL RACE DESTINED TO BIRTH!

MISSION COMPLETE
FACTORY 07
CREDITS: 2
FREE LIFE EVERY 255,000 POINTS

CRYSTAL POWER

NO FRIGID ROBTAGS

SHUTTLE LOAD OF FRIGID ROBTAGS

NO FRIGID ROBTAGS

JAKE AND DUKE FIGHT THEIR WAY THROUGH HORDES OF EVIL ROBOTS IN SEARCH OF PROFESSOR SARAH BELLUM

JAKE AND DUKE POINTS FOR TIVES RESCU

AT THE END OF EACH FACTORY LEVEL THE HEROES ARE SHOWN THEIR REWARD STATUS.

GOOD JOB! NOW GET TO THE NEXT FACTORY AND RESCUE OUR PEOPLE!

THEY MUST BREAK INTO FOOD LOCKERS, BOMB LOCKERS AND FIND SPECIAL WEAPONS TO HELP THEIR DEFENSE.

FACTORY MAP OF PLANET X

AT THE END OF THE CANAL ZONE MAZE, THE HEROES WILL CHOOSE ONE OF THREE DOORS TO THE NEXT SECTOR

ESCAPE

DISTRIBUTED BY:

"THE FATE OF THE WORLD IS IN YOUR HANDS!"

JAKE

"DESTROY THE EVIL REPTILONS"

DUKE

847A

524P

6952 7690 7690

COMBAT ZONE

7780

8383 = JP 3400

8400

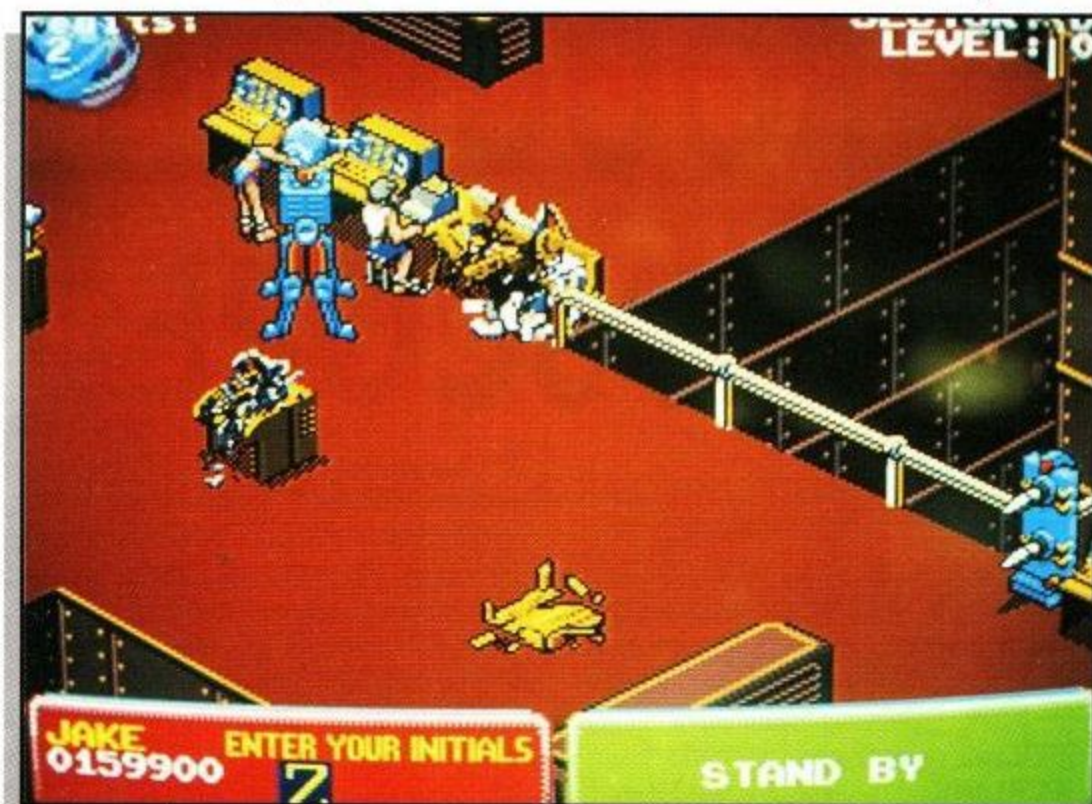

Robot Monster.

shooting the human slaves, working away at terminals, and beam them up to the rescue shuttle by touching them. You can also shoot up the delicate lab equipment – and get extra points (and satisfaction) for doing so.

Finish the level and you go onto a section where you steer your space buggy through a maze, against a strict time limit. Complete the maze and you get a mega bonus. I didn't.

After that, you go onto a bit where you battle it out with a giant Robotroid

– and more likely get stamped on. Use your bombs here, by pressing all three buttons together. Boom!

Beat the guy and it's further into the complex and harder levels. A fun game, it's well worth a go or seven. Check it out!

Finally, Wild Fang – or Temco Warrior – from Temco. This looks like a

Magic, Barbarian has Earth Magic and the Amazon, Fire Magic – each being stronger than the other in that order. Trouble is, each needs more potions to work, in that order, too.

This means that the Dwarf is quite an easy character to play in the initial stages because his magic, although weak, is easy to use and effective against underlings. He's good to play when you are getting to learn the game.

On the other hand, the Amazon will be weak on the earlier levels, but is more effective if you can get past the initial stages, while the Barbarian is a compromise between the two.

Another hint – while you are bashing a guy on your right and another enemy comes onto your left, try pressing both jump and fire together. You'll find yourself quickly swinging round and bopping the new guy straight on the bonce. Very satisfying!

Pity that can't be said of a game called Plotting – new from Taito. It's a puzzle game, another one as the manufacturers all hope to stumble on another Tetris. Plotting has you firing tiles at a matrix of other tiles. If the tiles have the same shape on it, both disappear, if not, it rebounds back to you. Fascinating stuff, eh? Give this one a wide berth.

You can't say that of Escape from the Planet of the Robot Monsters, however. New from Atari Games – a company that is always coming up with different ideas and graphic styles – although they don't always work!

EFTPOTRM (as we shall call it from now on!) is an isometric style arcade



Wild Fang.

adventure that will look very familiar to home users, with a graphic style and theme based on the tongue-in-cheek, sci-fi genre. And it's fun.

As you move through the levels of the factory planet, it's a zapping spree as you take out the robots that move towards you zombie-like, or the ones that stand on the spot and zap you! In the latter case, you either duck (using the duck button, not surprisingly!) or

jump over the bolt of pure energy. You can take three hits before you get dematerialised!

All the while, you have to avoid

poor man's Golden Axe graphic wise, but has some quirky graphics that – if you get into the style – soon grow on you.

Again it's a left to right scroll cum beat-em up, but you can change from a tiny man riding on the head of a giant, to a lad riding on the back of a leopard. Change configuration and tactics depending on the enemy encountered.

Frantic stuff, especially when played with two of you, you might find it worth a try if you come by it.

That's it then – next month the long awaited sequel to Chase HQ, yes, Chase HQ II. Get the gel and shades ready, boys! Miami Vice here we come!

We saw last month how NAND and NOR gates worked. Now we will look at a few more simple hardware building blocks. Remember these logical components are the most widely-used parts in computers and peripherals. They are used to achieve a high or low signal when other signals are at certain levels. As understanding words allows sense to be made of sentences, so these gates will put you well on the way to a full understanding of your computer.

The AND gate outputs a 1 (high) only when all its inputs are 1s. The OR gate outputs a 1 when any of its inputs is 1. The EXCLUSIVE OR outputs a 1 if either input is a 1 but not both. The NOT gate, or inverter, inverts the input signal - 1 in = 0 out and vice versa. Most gates are available with various numbers of inputs and several to each chip but the truth tables still apply. For example, a 3 input NOR gate, usually three in, each chip will output a 0 only when all 3 inputs are low.

TRUTH TABLES

NAND gate			NOR gate		
InA	InB	Out	InA	InB	Out
0	0	1	0	0	1
0	1	1	0	1	0
1	0	1	1	0	0
1	1	0	1	1	0

AND gate			OR gate		
InA	InB	Out	InA	InB	Out
0	0	0	0	0	0
0	1	0	0	1	1
1	0	0	1	0	1
1	1	1	1	1	1

EXCLUSIVE OR gate			NOT gate	
InA	InB	Out	In	Out
0	0	0	0	1
0	1	1	1	0
1	0	1		
1	1	0		

also called an
INVERTER

Remember the In/Out map and the need to decode IORQ with RD or with WR? In the CPC a decoded signal called IORD is produced by feeding IORQ and RD from the Z-80 to a 2 input OR gate. The output is low only when both inputs are low, i.e., when the Z-80 wants to Read data from a peripheral. Another signal, IOWR, is produced in the same way. One of its uses is to tell the printer port that the data on the data bus is for printing.

THROUGH THE MICROSCOPE

Trevor Cummings takes you even further into the wonderland of the CPC internals.

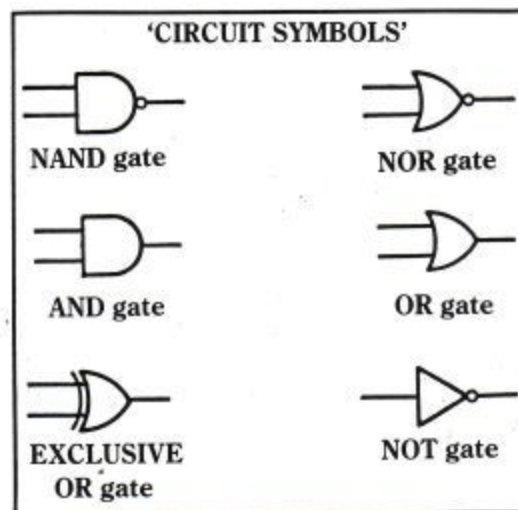

That is achieved by feeding it to another OR gate whose second input is A12, so that only when all three are low is a low signal produced.

The only time that A12 goes low together with IORQ and WR is when the Z-80 is writing or outputting to the

printer and the low signal produced causes the printer port to grab and keep the data which is on the data bus. The diagram shows what happens when OUT (C),A occurs in our machine code program. The character to be sent to the printer is already in the Z-80 accumulator, A and the port address with A12 low is in the register pair BC.

OUT(C),A is one of the Z-80 machine codes which causes it to put the contents of the accumulator on the data bus, send IORQ and WR low and put BC on the address bus. From the diagram you will see that a low signal is sent to the printer port latch when that occurs. The lines above IORQ and WR indicate that those signals are active low. High when not in use, low when activated - I said it was easy.

CPC PROCOPY

The new copyright laws, which outlaw both the act of illegal copying and the means to do it, have now been in force for a few weeks. A great deal of conflicting information has been written as to whether or not back-up copies are legal and whether copying utilities which overcome the copy-protection employed by software houses are legal. It has been said that if such a utility has a legitimate use it

is legal even though a part of it is designed to beat the protections.

I shall not enter the debate as I do not have a full copy of the Act but my eyebrows have certainly been raised by the latest offering from Nemesis. If the 'legal use' argument is sustainable its CPC *Procopy*, a disc copier designed to overcome copy-protection, will be satisfactory as it also has a number of unimpeachable utilities

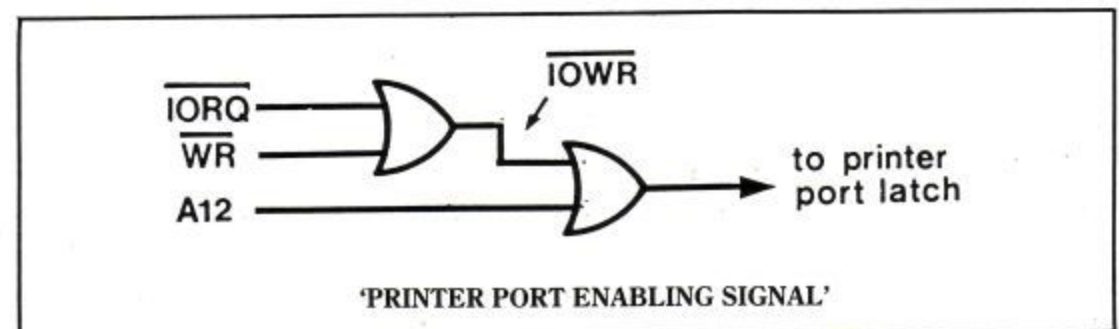

like formatting, disc mapping and the very interesting Minidos.

It would infringe the new laws to 'publish information intended to enable or assist persons to circumvent that form of copy-protection' - section 296, sub-section 2(b) - so I am steering clear of stating any game or piece of software Procopy will copy and any type of protection with which it will deal. Instead I will stick to the other utilities included on the disc.

MAPPING a disc is somewhat different from other mappers I have seen. Instead of a screen which shows the tracks and sectors where each file is stored, Procopy prompts for the tracks you wish to examine and displays such technical information as number of sectors, sector headers and gap#3 byte, one track at a time. Two formatting choices are offered, the normal, 178K free, data format and the Minidos vendor format.

Minidos is a set of useful utilities and is similar to CP/M in that it is written on to the first two tracks of any disc using its format, leaving 169K

free. Typing :CPM will cause it to run. It contains two CAT options. The first is almost standard but with the option to specify which drive is to be catalogued. Erased, system and read-only files are also listed and indicated. The second option shows the start addresses, length and entry points of selected files.

COPY is a disc-to-disc file copier with the usual ? and * wildcards permitted. ERASE is self-explanatory but KILL is a little different. When a

file is erased from a disc its directory entry is modified but the remainder is left intact. The kill command removes the directory entry of a file. UNERASE will resurrect erased files but not those which are killed. R/O and R/W allow any file to be set to read-only or to read-write. Similarly, SYSTEM allows the setting of any file to a system file or not.

Perhaps one of the most important features of Procopy is the facility to

archive files on to tape. Recovery of them is via Procopy but it cannot be used as a normal tape-to-disc transfer. It is a genuine archiving utility and much cheaper than though not so fast as a tape streamer.

A tape streamer is a very expensive piece of equipment which saves archive copies of discs and software to cassette tapes. They are used typically to back-up large capacity hard discs.

I have had to skim over the main protection-busting functions of Procopy until the legality of it, and others, is determined. Its extra utilities are a worthwhile addition to disc management and its price, £12.50 on disc - not available on tape - is amazing.





MACHINE CODE

Do not type this in. It is the data of the Basic program.

1:	BF10	F5	PUSH	AF
2:	BF11	1F	RRA	
3:	BF12	06 EF	LD B,	&EF
4:	BF14	E6 F5	AND	&5F
5:	BF16	ED 79	OUT (C),	A
6:	BF18	F6 20	OR	&20
7:	BF1A	ED 79	OUT (C),	A
8:	BF1C	F1	POP	AF
9:	BF1D	C3 35 0B	JP	&0B35

When this program is reached the original character to be sent to the printer is in the accumulator with D7 intact. It works as follows:

1. Saves the character and flags on the stack.
2. Rotates the accumulator right placing D7 (8th bit) in D6.
3. Printer port address into register B.
4. Re-set D7 and D5 to 0, leaving D6 intact. When D7 goes out the printer reads it as STROBE. As it is inverted along the way we send a 0 to keep it high.

5. Output the accumulator to the printer port. This makes sure that C on the flip-flop (D5) is low. If it is not in a low state it certainly cannot go high. High followed by high will not trigger it.
6. Set D5 to 1 leaving D6 and D7 intact.
7. Output to printer port sending C high and latching D6 in Q. The 8th bit is now latched.
8. Bring back the original character and flags from the stack.
9. Jump to MC WAIT PRINTER. This is the usual address found in the jumpblock which we have replaced.

If problems occur in obtaining any parts, MicroStyle will supply the full kit for £4.50 including postage.

Maplin Electronics, PO Box 3, Rayleigh, Essex SS6 2BR. Tel: 0702 554161.

MicroStyle, 212 Dudley Hill Road, Bradford, Yorkshire BD2 3DF. Tel: 0274 636652.

Tandy - see local Yellow Pages under Electrical Supplies Retailers.

We managed to omit the software needed to run our 8-bit printer port project from the August issue. Here it is:

```

10 POKE &BDF2,&10
20 POKE &BDF3,&BF
30 q=&BF10
40 FOR x=0 TO 15
50 READ d
60 POKE q+x,d
70 NEXT
80 DATA &f5,&1f,&06,&ef
85 DATA &e6,&5f,&ed,&79
90 DATA &f6,&20,&ed,&79
95 DATA &f1,&c3,&35,&0E

```

464 owners replace line 95 with

```
95 DATA &f1,&c3,&f8,&07
```

564 owners replace line 95 with

```
95 DATA &f1,&c3,&25,&0E
```

Two parts also seemed to go missing so Figure One is the full list.

Component	Supplier	Part No.	Price
Circuit board	Tandy	276-149	£0.79
D-type flip-flop 74LS74	Maplin	YF31J	£0.25
Edge connector 34-way	MicroStyle	EC34W	£2.00
Through connector 34-way	MicroStyle	TC34W	£0.90
Capacitor	Maplin	YR75S	£0.08
Wire	Maplin	BL92A	£0.28

The program needs to be typed-in and saved. Run it whenever the printer is to be used. Lines 10 and 20 replace the start address of MC WAIT PRINTER in the computer jump table with the start address of our machine code routine. The rest of the program pokes our machine code into a small unused area of memory starting at &BF10.

We've just added



to our low cost Business Series



The Business Series

Well, it had to happen! Following the tremendous success of the award winning low cost Business Series which features the widely acclaimed LC-10 and LC24-10, Star are pleased to announce the arrival of their wide carriage versions, the LC-15 and LC24-15. Capable of printing A3 landscape in either NLQ or LQ mode respectively and draft at speeds of up to 200cps, these new printers are able to offer much more.

WINNER
WHAT MICRO?
AWARDS
BEST BUDGET DOT
MATRIX PRINTER 1988
STAR LC-10

For users that need to link into networks or position the printer more remotely, you can now easily switch to a RS232C interface by just unplugging the parallel and clipping in the serial cartridge interface.

LC-15

- ✦ Superb Bottom and Rear Feed 9-Pin Printer.
- ✦ Offering high quality printing at a speedy 180cps in draft elite and 45cps in NLQ.
- ✦ A wide variety of styles can be used via the 8 Resident Fonts (including italics).
- ✦ First and Last line printing is also available on every page.
- ✦ Paper Parking is available on both LC-15 and LC24-15.

LC24-15

- ✦ Exceptional value 24-Pin printer offering speeds of up to 67cps in LQ mode and 200cps in draft elite.
- ✦ 8 LQ fonts available from the front panel plus a choice of 3 optional font cartridges and a 32Kb RAM cartridge for creating your own fonts or expanding the buffer memory from 11Kb to 43Kb.

THE
star
COMPUTER PRINTERS

Star Micronics U.K. Ltd., Craven House, 40 Uxbridge Road,
Ealing, London W5 2BS. Telephone: 01-840 1800.
A division of Star Micronics Co., Ltd. Japan.

Please send me details of the new Business Series printers (alternatively, just call the Sales Information Line on 01-840 1829).

Name _____

Company _____

Address _____

Postcode _____ Telephone _____



Public sector customers may purchase at preferential terms from HMSO. Contact 0603 695256.

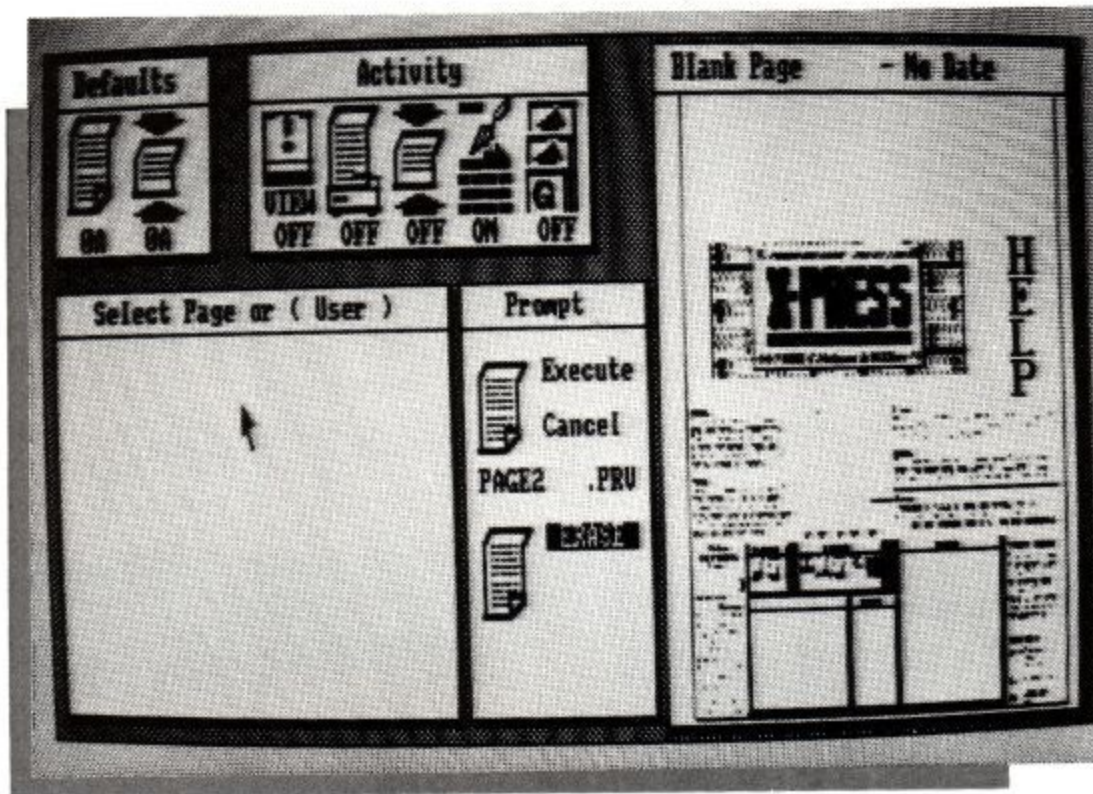

X-press yourself

One of the consequences of using a desk-top publishing system such as *Stop Press* is that large files are produced. The detail required to produce high-quality pages of pictures and text means that a great deal of information must be stored for each page. *X-Press* is a utility program for use with *Stop Press* which adds a number of useful functions. It allows pages to be previewed, printed, crammed – compressed – built – decompressed – and queued for printing.

Files can be stored on disc in either of two formats, normal *Stop Press* or

X-Press crammed. The latter are produced by the *X-Press* Cram facility which can reduce page files to as little as 6K, depending on the contents. Normal cramming will reduce pages to around 25K or so on average. All the functions operate with both file formats in one way or another.

The operation of *X-Press* uses a form of the ubiquitous WIMP front end. The screen is split into five static windows – they do not move round as in other WIMP systems – each having its own function. Selecting an operation type, e.g., View, print and the like is a matter of moving the pointer to the Activity window and clicking the required icon. The state indicator below the icon then goes from OFF to ON and information will appear in the

Prompt window. At this stage this is usually a disc file, or User selection. Again, placing the pointer in the required place and clicking Select gets things moving.

The mouse used with *X-Press* is the AMX system. For those who do not have it the cursor keys will move the

Kenn Garroch reviews an aid to the popular *Stop Press* desk top publishing system from Medway and King.

pointer round the screen with shift slowing it – F4, F5 and F6 being Select, Reduce and Cancel.

Select is used, as the name implies, for selecting things. They can be icons, file names, activities, options. In some circumstances the reduce key has the same effect as select but more normally is used to change the user number. Why the authors did not use an icon to change the user number I do not understand; it would have made more sense.

Perhaps the fact that the mouse has three buttons made them want to use the middle one for something. It is also

used to take pages out of the printer queue, i.e., 'Reduce' the queue. The Cancel button/key generally quits the current activity and moves back to the previous position.

Moving the cursor to the View icon and pressing select turns on viewing mode and allows either compressed or normal files to be displayed. The image is shown in a condensed format which reduces a whole A4 page to allow it to fit in the Preview window. It occupies one-third of the width of the screen and can show either A4 or foolscap. To get the latter, two A4 pages are combined to form a longer

image. In one form, the top one-third of an A4 sheet makes up the top part of the foolscap, the other A4 sheet effectively being placed on top of it but further down. Alternatively, the full A4 sheet can be on top with the bottom sheet showing its lower third.

The print option allows pages, either A4 or foolscap, to be printed in one of five modes; high-resolution – fast NTQ – high-resolution condensed, draft, draft condensed and draft high speed for proofing. The condensed mode gives a 25 percent reduction vertically for standard A4 pages and 25 percent more lines on foolscap combined pages.

Selection of the print mode is a matter of positioning the mouse over the required mode and pressing select. The program then loads the page into the preview window and puts up a 'printer ready' icon. Printing

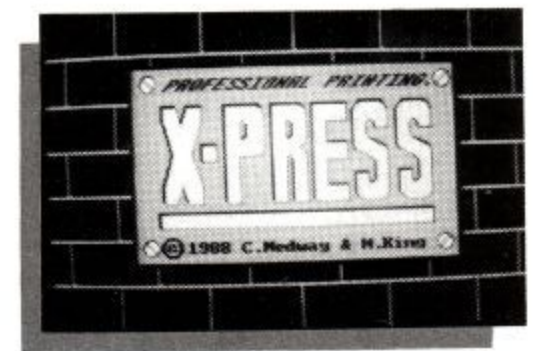

starts when select is pressed. The ESC key will pause printing if pressed once and stop if pressed twice.

Overall, *X-Press* is a reasonably good aid to *Stop Press*. Its facilities for cramming pages and queuing print-outs are useful, as is its ability to print-out faster – around four times faster than *Stop Press*.

Product:	<i>X-Press</i>
Machine:	Amstrad CPC6128
Available from:	Medway-King, Tel: 0703 442591.

ZEDASM ROM £19.95

The professional Z80 Text Editor/Assembler and System monitor. Superfast Z80 assembler (200 lines second). Supports page switching on 6128 machines, up to 80k of text source in memory at the same time.

DEMON DEVELOPMENT CARTRIDGE £19.95

The Ultimate machine code tool. Stop Any program Anytime by a press of a button, the memory remains intact and can be saved to Tape/Disc, debugged, traced, moved, disassembled etc.

EPROM PROGRAMMER KIT £27.50

Transfer your favourite programs (Basic/Machine code) onto Eprom. Programs 2764/27128 12.5 or 21 volt Eproms. Powerful but easy to use software, Rom to Rom copy, Editing, Verification, Single or block programming.

PCB DESIGNER CARTRIDGE £59.95

Design double sided printed circuit boards quickly and easily. Output to standard printer 1:1 or 2:1 scale. Predefined DILS & IDC connectors. Auto Routing. Zoom Editing etc. Too many functions to list here.

PASCAL COMPILER ROM £15

Our pascal compiler is easy to use, suitable for the absolute beginner and produces stand alone Machine code. Does NOT require CPM.

(Note cartridges have no through connector for 464 with Disk Drive)

JOHN MORRISON DEPT (ACU)

4 REIN GARDENS, TINGLEY,
WEST YORKSHIRE, WF3 1JR

TELEPHONE (0532) 537 507

S. A. E. for further information

VSE

Technical Services

High Quality Repairs
Low Inclusive Prices
The Logical choice!

REPAIRS

Amstrad CPC 464.....£21.90
Amstrad CPC 6128.....£24.90

ACCESSORIES

CPC 6128 Rom.....£16.90
64K Ram Pack.....£43.90
Printer Cable.....£8.80
MP2 Modulator.....£27.90

All repairs guaranteed 4 months, prices quoted apply to any single fault ★ and are inclusive of parts, labour and VAT. Free return carriage for UK mail order customers. CPC 6128 Rom installation service available, only £8.00. ★ Excludes cabinet damage and replacement of complete keyboard or disk drive assemblies (free estimate given).

VSE Technical Services (Dept. 107), Unit 6,
8 Nursery Road, London SW9 8BP. Tel: 01-737 0234

Reach the top
with...

LCL

Self-Tuition Courses



World leaders - Hons graduate/teacher authors - All disc sizes - At all major shows - £5 off total for 2, £10 off for 3

MICRO ENGLISH

Complete course taking beginners to GCSE in 24 programs with real speech and graphics adventure game, 2 discs + 2 books. £24

PRIMARY MATHS COURSE

Complete course taking age 3 years to secondary school entrance, using moving colour pictures. 24 programs on 2 discs + 2 books. £24

MICRO MATHS

Complete course taking beginners to GCSE in 24 programs on 59 topics on 2 discs + 2 books. £24

MEGA MATHS

A-level step-by-step course. 24 programs for £24. Full-screen graphics for calculus. 2 discs + 2 books.

HOME COLLEGE

Micro Maths or English with VHS video £49.99 each.

Send cheques PO's or phone orders or requests for free colour poster/catalogue to
LCL, DEPT AU, THAMES HOUSE, 73 BLANDY ROAD,
HENLEY-ON-THAMES, OXON RG9 1QB

Tel 0491 579345

VISA

ASTROLOGY for beginners

Teach yourself astrology using your Amstrad

Buy a Starter Pack comprising a simple program to calculate a horoscope, an introductory booklet and 2 self-teaching programs (how to interpret the horoscope).

ONLY £12.50 No previous knowledge required
For ALL Amstrads (CPC, PCW, PC, PPC)

Payment by Access/Visa, Cheque, P.O. Please state make of computer or send s.a.e. (about 9"x7") for free catalogue giving details of our wide range of programs for **PROFESSIONAL ASTROLOGERS** including complete natal interpretations and forecasting.

Also I CHING, GRAPHOLOGY, BIORHYTHMS, etc.

ASTROCALC

(Dept ACU) 67 Peascroft Road, Hemel Hempstead,
Herts HP3 8ER England. Tel: 0442 51809

50 GOOD REASONS TO SHOP AT CRAZY JOE'S

10 Computer Hits 5.....£4.99	Prodigy.....£1.99
10 Great Games 3.....£6.99	R-Type (Disc).....£7.99
1942.....£2.99	Roland in Time (464).....£0.99
Answer Back Junior Quiz.....£4.99	Roy of The Rovers.....£2.99
Army Moves.....£2.99	Runestone.....£1.99
Bard's Tale.....£2.99	Scruples.....£4.99
Bombjack 2.....£1.99	Spy Hunter.....£2.99
Daley Thompson Decathlon.....£2.99	Star Wars.....£3.99
Fernandex Must Die.....£3.99	Starglider (Disc).....£6.99
Fernandez Must Die (Disc).....£4.99	Supreme Challenge.....£6.99
Forgotten Worlds.....£6.99	Tetris (Disc).....£4.99
Game Over.....£2.99	Thunderbirds.....£7.99
Gauntlet 2.....£2.99	Tiger Road.....£4.99
Geoff Capes Strongman.....£0.99	Time Scanner.....£6.99
Gothik.....£1.99	Trio Hit Pak (3 Games).....£2.99
Grand Prix Selection.....£4.99	Triv Pursuits Baby Boomer.....£3.99
Harrier Attack.....£0.99	Triv Pursuits Young Players.....£3.99
History in the Making.....£12.99	Twin Turbo V8.....£0.99
Hunt for Red October.....£6.99	Victory Road.....£4.99
Inc. Shrinking Sphere (Disc).....£4.99	World Series Baseball.....£0.99
Jack the Nipper.....£2.99	Cheetah 125+ Joystick.....£7.99
Last Ninja 2.....£7.99	Cheetah Mach One Joystick.....£9.99
Monopoly.....£4.99	Konix Navigator.....£12.50
Pacland.....£5.99	Konix Speedking.....£9.50
Pacmania.....£4.99	Maxell CF2 3" Discs (10).....£22.50

**CRAZY JOE'S, DEPT ACU, 145 EFFINGHAM STREET
ROTHERHAM, SOUTH YORKSHIRE S65 1BL**

VISA and ACCESS orders taken on (0709) 829286

Please make cheque/P.O. payable to "Crazy Joe's"

P&P Free in UK on orders of £5 or over. Under £5 please add 50p.
Europe (inc. EIRE) add £1 per item. Rest of world add £1.50 per item.



20 Grove Avenue, New Costessey,
Norwich, Norfolk NR5 0HN, England

Smogware
Systems

RSX-LIB (1.0)

The RSX library utility

DON'T YOU JUST HATE RSXs?

- Great in theory, but a waste of time in practice?
- All that messing around with machine code?

WITH RSX-LIB, YOU'LL LOVE THEM!

- Select the ones you need from RSX-LIB's library
- Run them from anywhere in memory (self-relocating)
- 52 RSXs supplied free!
- Add more yourself (automatically) using assembled code, binary type-ins, RSX type-ins, etc.
- Simple to use utility, with comprehensive (and friendly) manual.

Suitable for all CPC machines, but
supplied on DISC ONLY.

Cheques (& Sterling), Eurocheques, or UK P.O.s for
£19.95 (UK), £21.45 (Europe), £21.95 (Rest of World).

Accounting for taste

John Taylor road tests
two packages aimed
at taking the fuss out
of finance.

Program: Stock Accounting System
Supplier: SD Microsystems
Price: £39.95 on 3in. disc
£19.95 for Small Traders' Pack/
Invoicer owners

The Stock Accounting System from SD Microsystems is a new integrated package for the Amstrad CPC 6128 and expanded 464/664. Following the success of its previous programs, SD Microsystems introduced its *Stock Accounting System*, a four-module program which can accomplish three essential actions occurring in any small business office.

The program modules, Sales Ledger, Invoicer, Stock Control and Statement Printer are all enhanced versions of the Small Trader programs from SD Microsystems.

Users familiar with those programs will therefore find it easy to adapt to the Stock Accounting System. It is easy to get the program started once back-ups have been made.

The manual advises some experimentation with the sample files provided on disc but this will not take a great deal of time for those who have used this type of software previously.

Novices can take as long as they wish to familiarise with the workings of the various modules without the worry of something going wrong and erasing all their data.

The real work starts when each of the modules is loaded and brought into operation. The modules are loaded separately and the user then has to enter the necessary data. All users must read and thoroughly digest the correct section of the manual

before trying to enter data. The manual is well-laid-out and all instructions are exceptionally clear and straightforward. The user has to decide what information each module needs to make it work properly and to his advantage.

The best way to do this is to decide



exactly what information needs to go into the module and then fit it to the modular plan as outlined in the manual. This part of the procedure is necessarily the most time-consuming but patience at this stage will be rewarded later.

Each of the modules can be accessed by a Master Menu. All the menus are clear and easy to read, though it is possible to move the cursor round the screen and overwrite the previously-input data.

This over-writing is only on the screen and does not affect data but beware that the screen could become

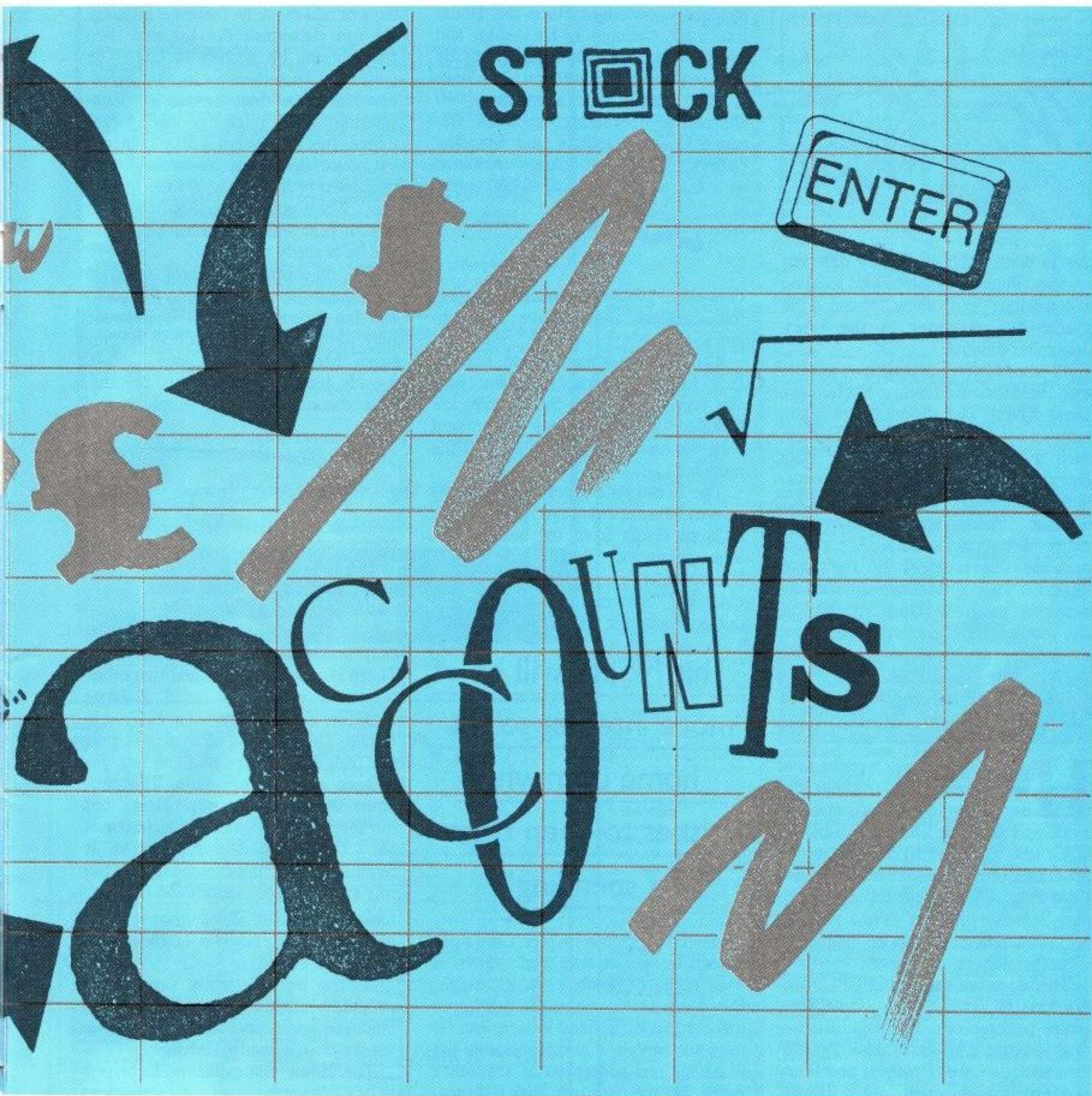

very messy.

There are also facilities for saving or inputting data, as well as the obvious features. Once the system is set up satisfactorily, the user will not need to make separate entries for each module. By installing a customer file of up

to 99 main names and addresses and a product price list, one sale entry will re-adjust automatically the levels of any one of the possible 750 lines of stock. This entry will also update the Sales Ledger as well as facilitate the production of an invoice. Statements,

invoices and credit notes can be printed on computer paper or A4 headed letter paper if the user wishes.

Producing an invoice automatically adjusts stock levels which are then re-saved into the Stock Control module. Those two modules can be run separately if the user wishes. Re-saving is accomplished by replying to a prompt, so the user just has to say no. That will probably be necessary only when dealing with extremely large orders which the user may prefer to enter manually.

When the Invoice module works with the Sales Ledger, it operates on a

batch file system. Each invoice file can store up to 50 auto-numbered transactions, which then have to be transferred to the Sales Ledger before the Invoice module can continue to function. Each invoice can hold up to 20 items and can feature headers and footers with separate delivery addresses for each one. The Invoice product/price list and stock files are saved to the extra 64K of memory, which is used as a RAM disc to produce a capacity of 750 items.

Users of previous Small Traders programs will find this a great improvement but must remember that

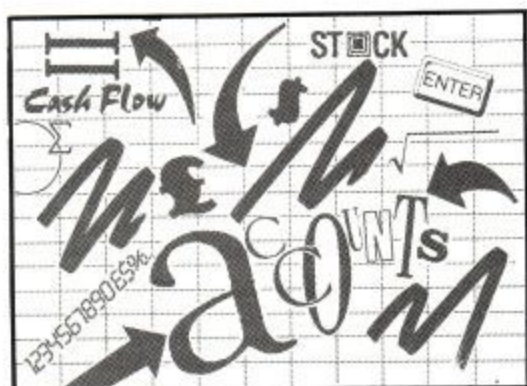

this is done using a slightly different system. Those wishing to load existing files will have to do so by accessing the special file converter in the Stock Controller module.

All the many operations available with the Stock Accounting System are menu-driven. This makes the program very easy to use, particularly with such a well-produced manual. Data entry is uncomplicated and the system does exactly what it promises for a much smaller financial outlay than many of its competitors. A program such as this is ideal for the small business user who needs a solid, dependable program which can deliver the goods without costing the earth.

Program: Home Executive
Supplier: SD Microsystems
Price: £19.95 on 3in. disc

Home Executive is a package of useful programs to help the user keep himself organised at work and at home. For the Amstrad CPC 464, 644 and 6128, this set of programs brings an Accounts Ledger, Card Filer, Mini-Calculator and Shopping Selector together in one package for a fraction of the price many PC owners would have to pay.

This does not mean that CPC owners lose on quality. The *Home Executive* package offers a range of practical facilities with extra desk-top utilities such as Label Designer and Diary and Calendar function. As a bonus, Home Executive is password-protected to keep important information from prying eyes.

The Accounts Ledger, while developed from SD Microsystems business accounting software, is not intended

for strict commercial use. This facility will be of much more interest to the home user who wishes to keep track of spending and, as the manual suggests, small clubs and organisations would find the program a great help.

The program requires no detailed

financial knowledge. Once the Home Executive package is backed-up and loaded, the Accounts Ledger can be selected via the main menu. The user is then faced with a menu of 10 alternative operations, such as Account Codes, Utilities and Standing Orders. The use of colours combined with the small print makes the menu

difficult to read but anyone with normal eyesight should have no problems.

The program is easy to use, particularly for those already familiar with this type of software. Sample files are included on the disc for experiment with the menu layouts for each of the modules.

The Accounts Ledger allows a fairly comprehensive coverage of the user's financial status from the simple vantage points of "What have I got? Where did it come from? and Where did it go?" Statements can be printed-out on computer paper or A4 station-

"This facility will be of more interest to the home user who wishes to keep track of spending"

ery as the user prefers. The Card Filer is equally practicable and allows a wide range of flexibility in its usage. Run from a main menu of 10 options, this cardbox-type filing system can be used to compile a comprehensive list of names and addresses or any other list of data the user may wish to store.

Once again, clubs and societies will find the program just as useful as the home owner, although both will have to be wary of transgressing against the Data Protection Act. Files can be searched, sorted and printed and the program can also process files from SD Microsystems Small Trader software, so previous customers are catered for, too.

The Shopper program should be a boon to harassed shoppers everywhere. A menu of six options allows the user to browse through a list of items which may need to be bought. The user can delete those he never

buys or add those he feels are missing. He can customise the list and then select items he wishes to buy. The only thing to remember is that selection has to be done in one go. Considering how often people forget things, this may seem a little contrary but, once the list is customised, forgetfulness will become a thing of the past. When going to a shop, the user has to print-out his list of selections and he is ready for action.

The on-screen Calculator program is perhaps the most basic in the package but is still useful. It is intended only as a simple arithmetical helping hand. Member X may owe Club Y weekly fees for the last six months. With the calculator it is simple to find

how much he owes. The package includes other quick, helpful programs like this.

The Diary and Calendar should prove to be particularly useful. They can be printed-out in condensed format on Personal Organiser paper for easy inclusion with other such files. There is a Label printer and two other programs which will need a large degree of care in use.

The Depreciation Calculator tells the user how much an item has decreased in value over time. This program should not pose problems but the Interest/Repayments Calculator is not so simple to use as it seems. It requires a fair understanding of the way such processes work and the user must be careful about making decisions based on his use of these two programs.

As the manual rightly says, these programs should be used only as a guideline and proper advice should be sought from a financial adviser.

The Home Executive package is a very interesting set of programs which have been linked well. Its reports are well-designed and logical and the programs contain some highly-original ideas. The whole package can be adapted for use among a wide range of potential owners. There are only two minor problems; the program does not allow the user to back out of menu selections without first entering data and it would also be good to see some on-screen help in future editions.

SD Microsystems
PO Box 24
Hitchin
Hertfordshire SG4 7EG

TELETEXT

A world of information
at your fingertips

A Microtext Adaptor turns your 464 or 6128 into a sophisticated Teletext Receiver. Giving you access to any of the hundreds of free pages from Ceefax or Oracle. As well as up-to-the-minute news or football results, there's the local weather or even bargain holidays. And Teletext caters for special interests, like computing, motoring, or gardening, you'll find things to do and places to go in your area plus much much more.

But unlike a Teletext TV, a Microtext Adaptor allows you to do a lot more with the information, you can save a page to disc or cassette, perhaps to keep a watch on share prices, or print pages like what's on TV. Plus you can access and use Teletext data from your own programs, providing endless possibilities.

The Microtext Adaptor fits neatly on the expansion port, it comes with software and is very easy to use. Just connect it with the lead supplied to the VIDEO OUT or AV socket of a video recorder and change channels with the controls on the video or, there's our own Tuner which has been specially designed to provide the signal that the Adaptor needs, plug in an ariel, it tunes itself in (!) and channels are selected from your keyboard. Tune into Teletext, a world of information at your fingertips.

"A well thought out product that performs admirably."
Amstrad Action, Dec. '87

A Microtext Adaptor for use with a video is only £74.95 Adaptor and Tuner just £124.90 prices include p/p & VAT

Instructions are provided to transfer software to disc. Disc's are available for
£5.00 extra



Please send cheques/PO's to



MICROTEXT

Dept AC, 7 Birdlip Close, Horndean, Hants PO8 9PW
Telephone: (0705) 595694

O.J. SOFTWARE

FAST FRIENDLY SERVICE

ADVENTURE	Cass	Disc	ADVENTURE	Cass	Disc	BUS/UTILITIES	Disc
Times of Lore		£11.95	Funschool 2-5	£5.50	£7.50	AMX Mouse & Art	£62.95
Bards Tale	£2.95	£6.95	Funschool 5-8	£5.50	£7.50	AMX Mouse & Stop Press	£71.95
War Middle Earth	£8.50	£11.95	Funschool 8-12	£5.50	£7.50	AMX Stop Press	£39.95
Pirates (6128) Only		£15.95	Funschool II UN6	£8.50	£10.95	AMX Extra Extra	£20.95
Bards Tale Hint Book		£4.50	Funschool II 6-8	£8.50	£10.95	Protex (ROM + £8.00)	£21.95
Heroes of Lance	£8.50	£15.95	Funschool II OV8	£8.50	£10.95	Protex CPM + Version	£50.95
Time & Magic	£11.95	£11.95	Happy Letters 3-6	£8.50	£11.95	Prospell (ROM + £8.00)	£20.95
Countdown to Doom		£10.95	Happy Numbers 3-6	£8.50	£11.95	Promerge (ROM + £8.00)	£20.95
Return To Doom		£10.95	Happy Writing 3-6	£8.50	£11.95	Maxam (ROM + £8.00)	£21.95
Corruption (6128) Only		£15.95	Wordhang 5+	£8.50	£11.95	Utopia ROM	£24.95
Ingrids Back	£11.95	£15.95	Timeman 14-9	£8.50	£11.95	Tasword 464/6128	£20.95
Lancelot	£11.95	£15.95	Timeman II 4-9	£8.50	£11.95	Tas - Spell	£13.95
			Map Rally 7+	£8.50	£11.95	Tas Sign 6128&PCW	£24.95
			Animal/Veg/Min 7+	£8.50	£11.95	Tascopy	£10.95
			World Wise 7+	£8.50	£11.95	Tasprint	£10.95
			Physics GCSE	£11.95	£15.95	Tas - Diary	£10.95
			Chemistry GCSE	£11.95	£15.95	Microdesign	£20.95
			1st Steps Mr Men	£9.95		Microdesign Extra	£10.95
			Here & There Mr Men	£9.95		Supercalc II 6128&PCW	£44.95
			Caesars Travels	£9.95		Advanced Art Studio	£19.95
			Early Words	£8.95	£13.95	Art Studio	£14.95
			Early Maths	£8.95	£13.95	Mastercalc 128	£27.95
			Primary Maths 5-14	£24.95	£24.95	Masterfile III	£29.95
			Micromaths 8+	£24.95	£24.95	Mini Office II	£15.95
			Mega Maths 15+	£24.95	£24.95	Protex Office AMS/CPM	£29.95
			Micro English	£24.95	£24.95	Crash Course Typ Tutor	£20.95
			Spitting Image	£8.50	£11.95	Two Fingers Conversion	£20.95
			Giant Killer Maths ADV		£11.95		
			Three Bears		£12.95		
			Magic Maths 4-8	£8.95	£12.95		
			Maths Mania 8-12	£8.95	£12.95		
			Maxi Maths 9-14	£8.95	£12.95		
			Better Maths 12-16	£8.95	£12.95		
			Better Spelling 9+	£8.95	£12.95		
			Biology I 12-16	£8.95	£12.95		
			Physics I 12-16	£8.95	£12.95		
			Chemistry I 12-16	£8.95	£12.95		
			Mapwork Quiz GB+IR	£8.95	£12.95		
			Weather/Climate	£8.95	£12.95		
			French Mistress	£13.95	£16.95		
			Spanish Tutor	£13.95	£16.95		
			German Master	£13.95	£16.95		
			Italian Tutor	£13.95	£16.95		
			Answer Back Jnr	£8.50	£11.95		

JOYSTICKS			ACCESSORIES	Cass
Cheetah 125+	£7.95		3.5" Drive Ramdos	£109.95
Ram Delta	£9.95		3.5" Dr Rodos/Romdos	£119.95
Konix Speedking	£10.95		AMX Mouse & Interface	£37.95
Konix Navigator	£12.95		C15 Cass 5 for	£2.95
Cheetah Mach 1	£10.95		KDS 8 Bit Printer Port	£18.95
Pro 5000 Clear	£14.95		KDS Romboard	£24.95
Pro 5000 Extra	£16.95		Rombo Rombox (8 Roms)	£31.95
Stu probe	£13.95		Cass Head Alignment Kit	£7.50
Supercharger	£11.95		Labels 1000 Fanfold It	£5.95
Quickshot Turbo	£11.95		6128 Keyboard Ext Lead	£7.95

STRATEGY/SIMULATION		
Tank Attack	£10.95	£12.95
Colossus 4 Bridge	£9.95	£11.95
Colossus 4 Chess	£8.50	£11.95
Scrabble	£8.50	£11.95
Scrabble DeLuxe 128K		£12.95
Monopoly	£8.50	£12.95
Leaderboard Par3	£11.95	£15.95
Leaderboard Fam Courses	£8.50	£15.95
Kenny Dalglish	£8.50	£11.95
Chuck Yeagers Aft	£7.95	£11.95
F15 Strike Eagle	£8.50	£11.95
Acrojet	£8.50	£11.95
Gunship	£11.95	£15.95
Silent Service	£8.50	£11.95
Football Dir 464	£8.50	
Football DI II Disc	£15.95	
Football Manag II	£8.50	£11.95
F/Manag II Expans	£6.95	£8.50
Yes Chancellor Disc		£11.95
Classic 4 Games	£8.50	£11.95
Question of Sport	£11.95	£15.95
Blockbusters	£6.95	£15.95
Bob's Full House	£6.95	
Microprose Soccer	£11.95	£15.95
T/Pursuit New Beg	£11.95	£15.95
Ancient Battles	£11.95	
Annals of Rome	£10.95	£14.95
Emlyn Hughes Socc	£8.50	£11.95
Tracksuit Manager	£8.50	

COMPILATIONS		
Arcade Muscle	£10.95	£15.95
Gold Silver Bronze	£11.95	£20.95
Supreme Challenge	£10.95	£13.95
Take 3 Sports		£8.50
Giants	£10.95	£15.95
Leaderbd's Par 3	£11.95	£15.95
In Crowd	£11.95	
Flight Ace	£10.95	£14.95
Mega Games I		£11.95
Hits 10 Vol 5	£10.95	£14.95
Magnificent 7	£8.50	£14.95
History in Making	£15.95	£24.95
Game Set & Match	£10.95	£14.95
Comm. Perform	£10.95	£15.95
Space Age	£10.95	£11.95
We are Champions	£8.50	£14.95
Soccer Spectac	£10.95	£13.95
Story So Far	£10.95	£11.95
6 Pack Vol III	£8.50	£11.95
Game Set & Match II	£10.95	£14.95
Heat Wave	£10.95	£14.95
Special Action	£10.95	

NEW GAMES ARE AVAILABLE ON DAY OF RELEASE: PLEASE PHONE FOR AVAILABILITY

Prices include Post & Packing in UK. Please send Cheques/PO's to:

O.J. SOFTWARE, 273 MOSSY LEA ROAD, WRIGHTINGTON, WIGAN, LANCs WN6 9RN

MOST ORDERS ARE DESPATCHED BY RETURN (OUT OF STOCK ITEMS USUALLY WITHIN ONE WEEK)
Write or phone (0257) 421915 for FREE LIST and LATEST RELEASES

OVERSEAS ORDERS: SOFTWARE ITEMS COSTING OVER £10 EACH POST FREE, OTHERS ADD £1.00 EACH

* SPECIAL OFFER ALL SOFTWARE ORDERS OVER £30 FREE CALCULATOR *

Order by Access or Visa 24hrs Answerphone



Amstrad CPC

MODE-ONE

21 Orchard Drive
Burton-upon-Stather
Scunthorpe DN15 9EF
South Humberside.
☎ 0724 721204

*** LOOK! NEW LOW PRICES ***

TITLE	CASS	DISC
Aftersburner	£7.40	£10.65
Blasteroids	£7.40	£10.65
Bloodwych NR	£6.90	£10.50
Chuck Yeagers Aft	£6.90	£10.65
Crazy Cars II	£6.90	£10.65
Command Perf.	£9.99	£14.05
Dragon Ninja	£7.40	£10.65
Dominator	£6.90	£10.65
Dark Fusion	£7.40	£10.65
Emlyn Hughes Soccer	£7.40	£10.65
Forgotten Worlds	£6.90	£10.65
Fist N Throttles	£9.00	£12.99
Game Over II (+1)	£6.80	£10.50
Guerrilla War	£6.80	£10.50
Giants	£10.40	£15.90
Game Set & Match II	£9.80	£12.99
H. A. T. E.	£6.90	£10.65
High Steel	£6.90	£10.50
H. K. Machine	£6.90	£10.65
I.S. Sphere	£6.90	£10.65
Jaws	£6.90	£10.50
Licence To Kill	£6.90	£10.50
Last Duel	£7.40	£10.65
Led Storm	£7.40	£10.65
Navy Moves	£6.90	£10.50
Netherworld	£6.90	
Oblierator	£7.40	
Operation Wolf	£7.40	£10.65
Pacland	£6.90	£10.65
Pacmania	£6.90	£10.65
Running Man	£7.40	£10.65
Run The Gauntlet	£7.40	£10.65
Robocop	£7.40	£10.65
Real Ghostbusters	£7.40	£10.65
Renegade III	£7.40	£10.65
Red Heat	£7.40	£10.65
Ric Dangerous	£6.90	£10.50
Rock Star NR	£7.40	£10.65
Stormlord	£7.40	£10.65
Silkworm	£6.90	£10.65
Special Action	£9.25	£12.95
Super Scramble	£6.90	£10.50
Skweek	£7.40	£10.65

TITLE	CASS	DISC
Taito Coin Ops	£8.50	
Thunderblade	£7.40	£10.65
Titan	£7.40	£10.65
Timescanner NR	£7.40	£10.65
Thunderbirds NR	£6.90	£10.50
Vindicators	£6.90	£10.65
Vigilante NR	£6.90	£10.65
Wanderer (+3D Specs)	£7.40	£10.65
War in Middle Earth	£6.90	
WEC Le-Mans	£6.90	£10.65
Xybots	£6.90	£10.50
4 Soccer Simulators	£6.90	£10.65
3D Pool	£6.90	£10.50

SPECIAL OFFER CASSETTE RRP OUR

Airbourne Ranger	£10.80	£13.95
Barbarian II	£6.95	£10.50
Batman II	£6.90	£10.50
Bubble Ghost	£6.50	£9.99
Cyberlord II	£6.95	£10.50
Echelon	£10.50	£12.99
Fernandez Must Die	£6.50	£9.99
Galactic Conquerer	£6.90	£9.99
Gunship	£9.80	£13.95
Live & Let Die	£6.50	£9.99
Moior Massacre	£6.90	£9.99
Roy of The Rovers	£5.99	
Return of the Jedi	£5.99	£9.99
Rambo III	£6.90	£10.50
R-Type	£6.90	£10.50
Road Blasters	£6.90	£9.99
Savage	£6.50	£10.50
Spitting Image	£6.25	£9.99
Supreme Challenge	£8.50	£12.45
SDI	£6.90	£10.25
Total Eclipse	£6.90	£9.99
Typhoon	£6.25	£9.99
1943 Midway	£6.50	£9.99
4x4 Offroad Racing	£6.50	£9.99

ALL £2.99 BUDGETS ONLY £2.60. ALL £1.99 BUDGETS ONLY £1.75. Any game not listed please write or phone. All in stock titles sent by return. New releases sent on the day of release.

All our prices include P&P within the U.K. Eire & Europe please add £1.20 per item. NR = new release, phone for availability.

Please make Cheques or Postal Orders payable to MODE ONE

PRODUCE PICTURES LIKE THESE IN "MINUTES"
USING A DMP2000/2160/3000/3160 PRINTER AND THE

DART SCANNER

A remarkable new image scanning system which enables you to recreate & store pictures, documents, drawings, photographs etc.

- No camera or video source needed
Simply feed your original into DMP2000/2160/3000/3160 printer (does not affect normal printing operations).
- Compatible with AMX Pagemaker and any light pen or mouse which works with standard screen format
- For all CPC computers

Features:
Scan - Magnification x1, x2, x3, x6
Print - Full Size/Half Size, Load & Save to Tape or Disc, Area Copy, Scrolling Window, Zoom Edit, Box/Blank, Clear Area, Add Text, Flip Screen, On screen Menu.

Applications:
Advertising/Artwork, Letterheads/Logo's, Newsletters & Leaflets, Games Screens.



Package Comprises:
Scanner head, Interface,
Software on Cassette or Disc

R.R.P. £79.95
Including VAT and P&P

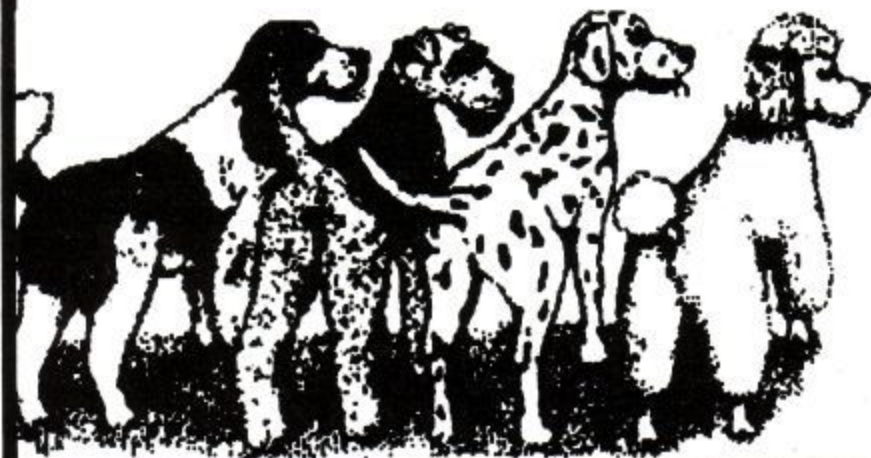

Telephone: (0502) 513707

Trade & Export enquiries also welcome

Unit B5
Oulton Works
School Road
LOWESTOFT
Suffolk NR33 9NA



**EDUCATIONAL
SOFTWARE
SPECIALISTS**

PRE-SCHOOL

PRIMARY

JUNIOR

Devised by experienced teachers
Tested in Classroom and Home
Parent/Teacher notes supplied with all sets

**WIDE CHOICE OF PROGRAMS FOR
AMSTRAD 464, 664, 6128, PC1512,
ATARI ST, PCW.**

CASSETTE £9.50. DISC £12.50 PER SET
(each set has 5 or 6 programs)

Please send SAE for lists, state model and
child's age

**ARC (ACU 10), 51 Coniston Crescent,
HUMBERSTON,
SOUTH HUMBERSIDE DN36 4BA. (0472) 812226**

★ Microgenic Systems ★

AT LAST

THE HOME COMPUTER ENTHUSIAST CAN HAVE PROFESSIONAL HIGH QUALITY
ACCESSORIES FOR ALL CPC COMPUTERS

Our programmer is not fussy about which brand of EPROMs you buy, it programs them all! This is achieved by hand selecting individual components for every board, thus giving the exact programming voltages required by your EPROMs. Add to this the easy to use menu driven software which is supplied on ROM, the ZIF socket and many other special features and you have a professional unit for only £69.95
Our successful 8 socket ROM board also has a host of features and uses on board switches to provide the following benefits:

- Easy bank switching 0-7 to 8-15 • Fast ROM selection
- Convenient board enable/disable • Useful computer hardware reset

This no-compromise ROM board only costs £34.95
Both of these products use the latest technology high quality components and can be left safely and permanently connected to your CPC computer, using their built-in flow-through connector.

Additional items to compliment your computer system:
EPROM ERASER £22.50 - with timer £27.50 • EPROM 27C64 £5.95 - 27C128 £6.95
EPROM ANTI STATIC BOX £2.50

P&P UK FREE - EUROPE £1 - ANYWHERE ELSE £2
CHEQUES AND POSTAL ORDERS MADE PAYABLE TO:

Microgenic Systems

PO BOX 41, WATH UPON DEARNE, ROTHERHAM S63 7PS



THE COMPUTER CENTER

"One single source" for all your Amstrad
Computer needs at competitive prices!

NEW SOFTWARE FOR THE AMSTRAD CPC RANGE

Happy Fractions :- £16.95 D - This program explains the fraction concept implementing excellent graphics display including equivalence, comparison, addition, subtraction. It offers an exciting flying saucer tutorial game.

Happy Breathing :- £16.95 D - An excellent educational program on the Respiratory System using graphics and text to explain each part and function of the system. There is an extensive tutorial and a very interesting game.

Arnold Plot :- £39.95 D/£24.95 T - General graph plotting package, contains a sophisticated "Data Editor" and a versatile plotting facility. It can support Epson compatible Dot Matrix Printers and Pin Plotters. Presentation: pie-charts, bar charts, graph, histograms, high/low charts. Tape version with reduced specification.



TMC The Micro Computer Ltd.,
9 St. James's Terrace, Nottingham NG1 6FW
Tel: (0602) 483440



We have it all this month with two film spin-offs, *Indiana Jones – The Last Crusade* and *Licence to Kill*, one arcade conversion, *Gemini Wing*, and loads more thrills 'n spills with air combat action game *Mig-29* and the hack 'n slay spectacular *Storm Warrior*.

GAMEPLAN

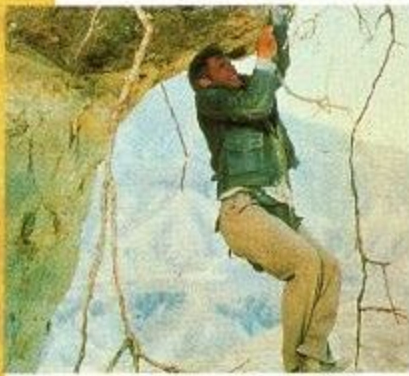

INDIANA JONES - THE LAST CRUSADE

Can you help Indy in his epic quest to thwart the Nazis and recover the Holy Grail?



GEMINI WING

As the defender of the Earth you employ the latest technology to blast those alien suckers.



DOMINATOR

Get to the heart of the matter as you blast your way through the internals of an invading alien.

PLUS

Eliminator, Super Nudge 2000, Story So Far Vol 2, Mindtrap, Licence to Kill. MiG-29. Storm Warrior.

1	(1)	Robocop Ocean
2	(7)	Twin Turbo V8 Code Masters
3	(NE)	Mig-29 Code Masters
4	(9)	Daley Thompson's Decathlon Hit Squad
5	(10)	Fast Food Code Masters
6	(2)	Postman Pat Alternative
7	(11)	Turbo Esprit Encore
8	(8)	Enduro Racer Hit Squad
9	(5)	Rambo Hit Squad
10	(NE)	Shanghai Warriors Players
11	(NE)	Army Moves Alternative
12	(15)	Arcade Flight Simulator Code Masters
13	(NE)	Dragon Ninja Ocean
14	(15)	Spy Hunter Kixx
15	(6)	Emlyn Hughes Int. Soccer Audiogenic
16	(4)	1942 Encore
17	(NE)	Gauntlet 2 Kixx
18	(12)	Treasure Island Dizzy Code Masters
19	(NE)	Wulf Pack Blue Ribbon
20	(20)	Crazy Cars 2 Titus

Last week's position in brackets
Top 20 compiled by Gallup



Indiana Jones - The Last Crusade

Indy takes on the Nazis in a blockbusting last crusade

Once again Harrison Ford defies belief as Indiana Jones attempts to thwart the attempts of the German army to get their hands on yet another holy relic. This time they are after the Holy Grail, source of eternal youth and miraculous cures. Indy's interest in the Grail stems not so much from its magical

powers or great archaeological interest but the fact that his father was tracking the Grail and has been kidnapped by the Nazis.

The game is based on the script of the film and not the film itself so there are a few differences. The differences are not too drastic and still fall within the realms of artistic licence.

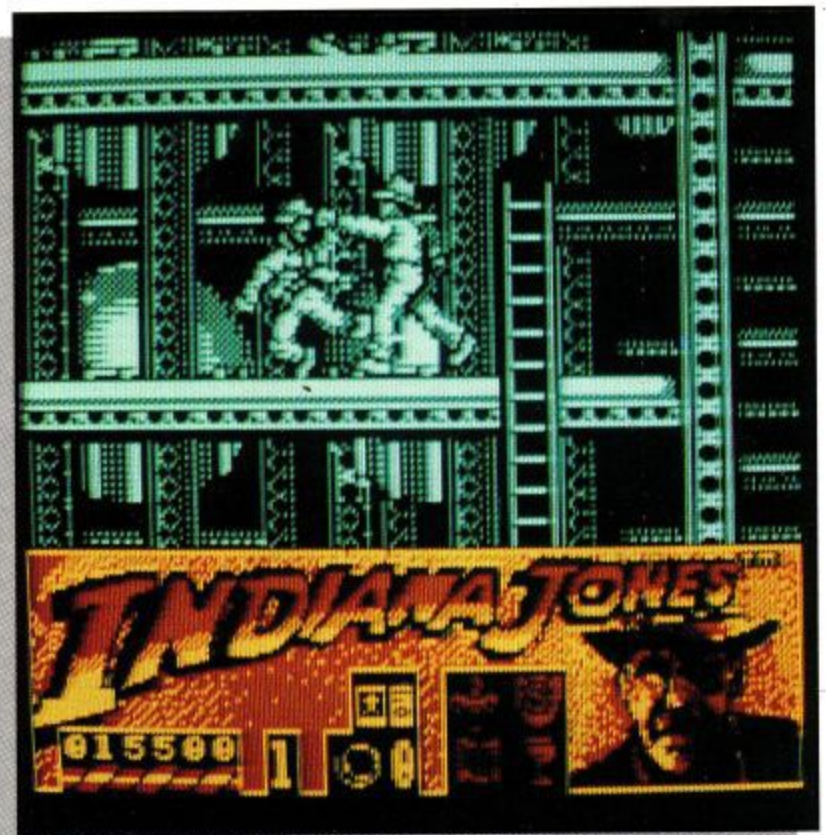



Indiana, or Junior as his dad is wont to say, starts the game by recovering the Cross of Coronado from a band of unscrupulous villains. In the film the escape involves the young Indiana but things went slightly astray and the storyline of this section bears a rather tenuous relationship to that of the film.

After a series of loading screens and a fair rendition of the title tune the game begins. The scrolling section of the play area is surprisingly devoid of colour, i.e. black and white, though the status and score panel underneath add a little colour to the scene and help distract from the scrolling

areas deficiencies.

Indiana sets forth in what is essentially a multi-directional scrolling platform-and-ladders game. Thankfully the game holds more appeal than other games of this ilk, mainly due to the large graphics, the mean dudes and the comical way Indiana holds on to his hat when he jumps. Indiana initially is armed only with a rather devastating left hook but later in the level he has a chance to pick up his whip. It can be used five times and has a far greater range than the fist.

Despite its logical superiority the whip fails to deliver and you are much better off with your bare knuckles. Using the whip is slow – so slow that the bad guys have either shot or collided with you, both of which abort the whipping process.

Torches can also be found in the underground sections and without a constant supply of them the screen gradually becomes darker and darker until play is no longer possible. Once Indi has transversed the many platforms, some of which disintegrate on contact, climbed countless ropes and explored the vast mine-like complex, he finds the cross and exits to level two via the copy protection.

You could be forgiven for thinking that the copy-protection was another level but failure to enter the correctly-decoded doorway results in the item of your quest not appearing on the next level, thus preventing you finishing the game.

The second level, Ascent on Castle Brunwald, leaves behind the cowboys and indians and replaces them with rats and fireballs. Starting in the sewers, Indiana must leap from rope to rope avoiding the pits which have a tendency to occur under the ropes. Recovering the shield allows Indiana to scale the front of the castle to gain entry and thus rescue his father. As Indiana approaches the castle, light-

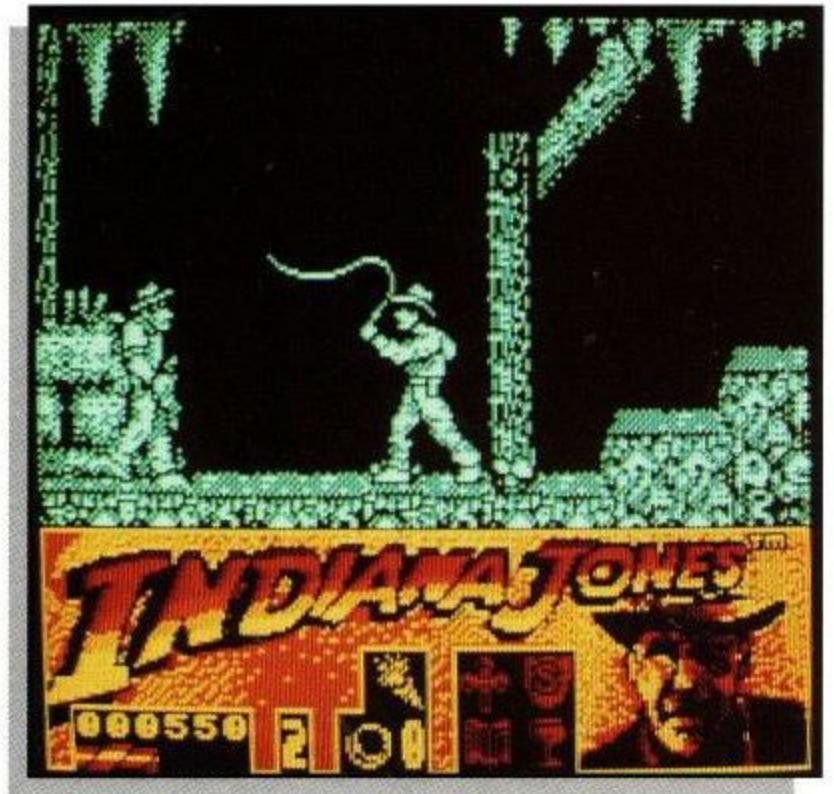

ning illuminates the scene, causing sections of the masonry to tumble leaving hazardous gaps and causing considerable aerial hazards

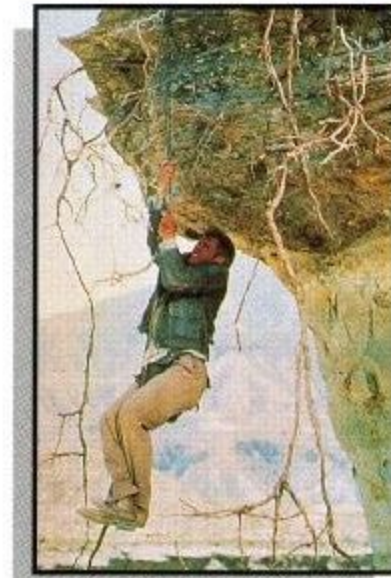

to rope-climbers.

Next is the zeppelin jaunt. The screen is in constant motion and, when combined with your joystick commands, produces some rather uneasy visuals which

manage to create the motions guaranteed to induce air sickness. If you miss one of the tickets and your current one runs out the alarms will sound and the guards will move faster.

The fourth and final level is a departure from the platforms-and-ladders theme. In a mad dash to obtain the grail before your father dies you brave bottomless pits and circular saws. In the 3D section you can move in and out of the screen to line up your next leap and avoid the rather vicious-looking blades which move across the surface of some platforms.

Despite the game bearing more resemblance to some of the earlier platform games its large, animated sprites and fiendish designs make it worthy of the Indiana name.

Adrian Pumphrey

ROUND-UP			
NAME	Indiana Jones – The Last Crusade		
SUPPLIER	U.S. Gold	PRICE	£9.99
GRAFFIX	71%	SONIX	48%
PLAYABILITY	75%	OVERALL	80%

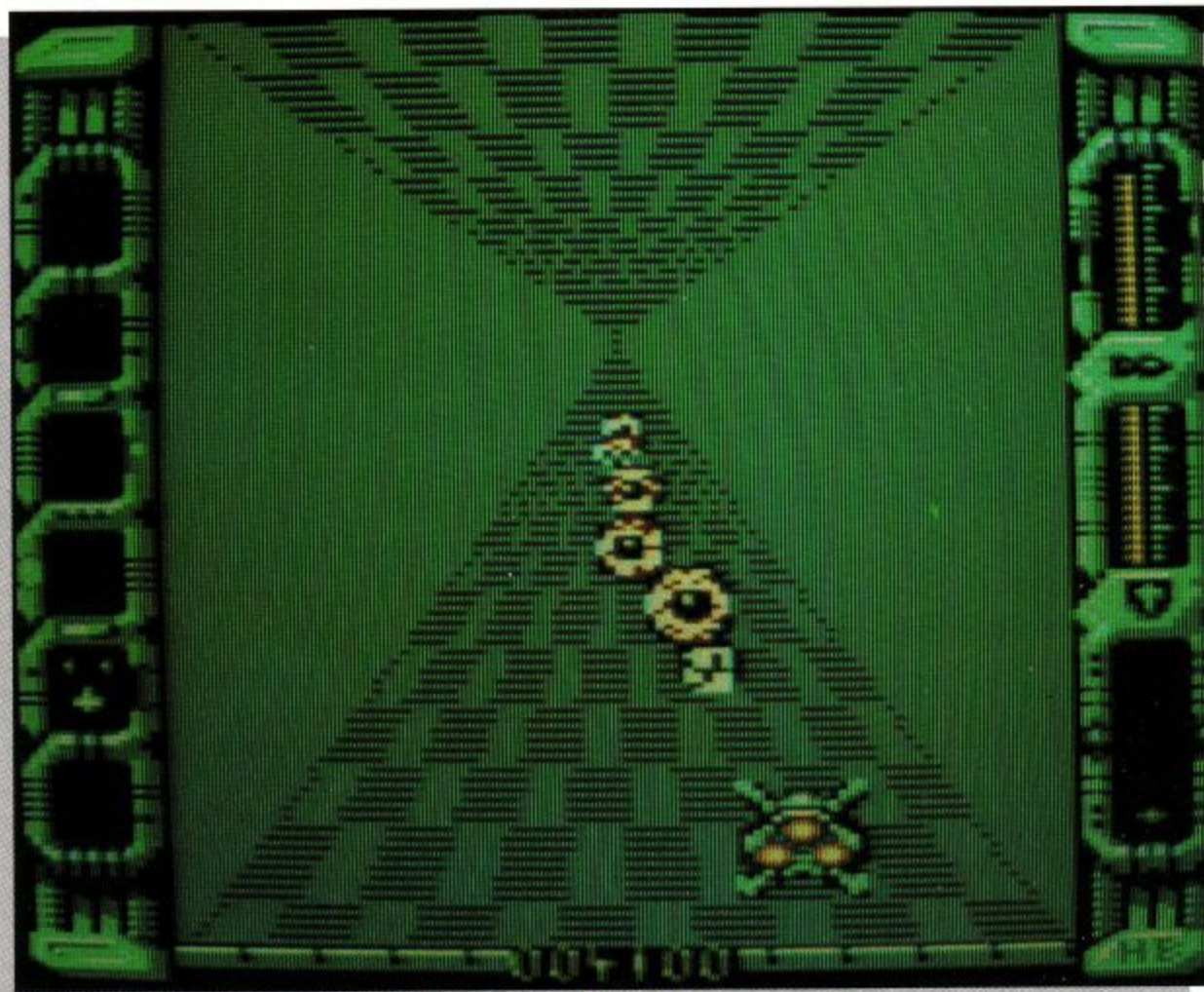

Eliminator

When there is no one else to turn to, when the forces of law and order are too scared to act, call for the A-Team. Cue music, load explosions, bad actors rolling round the floor pretending to have been shot, then getting up and showing it was only a glancing blow.

That means we have to rely on John Rambo, fighting for the American way – truth, justice, liberty. He is off on a gook hunt somewhere. This means we will have to call on the *Eliminator*. Dressed to thrill in Blob, his intergalactic spaceship, he is a one-man cliché machine. *Eliminator*, converted from John Phillips's 1988 original by John Wildsmith, is a third choice in every way. It is the kind of game you are likely to play only if your other games have corrupted or the cat has run off with the tape.

Eliminator has you spiralling through the galaxy but this is not a computerised version of something

On a road to nowhere but your doom



illegal; it is a mission to boldly go where no man would really want to go unless it was a wet Sunday afternoon and the football had been cancelled.

You are on a road to nowhere; nowhere but your doom, that is, one which bends up and down and side to side. I should point out that it does not really undulate like *Overlander* with

you on it. Rather there are long corners and huge down slopes. The road scrolls slowly towards you in two-colour 3-D – Spectrum simulation – and is littered with obstacles around which you must drive; enemy blobs, which must be shot for the sake of all mankind – and especially young Johnny sleeping peacefully in Acacia Avenue; ammunition sprites for re-stocking and weapon sprites for strapping on extra big boy weapons.

Your inter-galactic space-blob moves slower than a hibernating tortoise and only marginally faster than a dead one. That makes getting through the narrow gaps more hazardous than driving along the North Circular Road in the rush hour.

Armed only with a blob shooter initially, you can upgrade to twin blob, wide-angled twin blob, upwards-firing blobs and many more blob variations. If by now you have the impression that the graphics are basically indistinguishable blobs, you are correct. They are multi-coloured and 3D but blobs all the same.

The only real thrill is when you spin to the ceiling and leap over obstacles on the road via a ramp. Apart from that it is a question of how long you can stay awake. That is a pity because the ST and Amiga originals were good. The only good point about this desperate exercise is the gritty music by Nick Jones, more deserving of a fate other than accompanying this particularly sad version of *Eliminator*.

Mark Luckham

ROUND-UP			
NAME	Eliminator		
SUPPLIER	Henson	PRICE	£9.99
GRAFFIX	32%	SONIX	71%
PLAYABILITY	52%	OVERALL	41%

Yet another attempt has been made to transfer the magic of a fruit machine to the computer screen. *Super Nudge 2000* has a number of the authentic features to which all fruit machine addicts will be accustomed. You are given £1 credit to start; each attempt costs the usual 10 pence.

There are the standard three reels, with all the usual symbols. Prizes are won with two or three of a kind on the win line. There is no explanation of what each



you win the Cash Plus feature the bank becomes yours. After all the features there is the possibility of a repeat chance; scoring a yes is very difficult.

The graphics are good, the reels while spinning look authentic, which is satisfying as you will spend a great

deal of time watching them spin.

When I was a young boy, on one birthday a friend gave me a Pocketeer fruit machine simulator. I remember becoming bored with it before that happy day was over. A fruit machine is about winning money while drinking pints of Directors playing a computer imitation while drinking office coffee cannot compare.

Steve Brazier

Super Nudge 2000

An attempt to transfer the magic of the fruit machine to the comfort of your own home.

fruit is worth; they do not fall into the familiar pattern where cherries are worth the least, melons the most.

To reach the exciting part of the game, the letters of Fruitbank need to be lit. On some reels symbols is a number. This relates to the number of letters lit; for example, a cherry with a '3', a pear and a plum with a '1' will light the first four letters. The game is not generous with its feature hold, making it far too difficult to light the Fruitbank completely.

One of the symbols contains a question-mark, which gives the player a skill chance to light the Fruitbank. The skill chance was

almost impossible to miss – unfortunately unlike the real thing.

There are four features on offer. Nudges are self-explanatory; it is rather tedious that no auto-nudge is supplied. With Spin-A-Wheel the first reel spins and stops randomly. If the second reel appears, with a match before the third, a two-reel win is registered;



otherwise all three reels are matched.

Stop-A-Reel lets all three wheels spin; your task is to stop them one at a time to make a winning combination. The final feature with which I am unfamiliar is called Cash Plus. Whenever a certain symbol appears on the win line, 10 pence is added to the Cash Plus bank at the left of the screen. If

ROUND-UP			
NAME	Super Nudge 2000		
SUPPLIER	Mastertronic	PRICE	£2.99
GRAFFIX	70%	SONIX	70%
PLAYABILITY	30%	OVERALL	40%

Take on the world, armed only with a sword and with only one life. A simple task it is not. Yet it is your duty as Prince of the Kingdom to rid your people of a terrible enchantment inflicted on you by the extremely evil Witch Queen.

Darkness has descended on the land – and the computer screen – since the nasty old witch has summoned a thunderstorm destined to last for 100 years. Torrential rain, howling winds, floods and lightning will wreak death and destruction across the land, ruining crops and destroying villages; well, that is how the script goes.

There was no sign of bad

to-one combat; kill one of the enemy and the next screen can be reached. The fight is conducted using four attacking moves, three sword swipes and a kick. Killing any one guard is easy since the Prince is the stronger man. Each body blow received decreases our hero's strength; one strike too many and the game is over.

During a fight the sound effects are all-important; a



satisfying crunch depicts that a body blow has been made; a metallic ring suggests the opponent has mastered his swordcraft and

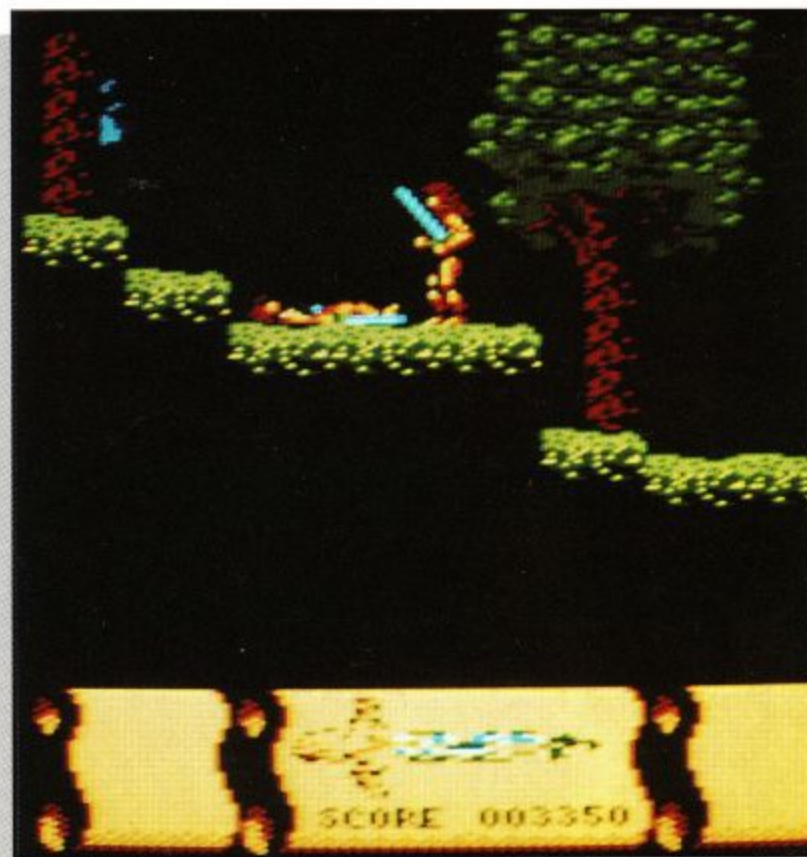

Storm Warrior

Take on the world armed only with a sword.



weather during the games I played, so perhaps I was mistakenly reading the BBC weather forecast instead. This game can best be



summed up as an adventure-style combat game. The Prince of Darkness spends his time in one-

blocked a move. Mastering defence is important if the journey is to be made all the way to the castle.

There are more hazards with which to be concerned. Making contact with a flying rock or a fireball damages your remaining energy severely. Before entry to the castle, as well as killing plenty of guards, the Prince has to find a torch and a key.

The torch is found at the bottom of the caves; the key you will have to find yourself.

One major failing is that the programmers have used the same sprite for the prince and the guards. Not only does it detract from the



atmosphere of the scenery but the fast action fights become difficult for the spectator to follow. You may find your friends offering support and advice to the enemy.

With this type of game the action can be spoiled by the

difficulty of mastering the movements of the character. I am pleased to say that in this case that is not a problem; moving and fighting with the Prince is soon mastered even if you are not a joystick wizard.

Having said that, his movements are not limited. He can walk backwards and forwards, jump, kick, and even perform somersaults. All this and all the sword movements are controlled with the joystick. The concepts behind the game are not new; you have probably seen them all before, yet I enjoyed it and fully recommend it.

Steve Brazier

ROUND-UP			
NAME	Storm Warrior		
SUPPLIER	Encore	PRICE	£2.99
GRAFFIX	SONIX	PLAYABILITY	OVERALL
64%	48%	76%	72%

ACU reader survey 1989

This month we have decided to get to know you a little better, hence the survey. Before the size of this survey daunts you completely, remember, with your help we can make this magazine even better and give you what you want.

An even better reason for you to help with our readership survey is that you can win one of the many great prizes on offer to participants.

★ STAR PRIZE £250 worth of software and peripherals for YOUR computer.

★ FIFTY extra special gift vouchers for any of the hundreds of items available through our own DIRECT LINES reader service or the Amstrad User Club catalogue.

★ FIFTY of our very own ACU Binders to store your back numbers.

To make sure of your chance of winning – fill in our questionnaire as soon as possible and return it to us – post free of course! Winners will be notified by 1st November, 1989.

1. Please tell us your age and sex

- | | | | |
|----------|--------------------------|--------|--------------------------|
| Under 15 | <input type="checkbox"/> | Male | <input type="checkbox"/> |
| 15–18 | <input type="checkbox"/> | Female | <input type="checkbox"/> |
| 19–24 | <input type="checkbox"/> | | |
| 25–34 | <input type="checkbox"/> | | |
| 35–44 | <input type="checkbox"/> | | |
| 45–54 | <input type="checkbox"/> | | |
| 55–65 | <input type="checkbox"/> | | |
| Over 65 | <input type="checkbox"/> | | |

2. How long do you keep your copies of ACU?

- | | |
|---------------------|--------------------------|
| Less than one month | <input type="checkbox"/> |
| One month | <input type="checkbox"/> |
| Three months | <input type="checkbox"/> |
| Six months | <input type="checkbox"/> |
| A year or more | <input type="checkbox"/> |

3. How long do you spend reading your copy of ACU?

- Over four hours
- Two to four hours
- One to two hours
- Less than one hour

4. How long have you been a ACU reader?

- Less than three months
- Three to six months
- Seven to 12 months
- One to two years
- Two to five years

5. How regularly do you buy the magazine?

- Occasional issues
- Most issues
- Every issue

6. How much of the magazine do you read?

- Some of the articles
- Most of the articles
- All of the articles

7. Does anyone else read your copy of the magazine?

- No
- One or two other people
- Three or four other people
- More than four other people

8. If the magazine is read by other people, please give details:

Age:	Person 1	Person 2	Person 3	Person 4
Under 15				
15-18				
19-24				
25-34				
35-44				
45-54				
55-65				
Over 65				
Sex:				
Male				
Female				

9. How much attention do you pay to advertisements in ACU?

- I read through all advertisements
- I read through most advertisements
- I look at a few advertisements
- I pay no attention to the advertisements

10. How do you rate the following articles in ACU?

	Poor	Average	Good	Excellent
Combat Zone				
Microscope				
Gameplan				
Hairy Hacker				
10 Liners				
Aunty John				
Applications Advice				

11. Would you like to see more or less coverage given to the following?

	More	Less	Same
Games reviews			
Serious computing			
Listings			
General features			
Beginners advice			
Advanced advice			

12. Which of the following would you like to see featured within the magazine? (tick one only)

- Additional supplements
- Competitions
- Discount offers
- Promotional gifts on the front cover

13. Which other computer magazines do you read and how often?

	Never	Occasionally	Regularly
Amstrad Action			
ACE			
Computer and Video Games			
Popular Computing Weekly			
Other (please specify)			

14. How do those magazines compare with ACU?

	Not as good as ACU	As good as ACU	Better than ACU
Amstrad Action			
ACE			
Computer and Video Games			
Popular Computing Weekly			

15. Please give any further comments or criticisms that you feel will improve ACU.

.....

16. Are you aware of the magazine's publication date?

Yes
 No

17. If you are aware, do you attempt to buy the magazine on that day?

Yes
 No

18. How do you obtain your copy?

Newsagent shop collection
 Newsagent home delivery
 Subscription
 Chance purchase
 Passed on copy

19. If you are a subscriber, on which date did you receive this issue?

.....

20. If you are a subscriber, how long have you subscribed to this magazine?

Less than three months
 Three to six months
 Seven to 12 months
 One to two years
 Two to five years

21. If you do not subscribe, is it due to one of the following?

Subscription too expensive
 Not every issue required
 Not aware subscription service available

22. Are you aware that to subscribe to this magazine in the U.K. is the same cost as buying it in a shop?

Yes
 No

23. Would you like to receive further details on taking a subscription?

Yes
 No

24. If you have subscribed to this magazine but now lapsed, is it due to:

Subscription too expensive
 Every issue no longer required
 Lateness in receiving subscription copy
 Poor service from our subscription department

Postage
will be
paid by
licensee

Do not affix Postage Stamps if posted in
Gt Britain, Channel Islands, N Ireland
or the Isle of Man.

2



BUSINESS REPLY SERVICE
Licence No. ND1155

ACU
Gill Stevenson
Focus Magazines
Greencoat House
Francis Street
London SW1P 1DG

Fold completed form along here, seal the edges and post it. There is no need to use a stamp.



Story so Far - Vol 2

A compilation giving you the best known Elite hits from the last two years.

Although it sounds like a children's fairytale, *The Story So Far* is nothing less than the history of Elite Systems in software form. It is a compilation but it sounds a little more grandiose that way and gives you the opportunity to relive some of the best-known Elite hits from the last two years.

As compilations go there are not many games here, the rest of the catalogue doubtless being saved for *The Story So Far So Good*.

What you get for your money are *Live and Let Die*, *Overlander*, *Beyond the Ice Palace*, *Space Harrier* and *Hopping Mad*, with all but the last being reasonably well-known. *Live and Let Die* was the first Bond game of a film which was a good game. It might be called

Buggy Boy on water but it certainly was not written as a Bond game. Rather, with its speedboat-based action, it resembled one memorable sequence from the film and

thus was retitled and appropriately licensed.

The object is now to penetrate the defences of some Mr Big somewhere – all 007 films have an evil Mr Big – and destroy some drug crop. What this amounts to is racing down a narrow strip of water which does not have a bank *per se*, thus giving the

impression of bobbing up and down a blue road.

Mines and rocks litter the way, while supplies must be collected to further the high-speed 3D chase. You are armed with a gun, something a little faster and heavier than a Browning pistol, to fend off the attack from aircraft and defence bunkers.

The only other hazard is the locks, where narrow passages, rocks and mined doors block the pursuit of the clock. Although a little on the difficult side to progress too far, the graphics are good and sliding over the embankments is great fun.

Beyond the Ice Palace is a basic arcade adventure with

vertical and horizontal screen action, three types of weapons, attractive graphics and far too difficult gameplay. Good, but too difficult to appeal to anyone except a masochist.

Space Harrier is the famous 3D flying and shooting-at-the-monsters game, avoiding the ground-based scenery and the impressive end-of-level aliens. It is all done in blocky, unsatisfactory style. Even the arcade game was shallow.

Overlander is one of the gems of this collection, being a great *Roadblaster*-style, 3D racing and shooting game. Select those extra weapons, choose that mission and prepare for a great action-based racer, with heaving hills and lurching scenery. An excellent game which justifiably put noses out of joint at U.S. Gold because it was much better than *Roadblasters*.

If *Overlander* was great, *Hopping Mad* counters it by being dreadful. Graphics converted straight from a Spectrum, plenty of bouncing balloon action and insipid sonics – truly hopeless.

With three quality games, one mediocre and one very poor this is not particularly good value but then if you do not possess any of the three good ones it is worth the money.

Mark Luckham



ROUND-UP			
NAME	Story So Far –		
SUPPLIER	Elite	PRICE	£12.99
GRAFFIX	75%	SONIX	65%
PLAYABILITY	85%	OVERALL	78%

I wondered whether this game should have an 18 certificate rating. Whether innocent minds should be exposed to the proclamation 'Penetrate, Dominate, Conquer'. It sounds a little rude, to say the least. Well, in the cause of ACU, I got out the PVC boots, the rubber mask and snorkel, and the buttered toast, but it was not like that.

Dominator is all about an ageing fighter pilot – the last

real pilot and the advancing threat from outer space. Roll of the drums and off we go into vertically-scrolling shooting, with sideways scrolling on the next phase.

The combination of game styles is becoming the fashion but I have to say the vertical part fails completely to provide a reasonable arcade gaming experience.

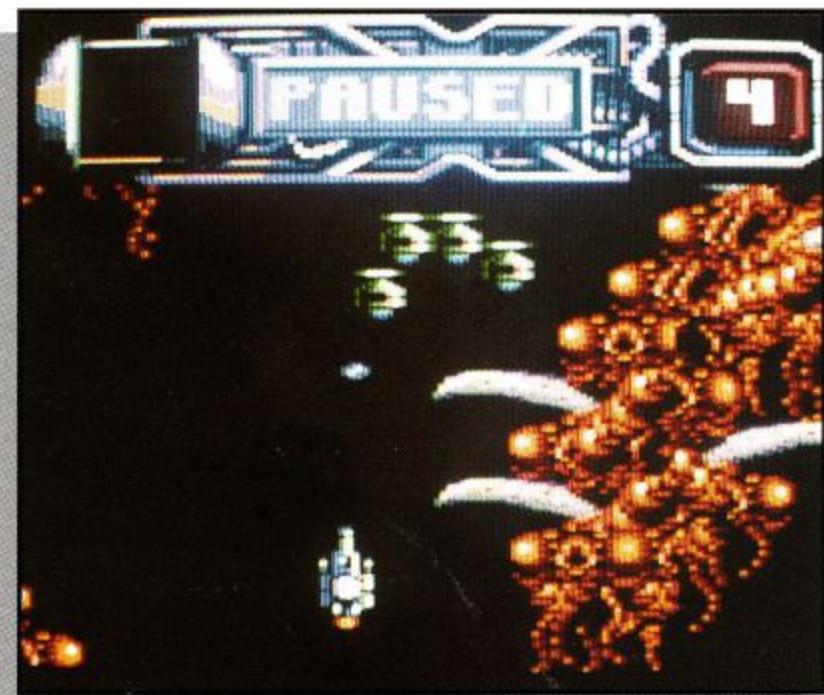
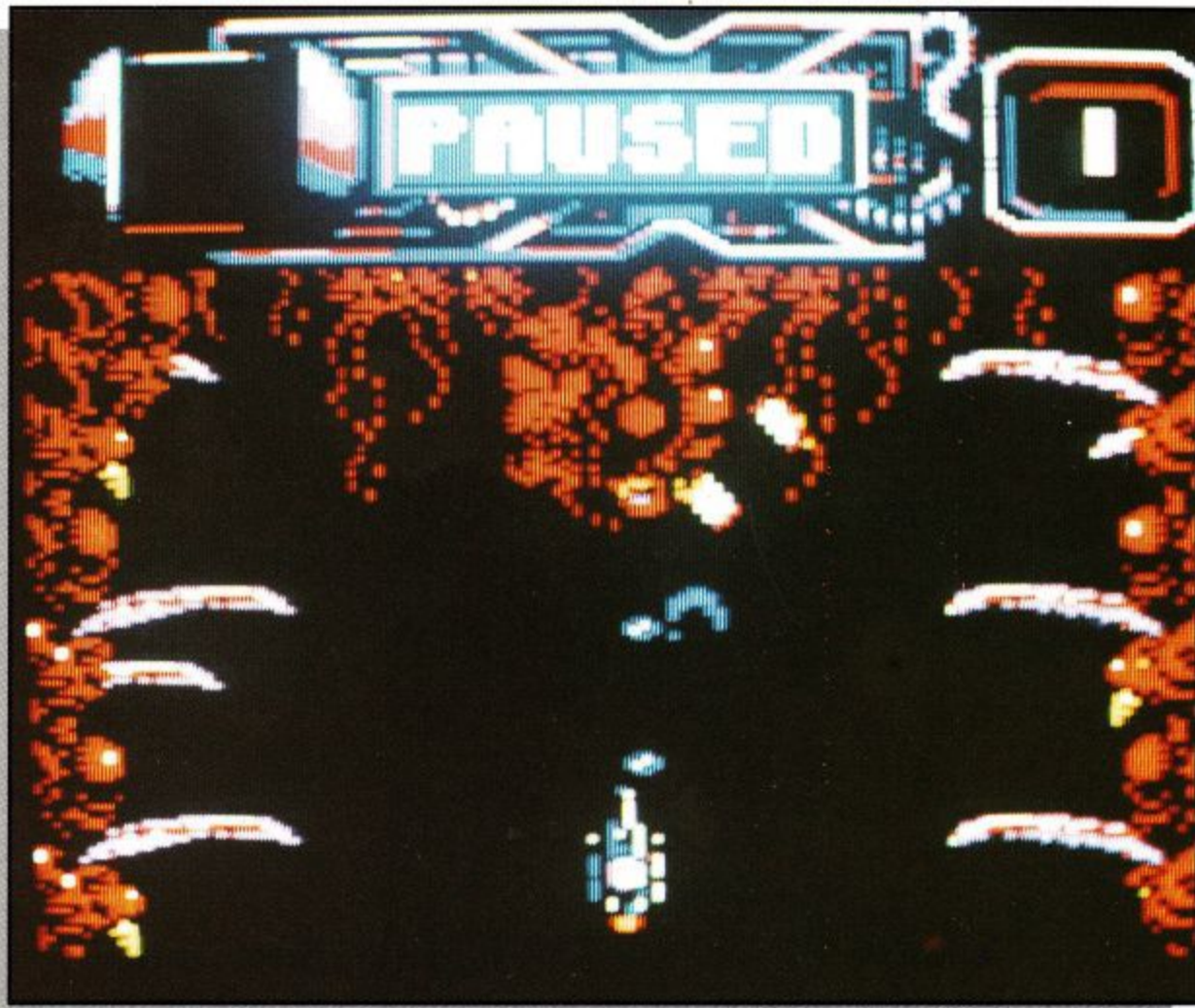

There is this thing eating everything in its path and you have to penetrate to its centre and shoot the living daylights out of it. There are bonus discs along the way, endowing extra weaponry, extra lives, points bonus, smart bombs and a cheat mode.

It does not help you overlook the fact that the scrolling is fairly slow and, unbelievably, your spaceship moves one block at a time laterally – and slowly vertically – making sharp man-

oeuvring a virtual impossibility. Thankfully the designers have measured the gap where the screen narrows to unfeasible tightness and your ship will go through with virtually nothing to spare.

The other problem is that you are playing on a reduced vertical screen so you do not have much chance to see things coming. The whole section plays like a pig – one with its feet stuck in a foot of mud at that.

The horizontal sections

Dominator

You are the last pilot in the world facing a threat from outer space.

are more playable, more entertaining but more difficult without being abnormally so. The scrolling is not too fast or smooth but you are getting real Amstrad multi-coloured graphics instead of Spectrum two-coloured blobs, so hurrah for that.

Although the first part looks as if you are through the inside of something's stomach, other screens are more hi-tech looking, with metallic pipes and steel

walls everywhere – at least you can see what is coming before it hits you.

Adequate just about sums up this one. The declaration: "It's vast appetite was closing in on Earth and the putrid smell of partly-digested nations hung ominously in space", might make it sound like an entertaining B-movie-style epic but I am afraid this is distinctly TV movie class.

Mark Luckham

		ROUND-UP	
NAME	Dominator		
SUPPLIER	Activision	PRICE	£9.99
GRAFFIX	79%	SONIX	71%
PLAYABILITY	68%	OVERALL	69%

In this latest budget blaster from Codemasters, the chaps have eschewed plot and the usual meaningless waffle in favour of straightforward violence. There is no namby-pamby messing – just get straight into that MiG-29 and go waste some sucker.

Why you are in a Soviet

wise and anti-clockwise. Everything else is there, with some rather tasty, chunky multi-colour graphics and different weapon systems.

Your first objective in this behind-the-aircraft 3D perspective game is to make it to the end of the Woodland level. It is not easy to make it

stay low and dodge hard.

You are armed with five weapon systems – bullets, bombs, air-to-ground missiles, air-to-air missiles and hydrogen bombs – and a limited supply of most of them. Catch the parachutes which float down periodically for the ammunition and also to replenish your fuel supply.

At certain points a big helicopter appears in front of you, which means that it can fly backwards at Mach 2, I suppose, and it can be downed only by an air-to-air missile, so make sure you do not use them all by then.

You might have thought that using a hydrogen bomb at very low altitude might be somewhat fatal but your air-



craft is obviously solid lead and warp engine-powered, because only the assembled enemies are fried, crisped and dried – even the Russians use smart bombs these days.

After the woodland there is desert with cacti; tropical, sea and Arctic with Eskimos fishing, landscapes to jet over, with a bonus screen of floating weapons to replenish your rapidly-dwindling stocks in the middle of it all.

It is a pity the sound effects are poor because the music, although somewhat tinny, is acceptable and the graphics are very good. The speed of objects scrolling

towards you is impressively fast, while the action is always thick and tense.

After a number of really disappointing releases from Codemasters, it is good to see an unpretentious budget thrash which is worth playing. MiG-29 may not be the most sophisticated of games but with the intense concentration required to select the proper weapon system at the correct time in the midst of a gunfight, it certainly beats Afterburner in my novella.

Mark Luckham

MiG-29

A budget blaster in the style of Afterburner. No messing, just go and waste some sucker.



fighter is not explained but if you watch Clint Eastwood's *Firefox* before you play, then you will have a feel for it. Either that or play *Afterburner*, of which this is the budget version. I would go so far as to say that MiG-29 is an *Afterburner* simulator, even if the horizon tilts only up and down, and does not swing clock-

without losing the odd life, as the tanks on the ground and the aircraft in the air are all bent on your destruction. Thankfully the aircraft

never seems to fire below a certain point, so the best strategy appears to be to

ROUND-UP			
NAME	Mig-29		
SUPPLIER	Codemasters	PRICE	£2.99
GRAFFIX	58%	PLAYABILITY	75%
SONIX	85%	OVERALL	73%



Gemini Wing

Die mutant alien scum.

When the headline Die Mutant Alien Scum appeared on the front page of the Soon-Day Spirit, all hell broke loose. Generation after generation of newspaper, not magazine, journalists had flaunted the good name of little green men everywhere and enough was enough. As a result, the entire galaxy declared war on the Earth. All would have been lost were it not for the dreaded Gemini project.

Once again the cutting edge of science brings forth

the doomsday machine, the only craft capable of defeating the alien hordes, and you, the perfect pilot for such a craft. Of course, the Gemini craft have one rather special advantage, the gumball. Those rather peculiar weapon pods form a tail on the back of your craft.

Holding down the fire button causes the gumball nearest your craft to detonate. With such devastating devices as the wall of flame and the infamous wind-screen wiper of death, it



sounds like a huge wind-screen wiper composed of fireballs; little can stand before it. Of course, the rest of the galaxy is not exactly messing around.

When you first experience the starting level you can be forgiven if you despair a little. At first the alien hordes overwhelm the senses; never before has the Amstrad screen been so busy. Endless lives disappear before your eyes as you try to assimilate the action and dodge the bullets.

This is made a little more difficult by the lack of colours on the Amstrad, because there is so much happening and insufficient colours to separate one sprite

only with the living aliens but with the landscapes, which although not slimy and pulsating, definitely give the impression of being alive at some stage in development. Each level has the obligatory mega alien which ranges from the salmon head to the worms emerging from a displaced snout.

As you blast your way to victory, watch for the clawed aliens. Destroying them liberates gumballs which can be collected and added to your trailing arsenal. Each time you complete a level you are given a password. If it is entered at the start of the program you will start the game from the appropriate level. What is more, each time you die you



clearly from another. You learn to distinguish between sprites, given a little practice.

The action is constant but to puzzle the complacent player each level has its particular way of dealing with your ship. The general feel of the game is organic, not

do not go back to level 1 but to the beginning of the level indicated by the password.

This must be one of the fastest and busiest shoot-'em-ups on the market - real frontier work on your Amstrad.

Adrian Pumphrey

ROUND-UP			
NAME			
SUPPLIER	Mastertronic	PRICE	£9.99
83%	70%	78%	80%
GRAFFIX	SONIX	PLAYABILITY	OVERALL

right, which makes the game doubly difficult.

The dice are manipulated by rotating a set of four. In the first few levels of the game the cursor can be moved round any set of four but by level six the cursor is

restricted to certain areas and completion in the time limit is almost impossible.

In the beginning, players will think that Mind Trap is a doddle but when past the first few levels things begin to become more difficult. As the time counts down you are no nearer to completing it than 30 seconds ago and you have only a short time left.

Mind Trap will keep the most ardent puzzle solver bemused for hours. Each time you play the puzzles are slightly different. The shapes stay the same but the positions of the dice change, thus providing a different puzzle each time you play.

Andrew Banner

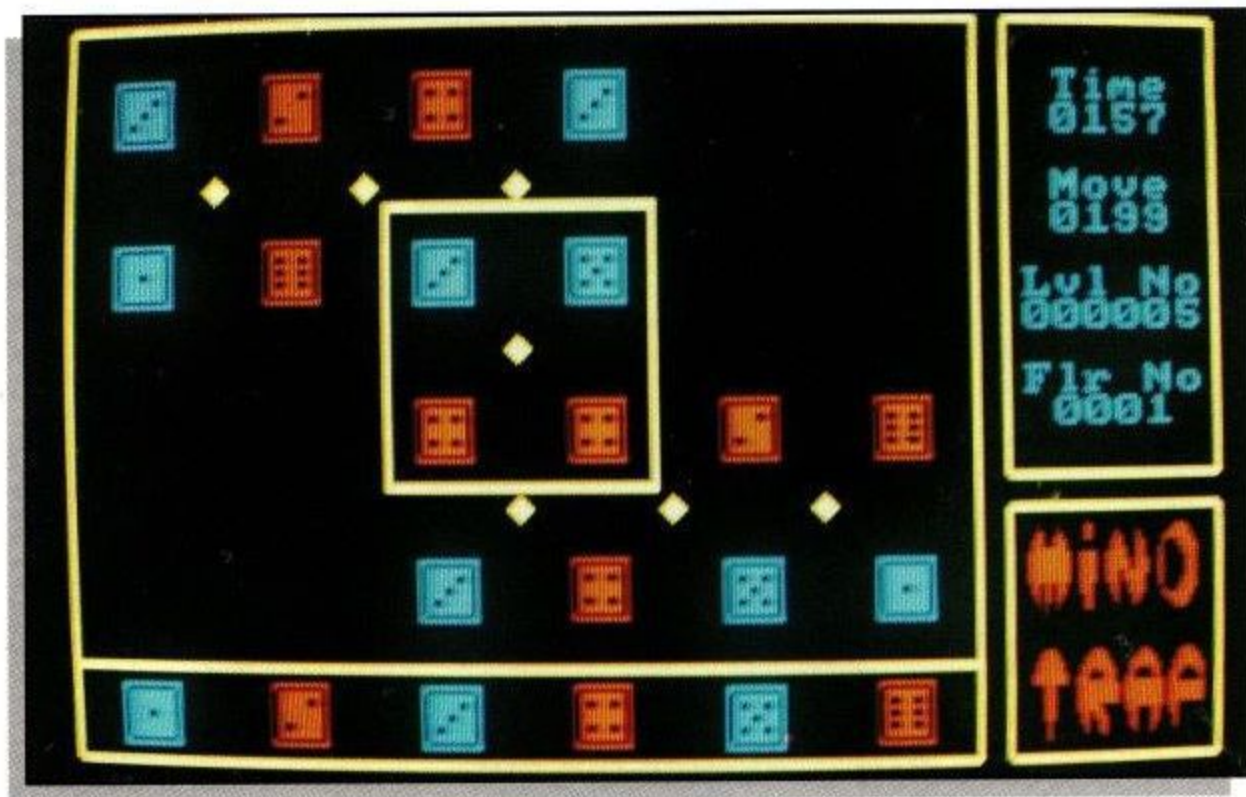

MINDTRAP

ence. A series of dice are displayed in a particular shape. Only one side of the dice is shown and the whole shape consists of dice with different numbers shown.

The object is to manipulate the dice so that each column on the shape consists of the same number. The columns must also be in number order from left to

Another puzzle game trying to follow up the success of Tetris.

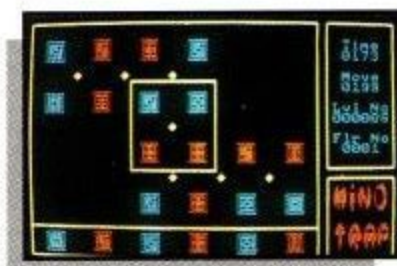

can sit there fiddling, never stopping. For innocent on-lookers, train spotting would seem more appealing. Until recently, puzzles have been restricted to physical objects or have been written on paper. Computer puzzle games are, perhaps, more

In the mists of time, mathematicians were composing puzzles for people to solve. Today you can walk into a games or toy shop and buy a puzzle, such as the infamous Chinese puzzles where you have to separate two shaped pieces of sprung metal.

Rubic has had thousands of people scratching their heads with his infernal cube and fiendishly clever Rubic's Magic, not to mention the cleverly-designed and difficult clock.

Many people love solving puzzles set by others. They

varied and interesting. One of the most publicised puzzle games is Tetris. This game from the U.S.S.R. involves fitting shaped objects in a line before they fill the screen area.

Today, puzzle games have not become any more sophisticated but they are varied. Take, for instance, Mind Trap, a game which is not so much exciting as interesting. Mind Trap is a problem-solving game with a differ-

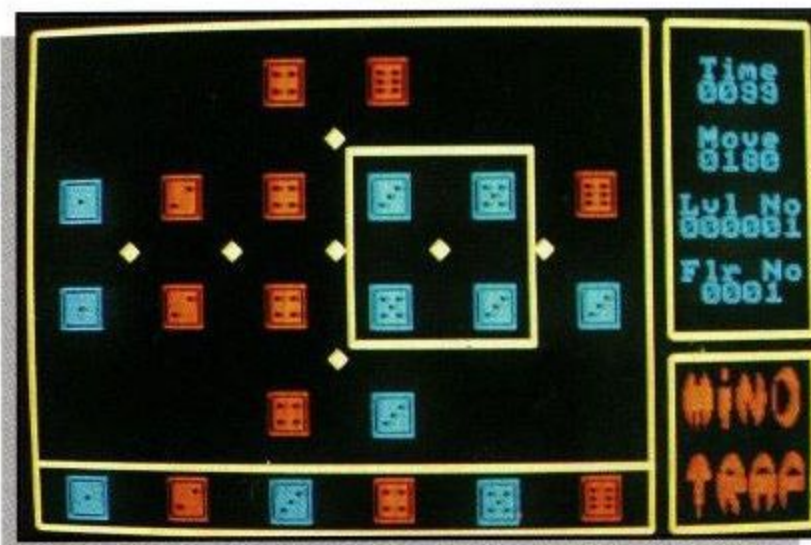

ROUND-UP			
NAME	Mindtrap		
SUPPLIER	Mastertronic	PRICE	£2.99
GRAFFIX	31%	SONIX	27%
PLAYABILITY	52%	OVERALL	48%

Bond may have lost his licence to kill but his licence to thrill is intact and in constant use. If you thought the film was a hair-raiser, just wait until you see the game. Six sub-games combine to bring you the escapades of Bond in one explosive package.

For once the Amstrad has been programmed correctly. Multi-coloured sprites, reasonably fast action and some well-placed thuds and whacks to accompany the action.

Life starts with Bond and Felix chasing the drug baron Sanchez. Understandably, trying to avoid capture Sanchez has left a few men behind to slow Bond a little by blowing him out of the



Licence To Kill

Shaken but not stirred.

leave behind some for you to re-cycle.

Next is one of the more spectacular stunts from the film and a remarkably easy level of the game. Bond swings on a rope dangling from the helicopter; as the helicopter pilot you must guide Bond over the tail of the aircraft in which Sanchez is making his getaway. Capturing the tail means you can haul in your catch and prepare for the next level.

It is time to get your feet wet as you stick the frogmen with your knife and fire captured harpoons at the escaping seaplane hoping to catch a lift. To kill the divers and avoid the flak from the dinghies Bond can dive underwater. Unfortunately he can hold his breath only for so long, which means he can pop up at the most awkward times. If you catch a lift, watch for the rocks as the seaplane tries to dash its unwelcome guest.

The final section is reminiscent of that old classic *Spy Hunter*, only this time it is truck versus truck. Ramming the other 18-wheelers off the road is great fun until you catch up with Sanchez. Like all villains he has to cheat and, instead of using skill to remove you from the road, he tends to use a rocket launcher.

Such things do not bother Bond and although I know what happens in the film I will let you decide the outcome of this little epic on your Amstrad.

Adrian Pumphrey

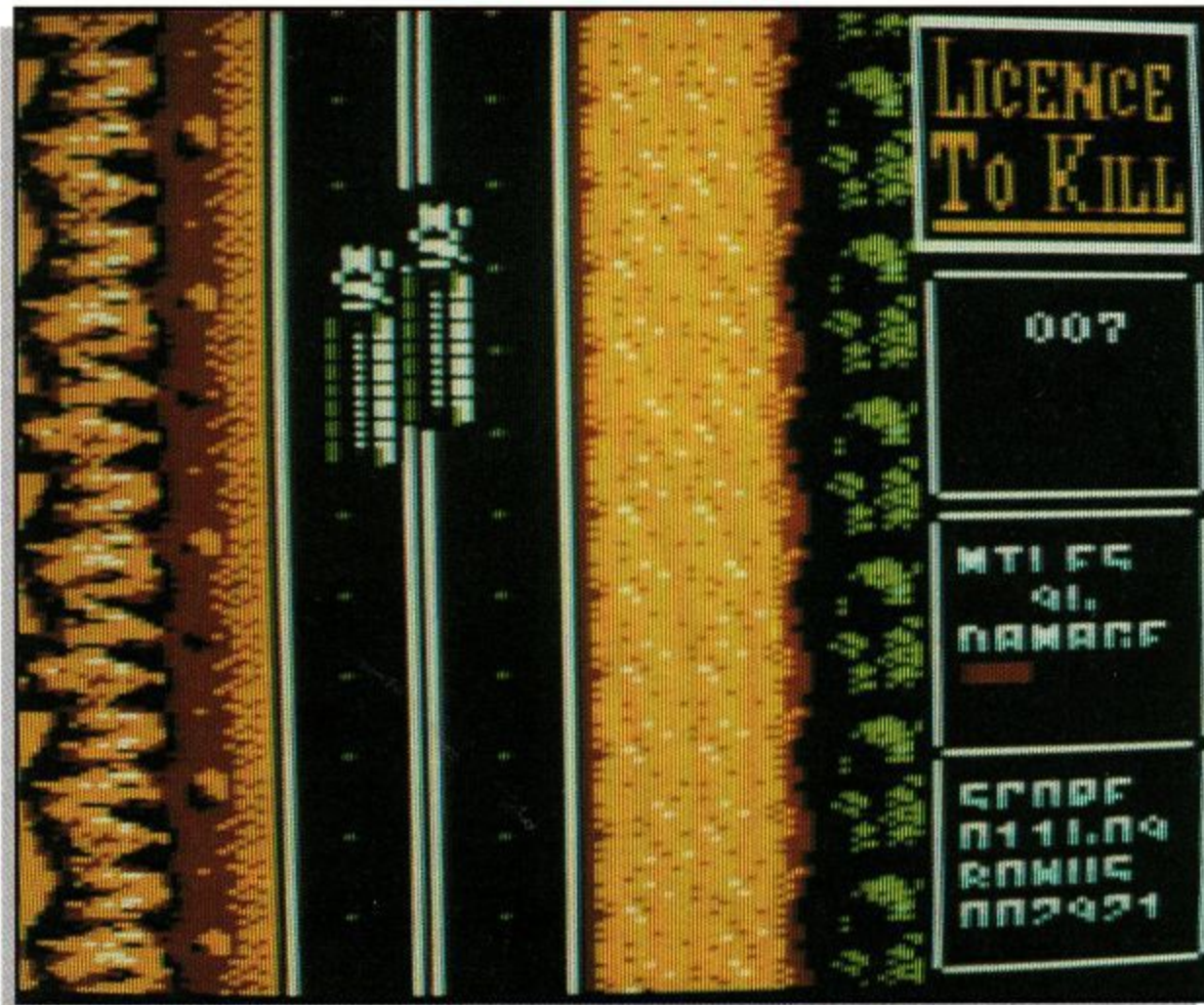

sky. Bond fights back by blasting the gun emplacements and weaving between their deadly hail.

Weaving presents its own problems, as you have to decrease your height to move forward, which leads to those all-too-probable collisions with the taller buildings.

Being a super kind of guy, Bond waltzes through this

section to confront the men on foot. In this section the 16-bit versions failed miserably but not so on the Amstrad. Bond can aim his gun by holding down the fire button and rotating the sights round his stationary figure.

This can waste ammunition, so make sure that you have ample supplies or that the villains you are wasting

ROUND-UP			
NAME	Licence To Kill		
SUPPLIER	Domark	PRICE	£9.99
GRAFFIX	82%	SONIX	78%
PLAYABILITY	83%	OVERALL	84%

Hack Attack

There's no poke with
out fire with the Hairy
Hacker



Chris Wootton of Mornington, Australia has saved me work by sending pokes and he has done it again with this one for *Singe's Lair*. You have to wind the tape past the file called DL2 before running this pokette:

See Fig. 1

Now, with infinite lives, it will not matter how many times you get singed.

His next is for *Satellite Warrior* and Wootton receives all the credit. The

“It will not matter how many times you get singed.”

Satellite Warrior pokette has been in the wars a bit, so if you see a line running through it, it is just an operation scar from the art department and you need not try to type it in.

See Fig. 2

Wootton has also hunted down and killed the battery in *Hunter Killer*. The battery has been replaced with a new, infinite energy cell with a copper-coloured top. No other energy cells

Fig. 1

```
1 'Escape from Singe's Lair Tape Poke
2 'by Chris Wootton
3 'Poke provides infinite lives
4 'Wind past DL2 then RUN
5 '
10 FOR a=&BF00 TO &BF10
20 READ a$:POKE a,VAL("&" + a$)
30 NEXT:CALL &BF00
40 '
50 DATA 21,00,03,11,00,7d,cd,a1,bc
60 DATA 3e,a7,32,3d,7d,c3,43,1b
```

Fig. 2

```
1 'Satellite Warrior Tape Poke
2 'by Chris Wootton
3 'Poke provides 5000 credits
4 'for player 1 (on skill 0)
5 '
10 MEMORY &1FFF
20 LOAD"!piccy.obj",&2000
30 LOAD"!part1.obj"
40 LOAD"!part2.obj"
50 LOAD"!data.obj"
60 POKE &8171,0:POKE &8172,&50
70 POKE &8121,1:CALL &3E00
```

look like it or last like it. You will have to wind past the file called Hunter Killer on the tape. Here is the poke, and I hope you do not mind being wound up:

See Fig. 3

Wootton also has a pokeling for infinite time on *Enduro Racer*. I know we have hacked it to death but I am still receiving letters about it. So, here, and perhaps for the final time, is a pokette for *Enduro Racer*:

See Fig. 4

A quick little cheat sent by G. Smith of Blackford for *Gauntlet II*. It works on both the Gauntlets – the adventure, not the Defender game – but the principle is the same. You need to be in two-player mode and when one character dies, press magic and fire and you are re-incarnated. The best

characters are Merlin and Thor. Give the potions to Merlin and try to use them before he snuffs it.

Michael Gledhill from Tavistock – in close co-operation with Conan the Barbarian, who is visiting Tavistock temporarily – has sent the odd pokette. He also sent instructions in German, with sub-titles in English. They were unprintable and a translation of the basic text appears below:

He has hacked *Savage*, after several hundred winks while it loaded, and has now wrung infinite lives from it. You also are invulnerable to the foul

continued over



Fig. 3

```

1 'Hunter Killer Tape Poke
2 'by Chris Wootton
3 'Poke provides infinite battery charge
4 'Wind past HUNTER KILLER then RUN
5 '
100 SYMBOL AFTER 31:MEMORY &7FFF:BORDER 0
110 INK 0,0:INK 1,24:INK 2,15:INK 3,6
120 MODE 1:LOAD"!":LOAD"!":CALL 39381,60,60
130 FOR a=&BF00 TO &BF23
140 READ a$:POKE a,VAL("&"a$)
150 NEXT:CALL &BF00:RUN"!":
155 '
160 DATA 01,03,00,11,24,bf,21,7a,bc
170 DATA ed,b0,3e,c3,32,7a,bc,21,17
180 DATA bf,22,7b,bc,c9,f5,3e,0e,32:
190 DATA 2c,12,32,2a,12,f1,c3,24,bf
    
```

Fig. 4

```

1 'Enduro Racer Tape Poke
2 'by Chris Wootton
3 'Poke provides infinite time
4 'to complete each stage
5 '
10 OPENOUT"a":MEMORY &7FF:MODE 1
20 INK 0,0:INK 1,0:INK 2,0:INK 3,0
30 BORDER 0:LOAD"!entt1":CALL &4000
40 INK 1,24:INK 2,23:INK 3,8
50 LOAD"!encode":POKE &655D,0
60 POKE &655E,0:POKE &655F,0
70 CALL &4000
    
```

K & M COMPUTERS

THE LEADING AMSTRAD MAIL ORDER SPECIALISTS

ADVENTURE	Cass	Disc
Time and Magik.....	£11.25	£11.25
Gnome II: Ingrid's Back.....	£11.25	£14.75
Pawn (6128).....		£14.75

COMPILATIONS	Cass	Disc
Heatwave.....	£10.50	£13.99
Soccer Spectacular.....	£10.50	£13.10
Special Action.....	£10.50	£13.99
The Story So Far (Vol 2).....	£10.25	£11.25
The In Crowd.....	£11.25	
History in the Making.....	£15.95	£21.50
Taito Coin-op (Inc Rastan).....	£9.90	
Supreme Challenge (Incl Elite).....	£9.90	£13.10
Gold, Silver & Bronze.....	£11.25	£21.50
Giants.....	£10.50	£15.95
Flight Ace.....	£11.25	£13.95
Arcade Muscle.....	£10.50	£15.95
Command Performance.....	£9.90	£15.95
Par 3.....	£11.25	£15.95
We Are the Champions.....	£7.75	£13.10
Game, Set & Match.....	£9.99	£13.10
Game, Set & Match II.....	£9.90	£13.10
Space Ace.....	£10.50	£11.25
KidsPlay.....	£2.99	

STRATEGY/SIMULATION	Cass	Disc
Kenny Dalglish.....	£7.75	
Football Manager II.....	£7.75	£11.25
F'ball Man. II Expansion Kit.....	£6.25	£7.25
Football Director II.....		£14.75
Gunship.....	£11.25	£14.75
Ancient Battles.....	£11.25	
Micropose Soccer.....	£11.25	£14.75
Times of Lore.....	£7.75	£11.25
Chuck Yeagers Ad. Trainer.....	£7.75	£11.25
3D Pool.....	£7.75	£11.25
Bards Tale.....	£2.75	£6.25
Question of Sport.....	£9.99	£14.75
Football Director (464).....	£7.75	
Roy of the Rovers.....	£7.75	£11.25
The National.....	£7.75	
War in Middle Earth.....	£7.75	£11.25
Heroes of The Lance.....	£7.75	£15.90
Airborne Ranger.....	£11.25	£14.75
Trivial Pursuit (New Edition).....	£11.25	£14.75
Emlyn Hughes Soccer.....	£7.75	£11.25
Track-Suit Manager.....	£7.75	£11.25
Laser Squad N.....	£7.75	£11.25
4 Soccer Simulator.....	£7.75	£11.25
Archon Collection.....	£2.75	£6.25
Classic Games 4.....	£7.75	£11.25
Carrier Command N.....		£Phone

EDUCATIONAL	Cass	Disc
Answer Back Jnr.....	£7.95	£11.95
Factfile 500s.....	£3.75	£6.75
Fun School (USs 5-8, 8-12).....	£5.50	£7.95
Maxi Maths (Geometry).....	£8.50	£13.95
The Three Bears (6128).....		£15.95
Happy Breathing (12-16).....		£13.95
Magic Maths (4-8).....	£8.50	£12.95
Maths Mania (8-12).....	£8.50	£12.95
Chemistry GCSE.....	£11.90	£14.95
Physics GCSE.....	£11.90	£14.95
Biology I (12-16).....	£8.50	£12.95
Wordhang.....	£7.50	£11.95
Happy Writing.....	£7.50	£11.95
Physics I 12-16.....	£8.50	£13.95
Mapwork Geography Quiz.....	£8.50	£13.95
Spanish Tutor.....	£12.95	£15.95
French Mistress.....	£12.95	£15.95
German Master.....	£12.95	£15.95
Iankey Crash Course (6128/PCW).....		£19.90
Iankey Two Finger (6128/PCW).....		£19.90
Fun School 2 (USs, 6-8, 8+).....	£7.99	£9.99
Happy Fractions (12-16).....		£13.95

ARCADE*	Cass	Disc
Thunderbirds.....	£10.25	£11.25
All New Ghostbusters.....	£7.75	£11.25
Run The Gauntlet.....	£7.75	£11.25
Dominator.....	£7.75	£11.25
Vigilante N.....	£7.75	£11.25
H.A.T.E.....	£7.75	£11.25
Robocop.....	£7.75	£11.25
Skweek.....	£7.75	£11.25
StormLord.....	£7.75	£11.25
New Zealand Story.....	£7.75	£11.25
Indy (Last Crusade) N.....	£7.75	£11.25
Super Scramble.....	£7.75	£11.25
Barbarian II.....	£7.75	£11.25
Forgotten Worlds.....	£7.75	£11.25
Red Heat.....	£7.75	£11.25
Crazy Cars II.....	£7.75	£11.25
Gemini Wing N.....	£7.75	£11.25
Afterburner.....	£7.75	£11.25
Navy Moves.....	£7.75	£11.25
Munsters.....	£7.75	£11.25
WEC Le Mans.....	£7.75	£11.25
Silkworm.....	£7.75	£11.25
Vindicators.....	£7.75	£11.25
APB N.....	£7.75	£11.25
Purple Satin Day N.....	£11.25	£14.45
Operation Neptune N.....	£7.75	£11.25
Licence To Kill.....	£7.75	£11.25
Blasteroids.....	£7.75	£11.25
Batman (New).....	£7.75	£11.25
Dragon Ninja.....	£7.75	£11.25
Superman.....	£7.75	£11.25
Gilbert.....	£7.75	£11.25
Rick Dangerous.....	£7.75	£11.25
Butcher Hill.....	£7.75	£11.25
Titan (Special Price).....	£6.99	£10.25
Renegade III.....	£7.75	£11.25
Xybots.....	£7.75	£11.25
High Steel.....	£7.75	£11.25

BUDGET	Cass only
Spy Hunter.....	£2.75
Battleships.....	£1.80
Quest/Golden Eggcup.....	£1.80
Split Personalities.....	£1.60
Frank Bruno Boxing.....	£1.80
Super Trolley.....	£1.80
Trantor.....	£2.75
Turbo Esprit.....	£1.80
BMX Simulator II.....	£2.75
Ghostbusters.....	£1.80
720.....	£2.75
Formula Grand Prix.....	£1.80
A.T.V. Simulator.....	£2.75
Rugby Boss.....	£1.80
Mig 29.....	£2.75
Moto X Sim.....	£2.75
Ace II.....	£2.75
Bombjack.....	£1.80
Twin Turbo VS.....	£2.75
Shockway Rider.....	£2.75
B.M.X. Freestyle.....	£2.75
Roadrunner.....	£2.75
Kikstart II.....	£1.80
Rocky Horror Show.....	£1.80
Postman Pat.....	£1.80
Jocky Wilson Darts.....	£2.75
Grand Prix Sim 2.....	£2.75
Green Beret.....	£2.75
Treasure Island Dizzy.....	£2.75
FastFood.....	£2.75
Adv Pinball Sim.....	£2.75
Gauntlet II.....	£2.75
1942.....	£2.75
Blackbeard.....	£2.75
Street Cred Boxing.....	£2.75

LOWEST PRICES AVAILABLE ON PRINTER RIBBONS

SPECIAL PRICES ON A.M.S. SOFTWARE

Stop Press.....	£39.95
Stop Press & Mouse.....	£72.95
Mouse & Art.....	£61.95
Mouse Mats.....	£4.95
Max.....	£16.95
Extra Extra.....	£21.95

KDS ELECTRONICS SPECIAL OFFERS

Rombox.....	£24.95
5 1/2" Second Drive.....	£158.95
8 Bit Pr Port.....	£18.75
Serial Int + Rom.....	£44.95
Printer T Switch.....	£24.95
Screen Master.....	£14.95
Ramdos (Disc).....	£23.95
Romdos (Rom).....	£27.95

KDS Modems are no longer available

MINI OFFICE II STILL OUR No. 1 SELLER

Cass £11.25 Disc £14.75

AMSOFT/MAXELL 3" DISCS

One.....	£2.50
Five.....	£12.50
Ten.....	£24.95
5 1/2" DISCS TEN.....	£3.90
3 1/2" DISCS TEN.....	£9.50

A SWIFT REDUCTION ON ARNOR PRODUCTS

Protext.....	Disc £18.45
Protext.....	Rom £28.45
Promerge.....	Disc £18.45
Promerge+.....	Rom £23.45
Prospell.....	Disc £17.45
Prospell.....	Rom £23.45
Maxam.....	Disc £18.45
Maxam.....	Rom £28.45
Maxam 1.5.....	Rom £21.45
Utopia.....	Rom £21.45

ALL PRICES INCLUDE VAT & P&P IN U.K.

In stock items sent by return of post

SPECIAL OFFER ORDER ANY FIVE £1.80 BUDGET GAMES AND PAY ONLY £8.00

DMP 2000/2160/3000 RIBBONS

£3.25.....	EACH
£5.99.....	FOR TWO
£13.50.....	FOR FIVE

ACCESSORIES

Rombo Rombox.....	£34.95
464 Keyboard Ext Leads.....	£6.99
6128 Keyboard Ext Leads.....	£7.99
Cover Set 464 or 6128.....	£7.50
Cover Set DMP 2000/2160.....	£4.50
3" Drive Cleaner.....	£4.99
Cassette Player and Leads.....	£19.99
6128 Cassette Leads.....	£3.50
Lockable 3" Disc Boxes.....	£9.99
AMS 3DL Disc Box.....	£12.50

JOYSTICKS

Superboard.....	£18.50
Cheetah Starfighter.....	£13.95
Konix Navigator.....	£13.95
Gunshot.....	£5.75
Quickjoy II Turbo.....	£10.50
Cheetah 125+.....	£7.95
Supercharger.....	£12.95
Cheetah Challenger.....	£4.75
Konix Autofire.....	£11.95
Konix Speedking.....	£9.99
Cruiser (Microswitch).....	£9.50
Delta.....	£9.50
Wico Ergostik.....	£17.75
Amstrad JY2.....	£13.95
Cheetah Mach I.....	£10.95
Quickjoy II.....	£8.50
Quickjoy Turbo.....	£10.50

BUS/UTILITIES

Adv Art Studio.....	£19.99
Joystick Splitter.....	£7.95
Tasword 6128.....	£19.95
Money Manager.....	£24.95
Mastercalc 128.....	£27.95
Qualitas +.....	£12.95
Masterfile 3.....	£32.95
Plan-It.....	£14.75
Professional Adv Writer.....	£24.95
Art studio and Mouse.....	£49.95
Tasspell.....	£13.95

HARDWARE ETC

2160 Printer.....	£159.95
DD1 Disc Drive.....	£159.95
MP2 Modulators.....	£29.95
FD1 Second Drive.....	£99.95
64K Memory Expansion.....	£47.95
Screen/Filter.....	£19.99
Eprom storage Box.....	£1.99
Cont Paper 2000 60g.....	£18.50
Cont Paper 2000 80g.....	£20.50
Mouse Mats.....	£4.95
Surge Plug.....	£12.50
CIS Cassettes.....	45p
Fanfold labels (1000).....	£5.90
Mouse Mouse.....	£3.95
RS232 with Commstar.....	£55.95
Printer Cable.....	£9.99

NEW LINES AT LOWEST PRICES

Atari ST Super Pack.....	£360.00
Amiga A500 Inc Mod.....	£370.00
PCW8256 (Inc VAT).....	£389.00
PCW8512 (Inc VAT).....	£499.00
PCW9512 (Inc VAT).....	£510.00
PP0512 (Inc VAT).....	£449.00
PC0512 (Inc VAT) from.....	£449.00
PC1640 (Inc VAT) from.....	£550.00
PC2086 (Inc VAT) from.....	£675.00

PCW OWNERS WRITE OR PHONE FOR NEW CATALOGUE PC200 SOFTWARE AVAILABLE PRICES IN THIS ADVERT ARE FOR AMSTRAD 464/6128

THE MAGNUM LIGHT RUN WITH SIX FREE GAMES INCLUDING 'OPERATION WOLF' PLEASE STATE 464 OR 6128 ONLY £32.95 FROM US

K & M COMPUTERS (CPC)
140 SANDY LANE CENTRE
SKELMERSDALE
LANCS WN8 8LH

ALL ITEMS ARE SUBJECT TO AVAILABILITY

WHEN ORDERING PLEASE STATE MAKE OF COMPUTER.
PLEASE MAKE CHEQUES & P.O. PAYABLE TO K & M COMPUTERS.
OVERSEAS INC. EIRE ADD £1 PER ITEM OF SOFTWARE.
WE SUPPLY GOVERNMENT & EDUCATIONAL ESTABLISHMENTS.

ACCESS ORDERS BY PHONE OR MAIL
N = NEW RELEASE
PLEASE PHONE FOR AVAILABILITY
AND OTHER NEW RELEASES



24 HRS PHONE (0695) 29046

SHOP OPEN 9-6 MON TO SAT

PROP. K. FAIRHURST

flying fiends but jumping into the fire is a bad idea. It sounds like a fun poke, and here it is:

```

1 ' Savage poke
2 ' By Michael Gledhill
3 'WOT NO UTILITIES ?!
10 MEMORY &9FFF;LOAD"level1!"
20 FOR n=0 TO 15:READ a
30 INK n,a;NEXT
40 DATA 0,3,6,16,15,24,26,9
50 DATA 18,11,1,2,4,13,0,8
60 ch=0;MODE 1
70 FOR n=&BF00 TO &BF26
80 READ a$:a=VAL("&"a$)
90 POKE n,a;ch=ch+a
100 NEXT:IF ch=3558 THEN 130
110 PRINT"Data error !"
120 END
130 CALL &BF00
140 DATA 01,01,bc,ed,49,01
150 DATA 20,bd,ed,49,3e,c9
160 DATA 32,32,bc,3e,c3,32
170 DATA 4a,a0,cd,03,a0,af
180 DATA 32,45,0d,32,18,08
190 DATA 32,2e,08,32,57,04
200 DATA c3,4d,a0
    
```

Gledhill also noticed that the password for level 2 is coded as SAB-BATTA - but where is level 2?

He has also done *Brainstorm*. He has fixed it so that you can manipulate the internal temporal reference mechanism. You can fiddle the clock speed; 1 is fast, 3 is normal and 7 is slow motion. You can also fix the time needed to do a screen, or even fix things so that you cannot fail the screen. It is all explained in the following pokelet:

```

1 'Brainstorm poke
2 'Michael Gledhill
3 ' 2,4,89
10 FOR n=&BE00 TO &BE30:READ a$
11 POKE n,VAL("&"a$);NEXT
12 DATA 2a,5b,bb,22,38,bd,2a
13 DATA 0f,bc,22,2f,be,21,0e
14 DATA bc,36,c3,23,36,1a,23
15 DATA 36,be,c3,00,3e,b7,20
16 DATA 11,3e,07,32,5f,89,21
17 DATA 00,00,22,00,80,3e,da
18 DATA 32,5a,81,af,cf,00,00
20 MEMORY &2FFF;LOAD"Brain1"
21 INK 2,7;INK 3,13;MODE 1
22 WINDOW#1,14,26,10,10
23 WINDOW#2,14,26,13,13
    
```

continued

```

24 INPUT"Clock speed (1,3 or 7) ",a
25 INPUT"Time (normally 400) ",b
26 INPUT"Can't die (Y/N) ",a$
27 POKE &BE1E,a
28 POKE &BE23,b AND 255
29 POKE &BE24,(b-(b AND 255))/256
30 IF a$="n" THEN 32
31 POKE &BE29,1
32 CLS;CALL &BE00
    
```

Now for a good pokette for *Ninja Scooter Simulator*. Like the *Brainstorm* pokette, you can alter the clock speed from 1-7 but Gledhill has tacked on another piece which fixes colours so that people with greenish monitors can see the potholes. This is it:

```

1 'Ninja scooter poke
2 'Michael Gledhill
3 ' 2,4,89
10 FOR n=&BE00 TO &BE2A:READ a$
11 POKE n,VAL("&"a$);NEXT
12 DATA 2a,5b,bb,22,38,bd,2a
13 DATA 0f,bc,22,29,be,21,0e
14 DATA bc,36,c3,23,36,1a,23
15 DATA 36,be,c3,00,3e,b7,20
16 DATA 0b,3e,07,32,74,69,3e
17 DATA 01,32,c5,6a,af,cf,00,00
20 MEMORY &2FFF;LOAD"scooter1"
21 INK 2,7;INK 3,13;MODE 1
22 WINDOW#1,14,26,10,10
23 WINDOW#2,14,26,13,13
24 INPUT"Clock speed (1,3 or 7) ",a
25 POKE &BE1E,a
26 INPUT"Green screen (Y/N) ";a$
27 IF a$="n" THEN 29
28 POKE &BE23,7
29 CLS;CALL &BE00
    
```

Another wheeled wonder pokette now for *Skateboard*. This improves your life expectancy more than a crash helmet. So, for all tip-tapping and 180° Daffy Duck merchants, here it is:

```

1 'Skateboard Kidz
2 'Michael Gledhill
3 ' 2,4,89
10 FOR n=&BE00 TO &BE2A:READ a$
11 POKE n,VAL("&"a$);NEXT
12 DATA 2a,5b,bb,22,38,bd,2a
13 DATA 0f,bc,22,29,be,21,0e
14 DATA bc,36,c3,23,36,1a,23
15 DATA 36,be,c3,00,3e,b7,28
16 DATA 0b,3e,c8,32,fc,29,3e
    
```

continued

```

17 DATA 05,32,3f,20,af,cf,00,00
20 MEMORY &2FFF;LOAD"skatel"
21 INK 2,7;INK 3,13;MODE 1
22 WINDOW#1,14,26,10,10
23 WINDOW#2,14,26,13,13
24 INPUT"How many lives ";a
25 POKE &BE23,a
26 INPUT"Infinite energy (Y/N) ";a$
27 IF a$="n" THEN 29
28 POKE &BE1E,0
29 CLS;CALL &BE00
    
```

For those who have bought *Cholo*, this is for you. Be careful, because I know there were two versions of *Cholo*. The first few had a bug which caused them to crash with monotonous regularity. This has now been fixed and I think this one is for the fixed version.

The first poke lets you walk on the water, without the aid of conspicuously large inflatable sandals. The next prevents you getting so much radiation damage and the third prevents you getting shot.

There is also a list of passwords which I have set as part of the listing:

```

10 ' Cholo
11 ' Michael Gledhill
12 ' (Written to avoid revision)
13 a=&1000;MODE 1
14 READ a$:IF a$="**" THEN 18
15 POKE a,VAL("&"a$)
16 a=a+1;GOTO 14
18 INK 0,0;INK 1,11
19 INK 2,6;INK 3,26
20 CALL &1000;RUN"Cholo"
21 DATA 21,32,bc,36,c3,23
22 DATA 36,0c,23,36,10,c9
23 ' Walk on water
24 DATA 3e,18,32,8a,9c,32
25 DATA ce,9d
26 ' Radiation less harmful
27 DATA af,32,1e,68
28 ' Can't get shot
29 DATA 3e,c9,32,16,83
30 ' Leave this bit
31 DATA c9,**
32 '
33 ' PASSWORDS
34 '
35 'are PHILBY,MCLEAN,BLUNT ,HOLLIS
36 'for Scum01,Scum02,Scum03,Scum04
37 '
38'PLUGIN,BRAZIL,FLYBOY,KLAATU,LOREAN
39'Hacker,Annaka,Plane,Gort,Koke
    
```

For sheer volume of work if nothing else, Gledhill has been named Hack of the Month.

Kenny Dalglish

SOCCER MANAGER

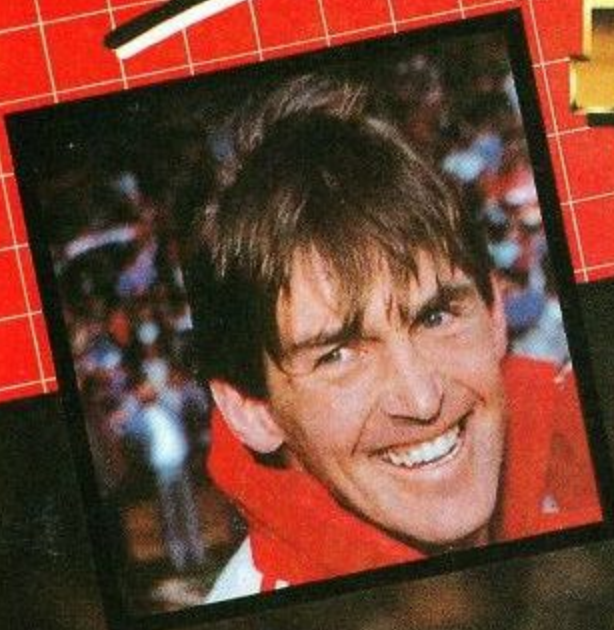

Cognito, the full-priced arm of award-winning outfit Zeppelin Games, brings you the ultimate football manager licence; the most respected chief in the game and the professional's choice - Kenny Dalglish. Kenny Dalglish has brought all the Liverpool discipline and flair of his playing days to the most demanding managerial post in soccer - Liverpool Football Club Manager. Now it is your turn to take on this most prestigious post

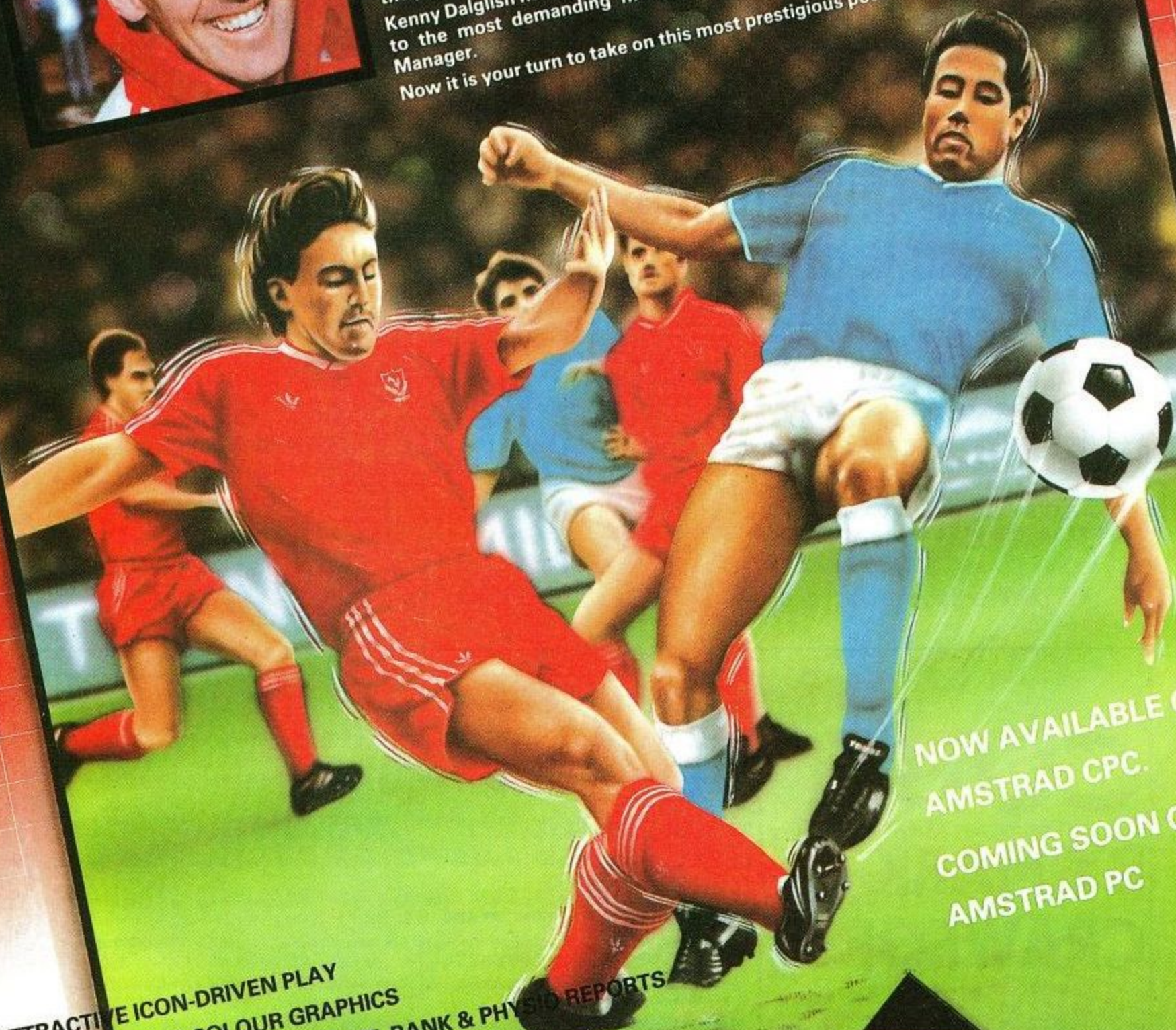

NOW AVAILABLE ON
AMSTRAD CPC.
COMING SOON ON
AMSTRAD PC

- ★ ATTRACTIVE ICON-DRIVEN PLAY
- ★ TOP-NOTCH FULL COLOUR GRAPHICS
- ★ CHAIRMAN, SCOUT, ACCOUNTANT, BANK & PHYSIO REPORTS
- ★ DETAILED GRAPHIC MATCH PLAY HIGHLIGHTS
- ★ FULL F.A. CUP AND LEAGUE CUP COMPETITION

Cognito

ANTHEM

BY MARK CRAWFORD

All rise, please, for this computer rendition of God Save The Queen – and that includes those characters at the front.

Omit line 5 when using on a 464.

```

5 ON BREAK CONT [BA]

10 GOSUB 90 [97]

20 READ a,ad,b,bd,c,cd:IF a=-1 THEN FOR f=0 TO 3000:NEXT:LOCATE 4,10:PRINT STRIN
G$(30,CHR$(247)):END ELSE SOUND 1,a,ad:SOUND 2,b,bd:SOUND 4,c,cd:GOTO 20 [58]

30 DATA 159,100,253,100,319,100,159,100,190,100,379,100,142,100,239,100,478,100,
169,150,284,150,426,150,159,50,284,50,379,50,142,100,284,100,338,100,127,100,213
,100,319,100,127,100,190,100,379,100,119,100,190,100,478,100 [9D]

40 DATA 127,150,213,150,426,150,142,50,239,50,478,50,159,100,253,100,379,100,142
,100,239,100,478,100,159,100,253,100,426,100,169,100,284,100,426,100,159,100,253
,100,638,100,159,50,253,50,426,50,142,50,213,50,478,50,127,50,213,50,506,50 [2F]

50 DATA 119,50,213,50,568,50,106,100,213,100,638,100,0,1,0,1,0,1,106,100,213,100
,506,100,0,1,0,1,0,1,106,100,213,100,426,100,0,1,0,1,0,1,106,150,213,150,319,150
,119,50,213,50,426,50,127,100,213,100,319,100 [9D]

60 DATA 119,100,213,100,426,100,0,1,0,1,0,1,119,100,213,100,338,100,0,1,0,1,0,1,
119,100,213,100,284,100,0,1,0,1,0,1,119,150,213,150,426,150,127,50,213,50,319,50
,142,100,213,100,426,100 [CA]

70 DATA 127,100,213,100,319,100,119,50,213,50,284,50,127,50,213,50,319,50,142,50
,213,50,338,50,159,50,213,50,379,50,127,50,213,50,426,50,127,50,213,50,478,50,12
7,50,213,50,506,50,119,50,213,50,568,50,106,100,213,100,638,100 [E6]

80 DATA 95,50,190,50,478,50,119,50,190,50,478,50,127,100,213,100,426,100,142,50,
213,50,426,50,142,50,213,50,478,50,159,250,253,250,638,250,-1,0,0,0,0,0 [0F]

90 SYMBOL AFTER 32:SYMBOL 247,112,112,64,112,64,120,8,8:MODE 1:PRINT"          GO
D SAVE THE QUEEN":LOCATE 9,2:PRINT STRING$(20,CHR$(208)):LOCATE 4,10:PRINT STRIN
G$(30,CHR$(247)):FOR f=0 TO 900:NEXT:LOCATE 4,10:PRINT STRING$(30,CHR$(248)) [2C
]

100 LOCATE 18,4:PRINT " Converted by Markie":RETURN [F2]

```

CUBE

BY MARK CRAWFORD

Don't strain your eyes too much trying to work this out – it is all an illusion.

Omit line 5 when using on a 464.

```

5 ON BREAK CONT [BA]

10 DEFINT a-o,r-z:PEN 1:PAPER 0:MODE 1:BORDER 5:INK 0,0:INK 1,26:INK 2,16:INK 3,
8:n=20 [85]

20 m=220:b=5:x=280:y=140:GOSUB 100:b=6:x=260:GOSUB 100:m=200:b=1:x=280:y=160:GOS
UB 100:b=2:y=140:GOSUB 100 [14]

30 m=220:b=1:x=260:y=360:GOSUB 100:b=2:y=340:GOSUB 100:b=5:x=480:y=140:GOSUB 100
:b=6:x=460:GOSUB 100 [48]

40 b=4:x=170:y=30:GOSUB 100:b=3:x=150:y=50:GOSUB 100:b=3:x=140:y=240:GOSUB 100 [
44]

50 b=4:x=360:y=20:GOSUB 100:b=3:x=340:y=40:GOSUB 100:m=280:b=4:x=360:y=220:GOSUB
100:b=3:x=340:y=240:GOSUB 100 [65]

60 m=220:b=1:x=140:y=40:GOSUB 100:y=20:b=2:GOSUB 100:m=200:b=5:x=160:y=40:GOSUB
100:b=6:x=140:GOSUB 100 [BC]

70 m=220:b=5:x=360:y=20:GOSUB 100:b=6:x=340:GOSUB 100:b=1:x=140:y=240:GOSUB 100:
y=220:b=2:GOSUB 100 [22]

80 b=5:x=280:y=200:m=60:GOSUB 100:b=6:x=260:GOSUB 100:b=1:x=320:y=160:GOSUB 100:
b=2:y=140:GOSUB 100 [DE]

90 WHILE INKEYS="" :WEND:END [90]

100 i=1+(b=2)+(b=4):j=1+(b=6)+(b=3):p=(1+(b=4)-(b=3))/2:q=(1+(b=3)-(b=4))/2:c=-
(b=2)-(b=6)-3*(b=3 OR b=1)-2*(b=4 OR b=5):FOR a=0 TO n STEP 2:MOVE x+u*i,y+a*j:DR
AWR m*p,m*q,c:NEXT:RETURN [6B]

```

OOPS!

The 10-liner Kill 'em all in the August issue suffered from a mysterious blob attack, so here is the offending line without the blob.

Each Ten-Liner published earns its author £10. If you have a few bright ideas, send your programs on disc or tape to ACU, Avralite Publications Ltd, Greencoat House, Francis Street, London SW1P 1DG. If you want your programs returned, please include a stamped addressed envelope.

```
10 DATA 00000000C0C0000000000000C0F0F0C0000000040F0F0F0F08000058F00F0FF0A40000B53FA5
5A3F7A00047FFF2F1FFFBF28047FFF2F1FFFBF280D75FF251AFFBA1E0D1A300F0F30251E0D0F0FCC
CC0F0F1E0D0F4E98CC8D0F1E0D0F4E64CC8D0F1E0D0F4ECC8D0F1E0D0F4ECC8D0F1E0D0F4ECC
CC8D0F1E040F0F [68]
```

TRAP

BY RAKESH BORHARA

I have seen many a version of this game but none so short. The idea is to cause the opposing player to collide with either

your own trail or the arena wall. Of course, the second player in this two-player game is trying to do the same.

The red player uses the joystick and the green player uses the keys - L for up, full stop for down, / for left and \ for right.

```
10 REM Trap By Rakesh Borhara [86]

20 SPEED KEY 30,2:DEFINT a-z:MODE 1:INK 0,0:INK 1,26:INK 2,18:BORDER 0:INK 3,6:EN
NV 1,11,-1,25:ENT 1,9,49,5,9,-10,15:CLS:PEN 1:LOCATE 6,13:INPUT"Size of Board (1
00 - 250)";b:IF b<100 THEN b=100 ELSE IF b>250 THEN b=250 [AD]

30 b=b/2:MODE 0:MOVE 320-b,200-b:DRAW 320-b,200+b,1:DRAW (320+b)-1,200+b:DRAW (3
20+b)-1,200-b:DRAW 320-b,200-b:plx=320+(b-25):ply=200+(b-25):p2x=320-(b-25):p2y=
200-(b-25):plxm=0:plym=-2:p2xm=0:p2ym=2:p1h=0:p2h=0:p1=3:p2=2 [24]

40 SPEED KEY 1,1:WHILE p1h=0 AND p2h=0:i$=UPPER$(INKEY$):IF i$=CHR$(11) THEN plx
m=0:plym=2 ELSE IF i$=CHR$(10) THEN plxm=0:plym=-2 ELSE IF i$=CHR$(8) THEN plxm=
-4:plym=0 ELSE IF i$=CHR$(9) THEN plxm=4:plym=0 [9F]

50 plx=plx+plxm:ply=ply+plym:c=TEST(plx,ply):IF c=2 OR c=1 THEN p1h=1:GOTO 80:EL
SE PLOT plx,ply,p1:SOUND 1,MIN(plx,ply),0.5 [69]

60 IF i$="L" THEN p2xm=0:p2ym=2 ELSE IF i$="." THEN p2xm=0:p2ym=-2 ELSE IF i$="/"
" THEN p2xm=-4:p2ym=0 ELSE IF i$="\ " THEN p2xm=4:p2ym=0 [A3]

70 p2x=p2x+p2xm:p2y=p2y+p2ym:c=TEST(p2x,p2y):IF c=3 OR c=1 THEN p2h=1:GOTO 90:EL
SE PLOT p2x,p2y,p2:SOUND 3,MIN(p2x,p2y),0.5:WEND [C8]

80 PEN 2:LOCATE 2,1:PRINT"GREEN PLAYER WINS":GOTO 100 [2F]

90 PEN 3:LOCATE 3,1:PRINT"RED PLAYER WINS" [3A]

100 SOUND 130,145,255,0,1,1,12:LOCATE 1,25:PEN 7:PRINT"ENTER TO PLAY AGAIN.":CA
LL &BB03:WHILE INKEY$<>CHR$(13):WEND:RUN [03]
```

Aunt's in Space

As Autumn approaches and the nights get shorter pistol packin' Aunt John Kennedy shows us how to write that timeless classic – Space Invaders.

After the high score table it seems only fitting that at last we start writing a game. The crusty old classic *Space Invaders* is an excellent first game to write. It has many moving missiles, bombs and bases about which to worry, not to mention the aliens wandering round in formation. Once you get the simplest version of *Space Invaders* working you can add features to your heart's content.

The source code is so long – around 14K – that we will have to split it into two parts and list the remaining half next month. When assembled, the code takes less than 6K of memory, including all the data needed for the graphics.

The program makes extensive use of a specially-written machine code subroutine to write graphics to the screen. Standard screen writing routines supplied by the firmware are not fast enough to move all the aliens and things round the screen fast en-

ough. Making use of a short table of addresses, the routine can put multi-coloured, character-sized blobs on to the screen very quickly. You are welcome to use the routine in any of your programs but you will have to wait for next month before it is listed.

The first stage in writing any program is an initial design. Everyone knows how *Space Invaders* works; a block of aliens moves left and right across the screen, dropping bombs on the user's little base. In this version the aliens are in a block of 28, seven columns of four rows. The status of the aliens, either dead or alive, is held in a 28-byte array of memory. The aliens move left and right until they reach the edge of the screen, when

they all move down a row. If they are all shot more will appear lower down the screen and, on later levels, rather faster and nastier.

This month's listing includes the main control part of the program, the sections

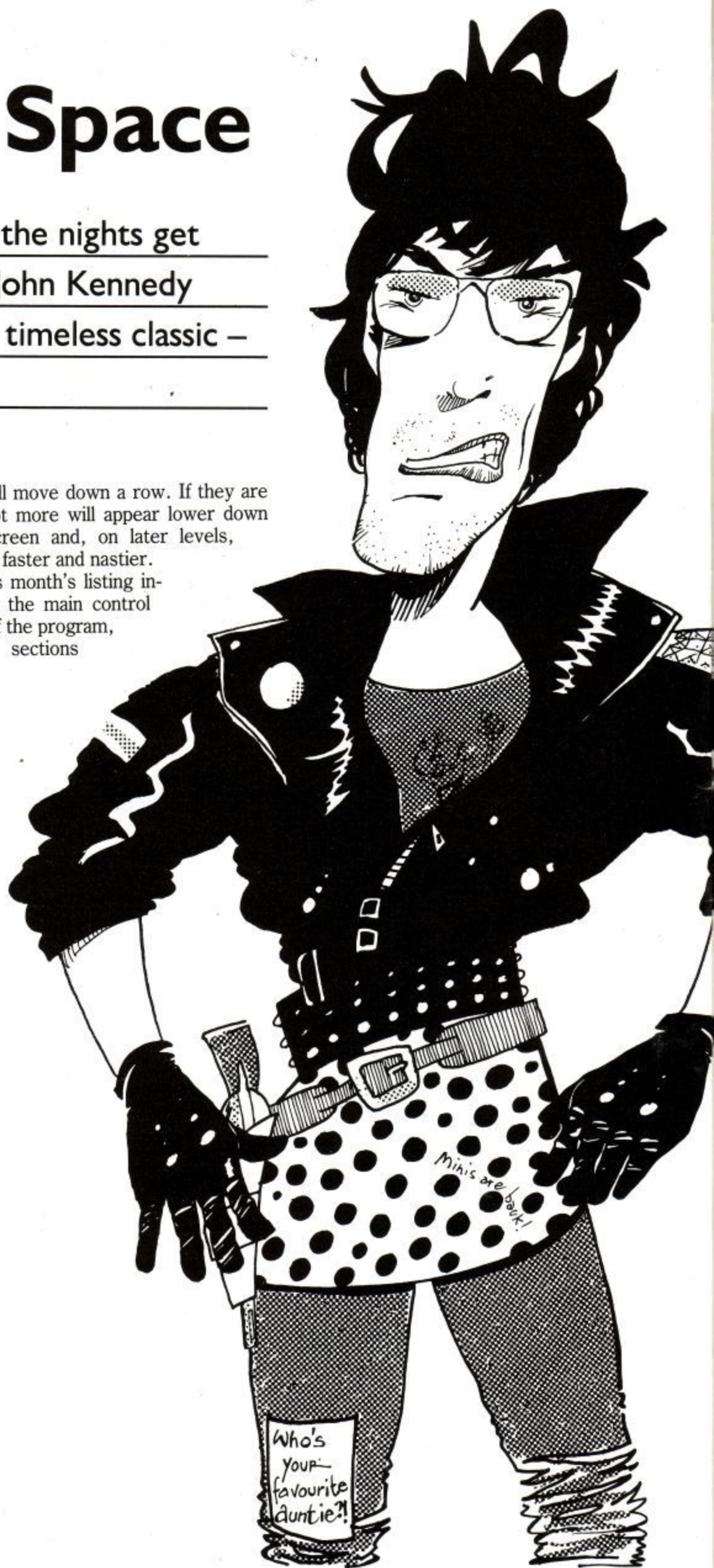

```

;The following firmware calls are used:
set_mode equ &bc0e
test_key equ &bb1e
txt_output equ &nb5a
set_cursor equ &bb75
wait_frame equ &bd19

org &4000 ;Start of Object code. And why not?

START
    call TITLE_SCREEN
    call SET_MAJOR_VARIABLES
MAINLOOP
    call SET_VARIABLES
    call SET_SCREEN
    call SET_SKILL
    call SET_INVADERS
    call WAIT

loop
    call INVADERS ;Print & Move Invaders
    call BASE ;Print & Move Base
    ld a,(flag)
    cp 0: jr z,loop
    cp 1: jr z,Quit_game
    cp 2: jr z,Game_over
    cp 3: jr z,Lost_a_life
    cp 4: jr z,New_Sheet

Quit_game
    ld a,2: jp Set_mode

New_sheet
    ld hl,string4: call PRINT_STRING
    ld a,(sheet): inc a: ld (sheet),a
    call wait
    jr mainloop

Game_over
    ld hl,string3: call PRINT_STRING
    call WAIT: call WAIT: call WAIT: jp START

Lost_a_life
    ld ix,space: call PRINT_MISSILE ;Erase any missiles.
    ld a,0: ld (bomb),a: ld (missile),a: ld (flag),a ;Reset variables.
    ld a,(lives): dec a: ld (lives),a ;Reduce lives.
    call PRINT_LIVES
    call WAIT
    ld a,(lives)
    cp 0 ;If some lives left
    jr nz,loop ;then play on.
    jr Game_over

WAIT ld b,100 ;Produce a short pause
wloop call Wait_Frame
d)nz wloop

```

which define the variables used and the code needed to move the player's base left and right and control the player's missile. The code will be of only academic use until it is combined with next month's listing. When that happens you will have a complete, fully-playable, 100 percent machine code Space Invaders game - always assuming that you have typed it all into an assembler and made no mistakes.

Let us go through the sections and see what is happening. Any labels in capital letters are main subroutines which can be called from any other routine in the program. Labels in lower-case are generally used only from within the section of code in which they are defined. If you are using an assembler other than the MAXAM 1.5 with which the listings

were produced you may find that the label names will have to be altered slightly. Some assemblers will refuse the underscore character. Others may limit the length of the label to eight characters. If that is so, change them carefully, preferably taking a pen to the listing in the magazine and jotting down any changes.

The first section of assembler controls the overall structure of the program. It starts the code running at address &4000, although you can change this if necessary. The first thing to happen is that the title screen is drawn. It consists of only a few lines of text and is an obvious candidate for improvement. What about a picture drawn with an art package? If you have a CPC6128 you could store the picture in the extra bank RAM or copy it to the screen when you need it.

The 'major' variables which are next set up are those such as the score and the number of lives with which the player starts. They are set up outside the main loop because they are set only once at the start of each game. Inside the main loop the play variables are set up. They define where the player's base will first appear, how high up the screen the aliens will start and so on; they must be defined at the start of every wave, not just once. The main screen display - score shields - are drawn next and then the final sets of variables controlling the initial skill levels and aliens are set up. After a short pause to allow the player to catch his breath, the game starts in earnest.

ret

; ----- Controlling the Variables -----

SET_VARIABLES

```
ld iy,aliengr2      ;Aliengr2 points to some graphics data
ld a,0:ld (animate),a
ld a,20
ld (basepos),a     ;Player's base's starting point.
ld a,0
ld (flag),a       ;Main flag
ld (hits),a       ;How many aliens destroyed so far
ld hl,0
ld (bomb),hl      ;Two variables; one to control the Aliens
ld (missile),hl   ;bombs, one to control the players missile
ret
```

SET_MAJOR_VARIABLES

```
ld hl,0
ld (score),hl
ld a,3
ld (lives),a
ld a,1
ld (sheet),a
ld a,6
ld (speed),a     ;How fast the aliens move.
ret
```

SET_SKILL

```
ld a,(sheet):inc a ;Set the aliens' starting height
ld (ypos),a       ;depending on the current sheet.
cp 11
ret nz
ld a,10:ld (ypos),a
ld a,(speed)     ;Speed the aliens @g.
dec a
ld (speed),a
cp 0
ret z
ld a,1:ld (speed),a
ret
```

SET_INVADERS

```
ld b,20          ;Set all elements in array.
ld hl,invadersdata
lpa ld (hl),1
inc hl
djnz lpa
ld a,2
ld (xpos),a     ;How far across they start.
ld a,1
ld (dir),a     ;They direction to the left
ld a,0
ld (count),a   ;Used to determine their speed.
ret
```

; ----- Writing to the Screen -----

TITLE_SCREEN

```
ld a,1:call Set_mode ;The bit with my name
ld hl,string6:call PRINT_STRING ;on it
not_pressed
ld a,47:call Test_key ;Wait until Spacebar
jr z, not_pressed ;is pressed.
ret
```

SET_SCREEN

```
ld a,1:call set_mode ;Set the screen up to
ld hl,string1:call PRINT_STRING ;play a game.
ld hl,string2:call PRINT_STRING
call PRINT_SHEET
call PRINT_SCORE
call PRINT_LIVES
call PRINT_HIGH
ret
```

PRINT_SCORE

```
ld hl,1793:call set_cursor:ld hl,(score):jp printhl
```

PRINT_HIGH

```
ld hl,8705:call set_cursor:ld hl,(high):jp printhl
```

PRINT_SHEET

```
ld hl,5689:call set_cursor:ld a,(sheet):ld l,a:ld h,0:jp printhl
```

PRINT_LIVES

```
;Print a marker for every life left.
ld hl,string5:call PRINT_STRING
ld a,(lives)
cp 0:ret z
ld b,a
llop ld a,239:call txt_output
djnz llop
ret
```

; ----- THE BASE -----

BASE

```
call PRINT_BASE ;Control the player's
call MOVE_BASE ;base and the missile.
call CONTROL_MISSILE
ret
```

PRINT_BASE

```
ld a,(basepos) ;Print the players base
ld l,a
ld h,24
push hl:ld ix,basegr:call PRINT_CHAR:pop hl
inc l:inc l
push hl:ld ix,basegr+16:call PRINT_CHAR:pop hl
inc l:inc l
ld ix,basegr+32:call PRINT_CHAR
```

```

ret
MOVE_BASE                                ;Check keyboard and
;move player's base
;accordingly.
ld a,60:call Test_key
call nz,esc
ld a,(left):call Test_key
call nz,baseleft
ld a,(right):call Test_key
call nz,baseright
ld a,(fire):call Test_key
call nz,basefire
ret
esc ld a,1:ld (flag),a                    ;An option to allow
ret                                        ;a return to BASIC.
baseleft
ld a,(basepos)
cp 0
ret z                                    ;The the base to the
dec a                                    ;left.
ld (basepos),a
ret
baseright
ld a,(basepos)
cp 70
ret z                                    ;Move it to the right.
inc a
ld (basepos),a
ret
basefire
ld a,(missile)                          ;if a missile is not
cp 0                                     ;already moving, fire
ret nz                                   ;one by setting its
ld a,(basepos):inc a:inc a:ld (missile),a ;X co-ord to approx
ld a,23:ld (missile+1),a                ;that of the Base.
ret
CONTROL_MISSILE
ld a,(missile):cp 0:ret z                ;if no missile, return
ld ix,space:call PRINT_MISSILE          ;Erase the missile
ld a,(missile+1):dec a:ld (missile+1),a ;Move it up
cp 0:jr z,stopmissile                   ;Check for scree top
ld ix,missile:call PRINT_MISSILE         ;Print missile
ret
stopmissile                              ;Missile has reached
ld a,0:ld (missile),a                   ;top, so reset it.
ret
PRINT_MISSILE
ld a,(missile)
cp 0:ret z
ld hl,(missile):jp PRINT_CHAR

```

The two routines INVADERS and BASE are called repeatedly until a change takes place in the variable 'flag'. When things are progressing normally, flag contains the value zero. When things are not progressing so well, flag is given a special value:

Value of flag	Meaning
0	Everything OK
1	User press ESCAPE key
2	The aliens have landed
3	The aliens bombed the player successfully
4	The player has destroyed all the aliens

Each of these values is checked for in turn and the flow of control is re-routed to the appropriate subroutine to take care of things. If flag now contains three, the number of lives the player has is reduced by one. If that means the player has no lives remaining, the program will start again from the beginning and print the title page, because the game is over.

This brings us to the next section which sets up all the variables. There is nothing much to be said of this part,

as it involves nothing more than poking a number of addresses with starting values. SET INVADERS uses a small loop to set all 28 elements to one. This is the array which determines whether a particular alien is alive or dead.

The next section controls most of the writing to the screen. TITLE SCREEN is my favourite piece of code. It puts my name on the screen and waits for the player to hit the spacebar. You can put your name here but you will have to wait until next month to do so, as both the strings of data to be printed and the printing routine are held over until then.

The procedure SET SCREEN will select Mode 1 and draw all the shields and scores using routines such as PRINT SCORE. PRINT SCORE, in common with the other number-printing routines, uses the routine PRINTHL which is defined next month. We have already looked at this routine in some depth.

The final section is a rather complicated one which prints and moves the player's base along the bottom of the screen. Also here is the code which checks to see if a missile has been fired and, if so, prints and moves it.

• Next month I will complete the listing.

DISCOUNT SOFTWARE



from M.J.C. SUPPLIES

DISC GAMES

MJC SPECIAL
Indiana Jones and The Last Crusade
RRP £14.99. Our Price £10.95
Offer ends 30/9/89

3D Pool	11.95
Dominator	12.95
Obliterator	11.95
Time + Magik	11.95
Lancelot	14.95
Forgotten Worlds	12.95
Silkworm	12.95
Xybots	12.95
Skweek	12.95
Emlyn Hughes Soccer	11.95
H.A.T.E.	12.95
Time Scanners	12.95
Renegade III	11.95
Chuck Yeager Aft	11.95
Running Man	11.95
Licence to Kill	11.95
Rick Dangerous	11.95
Supreme Soccer Challenge	12.95
The Story so far	11.95
Thunderbirds	11.95

CORNIX SOFTWARE

CARD INDEX: Easy to use filing system
CASS: 19.95
DISC: 24.95

SIMPLE ACCOUNTS: easy to use
accounts ideal for small business
(includes VAT). CASS: 34.95
DISC: 39.95

JOB ESTIMATOR: useful tool for con-
tractors. DISC: 39.95

PRODUCT COSTING: Disc: 39.95. Full
specifications on all of the above pro-
grams on request.

EDUCATION

Animal Veg. Mineral	11.95
Answerback Junior Quiz	11.95
Factfile Arithmetic	7.95
Factfile Spelling	7.95
Factfile Sports	7.95
Fun School for 2-5 years	7.95
Fun School for 5-8 years	7.95
Fun School for 8-12 years	7.95
Fun School 2 for under 6 yrs	9.95
Fun School 2 for 6-8 yrs	9.95
Fun School 2 for over 8 yrs	9.95
World Wise	11.95

Note: Factfiles are question packs only and
require the Answerback Junior Quiz.

DISC SERIOUS

Protect	17.95
Prospell	16.95
Promerge	16.95
Arnor Filer	18.95
Arnor Office Suite	26.95
Tasword 6128	23.95
Taspell	12.95
Tasprint	10.95
Tascopy	10.95
Tasdiary	10.95
Tassign 6128	23.95
Qualitas Plus V.2	14.95
Qualitas Font Library	11.95
Qualitas CPM + Utilities Disk	8.95
French Mistress	16.95
German Master	16.95
Spanish Tutor	16.95
Masterfile III Database	29.95
Mastercalc 128	25.95
Matrix Spreadsheet Plus	29.95
Stockmarket	25.95
Stop Press Desktop Publishing	29.95
Extra Extra	19.95
Maxam (Assembler/Diss)	18.95
Poke Easy Plus	14.95
Mini Office II	13.95
Rodos Extra Disk	8.95
Advanced Art Studio	19.95

CPM BASED

At Last Plus	29.95
Supercalc 2	44.95
Arnor C Compiler	39.95
Maxam II	39.95
Fortran	39.95
Nevada Cobol	39.95
Hisoft Devpac 80	39.95
Hisoft Pascal 80	39.95
Hisoft C Compiler	39.95
Iankey 2 Finger Typing	19.95
Iankey Crash Course	19.95

MJC SPECIAL

Protect CPM: including
Spellchecker & Mailmerge
RRP £59.95 OURS £39.95

CASSETTE BASED

Mini Office 2	9.95
Maxam 464	15.95
Protect 464	15.95
Tasword 464	15.95
German Master 464	14.95
French Mistress 464	14.95
Answerback JNR Quiz	8.95
Italian Tutor	14.95
Spanish Tutor	14.95

**ALL ABOVE PRICES INCLUDE VAT, POSTAGE & PACKING IN THE UK.
THE ABOVE SOFTWARE IS ONLY FOR THE AMSTRAD CPC RANGE**

ACCESSORIES

DKT 64K Memory Exp	45.95
AMX Mouse + Interface	39.95
Multiface II Plus	42.95
Printer Lead 1M	8.95
Printer Lead 1.5M	9.95
Printer Lead 2.0M	10.95
3" Disc Cleaner	6.95
Amstrad RS232 Interface	55.95
Mono Screen Filter	12.95
Colour Screen Filter	14.95
Comp Pro 5000 Joystick	13.95
Quickshot Turbo Joystick	9.95
Cruiser Joystick	9.95
464 Monitor Ext Leads	6.95
6128 Monitor Ext Leads	7.95
1000 Fanfold Labels	6.95
Second Drive Lead	7.95
AMX Mouse + Art Software	49.95
AMX Mouse + Stop Press	59.95
464 Dust cover (Mono/Col)	7.95
6128 Dust Cover (Mono/Col)	7.95
KDS 5 1/4" 800K, Disc Drive (state 464/6128)	149.95
KDS 8 bit Printer Port	18.95

BOOKS MANUALS

Adv Amstrad Graphics	7.95
Mastering Machine Code	8.95
Programming the Z80	19.95

RIBBONS

Printer	Quantity		
	1	2	5
DMP 2000/2160	3.50	6.00	14.00
Panasonic 1080/1081	3.95	7.00	16.00
Citizen 120D	3.95	7.00	15.00
Star LC10 (Black)	3.95	7.00	15.00
Micro-P165/200	4.95	8.00	18.00
Star LC10 Colour	5.95	11.00	—

Genuine Amsoft CF2 Disc
10 for £25.95

PLEASE CALL FOR AVAILABILITY

ROM BASED

Protect	27.95
Prospell	22.95
Promerge +	22.95
Maxam	27.95
Maxam 1.5	20.95
Utopia	20.95
BCPL	21.95
Rodos	28.95
Cage Rom (state which I/Face)	31.95
Rombo (if purchased with ROM)	28.95
KDS Rom Board (holds 6)	24.95

Quali Pack V.2

The Print Enhancement Package
Qualitas Plus KDS 8 Bit Printer Port
Display Font Pack

RRP £36.90

Package Price £34.95

Quali Pack Extra V.2

NEW Qualitas Plus V.2 KDS

Printer Port

NEW Qualitas font library.

RRP £51.85 Our Price £44.50

PRINT COLOUR GRAPHICS!

At last it is possible to get colour screen
dumps from a 6128!

Colourdump two is available exclusively
from MJC Supplies. Will take a standard
screen file from the Advanced Art Studio
or created with Amx Art and Prints out in
full colour on a Star LC10 colour printer.

You choose which colours on paper
represent which on screen, for total
control and variation.

Also works on Epson Compatibles.

Colourdump II 12.95 (inc. Dmp
2,000/2160) with coloured ribbons.
Advanced Art Studio £19.95
Star LC10 colour printer 214.95

(Printer price applies to orders
received before 30/9/89)

PRINTERS

All printers listed have a ten inch
(A4) carriage, are Epson
compatible, and feature friction
and tractor feed mechanisms for
continuous or single sheet paper.
All prices include the necessary
cable.

CITIZEN 120D

Cheap, Epson compatible, giving a range of text sizes
and effects in draft mode.
Limited sizes and effects in NLQ.
£139.95

PANASONIC IXP - 1081

Offers all the draft model text sizes of the DMP 2160, but
is better built, more reliable, and offers NLQ in all sizes
and effects, for the same price.
Highly recommended.
£159.95

STAR LC-10

As well built and reliable as the Panasonic. Has four NLQ
fonts (typefaces), in combination with all sizes and
effects. New low prices makes it well worth considering.
£174.95

STAR LC-10 COLOUR

All the features of the LC-10, but with a seven colour
option for colourful text. If you want colour graphics
please call first for advice.
£214.95

STAR LC 24-10

24 pin version of the LC-10. Has 5 excellent letter quality
fonts available with all sizes and effects. Two extra
effects, outline and shadow are also featured.
Good value.
£269.95

Overseas Orders Welcome - Please write for details

WE ARE NOW IN OUR FIFTH YEAR OF SPECIALISING IN AMSTRAD MAIL ORDER, OUR POLICY IS TO PROVIDE THE WIDEST RANGE AT
DISCOUNT PRICES WITH A FAST TURN AROUND TIME - TRY OUR SERVICES WITH CONFIDENCE

CALLERS WELCOME: Mon-Fri, 9 to 5, Sat 10 to 4

PLEASE SEND CHEQUES/POs TO:



M.J.C. SUPPLIES, (ACU)

40a Queen Street, Hitchin, Herts SG4 9TS

Tel: (0462) 32897/420847 or 421415 for enquiries/Credit Card orders

PROPRIETOR M.J. COOPER



WE'VE GOT 1,000!!

3" HEAD DRIVE CLEANERS

SUITABLE FOR - ALL AMSTRAD 3" DISK DRIVES

KIT COMPRISES:
3" CLEANING CASSETTE
TUBE HEAD CLEANING FLUID
INSTRUCTIONS

~~£9.95~~

**OUR PRICE
ONLY £5.95**

PRINTER RIBBONS

(Nylon Fabric)

AMSTRAD	CITIZEN	
DMP 2000/3000/3160	1200	£4.50
DMP 4000	EPSON	
PCW 825/6/85/2/LC3500	MX/FX/RX/80/FX/800	£3.20
PCW 9512	LX80/86/GX80	£3.20
STAR	MX/FX/RX/100/FX/1000	£3.50
NL10	MANNESMANTALLY	
LC10	MT80	£4.30

AMSTRAD

NEW . . . JOYSTICK SPLITTER
Play with a friend! Splitter enables 2 joysticks to be used independently

ONLY £6.95

PRINTER CABLE
66/4/46/4/6/128 1m

2m

Extension Printer Cable
1m plus power (PCW)

Monitor Extension Lead
66/4/6/128 1m

PPC to Philips 8524/8533/
8833/1081

PC to Philips 8501

£8.95
£9.95
£9.95
£8.50
£5.95
£5.95

**FOR PEOPLE ON THE MOVE
COMPUTER
E-X-T-E-N-S-I-O-N
LEADS**

(Hard Disk type)
9512 £11.50
1512 £18.95
1640 £19.95

(Floppy Disk type)
1512 £17.75
1640 £18.75

DUST COVERS

PC1512/1640

PCW825/6/85/12 sets 3

PC9512 sets 3

DMP 4000

DMP 2000/3000/3160

£9.50
£9.50
£9.75
£4.95
£4.95

All covers clear with grey piping

RS232 GENDER CHANGERS
Avoid incompatible cables ONLY £6.50

**CABLES MADE FOR ALL RS232 AND
PARALLEL TYPES OF COMPUTER,
MODEMS & PRINTERS RING NOW
FOR QUOTE**

PPC to PC data transfer
cable. Enables transfer
of data simply

ONLY
£10.50

DATA SWITCHBOXES
Enables you to quickly
& easily switch
between micros
& printers

RS232
(Serial) Metal Cased

25-way D1 to 2-way

25-way D1 to 3-way

25-way D1 to 4-way

36-way Centronics to 2-way Para

36-way Centronics to 3-way Para

PARALLEL CROSSOVER 36-way Centronics
2 to 2 changeover Crossover

£30.00
£40.00
£50.00
£30.00
£40.00
£50.00
£30.00

**UNIVERSAL PRINTER
STAND**

The adjustable
Printer Stand - 2 piece
construction, fits all standard and wide
carriage printers. Also provides
convenient space for paper and storage.
Rubber feet, vibration absorbing pads.

£12.95

**TILT &
SWIVEL BASE**
Suitable for 12" & 14"
TV or monitor £14.75

JUST ARRIVED
Professional Mouse Pads . £4.75

**REMEMBER, our business is Cables for
Computers, Printers, Monitors, Cassettes etc.
etc. The above is a very small selection! Write
or phone NOW for a quote. Trade EDUCA-
TIONAL & EXPORT ENQUIRES WELCOME**

**CENTRONICS
LINE BOOSTER**
In series, drives data
twice as far with half the
S to N ratio. Doubles
your cable length!

ONLY
£24.95

**AUTO SWITCHES
PARALLEL/SERIAL**

MP401 4-way
Parallel .. £105

MP801 8-way
Parallel .. £135

MS401 4-way
Serial £105

MS801 8-way
Serial £135

BUFFERS
PB 64K Ram £95
PB256K Ram .. £165

COPY HOLDERS
Clamps onto any table
Angle & position your
copy for easy typing on the
computer. Sliding
Rule also fitted
CH1. ONLY
£16.95

DISKETTE STORAGE BOXES
Anti Static with
removable lids
Lock and 2 keys.
Cream with
see-through
lid & custom dividers

To hold 40, 3.5" disks £8.95
To hold 80, 3.5" disks £10.50
To hold 50, 5.25" disks £8.95
To hold 100, 5.25" disks .. £9.95
To hold 120, 5.25" disks £10.95
PLUS COMBO BOX 40, 3.5" or 20 3" £8.25

**ANTI REFLECTION &
ANTI STATIC
SCREEN FILTERS**

COLOUR 12" £16.95
COLOUR 14" £17.95
MONO 12" £16.95
MONO 14" £17.95

ADD AN 800K DISC DRIVE TO YOUR CPC



£1 P&P IN UK, Access & Visa accepted. Please add 15% VAT to all orders. Cheques made payable to:
R.S.D. CONNECTIONS LTD, Dept AU10, Mead Business Centre, Mead Lane, Hertford SG13 7AG.
Trade, Educational & Export enquiries welcome



PREVIEW SOFTWARE

ADD AN 800K DISC DRIVE TO YOUR CPC

Our 80 track double sided 3.5 inch disc drive will allow you to store 800K on a single 3.5 inch disc. The drive is a slimline 1 inch high citizen mechanism (as used on the Amiga and ST) and comes complete in a steel casing and with a power supply and cable to connect to the computer (please specify 464/664/6128). We have three different software packages that complete the system, RAMDOS & ROMDOS by KDS software (ROMDOS is a ROM version of RAMDOS) or RODOS by ROMANTIC ROBOT. 464 owners must already own a first drive and interface before they can use our drive.

NEW LOW PRICES! SAVE £15.00 ON ALL DRIVES

Disc drive with RAMDOS	£109.99
Disc drive with ROMDOS	£119.99
Disc drive with RODOS	£119.99
Blank 3.5 inch disc	£1.00
ROMBOARD (holds 6 ROMS)	£24.99

All prices include VAT and postage



84-86 PRINCESS ST. MANCHESTER M1 6NG.

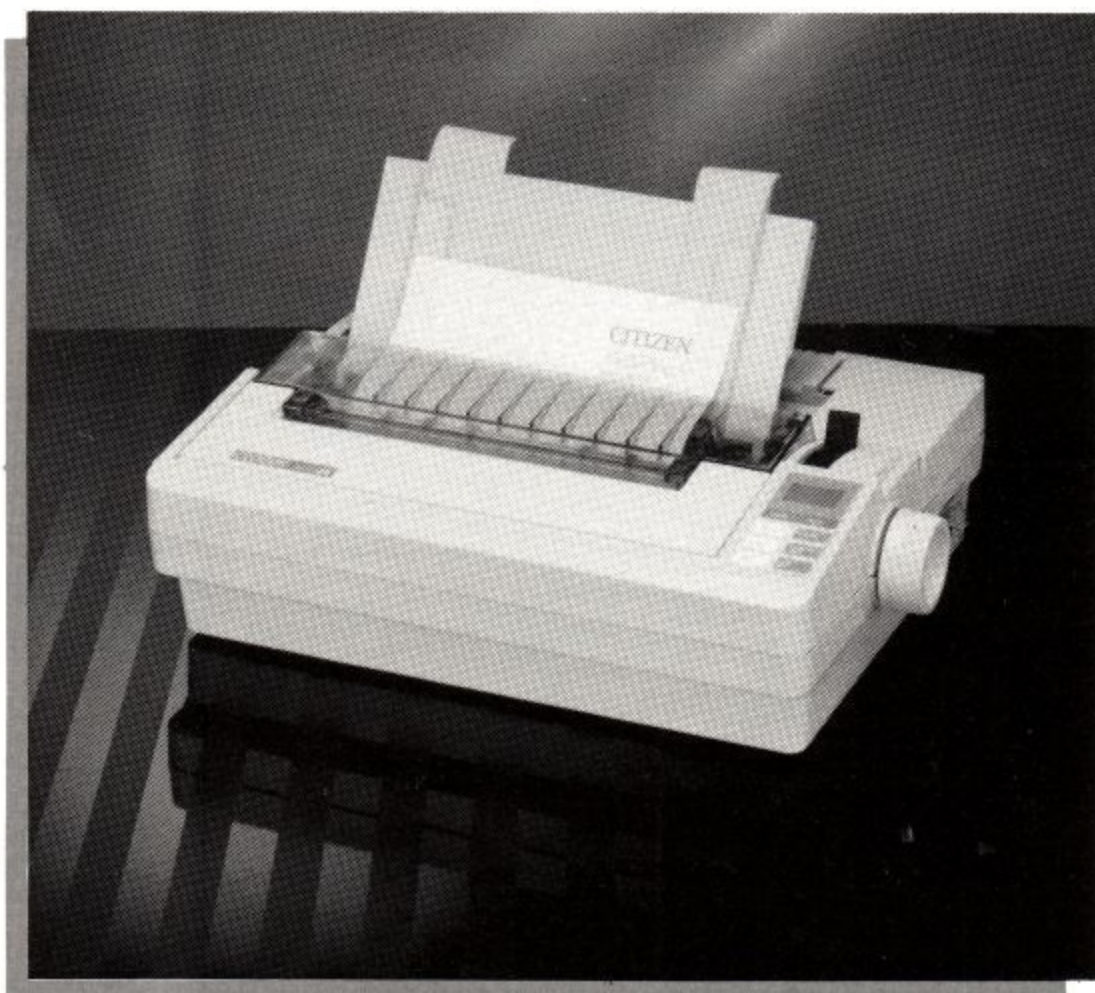

Printing the Swift way

Mark Luckham
 reviews a 'pocket
 battleship' of a
 printer and discovers
 the joys of a 24-pin.

You have been content using that old 9-pin for two years but recently it does not seem to be the wonder peripheral you always thought. The print quality is looking decidedly dotted; screen dumps take forever and look like cubist paintings when they appear.

It is time to upgrade but not to another 9-pin - to an exciting new 24-pin, high-performance one. You

may say you cannot afford one but Citizen, famous for its low-cost 9-pin printer, the 120-D, has launched an assault on the low-end 24-pin market with the Swift 24.

Looking at the Swift when it emerges from its wrapping gives the impression of power and compactibility. Supplied with a single sheet feeder and a tractor feed, the Swift also offers a Centronics parallel interface as standard, with serial an optional extra, five built-in fonts plus an expansion slot for font cards, and a two-line LCD display plus six-key

touchpad. One of the best features of the package is the manual, which even includes a section on how to send control characters to the printer from your computer. Not only are specific examples given for the CPC but other computers are listed.

The fonts on offer from the Swift are Times Roman, Prestige Elite, Courier, Helvetica for 24-pin near letter

quality, and a draft font for draft print. The quality is 120dpi in draft mode, and 360dpi in NLQ and graphics modes.

When using the draft mode the printing speed is 192cps at 12cpi and, in NLQ mode, 64cps at 12cpi and 53cps and 10cpi. The noise level when under way is a very reasonable 55dB, or 52dB when in the slower Quiet mode.

With an expandable 8K data buffer your printer will not be held up too long when printing anything except the longest documents. An excellent feature is that on the LCD display it informs what percentage of its memory is full of data from the computer.

The LCD display and the keypad are the hi-tech equivalent of DIP switches. There are four macros available, all re-definable, which control all the functions.

The printer has EEPROM, which means that once you have re-defined a macro so that it is compatible with your CPC, and offers all the fonts and spacing requirements you need, you can save it and it will survive a power-off. The next time the printer is turned on it boots with the last defined macro, ready to go.

The Swift offers three types of emulation - Epson LQ850, IBM Proprinter X24 and NEC P6+, so if you intend to buy one make sure you have an appropriate printer driver.

One of the most exciting aspects of the printer is the ability to print in colour. To do that you will have to buy the four-colour kit - £38 excluding VAT.

The Swift 24 is a pocket battleship of a printer. It offers great ease of use, a relatively small footprint, speedy and quality printing. If it is time to upgrade, the Citizen Swift 24 will put the power back into your printing.

Citizen Europe Ltd, Wellington House, 4-10 Cowley Road, Uxbridge, Middlesex UB8 2XW.

Tel: 0895 72621.

3

Reasons Why You Should Subscribe Today!



Convenience

Direct to your door at
NO EXTRA COST*
we pay the post!

Avoid Disappointment

Never again worry about
your local newsagent
selling out.

Save Money

Avoid any price
increases for the next
14 issues by subscribing.

1 + 2 = FREE ISSUES

YES 2 extra issues of your favourite
magazine absolutely FREE!

3

▷ This fabulous offer can't last forever so
Act NOW! Don't forget, if you are
currently a subscriber you too can take
advantage of this special deal by
renewing TODAY!

UK: £16.20; EUROPE: £23.00; MIDDLE EAST: £23.30;
FAR EAST: £25.90; REST OF WORLD: £23.80 or USA: \$41.00.

Airmail Rates on Request

*Overseas subscription rates include postage



Please begin my subscription to Amstrad Computer User (at the special offer of 14 issues for the price
of 12) with the _____ issue.

I enclose my cheque/money order for £ _____ made payable to: FOCUS MAGAZINES LIMITED
or debit my Access/Visa No.

Expiry Date.....

Name

Address

Postcode (please enter postcode to ensure prompt delivery)

Signed..... Date ACU10

Please send this form with your remittance to: Judi Gallon, Focus Magazines, Greencoat House,
Francis Street, London SW1P 1DG.

Only
£24.95

Including VAT and p&p.

Save £5 on RRP of £29.95 when you order direct from Connect Software

MONEY MANAGER

Amstrad CPC 464, 664 and 6128
(disc only)

Over 25,000 sold in UK alone

Versions available for Amstrad PCWs and PC compatibles. Phone or write for details.

Financial management software for personal and/or small business use

Money Manager provides individuals, businesses and professional people with a simple yet powerful way of managing their financial activities. All transactions can be entered easily and then presented in a wide variety of reports, ranging from a detailed listing of expenditure for tax purposes to summaries showing, for example, how much money has been spent over the past twelve months on petrol or electricity. Reports can also be presented in graphical form as pie and bar charts.

The Money Manager package has over 25,000 users in the UK alone. It is the ideal program for people who find that traditional accountancy programs are too complicated, unwieldy and time-consuming for their requirements.

- Any number of data files: Personal, Business, Accounts etc.
- 12 months per file, up to 100 entries (transactions) per month
- Move a file forward by a month at a time when required
- All options selected from the main menu
- Up to 9 user-defined accounts: Bank, Cash, Visa, Access etc.
- Up to 50 user-defined classes of income and expenditure
- A reference of up to 6 characters for each entry
- Your own descriptive text of 18 characters for each entry
- All the codes are displayed on screen whilst entering data
- Add, modify and delete existing entries at any time
- Quick insertion of standard entries and standing orders
- Entries can be sorted into date order automatically
- Single character 'mark' for even more selective reporting
- Reports showing each entry in a month or for whole year
- Reports may show classes merged into groups

- Spreadsheet type table showing class totals in each month
- Report showing class totals for each account
- Bar charts for up to 4 selected categories
- Pie charts of up to 10 selected 'slices'
- Report of monthly income, expenditure and cash-flow etc.
- Account statistics - monthly max, min, average, balance etc.
- Detailed Input and Output VAT reports
- Automatic calculation of VAT
- Simply ignore VAT features if they are not required
- Budget and cash-flow forecasts - may be updated
- Data search facility to find 'lost' items
- User-defined screen colours
- Comprehensive manual
- Two sets of sample data for practice and familiarisation
- Free telephone support for as long as you need it

**Connect
Software Ltd.**

To receive your copy of Money Manager by return post phone us now with your credit card number, or write to us at the address below enclosing your cheque for £24.95

01 743 9792 8am-10pm, 7 days a week

Connect Software Ltd., 3 Flanchford Rd., London W12 9ND



**CHALLENGE
SOFTWARE**

GREAT STRATEGY GAMES

A superb range of Football & Cricket games

for the Spectrum, Commodore & Amstrad

From Challenge Software (formerly E & J Software)

TREBLE CHAMPIONS £9.95 Spec 48/128 : Com 64/128 : Ams CPC
A STUNNINGLY REALISTIC FOOTBALL STRATEGY GAME - Can you Win The League, The F.A. Cup & The League Cup - 4 Divisions of 20 Teams + 1 Div. 20 Non League Teams - Details of OVER 1500 Players - Results & Leagues ALL Divisions - League Cup with 1st, 2nd Rnds + S/Finals over 2 Legs - F.A. Cup includes Non League - Transfer Market buy ANY PLAYER ANY DIVISION - 3 Skill Levels - Start ANY Division - SAVE GAME - Time Management - Reserves - 2 In-Match Subs - Coaching + Fitness Training - PLUS MUCH MORE.

EUROPEAN CHAMPIONS £8.95 Spec 48/128 : Ams CPC
THE INTERNATIONAL CHALLENGE OF THE EUROPEAN NATIONS CUP - Genuine Nations Cup Format with full Random Draw of 32 Seeded Teams - Fixture List, Results and League Tables of ALL 8 Groups - Discipline & Medical Reports - Squad of 22 Players plus Other Players - 17 Month Itinerary of Qualifying Group, (Arrange Friendlies) and Finals - Plus many more Superb Features and Options. EUROPEAN CHAMPIONS includes E & J's MATCH PLAY SYSTEM which captures all the ACTION, DRAMA & TENSION of International Football.

WORLD CHAMPIONS £7.95 Spec 48/128 : Com 64/128 : Ams CPC
A COMPLETE WORLD CUP SIMULATION - Select Friendlies - 25 Players - Qualifying Group - 2 In-Match Subs - Discipline Table - Select Tour Opponents - Extra Time - Final Rounds - Players Gain Experience - 7 Skill Levels - TEXT MATCH SIMULATION including: Bookings, Goal Times, Named & Recorded Goal Scorers, Injury Time, Corners, Free Kicks, Match Clock, Penalties - PLUS many more Features.

CRICKET MASTER £8.95 Spec 48/128 : Com 64/128 : Ams CPC
A SUPERB SIMULATION OF ONE DAY INTERNATIONAL/COUNTY CRICKET - Weather, Wicket & Outfield Conditions - Batting & Bowling Tactics - Team Selection - Fast, Medium & Spin Bowlers - 4 Types of Batsmen - Select Field Layout - 3 Skill Levels - Wides - Byes - No Ball - Run Out - Misfield - Dropped Catches - Scoreboard - Batting & Bowling Analysis - Run Rate - Single Option - 3 Game Speeds - STAR FEATURE a complete MATCH OVERVIEW showing Ball by Ball Action and Commentary and MUCH MORE!

TEST MASTER £8.95 Spec 48/128 : Ams CPC
A COMPREHENSIVE SIMULATION OF A 5 DAY TEST MATCH - includes most of the Features of CRICKET MASTER and MATCH OVERVIEW plus Declarations - Nightwatchmen - Light Meter - Rain Stops Play - Varying Number of Overs per Day - Follow On - Save Game - New Ball - Bad Light Interruptions - TEST MASTER is a True representation of a Complete Test Match and offers the ULTIMATE CHALLENGE to All Cricket Enthusiasts.

Above games available on disc @ Plus £4.00 Spec & Ams or Plus £2.50 Com PER GAME
(Treble Champions not available on disc for Commodore 64/128)

ALL GAMES are available by MAIL ORDER for IMMEDIATE despatch by 1st class post and include Full Instructions. State which Machine & Tape or Disc.
(Add 50p per Game outside UK or £1.50 per Game for AIRMAIL outside Europe.
Payment in Pounds Sterling Only)

Cheques or Postal Orders payable to Challenge Software, SEND TO:
Challenge Software, Room A2, 37 Westmoor Road, ENFIELD, Middlesex, EN3 7LE

**FANTASTIC
DISCOUNTS**
FULL PRICE GAMES ONLY
Buy 2 games deduct £3.00
Buy 3 games deduct £5.00
Buy 4 games deduct £7.00
Buy 5 games deduct £12.00

MAKE YOUR AMSTRAD EARN!

Yes making money with your Amstrad becomes incidental when you know how. Your micro is, if only you knew it, a gold mine. The size and make is irrelevant. Make the initial effort NOW by starting your own.

HOME BASED BUSINESS.

This may be the most important move you will ever make!

REMEMBER: You'll never get rich by digging someone else's "ditch". Anyone in the country, including YOU, can become very rich in a relatively short period of time just by doing a few basic things! It's more rewarding than playing games. The benefits are many and varied. Full or part time. For FREE details send S.A.E. to:



HOME BASED BUSINESS

31 PILTON PLACE (ACU12)
KING AND QUEEN STREET
WALWORTH, LONDON SE17 1DR

JACKSON COMPUTERS LIMITED

JOIN OUR DISCOUNT CLUB!

Life membership for £8.50

Software/Hardware Discounts of 5-20% off RRP
All AMSTRAD and other leading makes of software available
Complete computer system, Printers, modems, cables

Amstrad CPC464 with colour monitor £287.50
Amstrad CPC6128 with colour monitor £389.90
PCW8256/512 £388.70/£504.85
Amstrad PCW 9512 £552.00
Amstrad PC 1640 ECD Ring for details
PPC portable computers in stock and also PC2000 range. Ring for details.

All prices include VAT
Also free Life Membership when you purchase any AMSTRAD computer
TEL: Between 9am-5pm 01-655 1610

Send for full Price List & membership form to:
25 Spring Lane, Woodside, South Norwood
London SE25 4SP

Joy about town

Adrian Pumphrey
casts an expert eye
over a state-of-the-art
selection of joysticks.

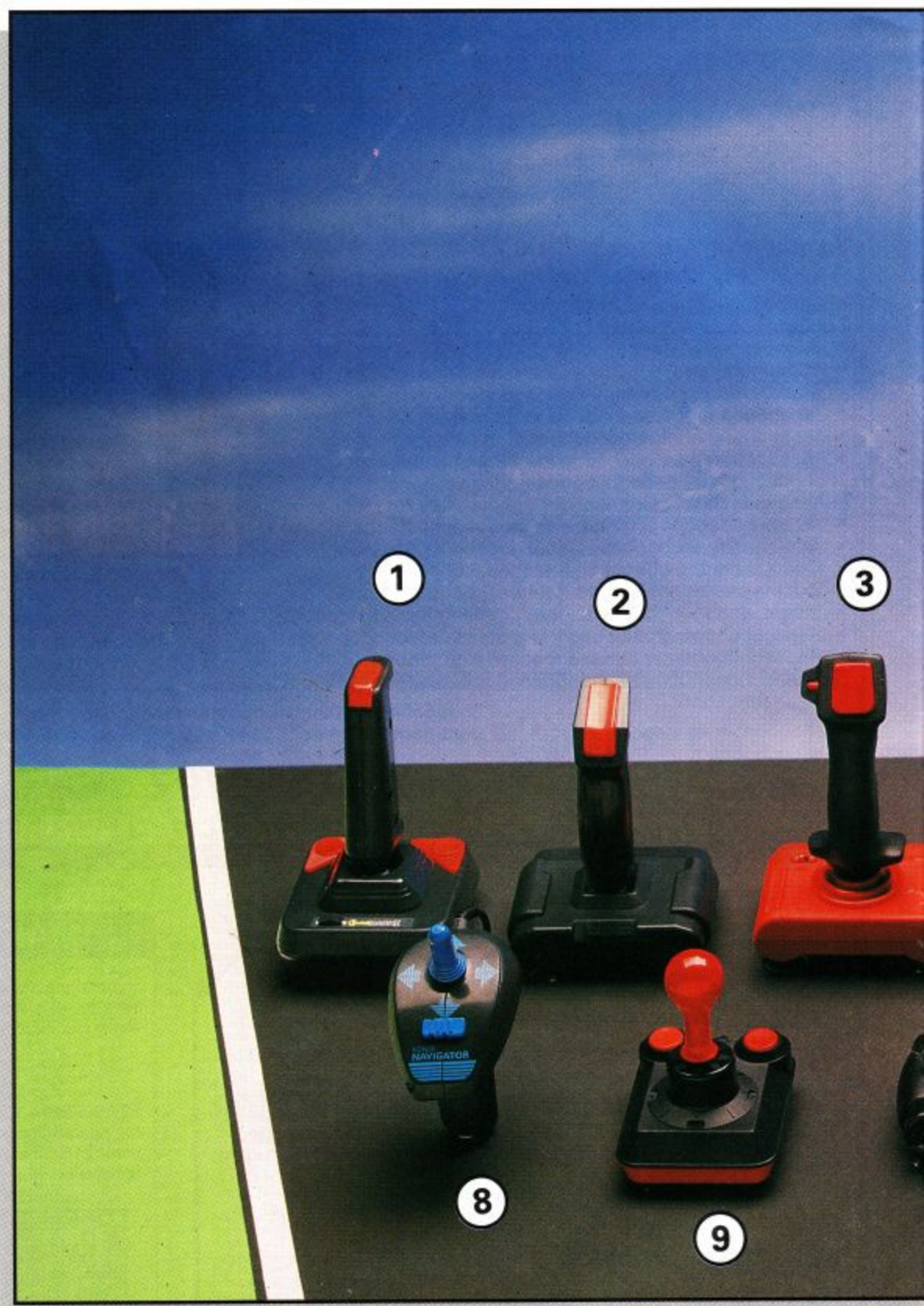

Mach I
Supplier: Cheetah
Price: £10.99

1

Chief clunky of the range. It is fully micro-switched with no damper on stick movements to give that familiar clunk effect. There is non-functioning auto-fire when used on the CPC. It works well if you demand little of your stick.

Quickshot II
Supplier: Spectravideo
Price: £6.95

2

Black and functional best sums up this stick. Non-functioning auto-fire with the CPC with two top-mounted buttons for finger and thumb action.

The lack of microswitches is reflected in the price and although perfectly functional you are better saving for the Turbo version.

Quickjoy II Turbo
Supplier: DGM
Price: £10.95

3

Positive movements with this joystick are each accompanied by a loud click as the micro-switches make contact. There are no fire buttons on the base – only a switch to allow the stick to operate correctly on the CPC. The top two fire buttons work with thumb and trigger finger. There is an auto-fire which is selected easily with the thumb but again it does not work with the CPC.

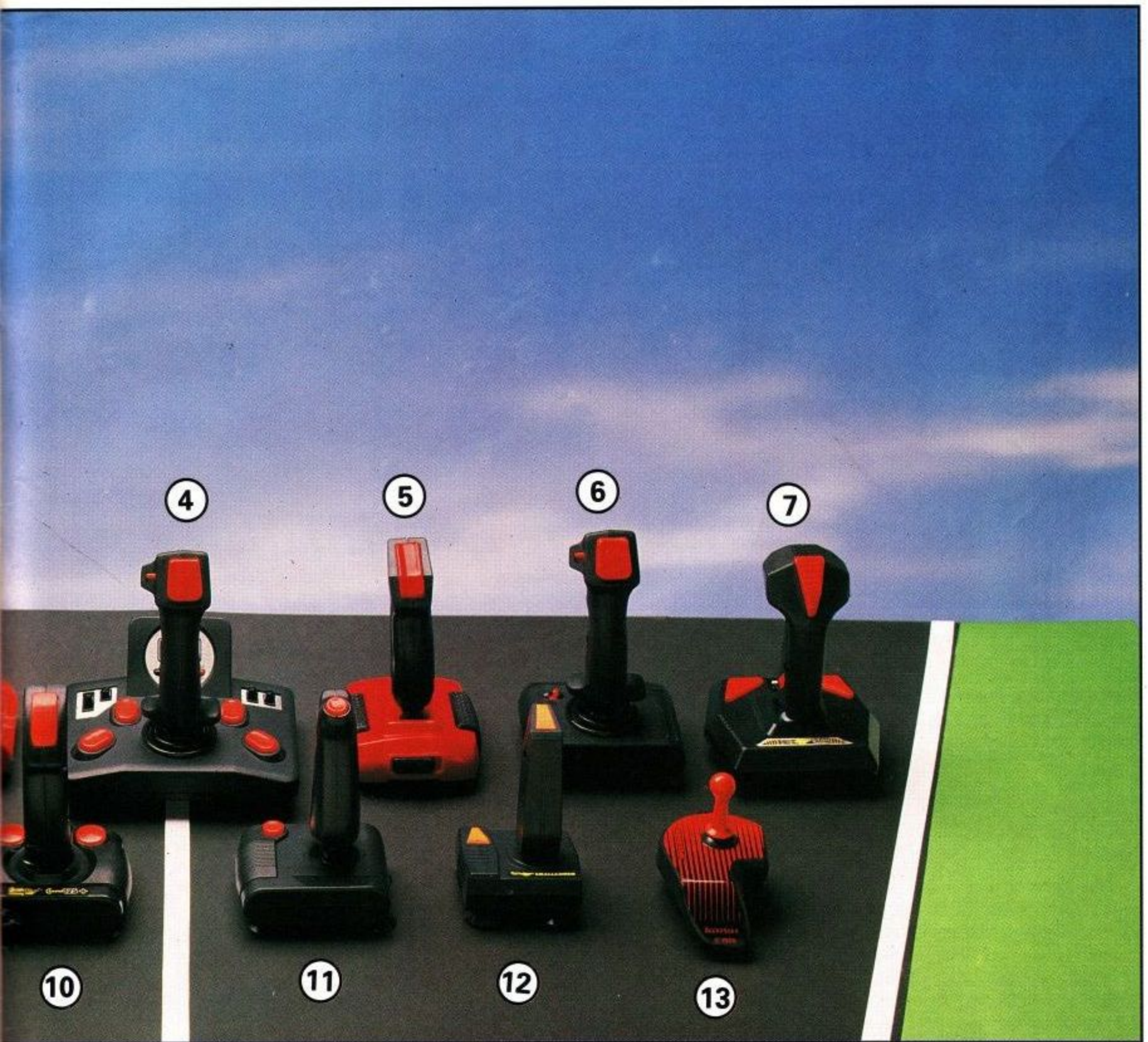

Quickjoy V – Superboard
Supplier: DGM
Price: £19.95

4

This mammoth joystick offers a choice of three sets of two fire buttons to use and includes its own timer. The fire button groups reside at the left, right and top of the stick, with the timer set in a raised display at the front. The timer can be set for a desired number of minutes, paused and re-set but it needs a battery.

The auto-fire is activated by a small switch at the top of the stick and can be switched easily with the thumb during play. The auto-fire can be set for three speeds which is great but unfortunately the auto-fire function does not work with the CPC.

Quickshot II Turbo
Supplier: Spectravideo
Price: £10.95

5

The design matches the performance with this fully-micro-switched blaster. It has a base-mounted switch with normal, auto-fire and CPC modes. Auto-fire is non-functioning on the CPC. Top-mounted fire buttons allow thumb and trigger finger operation.

Quickjoy II
Supplier: DGM
Price: £8.95

6

Identical in design to the Turbo version but without the micros-

witches. The grip is a little small for an adult hand but with the thumb-accessed auto-fire switch and CPC mode, it is a versatile little stick. Auto-fire is non-functioning on the CPC.

Star Probe
Supplier: Cheetah
Price: £14.99

7

A rather stylish stick with a cobra head. Along with the improved design is a performance lacking in the other Cheetah sticks reviewed. It is fully micro-switched, with four fire buttons, two at the top and one either side of the base. For Spectrum owners there is a split connector and an auto-fire which may well work on the

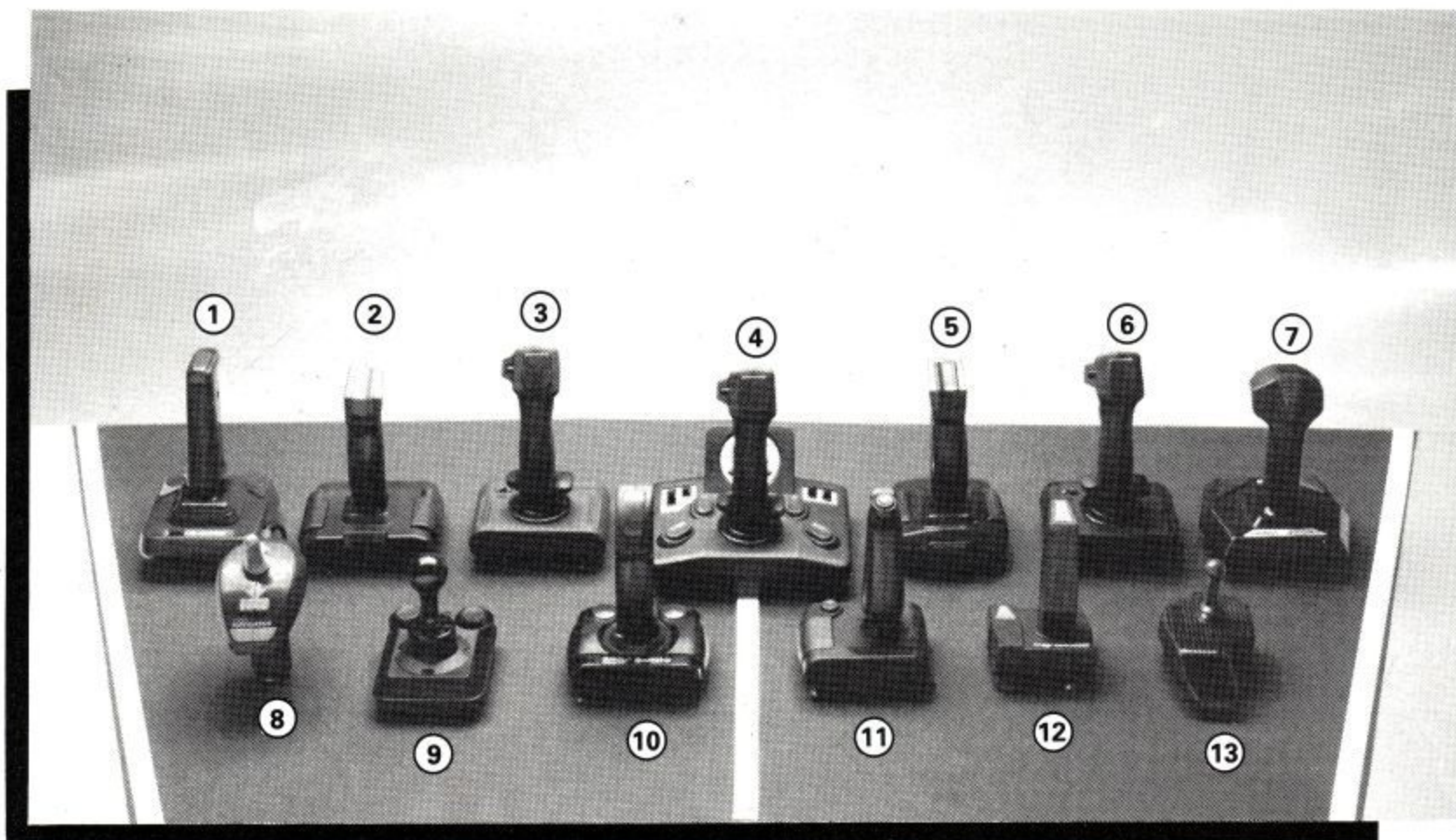

◀ From page 65

Spectrum but does not function on the CPC. The responses are good, if a little on the clunky side.

Navigator
Supplier: Konix
Price: £14.99

8

This must be one of the most misunderstood joysticks on the market, as its picture has appeared upside down in countless magazines. Strangely enough, the joystick looks better upside down. In essence, the Navigator is the back end of a pistol with a short stick on top. It fits snugly into the hand and the front-mounted trigger allows single-hand rapid fire; the auto-fire does not work with the CPC. The short control stick moves in a very positive manner, issuing a loud click and a lurch in the selected direction.

The design works well in both hands and the shape reminds the player of the weapon being wielded.

New Micro Blaster
Supplier: Micromart
Price: £12.95

9

Compact and chunky best describes this joystick as it crams it all into an easily hand-held module. Right and left fire buttons on base are both micro-switched. The stick has an

“It looks ugly and feels completely dead”

auto-fire switch under the base at the front. It is possible to switch modes while the heat is on but that requires dexterity greater than most possess. That is irrelevant really, as it does not work with the CPC.

There is good response, with the ability to bounce off walls unscathed. The chunky design could do with a few rounded edges for less painful gripping.

Cheetah 125+
Supplier: Cheetah
Price: £8.99

10

This stick follows the age-old design with two buttons on the top and one on either side of the base. The cable split for use with the Spectrum+2 is satisfactory but not very applicable and the auto-fire does not work on the CPC. It is nothing outstanding – just a standard non-micro-switched joystick.

Quickshot I
Supplier: Spectravideo
Price: £5.25

11

This may have been a good stick in

its time but its time is long gone. It looks ugly and feels ugly and the fire buttons feel completely dead.

Challenger
Supplier: Cheetah
Price: £4.99

12

This must be one of the smallest and most displeasing joysticks to view and hold. The stick has only one button on the base on the left-hand side, so if you prefer holding the stick in your right hand you are compelled to use the top fire button. Amazingly enough there is no auto-fire switch.

Speed King
Supplier: Konix
Price: £12.99/11.99 without auto-fire

13

This joystick is highly-designed peripheral. That is fine so long as you meet the requirements of the designers. If you have either a small hand or a desire to hold the stick in your right hand, forget it. If you hold the stick in a large left hand you are in for a treat.

The main body of the stick fits snugly into the palm of the hand with a recess for your back two fingers and a groove for your thumb. One of the remaining two fingers rests in the groove of the extended fire button. There is no auto-fire and its general design lends itself to more accuracy and less blast.

FREE! TENSTAR PACK WORTH OVER £229!



FREE! - AMEGAS - by Players



FREE! - INSANITY FIGHT - by Microdeal

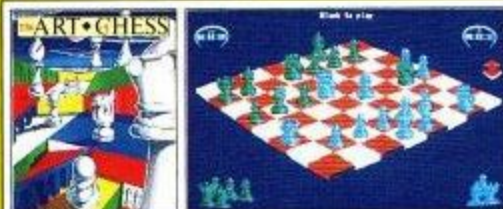

FREE! - ART OF CHESS - by SPA



FREE! - MERCENARY COMP - by Novagen



FREE! - BARBARIAN, ULT WARRIOR - by Palace



FREE! - TERRORPODS - by Psygnosis

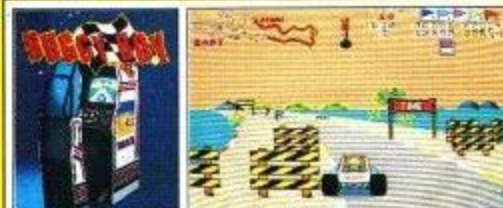

FREE! - BUGGY BOY - by Elite



FREE! - THUNDERCATS - by Elite



FREE! - IKARI WARRIORS - by Elite



FREE! - WIZBALL - by Ocean

Commodore AMIGA



ONLY £3.34 PER WEEK
RETURN COUPON FOR DETAILS

£346.95

+VAT= £399

INCLUDES FREE UK DELIVERY

The Amiga 500 is one of a new breed of technologically advanced computers, which are now emerging as the new standard for home computing, based around the new Motorola 68000 chip. The A500 has 512K RAM and a 1Mbyte double sided disk drive built-in. It can be connected directly to a wide range of monitors, or to a domestic TV set through a TV modulator. Designed with the user in mind, the A500 features a user friendly WIMP environment and comes supplied with a free mouse. And, when you buy your Amiga from Silica Shop, the UK's No1 Amiga specialists, you will experience an after sales service that is second to none, including a technical support helpline and free newsletters and price lists. Return the coupon below for our current information pack, which will give details of the Silica service and the very latest Silica Amiga offers. E&OE

WHY SILICA SHOP?

Before you decide when to buy your new Commodore Amiga computer, we suggest you consider very carefully WHERE you buy it. There are MANY companies who can offer you a computer, a few peripherals and the top ten selling titles. There are FEWER companies who can offer a wide range of products for your computer as well as expert advice and help when you need it. There is ONLY ONE company who can provide the largest range of Amiga related products in the UK, a full time Amiga specialist technical helpline and in-depth after sales support, including free newsletters and brochures delivered to your door for as long as you require after you purchase your computer. That one company is Silica Shop. We have been established in the home computer field for ten years and can now claim to meet our customers' requirements with an accuracy and understanding which is second to none. Here are just some of the things we can offer you.

THE FULL STOCK RANGE: The largest range of Amiga related peripherals, accessories, books and software in the UK.

AFTER SALES SUPPORT: The staff at Silica Shop are dedicated to help you to get the best from your Amiga.

FREE NEWSLETTERS: Mailed direct to your home as soon as we print them, featuring offers and latest releases.

FREE OVERNIGHT DELIVERY: On all hardware orders shipped to Silica Shop customers within the UK mainland.

PRICE MATCH PROMISE: We will normally match our competitors offers on a 'same product same price' basis.

FREE TECHNICAL HELPLINE: Full time team of Amiga technical experts to help you with your technical queries.

But don't just take our word for it. Complete and return the coupon below for our latest Amiga literature and begin to experience the Silica Shop specialist Amiga service.

PHOTON PAINT PACK

A500 Computer	£399.99
TV Modulator	£24.99
Photon Paint	£69.95
TenStar Pack	£229.50
TOTAL RRP:	£724.43
LESS DISCOUNT:	£325.43
PACK PRICE INC VAT:	£399

1084S MONITOR PACK

A500 Computer	£399.99
1084S Colour Monitor	£299.99
Photon Paint	£69.95
TenStar Pack	£229.50
TOTAL RRP:	£999.43
LESS DISCOUNT:	£350.43
PACK PRICE INC VAT:	£649

FREE FROM SILICA

When you buy the Amiga 500 from Silica Shop, you will not only get a high power, value for money computer, we will also give you some spectacular free gifts. First of all, we are now including a TV modulator with every A500 stand alone keyboard, so you can plug your Amiga straight into your TV at home (the modulator is not included with the A500-A1084S pack as it is not required for use with monitors). Secondly, we have added a free copy of Photon Paint, an advanced graphics package with an RRP of £69.95. Last (and by no means least!), so that you can be up and running straight away, we are giving away the sensational TENSTAR GAMES PACK with every A500 purchased at Silica Shop. This pack features ten top Amiga titles which have a combined RRP of nearly £230! Return the coupon for details.

FREE TENSTAR PACK

Amegas	£14.95
Art Of Chess	£24.95
Barbarian, Ult Warrior	£19.95
Buggy Boy	£24.95
Ikari Warriors	£24.95
Insanity Fight	£24.95
Mercenary Comp	£19.95
Terrorpods	£24.95
Thundercats	£24.95
Wizball	£24.95
TOTAL RRP:	£229.50 INC VAT

DO YOU OWN AN AMIGA?

If you already own an Amiga computer and would like to be registered on our mailing list as an Amiga user, let us know. We will be pleased to send you copies of our price lists and newsletters FREE OF CHARGE as they become available. Complete the coupon and return it to our Sidcup branch and begin experiencing a specialist Amiga service that is second to none.

SILICA SHOP:

SIDCUP (& Mail Order)	01-309 1111
1-4 The Mews, Hatherley Road, Sidcup, Kent, DA14 4DX	
OPEN: MON-SAT 9am - 5.30pm LATE NIGHT: FRIDAY 9am - 7pm	
LONDON	01-580 4000
52 Tottenham Court Road, London, W1P 0BA	
OPEN: MON-SAT 9.30am - 6.00pm LATE NIGHT: NONE	
LONDON	01-629 1234 ext 3914
Selfridges (1st floor), Oxford Street, London, W1A 1AB	
OPEN: MON-SAT 9am - 6.00pm LATE NIGHT: THURSDAY 9am - 8pm	

To: Silica Shop Ltd, Dept AMSACU 1089, 1-4 The Mews, Hatherley Road, Sidcup, Kent DA14 4DX

PLEASE SEND ME FREE LITERATURE ON THE AMIGA

Mr/Mrs/Ms: Initials: Surname:

Address:

Postcode:

Do you already own a computer
If so, which one do you own?



AMSTRAD
USER CLUB
It pays to belong!

INTRODUCING Our brand new super service for readers.

Amstrad Computer User and the Official Amstrad User Club have combined our unrivalled knowledge of your computer to provide a unique support service designed to meet exactly your needs.

Look out each month for our superb selection of invaluable offers at some of the best value prices around as well as really special deals for Amstrad User Club Members.

AMSTRAD MAGNUM LIGHT PHASER

From Virgin Mastertronic



The latest add-on goodie from Amstrad, the exciting Magnum light phaser, gives a new dimension to games on your CPC. The life-like effect of the Magnum along with seven smash hit games specially adapted for it will make you wonder how you played without one!

Price £34.95. Order Code MAGPHASE.



PANDORA —



Available only from ACU is the latest, enhanced version of the Pandora games generating program.

With only a limited knowledge of Basic, or the use of a word processor that produces ASCII files, you can access the full



power of your computer and your imagination! It has extensive sound and graphics facilities, 48 sprites available and a detailed manual with examples.

Tape PANDOR 001 £24.95
 MEMBERS £22.95
 Disc PANDOR 0001 £29.95
 MEMBERS £27.95



APPLICATION ADVICE

David Dorn once
again racks his brain
to answer your
problems.

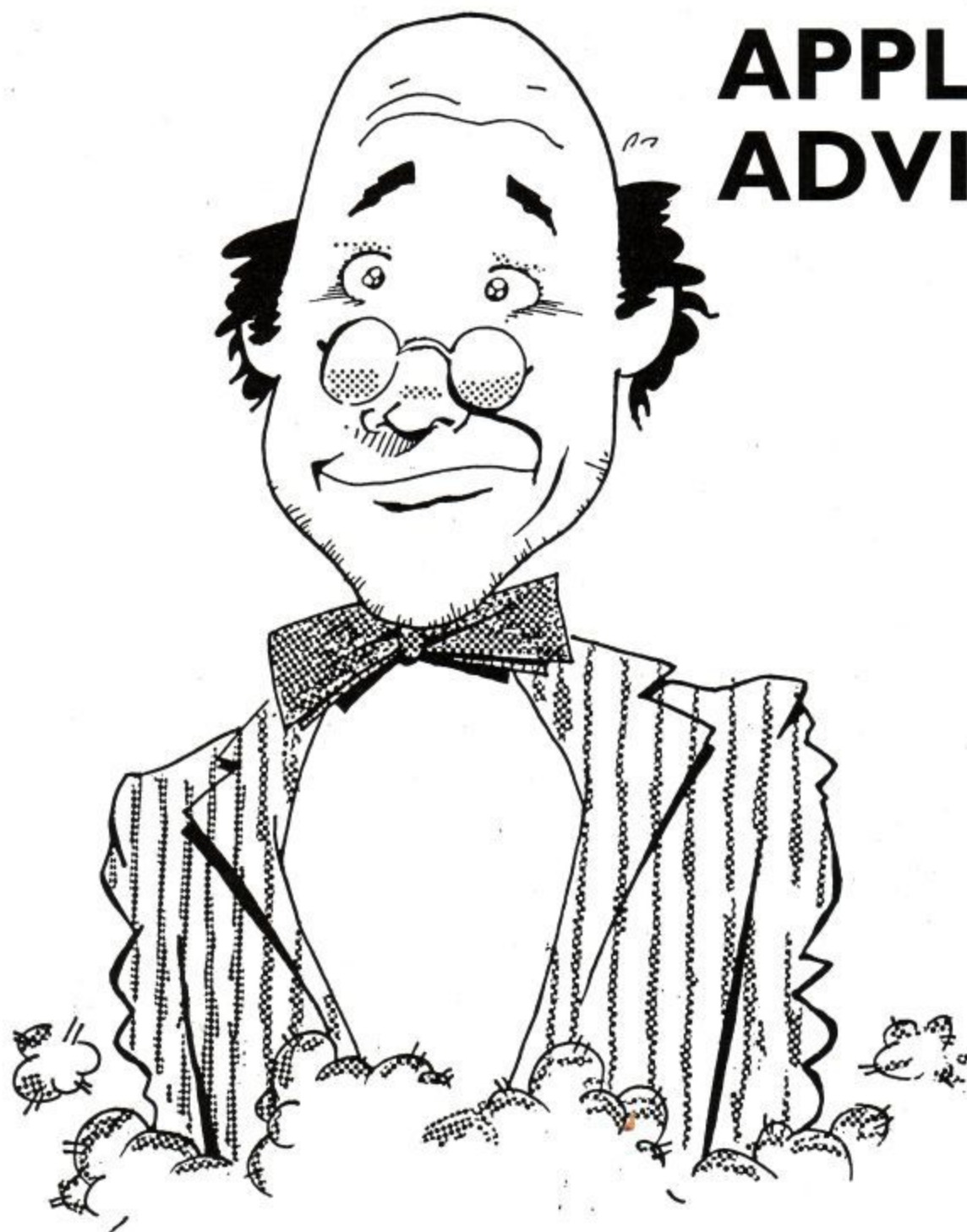

I would have chosen a fairly cheap 9-pin Epson-compatible. As it is, I think he may be better with an NEC P2200 24-pin printer. It will have a number of advantages. The first is its speed which, in draft mode, is around the 160cps mark. Second, the near letter quality output is very pleasant on the eye and is of good quality. That will be important when he writes those important business letters. A 9-pin printer, even NLQ, does not

approach the standards of a 24-pin, even with something like Qualitas driving it, and suffers in the speed department.

The cost so far, then, is around £280 for the printer, perhaps lower if you shop around, and around £260 for the computer. That makes £540, which leaves only £60 for the software.

Looking at what is available to perform stock control, accounts and word processing, it is probably easier to discard packages and narrow the final choice. The first contender, certainly on price, must be *Mini Office II* but the facilities in the database module of this package might make stock control less easy than it could be, since it is not so programmable as it needs to be to cope with such a task.

That is not a criticism; it was not designed to accommodate stock control but MO II will handle the other requirements via its word processor and spreadsheet.

What about separate packages? I have used *Money* from Connect Systems - 01-723 9792 for my accounts. It costs £24.95 and is not a bad buy - but it will not leave too much cash spare.

It is not often I am asked to specify a full business system based round a CPC but the first letter from the postbag this month asks me to do just that. It is from J. L. Carmichael of Llandovery, Dyfed. He recently bought a small shop which he intends opening as a sports shop. He says that one of his main problems will be "maintaining adequate control of stock items necessary to equip such a business". Not being very fond of paperwork and having a less than reliable memory, he has decided to delegate the work to a computer.

He has already made certain decisions, particularly about the equipment he wants to use, and sets out the

following criteria. First, the budget he must work to is £600, plus or minus 10 percent. Next, he wants to base the set-up round either a 464 or 6128,

with colour monitor and disc drive, together with a suitable printer. Finally, the software package(s) must be capable of handling the stock control, accounts, and, if possible, do some word processing.

I telephoned Carmichael to clarify one or two points, the main one being whether or not the computer was included in the overall budget, and discovered that the shop was to be concerned mainly with fishing tackle and would have a stock level of more than 300 items.

I would specify a CPC6128 but not necessarily colour. To keep within the budget, a monochrome machine is the best bet. None of the applications Carmichael wants to run needs colour; they all run in mode 2, so they are only two-colour anyway, but a built-in disc drive will be a great advantage, as will the extra memory and CPM Plus.

Next, the printer. If the requirement did not include word processing

Never mind; help is at hand from two firms which between them can cope with all of the requirements.

The *Small Trader's Pack* and *Stock Accounting System* from SD Microsystems - 0462 675106 - together cost £65, which stretches the budget a little, but is still within the 10 percent flexibility. If we add Protect to the shopping list, say £27 on disc, the final total looks like this:

Computer: Amstrad CPC6128	
Green	£260
Printer: NCC D3300	£300
Protext:	£27
STP/SAS:	£65
Total	£632

Given a little shopping around, or the assistance of a friendly local computer dealer, I reckon he could buy the lot for exactly the £600 budget figure. From there, more software can be added at fairly reasonable cost and the set-up should handle anything a small fishing tackle business can put to it for many years.

A Cornish query

I had a letter from Philip Curnow at Falmouth, Cornwall. He wrote offering an alternative to some of the higher cost Z-80 assembler packages available. It is called, strangely enough, the Z-80 Assembler, and is priced competitively at £10 on disc or £7 on cassette. Curnow says that he is working on a version which will assemble a file via a lead from one CPC to another, thus avoiding the need for moving files from one disc to another. All this resulted from a query from R. Bucks of Portsmouth about budget assemblers. Curnow tells me that he intends sending a copy of the assembler to ACU for review.

Double trouble for Dorn

I have had two very similar letters which have stumped me, not least because I have had no luck in getting my hands on the packages involved. The first is from E. F. Munroe, who says: "I have just inherited a *DR Graph*

package which I am attempting to use with a CPC6128, plus FD-1 second drive, Taxan Kaga KP810 printer and a KDS MkII 8-bit port. It works very well when inputting data from the

keyboard, giving clear graphs with no apparent problem.

"The story is different when I attempt to load a previously-saved graph from disc; it will not do it automatically, nor will it save a graph. To make the load/save process work I have to move the work disc from D: to A:. While this is not the manner in which this operation is supposed to be performed on a two-drive system, I could live with it. Once saved, a graph can be re-loaded and displayed but any attempt to print is met with the error message 'GRAPH: Menu corrupted' and the program crashes into CP/M.

"Much the same happens when using the program in single drive mode - the program takes no prisoners. Contact with Digital Research elicits the response that the product is obsolete and that telephone support ceased two years ago."

In the same batch was a letter from D.S. Swant who writes: "DR declined to answer the following questions. Can you, or your readers help?"

"TRANS.COM - this file is included on the distribution disc of DR Graph but its function is not described in the manual. How is it used?"

"In the manual for *DR Draw*, it states that a joystick can be used instead of the cursor keys. KEYS.DRW is described as a suitable key definition file but this covers only the 'fire' buttons. The other joystick keys also appear to need configuring. What is the correct re-definition?"

I cannot obtain either program. Neither can I get any meaningful response from DR, which seems to have left CP/M Plus to fend for itself.

I can only hazard a guess at the KEYS.DRW and assume that DR has included a utility much the same as SETKEYS.COM under CP/M, in which case the information needed is on page 23 in chapter 7 of the 6128 manual. Joystick 0 returns 72 for up, 73 for down, 74 for left and 75 for right. The two fire buttons return 76 for 1 and 77 for 2. If you want to use joystick 2 the corresponding codes are 48, 49, 50, and 51, with 52 and 53 for the fire buttons. Each of those codes will need to be translated into

the appropriate cursor key numbers, which are 0, 2, 8 and 1, for up, down, left and right.

The key equivalents for joystick movement codes are (6), (5), (R), and (T), and the values returned are 1,2,4 and 8 - bitwise switches on the port.

I would be grateful for any help for our two correspondents as, without the programs in question, there is little I can do and no constructive advice I can give.

Guide to modem living

The last letter this month is all to do with comms, that portion of our hobby which is often portrayed as a black art but which is, really, very simple.

K. Horner of Sheffield asks: "What do I need to begin using my 6128 to talk to other computers on systems like Prestel? I understand I need a modem which will handle 1,200/75 baud, since nothing else will do."

Nothing could be further from the truth. Prestel now has nation-wide access at local call rates and will accept all speeds from 300 to 2,400 baud, using a system called Vascom. You do not need to know anything about what happens inside the modem but I will give you an outline.

The modem takes a signal from your computer, through an RS232 interface - a serial port - and converts it into tones the telephone network

can handle. It then sends the tones down the line to the other end, where the other modem of the other computer turns them back into signals the computer can understand.

Most of the time, if you opt for fairly intelligent software you need never be aware of what is happening and just use a comms link like any other piece of software.

My suggestions for a basic outfit to get started would be a Pace Linnet modem, a Pace RS232C or Amstrad RS232C interface - both functionally identical - and the Cage Comms ROM. That will get you on to Prestel and any other viewdata-based system.

You can contact me on Prestel MBX 914177811 or Telecom Gold 74:MIK2050.

25%

off non-budget software RRP

1st Choice for fast friendly service

ARCADE		
	Tape	Disc
4 X 4 Off Road Racing	7.45	10.95
Action Force	7.45	
After Burner	7.45	10.95
Barbarian 2	7.45	10.95
Batman Caped Crus.	7.45	10.95
Command Perf	9.70	10.95
Crazy Cars 2	7.45	10.95
Cyberoid	7.45	
Dan Dare 2	5.95	
Dark Side	7.45	10.95
Dark Fusion	7.45	10.95
Dragon Ninja	7.45	10.95
Driller	10.95	13.45
Fire Trap	7.45	
Gothic		10.95
Giants	9.70	14.95
Marauder	7.45	
Netherworlds	7.45	10.95
Operation Wolf	7.45	10.95
Obliterator	7.45	
Pacland	7.45	10.95
Real Ghostbusters	7.45	10.95
Robocop	7.45	10.95
Running Man	7.45	10.95
Run The Gauntlet	7.45	10.95
Samurai Warrior	6.70	10.95
Skweek	7.45	10.95
Storm Lord	7.45	10.95
Thunderbirds	7.45	10.95
Venom Strikes Back	7.45	

ADVENTURE		
	Tape	Disc
Game Over 2	6.70	9.70
Ingrid's Back	10.95	14.95
Lancelot	10.95	14.95
Realm of the Troils	7.45	9.70
Time and Magic	10.95	10.95

BUSINESS		
	Tape	Disc
HomeBudget	1.75	
Mastercalc 128 (6128)		24.70
Masterfile 3		29.95
Mini Office 2	10.95	14.95
Protext	14.95	19.95
Tasword (464 or 6128)	18.70	22.45
Tascopy	8.95	10.95

BUDGET		
	Tape	Disc
Choice Cheats 1	2.99	4.99
Choice Cheats 2	2.99	4.99
Big Foot	2.99	
Commando	2.99	
Football Manager	2.99	
Footballer of the Year	2.99	
Gauntlet	2.99	
Moto Cross Simulator	2.99	
Pro Snooker	2.99	
SAS Combat	2.99	
Street Gang Football	2.99	
The Hit Squad	2.99	
Treasure Island Dizzy	2.99	
Twin Turbo V8	2.99	
Zorro	2.99	
Air Wolf	1.99	
B. McGuigan's Boxing	1.99	
Bomb Jack	1.99	
Bubble Bobble	1.99	
Dynamite Dan	1.99	
Dun Darach	1.99	
European 5 a Side	1.99	
Ghostbusters	1.99	
Gun Boat	1.99	
Joe Blade 2	1.99	
Shanghi Karate	1.99	
Steve Davis Snooker	1.99	
Thing	1.99	
Yabba Dabba Doo	1.99	
Yogi Bear	1.99	
Xeno	1.99	

EDUCATION

	Tape	Disc
Answer Back Quiz (6-11)	7.45	10.45
Fact Files for above		
Arithmetic (6-11)	3.70	6.70
English Words (12+)	3.70	6.70
Gen. Knowledge (12+)	3.70	6.70
Gen. Science (14+)	3.70	6.70
Nat. History (10+)	3.70	6.70
Spelling (6-11)	3.70	6.70
Better Maths (12-16)	8.20	12.70
Better Spelling (9-14)	8.20	12.70
Biology (12-16)	8.20	12.70
Chemistry (12-16)	8.20	12.70
Chemistry GCSE	10.95	14.95
French Mistress		14.95
Fun School (2-5)	4.45	6.70
Fun School (5-8)	4.45	6.70
Fun School (8-12)	4.45	6.70
Fun School 2 (Under 6)	7.45	9.70
Fun School 2 (6-8)	7.45	9.70
Fun School 2 (Over 8)	7.45	9.70
German Master		14.95
Magic Maths (4-8)	8.20	12.70
Maths Mania (6-12)	8.20	12.70
Maxi Maths (9-14)	8.20	12.70
Physics (12-16)	8.20	12.70
Physics GCSE	10.95	14.95
Spelling		6.70

LEISURE & SPORT

E. Hughes Int. Soccer	7.45	10.95
Football Manager 2	7.45	10.95
Game Set and Match 2	9.70	13.45
G. Lineker Sup. Skills	7.45	10.95
Gold Silver Bronze	10.95	18.70
Tour de Force	7.45	
Triv. Pursuit New Beg.	10.95	14.95
Triv. Pursuit Genius	10.95	14.95
Triv. Pursuit Young	10.95	14.95
Wec le Mans	7.45	10.95

EDUCATION EXTRA
Buy any 2 educational products

£1 off next order

BUDGET BARGAIN
Save over a £1
3 @ £1.99
or
2 @ £2.99
only £4.99

CHEAT for only **Tape £2.99**
Disc £4.99

Bend the rules! Play your games until dusk, with cheat options such as infinite weapons and immunity.

CHOICE CHEATS 1

Cheat at: By Fair Means or Foul, Cyberoid, Karnov, Operation Wolf, Flying Shark, Radius, Titanium, Advanced Pinball Simulator, Joe Blade 2, Star Trooper, Reflex and Shanghi Karate.

CHOICE CHEATS 2

Cheat at: Dragon Ninja, Hopper Copper, Arkanoid, Arkanoid 2, Dynamite Dan, Solomon's Key, Dizzy 2, ATV Simulator, Empire Strikes Back, Pro Ski Simulator, Batman and Head Over Heels.

Many more items in stock than listed phone us for **DISCOUNT PRICES**

All prices are inclusive of VAT and P & P in UK.

To order send cheque or PO to
1st Choice Software Ltd
Dept AU10

4 Paul Row, Temple Lane
Littleborough, Lancs. OL15 9QG

Please state Name, Address, Title, Disc or Cassette and price



phone 0706 72728



POOLS FORECASTER ONE & TWO CPC 464/664/6128 TAPE OR DISC

- * LEAGUE DATAFILE - current English and Scottish divisions. Easily MODIFIED for each new season or CREATE YOUR OWN - Australian, local amateur etc - 144 teams in 10 divisions. Non-league teams and CUP games can be added.
- * FORECASTS - two formulae, selectable factors. Predicts HOME/DRAW/AWAY %s plus SCORECAST in one compact report. CUP adjustment. FIXED ODDS data and sorted SELECTION LISTS available. SEQUENCE LISTS and FORM SUMMARY display.
- * OPTION ONE - full h/a 1ge tables, last 4 home + 4 away results. 8 factors.
- * OPTION TWO - total 1ge tables (P W D L F A PT), last 5 results. 6 factors.
- * ONE or TWO - £14 (disc £16). (No LEAGUE - £3 off).
- * BOTH - £18 (disc £20). MATCH files transfer between the two for dual use.

SEARCHPACK CPC 6128 DISC £12 (£6 with another disc item)

- * A UTILITY for Basic Programmers - handles ASCII files to approx 60K.
- * SEARCH - Edit str(W)/Find str(X-ref str(W)/Replace str(GS)/X-ref lines.
- * PACK - take out excess spaces or REMS(GS), concatenate short lines.
- * ALSO - edit/auto edit/delete(GS)/renumber/copy input. (GS):global/select. (W): wildcard. List and X-ref to screen or Printer. Save any PART. MERGE files. Mode 1 or 2. Screen clock. Keyboard definable. Uses Bank Manager.

ALL PROGRAMS feature instructions, easy back-up from menu, single keypress selection, screen colour control, output to any Printer, 1 or 2 disc drive operation, disc/tape switch, cat+erase files. SEND SAE for details, please, OR cross cheque/PO (to Bug-hunters) - state model, tape/disc, items reqd.

BUG-HUNTERS (ACU), 71 Milford Close, Abbey Wood, LONDON SE2 0DS

ONLY POOLS AND HORSES

FOOTBALL BOXFORM £14.95 (+ £2 for 3" disc)

- * The ONLY pools program written by a GENUINE EXPERT who has been professionally employed as such by the leading pools company.
- * The ONLY program dealing with football form that has its team merit ratings published in a national sporting magazine.
- * The ONLY program that uses machine code and advanced statistical methods to analyse football form. Lists homes aways and draws in order of merit and gives true odds for every match. Covers league & non-league clubs.
- * The ONLY program to claim 50% MORE DRAWS than obtained by chance.

BOXFORM & HANDICAP WINNER £14.95 (+ £2 for 3" disc)

Two programs for the price of one. Easy to use and they never go out of date. All you need is a few minutes with a daily paper. BOXFORM weights up a race by considering the many facets of form. Easily amended to suit the user's ideas. HANDICAP WINNER shows the value for money bets. OVER 600 WINNERS in handicaps this year at prices up to 25/1.

SPECIAL PRICE of £24.95 (+ £2 for 3" disc) for all of the above programs

RACING TOOL KIT (with Football Boxform £59.90) £49.95 tape or disc.

A package of 7 programs for the racing enthusiast. BOXFORM & HANDICAP WINNER plus programs to produce ratings and time figures, update private handicaps or form your own, keep records, work out almost any bet etc. etc.

Why pay inflated prices? BOXoft CLEVER and get the BEST

Available on tape or disc for Spectrum, CMD C64/128, AMS CPC's, BBC B. from:



BOXOFT (ACU), 65 Allans Meadow, Neston, South Wirral. L64 9SQ.
Credit card holders may phone: 051-336-2668 (24 hrs)



G-TEN Limited



THE MAIL ORDER SOFTWARE HOUSE

AMSTRAD CPC	TAPE	DISC	BUSINESS SOFTWARE	
Action Service	7.25	12.25	(Carriage Free)	
Afterburner	7.25	12.25		
Barbarian II	7.25	12.25	AMSTRAD PCW	
Batman	7.25	12.25	Integrated Accounts V5.0	135.00
Carrier Command	12.25	17.25	Sales Ledger V5.0	60.00
Cyberoid II	7.25	12.25	Nominal Ledger V5.0	60.00
Dominator	7.25	12.25	Purchase Ledger V5.0	60.00
Dragon Ninja	7.25	12.25	Aztec C	75.00
Eliminator	7.25	12.25	Nevada Cobol	45.00
Espionage	6.75	12.25	Nevada Fortran 66	35.00
Final Assault	7.25	17.25	Pascal 80	45.00
Flight Ace	12.25	16.50	Z Basic	65.00
GI Hero	6.25	12.25	D.T. Publisher + Mouse	75.00
Giants	10.50	17.25	Fleet Street Editor + V.I.O.	45.00
Hill 19	7.25	12.25		
I.S.S.	7.25	12.25	PERIPHERALS	
Jinks	7.25	12.25	(Carriage Free)	
Karate Ace	10.50	12.25	Dust Cover CPC	7.50
Last Ninja II	10.50	12.25	Amstrad Joystick I/II	5.95
Led Storm	7.25	12.25	QuickStart II Turbo	13.95
Mind Stone	6.75	10.50	Pro 5000 Joystick	14.95
Night Raider	7.25	12.25	Mouse Mats	4.95
Out Run	7.25	12.25		
Parisian Knights	10.50	12.25	Government & Educational	
Red Heat	7.25	12.25	Establishment orders welcomed	
Robocop	6.75	12.25	Please allow 14-28 day delivery. Do not send cash	
Special Action	10.50	15.50	by post. Strictly Mail Order. P.O. or Access Card	
Soccer	12.25	17.25	Orders despatched within 48 hrs subject to	
Special Action	10.50	15.50	availability. P&P included in UK, EC, BFPO.	
Thunderbirds	10.50	12.25	Elsewhere add £3 per item.	
Technocop	7.25	12.25		
Vigilante	7.25	12.25		

Please make cheques or P.O. made payable to G-Ten Limited
Send your order to:

G-TEN LIMITED,
Dept AMU 01, 5A Edgware Road, London NW9 5DL.
or call 24-hr telesales no. 01-200 4858

BUY TWO GAMES GET ONE FREE MYSTERY GAME FREE (Tape version only)

520ST-FM SUPER PACK



**1Mb DISK DRIVE
£450 OF SOFTWARE**

ARCADE GAMES

Arkanoid II	Imagine	£19.95
Beyond The Ice Palace	Elite	£19.95
Black Lamp	Firebird	£19.95
Buggy Boy	Elite	£19.95
Chopper X	Mastertronic	£9.99
Ikari Warriors	Elite	£14.95
Marble Madness	Electronic Arts	£24.95
Quadralien	Logotron	£19.95
Ranarama	Hewson Consultants	£19.95
Return To Genesis	Firebird	£19.95
Roadwars	Melbourne House	£19.95
Starquake	Mandarin	£19.95
Test Drive	Electronic Arts	£24.95
Thrust	Firebird	£9.95
Thundercats	Elite	£19.95
Wizball	Ocean	£19.95
Xenon	Melbourne House	£19.95
Zynaps	Hewson Consultants	£19.95

SPORTS SIMULATIONS

Eddie Edwards Super Ski	Elite	£19.95
Seconds Out	Tynesoft	£19.95
Summer Olympiad '88	Tynesoft	£19.95

PRODUCTIVITY SOFTWARE

Organiser	Triangle Publishing	£49.95
-----------	---------------------	--------

JOYSTICK

Atari CX40 Joystick	Atari Corp	£4.99
---------------------	------------	-------

FREE ATARI BUNDLE VALUE: £458.97

£399
INCLUDING VAT

With SM124 mono monitor: £498 ^{INC VAT} With SC1224 colour monitor: £698 ^{INC VAT}

1040ST-FM PROFESSIONAL PACK

NOW WITH TV MODULATOR

For the serious home user and the small business, we are pleased to announce a new package based around the 1040ST-FM. The 1040ST-FM has 1Mbyte RAM and a 1Mbyte built-in disk drive. In addition, the 1040ST-FM now comes with a TV modulator built-in. (The previously available 1040ST-F was designed for use with a monitor only and did not come with a modulator.) This modulator allows the 1040ST-F to be plugged directly into any domestic TV set, and comes complete with a lead to allow you to do so. The new 'Professional Pack' from Silica includes the new 1040ST-FM with modulator plus four high quality software packages including a spreadsheet, database, word processor and programming language. This 'Professional Pack' software will enable you to get straight down to business with your new computer. In addition to this software (worth £384.84), if you buy the Professional Pack from Silica Shop, you will also receive the Silica ST Starter Kit (worth over £200), FREE OF CHARGE. Return the coupon for further information.

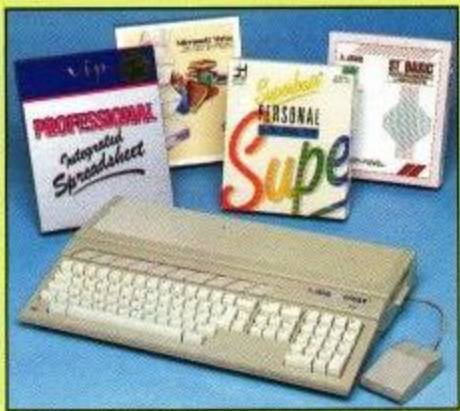

£499
INCLUDING VAT

With SM124 mono monitor: £598 ^{INC VAT}
With SC1224 colour monitor: £798 ^{INC VAT}

ATARI 1040ST-FM	(Computer)	£499.99
VIP PROFESSIONAL	(Spreadsheet)	£149.95
MICROSOFT WRITE	(Word Processor)	£149.95
SUPERBASE PERSONAL	(Database)	£59.95
BASIC DISK & MANUAL	(Language)	£24.98
NORMAL RRP:		£884.82
LESS DISCOUNT:		-£385.82
PROFESSIONAL PACK PRICE:		£499.00

2Mb & 4Mb MEGA ST

The MEGA ST computers are styled as a lightweight keyboard with a separate CPU, connected by a coiled telephone style cable. There are two versions of the MEGA ST, one with 2Mbytes of RAM and the other with 4Mbytes. Each version has a 1Mbyte double sided disk drive built-in to the CPU unit. The MEGA ST's do not come with modulator built-in and must therefore be used with a monitor. With every MEGA ST purchased, we will add the 'Professional Pack' software (worth £384.83) detailed above, plus the Silica ST Starter Kit (worth over £200) both FREE OF CHARGE. Return the coupon for further details.



2Mb MEGA ST

£899 ^{INC VAT}

+ mono monitor = £998

+ colour monitor = £1198

4Mb MEGA ST

£1199 ^{INC VAT}

+ mono monitor = £1298

+ colour monitor = £1498

DTP PageStream £149 ^{+VAT} =£171.35

Desktop Publishing (DTP) is one of the fastest growing applications for personal computers. We are pleased to announce a powerful low cost package for the Atari ST called PageStream. PageStream costs only £149 (+VAT=£171.35) and, because it works with an Atari 1040ST and a Silica SP-180AJ printer, you can be up and running with a complete system for less than £1000. Some of the features of PageStream are listed to the right. If you would like further information on this program, complete and return the coupon below, ticking the 'DTP' box in the corner.

- TEXT-FLOW AROUND GRAPHICS
- ROTATION OF TEXT & GRAPHICS
- SLANT OR TWIST ANY OBJECT
- POSTSCRIPT COMPATIBLE
- TAG FUNCTION
- AUTO/MANUAL KERNING & HYPHENATION
- GROUPING OF OBJECTS

DO YOU OWN AN ATARI ST?

If you already own an Atari ST computer and would like to be registered on our mailing list as an ST user, let us know. We will be pleased to send you copies of our price-lists and newsletters FREE OF CHARGE as they become available. Complete the coupon and return it to our Sidcup branch and begin experiencing a specialist ST service that is second to none.

SILICA SHOP:

SIDCUP (& Mail Order)	01-309 1111
1-4 The Mews, Hatherley Road, Sidcup, Kent, DA14 4DX	
OPEN: MON-SAT 9am - 5.30pm LATE NIGHT: FRIDAY 9am - 7pm	
LONDON	01-580 4000
52 Tottenham Court Road, London, W1P 0BA	
OPEN: MON-SAT 9.30am - 6.00pm LATE NIGHT: NONE	
LONDON	01-629 1234 ext 3914
Selfridges (1st floor), Oxford Street, London, W1A 1AB	
OPEN: MON-SAT 9am - 6.00pm LATE NIGHT: THURSDAY 9am - 8pm	



ST COMPUTERS

The range of Atari ST computers offers something for everyone. From the games enthusiast who wants the challenge of the very best in arcade action, to the businessman who wants to make financial forecasts or faultless presentations. The ST offers high quality graphics, sound and speed for the gamer, whilst providing a fast, user friendly and affordable solution to business. The ST is now firmly established in the home environment and boasts a wealth of users in education, local government, television, and a variety of different businesses. Software for the range stretches to cover applications as diverse as ENTERTAINMENT, ACCOUNTS, ART, COMMUNICATIONS, COMPUTER AIDED DESIGN, DATABASES, DESKTOP PUBLISHING, EDUCATION, MUSIC, PROGRAMMING, SPREADSHEETS, WORD PROCESSING and more. For a full list of the software available, as well as details of the ST range, complete and return the coupon below.

All prices correct at the time of going to press. £40E

520ST-FM EXPLORER PACK WITH BUILT-IN 1Mb DISK DRIVE



The value for money offered by the Atari ST range is reflected in the Explorer Pack featuring the 520ST-FM computer with 512K RAM. The 520ST-FM computer now comes with a built-in 1 Mb double sided disk drive as well as a free mouse controller and a built-in TV modulator. The new 520ST-FM Explorer Pack includes the 520ST-FM computer, the arcade game Ranarama, a tutorial program and some useful desktop accessories. In addition, if you buy the Explorer Pack from Silica, we will give you the Silica ST Starter Kit worth over £200, FREE OF CHARGE. Return the coupon for details of our Starter Kit and of the full ST range.

£260 ^{+VAT=} **£299**

ONLY £2.51 PER WEEK
RETURN COUPON FOR DETAILS

+ SM124 mono monitor: £398 ^{INC VAT} + SC1224 colour monitor: £598 ^{INC VAT}

WHY SILICA SHOP?

Before you decide when to buy your new Atari ST computer, we suggest you consider very carefully WHERE you buy it. There are MANY companies who can offer you a computer, a few peripherals and the top ten selling titles. There are FEWER companies who can offer a wide range of products for your computer and expert advice and help when you need it. There is ONLY ONE company who can provide the largest range of Atari ST related products in the UK, a full time Atari ST specialist technical helpline and in-depth after sales support, including free newsletters and brochures delivered to your door for as long as you require after you purchase your computer. That one company is Silica Shop. We have been established in the home computer field for ten years with an annual turnover in excess of £8 million and can now claim to meet our customers requirements with an accuracy and understanding which is second to none. But don't just take our word for it. Complete and return the coupon below for our latest literature and begin to experience the Silica Shop specialist Atari service.

- SILICA STARTER KIT:** Worth over £200, FREE with every Atari ST computer bought from Silica.
- PROFESSIONAL PACK:** Free business software with 1040ST-FM and MEGA ST's bought from Silica.
- DEDICATED SERVICING:** 7 full-time Atari trained staff with years of experience on Atari servicing.
- THE FULL STOCK RANGE:** All of your Atari requirements from one place.
- AFTER SALES SUPPORT:** The staff at Silica are dedicated to help you get the best from your ST.
- FREE CATALOGUES:** Mailed direct to your home as soon as we print them, featuring offers as well as all of the new releases.
- FREE OVERNIGHT DELIVERY:** On all hardware orders shipped within the UK mainland.
- PRICE MATCH PROMISE:** We will match competitors on a 'same product same price' basis.
- FREE TECHNICAL HELPLINE:** Full time team of Atari technical experts always at your service.

FREE SILICA STARTER KIT WORTH OVER £200

WITH EVERY ST - RETURN COUPON FOR DETAILS
ALL PRICES QUOTED INCLUDE FREE UK DELIVERY

To: Silica Shop Ltd, Dept AMSACU 1089, 1-4 The Mews, Hatherley Road, Sidcup, Kent DA11 4DX
PLEASE SEND FREE LITERATURE ON THE ATARI ST

Mr/Mrs/Ms: Initials: Surname:

Address:

Postcode:

Do you already own a computer
If so, which one do you own? DTP

TASWORD 6128

The Word Processor - with Mail Merge

The established, powerful word processor for the Amstrad CPC 6128. TASWORD 6128 has been specially developed to use 64K of memory as text space. This means a text file can be a massive 60,000 characters long, enough room for over 10,000 words! Featuring all standard and many extra word processing facilities TASWORD 6128 includes sophisticated print options, on-screen help, notepads and a built-in data merge facility. Extensive customisation options allow many facilities to be changed to your requirements and then saved into the program. Combining power with ease of use, TASWORD 6128 is the complete word processor for the CPC 6128.

TASWORD 6128 Disc £29.95



PERFECTION IN PROFESSIONAL SOFTWARE

Springfield House, Hyde Terrace, Leeds LS2 9LN Tel (0532) 438301

If you do not want to cut this magazine, simply write out your order and post to:
TASMAN SOFTWARE LTD, DEPT ACU, SPRINGFIELD HOUSE, HYDE TERRACE, LEEDS LS2 9LN

I enclose a cheque/PO made payable to Tasman Software Ltd OR
charge my ACCESS/VISA number: _____ Card expiry date: _____ ACU

NAME _____ ITEM _____ PRICE £ _____
ADDRESS _____ £ _____
£ _____

Telephone Access/Visa orders: Leeds (0532) 438301 Outside Europe add £2 per item airmail TOTAL £ _____

Please send me a FREE Tasman brochure describing your products for the IBM/Amstrad PC Amstrad PCW Amstrad CPC

All prices include VAT and post and packing

TASWORD 464

The Word Processor

Your 464 becomes a professional standard word processor with TASWORD 464. Supplied complete with a comprehensive manual and a cassette which contains the TASWORD 464 TUTOR to teach you word processing using TASWORD 464.

TASWORD 464 cassette £24.95

TAS-SIGN

The Sign Maker for the CPC 6128 and PCW

Produce and print your own signs, banners and large notices to get your message across with maximum impact. A complete sign making package including four distinctive lettering styles and character heights from one inch to the full width of the paper. Signs may be printed across the paper or along the length of the paper to produce large eye-catching banners and notices.

TAS-SIGN (dot matrix printers only) disc £29.95

Use the clip coupon below and send for our FREE brochure describing these and other products for the CPC range.

POOLSWINNER II

THE ULTIMATE POOLS PREDICTION PROGRAM

- **MASSIVE DATABASE** Poolswinner is a sophisticated Pools prediction aid. It comes complete with the largest database available - 22000 matches over 10 years.
- **PREDICTS** Not just SCOREDRAWS, but ALWAYS, HOMES and NO SCORES.
- **SUCCESSFUL** SELEC guarantee that Poolswinner performs significantly better than chance.
- **ADAPTABLE** Probabilities are given on every fixture - choose as many selections as you need for your bet. The precise prediction formula can be set by the user - you can develop and test your own unique method.
- **SIMPLE DATA ENTRY** All team names are in the program. Simply type in the reference numbers from the screen. Or use FIXGEN to produce fixture list automatically (see below).
- **LEAGUE AND NON-LEAGUE** All English and Scottish League teams are supported, and also the non-league sides often used on pools coupons.
- **PRINTER SUPPORT** Full hard copy printout of data if you have a printer.



PRICE £18.00 (all inclusive)

FIXGEN 88/9

AT LAST: No more struggling for hours to get the fixture list into the computer. FIXGEN has been programmed with all English and Scottish League fixtures for 1988/89. Simply type in the date, and the full fixture list is generated in seconds. Fully compatible with Poolswinner. Yearly updates available.

POOLSWINNER with FIXGEN £19.50 (for both)

COURSEWINNER v3

THE PUNTERS COMPUTER PROGRAM

NOT JUST A TIPSTER PROGRAM, Coursewinner V3 can be used by experts and occasional punters alike. You can develop and test your own unique winning system by adjusting the analysis formula, or use the program in simple mode. Coursewinner V3 uses statistical analysis of major factors including past form, speed ratings, course statistics, prize money, weight, going, trainer and jockey form etc, etc. It outputs most likely winners, good long odds bets, forecasts, tricast etc. The database includes vital course statistics for all British courses. You can update the database - never goes out of date. FULL PRINTER SUPPORT.

PRICE £18.00 (all inclusive) includes Flat AND National Hunt versions.

AVAILABLE FOR

All supplied on tape ...
(Automatic Conversion to disc)

AMSTRAD CPCs
BBCs
COMMODORE 64/128
SPECTRUM

DISCS ...

(Add £3.00)

AMSTRAD PCW
IBM Format
COMMODORE AMIGA
ATARI ST

Send Cheques/POs for
return of post service to ...



62 ALTRINCHAM RD, GATLEY, CHEADLE, CHESHIRE SK8 4DP. ☎ 061-428 7425
(Send for full list of our software)

INDEX

REC	COMPANY	Page no.
1	Arc	30
2	Astrocalc	25
3	Boxsoft	72
4	Brunning Software	14
5	Bug Hunters	72
6	Connect Software	63
7	Crazy Joes	25
8	Dart Electronics	30
9	Datel Electronics	8,9
10	EJ Software	63
11	First Choice Software	72
12	G-Ten	72
13	Home Based Business	63
14	Jackson Computers	63
15	Jackson Software	15
16	John Morrison	25
17	K & M Computers	49
18	LCL	25
19	LGRM	15
20	Micro Text	29
21	Mircrogenic	30
22	MJC Supplies	58
23	Mode One	29
24	O.J. Software	29
25	Ocean Software	IFC,IBC,OBC
26	RSD Connections	59
27	S.D.C.	62
28	Selec Software	74
29	Silica Shop	67,73
30	Siren Software	59
31	Smog	25
32	Star Micronics	23
33	Strategy Software	15
34	Tasman Software	74
35	Titus	13
36	TMC	30
37	Virgin Mastertronic	4
38	VSE	25
39	Williams Services	15

NOW THE HIT NAMES · THE HIT GAMES
From

The HIT SQUAD

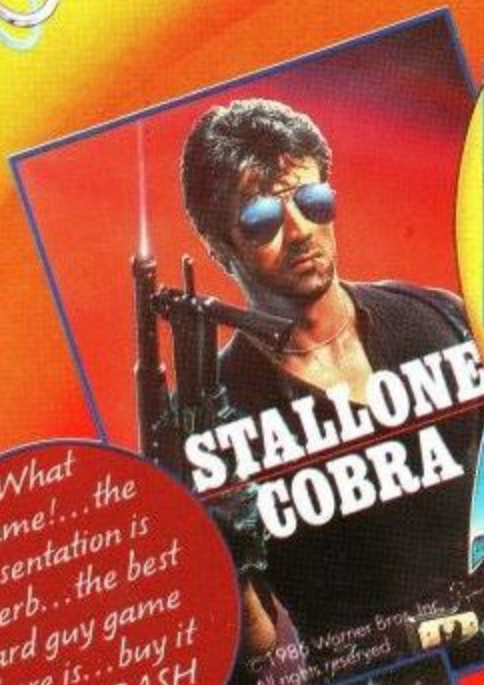

"What a game!... the presentation is superb... the best hard guy game there is... buy it now" **CRASH Smash**

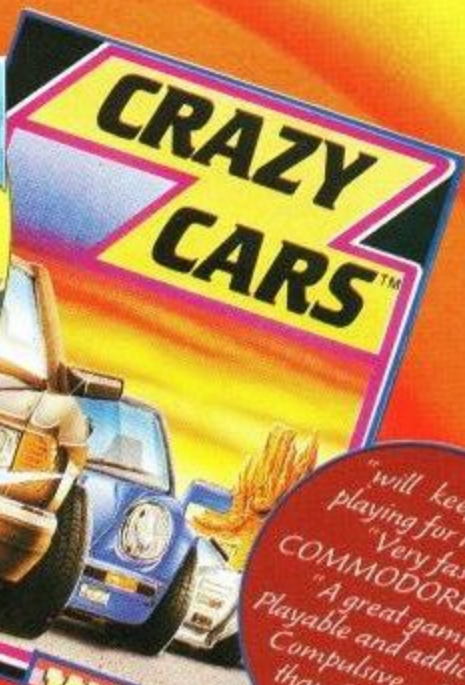

"will keep you playing for hours" "Very fast" **COMMODORE USER**
 "A great game... Playable and addictive... Compulsive... Faster than Out Run (!)" **CRASH**



"This is programming of the highest order on any machine" **AMSTRAD USER**
 "You'll want to play it again and again" **SINC. USER Classic CRASH Smash.**

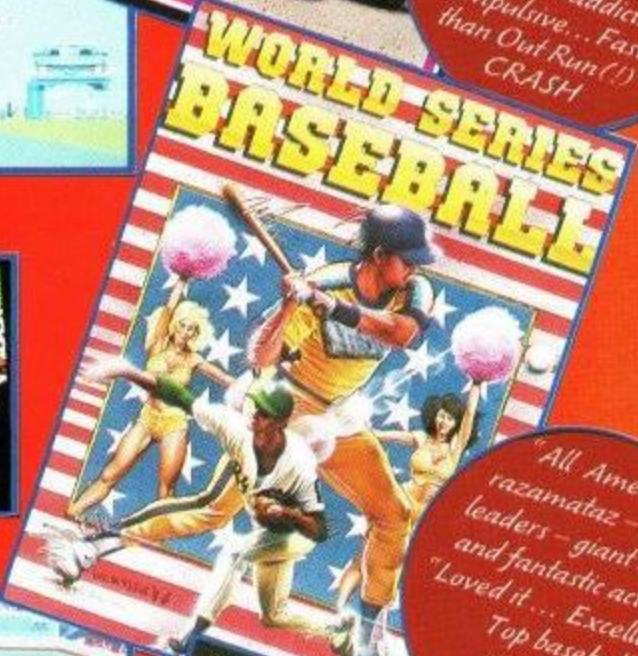

"All American razamatatz - cheer leaders - giant screen and fantastic action" "Loved it... Excellent... Top baseball simulation" - **ZZAP Sizzler**

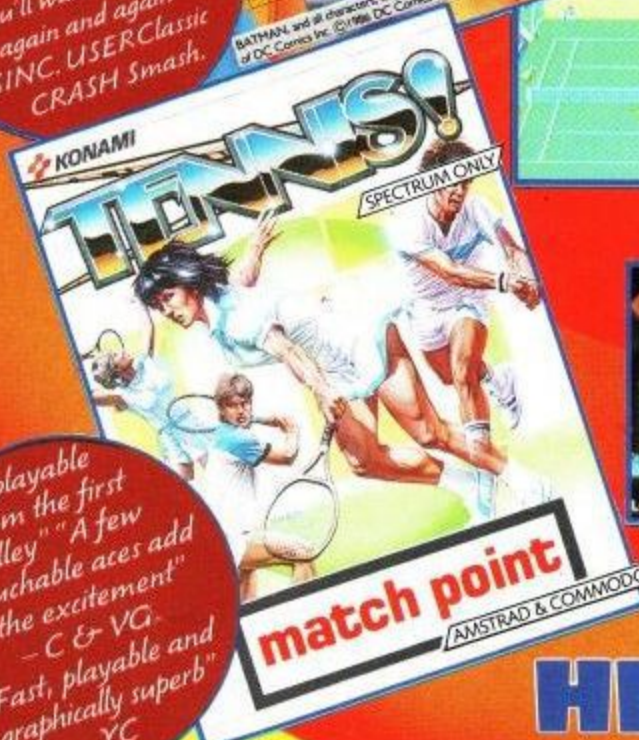

"playable from the first volley" "A few untouchable aces add to the excitement" - **C & VG.**
 "Fast, playable and graphically superb" **YC**

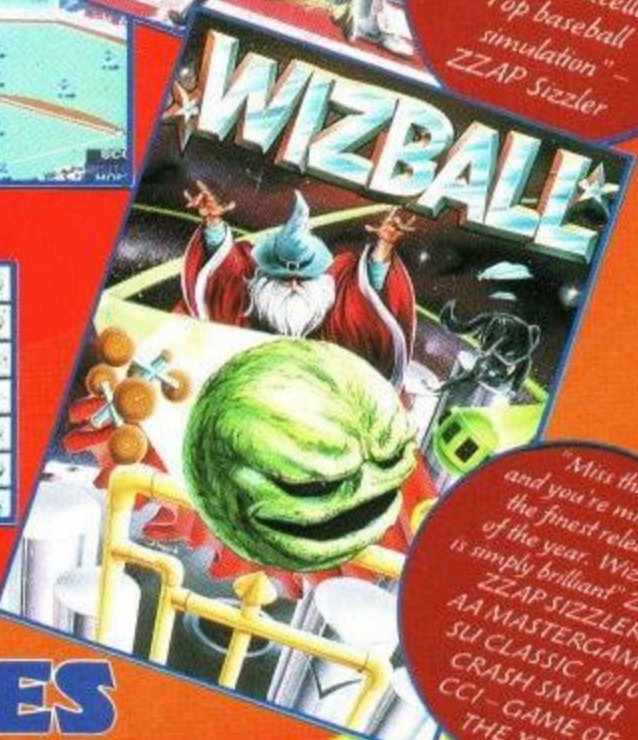

"Miss this and you're missing the finest release of the year. Wizball is simply brilliant" **ZZAP SIZZLER**
AA MASTERCAME
SU CLASSIC 10/10
CRASH SMASH
CCI - GAME OF THE YEAR

HIT NAMES HIT GAMES · HIT SQUAD

SIX MORE SUPERB GAMES AT INCREDIBLE PRICES
ASK FOR THEM BY NAME AT YOUR COMPUTER SOFTWARE STOCKIST
ONLY £2.99

ACTION RATING-99%



MOSCOW'S TOUGHEST DETECTIVE. CHICAGO'S CRAZIEST COP. THERE'S ONLY ONE THING WORSE THAN MAKING THEM MAD. MAKING THEM PARTNERS.

The heat is on ... and the chase is in full cry as East and West join forces to hunt down a Soviet drugs dealer. The two detectives; one Russian, one American have very different methods of capturing their prey, but together they face the worst of Chicago's underworld – street fights, the 'Cleanheads' gang, gun fire – the hottest film tie-in to date – it's all action with stunning graphics – feel the heat – RED HEAT.



THIS IS THE CLIMAX ...

THRILLING ACTION THROUGH TIME AND SPACE

When a guy loses his girl – he loses his mind! Now, in the Final Chapter, Renegade must summon all his strength and lightning reactions as he chases his girlfriend's captors through time itself. Fight against neolithic man, mediaeval knights, and the tormented undead from within the tombs of Ancient Egypt. Your quest finally takes you BEYOND the present – to a time you'll never forget! ... but remember ... your girl wants to see you alive!



NOW FOR THE ATARI ST & AMIGA



9 EXPLOSIVE EVENTS

JET SKIS · HOVERS · QUADS · BUGGYS · THE HILL · METEORS · SUPERCATS · SPEEDBOATS · INFLATABLES

Hot from the Television series – the toughest, most exciting, multi-machine assault course to hit your screens! Simulating the skills of controlling the Jet Skis, the speed of the buggys, the sheer guts and stamina required for The Hill and much, much more! Run wild – Run The Gauntlet!



(THE OTHER 1% IS FOR LOADING)

SPECTRUM
£8.99 EA
CASSETTE

ocean

COMMODORE
AMSTRAD
£9.99 EA
CASSETTE

RED HEAT
RENEGADE III

THE FINAL CHAPTER

RUN THE GAUNTLET