

**FREE AD!**  
**TURN TO**  
**PAGE 47**  
**NOW!**



# COMPUTER **EXPRESS**

**BRITAIN'S BIGGEST SELLING COMPUTER WEEKLY**

## PC

- Sound board on test
- BASIC 2 review
- ROM screen fonts

## AMIGA

- Budget bonanza?
- DigiView upgrade
- New emulator
- Comms pack

## ST

- STE by Christmas?
- TT news
- Music with Quartet

## PCW

- New Mini Office

## SPECTRUM

- Multiface returns

## ARCHIMEDES

- Minerva database

**QL • BBC • C64**  
**CPC • MSX**  
**SPECIALIST COLUMNS**

# CRISIS



**Why this man  
must sell  
£200m of  
computers  
- and fast**

**page 2**

## ● PRESS FOR INTERACTION

Interactive video shows the way to the 90s **page 7**

## ● ARC LIGHTS UP

The Archimedes software explosion **page 16**



# 60 GREATEST GAMES

**32 PAGES PACKED WITH BRITAIN'S BEST COMPUTER BARGAINS**

**★ SHOPPING EXPRESS ★**

# CONTENTS

## FEATURES

- INTERACTIVE VIDEO** 8  
Report on the future of communicating with the computer
- OUT OF THE ARC** 16  
How software is finally reaching Acorn's power machine
- SOUND OFF** 11  
A add-on board promises top quality sound on the PC
- QUARTET** 11  
A new music-making package for the ST
- BEGINNERS** 14  
Making a start in the world of programming
- BUYERS' GUIDE** 28  
Comprehensive survey of the best games for your machine

## REGULARS

- COMMENT** 4
- LETTERS** 12
- EXPRESS SALES** 32  
The best bargains in Christendom
- JOBS** 44  
Roll up, get your new job here
- TECH TIPS** 60
- READERS' CLASSIFIED ADS** 26
- GAMEPLAY** 49  
This weeks hard-hitting report on the coming and goings in the games world - releases, reviews, ranting...
- VOUCHERS** 17  
Save £10!
- BACK PAGE** 54  
The end of the mag

## YOUR MACHINE

- Amiga** 52
- ST** 52
- PC** 53
- CPC** 54
- Spectrum** 54
- Commodore 64** 58
- PCW, QL** 58
- BBC** 58
- MSX** 58
- Archimedes** 59

● Machine sell off likely as profits plummet

# AMSTRAD FACES CASH CRISIS

Amstrad is in disarray after its latest figures show plunging profits, mushrooming overheads, a cash deficit - and huge stocks of unsold machines.

Computers worth £200 million are sitting in warehouses, most of them PC2000s - the high-end range whose sales still haven't taken off for the company. This is more than twice what Amstrad sold this year. If Amstrad is going to shift them margins must suffer - which means cheaper top-end PCs in the shops.

After problems with one of its main High Street retailers, Dixons, which took the Olivetti PC much to Amstrad's annoyance last year, Amstrad may be forced to go cap in hand to ask retailers to shift stock at cut prices.

But Amstrad's Nick Hewer dismissed the possibility of giveaway PC2000s. He told *Express*, "People may try to beat us down on margins, but we shall try our best to sell the equipment at normal margins in the normal and orderly way. It's not a fire sale. There'll be no surprises."

### SLUMP

The slump in Amstrad's fortunes is shown dramatically by its share price, down to 47p from its high of 208p last year. Relative to the FT All-share index, it has plummeted from 900 to 200. The present undervaluing of the company, which puts its total market value at £267m with its assets at £311m, means that the company could be bought for less than it is worth, and Sugar is threatening to buy all the shares himself, in effect buying back the company, which was floated in 1980.

Sugar, clearly frustrated by the low share price despite the company's still considerable profits this year, said "I see no necessity for remaining in the firing line if we are not being thanked for it by

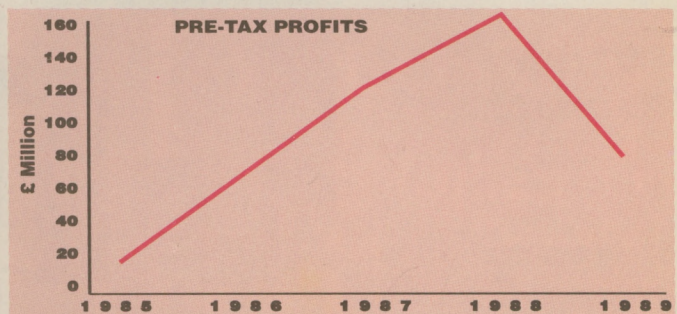

• Sugar: "No thanks"

any form of rating", and threatened to repurchase the stock. But to do this, Sugar needs cash, and the cash to buy the company back must come from sales - which would mean severe margin cutting to shift the stockpile of PCs.

But the reluctance of investors to put their money in Amstrad is easy to see. The profits halved last year and are likely to halve again; the company's cash position has turned from positive to £100m of borrowing; and perhaps most importantly the company's main market, the UK, has seen the consumer spending.

Sugar has dramatic proposals to make

the company more profitable again. First is the closure of Amstrad's audio division - the original business which started Alan Sugar off in the 1970s. Second would be a radical re-organisation of management.

The company's results to 30th June this year showed a profit of £76m on a turnover of £626m. But last year the same turnover produced a profit of £160m - and of the £77m it made this year, £75 was made in the first six months. In other words, profits this half were £2 million, on sales of £277m.

Alan Sugar's statement noted that expenses had increased "substantially as overseas sales and marketing activities have expanded, sometimes in advance of sales" - a reference to some of the advertising campaigns that produced few sales as the PC2000s had been delayed and were not available.

Pundits believe that things will worsen for Amstrad before they get better. ■

• During the Stock Market ups and down on last Monday Alan Sugar was £17 million down by lunchtime. After the upturn later in the day his fortune had recovered to a more manageable £2 million loss.

## PAYING THE PRICE

This has been a year of headaches for Amstrad's accountants:

- Amstrad paid £44m for a stake in US semiconductor manufacturer Micron in an effort to safeguard DRAM supplies. The stake is now worth two-thirds of its original value - a notional loss to Amstrad of nearly £15m if it decided to sell

- The company lost £15m through unavoidable write-offs and bad debts

- Advertising on PC2000s - which were not yet then available - wasted £10m

- The PC2000 range was Amstrad's push into the lucrative top end business market. Problems with the hard disk controllers on the 2286s caused by a faulty component were put right by the company which recalled the lot. To put it right needed £7m

- Despite its efforts to protect chip supplies, the DRAM

- shortage delayed manufacture of many PCs and cost Amstrad £6m

- The PC200 was Amstrad's attempt last Christmas to sell a downmarket PC clone. The machine bombed, partly due to being hopelessly under-specified for the price, but it wasn't helped by a distribution fiasco which led to it being on sale without monitors, manuals or software. It's anyone's guess as to how much this has cost the company

## THE EXPRESS PROGNOSIS

What you can expect for Amstrad's range of machines this Christmas

**PC2000s:** Price-cutting, but most probably disguised in the form of bundles, on the way  
**PC200:** Disappeared since last Christmas's disastrous launch. Possibly coming out before long as an 'MS-DOS PCW', a cheap word processing bundle with printer and software.

**PC1512/1640:** These low end PCs look due for a phase-out; watch for special deals  
**CPC:** Selling well. Still a good machine. Expect no special deals or price cuts.

**PCW:** Still selling very well - recent ad campaign by Amstrad should add significantly to sales. Expect no price cuts or special deals.

## Sugar denies Amstrad sale

Following Amstrad's poor performance and its current low standing in the City, the company's boss and founder Alan Sugar was earlier this week forced to deny the all but unimaginable - a sell off of some of his firm.

Various reports at the weekend suggested that Sugar is looking for a partner to help pull the company through a particularly sticky patch. Analysts were all looking toward electronics giant GEC which has enjoyed a good relationship with Amstrad in the past.

However, Sugar said that City watchers had got it all wrong. "We have absolutely no plans to link up with anybody - we're determined to go it alone," he said. He claimed that analysts had misunderstood him during a meeting earlier last week. At the time Sugar had said he would be subcontracting some of his manufacturing to GEC.

"Analysts obviously put their fabrication hats on immediately after my meeting with them last Tuesday. They've dreamed up the whole thing themselves," commented Sugar.

"Of course if IBM offered us £5 a share we'd have to consider it. But the likelihood of that is rather slim." On Monday Amstrad shares stood at 48p.■

## See you soon

British Telecom has unveiled a videophone that they hope will be in action by the late 1990s.

The Viewphone can transmit a moving colour picture of the callers from a fixed-focus video camera attached to the phone unit to the other caller's four-inch LCD screen. Both callers must be in a 'reasonably lit' area and be sitting the right distance from the camera.

BT hopes that 85% of the population will be using videophones by the year 2000.

As reported recently in Express, some areas of France around Nice already have videophones.■

# A TALKING MAGAZINE!

**Texas Instruments has spent the last 11 years developing a chip that features in the world's first talking advertisement.**

Readers of the current edition of American journal *Business Week* turn over a page to find the tiny device embedded in a credit card sized plastic

casing. As they do so, the chip begins to speak about itself, unbelievably in a Bugs Bunny accent, and discusses its promise for use in creative advertising.

Unless the page is turned again, the chip will repeat this a further 650 times before its batteries run out.

With its built in speaker, the device costs only £2.50 to produce and is expected to have a big future in advertising posters, greetings cards, leaflets, business cards and record sleeves.

Perhaps its most far reaching implication could be in applications for the blind.■

## Citizen's tiny plans

Yet another pocket PC is to be launched, this time by Citizen.

The machine is being shown to trade customers around Europe and should be generally available early next year. Citizen is hoping to sell the machine at around £699 although the company could sell the tiny PC off to another manufacturer.

The Pocket PC weighs just under a pound and is fully IBM compatible. It is

understood that a special version of spreadsheet Lotus 1-2-3 will be sold with it. It will run smart cards in much the same way as Atari's impressive Portfolio. Curiously, a light pen is also being planned for the machine.

Citizen's offering measures six inches by four inches by three inches making it slightly smaller than the Portfolio. That firm joins Poqet, Zenith, Psion, Compaq and Atari into the pocket PC fray.■

## An Amiga date

This year's Commodore Show will be held at London's Novotel Exhibition Centre, Hammersmith from Friday 17th November to Sunday 19th. Entrance is £5 with a specially reduced 'family' ticket allowing two adults and three children available for £15.■

## New Tetris launched

US software house Spectrum Holobyte has announced *Welltris* - the second game from Soviet author Alexey Pajitnov, creator of the award winning *Tetris*.

Like its predecessor, *Welltris* challenges the player to manipulate falling shapes, consisting of various configurations of squares into solid rows. This time though the pieces fall randomly, one at a time, into a four sided well with grid-like walls and bottom. There are three levels of difficulty, set by the number of squares in a piece - the most challenging has five squared objects and the top falling rate of five.

Pajitnov is a highly respected mathematician in the USSR but the success of *Tetris* has little to do with complex maths. The simplicity of the game caught most magazine reviewers on the hop.

Coming in CGA, EGA or Hercules resolutions on the PC, versions for the Mac and Amiga are also on the cards. Spectrum Holobyte games are distributed here by Mirrorsoft on 01 928 1454.■

## Across the PC Spectrum

Spectrum owners wishing to upgrade to a larger system but wishing to keep hold of their software collection have now had their wishes fulfilled. A Spectrum Emulator for the PC is now under development, allowing most software to be run. The emulator will even come supplied with its own tape leads. For more information contact Jaz Brooks on 061 773 4985.■

## EXPANDING HORIZONS

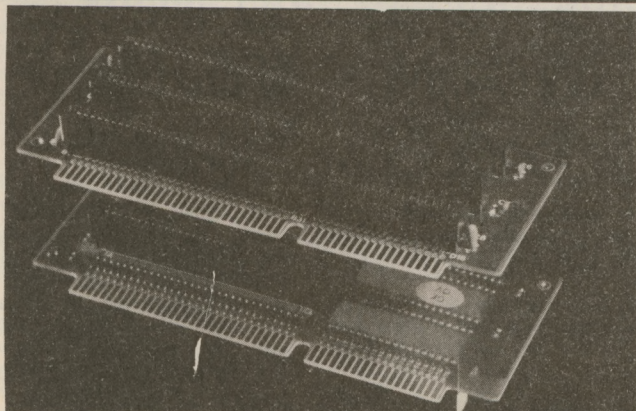

PC AT compatible owners with lack of expansion slot problems will be pleased to learn Chiptech has announced an adapter card that allows up to five cards to be fitted into a single slot. 'T-Board' features three AT style 16-bit slots and two XT style 8-bit slots allowing a mix of disk controllers, graphics and I/O cards all in a unit only three inches high. Chiptech is on 0727 40476

## Globe trotting

PC Globe is an atlas on disk for PCs from Applied Knowledge Limited.

Detailed maps and graphics are available on all the world's countries, and these maps are accompanied by facts and figures on all the world's economies.

The included database has details of population, religion, health statistics, economic and trade data, national leaders, political parties, telephone and radio ham codes, and tourist attractions.

The program also automatically converts currencies and time zones and gives you bearings and distances between spots.

The data and the maps can both be exported to word processing and desktop publishing applications.

PC Globe was previously on release for £199, but has now been reduced to £69.95. Applied Knowledge is on 0422 330573.■

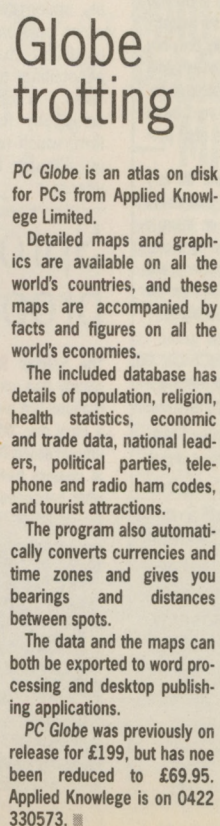
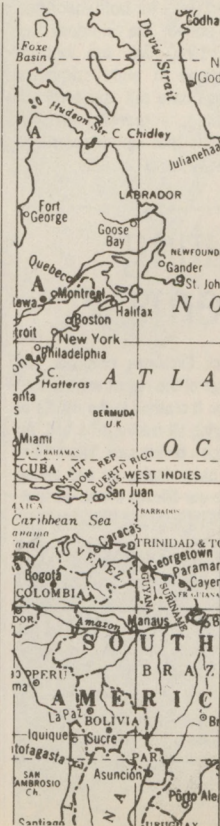

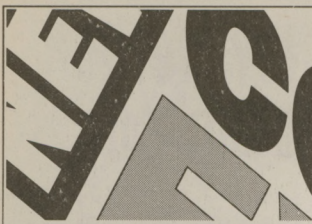

COMMENT

DOWN TIME FOR AMSTRAD

To the ordinary Amstrad owner in the street it looks as though journalists are out to get the company. How can we be so disparaging, people ask us, about a concern that has made £77 million this year? A company which employs hundreds of people and brings in taxes for the country?... etc etc.

First, the profits. Amstrad's figures for the last few years have been so ridiculously large that any downturn is a sign that something is wrong. Profits have halved in the last year and look set to more than halve next time: the £77 million profit for this year conceals a profit of £75 million in the first six months and just £2 million in the last - it doesn't take an accountant to see that something has been going wrong recently. So much for the profits.

Second, the management problems. Amstrad has grown too fast, opening up ten overseas subsidiaries in 18 months. The price of that growth is being paid now: 150 jobs gone in the audio division in Southend. So much for employment.

Third, the unsold stocks. Sitting on shelves somewhere, whether in warehouses or in cargo holds, is something like a year's sales of computers. And computers have a finite shelf life, just like strawberries or fashion clothes. Add this to Amstrad's cash deficit, snatched from the jaws of a huge cash surplus last year, and it spells very little to keep the Inland Revenue happy this financial year. So much for the taxes.

When Amstrad was on its way up in the mid 1980s, there were murmurings in the industry that their heavy-handed, occasionally bully-boy approach to business would lead them into grief one day. 'You've got to be nice to people on the way up,' one said, 'because one day you'll be on your way down. And you're going to need people to turn to.'

Is Amstrad finally on the way down? We very much hope not, because Amstrad's potential to create new markets and cash in on them is good for everyone. But if times are hard over the next couple of years for the company, and if it gets an unsympathetic reception from the rest of the industry, it only has itself to blame.

- EDITOR • Rob Ainsley
- FEATURES EDITOR • Andy Storer
- ART EDITOR • Angela Neal
- PRODUCTION EDITOR • Stuart Anderton
- NEWS EDITOR • Colin Campbell
- STAFF WRITER • Maff Evans
- ART ASSISTANT • Paula Mabe
- ADVERTISEMENT MANAGER • Mark Salmon
- DEPUTY AD MANAGER • Adrian Taylor
- AD EXECUTIVES • Quentin Mowbray, Sarah King, Helen Kirkhope
- AD TYPESSETTING • Terry Turner
- PUBLISHER • Greg Ingham

© Future Publishing Ltd • 4 QUEEN ST, BATH, BA1 1EJ • TEL: 0225 446034 • FAX: 0225 446019  
Subscriptions: The Old Barn, Somerton, Somerset (0458) 74011 • Printed by Redwood Web Offset, Trowbridge, Wilts • Distributed by Comag, West Drayton, Middx

• Neural network research brings micro of the future closer

# CHIP TECHNOLOGY BREAKTHROUGH

**A new 'artificial brain cell' based on a standard unmodified silicon chip has been designed by Britain's first Professor of Neural Networks.**

Professor Igor Aleksander of Imperial College has developed a new type of neuron, called a 'G-ram', or 'generalising random access memory'. This makes standard silicon chips act like neural networks, in contrast to the approach taken by other researchers which require specially modified chips.

The G-ram is almost an ideal neuron, more powerful than other net chips. Pro-

fessor Aleksander believes that the new intelligent learning chip will make its way into home computers within a few years.

Neural networks are the silicon equivalent of linked brain cells, which can 'learn' by experience without having to be programmed or given explicit rules.

For example, a neural network for number recognition is given a few dozen examples of numbers and it works out by association for itself what defines the shape of a 3 or a 5 and so on. From then on it can recognise numbers by their shapes according to what it has learnt.

The more examples it encounters, the better it learns, in a similar way to a human brain.

Existing systems are very simple but there are already PC-based programs which can recognise and verify passport pictures, fingerprints and signatures with 98% accuracy. Speech recognition and artificial vision are potential areas where neural networks can be of great value.

Professor Aleksander was responsible for the first computer capable of recognising patterns, a neural network computer called Wisard, in 1981. ■

## Compaq enters laptop fray

Compaq has entered the rapidly growing notebook computer market with two new 6lb laptops.

The 8086 based LTE 1 Model 1 and 286 based Model 20, priced at £1495 and £1995, both feature 640K RAM and a 640 x 200 backlit LCD screen. Incredibly, optional hard disks for both machines weigh only one pound. The company has predicted that 1990 will see laptops accounting for one in eight computer sales - a figure borne out by a recent survey by Romtec, a market research firm, which reveals that laptop sales are up 70% for the first six months of this year. ■



The 27th Annual Amusement Machine Show, held in Tokyo earlier this month, featured over 350 new video games machines, 95% of them Japanese in origin. But in the absence of any significantly new processor technology, the product on show may as well have represented the state of the art a year ago since street fighting, space shoot-em-ups and driving sims are still the predominant game themes. In the driving stakes, Namco's Eunoo Roadster, based on Winning Runner, Four Trax and Suzuka GP caused a stir, as did Jaleco's Big Run, but the stars were Stun Runner from Atari - a fast action bike sim - and Taito's driving shoot-em-up Special Criminal Investigation. Old favourites drawing new crowds were Irem's upgrade of R-Type II and Capcom's Street Fighter '89 - both featuring enhanced speed and graphics. ■

## Sprouting problems

The Belgian Stock Exchange computer had clearly had enough of the recent market fluctuations last week. It crashed in the middle of a busy day, bringing all trading to a halt. An embarrassed Belgian broker said: 'International dealers have been ringing up and asking what happened to our Mickey Mouse computer system.' ■

## Just a northern show

Sinclair QL fans should note that the third Northern Home Computer Show will be held on 2nd December at the Stokes Hall, Leyland, Lancashire. The organiser, Sector Software, is hoping to attract 30 exhibitors. Sector is on 0772 454328. ■

## Students get cheap loans for Tandy PCs

Tandy Computers has struck a deal with the National Union of Students to supply PCs, laptops and portables at special prices to students.

Any NUS member is now able to borrow any amount from £350 to £1000 via Midland Bank to purchase a Tandy over a three year period for a fixed sum each term at a rate only 1% over base bank rate. As such a £500 loan would cost £16 per term.

The Tandy machines have been added to the list of approved machines for NUS loans. Others include Commodore Amigas and Amstrad PCs. More details from your local Students' Union. ■

## Top quality output from Calamus

ST specialist Signa has announced a Linotype bureau service for its Calamus desk top publishing package.

The service enables ST users to send a Calamus document on disk to the bureau to be printed at a resolution of 2541 dots per inch - this trounces the standard 300 d.p.i. offered by Atari's laser printer. Images can also be processed to the same resolution and turn around is one day - although when the company introduce a facility to send material by modem this should be even quicker. Prices start at £7.50 for a typical A4 page. Signa is on 0252 341600. ■

# Just the ticket

British Rail is testing out a new computer-based reservation and ticket issuing system in a bid to cut down queueing time.

InterCity reckons that passengers will currently tolerate queueing for three minutes, will get angry after five minutes, and will leave if they're still waiting after ten. Now Reading and Carlisle are the first stations to have a special system that answers timetable and routing enquiries, makes reservations and issues tickets all in one operation in seconds, via Opus PCIII terminals.

British Rail aims to have the system implemented everywhere by 1993, in time for the opening of the Channel Tunnel.

• Meanwhile BR has commissioned a research team to start work on an artificial vision system to be used on level crossings. The system will decide whether or not it is safe to lower the barriers when a train is coming. ■

# £1 billion lost through fraud

Accountancy firm Coopers & Lybrand has estimated that companies this year will lose over £1 billion through computer data loss.

While half of this will be accounted for by accidental damage such as fire and flood, this still means £500 million going astray through deliberate acts. About 20 per cent of major companies, according to a recent police report, think that the most prevalent type of fraud is computer-based. Most fraud is not done by 'hackers' but by insiders, police believe. ■

# How I lost £2 billion

A computer error led to a major British bank losing £2 billion in 30 minutes, it has been claimed.

The incident, which happened 'in the last few weeks' according to *Computer Weekly*, cost the bank more than its annual profits. It happened when a software error on a super-fast funds transfer computer caused the money to flood into accounts of companies across Europe.

It is not known how much of the money has been recovered, or which bank suffered the loss. ■

# PROGRAMMERS AREN'T BORING

**An academic study just published after five years research reveals that computer fanatics aren't just a bunch of boring terminal junkies talking in hex and obsessed with hardware.**

Psychologist, Dr. Margaret Shotton's 330 page doctoral research project claims just the opposite - computer dependency is in fact therapeutic by providing an outlet for high levels of intelligence, curiosity and originality.

Although the report does note that some users do regard computers as the ultimate hobby, providing a controllable form of interaction which they are unable to find elsewhere, it concludes that most interviewees had increased their social circles, gained in confidence and improved their job prospects.

However, sociologists among you may not find the results so convincing. The research was based on a sample of only 106 recipients to advertisements placed in newspapers and magazines between 1984 and 85. One could argue that real dependents would be too obsessed to even notice the adverts let alone reply to them. ■

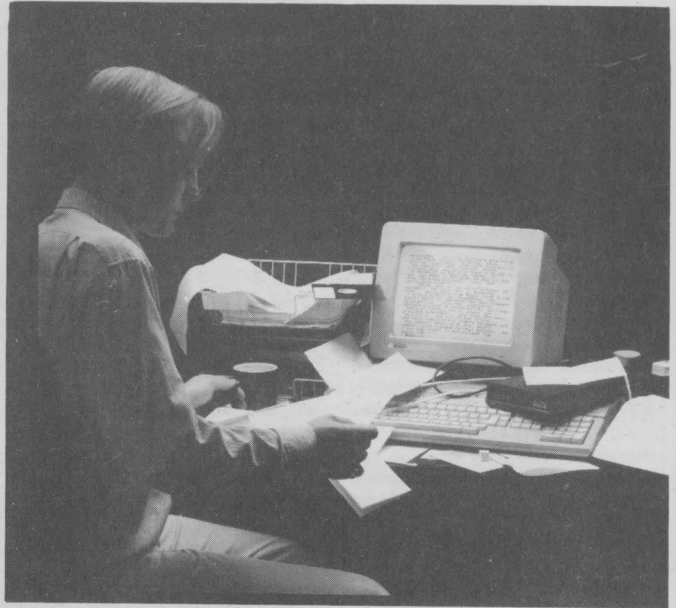

• The popular image of the programmer as a sickly loner isn't true, according to research

• Mini Office on the PCW: the saga continues

## Mini Office Professional - Minus

After criticism over its seven-module program for the PCW, *Mini Office Professional Plus*, publisher Database is to market the package minus the spell checker and thesaurus.

These two modules attracted criticism for being very slow and not working with the word processor. The new five-module package costs £39.95 and includes word processor, database, spreadsheet, graphics and comms packages, plus a manual and quick reference card. Database is on 0625 878888. ■

### SNIPPETS ● SNIPPETS ● SNIPPETS ● SNIPPETS ●

• Seen at a meeting: 'Hacking - Should it be made an offence?'

Opening speaker: Mr Timothy Hackworth, British Computer Society

• Apple will launch a colour version of its entry-level machine - the Macintosh Plus - next April. Rumoured street price in the States is \$1,400.

• A new virus construction set is doing the

rounds. This one's from France and it allows you to produce variants of the notorious ST virus - Signum BPL.

Signum's believed to be half a virus waiting for its other more destructive part.

• A new multi-user adventure game on Micronet, Prestel and Telecom Gold is to be launched in the new year. Called Trash it promises fire-eating cabbages an pink blanchmange rain...

## Japanese get their genes on

Japanese scientists working on artificial intelligence are to harness their 'thinking' computers for mapping human genes.

The fifth generation computers they are building will be able to converse, process visual images and reason

like human brains. The Japanese team, led by Kazuhiro Fuchi in Tokyo, believe that unravelling the mysteries of human genes - the chemical 'code' that determines each individual's physical characteristics such as hair colour, intelligence,

susceptibility to certain diseases and so on - is an ideal application for their creations.

This could lead to a better understanding, and perhaps prevention or even cure, of many diseases and disorders. ■

● Computers open up options

# WORKING AT HOME TAKES OFF

Between them, British Telecom and The Henley Centre for Forecasting estimate the UK has several million people working on computers from home rather than in their company's offices. And the number is increasing rapidly.

With office space becoming more and more scarce and expensive, employers are looking at other ways of cutting costs while maintaining productivity. Teleworking is seen to be a viable solution with a wide variety of employees either hooked directly into office computers or sending material in by E-mail.

At a recent conference organised by ACRE, a rural development charity based in Cirencester, the explosion in teleworking was held up as a possible saviour of the flagging fortunes of rural economies. For with EEC grants as subsidy, five 'telecottages' are soon to be set up as pilot schemes in Staffordshire, Derbyshire,

Wales and the western highlands of Scotland.

A telecottage is a community facility where high-tech gear will be made cheaply available for activities such as word processing, desktop publishing and bookkeeping. Each centre will cost around £10,000 to set up and will provide upto four PCs with hard disks, laser printers, fax and E-Mail facilities.

Distance working is becoming increasingly common in journalism and the publishing industry, where the common availability of modem links into national newspapers and other publications provides the incentive.

This trend in distance working follows the experience of Scandinavia where the 50 telecottages already set up and running have provided an essential service in remote areas as well as well-paid employment for those participating in the schemes. ■

## Who ya gonna call?

Sega owners are to get their hands on the biggest selling computer game of all time - *Ghostbusters*.

Activision's four stage classic has notched up sales of more than two million on home computer formats and is set to score a hit with the Sega console. It costs £27.95 from Virgin/Mastertronic.

The firm has also launched *American Baseball* and *Alex Kidd's High Tech World* at £24.95. ■



## Amstrad Shoot from the Lip special

"We took on far more than we could handle and now we're paying for it"

*Sugar on the too-rapid expansion into ten overseas subsidiaries*

"Amstrad's challenge is to persuade the retailers to take [its computers] off its hands at a price which does not deepen the company's crisis"

*Alan Cane in The Financial Times*

"It was a lousy deal"

*Alan Sugar on the Micron deal that lost Amstrad £15m*

"Some of that [Amstrad's problems] has been unavoidable. But some must have been due to overstretched and over-optimistic management"

*Roger Cowe in The Guardian*

"I'm no longer going to chase profits to keep the

stock market happy"

*Sugar in a meeting with City analysts*

"The short term objective of the company in good shape... may be a bitter pill to swallow for some investors, since this policy may be at the expense of chasing profits"

*Sugar's statement in the year end results*

# WAREHOUSE CLEARANCE



## DESKTOP PC

**ONLY £299.00 + VAT**

The EAZY PC is designed for people who want a powerful, affordable personal computer that is extremely easy to use. Whether you are running a business, doing school or college work, office work at home, or just playing games. The EAZY PC runs all of today's top PC Compatible software. The package consists of:

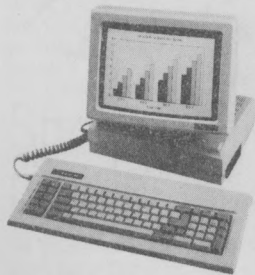

- ★ 84 Key Low-Profile Keyboard. (Audible click on each keypress.)
- ★ Base Unit that measures only 11" x 14"
- ★ Powerful NEC V40 processor (8088-compatible 16 bit micro-processor 7.16 MHz)
- ★ Attached 14" High-Resolution Page white monitor (640 x 400 Chars, 640 x 200 graphics.) with separate brightness/contrast.
- ★ MS-DOS, MS-DOS Manager, & GW Basic Software
- ★ 3 1/2" High capacity disk drive (720k formatted)
- ★ Built-in Parallel Printer Port & Mouse Port (Microsoft compat.)
- ★ Perfect for wordprocessing, accounts, spreadsheets, databases etc.

**ORIGINAL SELLING PRICE £499.00 plus VAT**  
**OUR TOTAL PRICE £354.00 inc Overnight Carrier**

VISA/ACCESS orders welcome. Prices subject to change without notice. All transactions are subject to our standard conditions of sale, available upon request. Personal callers welcome by appointment. All prices include VAT. Cheques/Postal orders with order.

## EPSON LASER

**GQ 3500 ONLY £650.00 + VAT**

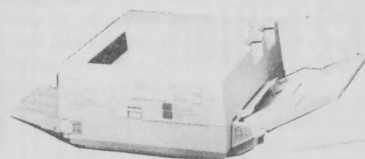

At last, a laser printer that is affordable for the home or small office use. Add to this price the name of EPSON and you can see what tremendous value this offer is.

The EPSON GQ3500 is a quality laser printer with 640k RAM (expandable to 4 megabytes), standard parallel interface, & 7 built-in fonts. Paper delivery can be either face-up or face-down. We have also included in this package, absolutely free of charge, 2 additional Font Cards, and an HP Emulation Card. (Valued at approximately £150.00)

You would normally expect to pay £1100 - £1200 plus VAT for this Laser Printer, but our fully inclusive price of just £759.00 includes VAT & Overnight Carrier.

★ 12 months on-site warranty available with this item.

## UK HOME COMPUTERS

82 Churchward Avenue, Swindon, Wilts. SN2 1NH

Telephone: (0793) 695034



# Dowling COMPUTERS

**HEAD OFFICE:**  
Unit 48  
Tyne Road  
Sandy, Beds, SG19 1RB  
Tel: 0767 81750/60  
Fax: 0767 81730



*If you're serious about Computing, FORGET the rest - TRUST the BEST!*

## BEDFORDSHIRE

3 Harpur Centre  
Lower Floor  
Harpur Street  
Bedford  
Tel: 0234 273090

## CAMBRIDGESHIRE

Cromwell Mews  
5 Station Road  
St. Ives  
Cambs  
Tel: 0480 300800

## HERTFORDSHIRE

49 Railway Street  
Warren Place  
Hertford  
Herts  
Tel: 0992 554469

**ALL PRICES INCLUDE VAT, DELIVERY AND A FULL 1 YEAR GUARANTEE!**

### COMPUTERS/SOFTWARE

We fully stock, support and service the following range:

- ★ Atari 520ST/1040/Mega
- ★ Commodore Amiga Range
- ★ Commodore 64
- ★ Sinclair + 2/3
- ★ Atari Portfolio
- ★ Sega Console
- ★ Amstrad PCW Range
- ★ Amstrad PC 1512/1640/2086
- ★ Commodore PC1/10/20/40

### ACCESSORIES/DISKS

10 x 3 1/2" DS/DD disks  
in a solid plastic box .....£9.99  
10 x 5 1/4" DS/DD disks  
in a solid plastic box .....£7.99  
High Quality Mouse Mat .....£3.99  
ST/Amiga Dust Cover .....£3.99  
3 1/2" Disk Cleaning Kit.....£3.99  
3 1/2" 50 Cap. Lockable  
Box .....£6.99  
3 1/2" 100 Cap. Lockable  
Box .....£9.99

**For the most comprehensive range available - call into your local Dowling store -NOW!**

# ATARI 520ST-FM

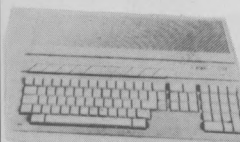

### DOWLING SUPER PACK 1

- ★ 520STFM Computer
- ★ Integral Drive
- ★ Quality Mouse Controller
- ★ Quality Mouse Mat
- ★ Dust Cover
- ★ Disk Drive Cleaner
- ★ Mystery Game

**£249.95**

### DOWLING SUPER PACK 2

As above with £450 Super Software Pack!

**£349.95**

## THE NEW INCREDIBLE AMIGA A500 BATMAN PACK ONLY £399.99

And for a limited period only DOWLING are giving away the 10 Star Games Pack Comprising:

Amegas .....£14.95  
Insanity Fight .....£24.95  
Art of Chess .....£24.95  
Mercenary Comp .....£19.95  
Buggy Boy .....£24.95  
Terrorpods .....£24.95  
Thundercats .....£24.95  
Kari Warriors .....£24.95  
Wizball .....£24.95  
Barbarian Ultimate Warrior .....£19.95



ABSOLUTELY FREE....Value £229.50

### PROFESSIONAL REPAIRS

All repairs undertaken are given the following service:

- ★ Full 6 Month Guarantee
- ★ Full soak test after repair
- ★ Fully cleaned inside and out and returned like new
- ★ Repaired and returned within 7 days of receipt

So Forget the cowboys, call in to your local **DOWLING STORE** now or ring **Head Office** for details of how to post your repair to us.

*Are you a privileged Dowling Gold Card Holder? IF NOT, WHY NOT?*

*Dowling COMPUTERS Privileged Customer Card N° 56789*

### Benefits Include:

- ★ 10% off all Software
  - ★ 5% off Blank Disks, Boxes etc
  - ★ No Deposit Telephone Ordering Service
  - ★ Members Prize Draw
  - ★ Plus lots lots more
- So Call in to your local DOWLING STORE NOW!**

### Why Dowling Computers?

Here are just a few reasons why customers prefer us:

- ★ First and Foremost, we really CARE about our customers' needs
- ★ ALL OUR STAFF are trained to give a friendly personal service.
- ★ EMPLOYING ENGINEERS ourselves, we won't send repairs away for weeks on end!
- ★ That's why we at Dowling say "FORGET THE REST - TRUST THE BEST"

### ORDERING MADE EASY



Try to call in to one of our shops for the best possible service and advice



Order by phone by calling our Head Office quoting your Access/Visa Number



Order by Post - make Cheques, Building Society Drafts or Postal Orders payable to Dowling Computers

N.B. Please add £6 for Courier Delivery

## THIS WEEK'S DOWLING OFFER STAR LC10 COLOUR

**PRINTER + ONE YEAR ON SITE MAINTENANCE + FREE PRINTER LEAD**

**ONLY £199.95 INC VAT & DELIVERY**

**REMEMBER - FORGET THE REST, TRUST THE BEST**

Offer valid till 30/10/89 with this voucher only and on a one voucher per person basis



**B**righton's Metropole Hotel is the annual venue for an expo on all things interactive. This year, 60 exhibitors showed their wares - everything from touch screen technology to voice-driven video recorders being perused by over 2000 visitors. All of the 30 main product launches were PC based, all were exclusively geared towards the corporate user. But beneath the business veneer lies a fascinating insight into tomorrow's technology for today's computers.

Although one could easily argue that all personal computers are interactive systems - all elements of their use entirely depend on a two-way communications interface - it's rather labouring a point. The key difference between the box and monitor at home and the Metropole machinery is the inclusion of multi-media mass storage devices. Stand after stand is full of Sony KXCP1 monitors with touch screen membranes that allow 'point and perform' operations on a bewildering variety of laserdisc and CD Video players. Moving video, CD quality audio, 24-bit colour graphics and text can all reside on a single source disk - interleaved across a half a gigabyte of storage space, each independently accessible.

But it's not just down to larger storage space and multi-format sources - Interactive is about multiple choice decisions. You navigate a series of pathways laid down in code which guide you through the subject at hand. I.T. for two is what it's all about - looking, listening and responding to integrated systems which allow you to obtain information, advice and entertainment in your own time, at your own pace. What's more the software required to author these productions seems to be as easy to develop as the resulting screens are to navigate. It's all very much a question of just pointing and clicking - from writing the software to using the system. When integrated interactive home systems finally become par for the course next decade, we'll all conclude that computing was finally a product of WIMPS. ●

# JUST POINT AND

*The Interactive '89 show was devoted to mixing computing, video and audio. Andy Storer spent a day with I.V....*



• Could this be the personal computer of the nineties? - 486 chip, six megs of RAM, built-in videodisc and CD quality sound

## PRODUCTS

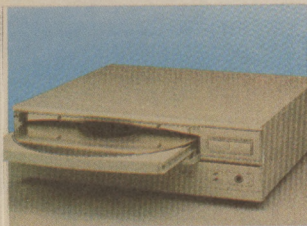

▲ Philips launched its VP310 optical drive. The Omni is a £995 CD drive that will play not only ordinary audio disks, but eight and 12-inch LaserVision discs and 3, 5, 8 and 12 inch CD-Video discs encoded with digital sound. The deck also includes an interface for video overlay and control cards, thus ensuring that you can superimpose computer-generated screens on the picture are to activate portions of the screen by clicking on pixel buttons and icons. The Omni also features full 16-bit sampling capabilities and on-board character generator - making it the ideal multimedia player. Philips is on 01 689 2166

● AMT launched its Speech Development System for PCs - a development tool for incorporating high quality speech into new and existing software. SDS get round the problem of expensive processor-controlled tape-decks by actually emulating the human voice box and vocal tract. The sampling hardware may cost £3000 but the results are impressive. A single sided floppy can hold 24 minutes of recorded speech - a



double-sided, high-density disk over 80 minutes! A simple playback module costs only £100, so it could be ideal for training applications, the blind and schools. AMT is on 01 450 3222

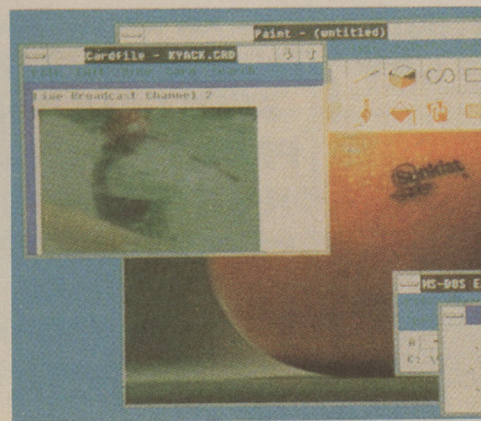

◀ Touchscreens are an important piece of interactive kit as they allow users to easily navigate software without the need for mice or keyboards. Ellinor manufactures a complete range of monitors with touch screen capabilities - it will also convert your own for a price. Touchscreen technology works by placing a transparent membrane over the glass surface of a screen, linked by RS 232 to appropriate software drivers, which converts your finger position to a grid co-ordinate. Response time is so fast that it would be possible for any icon or pull-down menu software to respond to upto 140 touches each second (if you were manic enough). Ellinor is on 0734 311066

◀ New Media Graphics' VideoWindows board for PCs showed just how far computer and video technologies are converging. Scalable, full motion video can be combined with hi-res graphics to provide an ideal multimedia environment for point of purchase, teleconferencing, presentations and desk top video editing. New Media Graphics is on 0425 472753

## PROGRAMS

Interactive systems are all very well but what about the software side of things - how do you go about developing multimedia applications for a personal computer? Here are four programming environments featured at Interactive '89 that provide the essential authoring requirements

▼ Coursebuilder is a graphics based authoring tool for the Mac that allows you to edit and arrange a series of 'contents blocks' depicting interactive routes. Graphics, clip art and scanned images can be imported, animations created and videodisks, VTRs and

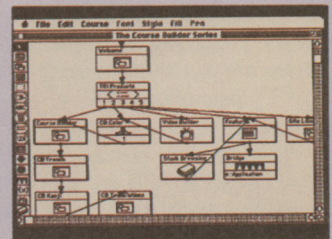

slide projectors controlled. An author simply draws arrows between icons - these arrows represent conditions that lead a user down a choice of 10 paths. The matrix of possibilities can be as big as memory permits. Courseware can be found on path number 0425 472753

# AND PLAY



▲ ▼ The DVA-4000, from VideoLogic on 09277 60511, is a PC card that provides a digital video adapter allowing full manipulation of live or recorded colour video or TV images, including size, position, brightness, saturation, contrast and hue in real time. It's also possible to capture individual or sequences of frames to hard disk for subsequent processing and playback. PCs equipped with video cameras can be networked to provide on-screen teleconferencing between multiple users - each having their own image in their own window.

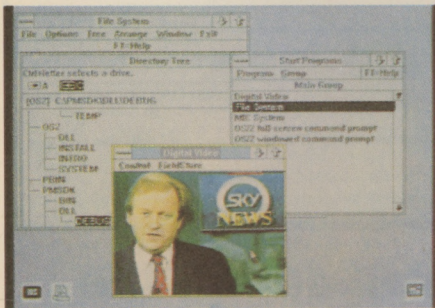

## PERSONAL

Management and behavioural training are the first areas to have been exploited in a big way. Companies like John Cleese's Visual Arts having realised multi-million pound turnovers on the strength of combining humour with learning, are all moving into the interactive field. The corporate check-list covers areas like

- Negotiation
- Recruitment
- Counselling
- Customer care
- Non-verbal communication
- Assertiveness skills
- Delegation

But away from the dry humour of corporate training lie the new boom areas like

- Surrogate travel - just step in your local travel agents and explore that resort
- Interactive cartoons and films - take control of the bridge and take out that enemy
- Mail-order catalogues - roam the hypermarket of your dreams
- Remote galleries - browse New York's finest exhibits without an American in sight!

## PROJECTS

Interactive systems are in use in all areas of industry, leisure education and art. The main applications are for

- Information points
- Management information
- Dealer product training
- Procedural skills
- Interpersonal skills
- Visual catalogues
- Software simulators
- Health and safety
- Museum and gallery exhibits

These may be delivered on the format of

- Interactive video disc
- Interactive audio
- Interactive video tape
- Monitors
- Overhead video projectors
- Vidwalls



## PLANS

The EEC-sponsored Esprit project was initially set up in February with a £2.6m budget to develop the next generation of CD ROM authoring workstations. Currently, CD ROM is by far the cheapest method of storing and distributing large databases of text, graphics and images - one megabyte of data costs only 0.015p to produce, as opposed to £1.05 on floppy and £6.25 on hard disk. But the optical storage arena is split three ways. There's the competing media of CD-I, the 'I' standing for interactive, which adds sound and video and

was originally intended for the home entertainment market, and then there's DVI. Digital Video Interactive relies on a mini-computer to compress each picture down to 5K instead of the 1Mb required on a CD-ROM enabling the CD to be used for up to one hour of moving video.

So, the Esprit project is looking to bridge the three formats to exploit the best features of each. Expert systems are being employed to develop the relevant tool kits and a pan-European voice, data and video comms network

has been set up to enable assorted development teams to work in harmony. The first integrated workstation is hoped to be completed by mid 1990 with the express intention of hiding the complexities of optical disc technology from the user - be they the publisher, creative designer or end-user. The solution is to provide simple visual tools to enable a user to capture and organise all sources of material - the means being supplied by authoring systems which rely on film-style storyboards and scripting.

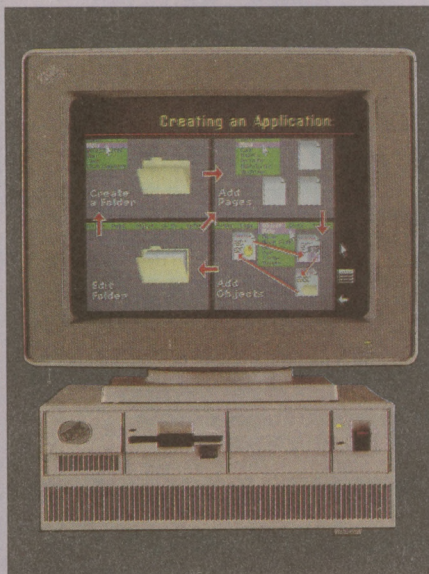

◀ ▼ IBM's Linkway is the company's HyperCard clone for the PC. It's a mouse driven application that allows a user to combine text, graphics and still pictures while accessing music, speech, CD ROM and video disk media through icons. Linkway's still in its infancy though it points the way ahead for IBM's thinking on a new interface for the 90s. Gone are the MS-DOS meanderings; here are associative, button-linked applications you build yourself. The system is completely compatible with existing PC applications - Linkway buttons can be easily configured to take a user straight into other software - on termination the user is returned back to Linkway. More info on 01 747 0747

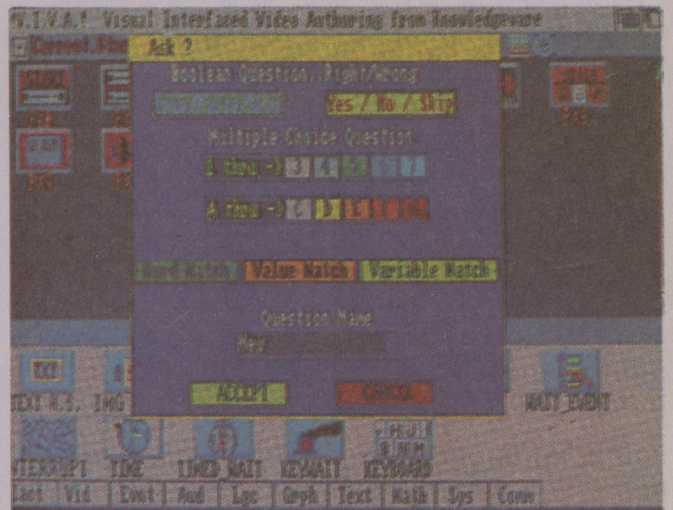
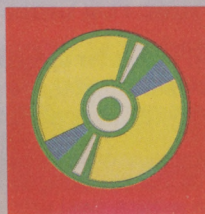

▲ Viva is an interactive software tool that allows a producer to create information environments drawing on the excellent video, sound, colour and graphic capabilities of the Amiga. Fully icon-driven, Viva works on the concept of 'frames' for an interactive storyboard. Along with speech, database and expert system capabilities, the software can also trigger videodisc and CD players, genlocks and digitisers. This remarkable system is also portable - any Viva script written on an Amiga can be ported over and executed on

the Mac and PC versions. It's available from Michtron on 0101 313 334 5700 for between \$199 and \$599 depending on the version.

● PS-Dialog is a language for developing interactive PC applications from AIT on 0491 579272. It's used to create EGA or VGA applications handling touch screens, mice, printers and memory cards. Graphics images can be imported and an efficient command list determines screen co-ordinates for text, graphics and touch areas.



**INNOVATIONS SSI-2001**

• PC • £75  
• CompuSoft • 0734 351789

The IBM PC was never really designed as a games computer. Especially lacking are quality sound effects, unlike its 16-bit counterparts the Atari ST and Commodore Amiga, and with software and limited add on packages costing almost twice as much, it has been a hard up hill struggle for the PC in the already overcrowded games machine market. But now American company Innovations

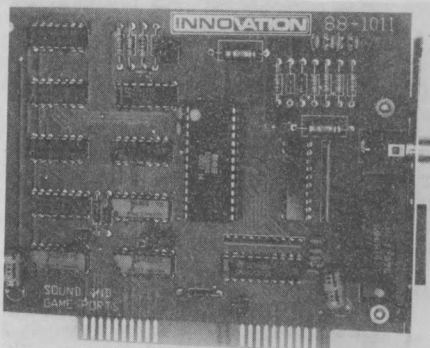

• Innovations's sound board offers realistic games on the PC at a reasonable price

# SOUND SYSTEMS

*Quentin Mobray tries out a PC board which adds sound and joysticks at a reasonable price*

has produced a range of add ons at competitive prices to help overcome this, one of these being the SSI-2001 sound board.

One of the problems in the past with add ons for the PC has been trying to get the agreement of software houses to develop software that can run with the package. It appears that this is a problem that the Innovation SSI-2001 has overcome when you look at the vast range of household-name software companies that support this board - for example Microprose with its *F-19 Stealth Fighter*, *Red Storm Rising* and the recently launched *M1 Tank*, Activision's *Enchanted Lands* and *Time Rift* and many other software companies like Microdeal, Software Toolworks, Mindscape and Electronic Arts.

The sound produced is equal to that of the Atari and Amiga as it utilises the Commodore 6582 SID integrated circuit. This well-established chip enables the generation of three simultaneous

voices of music or sound effects, giving a vast scope for real-life sound from music to speech synthesis.

The SSI-2001 is a half size card that is easily fitted into any PC expansion slot. One of the nice things about the board is that it also holds a game port controller capable of supporting two joysticks (with a Y cable) The game port also has three adjustable levels of sensitivity.

If you are looking to add sound to your PC at an economical price then this could be the board for you. However the WYSIWYG principle does apply in this instance - for your £75 you get a get mono board with no software and limited instructions. It is worth noting that you do need an external amp and speakers to get any benefit from this rather effective board, unlike its more costly rivals. But with it it is possible for the computer literate to produce voice and music and with the aid of another identical card stereo is possible. ●

**QUARTET**

Atari ST • £49.95  
Microdeal • 0726 68020

Just about anyone with half a brain has released a sampler by now but when you've heard your ST playing Bing Crosby once, you've heard it all. There's certainly no way you could turn a sample of good ole' Bing into a Bon Jovi hit - you need a composing tool to do that and *Quartet's* the job.

You can compose music using sampled instruments but what's really impressive is the way you can have four channels playing simultaneously. When you load *Quartet* you're given a main screen, consisting of an empty stave and a handful of icons. Using these you select which voice should be displayed at any one time. Alongside the voice icons are a series of notes from a hemidemi-semi-quaver to a dotted semibreve. By selecting one of these notes and clicking on the stave, the note will be placed in the score - the left mouse button replaces an existing note (for editing) while the right mouse button inserts a note.

At various points in the stave you can switch instruments so you could, for example, create a backing drum track and work the other three voices over the top of this. There are 11 instruments provided with *Quartet*, although you can import additional sampled instruments so there's no reason why you can't have more than this number. If you really want to make the most of

# SEQUENCE OF DELIGHTS

*Sampling sounds is nothing new but what can you do with them? Mark Higham finds out how Quartet lets you compose four-track ditties using sampled instruments.*

*Quartet* then you can even set it to record MIDI input from a keyboard. The notes will be recorded as you play and you can choose which instruments are to be used in the playback.

When it comes to editing the tracks, you can select to play either one voice at a time - in which case the currently selected voice will be used, or you can play all four voices at once and listen to the complete track. By pressing [F2] during playback you can direct all output to a Replay cartridge if you have one. With an extra program

provided on the *Quartet* disk, you can even include sequences into your own programs.

What's particularly exciting about *Quartet* is that you don't need any musical knowledge to have fun with it. However, if you want to use it seriously then it is capable of the same kind of results as an Amiga. It's not ridiculously complex to use but it is capable of some brilliant results which make it a must for music enthusiasts. As yet, there's no other package available on the ST to touch it. ●

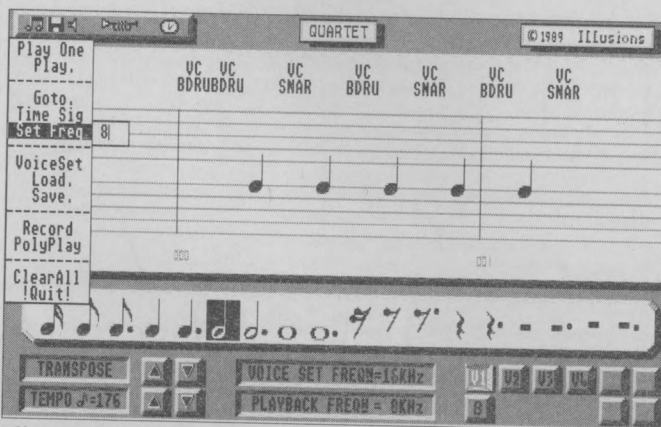

• You can alter the frequency of the sample so that you can store more in memory

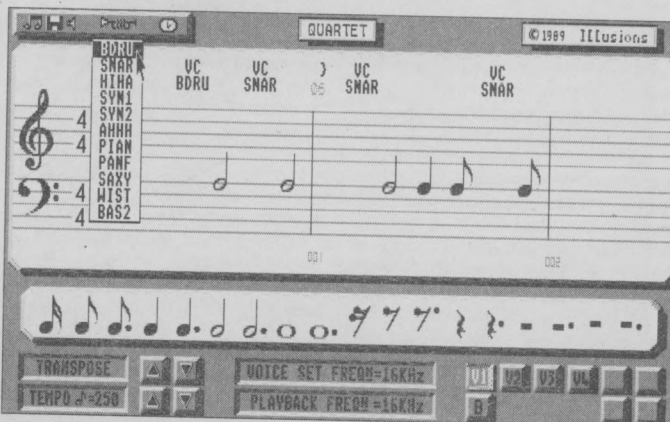

• Quartet lets you use up to 11 different instruments in a composition

# EXPRESS MAIL

## Dear Reader

Another collection of comment, controversy, compliments... and Rob Ainsley's replies. Have you got something to say? Make your voice heard in computing's liveliest letters page! Send your contributions to: **Express Mail, 4 Queen Street, Bath, Avon BA1 1EJ** PS. Sorry, but we just don't have the time to give personal replies, whether you include an sae or not. We're too busy putting Express together!

## DISAPPOINTMENTS IN PROGRAMMING

As a graphic artist working freelance within the software industry, I am writing to offer some advice to those young people who may be considering starting a career in this field: don't!

Every year scores of young programmers, artist and musicians approach development houses and publishers, drawn by the chance to see 'their name in lights', their product on the shelves, their pictures in the magazines. They're fed constant stories of the programmer as a 'folk-hero', and mythical tales of whizz-kids, driving Porsches, waving gold cards and equipped with infinite street-cred pokes. I have actually seen people waving gold cards and driving Porsches, but they weren't the programmers.

Showtime just reinforces these myths, the hype, flash, (and incredibly expensive) stands suggest that the industry's walls are papered with ten pound notes.

Every year scores of young programmers, artists and musicians are ripped off by development houses and publishers offering paltry sums tied to incredibly biased contracts (if you are lucky enough, to get a contract at all). Don't think that it won't happen to you, it will, there is no question about it. Of course the companies doing it to these kids don't mind, because they know that there will be another crop of young talent along soon.

This brings me to my second point, namely that the industry seems to be built largely on exploitation. The attitude seems to prevail that freelancers and small developers are fair game. The sums paid out may seem a lot to a teenager working in his bedroom, but they don't pay a mortgage and they don't clothe children.

The amount of money put into advertising and the aforementioned shows suggests that there is money being made by the producers, but it isn't getting back to the people who make it all happen, the small independent software author at the bottom of the heap.

OK by now you're thinking that this guy is some failure who can't get any jobs because of his appalling work, and he's decided to vent his frustration by screaming at your letters page. Well you're wrong; I'm frustrated alright, but not for those reasons.

I've been working in the industry for getting on for three years, since when I have achieved a consistently high standard in my work producing a good product, on time. This is witnessed by the fact that during all that time I have only been without work for six weeks or so. Most of my work has had above average reviews.

However, at the moment I'm owed money by a lot of people who think the freelancer doesn't matter, having a contract doesn't mean the companies are going to pay up. Look what happened to Software Horizons. Of course you could take them to court (I have done in the past) but that takes time and sours relations with other sources of work if they hear about it. Surely nowhere else would anyone have to wait for anything up to six months to be paid after fulfilling a contract, or not get paid at all. No other industry treats its professional workforce with such contempt.

At the PC show there were probably only 30 or so programmers - the rest of the crowd were middle men making a good living on the backs of the people doing the real work. That situation seems to sum up what this whole business is about.

I'm not dumb enough to believe that writing letters is going to change this situation, but I hope that this will warn off at least some of the potential victims of the corporate sharks.

Sorry not to put name and address but I'm in the middle of projects and if the publishers found out I might be in the mood to stop trading, they would be difficult to get final payments out of and if I kept going, any future contracts might be difficult to get.  
A programmer

• **You didn't mention any specifics in your letter, but if you'd like to get back to us with names and figures, we'd be interested in pursuing this further - all in strictest confidence, of course. Meanwhile, how about an employer's view on this?**

## MONEY MATTERS

After seeing an advert in your magazine I ordered WEC Le Mans for the Amiga from Homesoft UK at the beginning of May and paid by cheque which was

cash. After reading in Express that the software firm had gone bust at the beginning of August, I phoned to change my order and was told to put it in writing - which I did. The next week Homesoft went bust.

Before I knew they had gone bust I tried phoning them but got no reply so I phoned the Trading Standards Office and I have just received a report from them saying there is no chance of retrieving my money and they suggested that I try you to see if I can get compensation from Express. The price of the game was £15.10.

B Page, Bispham, Blackpool

Can you help me? A computer firm called Homesoft (UK) has £22.60 of my money.  
L A Munson, Aylesbury, Bucks

• **I'm afraid not. It seems from the investigations of the Trading Standards Officer that the company has gone bust owing a lot of money. I'm afraid there's no way we can reimburse you either - in fact, we're still waiting for the money for the adverts that Homesoft took out.**

## MATTER OF FRACTAL

A few months ago in a copy of *Scientific American*, there was a series of articles concerning fractals, one in particular containing the Slo Gro Fractal Algorithm, as well as an algorithm to plot the Mandelbrot set. I have been unable to obtain these articles and would be extremely grateful if you could print my address in case anybody out there has these articles.

James Melia, 46, Churncote, Storchley, Telford, Shropshire TF3 1YL

• **We've no idea, not being able to afford Scientific American, but I'm sure someone out there can help you. And if anyone does find out who's behind the Slo Gro Fractal Algorithm, send us their address, and we'll send them a dictionary.**

## PILOT LIGHT

With reference to Stephen Mercer's letter (Express 48) regarding Digital Integration's wonderful F16 Combat Pilot.

I too was wary of the noise emanating from the floppy drive when loading. Then recently, while loading the aforementioned program, the drive after making the usual noise, came to a grinding halt.

I would therefore like to hear DI's reaction to this, as I hold the protection used on their software wholly responsible for the demise of my drive. When you consider that a replacement drive is going to cost me in the region of £200 (due to the fact that only Commodore supply the drive used in the A500) I am sure that you will agree that this was quite an expensive lesson.

I would also warn fellow Amiga users to bear in mind what has happened to my machine before using/ buying the program, while the ridiculously heavy protection exists. I am sure most users would prefer to use the password method, this would also make it possible to install the program on hard disk, as with *Balance of Power 1990!*

Please DI, let's have software that doesn't destroy the machine. Surely simulations are meant to remove the element of danger associated with the real thing.

M Harper, Rotherham

• **It would be interesting to see if you could successfully bring about claims for damages against Digital Integration, if you could prove that their copy protection had in fact killed your drive, not that of course I am suggesting it could have done, and retract this vile slur immediately. Perhaps Digital Integration would like to tell us their side of the story?...**

## DRAGON ON AND ON

I regularly read Express, and on reading your article Second Hand News by Jerry Glenwright, Issue 47, I was dismayed to discover that my faithful Dragon 64 is only worth £35. No Way! It might be five years old, but it has given me no trouble, and does that which I require of it.

It does not need a dedicated data-corder, any reasonable tape recorder will do, it does not need a noisy, dedicated disc drive, it will use any Shugart standard drive. Small memory? How much can you get on four double sided disc drives of any size. Yes I know that the text and graphic screens leave a lot to be desired, but available software overcomes that (how does a 64 column WYSIWYG word processor grab you), and I can use any Centronics printer. Add several active User Groups Shows and you have a tried and trusted computer. £35? More like £200 plus.

## PRIZE LETTER

I was surprised at your offering a prize for the first person to define 'ten situational awareness buzzwords' (Express 49). They are very easy to define.

1) **Apex** - Ill fated successor to the QL. Featured fast loading via an 8-track stereo cassette.

2) **Bugout** - Enabling program allowing 90% of all Amstrad games to be played on an Amstrad Computer.

3) **F-pole** - Broomstick Flight Simulator; of little interest unless you are a witch.

4) **G-loading** - loading of previously turbo

saved discs. The 'g' stands for the resultant gibberish.

5) **Pump** - Publishing Master Plus. Versatile DTP program allowing totally unreadable full page adverts to be produced for Express.

6) **Pre-merge** - DOS command allowing simultaneous loading of word processor and game programs. Allows Batman to be played as a text adventure.

7) **Bogie** - Static pixel on outside on screen. Normally brown and of irregular shape.

8) **R Max** - Plug in module for PC com-

patibles. Reduces RAM to 256K maximum, disables drives and allows PC to be used as a game console.

9) **Generic strobes** - Enables laser printers to achieve equivalent of nine-pin dot matrix draft quality print.

10) **Kinesthetic cueing** - Reissue of classic Hurricane Higgins Snooker game. TRE Ford, Chester

• **Dash it all! OK, you win. Tell us what computer you own, and a crack team of SAS men with portable NCubes will deliver your mystery software prize personally.**

Come on all you Dragon owners and, let's ask for our own column in *Express*. If MSX and others can do it, why can't we?  
F Fisher, Gillingham, Kent

**• If anyone out there does want to give Mr Fisher £200 for his Dragon, I can put you in touch with someone who can sell you a C5, an eight-track cartridge player and a Betamax video recorder for just £1,000 the lot.**

**SHH... YOU KNOW WHO**

In a perfect world we would all own an ST or an Amiga but alas there are those who think that dead-flesh keys are the norm. If I owned an oddity I think that I would keep quiet about it.  
DP Hackett, Penilee, Glasgow

**POINTS TAKEN**

1) Thank you for publishing my letter on the TT in issue 48.

I suppose your enigmatic answer was a sort of vague agreement. I know my letter was too long - they always are - but I think you could have made my point about the TT being ST compatible.

If you want to run ST software, you might as well buy an ST - it will be years before they become unsupported, like the Speccy - and spend the rest on software, an investment in Barlow Clowes, a donation to the water advertisement funding campaign etc.

2) I have no sympathy for WH Alexander (Letters, *Express* 48).

As a Beeb owner, I too have to stand the Hitler-style prejudices of ST/Amiga owners. And if I can take it...

3) I thought it was ironic and sad that you restarted using bleached paper (in issue 48), which you made such a fuss about dropping back in issue 32, when in the same issue you had an article about "Green Computing."

4) Does the Beeb Box also cover the Acorn Electron - strictly speaking it shouldn't, as that is an Acorn machine.

5) Your comment that Tony Benn owns a Beeb (*Express* Listings 48) is I'm afraid incorrect.

According to BBC Acorn User of February this year he owns seven - including a couple of Masters.

J Benson, Bedford

**• 1) Yes, I suppose it was.**

**2) Well, I wouldn't describe ST/Amiga owners as having Hitler-style prejudices. Until they start invading Poland and winning the Nuremberg rallies I'll give them the benefit of the doubt.**

**3) Issue 48 was on the same non-chlorine bleached paper as 47 was and this one is, you wally.**

**4) OK, strictly not, but we don't mind if it does.**

**5) We neither specified the number of Beebs, nor stated that he 'owned' any. If you must make pedantic points, make them about things we said, not things you thought we said!**

**No JOY**

Recently, I bought an Amiga and a few games - I also decided to buy a joystick at the same time.

So I bought a Quickshot II Turbo. As soon as I got home I tried the joystick, but it would not go right, up or down, only left.

It had QC passed stuck on the bottom. So I returned it to the dealer the next day and the nice man gave me a new Quickshot II Turbo.

I went home expecting it to work but it

stuck to the bottom - no up, only left and right.

I then went to Silica Shop - the man with the red beard gave me a new one even though I had forgotten my receipt. It worked perfectly.

I then took the Quickshot II Turbo back to the dealer from whom I got it from. He then gave me another one and satisfied it would work I went home. It didn't. It would go up and down, but not right, only left.

I returned it for the umpteenth time and got another Quickshot II Turbo. I am now the owner of a joystick that will go in all the directions but fires if you try to go left.

All the above mentioned sticks had a sticker saying 'QC passed' stuck on the bottom.

Quality Control passed by whom? Margaret Thatcher?

R Barreto, Brixton, London

**• Hmm. Perhaps the 'QC passed' sticker means:**

**a) The quality control staff were rat-arsed on sherry;**

**b) The company's barrister is on hand to rebut allegations of shoddy workmanship; or**

**c) Quentin Crisp deemed them fit for sale, but with such a limp wrist he couldn't test them properly.**

**LOW DEFINITION**

Some definitions for the 'ten situational awareness buzzwords' in issue 49.

**Apex**

Given on the cheek, usually by one's spouse

**Bugout**

Insecticide or ant-flap

**F-pole**

Expression used by BT engineers when the thing won't stand up

**G-loading**

Comment by American on seeing an Amiga boot up at the third try

**Pump**

Plimsoll or training shoe

**Premerge**

Sex drive (sorry, that's 'prime urge'). It should read 'before joining' (which is almost the same thing)

**Bogie**

Solidified snot

**R-Max**

Mr Bygraves

**Generic strobes**

Elderly flashers

**Kinesthetic cueing**

A relative appreciating your superb snooker playing activities

J Trollope, Ainess, Ross-shire

**• I think you're just nudged out of first place by Mr Ford's definitions - but congrats on a good second.**

**THRASH IT OUT**

The tall and the short of it is that the RISC based Archie doesn't thrash the Amiga, they both are as good as each other with their capabilities canceling one another out.

It would be unfair to say that the Amiga has the edge with software support because no software has yet pushed either machine to anything like its limits (well, game-wise anyway).

H Van Wijk, Brundall, Norwich

**• Well, it'll be interesting to see how the Archimedes market grows over the next year.**

Looking at this week's article on the Archie on page 16, I must admit, I think

**the tide is turning for Acorn's machine software-wise. I'd buy an Arc rather than an Amiga if I had the money, though as I'm not a mad keen games player others may well disagree.**

**RIGHT TO REPLY**

I would just like to take this chance to reply to Peter Calver's letter concerning software piracy in *Express* 47.

A user group and its owner are two separate entities - similar to a limited company which is able to be sued as a 'person' in its own right.

Providing the owner of the user group does not allow the group to be involved in any of their less savoury practices (the previous example I gave was that of using the club to find new people to swap pirated software with) the two may be treated as being entirely separate.

In other words, if the Federation Against Software Theft, FAST, decided to pay the owner a visit, they would only be able to collar the owner - only in his capacity as a private individual - and not the club as it would be guilty of nothing.

He makes the analogy of a landlord allowing drug abuse in his pub because if he doesn't, the customers will go elsewhere.

This has absolutely nothing to do with the point in question, but I will use his analogy to clarify the situation further.

The landlord would be perfectly justified in not allowing drug abuse on his property, regardless of the financial loss he would make when customers left to use other pubs.

This comparison is not valid to the point however. I have already said that the club not be involved in any illegal or immoral activity.

What if the landlord closes the pub for a night, goes into town and attacks an old lady? Would the police turn up, dig out the foundations of the pub and move it brick by brick to a nice cell for the night?

No. The owner, in his capacity as a private individual - not as a landlord - would be in the cell.

Perhaps I did not make myself clear enough, or perhaps my point was just a little too subtle for Mr Calver to understand, but this is the crux of the situation.

Now let me make it absolutely clear: I never said that software piracy was right, nor do I say so now. I do say that it is easily justifiable by some people and that, unfortunately, it is a fact of life.

A user group that does not allow

piracy etc. will not stop pirates all. As I said previously, they will just go out and find another club or another method that allows them to do it.

That's not to say that clubs should allow such behaviour; after all, someone has to be responsible for setting moral standards somewhere.

My final observation is one that I think would help to stop the greater evil of corporate pirates - companies that have a single user licence but that make literally hundreds of copies.

Perhaps a system whereby the software company not only guarantees confidentiality but that also pays some sort of reward (perhaps even a percentage of damages won or enforced licence fees) would perhaps discourage company piracy more than an education campaign.  
P Bocij, Derby

**• Hmm; an interesting suggestion. I'd be curious to see what Microsoft or Ashton-Tate or Lotus think about giving rewards to people who 'shop' pirates. We might see a new breed of bounty hunter emerging, which seeks out and exposes company pirates.**

**Would a Batman or Superman of the 1990s actually spend most of their time chasing the Penguin slyly running off fifty copies of Lotus 1-2-3 when his site licence only extends to five, or Lex Luther and his underground WordStar Duplication Factory in Hong Kong?**

**FINAL WORDS**

Thanks for your piece on viruses (*Express* 49). I have been very impressed by the even handed coverage in your magazine of the virus business, in contrast to the hype of the media.

The article in the Star was so sensational as to be ridiculous. 'Britain on the blink' indeed!

I was sorry to see that the Blind Institute lost data, and (having lost data myself through disk corruption) know to my cost how much time and money it can mean.

But that apart, it is clear from the Friday 13th experience that the worst threat to society comes not from the virus writers, but from the tabloid writers!  
David Alston, Southampton

**• Well, maybe. It's quite legitimate for a paper to make a story - after all, we gave just as much coverage to the virus business. But scaremongering and setting off shrill false alarms is not justifiable. Panic stations writing like this does no-one any good.**

**...SNIPPETS...**

**A JOKE, I THINK**

**Q.** How many ST owners does it take to change a light bulb?

**A.** 15 - 1 to change it, and 14 to carry out the research... (Yes I do own an Amiga)  
*Ian Foster, Huddersfield, Yorkshire*

**Q.** How many solicitors does it take to change a light bulb?

**A.** If you're asking for

my professional advice it'll cost you £50 an hour.

**WHOLE NUMBERS**

As a robot, I find your human race amusing. Douglas Adams claims the answer to life is 42. Any robot knows it is in fact 41.927...  
*Daneel Olivaw*

**• No, it must be an integer. Like food, good numbers should be natural and whole. ('Robot'**

my walking frame. We know it's you, Steve.)

**FUNNY YOU SHOULD SAY THAT**

When are you going to have another 'New Computer Excess' joke supplement? The last one was hilarious...  
*Roger Batty, Oxford*

**• Amazing you should say that. It's going in next week, as part of our one-year celebrations.**

**Q. WHAT IS A COMPUTER PROGRAM?**

**A.** Basically, a sequence of instructions, just like a recipe or piano roll. If you think of those old pianolas as the musical equivalent of a computer, the piano roll is the equivalent of a program. The effect is to play a tune, but the instructions themselves are just notches on paper. Similarly, the program itself just consists of a sequence of blips representing 1s and 0s.

**Q. HOW DO YOU GET THE COMPUTER TO DO WHAT YOU WANT?**

**A.** Suppose you want the computer to print 'Hello' on the screen. To the computer, the instruction that makes it do this might be a sequence of numbers - 45, 65, 23 and so on. This is machine code. Obviously this would be tedious to do all the time, so there have evolved various computer 'languages'. In one language, the command to print the word 'Hello' on screen might be PRINT "Hello", and in another, PRINTF ("Hello"/n). The language then takes care of the 'translation' into numbers for you.

**Q. HOW DO YOU WRITE A PROGRAM?**

**A.** By preparing a list of your commands as a normal text file in a word processor or text editor. A simple program to calculate VAT on an amount you type in might be in BASIC

```
10 INPUT amount
20 VAT=amount*0.15
30 PRINT "VAT on this is";VAT
```

The line numbers are there to tell the computer in what order to take the instructions. In many languages there are no line numbers and the sequence is taken in the order it appears in the file.

After you've prepared your program like this, you run it through a compiler (if the language is an interpreted one) or compile it (if the language is a compiled one).

**Q. WHAT ARE 'INTERPRETERS' AND 'COMPILERS' THEN?**

**A.** An interpreted language translates each command as it turns up. A compiler 'translates' the whole program into machine code and then runs it.

**Q. WHY ARE THERE THE TWO SYSTEMS?**

**A.** In an interpreted language, developing a program - ie, writing and testing it bit by bit until it does what it's supposed to - is easier. You can stop the program in mid-stream and type in an extra line or adjust the next one just before it is executed, then carry on, because the interpreter works one instruction at a time. With a compiled language, every little adjustment requires you to re-compile the program before you can run it and see what effect it has. This can be really tedious. On the other hand, compiled programs run a lot faster, so it's better from the user's point of view if commercial software is written in a compiled language.

**Q. WHAT'S ASSEMBLY LANGUAGE?**

**A.** If you like, assembler, or assembly language, is halfway between machine code and a normal language. Printing just a *single character* in assembler might look like this:

```
wrtchar  move    d0,-(sp)
         move    #con,-(sp)
         move    #conout,-(sp)
         trap    #bios
         addq.l  #6,sp
         rts
```

Only really clever people use assembler. The advantage over a normal language is that it can be a lot faster, and you have more control over just what each individual bit of the computer is doing, so some commercial programs (graphics routines and games, for example) are better written in assembler. There's no need for the beginner to worry about it at all.

**Q. WHAT SORTS OF LANGUAGES ARE THERE?**

**A.** The most popular is the interpreted BASIC, or 'Beginners All-purpose Symbolic Instruction Code'. Though designed as a beginners' lan-

# BEGINNERS PROGRAMMING

*Writing your own programs is easier than you think, even if you're a total beginner. Michael Allerby answers your questions...*



guage, it's evolved so much that it's a perfectly legitimate language now.

Other popular languages are C (a compiler used to write many commercial packages) Pascal (another compiler) and Logo (an interpreter originally written to teach children programming).

**Q. HOW MUCH DOES IT COST?**

**A.** There will probably be a free version of BASIC with your micro, so it's probably the best one to start on. Languages cost anything from £20 to £100. You'll have to get a manual as well; there isn't space here to list any but your local bookshop will be full of them. A good BASIC manual would only cost you a tenner or so.

**Q. WHAT CAN YOU WRITE WITH THEM?**

**A.** Anything that can be done on a micro. Games, accounts routines to run your business, purpose built databases to store and manipulate information about your customers or club members, educational programs - anything, and it doesn't really matter which language you choose.

**Q. CAN YOU SELL PROGRAMS YOU'VE WRITTEN?**

**A.** Yes, and many people do, though you might have problems if you used an interpreter such as

BASIC to write it. To run the program, users will need the same version of BASIC. You can't give them a copy or you'd be breaking the licensing agreement, of course. You're best sticking to versions that come free with the machine. With compiled languages there's no problem; you just sell the compiled .COM or .EXE file or whatever and users run that as per any other program.

You can either sell them yourself, through mail order perhaps, or send them to a software publisher who would market them for you. Probably your best chance of making any money out of a program you've written is if it fits some special professional niche - a utility for accountants that you know doesn't currently exist, perhaps, or that special train spotting program you wrote because you couldn't find what you wanted commercially.

**Q. WHAT'S THE BEST MACHINE TO BUY IF YOU WANT TO PROGRAM?**

**A.** Any really, but there are probably more languages available - especially the sort of languages that you'd use in a commercial programming environment such as COBOL, UNIX and so on - for the PC and perhaps ST than any other machine. ●

Screen Shot From Amiga Version

ACTION & ADVENTURE ALL THE WAY - NILE STYLE

# DAYS OF THE PHARAOH™

THE FATE OF AN ANCIENT CIVILISATION RESTS IN THE FORTUNES OF YOUR FUTURE.

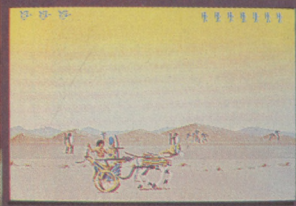
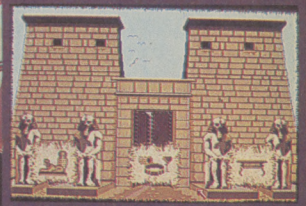

Screen Shots From Amiga Version

"It's deep absorbing fun to play."  
"The graphics are excellent."  
"In an increasingly popular field of interactive strategy, this is a must for fans of this style."  
**COMMODORE USER.**  
"An excellent product... Great in-depth game play."  
"Will keep you enthralled for weeks..."  
"Some very clever and original touches."  
**THE GAMES MACHINE**

"Pharaoh combines effective graphics and superb sound in a very playable game. From the word go, it offers a wide variety of options and playable sub-games. If you fancy something different, take a look."  
**AMIGA ACTION.**  
"The graphics are superb..."  
**ST FORMAT.**

On the night of the Pharaoh's death, Amon-Re, the Sun God, rescues one young prince from the wrath of Seth, God of the Desert and Evil, bringing him to the fellahs amongst whom he is raised. You are this young Egyptian prince, royal blood flows in your veins and ambition and intelligence move you into trade as a merchant - your opportunity to escape the life of a servant. However, as your wealth increases and position in society rises, evil jealousy threatens your life, it is then that princely courage protects you against your enemies. The struggle to regain your birthright is a life's journey of adventure and action.

CBM AMIGA £24.99  
ATARI ST £24.99  
IBM PC £24.99



**Rainbow Arts**

A Chip production for Rainbow Arts

FROM THE CREATORS OF



# UNDERNEATH THE ARCHIES

*Often maligned as the gap in Archimedes marketing, the Archie software industry continues to grow apace. Arch supporter Bertrum Carrot takes stock as the Archimedes comes of age...*

In between the impressive Greek canapés at the original launch of the Archimedes, there was a lot of excited talk about the machine's potential, and precious little in the way of applications written for it. Acorn had handed out development machines to a selected few, including Minerva, Clares and Computer Concepts, but in the main there were spectacular graphics demos and a few hastily ported packages.

This start was to an extent fuelled the press byline 'nice machine, shame there's no software for it'. Software has been slow to come, partly due to Acorn's concentration on the machine for educational use.

More importantly though programs written specifically for the Archie and its multitasking operating system RISCOS, are big, serious applications which need time to get right.

Acorn's 'jousting tournament' stand at last month's PC Show demonstrated admirably that things are at last changing. A wealth of new software was given its first showing and convinced plenty of die-hards there was actually life in the machine. A parallel can be drawn between the growth of the Archimedes market and that of the Amiga, which started life in much the same way and is only now, several years after its launch, being taken up as a mainstream home personal computer. As ever, a price cut from the boys at Cambridge could provide the extra kick needed to boost the Archie into the same position.

## Tasks for multi-taskers

There are now over 550 commercial programs specifically written for the Archimedes. They cover a wide range of applications, with particular emphasis on education. There are also thousands of programs available for the BBC micro and IBM PC, the vast majority of which will run on the Archie. The PC emulator is needed to run PC applications, but the Beeb emulator is supplied with the machine.

Several areas of application are showing particular prominence in Archimedes software, most

• Pro Artisan from Clares is one of the many excellent new graphics packages (see right).

• Silicon Vision's Film-Maker animator in action (below)

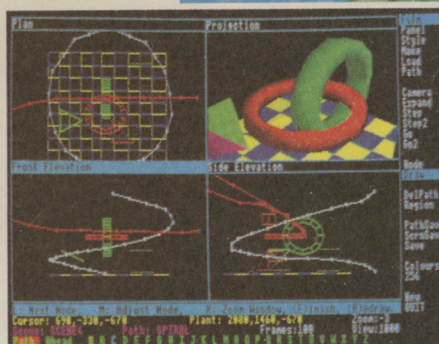

reflecting the machine's strong hardware features. Graphics programs have featured well from early days, and recent releases include *Atelier* from Minerva and *Artisan Professional* and *Artisan 2* from Clares. These products use the full colour range of the machine and include sophisticated effects like colour masking and graphics wrap. Clares also market the *Render Bender* ray-tracing package and there are several video accessories like genlocks which can be slotted into the back of the machine as podules.

New products on the sound front include the *SoundSynth* and *Studio 24 Plus* from Electromusic Research, as well as MIDI podules for control of other instruments. Armadillo Systems also produce a range of music products, including stereo

sampler cards and the modular *HighNote* music software.

Desktop publishing is another area that's flourishing. As well as Acorn's own DTP, there are new products from Computer Concepts (*Impression*), Clares (*Tempest*) and BEEBUG (*BEEBUG DTP*). Of these, *Impression* will probably be the most sophisticated, though its yet to be released in its final version. On a related theme, CAD packages are beginning to appear, with *LinCAD Archimedes* a major contender.

Acorn's set of scalable fonts and system-wide printer drivers mean that any properly written RISCOS program can produce high quality output on the majority of popular printers including dot-matrix and lasers. ●

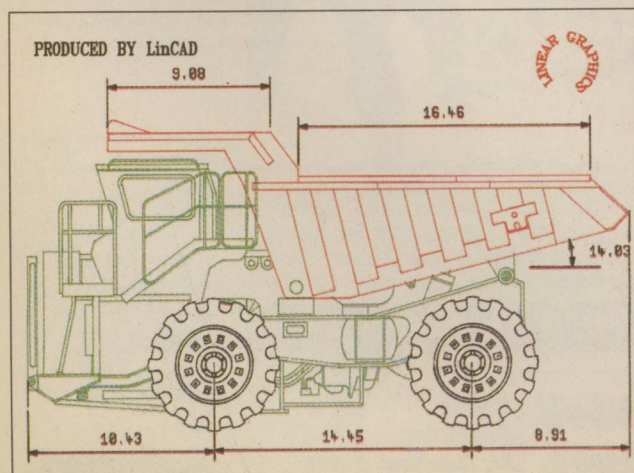

• A big truck from Linear Graphics' LinCAD drawing package

## DISARMING FACTS

- The Archimedes was launched as the world's fastest personal computer, rated at four million instructions per second (MIPS). The new ARM 3 chip, produced in California to Acorn's design, is about three and a half times faster. It can be added to existing Archies, leaving the upgraded machine still comfortably in the lead.
- A lot of early Archimedes software, including the *Paint* program original supplied with the machines by Acorn, was written in BASIC.

- The Archimedes BASIC can, in some instances, run nearly as fast as machine code does on the BBC micro.
- The Archimedes is a full 32-bit machine - the nearest rival in the PC market being the 80386 processor found in top-end IBM compatibles. 80386s are only barely as fast as they use a Complex Instruction Set (CISC), and can cost over six times as much as an A3000.
- All Archimedes micros have 20 screen modes, ranging from two colours at a resolu-

- tion of 640 x 512, to 256 colours at a resolution of 640 x 256. Each pixel can be individually coloured from a palette of 4,096 colours and the maximum screen memory for a high-res screen is 160K. On the 400 series Archie, you can have 256 colours at full resolution, taking 320K!
- The Archimedes sound system has eight voices, each of which can be played in mono or stereo. The A3000 was the first home micro to include stereo speakers inside its case.

# BEST

- Bargains
- Advice
- Prices
- Offers
- Jobs

# SHOPPING EXPRESS

The *weekly* computer market place for people *serious* about buying

## THIS WEEK'S BUYERS' GUIDE

# 60 TOP GAMES

### ● The best in exciting computer entertainment

## JOB SHOPPING?

Check out our recruitment section inside

## ALSO INSIDE

- **Take** advantage of our latest mail order offers.
- **Benefit** from our reliable buyers' guides. No waffle, just facts.
- **Gain** more than £10 off mail order prices by using Express vouchers.
- **Score** on the free reader adverts. Sell your products for *absolutely no charge!*

Save your cash, save your time

## SAVE MONEY

Use these Express Vouchers with the ads inside ▶

Full details overleaf

EXPRESS VOUCHER <b>50p</b>	EXPRESS VOUCHER <b>£1</b>
EXPRESS VOUCHER <b>£3</b>	EXPRESS VOUCHER <b>£6</b>

# £399!

## 10MHz XT

- ★ 640Kb RAM
- ★ 10MHz CPU switchable to 4.77
- ★ 102 Key Keyboard
- ★ 360 Kb 5 1/4" Floppy Drive
- ★ 2 Parallel Ports
- ★ 2 Serial Ports
- ★ Real Time Clock/Calendar
- ★ 5/6 Free Expansion Slots
- ★ Hercules Graphics Card & High Res Mono Monitor
- ★ MS-DOS vers. 3.3 & GW-Basic
- ★ Microsoft Windows
- ★ Full Set of Manuals & Documentation

Rated  
5 stars  
by N.C.E.  
Issue 43

Single Drive Complete System Mono .....£399  
 40Mb 30Ms Complete System MONO .....£599  
 14" EGA Colour Monitor add .....£226  
 720Kb 3 1/2" Floppy Drive add .....£60

### DOLAN ELECTRONICS LTD

DANFFORDDGAR HOUSE,  
 CARMARTHEN, DYFED  
 SA32 7DU



# £749!

## 16MHz AT

- ★ 1Mb RAM
- ★ 16MHz CPU switchable to 6
- ★ 102 Key Keyboard
- ★ 1.2Mb 5 1/4" FLOPPY DRIVE
- ★ 1 Parallel Port
- ★ 2 Serial Ports
- ★ Real Time Clock/Calendar
- ★ 5 Free Expansion Slots
- ★ Mono/CGA/EGA Card Included
- ★ High Res Mono Monitor
- ★ MS-DOS vers. 4.01 & GW-BASIC
- ★ Genuine Microsoft Mouse & Microsoft Window
- ★ Full Set of Manuals & Documentation
- ★ 1 YEAR ON SITE MAINTENANCE (Base Unit)

RATED  
4 STARS  
BY N.C.E.  
ISSUE 43

Single Drive Complete System Mono .....£749  
 45Mb 25Ms Complete System MONO .....£1025  
 14" EGA Colour Monitor add .....£200  
 1.44 Mb 3 1/2" Floppy Drive add .....£85

### SALES: 0267 84538

### FAX: 0267 84617

All Prices ex. VAT & Delivery  
 C.W.O., C.O.D. AVAILABLE  
 (Specification Subject to change)



# EXPRESS VOUCHERS - How the scheme works

● The Express voucher scheme is a unique way of enabling you to save money when you buy goods by mail order.

● It offers you a discount of up to 5% off the prices printed in many advertisements in this magazine - and remember, many of these

prices are already much lower than in the shops.

● The vouchers are not limited to specific items - you can save on any purchase from one of the participating advertisers.

● Most of our advertisers are

taking part in this scheme - just look for this sign.

● Remember. By using this scheme you will almost *always* be able to buy goods cheaper from New Computer Express than anywhere else.

### £1 voucher. Valid for orders above £20

This voucher may be used as £1.00 part payment on any order totalling over £20 from a participating advertiser in New Computer Express. You simply fill in the details below and send it off with your order.

NAME \_\_\_\_\_  
 ADDRESS \_\_\_\_\_  
 TEL. \_\_\_\_\_

ITEM PURCHASED \_\_\_\_\_

One voucher per order only. Voucher and order must reach the advertiser before **9am Monday Nov 6th**

### 50p voucher. Valid for orders over £10

This voucher may be used as 50p part payment on any order totalling over £10 from a participating advertiser in New Computer Express. You simply fill in the details below and send it off with your order.

NAME \_\_\_\_\_  
 ADDRESS \_\_\_\_\_  
 TEL. \_\_\_\_\_

ITEM PURCHASED \_\_\_\_\_

One voucher per order only. Voucher and order must reach the advertiser before **9am Monday Nov 6th**

### £6 voucher. Valid for orders over £120

This voucher may be used as £6.00 part payment on any order totalling over £120 from a participating advertiser in New Computer Express. You simply fill in the details below and send it off with your order.

NAME \_\_\_\_\_  
 ADDRESS \_\_\_\_\_  
 TEL. \_\_\_\_\_

ITEM PURCHASED \_\_\_\_\_

One voucher per order only. Voucher and order must reach advertiser before **9am Monday Nov 6th**

### £3 voucher. Valid for orders over £60

This voucher may be used as £3.00 part payment on any order totalling over £60 from a participating advertiser in New Computer Express. You simply fill in the details below and send it off with your order.

NAME \_\_\_\_\_  
 ADDRESS \_\_\_\_\_  
 TEL. \_\_\_\_\_

ITEM PURCHASED \_\_\_\_\_

One voucher per order only. Voucher and order must reach the advertiser before **9am Monday Nov 6th**

### THE FIVE SIMPLE RULES

1. Express vouchers can be used to obtain discounts on purchases of goods advertised in this issue of *New Computer Express*, provided that they are bought directly from an advertiser taking part in the scheme. The vouchers are valid only for those advertisements which say "We accept Express vouchers".
2. Each voucher entitles you to a discount at the voucher's face value, provided that your overall order level is higher than the figure indicated on the back of the voucher.
3. To use a voucher, simply enclose it with your discounted payment when you order. You may use **only one** voucher in any one order.
4. The order including the voucher must be received by the advertiser before the closing date printed on the voucher.
5. You must fill in the details on the voucher.

# THE SHOPPING EXPRESS BUYER'S GUIDE TO 60 TOP GAMES

After you've done the days database work or finally finished that wordy WP article, and you're looking for some fun then the choice of games for your machine is enormous. Whether it's mindless violence or nail-biting strategy there's a whole world out there just waiting to be booted. This week, *Express* brings you the definitive guide to the top games on your machine to suit all tastes.

## ST GAMES

### ● CARRIER COMMAND

Rainbird 0666 504326  
£24.99

Compelling strategic shoot-'em-up with you in charge of a 200mph aircraft carrier of the future attempting to take control of a vast volcanic archipelago. Fly jets and drive amphibious vehicles simultaneously while colonising the territory and supplies of the enemy

### ● STARGLIDER 2

Rainbird 0666 504326  
£24.99

Solid 3D extravaganza which can be played either as shoot-'em-up or strategy with you looking for the parts to build a neutron bomb as you fly around an alien system encountering all manner of alien life. Features some of the best filled vector animation on any home micro.

### ● KICK OFF

Anco 0322 92513  
£19.99

Excellent soccer-sim with furious, well-rad ball control putting it in a class of its own. Play against a friend or the computer in five levels of competence presented with opportunities to compete in The World Cup and practice the skills needed to beat all comers.

### ● DUNGEON MASTER

Mirrorsoft 01 928 1454  
£24.99

Arguably the best graphic adventure to have appeared on any machine, *Dungeon Master* takes you into a catacombed world of adventure and peril. Fourteen levels of surprise and puzzles with only four companions to help you survive.

### ● XENON 2

Imageworks 01 928 1454  
£24.99

Much hyped but nevertheless superb shoot-'em-up with the accent firmly on attack. Six levels of mutant aliens just dying to get taken out with you at the controls of a modular spacecraft with almost enough weaponry to drown out the sound of the Bomb The Bass soundtrack

### ● FALCON

Mirrorsoft 01 928 1454  
£19.99

Superior F-16 flight sim, now with an additional mission disk, featuring multi-viewpoint combat tasks with smooth graphics and superb control. Perhaps not a stickler for realism but immensely playable and nevertheless convincing

### ● PURPLE SATURN DAY

Infogrammes 01 364 0123  
£19.99

Five in one strategic shoot-'em-up from the same stable as *Captain Blood* and exhibiting all the same French polish in the graphics and audio departments. Each of the five games would be worth almost twenty quid in their own right.

### ● VIRUS

Firebird 0666 504326  
£19.99

First solid 3D game to really harness the power of the 68000 - smooth, fast scrolling shoot-'em-up with brilliant graphics in which you guide a hoverplane over a archipelago world being infested with pestilence by a variety of alien craft.

### ● BALANCE OF POWER

Mindscape 0444 86545  
£24.99

Challenge your ST, or a friend, to global domination in the ultimate ST strategy game. A fascinating insight into geopolitics with you playing either the USA or USSR in a five year span of policy-making as you attempt to defeat your opponent without causing Armageddon.

### ● POPULOUS

Electronic Arts 0753 46465  
£24.99

Unique microcosm of a variety of worlds in which you play God. You create the conditions for your minions to breed and colonise a staggering 999 worlds before your human or computer opponent does the same. Recently complemented by an additional disk of new worlds.

## AMIGA GAMES

### ● F-18 INTERCEPTOR

ELECTRONIC ARTS 0753 46465

£24.95

This multi-view solid 3D combat simulator took Amiga owners by storm when it was first released in June 1988. The frame has still to be surpassed and we bet there are still players out there waiting to complete it from day one. Featuring devious missions, superbly animated graphics and stereo sound, it still remains the best flight sim on ANY machine.

### ● SUPER HANG ON

ELECTRIC DREAMS 0734 31666  
£24.99

With brilliant stereo SFX and frantic racing action, this racing bike sim positively roars through the opposition - two or four wheeled. Impressive scenery on every stage and perfect pacing make for all the ingredients you're ever likely to need - that and excellent control

### ● PURPLE SATURN DAY

INFOGRAMMES  
£19.99

Excellent five-in-one multi-format game that combines shoot-'em-up fanatics with strategic gameplay. Featuring all the hallmarks of French graphics and sound we've come to expect from Infogrammes - the animations are well above average.

### ● DENARIS

RAINBOW ARTS 0260 299401  
£19.99

The perfect horizontal scroller, with furious blastability on every level ensuring major destruction of everything that moves. But beneath the ordinary scenario lies a real deviance in gameplay - some of the most engrossing encounters you're ever likely to experience with super-smart aliens that can only be described as complete b\*st\*\*d\*

### ● KICK OFF

ANCO 0322 92513  
£19.99

Undoubted world cup all-stars in the footie sim stakes, Kick Off's radical ball artists beat the opposition hands down. Playing against the computer or a friend, it's possibly the most addictive game this side of Tetris. K.O.'s a knock out, featuring league matches across five levels of

skill plus a training mode to practice against 8 international sides.

### ● POPULOUS

ELECTRONIC ARTS 0753 46465  
£24.95

Play God for once in your life and take on the Devil in a divinely strategic quest for microcosmic conquest. Build up your people's resources, foster their development and birth rate and colonise! In the meantime throw a few volcanoes, earthquakes and plagues in your opponent's lap as you battle it out across 999 worlds

### ● XENON 2

IMAGE WORKS 01 928 1454  
£24.99

Not bad on the ST but a true tour de force on the Amiga with great Bomb the Bass sampling and overkill weaponry as you work your way through five laser levels on your way to ridiculously resistant end-of-level guardians. Kill and collect endless energy to buy fabulously fatal firepower

### ● BALANCE OF POWER 1990

MINDSCAPE 0444 86545  
£24.99

Brilliant geopolitical strategy where you take the side of a superpower and in five years attempt to change the course of history. Watch with glee as you send division after division of elite Soviet troops into Nicaragua to take out the Contras and hold your breath in terror as you wait for the result of an over-ambitious decision - Armageddon.

### ● VIRUS

Firebird 0666 504326  
£19.99

First solid 3D game to really harness the power of the 68000 - smooth, fast scrolling shoot-'em-up with brilliant graphics in which you guide a hoverplane over a archipelago world being infested with pestilence by a variety of alien craft.

### ● DUNGEON MASTER

Mirrorsoft 01 928 1454  
£24.99

Arguably the best graphic adventure to have appeared on any machine, *Dungeon Master* takes you into a catacombed

**DATAPLEX**

10 Petersfield Avenue, Slough,  
Berkshire SL2 5DN  
Tel: 0753 35557  
All prices excluding  
VAT and delivery



**AMIGA HARDWARE**

Amiga 500 Complete £279  
Amiga 500 + TV modulator £289

**NEW BATMAN PACK £317**

**New from Amiga**

Includes: TV modulator, 3.5" Disk Drive with Amiga DOS Kickstart, Workbench and the very first software also includes Batman The Movie game, F18 Inceptor, Paint 2, New Zealand Story, + Free mouse mat.

**AMIGA ACCESSORIES**

- Amiga A501 RAM pack.....£99
- Amiga joystick.....£8
- TV Modulator.....£19
- Phillips CM8833 colour monitor.....£189
- Amiga To Philips cable.....£8

**AMIGA DRIVE**

- 1 Meg 3.5" external.....£68
- 1 Meg 3.5" internal.....£63
- 1 Meg 5.25" external.....£99

**ATARI COMPUTERS**

- 520 STFM Explorer Pack.....£229
- 520 STFM Power Pack.....£309
- 1040 STFM Professional Pack.....£379
- SM124 mono monitor.....£99
- CS1224 colour monitor.....£229

**ATARI DRIVES**

- 1 Meg 3.5 external.....£80
- 1 Meg 5.25 external.....£99

**STAR PRINTERS**

- Star LC10 mono.....£135
- Star LC10 colour.....£168
- Star 2410.....£199
- Star LC15 9 Pin 136 column.....£264
- Star LC2415 24 Pin.....£328

**EPSON**

- Epson LX400.....£145
- Epson LQ550.....£255

**Many More Epson In Stock. Please call for prices.**

**PANASONIC**

**Unbeatable Prices!**

- Panasonic 1081.....£125
- KXB 1124.....£239
- K1180.....£144

**CITIZEN PRINTERS**

- Citizen 120D.....£110
- Citizen 180E.....£127
- Swift 24.....£255
- Colour upgrade for Swift.....£42

**MANNESMAN TALLY**

- Mannesman MT 81 Dot Matrix.....£110
- Mannesman Sheetfeeder.....£62
- Mannesman Serial Interface.....£49

world of adventure and peril. Fourteen levels of surprise and puzzles with only four companions to help you survive. Unfortunately only available for users with 1meg of RAM

**PC GAMES**

**● BALANCE OF POWER**

Mindscape 0444 86545  
£24.99

Challenge your ST, or a friend, to global domination in the ultimate ST strategy game. A fascinating insight into geopolitics with you playing either the USA or USSR in a five year span of policy-making as you attempt to defeat your opponent without causing Armageddon.

**● F-19 STEALTH FIGHTER**

MICROPROSE 0666 504326  
£39.95

From CGA to VGA you can fly the darkest bird of the air in this excellent flight sim that takes you on missions over Libya and other hot-spots on various combat missions. With multi-views and impressive animation, F-19 stands out as the top playable PC sim.

**● 688 ATTACK SUB**

ELECTRONIC ARTS 0753 46465  
£29.99

A sub sim featuring superb graphics and gameplay as you take on the ruskies in North Pole shenanigans right upto VGA ocean clarity. Since submariners and computer buffs might share a lot in common, the atmosphere should suit all comers down to the ground - or should that be bed

**● WATERLOO**

MIRRORSOFT 01 928 1454  
£ 24.99

Borodina's author turns out another tactical *tour de force* with this adaptation of the Napoleon's last stand - but was it? A terrific and easy to use wargame that could have you rewriting history if only you weren't playing silicon opposition. Alarmingly addictive

**● SENTINEL**

FIREBIRD 0666 504326  
£24.99

A totally original game concept which after ten years of computer gaming is a rare enough event in itself. *Sentinel* pits your wits in thousands of undulated solid 3D chequer board worlds against a random host of energy draining sentinels who you must consume to survive

**● FLIGHT SIMULATOR 3**

MICROSOFT 0734 500741  
£52

The Microsoft classic still retain all the hallmark of a true flight sim, with studios attention paid to every last detail and lots of extra options. In VGA the true realism has to be seen to be believed. For serious airborne buffs only.

**● TETRIS**

MIRRORSOFT 01 928 1454  
£19.95

THE most addictive computer game EVER. Combining fast reactions, quick

thinking and relentless tactical positioning, *Tetris* puts you firmly in the middle of a major dilemma - how can you possibly switch it off? It's all very simple - manoeuvre falling blocks into spaces to complete lines which will disappear and give you more time to position the next randomly irregular falling block. Simple. You bet!

**● INFOCOM ADVENTURES**

INFOCOM 0734 311666  
£24.99 TO £34.99

A series of games which at one time represented a new force in fiction but of late seem to have subsided in an avalanche of arcade action. Nevertheless; Infocom's text adventures remain the most impressive interactive outings, ranging from horror to sci-fi to not so plain old fantasy - well worth checking out - especially *Lurking Horror* and *Wish-bringer*.

**● ULTIMA V**

MICROPROSE 0666 504326  
£29.95

Still the ultimate role playing game, offering 200 different characters to choose from. And you'll probably need them in a vast excursion that'll have you pondering for years as you try to solve this massive adventure featuring thirty separate towns and their populations, eight dungeons and of course, a fatal sprinkling of that ole black magic.

**ARCHIMEDES**

**● ZARCH**

£19.95  
Superior 0532 459453

The original game for the Arc which really showed off its power. You control a flyer with the mouse and must prevent the landscape from being infected by aliens.

**● CONQUEROR**

£19.95  
Superior 0532 459453

A sort of 32-bit *Battlezone*, set in the same stunning 3D landscape as *Zarch*.

**COMMODORE 64.**

The Commodore 64 along with the Spectrum was one of the foremost games machines during the boom years of home computing. Even today, it still enjoys tremendous popularity and new software releases.

**● URIDIUM**

£9.99  
Hewson 0235 832939

One of the best horizontal bi-directionally scrolling shoot-em-ups available for the Commodore 64, the game featured incredibly smooth scrolling and breath-taking bass relief landscaping using black and white and three grey shades. *Uridium* is a yardstick by which others of the genre are measured.

**● IMPOSSIBLE MISSION**

£9.99  
Epyx 0734 313966

Fun and highly addictive strategy/adventure game involving you as a secret agent trying to stop scientists from taking over the world. In order to archive that aim you must cavort hither and thither on the various floors of a skyscraper, searching rooms, and the furniture contains therein to locate clues

# Ladbroke Computing International

"The Country's Leading 16 Bit Specialist"

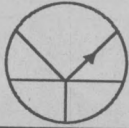

33 Ormskirk Road, Preston, PR1 2QP.  
Open Mon. - Sat. 9:30 am to 5:00 pm  
Dealer enquiries welcome.

## You Can't Afford to Shop Elsewhere All Prices Inc. VAT

This company has given years of full support to computer users from their premises at 33 Ormskirk Road Preston. Now from their Mail Order premises they can offer this second to none "service to users countrywide. All Software/Hardware is in stock and fully tested prior to purchase to ensure that returned goods are now a thing of the past. All hardware is supported by our on site engineers so that quick turn around on all repairs is guaranteed. There are no hidden extras WYSIWYG. ALL PRICES INCLUDE VAT AND DELIVERY on orders over £100 (Mainland UK) next day delivery +£5. All prices are correct at time of going to press and are subject to change without prior notice. Phone for latest prices, information advice (we are always happy to help.)

### Midistudio New Price £49.99

Midistudio is an attractively priced 20 track Midi Sequencing package. It can record up to 682 bars per phrase (pattern) on up to 100 phrases. Any phrase can be placed on any track. Tracks can be soloed and muted and tracks and phrases can be named. Program numbers can be displayed in a variety of ways including 0-127, 1-128, in banks from a11-b88 or a01-b64. The desk features sliders to set relative volumes on each track and you can even do a mix on the fly. Midistudio also has a clock to display the length of the last playback. Midistudio has step time note edit functions including copy, split, merge, append, and transpose, velocity editing (including a humanize function), full controller editing, quantizing and a buffer which will store a copy of a phrase for recall after destructive editing. **Demo disk £3.99**

**Midistudio Master, 30+ new features £149.99**

### Software

At Least 20% discount off all 16 bit games software.

Minimum Discount

E.G.	RRP	Our Price
	£19.99	£15.99
	£24.99	£19.99

Maximum Discount

	£19.99	£6.99
	£24.99	£9.99

**Phone for best prices**  
Free delivery (Mainland UK only) on orders over £40, for orders under £40 add £2.50. Send SAE for catalogue

### A4 Flat bed Scanner £499.99

These A4 Flat bed scanners scan at 200dpi. The mechanism includes a thermal printer which can be used in conjunction with the scanner to photo copy documents or as a stand alone printer. The scanner comes complete with scanning and graphics editing software for the ST or Amiga. Ideal for DTP.

**Limited offer ex-demo £349.99**

### New Low Price Quality Scanning

**Demonstration disk (low res) £3.99 (£2.00 redeemable)**  
The Image Scanner can provide high quality graphics digitising for a tenth of the cost of other digitisers. This simple unit plugs into the cartridge port of the ST and accepts scanned information via optical cables which fix easily to the head of any printer. Scanned images can be saved in raw data, Degas Neo and IMG formats. Best results are achieved with photo copies. The Software supports scanning resolutions of 75,150,216,300,360 and 1000 dots per inch horizontally. An example disk is available which contains a slide show of low resolution images scanned with this product. The cost of this disk is £3.99, £2.00 of which is redeemable on purchase of a scanner.

**Scan at up to 1000 DPI for Only £59.99**

### New Low Price Printers

Star LC 10	£ 169.99 *
Star LC 10 Colour	£ 219.99 *
Star LC 24/10	£ 259.99 *
Epson LQ500	£ 319.99 *
Citizen 120D	£ 139.99 *
SLM 804 Laser	£1099.99 includes 90 days on site warranty

\* All these printers carry a 12 months on site warranty and come complete with cable. On site warranty UK Mainland only.

### Hard drives

Vortex 40MB(ST & Amiga)	£499.99
Megafile 30 (ST)	£474.99
Megafile 60 (ST)	£599.99
Supra 30MB (ST)	£474.99
Third Coast 65 MB (ST)	£599.99
(Amiga)	£659.99

We are offering a range of high quality ST hard drives at ridiculously low prices. All have the following specification. Full metal case same size/colour as Mega ST, 60 watt PSU, room for second mechanism. The low power controller is full SCSI and allows up to 8 drives on one controller. The software includes Autopark, Autoboot from any partition, partition size up to 1 Gigabyte, any number of partitions, 100% AHDI 3.2 compatible driver, write protect any partition.

**40HD 42 Mb formatted, 11Ms average access time, 64K on board cache memory. . . . .£549.99**  
**50HD 48 Mb formatted, 30Ms. . . . .£499.99**  
**85HD 83 Mb formatted, 28Ms. . . . .£699.99**  
**180HD 180 Mb formatted, 20Ms. . . . .£1299.99**

### Disk drives

Cumana slim 1Mg Drive(ST).....	£89.99
Cumana internal 1Mg Drive(ST) (kit or fitted).....	£74.99
Please note ST's case needs cutting for above internal drives.	
Cumana 1Mg slim Drive, disc. switch,through port (Amiga).....	£74.99
A/B boot switch (fitted)(ST).....	£24.99

### Monitors & Peripherals

SM 124 Mono	£ 99.99	Amiga Modulator	£24.99
SC 124 Colour	£269.99	PRO 5000 joystick	£8.99
Phillips 8833 Colour	£249.99	Dcom autofire joystick	£9.99
Phillips 15" FS1 Remote,		Hawk scanner	£1250
Start input, Tv with 40		Traker ball(ST-Amiga)	£24.99
tuner presets.	£234.99	80 / 100 disk box	£9.99
Other Tv's	phone	Dustcovers from	£2.99

All monitors come with scart to ST/Amiga.

### Repair Centre & Upgrades

Our Atari trained engineers can repair all hardware, inc Amigas, in minimum time at competitive prices.

#### UPGRADES EX-STOCK

1 Mg STM (fitted) (ST)	£ 94.99 *	Board + 1 Mg upgrade (fitted) (ST)	£129.99
1 Mg STFM (kit) (ST)	£ 69.99 *	Board + 2.5 Mg upgrade (fitted) (ST)	£299.99
STFM upgrade fitting service	£ 25	Board + 4 Mg upgrade (fitted) (ST)	£499.99
STFM Blitter chip upgrade (kit) (ST)£	39.99 *	STFM Blitter chip upgrade (fitted) (ST)	£ 49.99 *
512 K RAM Extension board (Amiga)£	19.99	RAM Extension populated (Amiga)	£ 89.99
RAM Extension board+clock (Amiga) £	29.99	RAM Extension+clock populated (Amiga)£	99.99

\* Please check machine configuration before ordering. Fitting prices quoted for machines not previously tampered with. Due to the complexity of the installation we must install and upgrade the ST board for you. All upgrades and repairs carry our 3 months parts and labour guarantee.

### New Low Price Quality Disks

All our disks are top quality Sony, Maxcell or Kao products, not cheap imports. All disks carry an unconditional lifetime guarantee. Please add 60p postage and packing for each pack of ten disks.

Quantity	3.5" D/IS	Boxed	5.25" D/IS	Boxed
10	£8.99	£9.99	£4.50	£5.50
100	£79.99	£82.99	£40	£45

**Sony Branded**

10	£10.99
100	£99

**Phone for different capacity disk boxes and disk care kits.**

### \*\* New Low Prices \*\* Computer Systems and Packs \*\* New Low Prices \*\*

<h4>520 STFM Explorer Pack £279.99</h4> <p>Includes Atari 520 STFM with 1/2 Mg Memory, 1 Mg drive and mouse. Includes tutorial disk.</p>	<h4>Amiga A500 Pack New Price £349.99</h4> <p>Includes best selling Amiga A500 computer with 1/2 Mg memory 1 Mg drive, mouse, Tenstar pack, Photon pain and Modulator.</p>	<h4>DTP Packs £phone</h4> <p>This pack consists of Mega 2/ or 4, external 3.5" drive / or 30 Mb hard drive, SLM804 Laser printer, Mono monitor, software, 90 days on site maintenance.</p>
<h4>520STFM Power Pack New Price £349.99</h4> <p>Includes Atari 520 STFM with 1/2 Mg Memory, 1 Mg drive, mouse, joystick and software pack consisting of organiser software First BASIC, First Music and a selection of 20 top quality games.</p>	<h4>Atari Mega ST 1+Mono Mon £599.99</h4> <p>The new Mega ST 1 includes separate keyboard and cpu, Blitter chip, clock, 1 MB RAM, mouse and a business software pack including database, word processor, spreadsheet and BASIC software.</p>	<h4>Atari Portfolio (pocket pc) £249.99</h4> <p>This amazing hand held computer is fully MS-DOS compatible and has built in software including address book, text editor, diary and a Lotus 123 file compatible spreadsheet. 128K free RAM, 256k ROM</p>
<h4>1040 STFM £449.99</h4> <p>Includes Atari 1040 STFM with 1 Mg Memory, 1 Mg drive, mouse and Business pack which consists of Microsoft Write, Super base personal, VIP Professional and Metacomco Basic.</p>	<h4>Atari Mega ST 2+Mono Mon £899.99</h4> <p>The Mega ST 2 includes separate keyboard and cpu, Blitter chip, 2 MB RAM and mouse. The Mega ST 2 also includes a battery backed clock and business software.</p>	<h4>Atari PC 4 (80286) £1499</h4> <p>The PC 4 has an 80286 processor running at 8 or 12 MHz, 1 MB of RAM, 60 MB hard drive, 5 AT and 1 XT expansion slots. For Mono monitor add £100. Phone for others.</p>
<h4>1040STFM Power Pack New Price £459.99</h4> <p>Includes Atari 520 STFM with upgraded 1 Mg Memory, drive and mouse with software pack. This pack is equivalent to a 1040 STFM with Power Pack software.</p>	<h4>Atari Mega ST 4+Mono Mon £1199.99</h4> <p>The Mega ST 4 includes separate keyboard and cpu, Blitter chip, 4 MB RAM and mouse. The Mega ST 4 also includes a battery backed clock and business software.</p>	<h4>Atari PC 5 (80386) £2599</h4> <p>The PC 5 has an 80386 processor running at 16 MHz, math coprocessor socket, 64K cache memory, 2 MB RAM, 60 MB hard disk with high performance controller, 4 AT and 1 XT slots. For Mono monitor add £100.</p>

# Shekhana Computers

- Sony disks 3.5" DSDD box of 10.....£9.99 JVC 5.25" high density DSHD X 10...£10.99
- JVC disks 3.5" DSDD box of 10.....£9.99 Maxell 5.25" high density DSHD X 10...£10.99
- JVC high density 3.5" DSHD X 10...£24.99 Unbranded 5.25" DSDD box of 10.....£4.99
- Sony unbranded bulk 3.5" DSDD X 10...£7.99 Maxell 3" CF2 box of 10.....£24.99
- JVC 5.25" DSDD X box of 10.....£6.99

All disks are genuine and guaranteed by us.

Cheque/P.O payable to SCS (E), 655 Green Lanes, London N8 0QY.  
Access and Visa cards accepted. Ring 01-348 2907, 01-340 8565.  
Fax your order to - 01-889 9413. Please add 50p P+P per box of 10 disks.

## T.C. COMPUTERS

at: 12a BARNARDS WAY, CHARLTON HEIGHTS, WANTAGE, OXON OX12 7EB

- |                                           |                                                                                                                |
|-------------------------------------------|----------------------------------------------------------------------------------------------------------------|
| AMIGA A500 Pack 1.....£349                | COMMODORE PC-10 111 SD CGA Colour...£710                                                                       |
| AMIGA A500 Pack 2.....£379                | COMMODORE PC-10 111 SD EGA Colour...£890                                                                       |
| AMIGA A500 Pack 3.....£439                | COMMODORE PC 40 III SD VEGA Colour...£1600                                                                     |
| AMIGA A500 Pack 4.....£449                | COMMODORE PC 60 III SD CGA Colour...£1459                                                                      |
| AMIGA A500 Pack 5.....£489                | ATARI PC-3 SD Mono.....£610                                                                                    |
| AMIGA A500 Pack 6.....£540                | ATARI PC-3 DD Mono.....£660                                                                                    |
| AMIGA A500 Pack 7.....£599                | ATARI PC-3 DD CGA Colour...£760                                                                                |
| AMIGA A500 Pack 8.....£630                | ATARI PC-3 DD EGA Colour...£899                                                                                |
| AMIGA A500 Pack 9.....£648                | PACKARD BELL PB 500 SD Mono...£635                                                                             |
| AMIGA SYSTEM 500 Pack 1.....£749          | PACKARD BELL PB 500 SD CGA Colour...£740                                                                       |
| COMMODORE C64 Hollywood Pack.....£140     | PACKARD BELL PB 500 SD EGA Colour...£760                                                                       |
| COMMODORE C64 Entertainment Pack...£179   | PACKARD BELL PB 500 DD CGA Colour...£820                                                                       |
| ATARI 520STFM New Power Pack.....£349     | PACKARD BELL PB 500 SD 20Mb HD EGA Colour...£1079                                                              |
| ATARI 1040STFM Ultimate Pack.....£469     | COMMODORE PC's incl. 12 months on site warranty and 102 keyboard on PC 10's/20's                               |
| SINCLAIR +3 incl. Games & Joystick...£179 | PACKARD BELL PC's incl. FREE software and 12 month on-site warranty. ATARI PC's incl. FREE software and mouse. |
| STAR LC-10 Mono.....£155                  |                                                                                                                |
| STAR LC-24 10 Mono.....£259               |                                                                                                                |
| COMMODORE PC-10 111 SD Mono.....£570      |                                                                                                                |

ALL PRICES ARE INCLUSIVE OF VAT  
OXFORDSHIRE'S PREMIER COMMODORE DEALER  
WANTAGE 02357 60177. E.&O.E.

## C & M MICROS

HOME & BUSINESS COMPUTER SUPPLIES

**DON'T BUY DISKS OFFERING ANYTHING LESS!**

FREE lifetime guarantee GOLD CARD. We are so confident with the unbelievable quality of all our disks that we give a lifetime guarantee GOLD CARD with each purchase of disks. Keep the card in a safe place so that lifetime guarantee support is only a phone call away if you should ever need it.

LIFETIME REPLACEMENT GUARANTEE, 100% ERROR FREE. COMPLETE WITH MULTI-COLOUR LABELS, TABS (5 1/4") AND PROTECTIVE SLEEVES.

3 1/2" unbranded disks manufactured by SONY  
5 1/4" unbranded disks manufactured by SENTINEL



Bulk Disks	10	25	50	100	150	200	300	500
3 1/2" DS/DD								
(135)	£7.50	£18	£34	£66	£96	£124	£180	£290
5 1/4" DS/QD								
(96)	£3.50	£8	£15	£28	£41	£52	£76	£125
3" DS								
(Maxell)	£23	£57	£112	£219	£327			Phone for prices

BRANDED DISKS MANUFACTURED BY THE SONY CORPORATION OF JAPAN

Sony Brand	1+	3+	5+	10+
3 1/2" DS/DD (135)	Boxes.....£12.00	£11.50	£11.00	£10.50
5 1/4" DS/QD (96)	of 10.....£12.00	£11.50	£11.00	£10.50

STRONG DISK BOXES. LOCKABLE WITH 2 KEYS.

DIVIDERS & RECESSED HANDLE. Add £1 P&P if not ordered with disks.

3 1/2"	40 Capacity	£4.50	80 Capacity	£6.50
5 1/4"	60 Capacity	£4.50	100 Capacity	£6.50

\* Special Offers \* Latest COLOURS™ disk packs. 10 Coloured 3 1/2" disks (2 of red, orange, yellow, green, fog-white) in a clear fronted flip-top case. Only £9.50

- MX1 - A500 1/2 Meg Memory expansion. 1 year guarantee .....£79.95
- MX2 - Same as MX1 but with battery backed time and date .....£89.95
- Amiga sys programmers guide .....£31.30 Amiga C for beginners .....£17.55
- Atari ST machine language .....£18.00 Atari ST BASIC to C .....£14.20

ALL PRICES INCLUDE VAT. P&P FREE (UK ONLY). Orders below £15 in value carry a handling charge of £1. Please phone or write for a FREE price list.

**C & M MICROS, 25 MIDDLEFIELD ROAD, BESSACARR, DONCASTER, S.YORKS. DN4 7EB**  
CARDNET CREDIT CARD HOTLINE (0302) 539955



as to the whereabouts of the aforementioned scientists.

### ● ELITE

£14.99

Firebird 0666 504326

Probably the most well-known game of all time, Elite is a space trading, strategy game with elements of adventure and shoot-em-up which manages to sustain the interest of players over many hours. Beginning as a novice space trader with a small amount of money, you must claw your way to the top by trading guns, drugs and other contraband commodities with various planets. You can also take to piracy in order to swell the coffers. The epithet classic might have been invented for this game.

### ● SHADOW FIRE

£9.99

Beyond 061 224 5150

Addictive strategy game involving a team of highly trained crack commandoes controlled by you who beam aboard a space ship and attempt to take it over and rid it of an evil infestation. The game is played via a plan view of the space sip and features smooth scrolling and colourful graphics.

### ● BOULDERDASH

£9.99

Statesoft n/a (you may be able to find a second hand copy)

Taking control of a cute little ant labouring under the name Rockford you must rush around inside dangerous caverns collecting diamonds and other goodies while avoiding falling boulders. A simple plot but highly addictive.

### SINCLAIR SPECTRUM

From the very beginning the newly created home computer market latched on to the Sinclair Spectrum as the ultimate games machine and little has changed in the six years since its launch. Today, new games still find their way to the market and it looks like there's several years of life in the old dog yet.

### ● WHEN TIME STOOD STILL

£9.99

Ocean 061 832 6633

Strategy and adventure combined to create a highly addictive, supremely playable game involving the control of a team of four characters. Your task is to wipe out the opposing enemy forces or win them over to your side. There are numerous physical puzzles such as bridges to cross, doors to open etc., an the whole game is made special by the use of a smooth scrolling isometric playfield.

### ● HEAD OVER HEELS

£9.99

Ocean 061 832 6633

You take control of two characters who rejoice under the names Head and Heels. Cavorting around a highly colourful isometric playfield you must solve many puzzles by getting head to sit on top of heels. A novel plot, with lots of tricks and traps make the game very enjoyable.

### ● ELITE

£14.99

Firebird 0666 504326

The all-time trading, adventure and shoot-em-up game which places you in

the role of a novice trader who must traverse the vast reaches of the Universe generating wealth by selling goods to planets in need. You can trade in legal or illegal items such as guns, drugs etc., or you can become a pirate and steal the wealth of other traders. Very addictive, colourful and playable.

### ● MERCENARY

£14.99

Novagen 021 449 9516

Travelling through space you ship develops a fault with the guidance system and you crash land on the nearest planet, Targ. You quickly discover that the planet is inhabited by two warring factions the Palyars and Mechanoids. To escape from Targ you must befriend one race or the other in order to get the equipment necessary to repair you ship. Featuring fast, smooth scrolling 3-D flight simulation, shooting, maiming and killing and lots of underground complexes to explore, the game is deservedly popular.

### ● LORDS OF MIDNIGHT

Strategy and adventure game involving you controlling four characters trying to solve puzzles, collect treasure and raise armies in order to fight the enemy. Lords of Midnight features interesting playfields with the possibility of eight different views and the difficult challenge of keeping track of your characters.

### AMSTRAD CPC464/664/6128

Arriving on the home computer scene a little later than the Commodore 64 and Sinclair Spectrum, the CPC range of machines quickly became popular due to their superior construction, bundled monitor and software availability.

### ● TARGET RENEGADE

£14.99

Ocean 061 832 6633

Highly colourful and addictive game which places you in the roll of a vigilante out to avenge the death of your brother Matt, killed while investigating the nefarious doings of Mr. Big. You must employ everyday items to kill the gang members which you encounter on each level until eventually tracking down Mr. Big.

### ● GAUNTLET

£9.99

US Gold 021 625 3388

Extremely popular arcade game converted to most formats including the CPC range featuring four separate characters (wizard, strong-man etc.,) rushing hither and thither around an enormous smooth-scrolling colourful playfield in an attempt to locate treasure and kill bad guys. Fun to play and addictive.

### ● GUNSHIP

£14.99

Microprose 0666 504326

Renowned for the quality of their flight simulators and the enormous ego of the founder of the company 'Wild' Bill Sealy, Microprose touched base with Gunship, a superb helicopter simulation. Although the plot is a little tired (kill, kill, kill), the flight sequences are expertly programmed, and the helicopter is a treat to fly.

# ATARI ST and AMIGA

## Sixteen Bit Superdeals from the Sixteen Bit Specialists!

**CUSTOMERS PLEASE NOTE!** When comparing prices remember ours include fast delivery by courier.

**NEW !!**

### 520 STFM Power Pack £359.00

*Inc. VAT and Next Day Delivery*

**Power Pack includes:**

- ★ 520 STFM 512K Keyboard with Built-in 1 Megabyte disk drive and TV Modulator
  - ★ Over £550 worth of games software, including OutRun, Gauntlet 2, R-Type, Space Harrier, Super HangOn and 16 more Top Games
  - ★ Organiser Business Software including WORDPROCESSOR, SPREADSHEET and DATABASE.
  - ★ First BASIC and First Music Utility Software
  - ★ FREE JOYSTICK AND FREE MOUSE MAT WORTH £4.95
  - ★ All leads, manuals PLUS MOUSE and free mains plug!
- REMEMBER!** Many ST's do not come with BASIC - ours come with ST BASIC REV D by Metacomco.

### 520STFM Explorer Pack £279.00

- ★ Explorer Pack Includes 520STFM 512K Keyboard with built-in 1 Megabyte Disk Drive and TV Modulator
- ★ 1 FREE Game, ST Tutorial and METACOMCO Basic worth £25.00
- ★ All Leads, Manuals PLUS MOUSE and FREE Mains Plug! ★ Free mouse mat worth £4.95

### 1040STFM Super Pack £439.00

- ★ Includes 1 megabyte keyboard PLUS £450 worth of software. Comprising 21 games and Organiser Business Software. Also includes Metacomco BASIC, Mouse Pad, all Leads, Manuals and Mouse.

### 1040STFM Business Pack £439.00

**Business Pack includes:**

- ★ Atari 1040STFM Keyboard with 1 meg memory and 1 meg built-in disk drive plus TV modulator.
- ★ £385 worth of Business Software including MICROSOFT WRITE word processor (£150), SUPERBASE PERSONAL Database (£60) and VIP PROFESSIONAL Lotus 123 Spreadsheet clone (£150). Metacomco Basic (£25.00)
- ★ All leads, manuals and mouse.

### MEGA 1 BUSINESS PACK £529.00

**Features:**

- ★ Separate Keyboard and System Unit
  - ★ All the Software included with 1040 STFM Business Pack.
  - ★ Blitter chip installed for faster graphics
- Inc SM124 Mono Monitor..... £628.00*

### ACCESSORIES

Quickshot II Turbo Joystick.....£9.95	Branded Memorex 3.5" DS DD Disks
Competition Pro 5000 Joystick ....£13.95	Box of 10.....£13.95
Competition Pro with Autofire .....£14.95	Memorex Disk Box
Konix Speedking Joystick .....£11.95	For 40 3.5" Disks .....£8.95
Red Mouse Mat with Amiga logo ...£5.95	Amiga 1/2 Meg Expansion .....£119.95
Plain blue Mouse Mat .....£4.95	Control Centre Atari or Amiga.....£39.95
Contriver Amiga and ST Mouse with FREE Holder and Mouse Pad £20.95	

### PRINTERS

Star LC24-10 24 pin incl. lead ST/Amiga .....	£259.00
Star LC10 including interface lead for ST/Amiga.....	£169.00
Star LC10 colour including interface lead for ST/Amiga .....	£219.00
Citizen 120D including interface lead for ST/Amiga .....	£159.00
<b>SEIKOSHA 80 COLUMN PRINTERS - AMAZING PRICES</b>	
Seikosha 9 pin NLQ including interface lead for ST/Amiga .....	£139.00
Seikosha 24 pin LQ including interface lead for ST/Amiga .....	£239.00

### Amiga A500 BAT Games Pack £399.00

*Inc VAT and Next Day Delivery*



**BAT Games Pack includes:**

- ★ Amiga A500 512K Keyboard with Built-in 1 Megabyte disk drive.
- ★ Free TV modulator worth £24.99 allowing you to use the Amiga with a normal TV.
- ★ DELUXE PAINT II and PHOTON PAINT Graphic Packages WORTH over £100!
- ★ FREE, only-just-released BATMAN - THE MOVIE games software.
- ★ NEW ZEALAND STORY arcade games software.
- ★ F16 - INTERCEPTOR - amazing 3D flight simulator software.
- ★ A further £230 worth of Games Software, including BUGGY BOY, MERCENARY, BARBARIAN, WIZBALL & six more games.
- ★ FREE MOUSE MAT worth £4.95
- ★ Amiga BASIC, Amiga EXTRAS 1.3, Workbench 1.3 PLUS the Amiga Step by Step Tutorial.
- ★ All leads, manuals PLUS MOUSE and mains plug!

### Amiga A500 Business & Games Pack £479.00



- ★ Includes Amiga A500 and TV modulator PLUS BATMAN: THE MOVIE, F18 INTERCEPTOR, NEW ZEALAND STORY and in addition a comprehensive suite of business programs including: KIND WORDS II, Word Processor (featuring Spellchecker and Thesaurus), HOME ACCOUNTS by Digita International and SUPERBASE PERSONAL database software.

### AMIGA 1 MEG BAT GAME PACK £529.00

**1 Meg Bat Games Pack includes:**

- ★ Fitted 1 Megabyte Memory Expansion + Real Time Clock Card
- ★ Everything listed for the A500 Bat Game Pack
- ★ DRAGON'S LAIR 1 MEG MEGAGAME!

### EXTERNAL DISK DRIVES

Atari SF314 1 Megabyte.....	£139.00
Amiga A1010 1 Megabyte .....	£109.00
Cumana 1 Megabyte Atari or Amiga .....	£99.95
NEC 1 Megabyte Atari or Amiga .....	£89.95
Atari Megafile 30 Hard Disk.....	£449.00
New! Commodore A590 20 meg hard disk.....	£369.00
A590 Hard Disk + Memory Upgrade installed.....	Phone

### MONITORS

Commodore Amiga A1084 Stereo colour Monitor inc lead .....	£249.00
Atari SC1224 Colour Monitor inc lead .....	£259.00
Atari SM124 Mono Monitor including lead.....	£104.00
Philips CM8833 stereo colour monitor inc. lead for ST or Amiga.....	£239.00

### CREDIT CARD ORDERLINE ☎ 0908 378008 (Mon - Sat 9am - 6pm)

To order either call the orderline above with your Credit Card details OR make a cheque or P.O. payable to Digicom Computer Services and send it with your order to the address below. Callers are also most welcome at the address below

### DIGICOM

Unit 36, Wharfside, Fenny Stratford, MILTON KEYNES MK2 2AZ  
All prices include VAT and delivery by courier



**MERLIN COMPUTERS**  
OUR PRICES ARE MAGIC

**AMIGA 500 ONLY £379.00**  
**INC FREE TV MODULATOR & SOFTWARE BUNDLE**

ATARI 520 STFM POWER PACK .....£359.99

**TRY THE ST's MIDI POWER**

CASIO MT 240 AN EXCELLENT LOW COST MIDI KEYBOARD £124.99  
OTHER CASIO KEYBOARDS ALSO AVAILABLE

- 1 MEG 3.5" DISK DRIVES ST AND AMIGA .....£85.99
- ATARI STFM 1 MEG INTERNAL DRIVE UPGRADE .....£74.99
- 1 MEG INTERNAL DRIVE FOR AMSTRAD 1512/1640 .....£85.99

The above drive is an easy to fit 2nd drive complete with mounting tray/facia

- STAR LC 10 COLOUR PRINTER.....£210.00
- STAR LC10 MONO PRINTER .....£169.99
- STAR LC10 COLOUR HEAT TRANSFER RIBBONS - IDEAL FOR PRINTING YOUR OWN T-SHIRTS ETC .....£17.99

**BLANK DISKS AT AMAZING LOW PRICES**

- 10 3.5" DS/DD life time guaranteed .....£7.99
- 10 5.25" DS (per 10).....£3.50

Bulk buyers please phone for bulk prices

**WE STOCK MANY ITEMS NOT LISTED HERE PLEASE PHONE FOR ANY ITEMS NOT LISTED**

**PLEASE NOTE ATARI 8-BIT OWNERS WE SUPPORT YOU**

**PLEASE PHONE FOR DETAILS**

**MERLIN COMPUTERS**

154 Uplands Ave., Connah's Quay,  
Deeside, Clwyd. CH5 4LG  
Tel: 0244 821843



**PD & SHAREWARE**  
who do you get yours from?



There are many PD libraries around but do they offer you....

- ★ Huge collection, thousands of programs on over 3000 disks
- ★ Same day service - 1st Class post - GUARANTEED
- ★ Knowledgeable staff on hand (no 'phone after six and ask for fred')
- ★ Three years experience collecting and distributing PD & Shareware to satisfied customers all over the world.
- ★ FREE 30 page catalogue, S.A.E (22p stamp) and state MAKE of computer CLEARLY and we'll rush one to you by return.

**AMIGA**

Currently over 800 disks in our catalogue, including Fred Fish, APDC, AMICUS, PanoramA etc. Our own SOF collection is so good other libraries stock them now and of course we are exclusive distributors of the fabulous UGA disks. All are auto-boot, menu driven and so very easy to use, probably the best collection available! We also run an Amiga Club, ask for details.

**ATARI ST**

We currently stock over 800 disks full of PD/Shareware for these machines, containing every imaginable type of program! Choose from ALL the Public Domain, not just "a selection". If you are new to ST'ing why not join "Clubville", our popular user group, £6.50 gets you newsheets, offers, special prices on goods, 5% Off blanks/PD etc.

**IBM PC**

(and compatibles)

Thousands of the most popular Public domain and Shareware programs in our current catalogue, all available on either 3.5" or 5.25" format, if ordering (opposite) state which. Whatever type of program you may require, we've probably got it.

MEGA PACK - £19:50 (£14:50)

5 PD disks + 5 blank disks

plus a Library case

(Selection of current popular titles),

INTRO DISK - £1:50

(Atari or Amiga only)

VIRUS KILLER DISK - £1:50

(state machine clearly)

(prices in brackets for 5.25" disks, state preference)

24 Hour orderline on

**0705-266509**

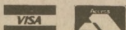

**SOFTVILLE**

Unit 5, Stratfield Park  
Electra Avenue, Waterlooville,  
Hants. PO7 7XN.

**WEC LE MANS**

£14.99  
Ocean 061 832 6633

Thrilling simulation of the Le Mans 24 hour car race. The game places in the seat of a super fast car at the beginning of the race with one objective in mind - to win the Le Mans race. Colourful and fun to play, the game sustains interest with its pretty graphics and thrilling race sequences.

**ELITE**

£14.99  
Firebird 0666 504326

The ultimate, definitive adventure, trading and killing game in which you take the role of a trader roaming the vast spaces of the Universe in order to generate vast amounts of wealth for yourself. You can elect to trade peacefully or rampage around taking out other traders and stealing their goods.

**ATARI 400/800/600XL/800XL /130XE**

Never quite making it in the popularity stakes, the Atari 8-bit machines did sell into many homes and today, this range of computers enjoys an almost fanatical following.

**FLIGHT SIMULATOR II 39**

SubLogic 0101 217 3564166

The best flight simulator available for any computer bar none. This program places you in the seat of a Piper Cherokee Archer single wing light aircraft and gives you the whole of north America to explore. Ground detail such as the Statue of Liberty, Empire State building etc., are within two feet of their real-world positions. The program is so good that SubLogic applied to the FAA (Federal Aviation Authority) to have the program used by real pilots in order to log practise flight time.

**MERCENARY**

£14.99  
Novagen 021 449 9516

3-D flight simulation, trading and killing program. Travelling through space, your ship develops a fault and your crash land on the planet of Targ. To escape, you must befriend one of the two warring factions, the Palyars or Mechanoids. The game features incredibly smooth flight simulation and lots of ground detail.

**RESCUE ON FRACTALUS**

£9.99  
LucasFilm 0101 415 6621966

The planet of Fractalus has been overrun with alien creatures and it is your task to rescue survivors and destroy the alien defences. Rescue on Fractalus was the first game to feature a three dimensional landscape generated by

fractal equations. The game has smooth scrolling flight, and lots of thrills as you work hard to destroy the aliens.

**POLE POSITION**

£9.99  
Atari 0753 33344

The first and still the best. This game places you in the seat of a formula one racing car with the engine revving, waiting for the flag to fall. You have an out-of-the-cockpit view of the racing track and colourful, smooth-scrolling graphics. Lots of fun and highly addictive.

**SOLO FLIGHT**

£14.99  
Microprose 0666 504326

Evergreen flight simulator from Microprose, experts in the field. Featuring colourful, 3-D graphics and a series of flight lessons which appear on-screen and talk you through the process of flying, the game became popular with those who had found other flight simulators rather too difficult to enjoy.

**ACORN BBC B**

The Beeb as it's affectionately known, enjoyed a moderate success amongst computer users during the boom years of home computing. Unfortunately, the machine was a little too expensive for the average home user and consequently, never quite achieved the sales the specifications demanded.

**ELITE**

£14.99  
Firebird 0666 504326

The ultimate trading, adventure and strategy shoot-em-up was initially released on the BBC micro where it enjoyed enormous popularity and made owners of other computers extremely jealous. 3-D space flight simulation, trading and killing make the game incredibly addictive.

**REPTON**

£14.99  
Superior 0532 459453

Colourful and highly popular maze game involving you as a reptile cavorting around enormous caverns collecting various treasures and avoiding falling objects from above. A simple plot but very addictive.

**AMSTRAD PCW**

With its green screen and poor sound capabilities the Amstrad PCW is not the computer which stimulates the creative juices of games programmers. Nevertheless, one or two popular programs have been converted from other formats.

**TOMAHAWK**

£14.99  
Digital Integration 0273 56130

Very popular helicopter, flight simulator from Digital Integration featuring super 3-D out-of-the-cockpit smooth scrolling graphics and lots to see and kill. Loses a little on the green screen but still very playable.

**IN NEXT WEEK'S SHOPPING EXPRESS AMIGA ESSENTIALS**

# Evesham Micros

WE ACCEPT EXPRESS VOUCHERS

**CAMBRIDGE SHOP NOW OPEN!**  
5 Glisson Road, Cambridge  
Tel: (0223) 323898

All prices include VAT and Delivery

## ATARI

All our ST prices include: mouse etc. plus 5 disks of software including 'First Word' wordprocessor, utilities, 'Neochrome' graphics utility, game and demos.

### 520 STFM POWER PACK

Amazing value, all-new special ST package from Atari! Includes 520STFM with 1Mb drive, joystick, mouse, user guide, 5 disks of public domain software, plus an incredible selection of chart-topping software with a total RRP of over £500! Software included is:

- |               |            |             |             |
|---------------|------------|-------------|-------------|
| R-Type        | Pacmania   | Out Run     | Nebulus     |
| Afterburner   | Starglider | Bombuzal    | Starquake   |
| Double Dragon | Super Huey | Xenon       | First Music |
| Super Hangon  | Eliminator | Gauntlet II | First Basic |
| Space Harrier | Predator   | Black Lamp  | Organiser   |
| Overlander    | Bombjack   | Starry      |             |

**All for only £349.00**  
Inc VAT & delivery

### 520 STFM SUPER PACK

Fantastic value! Includes 520 STFM with 1Mb drive, software with a total RRP of over £620, joystick, mouse, User Guide and 5 disks of Public Domain Software. Software includes:

- |                   |             |            |
|-------------------|-------------|------------|
| Marble Madness    | Test Drive  | Chopper X  |
| Beyond Ice Palace | Buggy Boy   | Ranarama   |
| Thundercats       | Quadralen   | Starquake  |
| Summer Olympiad   | Xenon       | Genesis    |
| Arkanoïd II       | Wizball     | Black Lamp |
| Eddie Edwards Ski | Seconds Out | Thrust     |
| Ikari Warriors    | Zynaps      | Organiser  |

**only £319.00**  
Inc VAT & delivery

520 STFM with 1Mb internal drive fitted .....	£269.00
1040 STFM latest model, with built-in TV modulator .....	£399.00
1040 STFM Super Pack: includes 21 software titles and games joystick as supplied with above '520 STFM SUPER PACK' offer .....	£429.00
1040 STFM Hyper Pack, including 'Hyper Paint', 'Hyper Draw', 'First BASIC', 'Organiser' plus £50 Atari Software Offer Voucher .....	£429.00
Mega ST1 with monochrome monitor .....	£599.00
Mega ST2 with monochrome monitor .....	£849.00
SM124 monochrome monitor .....	£119.00 bought with ST
SC1224 colour monitor .....	£279.00
Philips CM8832 14" colour monitor c/w ST cable .....	£219.00
ITT CP3228 16.5" TV/Monitor with remote control & ST cable .....	£229.00

## AMIGA ACCESSORIES

Amiga 500 Low Cost RAM/Clock expansion unit; ultra-neat design .....	£79.00
External 5.25" 40/80 track switchable floppy drive .....	£114.95
Midi Interface by Omega Projects, including 30" serial connector .....	£29.95
Contriver Hi-Res replacement mouse, with mouse mat and pocket .....	£22.95
Vortex 'System 2000' 40Mb hard disk, with interface & software .....	£529.00
ITT CP3228 16.5" TV/Monitor with full remote control and SCART cable .....	£229.00
Philips CM8833 stereo sound version of above, + video/audio inputs, c/w cable ..	£229.00
Amiga 500 dust cover .....	£4.95

**DOUBLE TAKE!**  
PYE 15" FST TV/MONITOR  
(MODEL 2325)

Superb quality, stylish medium resolution FST colour TV/monitor to suit the Amiga or Atari ST. Features teletext, full infra-red remote, SCART connector, Video/Audio inputs and headphone output, 40 tuner presets, ext. aerial connector and a loop aerial. Supplied with cable (please state computer type when ordering).

**ALL THIS FOR JUST £269.00**  
Includes VAT and computer connection lead

## Amiga & ST 3.5" Drives

- ★Very Quiet
- ★Slimline Styling
- ★Fully Compatible
- ★Top quality Teac/Citizen drive mechanism
- ★On/Off switch for Amiga
- ★External plug-in PSU for ST
- ★Throughport for Amiga
- ★1Mb unformatted capacity

**Fully compatible, high quality 3.5" external drives for the ST and Amiga**  
Amiga version only **£74.95**  
Atari ST version only **£79.95**  
Prices include VAT & delivery

## Western Digital Filecards

Upgrading your PC to hard disk? Look no further, we offer the best prices on top quality hardcards. Thorough documentation supplied, low power consumption, with free XTree file management software and Speedread. For Amstrad PC users we supply hardcards tested and formatted, with our simple software installation procedure. The best packages available!

21MB...£225.00    32MB...£239.00    40MB...£289.00

### 3.5" disks

10...£ 9.95 in plastic case £11.95  
25...£22.95 in 40 cap case £29.95  
Fully guaranteed double sided media

### 5.25" disks

25...£9.95 in 50 cap box £18.95  
in 100 cap box £20.95  
Fully guaranteed double sided media

## Amstrad PC1512/1640/2086

We offer a wide choice of Amstrad PCs with many upgrade options. For the hard disk option, check our 'Evesham Upgraded Models'. Only the best will do - so we normally upgrade by means of a Western Digital Filecard, which includes XTree & SpeedRead software; however on single drive 1512/1640 models we can offer internal installations at the same price (leaving more expansion room but no upgrade opportunity for a 2nd floppy drive). Prices in lighter type exclude VAT.  
**Free with 1512 models... Ability and 4 US Gold Games**

	SD	DD	AMS H.D.	SD 21MEG	DD 21MEG	SD 32MEG	DD 32MEG
<b>EVESHAM UPGRADED MODELS</b>							
MONO 1512	384.35 <b>442.00</b>	477.39 <b>549.00</b>	N/A N/A	580.00 <b>667.00</b>	673.04 <b>774.00</b>	592.17 <b>681.00</b>	685.22 <b>788.00</b>
COLOUR 1512	494.78 <b>569.00</b>	555.85 <b>639.00</b>	N/A N/A	690.43 <b>794.00</b>	751.30 <b>864.00</b>	702.61 <b>808.00</b>	763.48 <b>878.00</b>
MONO 1640	474.78 <b>546.00</b>	555.65 <b>639.00</b>	738.26 <b>849.00</b>	670.43 <b>771.00</b>	751.30 <b>864.00</b>	682.61 <b>785.00</b>	763.48 <b>878.00</b>
CGA (COLOUR) 1640	581.74 <b>669.00</b>	651.30 <b>749.00</b>	825.22 <b>949.00</b>	777.39 <b>894.00</b>	846.96 <b>974.00</b>	789.57 <b>908.00</b>	859.13 <b>988.00</b>
EGA (ECD) 1640	677.39 <b>779.00</b>	738.26 <b>849.00</b>	938.26 <b>1079.00</b>	873.04 <b>1004.00</b>	933.91 <b>1074.00</b>	885.22 <b>1018.00</b>	946.09 <b>1088.00</b>
2086 MONO	564.35 <b>649.00</b>	633.91 <b>729.00</b>	813.04 <b>935.00</b>	760.00 <b>874.00</b>	829.57 <b>954.00</b>	772.17 <b>888.00</b>	841.74 <b>968.00</b>
2086 CD	656.52 <b>755.00</b>	726.09 <b>835.00</b>	903.48 <b>1039.00</b>	852.17 <b>980.00</b>	921.74 <b>1060.00</b>	864.35 <b>994.00</b>	933.91 <b>1074.00</b>
2086 12" HRCD	746.98 <b>859.00</b>	813.04 <b>935.00</b>	995.65 <b>1145.00</b>	942.61 <b>1084.00</b>	1008.70 <b>1160.00</b>	954.78 <b>1098.00</b>	1020.87 <b>1174.00</b>
2086 14" HRCD	833.81 <b>959.00</b>	903.48 <b>1039.00</b>	1086.09 <b>1248.00</b>	1029.57 <b>1184.00</b>	1099.13 <b>1264.00</b>	1033.04 <b>1198.00</b>	1111.30 <b>1278.00</b>

**12 MONTHS ON-SITE MAINTENANCE NOW SUPPLIED WITH ALL MODELS OF PC1512, 1640 AND 2086 FREE OF CHARGE!**

## upgrades / accessories

1512 memory upgrade to 640K .....	£39.95	Enhancer 101 replacement keyboard ...	£74.95
Maths Co-processor 8087-2 .....	£129.00	3.5" drive (720K) for SD models .....	£79.95
NEC V30 (8086 replacement) .....	£24.95	PC2000 series compatible	
Cipher CT1525 tape streamer .....	£319.00	5.25" (360K) external drive .....	£84.95
Amstrad Modem Card V21/23 .....	£299.00	Genius GM6000 Mouse package .....	£34.95
Communicate Fax Card SR .....	£199.00	Konix PC Joystick & Controller Card .....	£28.95

## Amstrad PPCs

Low prices on all portable PCs - especially twin drive models prices in brackets are excluding VAT

PPC512S .....	(£373.04) £429.00	PPC640S .....	(£477.39) £549.00
PPC512D .....	(£433.91) £499.00	PPC640D .....	(£546.96) £629.00

Low price External 3.5" floppy drive (720K), suits any Amstrad PC 1512 1640 inc. DD and HD models. uses no expansion slots ..... £99.95

## Central Point Software

For all your PC disk management requirements

**PC Tools Deluxe Ver.5.5...** Other utilities may claim to 'do it all' but only PC Tools Deluxe is the complete disk utility package, providing a fast hard disk backup, the best undelete available, 100% safe formatting of floppy and hard disks, unformat, reliable disk caching, compress facility, in fact everything required to manage & protect your data at a sensible price.....£59.95

## PRINTERS

All prices include VAT, delivery and cable



We use and recommend Star printers since they do offer an unbeatable combination of features, print quality, reliability and value. Get it right with a Star at our special, all in, prices. We can provide on-site maintenance contracts for only £5.75 extra.

Star LC24-10 feature-packed multifont 24 pin printer, amazing low price ...	£239.00
Star LC10 best-selling 144/36cps printer, 4 NLQ fonts, inc.2 extra ribbons free ..	£169.00
Star LC10 7-colour version of above printer, inc.2 extra black ribbons .....	£215.00
Star LC15 wide carriage version of LC10 .....	£329.00
Star LC24-15 wide carriage version of LC24-10 .....	£409.00
Star FR-10 new Professional 9pin 300/76 cps, 31K buffer, 16 NLQ fonts, EE-PROM configuration memory and 12 months on-site maintenance .....	£399.00
Star FR-15 9pin as FR10, wide carriage version .....	£499.00
Star XB24-10 Professional 24pin: 27K buffer, 4 SLQ & 25 LQ fonts with EE-PROM configuration memory and 12 months on-site maintenance .....	£499.00
Star XB24-15 wide carriage version of XB24-10, with 41K buffer .....	£649.00
NEC P2200 budget 24pin, great value 168/56 cps .....	£279.00
Olivetti DM100S Super 9pin 200/30 cps, inc.12 months on-site maintenance! ..	£129.95
Hewlett-Packard 'Deskjet' inkjet printer 240/120 cps .....	£749.00
Amstrad DMP3160/3250DI good value 10" 9pin .....	£169.00
Panasonic KXP1081 reliable budget 10" printer 120/24 cps .....	£169.00
Panasonic KXP1180 super new 9pin with over 3400 typestyles, 11" carriage .....	£199.00
Panasonic KXP1124 good quality 11" multifont 24pin printer .....	£299.00
Epson LX800 popular 10" 180/25 cps .....	£179.00
Epson LQ550 (was LQ500) good 24pin printer 150/50 cps .....	£319.00
Citizen 125D good value 10" 120 cps .....	£139.00
Mannesmann Tally MT-81 130/24 cps .....	£149.00

## HOW TO ORDER

All prices VAT/delivery inclusive  
Express courier delivery £5.00 extra  
Send cheque, P.O. or ACCESS/VISA details  
Phone with ACCESS/VISA details  
Govt., educ. & PLC official orders welcome  
All goods subject to availability E.&O.E.  
Open to callers 6 days, 9.30-5.30  
Fax: 0386 765354

## Evesham Micros Ltd

63 Bridge Street  
Evesham  
Worcs WR11 4SF  
Tel: 0386 765500

Also at: 1762 Pershore Rd., Cotteridge, Birmingham, B30 3BH Tel: 021 458 4564

# SHOPPING EXPRESS READER ADS

**There are great bargains to be had in our reader ads section, but remember to check before you buy -Express cannot be held responsible for the quality of the goods on offer!**

## ● PERSONAL

**WANTED** Amiga A500 Plus software and books local area preferred up to £300 paid ring 091 5373260 (Wear-side).

**ST** user wants contacts from all over the World. Write to Steven, 13 Meldone Sheep House Way, New Malden Surrey, KT3 5PW. England.

**C64** Penpals wanted by female user (I'm 19). I'd also like to buy ADV's or R.P.gs good prices for originals. Write to: Steph, 56, Laurel Park, Harrow Weald, Middx. HA3 6AU.

## ● ANNOUNCEMENTS

**ELECTRON/BBC** video Titler. No extra hardware needed. Send £12 to Vijay, 146 Park Street South, W'ton, West Mids, WV2 3JF or phone 0902-337268 after 5pm. Weekends only. (original).

## ● FOR SALE

**ICL-PC** 10Mb hard disk. Microline 83A matrix printer, 6404 colour VDU. 3/4 Meg RAM, CCPM-86 supports, four VDUs each with 4-way multi-tasking, 1 Meg floppy. Buyer collects £720. Phone Mark on 041 959 6732.

**ATARI** 800, 1050 and 810 disk drives. 850 interface, Centronics printer, cassette, touch tablet plus tons of software, £350. Tel: 0256 473246, ansafone.

**CBM 64** data cassette, disc drive, £500 of software + joystick, real bargain, £250. Tel: 0371 873107.

**AMSTRAD** PC1640 DDMM good condition. Boxed, some software £360 or exchange for Atari 1040 STF/M/Porto studio/synth midi gear W.H.Y. Phone: Marc 021 475 4222, anytime.

**C64**, 1541 II disk drive, data cassette, freeze machine lots of original games, manuals, mags worth over £1500, will sell for £375, o.n.o. Tel: 0892 32911 after 4 pm. Ask for Ashley.

**APPLE II** Europlus, twin floppies, RAM card, Z80 card, 80 column card, monitor serial port, DOS 3.3, CP/M, Basic, Wordstar, DBase, Spreadsheet, etc. Full manuals, £220 o.n.o. Tonbridge 366693, evenings.

**AMSTRAD** PC2086, 32Mb hard disk (Seagate) 14" colour VGA monitor, some software, perfect condition still boxed £900. Phone 0623 552942. Don't hesitate to leave your name and number.

**MACINTOSH II** - with keyboard, unit, Apple 12" monitor, datastream tape unit, Imagewriter LQ printer and loads of software, incl. MS-Word, £4000 - Phone Neil Mansell at LFC Insurance Service on (0702) 471717.

**DEMOS**, 100 disks, 3.5" full of Amiga stuff, used once £100. No offers, no listing, just total lot for sale, £100. Ring Brian 0928 567400. After 8 pm, evenings.

**ATARI 800XL**, disk drive, cassette deck, Amstrad printer, colour monitor, software packages, five joysticks, games, etc, hardly used, and boxed, first fair offer taken. Tel: 0270 73608 (Paul/Brian).

**AMSTRAD** PC 1512 double disk colour monitor II games, two joysticks, moderate condition, £175 o.n.o. Phone 960 4218 after 6 pm, not Wednesday.

**PIONEER** PX-7 MSX computer, with inbuilt Genlock. ideal for video applications. Also Pioneer graphics tablet and pen. Data recorder, Titting software packages. All boxed and immaculate £225 (Derbyshire) 0773 749630.

**FOR** BBC Akhter disc drive 40/80 D/S 5.25" £40. Voltmale twin joysticks £10. Watford Solderless Sideways ROM socket board £20. Various other ROMs. Acorn teletext £20. Tel: 0778 422103.

**AMSTRAD** CPC 464 with colour monitor and 30 games, bargain at £150 o.n.o. or swap for midi keyboard. Tel: Aberdeen (0224) 276434. Ask for Alan.

**MAGAZINES** for sale, Your Spectrum issues 1 to 21, Your Sinclair issues 1 to 27, Popular Computing Today issues 1 to 39. Willing to split, any offers? Phone (0224) 276434.

**PCW** 8256 with memory upgrade. Pro-text WP also CP/M software included. Under six months old still under guarantee. PC Forces Sale. £375 o.n.o. For details Tel: Rochdale (0706) 344106.

**ACORN** 512K co-processor with adaptor to connect BBC B. DOS+ and GEM software. As new £120, much more Acorn hardware/Firmware. Tel: 0702 559005.

**COLOUR** TV 14" portable, suit computer or general use. Quality picture, only £55, buyer won't be disappointed. Ring 0928 567400. Ask for Bri, after 8 pm.

**SINCLAIR** QL for sale £50 inc 8 books, 10 carts, printer interface, all manuals, spare membrane. Ring Brian at 0928 567400, after 8 pm. (Runcorn).

**AMSTRAD** CPC128 colour monitor DMP128 printer, joystick, Mini Office II, Money Manager, Self Teach CP/M plus, £250 games, software + extras excellent condition + manuals. £370 o.n.o. Phone Mick (390) 5861.

**CBM 64** with tape and disc drive + collection of quality games and some for sale at £245 plus joystick and disc box. Tel: 0782 415256, 6-7 pm buyer collects, cash only.

# CASPELL COMPUTER ☎ 0202 666155 [24 hr]

## RIBBONS

Amstrad DMP 2/3000 series	2482	A
Amstrad DMP 4000	2426	E
Amstrad PCW8256 (L/Life)	2741	D
Amstrad PCW9512	2746	B
Brother HR15/25/40	2696	B
Canon PW1080A	2223	D
Centronics GLP	2412	D
Citizen 120D/180E/LSP10	2488	B
Citizen MSP-40/50	2477	D
Commodore MPS801	2236	D
Epson FX/LX-80	2273	B
Epson LX/GX-80	2454	B
Epson LQ-500	2477	D
Epson RX-80	2273	B
Epson EX-800	2774	D
Epson Full Width	2320	D
Juki 6100 Daisywheel M/S	2563	B
NEC Pinwriter P1/P2	2254	D
NEC P2200	2844	D
NEC P6+/P7+	2870	E
Panasonic KXP-1081/1180	2228	D
Seikosha GP100	2317	B
Seikosha SL80 (L/Life)	2741	D
Seikosha 500/550	2236	D
Shirwa CP80/MT80	2698	D
Tatung/Commodore CP80	2698	D
Star LC10	2861	B
Star LC24-10	2868	B
Star NL10	2761	D

Many others - please enquire!

\* = Avail. in Fabric Nylon or M/Strike Film. Please choose!

(Fabrics offer longer life and may be used with Ribbon Refresh!)

## PRICE STRUCTURE

	1 off	2 off	5 off
A	£2.95	£5.75	£12.95
B	£3.95	£7.45	£16.95
C	£4.45	£7.95	£18.45
D	£4.95	£8.95	£19.95
E	£5.95	£10.95	£24.95

Prices include VAT & post

## WE ALSO HAVE

### DISKS

and a Technical Library of 1500 BOOKS!

Please enquire!

FREE SUPPLIES CATALOGUE

24-page FULL BOOKLIST 50p (Only with goods)



## PAPER

All prices per 1000 sheets incl. VAT

\* P&P £2.50 any quantity

11/9.5 60gsm Listing	£6.45
11/9.5 70gsm Microperf	£7.95
11/9.5 85gsm Letter Qual	£9.95
A4 size 70gsm Microperf	£9.70
A4 size 85gsm Letter Qual	£10.95
11/9.5 2 part NCR	£19.40

A5 size Letter Quality paper, Upright (Portrait) Orientation, £13.90 Microperf all edges for letter-writing

□ Address Labels □

3.5/1.5, 1- or 2- across £3.75 per 1000 (+£2.50 P&P)

At last - a unique new ink spray that restores ribbons in seconds

# SAVE £££s ON RIBBONS

- Quick & Convenient.
- Restores & Re-inks faded ribbons in seconds!
- Refreshed ribbon lubricates print head for smoother running & enhanced printer life.
- Use on any fabric ribbon... again and again!
- Pays for itself the first two times you use it.

**NEW**

EXTENDS FABRIC RIBBON LIFE... INDEFINITELY  
**RIBBON REFRESH**  
The Fabric Ribbon Restorer

QUICK & CONVENIENT RESTORES & RE-INKS FADED RIBBONS IN SECONDS  
REFRESHED RIBBON FULLY LUBRICATED THAT READ AS IT GOES WILL SPRAY UP TO 25 IN. LONG USE ON ANY FABRIC RIBBON (EXCEPT ADAM AXI ADAM) 160ml

ONLY **£8.95** inc VAT & post

Cheques/POs (no stamp needed)

**CASPELL COMPUTER SERVICES**

(Dept NCE) FREEPOST, Poole Dorset BH15 1BR

Tel: 0202 666155 or 0202 35650 (24-hr)

TRADE ENQUIRES & LOCAL AUTHORITY ORDERS WELCOMED

Account enquires: 43 Emerson Rd., Poole Dorset BH15 1QS

# YOUR ONE STOP SHOP

MORE SOFTWARE THAN YOU CAN HANDLE!  
MORE HARDWARE THAN YOU CAN USE!

Software

SUPERSTORE

## 20 MEG A590 Hard Drive

with space for 2mb extra RAM to turn your AMIGA into a 3 Meg machine. Essential for advanced graphics etc.

**£399.99** \*OR £15 MONTHLY

**A590**  
Complete with 2mb extra  
Ram fitted

Extra RAM per 1/2Mb  
**£79.99**

ONLY **£699.99** \*OR £27 MONTHLY

**A500 0.5 mb UPGRADE**  
ONLY **£79.99**  
WITH CLOCK **£89.99**

## AMIGA 3.5" 2nd DRIVE ONLY

- \* DISABLE SWITCH
- \* THROUGH PORT
- \* SLIM SIZE
- \* LOW POWER CONSUMPTION
- \* HIGHLY RELIABLE
- \* EXCELLENT R/W PERFORMANCE

**£79.99**

**ST 2nd DRIVES**  
ALSO AVAILABLE  
PLEASE ASK FOR DETAILS

WE STOCK MOST  
DATEL  
PRODUCTS

WE STOCK  
SEGA,  
ATARI, C16,  
MSX, BBC/  
ELECTRON,  
etc.

## AMIGA A500 BATMAN PACK ALMOST HALF PRICE



	R.R.P.
A500.....	£399.99
TV MODULATOR.....	24.99
BATMAN (THE MOVIE).....	24.99
NEWZEALAND STORY.....	24.99
DELUXE PAINT II.....	49.99
INTERCEPTOR.....	29.99
TEN STAR PACK.....	229.50
TOTAL R.R.P. ....	£784.44
LESS DISCOUNT.....	£384.45
<b>OUR PRICE.....</b>	<b>£399.99</b>

\*OR £15 MONTHLY

## OCEANIC DISK DRIVE

**DISK DRIVE C64 COMPATIBLE**  
Smart, slim, reliable.

**FREE SOFTWARE**  
Activision Music Studio, Word Processor, Database  
Communications Program.

ONLY **£129.00**

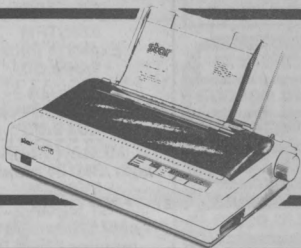

1 YEAR ON-SITE  
MAINTENANCE  
ONLY £10 EXTRA  
ON ANY PRINTER

**1 MEG AMIGA PACK:-**  
as above plus half meg upgrade,  
mouse, mat, mouse holder, dust  
cover and 10 disks

**OUR PRICE**  
ONLY **£499.99**  
\*OR £19 MONTHLY



\*(subject to  
status) Written  
details on re-  
quest.

**MAIL  
ORDER:-  
Carriage  
at Cost**

**ORDER HOTLINE**  
(MON to FRI)  
**(0782) 202269**

**ADVICE HOTLINE (0782) 268620**  
for FAST & FRIENDLY SERVICE

## PRINTERS

### STAR LC10

Acclaimed "Best Buy" budget printer.  
Now massively under-priced at just

**£169.99** \*OR £8 MONTHLY

### STAR LC10 Colour

The perfect printer for every Amiga.  
Colour output from all the better art  
packages - or just slot in a black ribbon  
for word processing. Cheap to run  
too. Very affordable

**£229.99** \*OR £9 MONTHLY

### STAR LC24 - 10

24 Pin quality at a price you can afford.  
8 Fonts, 3 print variations, paper park-  
ing, 170 CPS draft, 57 CPS LQ

**£259.99** \*OR £10 MONTHLY

**FREE Cable with every Printer**

#### STOKE-ON-TRENT

11 Market Square Arcade,  
Hanley Stoke-on-Trent  
Manager: Wayne Tel:  
0782 268620 Open 6 Days

#### SHEFFIELD

6 Waingate, Sheffield  
Manager: Tony  
Tel: 0742 721906  
Open 6 days

#### ST HELENS

27 Baldwin Street,  
St Helens  
Manager: Adrian  
Tel: 0744 27941  
Closed Thursday

#### STOCKPORT

6 Mealhouse Brow,  
(Off Little Underbank),  
Stockport. Manager: Ray  
Tel: 061 480 2693  
Closed Thursday

**AMIGA** 2000 twin 31/2" drives inc motion cable, 1.2 05. Only light home use, owner upgrading to Atari ST, only £750 ono. Call Mike on Dewsbury 0924 466704 any time.

**31/2"** disks for sale DS/DD £9 for 10 unwanted gift. Sedgley 78946.

**ST** originals Falcon, F16, Sleeping Gods, Emmanuelle, Joan of Arc, ART Director, Sinbad, Silent Service, Where Time Stood Still, Carrier Command, £7 each or exchange, 72 Holcombe Street, Derby.

**PC** Engine games to swap, I have War of the Dead and Over Hauled Man, any offers. Phone (0306) 885 003. I also want Nintendo and Vectrex Carts.

**AMSTRAD** 1512 DDCM 640K Math coprocessor much software and manuals plus Epson LX86 printer inc tractor feed. A bargain at £650 the lot. 0203 (Nuneaton) 342172 evenings only.

**BARGAIN** BBC and drive and Teletext adapter + software and mags. Worth over £700. Sell for £275. Phone 061 707 1549 ask for Karl.

**BBC B** fitted with DFS mega 3 Super Art Roms including all manuals for the above. Also SS Cumana disk drive and Acorn tape deck. £350 ono. Phone Burley 416448.

**MULTIFACE** Egat card 600x800, parallel printer port, manual utility disk, demo software £80. Richard Alderton Sheffield

(0742) 669170 evenings.

**HISOFT** Nevada Cobol for CPM machines PCW, CPC etc. Good manual, fast text editor (ED80) and utils. £22 inc postage. Phone Gary on 0709 896665.

**AGENDA** pocket computer and 32K RAM cartridge. Only £120. Ask for Simon 0532 842780. Evenings and weekends.

**520STFM** +1meg ext drive + 51/4 ext drive + £180 original software and extras. Cost over £750 sell for £450 ono. May split. Phone (051) 327 2941 Steve after 5pm.

**ATARI** 1040 STFM colour monitor Signun 2 super base, Pro24 C-Lab creator and more, £550 tel 01-959-3438.

**ACORN** Electron includes data recorder, 25 games, manuals, magazines, good condition £75. Tel 0272 863559 after 6pm.

**AMSTRAD** 6128 green screen plus colour modulator complete with various games £200.00 ono. Tel 021 707 4260.

**ATARI** 130XE, 1050 fitted with US Doubler, 1010, loads of software, mags, 1CD printer interface, no splits. £200 ono. 0726 64014 ask for Dave after 6pm.

**AMIGA** software old and new worth £250. Sell £700! Or split. Also Amiga artists needed to swap ideas and maybe

start crew. Phone Mark after 6pm 0656 650493.

**CBM64** for sale. Hardly used, joysticks, games for £160. Also will sell Sega Master system with control pads. 2 games for £65. Together £220. Phone (0633) 894673 after 5pm.

**SEGA** system, Light Phaser, RFV control stick, 11 games (Thunderblade) and Spectrum +2 £150 of software. Must sell quick £400. Contact Alan 25 Tan-Y-Bryn, Valley, Anglessey, North Wales LL65 3ER.

**ZX** Spectrum Datacorder, joystick, interface, ZX printer, books, 38 games all boxed, Tasword 2, Mini Office VU3D. Phone Dave, Plymouth 0752 369674 after 6.30pm. £100.

**SPECTRUM** 128K plus Twin Opus Drive, plus Multiface 128, plus loads of software, plus VTX Modem. The lot £160. Will split if hassled. Ring now for quick deal. 0823 451593.

**COMMODORE** Printer MPS801 unused £70, collect near Gloucester or pay carriage. Ring 0452 862205.

**AMSTRAD** 2086 30 Meg H.D. Monitor as new. 082584 758.

**SPECTRUM** +2 for sale. Over £300 worth of software and mags + Multiface 128 + Lifeguard and Genie. Together worth £500. Bargain £175 v.g.c. Phone 0922 407847 after 4pm.

**C64** Original disk games eg. Silent Ser-

vice £7, others as well. Phone 01 553 2328 (Ilford). Buyer collects.

**DISK** Drive 5 1/4" Double sided Double Density 80 Track with built in P.S.U. Less than 1 year old. Only £65.00 o.n.o. Contact Geoff Hockney (0323) 893294.

**CPC**, Rombo with Protext, Utopia, Maxam 1.5 £70. AMX Mouse and Art £40. Loads of original tape and disc software, mags etc. Steve: Tel 051 639 0196 (Work Number).

**FOR** sale: Micro peripherals, Daisywheel Printer MP40 uses Diablo Driver. Excellent quality print, pristine condition, call Gio on 0602 605994 (Nottingham) PM £280 o.n.o.

**STOP** press £18, Getset Typeset £16, both £30 Micro Design £30, Master Paint £9 for Amstrad PCW. Phone Steph (0256) 475524 (24 hours).

**ARCHIMEDES** software, Pro-Artisan, games etc. All original at half price or swap for Render Bender. Or any Archies interested in Art and Graphics. Contact Phillip 0282 602836.

**SPECTRUM** 48K with 5 1/4" Floppy Drives. Complete with Kempston Disc Interface, Printer, Joysticks in workstation. Many tapes £100 or split. Tel: 0767 50748.

**COMCEN** PCXT for sale 640K 20Mb HDD 5.25" DD still boxed. Plus Daisy Wheel Silver Reed Exp 400 Printer only £1200 o.n.o. Phone (0924) 469608 any-

# CompuSoft

## AT LAST! QUALITY SOUND FOR YOUR PC AT A REALISTIC PRICE

Enjoy enhanced sound from your games software via the Innovation sound board and your own amp and speakers. The INNOVATION SSI 2001 is the new PC sound standard, supported by many of the worlds leading software houses. Simply plug the sound board into a spare expansion slot and you will immediately have multivoice sound (and a joystick port) bringing high quality sound to your PC games.

Software houses supporting the Innovation sound board include:

Microprose, Velocity Development, Origin Systems, Digitech Software, Spectrum Holobyte, Microillusion, Microdeal, Software toolworks and Activision.

Only £75.00 inc. VAT and P & P.

Compusoft Ltd, 23 Easby Way, Lower Earley, READING, RG6 3XA.  
Telephone 0734-351789

ALL PRICES INCLUDE VAT AND DELIVERY!

**STAR**

MAIN REGISTERED DEALER

LC10 B/W = £154.00

LC10 COL = £197.00

LC24-10 = £235.00

2 METRE 'EASY-PULL' PRINTER CABLES .....£4.95

### AMIGA

NEW! **A500 BAT-PACK**

includes:  
Batman the Movie,  
New Zealand Story,  
F18 Interceptor,  
'D' Paint II,  
Workbench 1.2,  
Kickstart 1.2,  
Amiga Basic,  
Desktop Utilities  
New Tutorial Pack,  
TV Modulator

**£379.00**

with Tenstar Pack  
**£399.99**

### FAST LANE

The No.1 Racing  
Simulation  
only  
**AM £13.95 ST**

**PHILIPS 8833**

**STEREO COLOUR**

**MONITOR**

**ONLY £218**

**10 3.5" DS/DD**

**£7.90**

### ATARI

520STFM  
Power Pack  
**£347.00**

520STFM  
Explorer Pack  
**£269.00**

ST MEGA 1  
Business Pack  
**£519.00**

MEGA 1 PACK  
with SM124 monitor  
**£609.00**

ST MEGA 2  
Laser printer SM124  
monitor £1639.00  
sample printout on request

FREE!! Utilities and Tools Pack with every ST purchase software Blitter, ST Diagnostics, Disk Editor/Custom Formatter, Disk Boot Construction Set, Alarm Clock, Quick Formatter, Calculator, Custom Format Disk Duplicator, Printer Customiser Tool, Desktop games, ARC Construction Set, System Selector, 50/60 HZ Switcher and Synchronizer, Snapshot Dumper, RAM/PRINT Spooler, Word Processor and much, much more!!!

DEDUCT 2% FOR CASH, CHEQUE OR POSTAL ORDER PAYMENT

**COMPUTERHOUSE UK**

**TEL: 01-731-1276**

14 Romily Court, Landridge Road, Fulham, LONDON SW6 4LL



EST 1986

EURO  
CARD

VISA



We Accept EXPRESS VOUCHERS



# TREBLE H COMPUTING



We Accept EXPRESS VOUCHERS



## ATARI

**★ NEW ★ POWER PACK PLUS**

**ATARI 520 STF 1 MEG DRIVE**

FIRST BASIC, ORGANISER, FIRST MUSIC, XENON, DOUBLE DRAGON, NEBULUS, ELIMINATOR, OUT-RUN, GAUNTLET II, SUPER HUEY, AFTERBURNER, R-TYPE, PREDATOR, SUPER HANG-ON, BLACK LAMP, STARGLIDER, SPACE HARRIER, BOMB JACK, OVERLANDER, PACMANIA, STAR GOOSE, STAR RAY, BOMBUZAL.

+ JOYSTICK + 80 CAP. DISK BOX  
+ 10 x 3 1/2" DS/DD DISKS  
+ MOUSE MAT

**ALL FOR ONLY**  
**£369.99**

ATARI 520 STF 1 Meg Drive .....£269.99  
 ATARI 520 STF 1 Meg Drive + Super Pack .....£349.99  
 \* NEW\* ATARI 520 STF 1 Meg Drive + Power Pack .....£349.99  
 ATARI 1040 STF + Professional or Games Pack .....£439.99  
 ATARI 1040 STF + Steinberg Pro-12 .....£439.99  
 \* NEW \* MEGA 1 ST Inc. Professional Pack .....£519.99

**ADD £99.99 TO INCLUDE SM124 MONO MONITOR WITH ANY OF ABOVE**

AMIGA 500 Inc. Modulator .....£359.99  
 AMIGA 500 + 1/2 RAM Expansion .....£489.99  
 AMIGA 500 + 1084S Med. Res. Colour Monitor .....£589.99  
 B2000 + XT Bridgeboard + A2040 20 Mb Hard Drive + 1084S Monitor.....£1499.00  
 AMIGA Art & Animation Pack Amiga 500  
 + 1/2 Meg Expansion + Deluxe Paint III .....£549.99

## AMIGA

**NEW ★ SPECIAL PACK**

AMIGA 500 INC MODULATOR  
 WORKBENCH 1.3 AND MANUALS  
 11 GAMES  
 80 CAPACITY DISK BOX  
 20 x 3 1/2" DISKS  
 MOUSE MAT  
 DUST COVER

**ALL FOR ONLY**  
**£389.99**

### ACCESSORIES

Amiga A501 RAM Upgrade.....£129.99  
 Workbench 1.3 .....£13.50  
 Joystick/Mouse Extension.....£5.50  
 Disk Drive Cleaner (3.5 or 5.25) .....£4.95  
 Mouse Mat (Soft) .....£4.50  
 ST or Amiga Dust Cover .....£6.50  
 Amiga to Scart Lead (Not Sony) .....£9.95  
 ST to Scart Lead .....£9.95  
 Quickshot II Joystick .....£8.50  
 DCOMJoystick (Fully Microswitched) .....£9.95  
 Competition Pro 5000 (Black) .....£11.50  
 Competition Pro 5000 (Clear) .....£12.50  
 50 x 3.5" Disk Labels .....£1.20  
 80 Capacity 3.5" Disk Box.....£6.50  
 Monitor Covers From .....£6.95  
 Konix Speedking .....£10.50  
 Konix Navigator.....£12.25

### GAMES SOFTWARE

ST SOFTWARE		AMIGA SOFTWARE	
3-D Pool.....	£16.50	3-D Pool.....	£16.50
Battle Chess.....	£16.50	Battle Chess.....	£16.50
Blood Money.....	£16.50	Blood Money.....	£16.50
Blood Wych.....	£16.50	Blood Wych.....	£16.50
Daily Double Horse Racing.....	£13.50	Daily Double Horse Racing.....	£13.50
F16 Combat Pilot.....	£16.50	F16 Combat Pilot.....	£16.50
Falcon.....	£16.50	Falcon.....	£19.50
Falcon Mission Disk.....	£13.50	Falcon Mission Disk.....	£13.50
Gunship.....	£16.50	Gunship.....	£16.50
Hawkeye.....	£13.50	Hawkeye.....	£13.50
Kick Off.....	£13.50	Kick Off.....	£13.50
Kult.....	£16.50	Kult.....	£16.50
Leonardo.....	£13.50	Leonardo.....	£13.50
Lords of the Rising Sun.....	£20.99	Lords of the Rising Sun.....	£20.99
Microprose Soccer.....	£16.50	Microprose Soccer.....	£16.50
Mr Hell.....	£16.50	Mr Hell.....	£16.50
North & South.....	£16.50	North & South.....	£16.50
Passing Shot.....	£13.50	Passing Shot.....	£13.50
Quest for the Time Bird.....	£16.50	Quest for the Time Bird.....	£16.50
Rainbow Island.....	£16.50	Rainbow Island.....	£16.50
Risk.....	£13.50	Risk.....	£13.50
Robocop.....	£13.50	Robocop.....	£13.50
RVF Honda.....	£16.50	RVF Honda.....	£16.50
Shinobi.....	£13.50	Shinobi.....	£13.50
Shufflepuck Cafe.....	£13.50	Shufflepuck Cafe.....	£13.50
Targhan.....	£16.50	Targhan.....	£16.50
Vigilante.....	£13.50	Vigilante.....	£13.50
Waterloo.....	£16.50	Waterloo.....	£16.50
Wayne Gretzky Hockey.....	£16.50	Wayne Gretzky Hockey.....	£16.50
Xenophobe.....	£16.50	Xenophobe.....	£16.50

### MONITORS

ATARI SM 124 .....£109.99  
 ATARI SC 1224 .....£284.99  
 COMMODORE 1084S.....£259.99  
 PHILIPS 8833 .....£229.99

### DRIVES

CUMANA 1 MEG 3.5" for ST .....£94.99  
 CUMANA 1 MEG 3.5" for Amiga .....£94.99  
 NEC 3.5" for ST .....£94.99  
 NEC 3.5" for AMIGA .....£84.99  
 PCML 5.25" for ST .....£134.99  
 CUMANA 5.25" for AMIGA .....£134.99

### PRINTERS

STAR LC10 inc Cable + ribbons .....£175.00  
 STAR LC10 colour inc Cable .....£219.99  
 CITIZEN 120/D inc Cable .....£139.99  
 EPSON LX800 .....£189.99  
 STAR LC 24/10 inc Cable .....£269.99

### HARD DRIVES

THIRD COAST, ATARI, SUPRA AND  
 COMMODORE A590, VORTEX AVAILABLE. PLEASE  
 CALL FOR  
**\* BEST PRICES \***

### MUSIC AND SOUND

**ST**  
 Steinberg Pro-24.....£249.95  
 C-Lab Creator .....£239.99  
 C-Lab Notator .....£359.99  
 EZ Track Plus.....£249.95  
 Edit Track.....£199.99  
 Super Conductor.....£39.99  
 Pro Sound Designer.....£249.99  
 ST Replay 4 .....£64.99

**AMIGA**  
 Aegis Sonix V.2.....£44.95  
 Aegis AudioMaster II .....£59.95  
 Amas.....£77.99  
 Future Sound.....£79.99  
 Pro Sound Designer Gold .....£74.99  
 Eidersoft Midi Interface .....£24.95  
 Datel Midi Interface .....£34.95  
 Music X Out Now! .....£189.99  
 Dr T's KCS .....£159.99  
 Dr T's Midi Recording Studio .....£52.95  
 Deluxe Music .....£59.95

### DISKS



**TOP QUALITY  
 3 1/2" DS/DD  
 GUARANTEED  
 BULK DISKS**





**NEW PRICES**

10.....	<b>£7.50</b>
25.....	<b>£16.90</b>
50.....	<b>£32.25</b>
100.....	<b>£62.50</b>
200.....	<b>£123.00</b>

INCLUDING LABELS. Add £5.50 for 80 Capacity Disk Box when ordering disks  
 or £4.50 when ordering 50 or more Disks

### ART & ANIMATION

**ST**  
 Degas Elite.....£19.95  
 Cyber Paint 2 .....£54.95  
 Cyber Studio CAD 3D .....£69.95  
 Spectrum 512 .....£44.95  
 Quantum Paint Pro.....£32.95

**AMIGA**  
 Lights, Camera, Action.....£47.95  
 Zoetrope.....£79.95  
 Aegis Videoscape 3D.....£109.99  
 Comic Setter .....£44.99  
 Mini-Gen (Genlock) .....£104.99  
 Moviesetter.....£59.95  
 Deluxe Paint III.....£59.95

## ATARI PORTFOLIO POCKET PC



Pocket sized PC with 128K internal RAM, 256K ROM containing  
 B105 operating system and full applications suite, 200 mm x 105 mm x 29 mm  
 casing opens to reveal 40 col x 8 lines LCD screen and 63 keys with buried numeric keypad.

Built in applications include:

**Lotus 1-2-3 File Compatible Spreadsheet** Spreadsheet with 127 Col x 255 ROM worksheet. Calculations by natural order read and writes Lotus version 1 and 2.01 files. 123-like commands supported such as range move, copy, titles, column and ROM insert/delete.

**Diary** Comprehensive calendar and diary. "Wake-up" alarms even when switched off. Repeat entries daily, weekly or yearly. fast entry and movement of appointments.

**Address and Phone Book** Card index system. Automatic finding and dialling of any numbers V.A. DTMF tone dialer. Entries sorted on entry and can be selected into different categories.

**Calculator** Multiple display formats and memories. Factorial, power and root functions. Calculations can be reviewed and edited.

**Editor** Comprehensive and easy to use text editor. Optional word wrap at any column width. String search or replace.

**Other Features** Compatible with MS-DOS 2.11. Select screen between 40x8 and 80x25 mode. RAM expandable to 640K internal RAM disk configurable from 8K.2 way file transfer with a PC and printing using the parallel port auto switch off screen contrast control.

**£249.99**

All prices include VAT. Please send Cheques/PO made payable to:-

## TREBLE H COMPUTING

**DEPT NCE, CROMER HOUSE,  
 CAXTON WAY, STEVENAGE,  
 HERTS. SG1 2DF**

**★ CREDIT CARD HOTLINE: 0438 361738 ★  
 FAX: 0438 740 794**

If you do send cash please send it Registered.  
 All Goods are sent First Class/Registered. Please add £3.00 for outside U.K.  
 Large Orders ie. Amigas, ST, Monitors etc are always sent by courier.  
 Please add £6.00, if you require Next Day Courier Delivery on other items.

All prices are correct at time of going to Press, and are subject to change without prior notice



# FIRST micro

LOWEST UK PRICES GUARANTEED

HARDWARE & SOFTWARE  
SPECIALISTS  
NEW! SHOWROOM  
13 LANSDOWNE RD  
BOURNEMOUTH  
DORSET



EXC. VAT (0202) 24927



DELIVERY £5.00

## COMPUTERS

### AMSTRAD

PCW8256	£312			FREE PC TRAINING
PCW8512	£379			
PCW9512	£399			
	<b>MONO</b>	<b>COLOUR</b>		
PC1512 SD	£357	£439		
PC1512 DD	£439	£519		
	<b>MONO</b>	<b>COLOUR</b>	<b>EGA</b>	
PC1640 SD	£455	£539	£634	
PC1640 DD	£509	£589	£674	
PC1640 HD	£685	£799	£865	
	<b>MONO</b>	<b>COLOUR</b>	<b>12" HI-RES COLOUR</b>	<b>14" HI-RES COLOUR</b>
PC2086 SD	£539	£663	£749	£829
PC2086 DD	£649	£769	£846	£929
PC2086 HD	£833	£969	£1059	£1129
PC2286 DD	£875	£999	£1038	£1179
PC2286 HD	£1179	£1299	£1384	£1479

### EPSON

	<b>NO MONITOR</b>	<b>MONO</b>	<b>EGA</b>
PCs		£699	£1039
PCAx2	£969	£999	£1199
PCAx40	£1289	£1368	£1579
PCAx80	£1598	£1679	£1898

### COMMODORE

	<b>MONO</b>	<b>COLOUR</b>	<b>EGA</b>
PC10 SD	£499	£599	£749
PC10 DD	£589	£739	£875
PC20 HD	£779	£959	£1089
PC40 SD	£1065		£1270
PC40 HD	£1393		£1557

### LASER PRINTERS

Brother HL-88PPM	£1389
Brother HL-8QS Postscript 8PPM	£2967
Canon L8P-811 8PPM	£1259
Canon L8P-811 T exc toner 8PPM	£1874
Canon L8P-811 R exc toner 8PPM	£2068
Citizen Overture 110+10PPM	£959
Epson GQ3500 6PPM	P.O.A.
Hewlett Packard Laserjet II D 8PPM	£1967
Kyocera F1200 10PPM	£1469
Kyocera F1200 10PPM	£2379
Panasonic KXP-4450 PPM	£1342
QMS-PS 8 Postscript 6PPM	£2669
Qume Crystal Print WP 6PPM	£2095

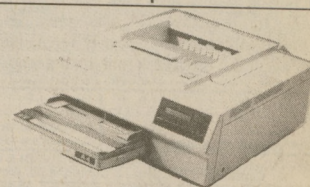

Hewlett Packard Laserjet II 8PPM  
ONLY £1249!

\*INCLUDES 1 YEAR ON-SITE MAINTENANCE



THE  
**star**  
COMPUTER PRINTERS  
LC24-10 £199



## AMIGA A500

INCLUDING:-  
• MOUSE • WORKBENCH • UTILITIES • MANUALS  
• BASIC • TUTORIAL • TV MODULATOR



£289

NOW AVAILABLE

AMIGA 500

BATMAN PACK



### A500 HARDWARE

A500 + TV MOD	£289
A500 + £200 OF GAMES	£315
A500 + 1084(S) HIGH RES COLOUR MONT	£476
A500 + IBM DRIVE	£359

### AMIGA EXTERNAL DRIVES

Cumana Cax 354E	£79
AF880	£89
RF302C	£89
Supra 20mb H/disk	
* All drives 1mb + on/off switch *	

### A2000 HARDWARE

A2000 + 1mb RAM	£799
A2000 + 1084(s) monitor + bridge BD + 20mb H/disk	£1299
A2000 + 1084(s) 20mb hard disk	£1049
XT bridge BD	£299

### A500/A2000 MONITORS

1084(s) High res monit	£209
Philips CM8833 High res.	£200
1901 C64-colour	Phone
1900 C64-Mono	Phone

### CANON

BJ-130	£569
--------	------

### CITIZEN

120D	£104
Swift 24	£269
MSP 15E	£185
HQP40 24pin	£269
HQP45 24pin	£297
150	£249

### EPSON

LX-400	£138
LX-850	£185
FX-1050	£373
LQ-400	£199
LQ-550	£268
LQ-850	£399
LQ-860	£529
Q-1050	£535
LQ-1060	£665
LQ-2550	£844

### HEWLETT PACKARD

QUIET JET +	£409
DESK JET	£442
DESK JET +	£534
PAINT JET	£666

### NEC

P220	£139
P6+	£411
P7+	£529

### OTO

850XL 850cos	£1474
--------------	-------

### PANASONIC

KXP 1081	£123
KXP 1592	£264
KXP 1595	£314
KXP 1124 24 pin	£247
KXP 1540 24 pin	£409

### SEIKOSHA

SSP-10 A1 pin 800cps	£2199
----------------------	-------

### STAR

LC10	£139
LC10 COLOUR	£169
LC24/10	£248
NX15	£259
FR10	£308
FR15	£399
XB24-10	£399
XB24-15	£529
NB15 INC S/FEED	£489

### DAISYWHEEL PRINTERS

Premier 35	£379
------------	------

### JUKI

ALL PRICES EXCLUDE VAT

CREDIT CARDS MAIL ORDER

AND EXPORT HOTLINE

(0202) 24927

To: FIRST MICRO, 13 LANSDOWNE RD, BOURNEMOUTH, DORSET BH1 1RZ  
I wish to order \_\_\_\_\_

My computer is \_\_\_\_\_

I enclose cheque/PO for £ \_\_\_\_\_ inc VAT.

Or charge my Access/Visa No. \_\_\_\_\_ Exp. date \_\_\_\_\_

Name \_\_\_\_\_

Signature \_\_\_\_\_

Address \_\_\_\_\_



## SOUTHEAST KENT SOFTWARE

78, Southfleet Road, Orpington, Kent. BR6 9SW.  
0689 50204Amiga 500 + FREE T.V. Modulator .....£350.00  
Atari 520 STFM Superpack .....£360.00SEGA SOFTWARE 10% OFF RETAIL PRICES  
Vigilante .....£22.00  
California Games .....£22.00  
Outrun 3D .....£22.00  
Altered Beast .....£22.0030% OFF ATARI/AMIGA GAMES  
Vigilante .....£11.50  
The Last Crusade .....£13.95  
Licence to Kill .....£13.95Business Software for Amstrad PCW,  
Atari & Amiga

Joystick 20% off Retail Prices

Cheque or P.O. payable to:  
J Ferguson

## ATARI ST PUBLIC DOMAIN

Alpha's Autumn Catalogue now has hundreds of great programs including:

- \* Desktop Publishers
- \* Wordprocessors
- \* Educational
- \* Art & Design
- \* Databases
- \* Business
- \* Copiers Galore
- \* Spreadsheets
- \* Accessories

High Quality Public Domain on top Quality Disks  
Send £1.00 for a demo disk and a catalogue

ALPHA COMPUTING, 32 Meadow Drive, Halifax, W. Yorks. HX3 5JZ

## SuperMaths

Specially written for Amstrad PCW's, PC's and compatibles. User friendly, enjoyable package: multiplication (including tables), division, addition and subtraction - 4 levels of difficulty - ages 5 upwards. Scores shown, success rewarded. PRACTICE and TEST (timed). WORKSHEET produces worksheets on printer with choice of styles, with separate answers.

Can provide hours of fun improving numeracy

Price (inc VAT/P&P) £18.95 (PC) and £16.95 (PCW). Cheques to  
Abacus Software, 11 Woodcote Drive, Orpington, Kent BR6 8DB  
Proprietor: JD CharltonAbacus  
Educational Software

## HINDLEY ELECTRONICS

SAME DAY SERVICE  
(CALLERS) C64 ONLY

FAST

24hr TURNAROUND  
(POSTAL) C64 ONLYEXPERT COMPUTER REPAIRS COMMODORE-SINCLAIR-ACORN  
Standard Charges (inc. VAT and fully insured return postage.)

Commodore 64	£25.00	Spectrum +2	£25.00	Amiga 500	£40.00
Commodore +4	£25.00	Commodore 64C	£29.00	Acorn Electron	£26.00
1541 Disc Drive	£32.50	Commodore Vx 20	£18.00	Amiga 500 Disc Drive	
Spectrum 48K	£18.00	Commodore 128	£32.00	Replacement	£65.00

3 MONTHS NO QUIBBLE WARRANTY ON ALL REPAIRS.

Computer ICS & General Components. Why pay more? (Please ring before posting goods)  
DEPT NCE, 97 MARKET STREET, HINDLEY, WIGAN WN2 3AA. TEL: 0942 522743

## BOOKS ON DISK

Now available on 5.25" disk for IBM PC and Compatibles  
CARMILLA AND OTHER DISTURBING TALES

THIS DISK CONTAINS FOUR EERIE STORIES BY the acclaimed writers, J. Sheridan Le Fanu and Bram Stoker.

USING OUR SYSTEM READING FROM YOUR SCREEN IS AS EASY AS PICKING UP A NOVEL!

(Facility for printing entire book included)

Send cheque/P.O. for £2.95p (Eire/EEC add 20p) or credit card details (incl. expiry date) to:

BLYTHE PUBLISHING - 8 GLENNOR CRESCENT WEST -

CARYDUFF - NIMELAND - BT9 8JF

IMMEDIATE DISPATCH BY FIRST CLASS POST ORDER FROM PRESTEL NO. 390502.

24 HOUR CREDIT CARD ORDERLINE 0232 813290

J. D. LEWIS  
Computer & Repair Service3 1/2" DSDD (Bulk)/10 .....£8.50 Star LC10 Printer .....£175.00  
5 1/4" DSDD (Bulk)/10 .....£3.95 ST Joystick/Mouse Extension .....£4.953 1/2" Disk Labels 100 for £2.25 inc P+P  
Send Large S.A.E. for FREE CatalogueAdd 65p Postage on orders under £10 Send Payment to:  
J.D. LEWIS, 97 CHAPLIN ROAD, LONGTON, STOKE-ON-TRENT, STAFFS. ST3 4RH  
TEL: 0782 323348

## K.Y.C. Disks

3.5 Unbranded Sony DS/DD  
65p per disc minimum order 25  
3 1/2" Locking Disk Boxes80 capacity £6.00 each  
Money Back Guarantee if not satisfiedAll Disks  
100%  
guaranteed  
135T.P.I.

Prices include P&amp;P and Labels. Send cheques &amp; postal orders to:-

K.Y.C. Disks, 51 Barmouth Road, Wandsworth, London, SW18 2DT.

Tel: 01-870 0469

## CHAMELEON SOFTWARE - APPLE SPECIALISTS

Apple II, Apple Macintosh: HARDWARE, SOFTWARE and

ACCESSORIES including a wide range of GAMES.

BOOKS for most computers, over 1700 titles available.

Write or telephone for latest list - please state machine. 10 free

3.5 inch wrap around labels to all enquirers.

Sony branded discs - £11.00 inc VAT and P&amp;P

Ribbon re-inking service from £1.50 per ribbon.

FREEPOST, Pinchbeck, SPALDING, Lincs. PE11 3BR.

Tel: 0775 85481

## THE CHIP SHOP (SEMICON) LTD

DO YOU NEED INTEGRATED CIRCUITS ? TRY US !

WE HAVE A FULL RANGE OF TTL, CPU'S, EPROMS, RAMS ETC  
+ MEMORY UPGRADES FOR MOST MICROS.FOR EXAMPLE V20 - 8 - .....13.50  
V30 - 8 - .....10.50  
Spectrum VLA - .....6.50

SEND SAE FOR FULL LIST

6 BEAN LEACH DRIVE, OFFERTON, STOCKPORT, CHESHIRE, SK2 5HZ

VISA ACCESS HOTLINE 061 - 483 - 1989

Multiworld Trading Company  
(UK limited)WE ALWAYS HAVE IN STOCK, LIQUIDATED AND REDUNDANT NEW AND SECOND  
USER TOP QUALITY COMPUTERS AT PRICES WE DARE TO ADVERTISE.

Every machine is checked out before collection.

Warranty available on certain machines

RIGHT NOW WE HAVE:

IBM PS2 Model 30/26, IBM PS2 Model 50, IBM PS2 Model 50Z,  
IBM PS2 Model 70, IBM Model 60, IBM AT's, IBM XT's, IBM PC'sAMSTRAD (all ranges), APRICOT (all ranges including 386), Compaq,  
Toshiba portable computers, Zenith portable computers,  
APPLE (most of latest including Macintosh),  
EPSON printers always available, STAR printers, HP laser printers, CANON  
laser printers, D/RAM memory chips, Math Co-Processors.

WE ALWAYS HAVE IBM COMPATIBLE COMPUTERS IN STOCK

FOR ALL YOUR NEEDS, BUYING OR SELLING, PLEASE CONTACT US  
ON 01-360-3305 FAX: 01 360 3757

OFFER OF THE MONTH

VGA COLOUR MONITOR .....£199.00 + VAT  
GROUP 3 PORTABLE FAX MACHINE - BT APPROVED .....£399.00 + VAT

HURRY AS STOCK IS LIMITED!

TRADE ENQUIRIES ARE ALWAYS WELCOME ON 01-360-8095

## NOVA PRESENTS - FOR THE AMIGA

NOVA PD CLUB The spirit of Amiga P.D.

Fish, TBAG, AGATron, Amicus and Nova collections

ALL popular Amiga P.D. collections

ONLY £2 per disk!!!

Catalogue disk £1.50 -

Updated FREE OF CHARGE

Discount Hardware, Software, Disks from 67p each

NOVA DISK MAGAZINE - ISSUE 3

★ Three disks • FREE Nova PD Club catalogue • £6.

★ News, Reviews, Articles, Programs Plus Lots More

★ INCLUDES PLANS FOR A  
COMPLETE SOUND SAMPLER.

★ Programs Text and Art compressed by up to 65%

★ Please make all Cheques/PO's payable to NOVA.

Nova (NCE), 4 Octavian House, Dashwood Road, Banbury, Oxon. Tel: 0295 259682

ANOTHER SPECIAL FROM EXMOUTH MICROS  
PC 1512 UPGRADE SET OF 18 RAM CHIPS

£29.99

Full instructions. Includes VAT and Postage. Visa Orders welcome.

Tel: 0395 267734

Exmouth Micros,

15 South Street, Exmouth, Devon, EX8 2SX

## WANTED FOR CASH

IBM COMPATIBLE COMPUTERS & EQUIPMENT  
JOB LOT BUYER OF HARDWARE & SOFTWARE

## SPECIAL OFFER

EASYWRITER 2 WORDPROCESSOR  
ONLY £45.00

FOR YOUR BEST POSSIBLE DEAL CALL

EXPRESS COMPUTERS  
(0604) 35519 OR FAX 35540DAVID OR CHRIS  
(DEPT NCE)

## YOU SAW THIS SPACE!

So Do 24,637 other prospective  
buyers every week!To find out how this space could work for you,  
CALL HELEN KIRKHOPE  
on (0225) 446034

**COMPUTER REPAIRS**

Fixed Price Repairs For:  
ACORN, AMIGA's, AMSTRAD, ATARI, COMMODORE,  
SPECTRUM's, ST's and QL's.

Includes - Delivery, Parts, Labour, Full Service  
V.A.T., 90 Day Warranty and 5 Day Turnround  
(Subject to Parts Availability) Collection can be arranged.  
Some faults and customer damage may incur a surcharge  
All our Engineers are fully experienced in 8 & 16 Bit Technology  
We also repair Business Computers, Monitors, Printers and  
Computer Terminals etc.

Low Cost Maintenance Contracts Available.  
Educational & Dealer Discounts Given.

Phone for details of our fully inclusive ST memory & drive upgrades  
**SHIELD COMPUTER SERVICES LTD**  
50 FLIXTON ROAD, URMSTON,  
MANCHESTER M31 3AB  
Telephone: 061 747 3185  
Fax: 061 747 0515

- 14" EGA Monitors.....£240.00
- Mannesman Tally MT81 .....£90.00
- MT 905 Laser Printers .....£825.00
- 286 AT 20mb Lap Tops.....£1450.00
- Xerox Ventura V1.0A
- UK Edt. Bulk packaged.....£45.00
- AST Megaplus II 256K.....£25.00

All items are ex. VAT and plus Delivery

Please call

**CAPITAL PRODUCTS**  
**061 926 9473**

9am - 5pm

**COMPUTER REPAIRS**

Specialists in Home and Business Computers, all makes repaired.  
ATARI, AMSTRAD, COMMODORE, SPECTRUM, SINCLAIR etc.

Atari Approved Service Centre.  
We also repair Printers, Monitors, Disk Drives etc.  
FREE estimates, all work fully guaranteed.

A.M.C., UNIT 4, WESTON ROAD INDUSTRIAL ESTATE,  
STRATFORD-UPON-AVON, WARKS, CV37 0AH  
**0789 292269**

**WIZZARD COMPUTERS**

**HOME AND BUSINESS SYSTEMS**

Full Range of PC's In Stock  
Commodore Amiga A500 - £369 inc VAT  
Atari 520STFM from £269.00 inc VAT  
Phone for details of all stock



**WIZZARD COMPUTERS**

93 Graham Street, Airdrie, Scotland ML6 6DE  
Telephone: 0236 47097

**COMPUTER REPAIR SPECIALISTS**

★ All types repaired from £15 ★ Please ring for details ★

**0909 483255**

**P & J Enterprises**

18, Anston Avenue, Worksop, Notts S81 7HT

**ALL COMPUTER HARDWARE AND SOFTWARE WANTED FOR CASH OR EXCHANGE**

**NOTHING REFUSED!!**

**01 727 0424**

*Magnetic North*

Amiga A500 includes Workbench 1.3, Mouse, Manuals etc.  
**ONLY £295.00 + VAT**

Public Domain for Amiga and IBM  
**£2.99 each**

Price includes next day delivery

46 Cookson Street  
Blackpool  
FY1 3ED

Tel: (0253) 22637

Callers welcome by appointment



*Eigen PD Software*

Public Domain & User-Supported Software  
for the IBM PC Compatibles

**£1.95**

Phone or send an A5 SAE for your FREE Catalogue of  
one of the Country's largest and best documented  
PD/Shareware Collections.

Per Disk (5 1/4")

	5 1/4"	3 1/2"
1 Disk	£1.95	£2.50
5 Disks	£8.00*	£12.00
10 Disks	£15.00**	£22.50

Unlike other Libraries, we don't have  
any "hidden" costs, like VAT, P&P,  
Membership Fees, 0898 phone num-  
bers etc.

**The Price You See Is  
The Price You Pay**

\* Includes FREE Library Case  
\*\* Includes 2 FREE Library Cases

Blank Disks: 5 1/4" DS/DD £9.50 for 25  
3 1/2" DS/DD £10.50 for 10

Disk Head Cleaning Kits £3.50 (State 5 1/4/3 1/2")

PO BOX 722, SWINDON, SN2 6YB. 0793 611270 & 061 748 4274

**ELECTRIC PD MAIL ORDER**

Write or phone for your FREE price list quoting the name of your computer

	Comm. 64	Amst.	Spec.	Amiga.	ST.
Pacamania.....	£6.95	£6.65	£6.65	£13.95	£13.65
Thunderbirds.....	£6.95	£6.95	£6.95	£17.50	£16.50
Robocop.....	£6.95	£6.95	£6.95	£16.40	£13.65
Spitting Image.....	£6.95	£6.95	£6.95	£14.50	£13.95
Operation Wolf.....	£6.95	£6.95	£6.65	£16.50	£13.65

Prices include VAT and UK Postage & Packaging. Europe - add 70p  
per game. Outside Europe add £1 per game.  
Cheques and P.O.'s to:

**ELECTRIC P.D.**

7 Park Road, Haltwhistle,  
Northumberland, NE49 9AR  
Tel: (0434) 321942

**COMPUTER AUCTIONS**

PRESENTED BY

**B & T ENTERPRISES**

Northolmes School - 4 November  
Viewing from 9.30 am. Auction commences 11.30 am  
CALL FOR FURTHER DETAILS

**Phone 0403 791018**

# XENON TECHNOLOGY

## HAND HELD GAMES

Donkey Kong II	Multi Screen	£22.45	Gold Cliff	Multi Screen	£22.45
Mario Bros	Multi Screen	£22.45	Climber	Wide Screen	£17.95
Safe Buster	Multi Screen	£22.45	Highway		£6.25
Pinball		£6.25	Air Combat		£6.25
Bomb Sweeper	Multi Screen	£22.45	Balloon Flight	Wide Screen	£17.95
Donkey Kong	Multi Screen	£22.45	Soccer		£6.25
Snoopy Tennis	Wide Screen	£17.95	Volcano		£6.25
Super Mario Bros	Wide Screen	£17.95	Space Fighter		£8.95
Plane & Tank		£6.25	Donkey Kong Junior	Wide Screen	£17.95
Jet Fighter		£8.95	Space Warrior		£8.95

## COMMODORE AMIGA SOFTWARE

Xenon II Megablast (Image Works)	£15.45
Batman: The Movie (Ocean)	£15.75
Shadow of the Beast (Psygnosis)	£21.95
It Came From The Desert (Image Works)	£19.45
Blade Warrior (Image Works)	£16.45
The Untouchables (Ocean)	£16.45
Cabal (Ocean)	£14.95
Stryx (Psychapse)	£12.75
Swords of Twilight (Electronic Arts)	£16.45
Dynamic Debugger (Image Works)	£16.45
Interphase (Image Works)	£16.45
Operation Thunderbolt (Ocean)	£16.45
The Lost Patrol (Ocean)	£15.75
Ooze (Dragonware)	£16.45
Fiendish Freddie's Big Top 'o Fun (Mindscape)	£16.45
Beach Volley (Psygnosis)	£15.75
Populous: Promised Lands (Electronic Arts)	£6.45
Gemini Wing (Virgin)	£12.75
Future Wars (Delphine/Palace)	£15.75
Power Drift (Activision)	£16.45

## ATARI ST SOFTWARE

Chaos Strikes Back (FTL)	£12.99
Xenon II Megablast (Image Works)	£15.45
Batman: The Movie (Ocean)	£13.45
Elite Editor (Xenon Technology)	£9.95
Blade Warrior (Image Works)	£16.45
Falcon Mission Disk Volume 1 (Mirrorsoft)	£13.45
Cabal (Ocean)	£13.45
Stryx (Psychapse)	£13.45
Hound of Shadow (Electronic Arts)	£16.45
Dynamic Debugger (Image Works)	£16.45
Interphase (Image Works)	£16.45
Stunt Car (Micro Style)	£16.45
The Lost Patrol (Ocean)	£13.45
Ooze (Dragonware)	£16.45
Fiendish Freddie's Big Top 'o Fun (Mindscape)	£16.45
Beach Volley (Psygnosis)	£13.45
Populous: Promised Lands (Electronic Arts)	£6.45
Gemini Wing (Virgin)	£13.45
Ferrari Formula 1 (Electronic Arts)	£15.85
Gunship Editor (Xenon Technology)	£4.95

## COMMODORE 64 SOFTWARE

	Disk	Tape
Batman: The Movie (Ocean)	£9.45	£6.35
Shinobi (Virgin)	£9.45	£6.45
Dynamite Dux (Activision)	£9.45	£6.45
Bloodwych (Image Works)	£8.45	£6.45
Cabal (Ocean)	£9.45	£6.35
Blood Money (Psygnosis)	£8.45	£6.45
Ballistix (Psychapse)	£8.45	£6.45
Laser Squad (Blade)	£9.45	£6.45
Beach Volley (Ocean)	£9.45	£6.45
Dragon Spirit (Domark)	£8.45	£6.45
Mr Heli (Firebird)	£9.45	£6.45
Carrier Command (Rainbird)	£9.45	£6.45
Quarterback (Virgin)	£9.45	£6.45
Stunt Car (Micro Style)	£13.45	£9.45
Super Quintet (Infogrames)	£9.45	£6.45
Super Wonder Boy (Activision)	£9.45	£6.45
Eye of Horus (Logotron)	£9.45	£6.45
Rainbow Island (Firebird)	£9.45	£6.45
Operation Neptune (Infogrames)	£9.45	£6.45
Weird Dreams (Rainbird)	£9.45	£6.45

## SPECTRUM SOFTWARE

	Disk	Tape
Batman: The Movie (Ocean)	£9.45	£6.35
Shinobi (Virgin)	£9.45	£6.45
Dynamite Dux (Activision)	£9.45	£6.45
Bloodwych (Image Works)	£8.45	£6.45
Cabal (Ocean)	£9.45	£6.35
Chase HQ (Ocean)	£9.45	£6.45
Operation Thunderbolt (Ocean)	£9.45	£6.35
Laser Squad (Blade)	£9.45	£6.45
Beach Volley (Ocean)	£9.45	£6.45
Dragon Spirit (Domark)	£8.45	£6.45
Mr. Heli (Firebird)	£9.45	£6.45
Xenophobe (Micro Style)	£9.45	£6.45
Quarterback (Virgin)	£9.45	£6.45
Altered Beast (Activision)	£9.45	£6.45
Super Quintet (Infogrames)	£9.45	£6.45
Purple Saturn Day (Exxos)	£9.45	£6.45
Chuck Yeager's Advanced Flight Sim (E/A)	£9.45	£6.45
Rainbow Island (Firebird)	£9.45	£6.45
Risk (Leisure Genius)	£9.45	£6.45
Passing Shot (Image Works)	£8.45	£6.45

## AMSTRAD CPC SOFTWARE

	Disk	Tape
Ghostbusters II (Activision)	£9.45	£6.45
Shinobi (Virgin)	£9.45	£6.45
Dynamite Dux (Activision)	£9.45	£6.45
Power Drift (Activision)	£9.45	£6.45
Cabal (Ocean)	£9.45	£6.45
Batman: The Movie (Ocean)	£8.45	£6.45
Chase HQ (Ocean)	£8.45	£6.45
Laser Squad (Blade)	£9.45	£6.45
Beach Volley (Ocean)	£9.45	£6.45
Altered Beast (Activision)	£8.45	£6.45

	Disk	Tape
Mr. Heli (Firebird)	£9.45	£6.45
Carrier Command (Rainbird)	£9.45	£6.45
Quarterback (Virgin)	£9.45	£6.45
Bangkok Knights (Activision)	£9.45	£6.45
Super Quintet (Infogrames)	£9.45	£6.45
Ballistix (Psychapse)	£9.45	£6.45
Eye of Horus (Logotron)	£9.45	£6.45
Rainbow Island (Firebird)	£9.45	£6.45
Operation Neptune (Infogrames)	£9.45	£6.45
Weird Dreams	£9.45	£6.45

## XENON TECHNOLOGY

71 Wadham Road,  
North End, Portsmouth,  
Hampshire, PO2 9ED.  
Telephone: (0705) 670878

**SPECIAL OFFERS!!** Any less and we'll be giving them away. "And why not?" I hear you ask. **Because we're not as stupid as the competition looks!!**

>	<b>zenon</b>	(zen', zen'on) a zero-valent element (Xe: atomic number 54), a heavy gas present in the atmosphere in proportion of 1:17 x 10E7 by volume.
>	<b>technology</b>	(tek'n-o-lo'ji) the practice of any or all of the applied science that have practical value and/or industrial use: technical method(s) in a particular field of industry.
>	<b>zenon technology</b>	(zen'on tek'n-o-l-lo'-ji) the best definition.

To order simply write on a piece of paper, your name, postal address a telephone number (if possible, only used if absolutely necessary), and the software title (with the machine model). Then pop in your payment (either a cheque or a postal order) and then pop it in the post (not forgetting of course our name on the front of the envelope and a stamp.)

VAT Registration Number: 543 9020 57

Proprietor: Steve Lowe

Note: Xenon Technology is Mail Order ONLY.

All products are dispatched within 24 hours (subject to availability) by FIRST CLASS post. All new titles are dispatched when released. All prices shown are fully inclusive of VAT, Postage, Packaging and a full guarantee (please add £1.10 per item overseas). Please make Cheques or Postal Orders payable to "Xenon Technology".



**AMIGA 500** 1meg upgrade colour stereo monitor, two external disk drives, Olivetti colour printer, computer table, zipstick, over 100 disks, books etc. many extras £850. Tel: Mr Gray 0253 406577.

**MICROTEXT** Teletext adaptor for Amiga A500, bought June 1989, £85 o.n.o. May swap for serious software or stereo amplifier. Phone Richard: 0474 327625. Gravesend, Kent.

**AMIGA** originals. Rocket Ranger, Dragon Ninja, Forgotten Worlds, Speedball £7.50 each. Bionic Commando, Wanted, Sidearms £5.50 each. All in Mint condition. Phone Staines (0784) 456858 inc P&P Silkworm £7.75 also.

**FOR** sale: Amiga A500, 1 meg external drive, software, disk box, joystick, mouse, workbench 1.3, etc. Excellent condition, hardly used, only 2 months old, guaranteed, boxed. Phone: (0474) 359837 £385.

**AMSTRAD** CPC464 colour, with Disc Drive, Multiface, Speech Synthesizer, Joystick, DMP3160, 70+ discs, 100+ tapes containing games, utilities etc. Must be £1000+ cost price, only £495, Nick, Brentwood (0277) 214094.

**C64**, disc drive, MPS 803 printer £180 or £60 each, also lots of software, games, business, utilities, backup cartridges at ridiculous cheap prices. Ring Stevenage 359183 evenings or weekends.

**CBM64** £500 worth of software, mouse

+ Music Maker £800 o.n.o. Call Andy 01 689 4686 (Daytime) 01 679 6242 (Evenings) Yo! Watch out for the N.H.S. and their new demo for some mega thrills!

**PCW** 8256 512K RAM, Interface, Mouse, DTP, Spreadsheet, DataBase, Covers, Manuals, Label Printer, Printer with paper, 24 discs, Batman Game, Tempdisc, Disc box, £350 o.n.o. (0277) 227333 anytime.

**ATARI** STM - 512K, mouse, 1 meg external drive - £150. Tel: 01 586 6155.

**TURN** your Commodore 128 into a WordProcessor, Calculator, and Mailing List, with Daisywheel Printer plus "Superscript" (30,000 Word Dictionary and Spelling Checker) £150 o.n.o. Phone 0243 860901 (after 6pm).

**COMMODORE** 64 disk drive, joystick, mouse, datasette, over 200 games plus magazines and books £190 o.n.o. Phone Locksheath 582298 after 6pm. (Soton).

**SEGA** games console, 10 games, light phaser, 2 joypads, 1 joystick. Games include Double Dragon, Shinobi, Afterburner. All boxed only £140. Tel: Chris on (0772) 717607 after 5pm. Ta!

**ST** software for sale. All original. Voyager, Heroes, Backlash, Gauntlet II, STOS, Home Accounts. Call Andy after 7pm. on (0204) 51984. The price? only £50! Come on down!

**AMSTRAD** 1512 DDM. PC compatible with some software and Juki Daisywheel

Printer £550 o.n.o. Ring Vic: 0227 374576.

**C64** tape games for sale or swap. All original incl. Uchi Mata, Colour of Magic. Write to: Chris Ward, 778 Obelisk Rise, Northampton, NN2 8TP.

**FAST** Basic (disk) and STOS for sale. Boxed, never used, £50 for both or will split or swap for GFA V3. Phone 027 581 5496 after 6pm. 23 Skidoo.

**800** channel hand held 142-149 MHz, covers two metres, Sim/DUP for Amiga or will sell Pro 2021 Scanner 200 channel, less than six months old for Amiga. Tel: Derby 760353.

**SEVEN** top Amiga games ie. Kult, Populous, Conflict Europe. All £40 also Amiga programmers' handbook and Amiga machine language £25. Phone 021 552 6012. Ask for Michael.

**SPECTRUM** +3 £130, under guarantee, Multiface 3 £35, 2nd 3" drive £40, software pack £25, Tech Tape, Serious stuff, machine code books, Devac, Tasword. All mint condition. Phone 0226 742413.

**C64** games for sale. Contact R. Donaghey, 23 Melmount Gardens, Strabane, Co. Tyrone. N. Ireland. BT82 9EB NOW!!!

**CBM** 64, Disk Drive, Datasette, Printer, Joystick, LightPen, 120+ Original disks including games, business and utility software. Only £350 o.n.o. Tel: (0238) 562310.

**VIDEO** camera, Panasonic 1410, Black/White, new tube fitted and set to full spec, internal and external sync as new, with lens £50. Dave after 7pm 061 798 0456.

**PRINTER** Shinwa CPA80 Dot Matrix inc. Lead £70, Spectrum 48K Printer, paper, Tape Deck, I/O Port, Digital Tracer, ZX81, I/O Port, £125. Ring John, evenings 6-9. 0268 552044.

**NINTENDO** control deck plus 6 games. All boxed. All literature. £160. Phone 051 526 8723.

**C64:** 1541 Disk Drive, Modem, Cassette Deck, Robot and Interface. £400 games Geos, 14 discs etc., £30 books. Will split. All boxed. S.A.E. Gordon Dunlop, 10 Lisdoonan Road, Carryduff, Belfast.

**ATARI** STFM, only 3 months old, 1 meg drive built-in, with 30 software titles worth over £1000, with many extras, sell for £350. Phone Nick on 0545 580671. Hurry!

**LOOK!** CBM64 Midi Interface, Sound Enhancer Keyboard, Sampler, 2 Data Corders, 2 Power Supplies, £500 originals, worth £800, selling £90! Yep! Write: Travis, 52 St. Aldwyn Road, Tredworth, Gloucester, GL1 4RL. Buyer must pick up.

**BBCB** 1.20S, Tape Recorder, Games, Utilities, Books, sell for £200 and Speccy games for sale: R-Type, NZ Story, Robocop, Ringwars, loads more from 75p to £4. Tel (Mat) Buckhurst Hill,



**ASTECH COMPUTER ENTERPRISES PRESENT A CHALLENGE TO TRY + BEAT PRICES ON ANY COMPUTER ITEMS.**

**ACCESS**



**AMSTRAD**

apricot

**Tandon**

**ZENITH**

**EPSON**

**NEC**

**THE STAR**

**FREE DISK BANK FOR ORDERS OVER £250**

**OCTOBER/NOVEMBER SPECIAL OFFERS.**

**OCTOBER/NOVEMBER SPECIAL OFFERS**

PHONE NOW AND ASK FOR DETAILS OF ALL OUR PC'S, PRINTERS PERIPHERALS & CONSUMABLES.

**AND LOTS MORE RING NOW FOR BARGAINS!!**

**PHONE NOW.**

**PHONE NOW TO ORDER ON 01 903 7945 (3 LINES) FOR THE BEST DEAL!!!**

**OPEN MON-SAT 9.00AM-6.30PM**

\* On-site maintenance Available on most products \* Subject to availability. Prices can change All cheques made payable to

**ASTECH COMPUTER CONSULTANTS**

Address: 25 Braemar Avenue Wembley, Middlesex HAD 4QW

\* All prices exclude VAT & Delivery.

**STAR LC10 Multifront .....£139.00**

**STAR LC10 Colour .....£185.00**

**NEC PC+ (24 PIN) 80C.... £393.00**

**NEC P7+ ..... £523.00**

**NEC P2200 ..... £239.00**

**Olivetti Laserjet II**

**(HP Laserjet II rebadged £1279.00**

**Amiga 500 .....£319.00**

**Apricot ZEN-S PC386**

**With VGA colour monitor £1599.00**

**Timeworks desktop ..... £84.00**

**SONY 3 1/2" DS/DD(+2) .. £12.00**

**VISA**

Essex, 505 9074.

**ISSUES** 1-13 "ST Amiga Format" (with discs) £20, ST: Super Pack (New) £30, Falcon £10, F-16 £10, Degas Elite £8, Millennium £8. Ring 046 276 358.

**BARGAINS!** Commodore 1541 Disk Drive and Software am asking £120. Star Colour Printer for £200 (Both for C64). Magazines also, details phone Joseph after 5pm. Tel: (01) 643 1312. OK!

**APRICOT** F1 512K, 720K Single Drive, Mono Monitor, Lan Card, Leads, Manuals, Accessories, Software: GEM, Super Series, Turbo Pascal, Activity, Diary Wordstar, Basic, lots more. £280. Tel: 0580 753436.

**APPLE** IIE+ 2DD Monitor 80 column language, Pal & Serial Cards plus Manuals & various software, offers around £280. (0703) 613918.

**COMMODORE** 128, Disk Drive, much software, all original. Full size Polyphonic Keyboard, Backup Cartridge, Joystick, all Manuals and leads, Diskbox and Disks £320. Tel: Mike, Milton Keynes, (0908) 674316 evenings.

**AMIGA** Crazy Cars, Technocop - £5 each. Also wanted - Penpals, C64 5 1/4" Drive, Contact: Pete, 15 Milford Close, TonTeg, Mid Glam. CF38 1HG. Yo Tich, Boon, Daz, Baz, Kosta!

**FOR** sale. Spectrum +3, Multiface+3, Tandy DMP 106 with cable, lots of software inc. Masterfile, Tasword +3, Taspint, approx 20 disks, joysticks inc. 1 year old, £250 o.n.o. Tel: (0506) 855247.

**ORIGINAL** Amiga and ST software. Many titles only £5 each. Tel: 091 3889537.

**ATARI** 1 Meg external Citizen drive £60, Data Chat Modem with lead and software for Atari £80, new. Steve after 7 (051) 526 0235.

**INTER-WORD** for the BBC B, B+, B+128, Master Wyswyg, WordProcessor in box as new £25.00. Tel: (0534) 75841. S. Shield, 3 Dorset Mews, St. Helier, Jersey, C.I.

**SPECTRUM** games for sale. 33 tapes inc. Trivial Pursuit and A New Beginning, The Gold Collection and Block Busters, £30 the lot. Phone Mark on 0272 826477 after 5pm.

**MICRO** Vitec hi-res colour monitor £160. WS2000 Modem £30. C64C boxed with games £110. Tel: 061 633 7892. Manchester.

**TASWORD** +3 and Arcade Muscle disks for sale, includes Street Fighter, 1943, SideArms, Bionic Commandos, Road Blasters, Cost £40, sell for £20. Phone Mark on 0272 826477 after 5pm.

**ATARI** 800 for sale, plus XC12 Data Recorder, Conversational German, Invitation to programming plus more £60. (0394) 672149 after 6pm. P.S. Mega Alien Rules.

**C64**, Cassette Unit, Carrying Case, Freeze Frame, Backup Utility, Joystick, Reset Switch, £300+ software, all originals, books and magazines worth £450+ want £200 o.n.o. Phone Dave

0443 491531 after 6pm.

**AMIGA** 500, Panasonic KXP1081, Paper, Amplifier with two speakers, 200 disks with boxes, Joysticks, 68000 ML books, Dustcover, 8 months old. £500 o.n.o. Tel: Martyn on 0639 884084.

**ATARI** ST (1/2 meg drive), Mouse, Joystick, £900 Software excellent condition. Best offer secures. Also IS Sound Sampler £45 immaculate. Tel: (01) 739 7949.

**QL** computer disk interface CST Disk Drive, Philips Monitor, Manuals, Mags all in excellent condition £200. Tel: 0532 758292 after 7pm.

**AMIGA** 500 1.3 ROM, 1 meg + clock, 1081 monitor + stand, Canon 1080A printer. All as new £650. Basingstoke 781408.

**1050** Disk Drive, excellent condition, as new boxed with manuals etc. £85.00. Touch Tablet used twice, as new, £25. Your Computer mags free to first collector. Contact Grahame, 0203 311670.

**SPECTRUM** Tape software, all original boxed and Documented Gunship, Acrojet, Monopoly, Trivial Pursuits, Animator, Silent Service. Any two for £10. Tel: Andy on 041 881 5429 for details.

**MONITOR** Philips BM7502 Green Screen 80 Columns, lead, ideal for home computers W/P. Buyer pays postage, immaculate £30. (0642) 564982.

**MSX** Toshiba HX-10 computer, Data Corder manual, leads, box, software, ideal first computer, up-grade to MSX2 System forces sale, immaculate £45 including postage. (0642) 564932.

**ATARI** 520STFM Power Pack for sale cost £399. Will sell for £260 (3 months old, perfect condition) with software, joystick, manuals, mouse etc. Call Ian on 0241 74887.

**ATARI** ST (or Amiga) Sound Sampler Cartridge. Only £18. Also ST games: Virus £8, Silent Service £9, Spitfire 40 £5, Shadowgate £6 + others. Tel: 01 868 6028.

**STFM**, 1 meg Drive, loads games inc. Falcon, Mis. Disk, Virus, R-Type, Elite also Art Director, Books, Joystick. Tel: 0742 345145 £220.

**ST** Languages for sale. FTL Modula 2 £25. OSS Pascal £25. Both originals with manuals. Cash and collect. Birmingham 021 777 7302.

**AMSTRAD** CPC software all with original documentation. Brunword 6128 £15, Matrix Spreadsheet £15, Discbase £5. Also JVC Hc R105 Cassette Data Recorder and Joystick £15. Upgrade Ribbon for sale 036287 340.

**PRINTER** Brother R5 Centronics I/F only £35 also. Medium Resolution Monitor leads for ST QL Spec 128 £95. Mr E.M. Duffield, 54 Finsbury Close, Broadfield, Crawley, W. Sussex. RH11 9NR.

**COMMODORE** 64, Tape Deck, Disk Drive, MPS803 Printer, Joystick, over £250 of original software and books including Word Processor and Database. £275 o.n.o. Tel: 0253 591874.

**AMSTRAD** PCW 8512, hardly used, boxed, as new, plus dot matrix printer, plus WP software, £400 o.n.o. Tel: 0274 626165, evenings.

**CASIO** HT-700 programmable digital synthesizer midi in out LG. Keyboard, 40 rhythms, pitch bend take RAM cards, £130 still boxed. Tel: 0924 493633, West Yorkshire.

**COMMODORE** 64/128 computer modem, still boxed, £25. Some original software, £2 each. Tel: 0924 493633.

**DRAGON** \*059 originals £20 each. Other original software £3 each, American and British mags, £20 the lot, about 100. Tel: 0924 493633.

**XL** system 800XL with full set of brand new ram chips, 1010, XC12, Quickshot II Joystick, over £200 of software, all manuals partly boxed perfect condition, will deliver, £80 o.n.o. Tel: 0295 738738.

**130XE**, XC12, XF551, 850 interface, printer cable, trackball, proline joystick Quickshot II turbo joy, speaker system video cable, £600 of disk software and cartridges such as S.A.M. Brand New all boxed manuals, perfect condition, plus all mags, books and a years subscription to Atari Explorer in the U.S.A. Will deliver, £380 o.n.o. Tel: 0295 738738.

**AMSTRAD** 464 colour monitor, disk drive, Multiface 2, £250 of games, AA mags, 1 to 49, £425 or closest offer. Contact Ian after 6pm Tel: 0428 4840. 464 keyboard and modulator for £50.

**800XL** disc drive, data recorder approx 70 games, mags, books, £120 o.n.o. Tel: 0704 89411, after 6.00, Lancs.

**AMIGA** A500, including loads software, samplers, mouse mat, joystick, coder, boxed as new. Tel: 0923 670810, after 6 pm. Offers only (Watford Area).

**ATARI** ST, 1 Meg external drive, 1 Meg memory, Discovery Happy cartridge, 100+ discs. All manuals, joystick etc, £500. Call Alan on 0932 564552, after 6 pm.

**AMSTRAD** PCW 8512, unmarked condition, complete with software and Basic manual £275. Tel: 0268 697764 after 7 pm.

**AMSTRAD** PC2086, 32 Mb hard disk (Seagate) 14" colour VGA, some software, perfect condition, still boxed, £900 o.n.o. Tel: 0623 552942 and leave your name and number.

**ATARI** 1040 STF, SM124 monitor, Steinberg PRO24 V.3 plus lots of software, joystick, disk box. As new condition, £595. Tel: 0533 849368.

**1029** Atari Dot-Matrix printer, boxed as new. Atari Writer Word Proc Included. Excellent condition. Sell for £70 - offers considered. Phone (0248) 722960 After 6.30pm.

**MOUSE** PCW 8512 for sale Plus lots of 3" discs. D.T.P screen filter for PCW offers complete Darkroom swap for Amiga ring Neil 01 377 2638 A.6%

**DATel** Genie mouse, plus (Interface for Spectrum) boxed as new plus Icon

Graphics 128, Artist II, White Lighting, G.A.C Paint Plus, all Originals with documents the lot £50. 041 881 5429.

**AMIGA** software. Tetris, Wizball, Nebulus, Mercenary, Kings Quest 3, Helter Skelter, Gnome Ranger, Bionic Commando, Black Shadow, £6 Each. £45 the lot. 0353 661080.

**SEIKOSHA** GP700 Colour Printer and Colour Graphics Interface new and boxed £180 call Andy 437 0434 Ext. 2255 between 9.30 - 5.30.

**AMIGA** original games: Falcon, Operation Wolf, Strike Force Harrier, Fish! Elite, Rocket Ranger, Sword of Sodan. All Excellent condition will sell separately. Open to offers phone Richard 0245 41 4231.

**ELECTRON** games! 28 games, 4 Educational Programs including Spycat, Last Ninja, Bugeyes, Computer Hits 2, a total of 41 programs, worth over £100. £30 the lot! Phone evenings 021-3506635.

**OLIVETTI** M240, Green CGA Monitor, 20Mb hard disk, 360k floppy, 640k memory, as new with DBase3+, Ability, Wordstar, Norton, Lotus 123, Games etc on HD, £895 O.N.O tel (Evenings) 0763 249823.

**MUSICIAN** on Amiga and ST will write your music for your games or demos all I want is a good music routine written on the ST. Ring Justin 0244 - 318122.

**AMIGA** games 3D Pool, Rick Dangerous, Robocop more available. All Original latest titles only £10 each ring Phil 051 342 3226 after 6pm.

**OLIVETTI** prodest PC 1 single drive mono VGC 9 months old includes D/Base WP S/Sheet Comms games Pascal £575 Also Sega Master System 3D Glasses £120. 01 519 5916.

**QL** with 3.5" Disk Drive, Colour monitor, Centronics Interface, Books, Roms, Software, £350 O.N.O. TEL GUISLEY 0943 - 74651.

**SPECTRUM** +2 joystick PSU and 25 games on tape for £50 call Terry, 01 251 3769 after 5pm.

**AMSTRAD** 16405D Hi-Res enhanced colour (EGA) Western Digital 32 MB Hard Disk Drive, Maths Co-Processor £695. Epson DX100 Daisy Wheel Printer £60, Both good condition. Newport Gwent (0633) 25543.

**FOR** sale D100 P.L.C. programmable Logic Controller and L.C. Programmer 20/1/0 Unit Brand New + Ladder program for IBM PC/XT/AT Compatibles computers cost new £700 + sell £300 Details 061-633-0824.

**AMIGA** software. Gold Hints, Capt Blood, Corruption, Deja Vu, Guild of Thieves, Red October, Jinxter, Knight Orc, Mind Fighter, Pawn, Portal, Station Fall, £7 each. £70 the lot. 0353 661080.

**P.C.** Engine games to swap, I have "Overhauled Man" and "War of the Dead" what have you got phone (0306) 885 003 swaps only.

**SEGA** games console, 10 games, light

# AMIGA SUPERMARKET

### EXTERNAL AMIGA DRIVE

- ★ 3.5" 880K FORMATTED
  - ★ ON/OFF SWITCH
  - ★ THROUGH PORT
  - ★ SLIMLINE STEEL CASE
- FOR A500/1000/2000 **£79.99**

### MODEMS — FREE CABLE

- DEMON MODEM + FREE A500 CABLE **£102.99**
- DESIGNER MODEM + FREE A500 CABLE **£113.85**
- PACE LINNET MODEM + FREE A500 CABLE **£174.99**

### MONO & STEREO DIGITISERS

The best sounding (sample rates upto 70KHz), lowest priced (ready built & tested) AMIGA sound digitisers on the market AND compatible with a big range of sampler Software eg AUDIOMASTER I & II, PERFECT SOUND, SONIX, FUTURE SOUND & others. Complete with audio input lead for connection to personal stereos, radios, keyboards etc.

#### FREE 'SOUND WORKSHOP' DISK

- A500/2000 MONO DIGITISER **£27.99**
- A500/2000 STEREO DIGITISER **£37.99**

### MINIAMP 2 STEREO SPEAKER SYSTEM

The AMIGA has the best stereo sound around — hear it through our MINIAMP 2 stereo speaker system. Two neat self contained, speakers & built-in stereo amplifier + handy remote volume control. Powered for the AMIGA (mains power pack optional). Complete with all leads — just plug-in & switch on.

- MINIAMP 2 FOR A500/2000 **£19.99**
- MINIAMP 2 FOR A1000 **£19.99**
- OPTIONAL MAINS POWER UNIT **£5.99**

### MIDI INTERFACES — FREE MIDI LEAD

Connect any Midi instrument to your A500 or 2000 with our low cost MIDI INTERFACES. Compatible with all AMIGA MIDI SOFTWARE. Just plug-in — no extra software, batteries or power supplies needed.

MIDI 1 has IN THRU & OUT sockets. MIDI 2 has IN THRU & OUT sockets + two unique separately switchable out thru sockets for added versatility with additional Midi instruments & sound expanders.

- MIDI 1 + FREE LEAD **£29.99**
- MIDI 2 + FREE LEAD **£34.99**
- EXTRA MIDI LEAD 5m **£4.99**

### TRILOGIC TV & MONITOR LEADS

- AL1 — AMIGA TO SCART TV OR MONITORS **£10.99** mono or stereo, inc Sony, Philips, Toshiba etc.
- AL2 — AMIGA TO FERGUSON 7/8PIN DIN **£10.99** inc MCO1, MCO5.
- AL4 — AMIGA TO HITACHI 7 PIN DIN **£10.99** inc Granada with RGB input.
- AL6 — AMIGA TO AMSTRAD CPC COLOUR **£9.99** monitor with 6 pin socket. No audio lead.
- AL11 — AMIGA TO MULTISYNC MONITOR **£9.99** with 9w 'D' socket. No audio lead.

**MANY OTHER TYPES AVAILABLE.**  
All tv/monitor leads include audio lead except where stated, give all 4096 colours & are approx 1.5m long

LONGER LEADS TO ORDER **£4.99 EXTRA ANY LENGTH**

### MONITOR SHARERS

Want to use two computers (or 1 computer, 1 VCR) with one Tv or monitor? NO MORE lead swapping if you connect our MONITOR SHARER switch. Your existing leads plug-in to Sharer, & lead from Sharer connects to tv or Monitor. Push button changeover switch can be used at anytime.

- FOR SCART TVs & MONITORS **£15.99**

### MOUSE JOYSTICK SWITCH — NEW IMPROVED MODEL

A must for AMIGAS & STs — no more groping round the back, wearing out the mouse port or risking damage by not powering down before unplugging. With our Mouse/Joystick switch connect both & just push a button anytime to select which ever is needed — even when powered up.

- MOUSE JOYSTICK SWITCH **£12.99**

### PORT SHARER

Our neat PORT SHARER switch has TWO Amiga compatible 25w female 'D' sockets for printers, & audio/video digitisers. Push-button changeover switch. Amiga cable included. **FREE CABLE** FOR A500/2000 & STs etc. **£20.99**

### MINIAMP 4 STEREO SPEAKER SYSTEM

Offers more power & louder speakers, with mains pack included. Separate 4 watt per channel amplifier, speakers / headphone socket + 4" dia twin cone heavy duty speakers.

ALSO FOR USE WITH ST, ARCHIMEDES, SPECTRUM + & SATELLITE TV RECEIVERS ETC. FOR A500/1000 /2000 **£34.99**

PLEASE ENQUIRE FOR OTHER APPLICATIONS.

### MINIAMP 5 STEREO SPEAKER SYSTEM

The ultimate 3 way MINI HI-FI BOOKSHELF SPEAKERS in solid alloy enclosure. Separate 5 watt per channel amplifier, speakers / headphone socket + Mains power unit & connecting lead.

ALSO FOR USE WITH ST, ARCHIMEDES & SATELLITE TV RECEIVERS ETC. FOR A500/1000 /2000 **£69.99**

(SPEAKERS ALONE SOLD ELSEWHERE FOR £59.99)

PLEASE ENQUIRE FOR OTHER APPLICATIONS.

### DISK DRIVES

### DUST COVERS — DON'T LEAVE IT EXPOSED!

- A500 **£5.49**
  - A2000 — 2 COVERS **£9.99**
  - 3.5" EXTERNAL DRIVE **£4.99**
  - CM8833/6852 MONITOR **£6.99**
  - 1084/S MONITOR **£6.99**
  - CITIZEN 120D **£5.99**
  - STAR LC10/LC10 COLOUR **£5.99**
- Flame retardant antistatic PVC

**LOW PRICES! FAST SERVICE!**

**GOOD RANGE OF AMIGA SOFTWARE STOCKED AT DISCOUNT PRICES — DETAILS IN OUR FREE CATALOGUE.**

### HOW TO ORDER

- 1) To use this ad as an order form — tick the box next to the items you wish to order, add any carriage charges (see below), fill in coupon, send in the whole page with payment or quote Access or Visa number & expiry date. A new copy of the ad + our catalogue will be sent with your order.
- 2) Or write out your order + name & address on a separate sheet if you wish.

- 1) Orders under £1500 — please add 75p
- 2) Orders over £1500 post free
- 3) Optional express delivery — add £1.99 for small orders; or £5.00 for carrier delivery on computers, monitors, disk drives, printers. \* FREE CARRIER DELIVERY ON ORDERS OVER £500 \*
- 4) Export orders despatched daily — add £1.99 extra for surface mail or £3.99 for airmail.

SAVE £1 BUY A DISK BOX PLUS ANY PACK OF DISKS AND DEDUCT £1

- ### DISK BOXES
- 3.5" 40/50 DISK BOX **£8.49**
  - 3.5" 80 DISK BOX **£9.99**
  - 3.5" 100 DISK BOX **£11.99**
- Lockable, smoked lid, antistatic

### SONY DISKS

- 10 for **£12.99**
  - 25 for **£28.49**
  - 50 for **£55.99**
  - 100 for **£99.99**
- 3.5" Ds/dd guaranteed plus FREE labels.

**A500 RAM EXPANSION**  
★ 512K RAM  
★ ON/OFF SWITCH  
FOR A500. ONLY **£89.99**

**ALL PRICES INC VAT**

### TV / MONITOR OFFERS.

BRAND NEW TELEFUNKEN PORTABLE TV / MONITOR.

- 14" SCREEN
- FULL REMOTE CONTROL
- SCART SOCKET
- FREE LEAD - AMIGA or ST HEADPHONE SOCKET

### BARGAIN PRICE - ONLY £229.99

inc vat, lead & delivery. Carrier delivery £5.00 extra. Hurry limited stocks. 15 & 17" FST models also available - phone for price.

### COMPUTERS, PRINTERS, MONITORS

- ALL PRICES INCLUDE VAT & DELIVERY
- AMIGA A500 BATMAN PACK **£389.99**
  - C64 XMAS PACK **£144.99**
  - OC118N D/DRIVE FOR C64 **£118.99**
  - CITIZEN 120D PRINTER **£138.99**
  - STAR LC10 PRINTER **£169.99**
  - STAR LC10 COLOUR **£214.99**
  - STAR LC24-10 24 PIN **£295.99**
  - STAR NX15 (WIDE CARRIAGE) **£329.99**
  - PANASONIC KX-P1081 **£169.99**
  - PANASONIC KX-P1180 **£194.99**
  - PANASONIC KX-P1124 24 PIN **£315.99**
  - PHILIPS CM8833 14" STEREO COLOUR MONITOR, FREE LEAD **£219.99**
- ALL PRINTERS & MONITORS SUPPLIED WITH LEAD — PLEASE STATE COMPUTER + FREE CARRIER DELIVERY ON ORDERS OVER £500 \*

### PRINTER & MODEM LEADS

- AMP1 — A500 PARALLEL PRINTER CABLE 1.5m **£6.99**
  - AMP2 — A500 PARALLEL PRINTER CABLE 3.0m **£9.99**
  - NM1 — A500 — A500 NUL MODEM CABLE 1.5m **£7.99**
  - NM2 — A500 — A1000 NUL MODEM CABLE 1.5m **£7.99**
  - ML1 — DEMON & DESIGNER A500 MODEM LEAD **£9.99**
- A1000 types also stocked.

### USEFUL ODDS & ENDS

- REPLACEMENT MOUSE — FOR AMIGA, ST, AND C64 **£29.99**
- MOUSE MAT - A4, NON SLIP, RED OR BLUE **£4.99**
- EXTERNAL DRIVE SWITCH FOR DF1 — NO EXPOSED PARTS **£8.99**
- 4 JOYSTICK ADAPTOR FOR 4 PLAYER GAMES **£8.99**
- MODULATOR SPLITTER — CONNECT RGB LEAD & MODULATOR... **£15.99**
- MODULATOR EXTENSION LEAD APPROX 6" LONG **£8.99**

### OTHER PERIPHERALS

- MINGEN — GENLOCK FOR A500 **£109.99**
- VORTEX 40 MB AUTOBOOT HARD DRIVE **£529.99**
- COMMODORE A590 20Mb H/DRIVE **£389.99**
- DIGIVIEW GOLD COLOUR VIDEO DIGITISER **£139.95**
- B/W VIDEO CAMERA — HIGH QUALITY BY HITACHI **£239.99**

NAME .....

ADDRESS .....

TEL. NO. ....

EXPRESS DELIVERY £1.99  or £5.00

EXPORT DELIVERY £1.99  or £3.99

GOODS TOTAL £ : :

CARRIAGE TOTAL £ : :

TOTAL ENCLOSED £ : :

CARD No. ....

EXPIRY DATE .....

SIGNED .....

Address given above must be cardholders address.

**PROMPT DESPATCH**  
**FREE CATALOGUE**  
**CALLERS WELCOME**

**TRILOGIC** (Dept NCE)  
Unit 1  
253 New Works Road  
Bradford BD12 0QP

Fax 0274 600150

**FAST MAIL ORDER**  
**PROMPT DESPATCH.**  
TELEPHONE ORDERS:  
**0274 691115**  
5 LINES

**ENQUIRIES**  
**0274 678062**

Phaser, 2 Joypads, 1 joystick. Games inc Double Dragon, Shinobi, Afterburner. All boxed only £140 tel Chris 0772 717607 after 5pm.

**FOR** sale: Quattro Modem external no software instructions hence £450 O.N.O virtually new. IBM Dos-4.00 (3.5 Diskettes) shrink wrapped still £50 ONO. Call Raj on 01 571 2867 after 7pm.

**QL(JS)** 640K. 2x720K 5.25" Epson DD/DS disk Drives. Internal QIMI Mouse. SER/PAR Converter. Spare PSU. Software, Psion V2.35, Qram, QPointer, 20xMDVs 30 Disks. User/Tech guides. Perfect. £300. Tel: 01-889 - 4276 Tottenham.

**XEROX** 4020 Colour Inkjet with extra paper, Ink. Amazing results from the best Amiga Printer £725 O.N.O also Digi View System £260 call 0787 74860 after 5pm for details.

**AMIGA** Originals World Tour Golf, Capone, 3 Stooges, Interceptor, Strike Force Harrier, Hostages, Mortville Manor, Defender of The Crown. A Bargain at £40 the lot. Tel Ian on Bristol 613173.

**COMMODORE** Plus/4 Data Recorder Tapes. Electron many titles. T1-99/4A offers all or parts manuals for Plus/4 and Electron included phone 0942 813795 (Lancs).

**SEGA** in excellent condition with 27 games eg. Altered Beast, Rastan, Vigilante, Rampage, Time Soldiers, R-Type, with control pads and Konix joystick sell for £200 phone (0254) 53195 After 6pm.

**GLP** D/Matrix S/P Printer Tractor C/Roll units. Best offer secures. Buyer collects, pays car.. Also Spectrum Kempstone I/Face B.O.S. TEL George 0322 69897.

**AMSTRAD** CPC 464 with Green Monitors, Perfect condition, boxed, with manual, books, games, Mini Office 2, (seldom used), Guaranteed, £130 inc. postage/insurance. Stuart Miller, 53 Albert Street, Edinburgh.

**AMSTRAD** CPC6128 with Colour Monitor, Joystick, Speech ROM, Tape Recorder, Dust Covers, Blank Discs, Discs Box, Manuals and Software £230, Ring Andy for details 04022 23092.

**OKI** Micro Line 192 Printer for sale good condition, fast quality printer with multi Fonts cost £395 quick sale £150. Ideal for small business and word processing. Phone 01 788 3708.

**CBM64** for sale, joysticks hardly used for £160, Sega Master System with 2 games control pads for £65 Together £220 or will swap for Amiga A500 phone 0633 894 673 after 5pm.

**C64** original disk Super Star Ice Hockey with instructions by Mindscape only £4.50. Jack Diamond, 18 Walker Road, Ayr, Ayrshire, Scotland. KA8 9LB.

**AMIGA** 500+ External Drive + Modulator, + 2 joysticks, 160+ disks of software, disk boxes, mags, mouse mat, boxed as new, mint condition, valued at £3500+, offers £390 +, Tel: 0273

502281, 6pm - 10pm.

**240V** to 110V voltage converter suitable for computer equipment, 1000W for sale, £50 O.N.O., also 240V mains conditioner unit, £50 O.N.O Tel (0733) 73168 Evenings.

**BROTHER** M-1009 Pin Dot Matrix Printer Pin Feed Unit £55 O.N.O Phone Exeter 58813 after 8pm.

**SWAP** over 100 31/2" disks most with Amiga PD for best C64 or CR8 Deal offered Tel: Lee (0778) 347616.

**SWAP** NEC Amiga second Drive for best C64 or C128 deal offered Tel: Lee (0778) 347616.

**SPECTRUM** 128 + 3 + 10 discs + Multiface 3 £150. Phone 0253 886601 Blackpool Area.

**SPECTRUM** + , Power Pack, joystick, Interface and loadsa games, mint condition, business software, Word Processor, etc. £100 ideal Xmas gift. Write to S. Shaw, 50 Tarnbrook Drive, Blackpool, Lancs, FY3 7QA.

**AMIGA** 500 for sale three weeks old, 11 months guarantee, mod; Comp Pro joystick 14 games inc. Beast, Great Saving on new price £330. Tel: Cardiff 0222 551418.

**SPEC** 128 + over £600 of games, very good condition. Games all originals. I'm open to offers. Phone 664085, ask for Marcus between 4 & 6 most days.

**CASIO** C2 101 Synth with case, Stand, Two RAM Packs, PSU, Midi leads and super conductor ST software £170 ONO buy it now! Ring Dave Leeds 691 532.

**COMMODORE** 64 and Datasette. Over £300 of software and utilities all original and boxed in excellent condition. £150 ONO Tel Blackpool 0253 64386 Preferably after 6pm.

**ATARI** 520 STFM with over £300 of games ie. Robocop, Dungeon Master and Casio HT700 Digitizer MIDI keyboard, all for only £360 O.N.O Tel Leeds (0532) 736942.

**ATARI** STFM 10 months old, one Mega Drive, some software, mint condition £270 phone 0908 377029 Evenings or weekend Bucks.

**BBC** Master 512 Dos+/Gem 51/4 " , 31/2" Drives, Colour Monitor, AMX Mouse, Stop Press, Extra Extra, Morley Romboard Beebug, Master Rom, Double Console, Typing, Joystick, Manuals, Games, etc, 1 year old as new £725 ono. Phil 0980 6103030 evenings/weekends.

**AMIGA** software boxed as original, Power Drome, War in Middle Earth, Def Con 5, Chuckie Egg, Speedball, Thunder Blade, £7.00 Each or £35 the lot, buyer collects. Tel Bob 01-949-0240 New Malden Surrey.

**ATARI STFM** 1/2 meg Drive with original software and free disks. Can deliver Scotland. £200 phone 0250 5108.

**COMMODORE** 64 Cassette Unit Leads

etc, Manuals, Joystick, Music, Keyboard, overlay with Music Master Program, 40+ Computer mags, over £250 worth of games will accept £195. Phone Junior on (01) 749-5698.

**ATARI** 520STFM Explorer pack, 1 meg Drive, only £260 N.O. Tel (091) 5142927 (games included).

**COLOUR** Monitor Fidelity CM14 with Anti Glare Filter £100. Also Amstrad DMP 2000 Printer (Dot Matrix) with 8K Buffer installed £100 Phone Bill (0265) 57100.

**ART** Studio by Rainbird for Spectrum boxed as new with Manuals only £4.50 best ever Speccy Art package. Tel 0305 783506. Ask for Ian.

**ATARI** 520 STFM Super Pack with Philips 8833 monitor plus Siilca Starter pack as new, hardly used, original package available. Ideal Xmas gift, cost £630+ sell for £450. 0902 416561.

**16** Spectrum games all for £30. Include Robocop, R-Type, Afterburner, Combat School plus many others. Sorry will not separate. Phone 685 0277 and ask for Wilton. Need PC engine contacts.

**SPECTRUM** + 48K tape recorder, over 80 games, joystick, printer, colour TV (needs repairing) - £95 buyer must collect Tel (0782) 515964.

**FOR** sale: Outrun Electronic game with steering wheel and gear stick, includes realistic sound effects and 5 exciting races. Cost £35, sell for £20 Exl cond. Tel (0782) 515964.

**OCEANIC** OC-118N disk-drive! Barely used, good looking reliable, quiet. (Forget that 1541 Racket!) only £70! One chance only! Call Chris (evenings) on (0274) 582716. Hurry before I sell it!!

**CITIZEN** 120D Printer! Only £50 without Interface £75 with CBM 64 Interface! (Will work with other Computers if relevant, Interface bought separately.) Superb condition! (Call Chris Evenings only (0274) 582716.

**ATARI** internal half meg drive and control board. Two months old. £20 only. Phone 05337 09314 evenings price includes postage. Hi! to Skexis and Grongo.

**SPECTRUM** + 2, mouse, joystick, over £500 games, loads of mags. V.g.c £200 ono. Tel: (0252) 725278 after 6pm.

**AMIGA** 68010 CPU for sale. Can't install in my machine as warranty will become invalid. £50 ono. Phone Paul on Bristol 652759 after 5pm weekdays only. Buyer collects.

**ATARI** STFM 1 meg internal drive for sale £60. Tel 0904 791067.

**AMIGA** 500. 10 months old, with £380 of software (not 10 star pack). 10 blank discs, dust cover, mouse mat, books, £395. Buyer collects or pays postage. Bargain 0353 661080.

**ATARI** 520STFM 1 meg ram 720K internal drive, software, books, mags. £350 ono. Phone (0226) 240790 evenings.

**CPC** 464 and colour monitor under guarantee with £100 of games. Exc. working order £230 ono. 0322 78239, Dartford.

**SPECTRUM** PLUS 3 for sale. Joystick adapters/interface, £30 of games and ten blank discs. In excellent condition, hardly used. Bargain at £150. Buyer collects. Phone Mike - 051-677 1581.

**MPS** 1200 printer, friction/tractor feed NLQ and draft, serial cable for 64/128 purchased in error. Brand new worth £200. £150 ono. Call 0795 426557 evening and weekends. Phil.

**BARGAIN** 64/128 Commodore 1541 d/drive + DOS cassette disks, manuals, loads of extras. Sale due to upgrade to Amiga only £280 buys the lot. tel: 061 688 4209 after 6pm. Manchester.

**RARE**, collectable, one Newbrain 32k computer, complete PSU's, leads, manual, software £50. One Aquarius, 16+16K computer, PSU, software manual, complete £50. + VIC20/ZX81 parts, ST books, various software. 0743 249194.

**ATARI** XF551 D/S 360K disk drive new, under warranty, boxed, little used, immaculate, with 3x boxes disks, manuals, cost (total) £190. Sell £95. (only five months old!) Phone 0743 249094.

**AMSTRAD** CPC464, colour monitor, games and software worth over £700. mags, joystick, inst. book, perfect condition. Bargain £240. Phone Luton 0582 410228 after 5pm.

**AMIGA** 500 1.3 rom 1.meg + clock. 1081 monitor + stand. Canon 1080A printer. All as new £650. Basingstoke 781408.

**SEGA** master system includes five top games and two control pads. All for £125. Tel: 0245 329600

**AMIGA** 500, external drive, CM8833 monitor, WP, database and spreadsheet software, plus games. excellent condition £500 the lot. No split. Phone Ian (0427) 880364.

**FOR** Seikosha GP-50S, 2 ribbons and 3 rolls of 5" paper. Brand new. Never been used due to printer breaking down. A tanner the lot. Phone Gary on (0604) 863191.

**AMSTRAD** CPC 464, monitor, over £300 worth of software, drum machine and kits all worth over £600, will sell the lot for £160. Tel: 0245 329600.

## ● HELP WANTED

**PROGRAMMER** Wanted to develop with Atari ST Medieval game. Send demo or phone (0244) 821484, Justin, 14 Hawthorne Ave, Connahs Quay, Deeside, Clwyd, CHS 4TF, Serious programmers only, no fakes!

**HELP** wanted: does anyone know how to crack a Nimbus Net Work? Write to: Chris 73 Hillbrook Rd, London SW17 8SF.

Always

Reasonable

Reliable

And

No Fuss

COMPUTERS

AMIGA A500

Includes TV Modulator, mouse.  
10 Star Pack + Photon Paint  
RRP £339.00  
OFFER PRICE.....£375.00

AMIGA A500 BATMAN PACK  
Includes Batman The Movie,  
New Zealand Story, F18  
Interceptor, Deluxe Paint II, TV  
Modulator  
RRP £399.00  
OFFER PRICE.....£375.00



ATARI 520 STFM POWER PACK  
Includes 20 games, music  
software, business organizer,  
Hi-Soft basic  
RRP £349.00  
OFFER PRICE.....£349.00



ATARI 520 STFM EXPLORER  
PACK  
RRP £299.00  
OFFER PRICE.....£269.00

AMSTRAD PCW  
PCW 9512

+ Daisywheel printer  
Plus Free Auto Sheet Feeder  
RRP £573.00  
OFFER PRICE.....£516.00

BUSINESS SOFTWARE

FULL RANGE OF MAP  
ACCOUNTING SOFTWARE FOR  
IBM/AMSTRAD PC AND  
AMSTRAD PCW

- Credit card 24 hour facility
- Credit cards not debited until goods dispatched
- Offered subject to availability and price change
- Same day despatch on stock items
- Amstrad authorized business dealer
- Ring for price lists
- Large selection of games on most formats



MONITORS

PHILIPS CM8833

Colour Med-res  
RRP £299.00  
OFFER PRICE.....£225.00  
Includes lead ST/Amiga  
Please state which

ATARI SM124

Mono hi-res  
RRP £149.00  
OFFER PRICE.....£99.00

DISK DRIVES

AMIGA

1Meg 3.5" Slimline  
daisychainable, disable switch  
OFFER PRICE.....£74.95

ATARI ST

1 Meg 3.5" Slimline  
OFFER PRICE.....£69.95

UPGRADES

A501

1/2 Meg upgrade with clock card  
RRP £149.99  
OFFER PRICE.....£129.00  
1/2 Meg without clock.....£79.95  
1/2 Meg with clock.....£89.95

PRINTERS

CITIZEN

CITIZEN 180E 9 PIN DMP  
Draft 172 - NLQ 35 Friction 1  
tractor feed  
RRP £299.00  
OFFER PRICE.....£165.00

CITIZEN SWIFT 24 PIN DMP

Draft 192, LQ60, Friction/  
tractor feed  
RRP £441.00  
OFFER PRICE.....£299.00  
Price includes Amiga ST/PC lead, 2  
year warranty

STAR LC10 9 PIN DMP

Including Lead  
£169.00

STAR LC10 COLOUR PRINTER

Including Lead  
£210.00

IBM/PC COMPATIBLE

AMSTRAD PC  
PC 1512

SD MONO.....£442  
DD MONO.....£549  
SD COLOUR.....£569  
DD COLOUR.....£639

PC 2086

(Includes Lotus Symphony)  
SD MONO.....£649  
DD MONO.....£729  
HD MONO.....£935  
SD COLOUR.....£755  
DD COLOUR.....£835  
HD COLOUR.....£1,039

PHILIPS PC  
PC2086

12" HI-RES COLOUR  
SD £859 - DD £935 - HD  
£1,145

14" HI-RES COLOUR  
SD £959 - DD £1,039 - HD £1,249

PHILIPS PC  
NMS 9110 + BM 7913

2 x 3.5 "Meg disc drive, 768K  
RAM, MS DOS 3.21 HI-Res  
Mono Monitor  
OFFER PRICE.....£675.00  
RRP.....£803.00

PHILIPS PC  
NMS 9110 + BM 7913

1 x 3.5" disc drive + 20 Meg  
hard disc + Hi -Res Mono Green  
OFFER PRICE  
12" Mono RRP £918.....£833  
14" Colour RRP £1,035.....£950

SCHNEIDER EURO PC

Mono System, entry level PC,  
includes Microsoft works, integrated  
package VALUE £166.00  
1 x 3.5" disc drive, mono monitor,  
Amber  
OFFER PRICE.....£450.00

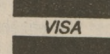

A  
R  
R  
A  
N

A  
R  
R  
A  
N

A  
R  
R  
A  
N

A  
R  
R  
A  
N

STATE  
MAKE AND  
MODEL OF  
COMPUTER

Mail Order Send Cheques/PO to:  
**ARRAN COMPUTERS**

17A LOWER HILLGATE, STOCKPORT  
SK1 1JQ  
TELEPHONE 061 480 3975

PRICES INC. VAT  
P&P FREE UK ONLY  
OVERSEAS ADD £3.00  
RECORDED DELIVERY £2.50

# ULTIMATE COMPUTERS

If you think you've tried the best... Try the ULTIMATE

Authorised Computer Dealers for AKHTER, AMSTRAD, EPSON, COMMODORE, HYUNDAI, OPUS, SHARP, MITAC, SCHNEIDER, All Products listed below carry a minimum 12 months return to base manufacturers warranty. Please call for Optional ON-SITE-MAINTENANCE

The Largest Selection of Computers by Mail Order in the UK

## AKHTER

MODEL	MON	COL	EGA
PC1000-8088 512K S/D	499	799	
PC2000-8088 640K HD20	799	1079	
PC100-8088 640K S/D	499	799	
PC100-8088 640K HD30	759	1025	
MINI-S 640K S/D	479	779	
MINI-D 640K D/D	499	799	
MINI-H 640K HD20	899	1199	
AT286-10 640K S/D	799	1099	
AT286-10 640K HD30	1099	1359	
AT286-16 1MB S/D VGA		1399	
AT286-16 1MB HD40 VGA		1759	
AT386-16 1MB S/D	1199		
AT386-16 1MB HD40	1549		
AT386-20 4MB S/D VGA		2229	
AT386-20 4MB HD40 VGA		2559	
AT386-20 4MB HD80 VGA		2999	

## SCHNEIDER

MODEL	MON	COL	EGA
EURO PC	379	521	
EURO AT 512K S/D	759	949	
EURO AT 512K D/D 854		1091	
EURO AT 1MB S/D 854	949	1091	
EURO AT 1MB D/D 949	1044	1139	
EURO AT 512K H/D 1091		1234	
EURO AT 1MB H/D 1186	1329	1424	
<b>Schneider Accessories</b>			
3.5" External Drive		113	
5.25" External Drive		113	
20Mb external Hard Disk		299	
40Mb External Hard Disk		399	
Monitor Stand		14	
All Schneider PC's & AT's include Microsoft Works, Dos & Manuals + 12 Months on-site-warranty			

## COMMODORE

MODEL	MON	COL	EGA
<b>PC/XT COMPATIBLE</b>			
PC10-S/D 640K	494	629	764
PC10-D/D 640K	539	674	809
PC20-H/D 640K	719	872	989
PC30-HD 640K	841	946	1017

### AT80286 COMPATIBLE - VGA'S

PC40-S/D 1MB	1053	1256	
PC40-40MB 1MB	1378	1540	
PC40+TAPE	1580	1783	

Call for special Commodore Bundles

## PORTABLES

MAKE	MODEL	PRICE
AMSTRAD	PPC512S	378
AMSTRAD	PPC512D	487
AMSTRAD	PPC640S	465
AMSTRAD	PPC640D	576
SHARP	4602	863
SHARP	4641	1463
SHARP	5541	2330
SHARP	7221	1699
SUPERSPORT	D/D	999
SUPERSPORT 286	20MB	2307
SUPERSPORT286	40MB	2741
TURBOSPORT 386	40MB	3607
HITACHI HL400	286 20MB	CALL
HITACHI HL500	386 40MB	CALL
AKHTER 286	3200 20MB	1954
SCHNEIDER	PC7640	1418

## AMSTRAD

MODEL	MON	COL	EGA
PCW8256	324		
PCW8512	413		
PCW9512	443		
PC1512SD	376	456	
PC1512DD	456	536	
PC1640SD	471	560	648
PC1640DD	535	624	713
PC1640HD	713	802	891
PC2086SD	555	644	733
PC2086DD	622	711	800
PC2086HD	800	888	977
PC2286DD	999	977	1066
PC2286HD	1066	1155	1244
PC2386HD	1777	1866	1955

## HYUNDAI

MODEL	MON	COL	EGA
<b>Super-16-640K 9.77Mhz Metal Casing</b>			
SUPER-16S/D	499	599	699
SUPER-16D/D	599	699	799
SUPER-16 30MB	699	799	899
<b>Super 286 features 640K Ram 12Mhz</b>			
SUPER 286 S/D	849	949	1049
SUPER 286 D/D	949	1049	1149
SUPER 286 20MB	1199	1299	1399
SUPER 286 30MB	1249	1349	1449
SUPER 286 40MB	1299	1399	1499
SUPER 286 80MB	CALL	CALL	CALL

### NOTICE

Hyundai comes highly recommended

## OPUS

MODEL	MON	COL	VGA
PC III 1 MB DD	698	978	1105
PC III 1MB HD30	887	1221	1472
PC IV 1MB HD20	1065		1421
PC V 1MB HD30	1221	1500	1661
PC V 4MB HD40	2221		2665
PC VI 1MB HD40	1550		1821
PC VI 1MB HD60	1687		1965
PC7 1MB HD70	2666		2855
PC7 2MB HD70	2888		3277
PC7 4M HD70	3222		3611
MSDOS	65		

Corporate / Education Discounts available on request

## MITAC

MODEL	MON	COL	EGA
MITAC 88 512K	586		
MITAC 88 20MBHD	790		1102
MITAC 1000L PS/2	730	830	VGA'S
MITAC 1000L PS/2	963		1163 VGA'S
MITAC 286SL HD20	1030	1209	1332
MITAC 286SL HD42	1163	1342	1465
MITAC 286V HD42	1463	1663	VGA'S
MITAC 286V HD102	1830	2130	VGA'S
MITAC 286VEHD42	1596	1796	VGA'S
MITAC 286VEHD102	2063	2263	VGA'S
MITAC 386 HD42	2330	2568	VGA'S
MITAC 386 HD102	2796	3130	VGA'S

All MITAC Systems come complete with 12 Months on-site-warranty

## PHILIPS

MODEL	MON	COL	EGA
Videowriter 150	258		
Videowriter 4260	345		
Videowriter 4460	432		
8088-2x3.5"	555	644	727
8088-20Mb HD	727	833	933
80286 20Mb DD	1425	1552	1720
80286 DD	860	1283	1467
80286 20MB SD	1342	1467	1635

80286 2x3.5" + FAX 764  
As Above + Printer 899

## BUILD YOUR OWN

PRODUCT	PRICE
Chassis	From 49
Power Supplies	From 59
Motherboards	From 99
256-15 Drams	From 4.50
Video Controllers	From 39
Disk Controllers	From 49
I/O Controllers	From 29
Mono Monitors	From 59
Colour Monitors	From 169
Ega Monitors	From 230
84 Key Keyboards	From 49
102 Key Keyboards	From 55
5.25" Floppy Drive 360k	From 39
5.25" Floppy Drive 1.2Mb	From 49
3.5" Floppy Drive 720k	From 59
3.5" Floppy Drive 1.44Mb	From 69

## AMIGA

MODEL	PRICE
AMIGA 500 + 10 Star pack	318
AMIGA 500 + 500 Air Miles	388
AMIGA 500 + ram + pack	434
AMIGA 500 + Colour Mon	533
AMIGA 2000 + K/B + Pack	922
AMIGA 2000 + Col Mon + Pack	1144
AMIGA A501 512K Upgrade	94
AMIGA A520 Modulator	20

Call for Amiga & Atari Latest Software

## ATARI

MODEL	PRICE
ATARI 520ST-FM + exp-pack	240
ATARI 520ST-FM + super pack	309
ATARI 520ST-FM + mono + ex-pk	317
ATARI 520ST-FM + mono + sp-pk	388
ATARI 1040ST-FM + super pack	388
ATARI 1040ST-FM + pro pack	388
ATARI 1040ST-FM + mono + sup	463
ATARI 1040ST-FM + mono + pro	463
ATARI Mega ST 1MB + pro pack	456
ATARI Mega ST 2MB + pro pack	722
ATARI Mega ST 4MB + pro pack	999
5" 500K Floppy	130
3.5" 1Mb Floppy	173
20Mb Hard Disk	521
12" High Res Mono Monitor	77
14" Med Res Colour Monitor	172

## BIT'S & PIECES

Model	PRICE
<b>Popular Modems</b>	
Amstrad V21-V22-V22bis-V23	125
Akhter V21-V22-V22bis-V23	119
<b>Printer Buffers &amp; T Switches</b>	
Acco -In line 64K Buffer Par	95
Acco -In Line 128K Buffer Par	145
Upgrade 64K serial	140
Upgrade 256K serial	256
MP Parallel 'T' Switch	30
MP Serial 'T' Switch	32
MP Parallel 4-way 'T' Switch	45
MP Serial 4-way 'T' Switch	49
<b>PC Compatible Mice</b>	
Logitech serial mouse + software	73
Logitech Bus mouse + software	79
Summamouse + Gem collection	159

## NETWORKS

We Specialise in Network Solutions:- For example a four user system for the busy accounts office with economy in mind:-			
<b>PRODUCT</b>	<b>QTY</b>	<b>PRICE</b>	
Super-16 S/D Mono	4	1996	
30Mb Hardcard	1	269	
Ethernet Adapter 10Mhz	4	548	
PC/MS-Net Software	1	141	
Cables & Connectors	3	45	
	<b>Sub Total</b>	<b>2999</b>	
	Carriage	40	
	VAT	455.85	
	<b>Grand Total</b>	<b>3494.85</b>	
Novell NE-1000 Compatible	137		
3 Meter RG-58 Cable-BNC	15		

## POPULAR SOFTWARE

Aldus Pagemaker V3	472
Xerox Ventura V2	574
dB Publisher	283
Framework III	338
Borland Quattro	126
Paradox 3	376
Cardbox Plus V4	253
Delta 5	383
Supercalc 5	240
Dataease V4	443
GEM Full Range. Please Call	
Foxbase Plus V2.01	252
Smart System V3.1	361
Sage Accountant	98
Sage Accountant Plus	165
Sage Financial Controller	265
Sage Payroll	98

## POPULAR SOFTWARE

dBase IV	350
Lotus 123 V2.01	276
Symphony V2.0	399
Freelance Plus V3	288
Wordstar Prof V5.0	205
Wordstar 2000 V3	261
Word Perfect V5.0	271
Excel V2.1	274
Windows V2.03	52
Windows 286 V2.1	52
Windows 386 V2.1	104
Wordcraft V4.0	284
Wordcraft Nova	172
Wordcraft Elite V4	565
Clipper	327
Multiplan V4.00	104
Works V1	101

If it's not advertised...Give us a ring and we will endeavour to give you a good price

# ULTIMATE PERIPHERALS

If you think you've tried the best... Try the ULTIMATE

Thousands of stock items, please call if what you want is not advertised. Free technical support on most products. Please ring if you have any Questions. All Products listed below carry a minimum 12 months return to base manufactures warranty. Please call for Optional ON-SITE-MAINTENANCE

The Largest Selection of Peripherals by Mail Order in the UK

## 9 PIN 80 COLUMN

MODEL	SPEED	PRICE
STAR LC10	144/36	122
STAR LC10-Colour	144/36	172
STAR FR10	300/76	306
CITIZEN 120D	130/25	110
CITIZEN 180E	175/30	138
CITIZEN MSP40	240/50	249
CITIZEN MSP50	300/60	299
MT 81	120/25	100
ACL 135	135/27	119
ACL 480	480/55	299
KXP 1081	144/28	122
KXP 1180	192/38	177
HYUNDAI-910	216/37	128
EPSON FX850	200/40	299
EPSON EX800	300/50	439
MP AR40	190/32	111

## 9 PIN 132 COLUMN

MODEL	SPEED	PRICE
STAR LC15	180/40	266
STAR NX15	120/30	265
STAR FR15	300/76	399
CITIZEN MSP 45	240/50	399
CITIZEN MSP55	300/60	499
HYUNDAI-920	216/37	199
KXP 1592	216/45	276
KXP 1595	288/61	381
EPSON FX1050	264/54	425
EPSON EX1000	250/50	588
EPSON DFX5000	533/80	1207
AMS DMP4000	200/50	257
ACL 700	480/55	399
OLIVETTI DM292	240/40	351
OLIVETTI PR24L	240/40	510
BROTHER 1709	240/50	356

## 24 PIN 80 COLUMN

MODEL	SPEED	PRICE
STAR LC24-10	170/57	199
STAR XB24-10	240/80	399
CITIZEN HQP 40	200/66	399
AMS LQ3500	160/60	188
EPSON LQ500	150/50	283
EPSON LQ850	220/73	467
HYUNDAI-1810	240/100	229
MP240	200/67	254
KXP1124	192/63	265
OLIVETTI DM250	240/80	432

## 24 PIN 132 COLUMN

MAKE	SPEED	PRICE
STAR XB24-15	240/80	526
CITIZEN HQP45	200/66	489
JUKI 7100	288/96	432
JUKI 7200	324/108	1082
EPSON LQ1050	264/88	603
EPSON LQ2550	400/133	923
EPSON TLQ4800	300/83	1563
BROTHER 1224	162/54	263
BROTHER 1724	216/60	499
HYUNDAI-1820	240/100	299
MP 241Q	200/67	277
MP2401Q	240/67	365
KXP1540	240/80	443
OLIVETTI DM250L	180/60	493
OLIVETTI DM600	330/82	815
AMS LQ5000	288/98	299

2 metre IBM Parallel Printer Cable 6.00 each

## DAISYWHEELS

MODEL	SPEED	PRICE
JUKI 6200	30	265
JUKI 6300 (P)	40	398
JUKI 6300 (S)	40	465
JUKI 6500	60	598
QUME SPRINT 11/ 40	40	718
QUME SPRINT 11/ 55	55	637
QUME SPRINT 11/ 90	90	1150
BROTHER HR20	22	378
BROTHER HR40	40	717
BROTHER TWINWRITER		717

For sheetfeeders, Tractors, Ribbons and Acoustic Hoods for the above Daisywheels printers, Please call

## INK & BUBBLE JETS

MODEL	SPEED	PRICE
CANON BJ-130	220	546
CANON PJ-1080A	7 Colour	343
EPSON SQ2500	450	958
HP DESKJET	220	457
HP DESKJET +	240	564
SIEMENS PT88I	240	332
SIEMENS PT88E	240	332
SIEMENS PT89I	200	384
SIEMENS PT89E	200	384
SIEMENS PT90I	480	1018
SHARP JX-720	Colour	730
MT911	220	530
OLIVETTI TH760	Thermal	532

CALL for consumables:- large stocks

## SX-LASER PRINTERS

MODEL	PRICE
CANON LBP8 II	1258
CANON LBP8 IIT	1786
CANON LBP8 IIR	Duplex 1958
HP LASERJET II	1299
HP LASERJET II	Duplex 1998
STAR LASER 8	1MB Ram 1277
STAR LASER 8 II	Dual BIN 1725
BROTHER HL-8	1399
BROTHER HL-8D	Dual Bin 2162
BROTHER HL-8QS	Postscript 2884
QMS PS810	Postscript 2899
OLIVETTI PG303	Postscript 2833
OLIVETTI PG208	HP Compat 1213
SIEMENS PT10	HP Compat 1299
Toner Cartridges for above	65

## MORE LASERS

MODEL	PRICE
CITIZEN 106	6PPM 930
CITIZEN 110	10PPM 1063
CITIZEN 112	12PPM 1166
EPSON GQ3500	6PPM 1136
EPSON GQ5000	6PPM 1207
MT905	6PPM 930
MT910	10PPM 1998
MT910GL	10PPM 2298
MT910EM	10PPM 2685
MT910DP	10PPM 2683
SHARP JX-8300	6PPM 1063
PANASONIC P4450	11PPM 1330
QUME LASER10	10PPM 1963
QUME SCRIPT 10	10PPM 3362
QUME CRYSTAL WP	6PPM 684

RIBBONS DISKETTES CABLES DUST COVERS MUFLERS TAPE STREAMERS CONSUMABLES

## SCANNERS & FAX

MODEL	COST
<b>SCANNERS</b>	
CANON IX12	374
CANON IX12F	752
CANON INTERFACE	113
LOGITECH HANDSCAN	150
PANASONIC FLATBED	899
HOWTECH COLOUR VARIOUS	CALL
<b>FACSIMILE</b>	
CANON FAX80 18sec TX speed	599
CANON FAX80 + on-site-maint	659
CANON FAX120 15sec TX speed	866
CANON FAX120 + on-site-maint	921
PANASONIC UF130 17sec	660
PANASONIC UF140 17 sec	834
For PC Fax cards	CALL

## MONITORS

MODEL	SPEC	PRICE
<b>PHILIPS MONO MONITORS</b>		
BM7502	12" green	83
BM7513	12" green	76
7913	12" FST Grn	82
7923	12" FST Amb	83
7BM713	14" FST Grn	89
7BM723	14" FST Amb	93
7BM749 PS/2	14" FST Wht	107
<b>PHILIPS COLOUR MONITORS</b>		
CM8833	14" 600 Dot	172
CM8852	14" 700 Dot	188
CM9053 EGA	14" 850 Dot	276
CM9073 EGA	14" 850 Dot	318
BCM082 VGA-PS/2	14" 640 Dot	399
CM8875 VGA	14" 640 Dot	CALL
CM9043 EGA	14" 640 Dot	237

## CAD CORNER

MODEL	PRICE
<b>PLOTTERS</b>	
Hitachi 873-A4/A3	400mm/sec 530
Hitachi 881-A4/A3	400mm/sec 416
Hitachi 874 A1/A4	400mm/sec 1998
<b>DIGITIZERS</b>	
Hitachi from 11"x12" to 44"x60"	CALL
Full range of pens, paper, stylus, cursors	
<b>MONITORS</b>	
Hitachi CM1686A1 18"	1199
Hitachi CM1686A3 18"	1299
Hitachi Hi-Scan 20"	1724
Hitachi CM2086A3 20"	1783
Hitachi CM2086(4) 20"	1862
Hitachi CM2086(D) 20"	2021

## DISK DRIVES

MODEL	COST
<b>PLUG-IN AND GO...HARDCARDS</b>	
CODIMEX 20MB	249
MINISCRIBE 20MB	259
JAVELIN 20MB	203
CODIMEX 30MB	269
MINISCRIBE 30MB	289
JAVELIN 30MB	230
SEAGATE 30MB	269
CODIMEX 40MB	299
MINISCRIBE 40MB	289
3.5" FLOPPY 720K	79
3.5" FLOPPY 1.44MB	99
<b>LARGE CAPACITY HARD DISK DRIVES</b>	
Please call for drives ranging from:-	
80MB to 1Giga also CD-ROM's etc	
Massive Discounts	

# ULTIMATE

**BUSINESS  
MACHINES  
LIMITED**

**5 Water Street  
Earby, Colne  
Lancashire BB8 6QP**

**SALES HOTLINE (0282) 843001  
VISA... (8 LINES) 24 Hrs... ACCESS**

**TERMS:**

All prices exclude V.A.T. & Carriage  
Strict cash with order only  
Visa, Access, PO or Cheques accepted  
Official orders accepted from Government, Education  
and substantial PLC's

**DELIVERY UK MAINLAND**

PRODUCT	NEXT DAY	4 DAYS
HARDWARE	15.00 + VAT	10.00 + VAT
SOFTWARE	10.00 + VAT	8.00 + VAT
CONSUMABLES	5.00 POST & PACKING + VAT	

**JOHN RUSSELL & CO**  
VALUERS & AUCTIONEERS

**FORTHCOMING AUCTIONS**

of computer hardware & electronic equipment

**Saturday 28th October 1989**

Kempton Park Race Course, Staines Road East, Sunbury, Middx

1200 lots of microcomputers & peripherals inc:

IBM & Compatible systems - IBM P/S 2 30,50,60 & 80 systems, Compaq 286 & 386, Deskpro & portable systems, Apple Mac Plus & SE systems, Laserwriters & other laser printers

Future Sale Dates:

**Saturday 11th November 1989**

Canons Leisure Centre, Madeira Road, Mitcham, Surrey

**Saturday 25th November 1989**

Dacorum College, The Marlowes, Hemel Hempstead, Herts

Viewing & Testing 9.00am / Sales Start 10.30am

For further details and catalogue please contact:

**01-681 5413**

Selsdon House, 34 Selsdon Rd, South Croydon, Surrey CR2 6PB

**SPECIALISING IN COMPUTER HARDWARE  
& COMMERCIAL EQUIPMENT**



**COMPUTER VOUCHERS**



1 ARLINGTON ROAD, PETERSHAM, RICHMOND, SURREY, TW10 7BZ

N.B. Please telephone before calling. - Please add VAT @ 15% and £10 courier delivery

**TEL: 01 948 1681**

WE NOW TAKE VISA

**COMMODORE  
AMIGA**

- AMIGA 500 ..... £345.00
- AMIGA 500 + COLOUR MON ..... £499.00
- AMIGA 2000 ..... £665.00

**ATARI**

- ATARI 520 ST ..... £235.00
- ATARI 1040 ST ..... £387.80

**MASTER SERIES**

- MASTER 128 ..... £339.15
- BBC A3000 ..... £599.00
- BBC A3000 COLOUR MONITOR .... £189.00

**ZENITH DATA  
SYSTEMS**

- EAZY PC ..... £447.00
- EAZY PC 2 DRIVES ..... £536.40
- Z-159 MONO ..... £617.15
- Z-159 COLOUR ..... £852.40
- Z-159 20MB HD COLOUR ..... £1,100.00
- Z-386 120MB HD ..... £4,100.00

**AMSTRAD**

- PCW 8256 ..... £327.70
- PCW 8512 ..... £416.00
- PCW 9512 ..... £499.00
- 1512SD .....col £479.60 ..... mono £400.40
- ..... EGA
- 1512DD .....col £563.88 ..... mono £483.96
- ..... EGA
- 1640SD .....col £592.48 ..... mono £498.39
- ..... EGA £688.17
- 1640DD .....col £657.44 ..... mono £562.00
- ..... EGA £753.71
- 1640HD .....col £798.00 ..... mono £698.00
- ..... EGA £898.00
- 2086SD .....col £715.00 ..... mono £581.00
- ..... Hi Res £890.00
- 2086HD .....col £1067.00 ..... mono £910.00
- ..... Hi Res £1237.60
- 2386HD .....col £2536.80 ..... mono £2423.00
- ..... Hi Res £2740.00

**PORTABLES**

- CAMBRIDGE Z88 ..... £199.00
- ZENITH Z-184 ..... £949.00
- ZENITH Z-184 with 20MB Hard Disk ... £1998.00
- ZENITH SUPERSOFT 286 20MB HD ... £2416.00
- ZENITH SUPERSOFT 286 40MB HD ... £3021.70
- ZENITH SUPERSOFT 386 40MB HD ... £3777.40

**ARCHIMEDES**

- ARC 305 BASE ..... £599.50
- ARC 305 MONO ..... £85.14
- ARC 305 COLOUR ..... £794.76
- ARC 310 BASE ..... £722.61
- ARC 310 MONO ..... £767.91
- ARC 310 COLOUR ..... £910.00
- ARC 310M BASE ..... £767.80
- ARC 310M MONO ..... £826.80
- ARC 310M COLOUR ..... £965.36
- ARC 440 BASE ..... £2188.92
- ARC 440 MONO ..... £2221.37
- ARC 440 COLOUR ..... £2356.42

**COMMODORE PC1**

- PC1 MONO ..... £299.00
- PC1 COLOUR ..... £399.00

**PRINTERS**

- STAR LC-10 ..... £145.00
- STAR LC24-10 ..... £228.00
- STAR LASERPRINTER 6 ..... £1040.00
- EPSON LX800 ..... £155.00
- EPSON LQ500 ..... £279.00
- EPSON INK JET SQ2500 ..... £999.95

**CAN** anyone help with the Atari ST Bards Tale? In return I can help with other tips. Write to "Revendale" Hatshill Farm Close, Bickleigh PL6 7AH. (075 539600).

**ANY** info on TRS-80 level II computer and expansion interface 1140 for programming manuals? Mr V Smyth, 3 Fleming Drive, Newark, Notts NG24 2BA. Tel 702196

**PCW** 8256 recent disabled building worker need programs. Any help Loco tips programs. G McGuire, 54 Standard Road, Enfield, Middx. EN5 6DP. Tel: 0992 717199.

**AMIGA** contacts wanted in Ireland. The Cork region especially. Must be fast and reliable, write to Finbar, 21 Loretto park, Friars Walk, Cork 4, Ireland. Overseas and all beginners welcome.

**BASIC**, Cheap Accounts and Invoicing Program wanted for IBM XT PC (MS-DOS) with 40Mb Hard Disk. Must produce printed invoices for home use only. Tel: J.B. (0394) 270151 x270 9am. to 5pm.

**ST** owner looking for STOS users who are interested. (Am only a beginner) contact Adrian on 0222 567596. Down with Amigas, Hi to Robert H., Ben and Mum, Dad and Emma.

**WANTED:** Maps of Bloodwych. I'm willing to pay for good maps, so give me a call on 01 876 5497 after 8pm. Ask for Eric.

**DOES** anyone know of an ST User Group in or about the Portsmouth area? Please contact Steve on Southsea 811321.

**WANTED:** C64 owners who are interested in programming in M/C. Hints and tips appreciated. Phone Julian on 557121 after 5.30pm or write: 32 Hasell Drive, Easton, Bristol, BS2 0AJ.

**ARE** there any games for the Atari ST similar to the Repton Series on the BBC? Phone Mike: (0778) 422103.

**WILL** someone make an .IMG or .D00 or .PI3 file from a 1933 photo please. If so ring (0271) 860738 and I will pay costs and send disk and photo.

## ● GOODS WANTED

**WANTED** Interpod or Brainbox for C64, may consider circuit details. Will swap games or utilities or pay cash. Phone Rod 0847 86310 after 6pm.

**520** STFM (D/S drive) and printer to suit wanted. Not interested in software. Ring now cash waiting. Will consider either item separately. Nigel Bradford 0274 565070.

**24** pin printer wanted, also CP/M PC, QL software. Phone 0232 651337. CP/M PC on QL with emulators. Beginner needs help. Phone John 0232 651337.

**WANTED** Atari ST, will pay around £140. Will collect London area. Soft-

ware if possible. Phone 669 7237 (010 and ask for Peter Jnr.)

**ATARI** ST cricket games, swop for my games. Gavin, 12 Leven Grove, Preston Road, Hull, HU9 3QD. 0482 707944.

**MODEM** wanted. Upgrading from VTX5000, so must be faster. Must include software for Spectrum 128+2. Phone (0946) 693352. Mon-Sat 9am-5pm.

**CAN** anyone help? I need an operator's manual for an IBM Pro Printer X24. Will pay for a copy. Please can come on help. Call Adrian: Basingstoke 862735.

**WANTED** for Apricot F2. Systems Discs and manuals, also information on built-in Modem, also technical ref. manuals. Please phone (0268) 697764 after 7. (Essex).

**HELP!** Want manual for my obsolete DTP Newdesk, I got at a car boot sale, will even buy original you have in limbo. Evenings: 052 98 316. Genuine Fast.

**BBC** Video Digitiser about £40 or will swap for Opus 40-Track Drive. (Needs attention). Also want 3.5" Drive. Simon Guerrero, 7 Matthews Road, Highfields, Stafford. Software for sale also. (£1 - £10).

**PC** engine games wanted, will pay up to £20 for any one I haven't got, like Bloody Wolf, Ordnye, Side Arms etc. Call for Tie after 8pm. (0932) 63579.

**SWAP** my C64 for your Speccy +3 or Speccy Disk Drive and I/F (Plus D or Disciple preferred). Interested? Phone: (0287) 24141 and ask for Greg.

**CACHET** Music Sound System II wanted for Amiga, urgent need of orig. prog. and manual. Ring (0928) 567400 ask for Bri after 8pm.

**WANTED;** Amiga software (games and video utilities) for new A500 enthusiast. I would also consider peripherals eg. Drives, Printer, Monitor etc. Complete set ST/Amiga Format Magazines wanted (Derbyshire) 0773 749630.

## ● HELP OFFERED

**BUBBLE** Bobble (Arcade) Tip. On title screen push joystick left then jump left, 1 player button, left, fire, then 1 player button, now put in cash for super power. (Jason's high score - 2 million).

**AMIGA** help offered. Workbench, CV or programming difficulties? However complex I'll try to assist. Jim Blacker, 17 Bellevue Terrace, Lancaster, LA1 4TY, or phone 0524 33553.

**THE** loft BBS 0442 230461 V21, V22, V22b, V23, 8NI, Protocols with new user advice files to download and online games for Atari and IBM - Call now: Hemel Hempstead 230461.

**AMIGA** owners! Stuck with CLI? Peeved with Workbench! I'll help you out! Send S.A.E. to Gordon Keenan 61 Glenfinnan Road, Glasgow G20 8JG. (No callers).

## DISKS

3" CF2	Per 5.....£10.22
	Per 10.....£19.52
3.5" DS/135tpi	Per 10.....£11.26
	Per 25.....£19.52
5.25" DS/96tpi	Per 10.....£5.61
	Per 25.....£12.56

## DISK STORAGE - TOUGH LOCKABLE

Box for 3"	Holds 30.....£8.48
Box for 3.5"	Holds 30.....£8.48
Box for 5.25"	Holds 100.....£9.96

## RIBBON REFRESH

The unique fabric ribbon restorer 160ml can  
£7.78 + VAT

## RIBBONS FOR ALL MAKES OF PRINTERS

If yours is not listed - give us a call

	1 off	2 off	5 off
	£	£	£
Amstrad DMP 2000	F 3.44	6.48	14.74
Amstrad DMP 4000	F 5.17	9.52	19.96
Amstrad 3000	F 3.44	6.48	14.74
Amstrad 8256/8512 Std. Life	F 3.44	6.48	14.74
Amstrad 8256/8512 LongLife	F 4.30	7.78	17.35
Amstrad 8256/8512 F Colours:			
Red, Blue, Green, Brown	F 4.30	7.78	17.35
Amstrad 8256/8512	MS 3.44	6.48	14.74
Amstrad 9512 Std. Life	F 3.44	6.48	14.74
Amstrad 9512 Longlife	F 4.30	7.78	17.35
Amstrad 9512 Fbr Colours:			
Red, Blue, Green, Brown	F 4.30	7.78	17.35
Amstrad 9512	MS 3.44	6.48	14.74
Brother AX10, AX15	F 3.65	6.93	16.42
Brother HR15/25/35	F 3.57	6.78	16.06
Brother HR15/25/35	MS 4.03	7.66	18.13
Citizen 120D	F 3.44	6.48	14.74
Citizen Premier 35	MS 2.43	4.62	10.94
Citizen Premier 35	F 2.99	5.69	13.45
Citizen MSP10	F 4.14	7.87	18.63
Commodore MPS801	F 3.34	6.35	15.03
Diablo Hytype II	F 2.99	5.69	13.45
Diablo Hytype II	MS 2.43	4.62	10.94
Epson FX1000, 105	F 4.30	7.78	17.35
Epson MX/RX/FX100	F 4.30	7.78	17.35
Epson MX/RX, FX800, FX85 FX80	F 3.44	6.48	14.74
Epson LX80/LX86	F 2.47	4.70	11.11
Epson LQ1500	F 4.22	8.03	18.99
Epson LQ800	F 4.14	7.87	18.63
Epson LQ1000	F 4.38	8.32	19.71
Epson EX800/1000	F 5.17	9.52	19.96
Epson LQ2500	F 4.73	8.99	21.28
Hewlett Packard Deskjet Cartridge	12.80	24.30	59.96
Qume 1v Sprint 7/9	F 4.30	7.78	17.35
Qume 1v Sprint 7/9	MS 3.44	6.48	14.74
Seikosha FP800 Longlife	F 4.30	7.78	17.35
Star Radix 15	F 5.47	10.40	24.61
Star SD15	F 5.68	10.92	25.66
Star NX15	F 5.71	10.85	25.69
Star LC10	F 4.30	7.78	17.35
Star LC2410	F 3.50	6.65	15.75
Star NP15	F 6.37	12.10	28.66
Star NL10	F 5.11	9.70	22.99
Star SD10	F 4.81	9.15	21.64
Star NC10	F 4.30	7.78	17.35

MS = Multistrike, F = Fabric

# Dunning COMPUTER SERVICES

Dept NCE, 32 Granville Road, Bournemouth, Dorset. BH5 2AH



(0202) 431762

All prices include Carriage - just add V.A.T. @ 15%. Enquiries welcome on our Help Line. Cheques/P.O.'s with order please. Or phone Credit Card Hotline

## CONTINUOUS STATIONERY

	Forms/Box	Price/Box	£
<b>11 x 9.5</b>			
1 Part 60GSM (M)	2000		13.88
1 Part 70GSM (M)	2000		15.68
1 Part 80GSM (M)	2000		17.40
1 Part 85GSM (M)	1000		11.76
2 Part NCR	1000		18.60
3 Part NCR	700		21.79
4 Part NCR	500		21.60
2 Part NCR TINT	1000		22.84
3 Part NCR TINT	750		25.70
4 Part NCR TINT	500		26.00
<b>11 x 9.25</b>			
1 Part 60GSM (M)	2000		15.08
<b>11.66 x 9.25 (A4)</b>			
1 Part 60GSM (M)	P 2000		17.32
1 Part 70GSM (M)	P 2000		17.92
1 Part 80GSM (M)	P 2000		20.48
1 Part 85GSM (M)	P 1000		12.76
2 Part NCR 80/57	P 1000		29.20
<b>8 x 12</b>			
1 Part 60GSM	P 2000		13.84
1 Part 70GSM (L)	P 3000		20.36
<b>11 x 14.5</b>			
1 Part 60GSM	*	2000	17.76
1 Part 70GSM	*	2000	19.56
2 Part OTC	*	1000	20.03
3 Part NCR	*	1000	23.60
2 Part NCR	*	700	29.23
<b>11 x 8.5</b>			
1 Part 60GSM	P 2000		13.84
2 Part NCR	P 1000		18.32

\* = Plain or Music Ruled P = Plain only (M) = Micro perfs all edges (L) = Laser Quality TINT = Coloured Paper 2 Part - White/Pink 3 Part - White/Yellow/Pink 4 Part - White/Yellow/Green/Pink

## LOOSE LEAF PAPER

A4 80GSM White Bond	Per ream (500)	6.91
A4 70GSM White Bond	Per ream (500)	6.48

## COMPUTER LABELS

Top Quality Avery Brand  
FREE Tape Dispenser/Cutter worth £4.99 + VAT with every 10000 labels!

	2000	5000	10000
	£	£	£
<b>1 ACROSS</b>			
2 3/4 x 15/16	6.96	14.48	25.52
2 3/4 x 1 7/16	8.48	18.04	32.13
3 1/2 x 15/16	7.39	15.52	27.43
3 1/2 x 1 7/16	9.52	21.70	36.83
4 x 15/16	12.96	28.57	51.78
4 x 1 7/16	7.78	16.81	29.52
4 x 1 15/16	9.96	21.43	38.52
4 x 1 15/16	13.09	28.83	52.13
<b>2 ACROSS</b>			
2 3/4 x 15/16	6.39	13.17	23.04
2 3/4 x 1 7/16	7.61	15.36	28.30
3 1/2 x 15/16	7.13	14.87	26.17
3 1/2 x 1 7/16	9.52	21.70	36.83
3 1/2 x 1 15/16	12.96	28.57	51.78
4 x 15/16	8.04	17.00	30.22
4 x 1 7/16	9.96	21.43	38.52
4 x 1 15/16	12.78	28.09	51.26
<b>3 ACROSS</b>			
2 3/4 x 15/16	6.23	12.85	22.32
2 3/4 x 1 7/16	7.51	15.76	27.80
3 1/2 x 15/16	6.36	15.90	28.10
3 1/2 x 1 7/16	8.48	18.04	32.13
3 1/2 x 1 15/16	11.46	24.63	44.52
4 x 15/16	7.13	14.87	26.17
4 x 1 7/16	9.66	20.83	37.52
4 x 1 15/16	12.68	27.89	50.76

## ENVELOPES - QUALITY COMMERCIAL RANGE

	Box Qty	Price	£
3 1/2 x 6 Manilla Gummed	1000		8.07
3 1/2 x 6 White Gummed	1000		10.08
C6 Manilla Gummed 4 1/2 x 6 3/8	1000		11.58
C6 White Gummed 4 1/2 x 6 3/8	1000		14.12
DL Manilla Gummed 4 1/4 x 8 5/8	1000		11.26
DL Manilla (Window) 4 1/4 x 8 5/8	1000		13.00
DL White S/Seal 4 1/4 x 8 5/8	1000		15.52
DL White S/Seal (Window)	1000		16.71
9 x 4 Manilla Gummed	500		11.12
C5 Manilla Gummed 9 x 6 3/8	500		9.52
C5 White Gummed 6 3/8 x 9	1000		12.13
C5 White S/Seal 6 3/8 x 9	500		13.13
C4 Manilla Gummed 12 3/4 x 9	250		9.09
C4 Manilla S/Seal 12 3/4 x 9	250		10.39

## FREDS DREAM - PART 2

**YES!**

DIGITAL MAGIC SOFTWARE are looking for Full Time and Freelance Programmers and Graphic Artists for the Amiga, Atari ST and the PC.

Call Jules Burt or Jon Law  
051 423 5943  
for more information  
or to arrange an appointment.  
Alternatively send your C.V. or demo to:

**Digital Magic Software**

5 Midwood House, Midwood street,  
Widnes, Cheshire WA8 6BH

## VASSTEC LTD

Computer software/supplies company requires the services of a freelance programmer with experience of IBM PC's/C, PASCAL.

Write or telephone for details:

*Vasstec Ltd*

1485 Dumbarton Road

Glasgow

G14 9XL

Tel: (041) 954 6853

Fax: (041) 950 1385

**Part-Time  
Staff Required**

to help with technical enquiries  
and running of the office.

**MUST** be computer literate, willing to  
work at weekends, hours to suit.

Call Mr. Chin on:

**0704 841213**

for an interview

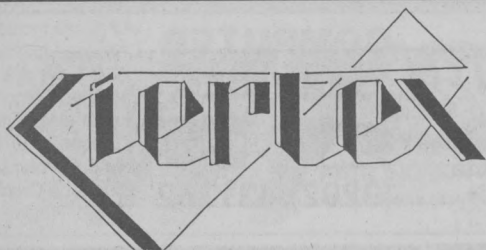

**TIERTEX Ltd**  
10A Barlow Moor Road,  
Didsbury,  
Manchester M20 0TR

Due to major expansion, one of the U.K.'s most experienced development houses requires the following individuals to complement its current in-house team.

★ ★ ★ **PROGRAMMERS** ★ ★ ★

★ ★ ★ **GRAPHIC ARTISTS** ★ ★ ★

The above positions are full time and based at our new Manchester offices. Remuneration is dependant on experience and a comprehensive bonus scheme will also be included.

The successful applicants would be working on the creme of Coin-Op conversions and exciting original projects for Europe's top software publishers.

If you think your work measures up to our past projects like Thunder Blade, Last Duel and 720, please send examples of your work together with a C.V. to the above address.

Alternatively, phone Andrew Ingram on 061 446 2251 to discuss these opportunities further, all applications will be dealt with in the strictest confidence.

# WJS DESIGN

Creators of BAAL and BLOOD MONEY (ST)

Are seeking an experienced 68000 programmer to work **in house** on original projects for the Atari ST and Commodore Amiga computers.

Based in **Leeds**, we specialise in only the highest quality 16 bit software. We provide excellent technical back-up and a 386PC. PDS development system to work on.

If you think you fit the bill, could code a mega-game with your eyes shut, are friendly, non-smoker and all round a pleasant kind of chappy (or chapess), then telephone in the first instance for a chat. Ask to speak to:-

Wayne Smithson  
WJS Design  
Park Mill House  
Stanningley Road  
Leeds LS12 3LR.

Tel: 0532 636554 Fax: 0532 636634

## Software Support

**Arnor Ltd**, successful and expanding publishers of business software including **Protext** have a vacancy in technical support. Responsibility and technical ability are the requirements that will be fulfilled by the successful applicant. Based in Peterborough.

A good salary will be paid depending on experience. Contact Mark for further details at:

Arnor Ltd  
611 Lincoln Road  
Peterborough PE1 3HA  
Tel: (0733) 68909 Fax: (0733) 67299

## MANCHESTER IN-HOUSE FULL-TIME GAMES PROGRAMMERS and GAMES ARTISTS REQUIRED NOW

We are in our tenth successful year producing great games for the worlds leading publishers.

To discuss joining us:  
**RING: 061 728 2282**  
ASK FOR JIM OR VAL



# CHIEF GRAPHICS ARTIST MIDLANDS

*Are you the best graphics artist in the industry?  
Could you be?*

PSS



- Do you want to earn what you are really worth?
- Mirrorsoft is expanding its development facility and requires a top class graphics artist.
- If you are an experienced graphics artist with a good track record on 16-Bit machines, we want to talk to you.
- We are offering an exceptional package of salary and homefits with optional bonus schemes.

If you would like to work for the best 16-Bit software house in the industry, write to Charlie Kamalati at Mirrorsoft, Irwin House, 118 Southwark Street, London SE1 0SW, or give us a call on 01 928 1454.

MIRRORSOFT

*It's even better than freelancing*

## MOONLIGHTERS REQUIRED

Turn your spare time into

# CASH

Tel/Write for more information to:

**Lisa**

**Danfforddgar House**

**Carmarthen, Dyfed SA32 7DU**

**Tel: 0267 84538**

## ACTUAL SCREENSHOTS

"What you see is what you get"

Actual screenshots is looking for the best programmers, graphics artists and new games for the Amiga, Atari ST and PC machines.

If you think your standards could match ours, send your demos with full details to:

**ACTUAL SCREENSHOTS, 7D KINGS YARD,  
CARPENTERS ROAD, LONDON E15 2HD**

or contact MICHAEL HODGES or ADRIAN TURNER on

**(01) 533 2918**

**Actual Screenshots**



## CHIP SUPPORT

DRAM	PRODUCT	PRICE £	SIMM MEMORY MODULES PRODUCT	PRICE £
64k	4164-100ns	1.50	256K x 9 - 80ns	38
	4164-120ns	1.35	256K x9 - 100ns	33
	4164-150ns	1.20	256K x 9 - 120ns	29
256k	41256-80ns	3.60	1M x 9 - 80ns	120
	41256-100ns	3.25	1M x 9 - 100ns	114
	41256-120ns	2.95		
	41256-150ns	2.60		
64K (256k)	41464-100ns	4.10		
	41464-120ns	3.60		
1MB	511000-80ns	9.45		
	511000-100ns	8.60		
256Kx4 (1MB)	514256-80ns	9.65		
	514256-100ns	9.25		

VOLUME & DEALER DISCOUNTS AVAILABLE

\* ALL ITEMS SHOWN ABOVE ARE EX-STOCK-  
NEXT DAY DELIVERY-EXC. VAT \*

\* CHIP SUPPORT CAN ALSO OFFER FROM STOCK-EPROM-  
STATIC RAM-INTEL MATHS CO-PROCESSORS.

\*CALL THE MEMORY  
MASTERS NOW

0473 250269\*

ORWELL HOUSE,  
73 CONSTABLE ROAD,  
IPSWICH, SUFFOLK,  
IP4 2UZ ENGLAND.

TELEPHONE

IPSWICH (0473) 250269

FAX

IPSWICH (0473) 236137



## CHIP SUPPORT

MEMORY UPGRADE?  
★ BEST PRICES FROM  
ONE OF THE U.K.'s  
LEADING SUPPLIER OF  
MEMORY PRODUCT ★

ALL EX-STOCK FULL  
WARRANTY

SIP MEMORY MODULES PRODUCT	PRICE £
256K x 9 - 80ns	41
256K x 9 - 100ns	37
1M x 9 - 80ns	132
1M x 9 - 100ns	126

## WANTED:

# PROGRAMMERS!

We require young, enthusiastic, hard-working individuals for our rapidly expanding software development team. We offer good rates of pay and excellent bonuses to all successful applicants.

Programmers may be in-house or freelance and should be skilled in Z80, 6502, 8086 or 68000 Assembly Language.

Re-location assistance provided for in-house applicants if required.

**Contact: Simon Thompson**

**on 0902 45281**

or write, enclosing full C.V. to:  
Esprit Software Programs Ltd.,  
Top Floor, Ivy House,  
1 Wellington Road,  
Bilston, Wolverhampton,  
West Midlands, WV14 6AA

## Sensitive Data Systems Ltd.

Tel. (0843) 602822

Fax. (0843) 602122

### MEGA ST



MEGA ST 1 £559.00

MEGA ST 2 £850.00

MEGA ST 4 £1165.00

For SM124 Monitor Add £95.00

### 520STFM 1040STFM



520STFM £275.00

520STFM POWERPACK £365.00

1040STFM £455.00

### ATARI SPECIAL PACKS

WORD PROCESSING PACK

MEGA ST2 + SLM804 +  
SM124 + SOFTWARE

£1675.00

D.T.P. PACK

MEGA ST4 + SLM804 +  
SM124 + MAGAFIL 30 +  
SOFTWARE

£2825.00

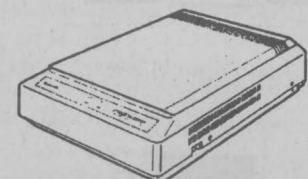

IIAWK 432 SCANNER £1667.50

IIAWK CP14 SCANNER £1250.00

COLIBRI SCANNER £454.25

SLM804 LASER PRINTER £1249.00

D.T.P. / W.P. SOFTWARE

CALAMUS D.T.P. £458.85

TIMWORKS D.T.P. £99.95

WORDPERFECT 4.1 £228.85

All prices include VAT

Anson Close, Pysons Road Industrial Estate, Broadstairs, Kent, CT10 2YB

# FREE READER ADS!

- As a major new service to readers, we are now offering small ads of up to 30 words absolutely free of charge!
- It's an ideal opportunity to sell second-hand computer equipment or get in touch with other users, or even to print a simple tip you've discovered!
- Because Express is published every week, you can be sure that ads submitted here will appear more quickly than any other magazine can manage.
- We're particularly keen to receive ads from people offering free

## Reader Ads order form

Name .....

Address .....

.....

..... Tel .....

Write your FREE advert here! (30 words max. Repeat details above if you want them to appear in print.)

Please tick the category your ad should appear in:

- Help offered  
  Mini-tips  
  Help wanted  
  For Sale  
  Goods wanted  
  Services  
 Events  
  Bugs discovered  
  Virus warning  
  Humour  
  Announcements  
  User  
 Groups  
  Bulletin boards  
  Personal  
  Misc

**Please note:**

- 1 Sorry, NO trade ads! All reader ads must be from private individuals
- 2 We cannot vouch for the quality of goods and/or services advertised in this section. All ads are accepted in good faith.
- 3 We reserve the right to amend or refuse ads at our discretion.
- 4 No pirated software may be sold through these columns. Any readers being offered non-originals should contact us.
- 5 We cannot guarantee that adverts will appear in a specific issue of *New Computer Express*.
- 6 The following declaration must be signed:

*My advertisement conforms to the terms above and is legal, decent honest and true*

Signed .....

help to other users (see box).

- Don't miss out on this opportunity for speaking directly to Britain's liveliest computer users.

Send to **EXPRESS READER ADS, 4 QUEEN STREET, BATH BA1 1EJ.**

## COULD YOU HELP ANOTHER USER?

Next month we're introducing a special reader-to-reader helpline and we'd like your help in setting it up. Are you knowledgeable about one or more of the following?

- One or more computers
- MS-DOS, TOS, AmigaDOS, CP/M.
- Any popular software package (serious or leisure).
- Any language.

If you're prepared to pass on that knowledge to other

users, please use the free Reader Ad service below to list the areas in which you can help.

You may list either a phone number or an address. (Readers using the Helpline will be instructed not to call in anti-social hours and to enclose an SAE with any queries.)

What do you gain from it? Simply the prospect of getting in touch with other computer users who could do with your help.

# Laserink

## 35% AUTUMN OFFER

**LASERINK ARE NOW OFFERING A MINIMUM OF 35% DISCOUNT ON ALL THE FOLLOWING PRINTER RANGES:**

	RRP	LASERINK SELLING PRICE
STAR ..... eg LC10	£199	£129
CITIZEN ..... eg 180E	£179	£116
OLIVETTI ..... eg DM105S colour	£249	£160
EPSON ..... eg LQ1050	£849	£545
HEWLETT ..... eg Deskjet		
PACKARD ..... Plus	£795	£515

**ALSO AVAILABLE AT SIMILAR DISCOUNTS BROTHER, RICOH, CANON, AND MANY MORE**

**LASER PRINTERS AVAILABLE EX-STOCK INCLUDE:**

	RRP	LASERINK SELLING PRICE
HPLASERJETII .....	£1999	£1265
HPLASERJETIID .....	£2999	£1979
OLIVETTI PG208 .....	£1950	£1250
STAR LASER PRINTER "8" .....	£1989	£1245
BROTHER HL8E LASER .....	£1995	£1350

**CALL NOW AND SAVE ££££'s ON MOST PRINTERS AND CONSUMABLES**

**LASERINK THE FAST AND FRIENDLY COMPUTER AND PRINTER PEOPLE**



### 0708 730259

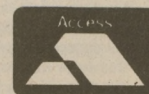

**180a RUSH GREEN ROAD  
ROMFORD, ESSEX RM7 0JU**

**ALL PRICES QUOTED EXCLUDE VAT AND DELIVERY**

# STREET TALK

BY MAFF EVANS

ISN'T it strange how computers seem to attract a "following"? The early eighties put the "microcomputer" (as everyone called them in those days) in the bracket of those people that professed to be techno-boffins or science freaks. Even playing video games was considered scientific. Back then it was the BBC micro and suchlike that ruled, but soon came a little rubbery machine called the Spectrum. It had really nice things like cheap games to play and found a lot of friends in the public. Then came the good old Commodore 64, with its great graphics and sound, wowing the new trend of games players.

Straight away all the new computer fans started slagging off the "archaic" micros and said how amazing their games machines were. The scene remained the property of these two machines for a while, until a few years ago when news of a new breed of 16-bit machines appeared. The Amiga from Commodore promised extremely pretty pictures and even better sound, but was pipped to the post by the Atari ST machine.

The thing is, now that these two machines are around, the good old Spectrum and C64 are the targets for everyone's derision. So how long will it be before the St and Amiga fall foul of the 32-bit ideal, left to be made fun of in the corner? It's a thought...

On the subject of old machines, after the news story last week complaining of the minuscule amount of Beeb games available, what happens but a host of new releases descend upon my desk. First is *Blast*, a shoot-'em-up from ASL for the BBC B and Master machines, but most noticeable is a batch of games from Impact software, featuring *E-Type* - a 3D racing game, *UIM* - a sort of underwater *Elite*, *White Magic* - a mystical arcade adventure, *Holed Out* - a golfing game and *Arcade Soccer* - speaks for itself really, doesn't it? All these should be available now, apart from the Archimedes version of *UIM*, which is due in December. Just goes to show that you can't kill off a machine that easily!

## GAME of the WEEK

# CARRIER COMMAND

Just over a year ago, Rainbird released a battle simulation on the ST and Amiga. Strategists instantly went ape over the game and praise was heaped upon it by many reviewers. That game was *Carrier Command*. Now Rainbird has decided that all you PC owners have done without this military masterpiece for too long, so Realtime Software has carried out this superb conversion.

The game places you in control of the ACC *Epsilon*, the first of the Government's latest high-tech carrier ships. The second, the ACC *Omega*, has fallen into enemy hands and has had its controlling software modified. The group responsible - the STANZA organisation - has demanded \$15 billion from the government or the *Omega* will be set loose.

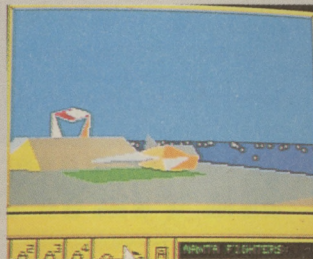

Rainbird • PC version reviewed • £24.99 • Out now

No this isn't a misprint, the game of the week is indeed on the PC. Don't believe that you can get a stonker of a game on the PC? There's only one thing to say to you then...BELIEVE IT!

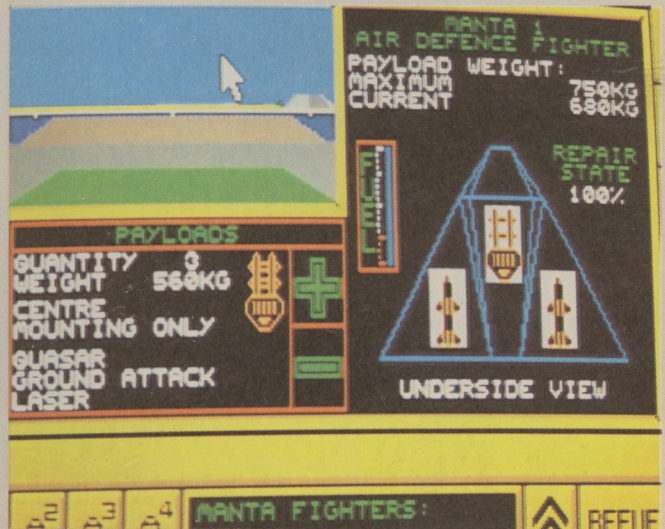

Naturally the government can't submit to these terrorist tactics, so an alternative has been found. A new version of the ACC control program has been developed and must be activated by dropping it on enemy installations. This is where you come in. You must use all the tactical systems available to you on your carrier to infiltrate the enemy positions and revert them to their friendly state.

The tactical elements of *Carrier Command* are very well implemented, with clear and concise control and information screens. It's very easy to get into the swing of the game and start deploying drones and Manta flyers all over the shop. Once the various systems have been worked out then getting into battle is a lot of fun.

**GRAPHICS AND SOUND** • Surprisingly enough, the graphics on the PC version of *Carrier Command* are

smooth, fast and colourful. Yes that's right, colourful! All the system's screens are nicely drawn and easy to understand, the maps and radar screens are obvious to track and watching the sea and land whizz beneath you from the Manta is particularly impressive. Nothing much has been done with the sound however, except for the most rudimentary effects (the odd beep or crunch here and there). If more had been done in this department then perhaps *Carrier Command* would have been just that little bit more atmospheric.

**OTHER VERSIONS** • *Carrier Command* has been out on the ST and Amiga for some considerable time bringing a great deal of success for Rainbird. Even Spectrum owners were given the opportunity to sample the delights of 3D tactical warfare - and rather good it was too. Oh, and all you C64 owners will be happy to learn that a

conversion is soon to be released for your machine. Yay!

**VERDICT** • To be quite honest, I didn't much fancy the prospect of reviewing a PC game (oops! Just offended a load of readers there), but I must admit to being pleasantly surprised. PC *Carrier Command* is a superb conversion of an extremely good battle simulation. The game design is good, the puzzles are challenging and the graphics are excellent. PC owners don't often get the chance to play such classics as this, so if you pass it up you'll be very sorry!

OTHER VERSIONS		
PC	£24.99dk	Out Now
Amiga	£24.99dk	Out Now
ST	£24.99dk	Out Now
Spec	£9.99cs, £14.99dk	Out Now
C64	£9.99cs, £14.99dk	Out Now

## FIRST PEEK... FIRST PEEK... FIRST PEEK... FIRST PEEK

### POWER DRIFT



Listening to the Playback tape this week, it's obvious that the 64 version of *Power Drift* has already made quite an impression on some of you. Well we've seen C64 and Amiga versions and it doesn't 'alf look a good racing game! If you haven't seen the arcade version (where have you been?), the game features a variety of colourful characters driving nippy little racing carts around all manner of twisting, bumpy circuits. It's one of those games that's got the hydraulic stomach churners, so any conversion has got to be really really good to make up for the lack of movement. Activision has taken it upon itself to license the game from Sega and have quite a job on their hands. Chris Butler (programmer of *Ghosts 'n' Goblins* and *Commando*) is doing the 64 version, while the Amiga version is being developed by ZZKJ, who was responsible for bringing us the Amiga version of *Super Hang-On*. So what's *Power Drift* really like? Well you'll have to wait for the full review. Hahaha!

# MINI REVIEWS...MINI REVIEWS...MINI REVIEWS

## DRAGON SPIRIT

★★★

Domark • £19.99 • ST version reviewed • Also available on Amiga, PC, CPC, Spectrum and C64



Dragon Spirit has been available on the PC Engine for a while now, but now - thanks to Domark - the game is no longer limited to that small clique of video gamers. The game features a large blue dragon, flying over a vertically-scrolling prehistoric world, attacking all manner of foes with its fiery breath. Dotted about the scenery are blue and red eggs, which release special pods when bombed. These pods give additional power to the dragon, with additions such as extra heads whirling fire-flies or a huge stream of flame - very useful for those end of level nasties.

The presentation of Dragon Spirit is rather on the sparse side - the title sequence only appears when the game first loads, thereafter the game just carries on ad infinitum. The in-game appearance, on the other hand, is well done, with a clear info-panel and well animated sprites flying over nicely drawn landscapes. Again wimpy sound has let us down. What has happened to the days of the powerful soundtrack? Has everyone forgotten Starglider?

But what of the gameplay? Well it's a basic shoot-'em-up - and quite a playable shoot-'em-up at that, with the difficulty set at just about right - which makes a change! Having said that, I can't say I found myself drawn to the machine time after time to play Dragon Spirit, maybe because (in the words of that famous detective) it's good...but not that good!

## STUNT CAR RACER

★★★

Micro Style • £9.99(c) £14.99(d) • C64 version reviewed • Also available for ST and Amiga

First-person race games seem to be making a comeback these days. What with *Hard Drivin'* on the way and *Powerdrome* a big hit, the days of perspective speed are far from over.

Unfortunately, the C64 version of *Stunt Car Racer* falls rather short of the mark set by the two aforementioned games. The documentation gives the impression that there is a load of facets to the actual game, but when you look more closely, most of the text is padding - referring to motor sport in general rather than elements of the program.

What we actually have is a typical 3D zoom around a bumpy track with the odd jump for added "excitement". The only sensation I can sense while driving around is frustration when the horizon does a flip in the most unrealistic way imaginable and I find myself in a heap at the side of the track. Add to this a strange control system, uninspiring, three colour graphics and you're heading towards one of the most infuriating race games available.

Sorry guys, but with *Hard Drivin'* on the way you'll have to come up with something a bit more impressive than this if you want to have a crack at success in this Christmas' market.

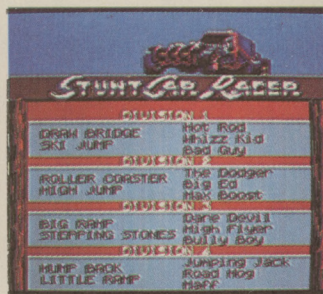

# MINI REVIEWS...MINI REVIEWS...MINI REVIEWS

## HIT LIST TOP 5 GAMES

Our recommended games of the moment.

### 1. BATMAN

Ocean • Amiga, C64, Spectrum, CPC

"Winged freak terrorises" the games players of the world, in his own fab and wundy video game.

### 2. KICK OFF

Anco • Amiga, ST, C64

You can't keep a good game down and this one keeps flying up in the air despite being sat on by the Express staff, because it's fantastic!

### 3. POPULOUS

Electronic Arts • Amiga, ST, PC  
I just played this again recently and couldn't believe that I'd forgotten how good it is, especially with the new worlds.

### 4. XENON 2

Imageworks • Amiga, ST  
Whizz-bang space battling at its very best...and those graphics...wow!

### 5. STRIDER

US Gold • Amiga  
Wonderful arcade conversion giving you the chance to make Ivan Ruskie taste your steel.

# TAME the GAME

### ● RVF HONDA (ST)

"If you run the game in 60Hz mode, you get the game a lot faster and it is very impressive."

Paul Ffelan, Chorley

### ● NEW ZEALAND STORY (SPECTRUM)

To get to the cheat mode, type FLUFFY on the title screen and a kiwi will appear at the bottom of the screen. You can now start with infinite lives and the ability to press enter to get to the next level.

Brian Morton, Bangor, Northern Ireland

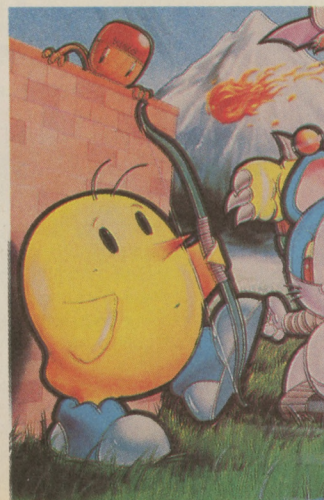

### ● SHADOW OF THE BEAST (AMIGA)

Place disc 1 in the drive and hold down the left mouse button until the game starts. You will now start with infinite energy.

If you still don't know what the blimey heck is going on then follow these pointers.

1. Go left.
2. Enter tree.
3. Go down until you encounter monsters with axes and kill them.
4. Keep hitting blue orb held by fire

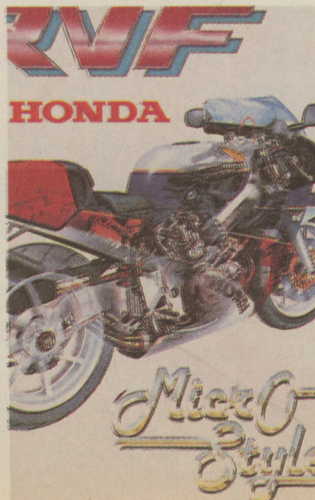

breathing monster to get a super blaster.

5. Go up-right to Skull-Chariot monster and use super blaster to kill him.
6. Go back down to where the blue orb thrower is. There should be a gold key around somewhere.
7. Go back to where you killed Skull-Chariot monster, cross the bridge, go up, left and throw the switch on the wall.
8. Go further up and go left through bouncing eyes.
9. Get second gold key from next to the dead monster.
10. If you go down and right you should find your way out.
11. You will emerge from the well to the right of the start position.
12. Continue right and you will come across a castle.
13. Go right until you see the torch on the wall.
14. Jump up and collect the torch.
15. Enter the castle and... Well that's a different section, isn't it? You'll have to find your own way from here.

SM Stocks, Chesterfield, Derbyshire

A very useful set of tips there. So a piece of software will be winging its way to you soon.

### ● STARGOOSE (ST)

Not the greatest game in the world. but if you play it and would like invincibility then press F9 during the game.

Nicholas Holness, Whitstable, Kent

# VIEWS...MINI REVIEWS...

## ACTION FIGHTER ★★

Firebird • £24.99 • ST Version reviewed • Also available for PC, Amiga, Spectrum, CPC and C64

Back in the mists of time, Sega released a vertically-scrolling coin-op, which placed you in the role of a special agent in a highly armed car. This game was called *Spy Hunter* and at the time it attracted quite a bit of attention.

Years later and Sega have come up with a game which is not entirely dissimilar to *Spy Hunter*. *Action Fighter* is a vertically-scrolling shoot-'em-up, with you in control of a motor-bike - which later turns into a car and then a spy plane.

Actually, the game is more like a cross between *Spy Hunter* and the classic *Xevious*, with the first section comprising of a race along a busy road evading enemy agents, collecting bonuses and going into a truck for extra weapons.

The later section has you flying along, destroying airborne baddies and dropping bombs on ground targets.

Although the baddies on both sections are quite nasty and lives are lost at an alarming rate, this game proves quite compulsive. The scrolling is remarkably smooth and fast and the sprites are neat and colourful.

The main problems lie in the sound and

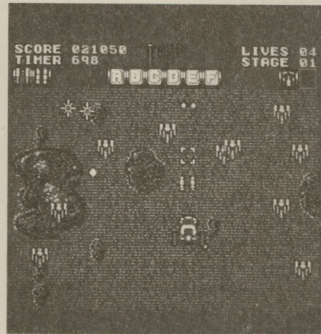

variety of gameplay stakes. Each level bears a striking resemblance to the one before, with a few more landscape features added. I would prefer more of a change. As for the sound, the effects consist of vague beeps and crunches - not the most realistic in the world.

For me, these problems question the viability of twenty five pound price tag, but if you like the classic arcade game then give it a whirl. It could be just your cup of dry leaves suffused in boiling water.

# VIEWS...MINI REVIEWS...

### ● ARCHIPELAGOS (ST/AMIGA)

Press RETURN after completing levels 1 and 2, then type 8421 and press [RETURN] twice. You can now select any of the Archipelagos from 1 to 9999.

Oliver Hargreaves, Preston, Lancashire

### ● BATMAN (AMIGA)

On the title page, hold down the J, A and M keys. The screen will flip upside-down and when you restart you'll have infinite lives.

David Pickering, Cheadle Hulme

**A useful tip for a great game and well deserving of a prize. Cheers David!**

### ● WIZBALL (ST/AMIGA)

Press the space bar to pause then type RAINBOW, press fire, then the space bar then C. Life should now be much easier.

M du Plessis, Cleveland

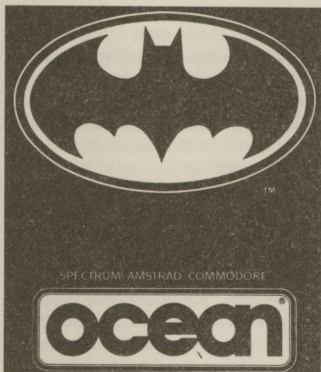

### ● IKARI WARRIORS (ST/AMIGA)

From the high score table type FREERIDE the [Return] and the screen goes back to normal. Then press either one or two players and take it away!

M du Plessis, Cleveland

## DO YOU OWN THESE GAMES?

- BATMAN
- SHADOW OF THE BEAST
- STRIDER
- DYNAMITE DUX
- CARRIER COMMAND
- INTERDICTOR
- EYE OF HORUS
- XENON 2
- DRAGON SPIRIT

Cheat modes for *Batman*, *Shadow of the Beast* and *Strider* in particular would be

most useful. So if you think you can oblige with a helpful hint or tip, then send 'em in to...

Tame the Game  
4 Queen Street,  
Bath.  
BA1 1EJ

Remember, the best tips win something for nothing (except for the 20p you pay for the stamp).

Can't be bad eh? (Bribe, bribe).

## ONE-LINERS • ONE-LINERS

• Brøderbund, long regarded as innovators in video gaming, is set to release the latest in its series of historic action/strategy games. *Joan of Arc: Siege and the Sword* has been available on ST and Amiga for a while, but PC owners shouldn't have long to wait before they can put themselves in the kingly shoes of Charles VII. The game supports Hercules, CGA, EGA and Tandy graphics, including a selection of digitised screens to portray the action.

• Spectrum owners can soon sample the delights of interplanetary competition with Infogrames' *Purple Saturn Day*. The original 16-bit versions had all sorts of accolades heaped on it - and rightly so it was a good game! Eight bit owners wishing to take to the stars for a trip through Saturn's Rings or a brain test can buy *Purple Saturn Day* from £9.99 on cassette or £14.99 on disk from October 23rd. Oh and first prize of "Press Release of the Week" to Pauline Garsden for the release that gave this info. Nice one!

• Buy the time you read this, Domark should have finished releasing the Star Wars trilogy on just about all formats. Reviewed a few weeks ago in *Express*, the package is a collection of all three Star Wars-related arcade conversions and represents a worthwhile purchase to fans. Ready for the prices? Here we go... £24.99 for ST and Amiga versions, £17.99 for C64, CPC and Spectrum +3 discs and £12.99 for C64, CPC and Spectrum cassettes.

• The end of this year sees a busy time for Mindscape with a bundle of releases in the

offing. Before the end of October, PC versions of the circus game *Fiendish Freddy's Big Top o' Fun* at £34.99 and the *Back Up Pro* copier at £69.99, while November has in store releases for various formats, including... (takes enormous breath) *Fiendish Freddy* on the ST; Horse racing and *Gin and Cribbage* on the Amiga; *Omega* on ST, PC, Amiga and C64; *Space Rogue*, *Knights of Legend* and *Windwalker* on PC and C64; and finally *Star Trek* and *Harley Davidson* on the PC (phew). Exact prices and release dates will probably be available soon.

• Elite, soon to be bringing out the 16-bit versions of *Commando*, is just about to release a scrolling *Commando*-style war game. Seems strange.... *Dogs of War* features selectable weapons, multi directional scrolling, and simultaneous two player action. Written by Steve Bak, the game should be available at the beginning of November at a price of £19.99 on ST and Amiga. I wonder how it'll fair against the official licensed game?

• Logotron, those wonderful people that gave us *StarRay*, has two new games in the pipeline. *StarBlaze* is a filled 3D shoot-'em-up, featuring "colourful backgrounds and scores of fiendish alien attack waves." Sounds thrilling! Also due soon is *Bad Company*, a 3D *Space Harrier* style game by Steve Bak (where have I heard that name before?). *Bad Company* should be available at the beginning of December, while *StarBlaze* will appear slightly earlier in November.

# Playback

YOUR VIEWS ON THE LATEST SOFTWARE - CALL 0225 444439

"I've just played *Batman* on the Amiga and I just want to warn people - don't buy it's a heap of crap. Bye."

No it isn't.

"Could someone please persuade software houses to stop licensing everything that has a remote chance of being turned into a game. Can we please have some more original software?"

BRIAN MORTON, Bangor, Northern Ireland

"How about having a lottery - Guess the launch date of *Pools of Radiance* on the ST. It's been said that it's going to be launched for four months to my knowledge. US Gold is now saying January or February when about a month ago it said mid October."

STEVE NEWTON

"At last Chris Butler has finally delivered on the

Commodore 64. Thanks Chris, *Power Drift* is absolutely brilliant and fantastic. Let's see how good US Gold can do when it brings out *Turbo Outrun* on the 64 as programmed by Probe."

IAN DOCKRELL, County Wexford, Ireland

**Aw, that's not really fair is it? What about *Ghosts 'n' Goblins*? That was good, even though *Space Harrier* wasn't.**

"I thought I'd ring up to warn people off the ST version of *TV Sports Football*. You only get half a game since the statistical element has been left out completely, the gameplay is all to easy, you have to reboot the machine after each game - even on the 1040 - and what's more there's a bug or two when you get to the playoff stages. I've never seen it, but I can't believe the Amiga version

was as bad as this. How can anyone give this a Game of the Month rating?"

STEVE PITTS, Hemel Hempstead

"I've just bought *Indiana Jones and the Last Crusade* - the graphic adventure on the Atari ST, and the sound effects have to be heard to be believed! They are so life-like, it's amazing. No honestly. I'm telling the truth, they're really good!"

**The phone call was abruptly ended with the sound of men in white coats arriving. Anyone else want to say something on the state of the software industry? Well give us a bell on 0225 444439 and stick it on tape. Oh, and if you've got "absolutely nothing at all to say" (in a Scottish accent), don't bother.**

# AMIGA BLITZ

## Budget bonanza

Even though the marketing people keep assuring us that £25 is a very reasonable price for an Amiga game, most of us still can't afford to lash out every time another block buster is released. Thankfully, this is all set to change (no, we aren't all going to be given a loan!).

As you've probably seen in a recent issue of *Express*, Virgin Mastertronic has announced the arrival of its new budget label, 16 Blitz which will be selling a whole range of Amiga games for a mind bogglingly low £4.95.

As well as the infectiously addictive *Infection* (reviewed three weeks ago in *Express*), Virgin have the following titles coming to an Amiga near you very soon -

**Little Computer People** - Re-release of the curious Activision game in which you adopt a 'computer person' as a pet. The original £25 price tag was a bit steep, but for £5 you can't get wrong.

**Sorcery +** - Now this really is the business. Fight to get your hands on this game if you have to - for £5 this is an absolute must! The game involves you travelling through a mystical land rescuing your sorcerer friends.

**RoadWars** - Old Melbourne House game that was originally produced for the Arcadia super select systems. From what I say at the PC Show, the game has been enhanced and is also worth investing in.

**Pub Pool** - As the name seems to strangely suggest, this is a pool game which will be of interest to those of you who like pool (isn't logic wonderful!).

**World Darts** - Another Arcadia super select game that goes down particularly well at my local, the Mason's Arms (now the most famous pub in Britain!). Do I really need to tell you what this game is all about?

**Kelly X** - If my memory serves me well, I'm almost certain that this was the working title for what eventually became *Xenon*. Anyone know any different?

## First there was A-Max

After years of build up, we have seen Amiga emulators for such mundane machines as the PC and Macintosh, but now the seemingly impossible has finally been achieved; the Amiga has got itself a Sinclair QL emulator.

Unlike other emulators, the most astounding thing about this particular emulator is that it is PD (let's face it, who's going to actually pay good money for the thing!). Unfortunately, I haven't got any QL software (and I don't want any) and so I haven't been able to actually test the emulator, but from what I've seen, it looks pretty complete. The author claims the emulator will run the vast majority of QL software and it will even allow you to read QL disks directly (you could have a problem with Microdrives though!).

The emulator is available for £3 from UGA software in Holland who can be contacted on 010 03404 52987. I haven't got a clue as to whether there is a UK distributor for the UGA disks.

## A friend indeed

After last week's preview of Brown-Wagh's up and coming Amiga word processor *Pen Pal*, you'll be glad to hear that, after a week's solid use, the program more than lives up to expectations.

As reported last week, *Pen Pal* is another of the new breed of 'word publishing' packages that combine the editing power of a dedicated word processor, the data handling capabilities of a database with the kind of layout power only found in up market DTP systems. The program features one of the friendliest user environments I've seen for many moons, which more than evidently owes a great deal to the Macintosh. If you are considering treating yourself to a word processor, or even a simple DTP package for producing forms, notices etc, then *Pen Pal* is worth considering.

For the definitive review, check out the next issue of *Amiga Format* which will be on sale on the second Thursday of next month (I know, it's a long time to wait!). The UK distributors, DLL, can be contacted on 0983 405600.

## NEWTEK-nology

NewTek, that Kansas-based producer of state of the art Amiga hardware and software, is soon to release a major upgrade to its ever popular digitiser system, *Digi-View*.

NewTek has been working through the night to finish the system in time for a November release (it was 4.30 in the morning, his time, when I spoke to Paul Montgomery, president of NewTek). Among many other enhancements, the most astounding feature is that *Digi-View 4* will allow you to digitise 4,096 colour pictures in high resolution. Yes, you did read that last line correctly - 4,096 colours on screen at once in high resolution (640 by 512 pixels). According to Paul, this impressive feat is achieved by using the Copper to alter the colour registers after every scanline, therefore allowing up to 16 colours to be used per line. Unfortunately, pictures produced using this system will not be compatible with currently available paint packages, although existing screen modes are still supported.

For enhanced HAM pictures, NewTek has also developed a new HAM system that allows for sharper images than are possible with currently available digitiser systems.

Also due for release soon from the darker depths of NewTek (or 'Alcatraz' as it is known by the programmers that work there) is a 3D rendering package from that pioneer of Amiga 3D graphics, Alan Hastings, creator of the critically acclaimed *VideoScape 3D* animation system from Aegis.

Jason Holborn



• *Digi-View* - major upgrade due very soon

# ST

## Thoughts of Chairman Bob

You'll recall last week I was speaking to Atari UK's boss Bob Gleadow - OK, so he's not Chairman, but I've got to get a headline somehow! - about the prospect of an Atari show to be held in the first half of next year.

My next questions to Gleadow concerned the STE: is it merely a minor enhancement? When will it be available? "The STE is going to be around a long time," Gleadow replied, "and like General Motors we've got to keep improving. I would like to hope that we'll get some of the 1040 product out - the STE 1040 - before Christmas.

"Logistically, Christmas for Atari is a nightmare, but if we can slot the STE deliveries, produce them and deliver them, we will. It's a very delicate time for us.

"The STE's been announced about four times. And if you read back in the press we've had a lot of criticism about our showing and not delivering. So yes, we do show our new products, we do get market reaction to them, and it's a question of policy: we don't believe that we prematurely show, but definitely if we showed a product and the world hated it, we'd kill it. So to us it's a very worthwhile marketing exercise.

"During the time that the STE, in its various names, has been shown, it has been further developed. So what we showed at Dusseldorf for the 1040, we believe we will deliver on. It's final, it's frozen, it's been sent to manufacturing level."

But will programmers take advantage of its capabilities, when the non-enhanced ST user-base must be their primary concern? "The ST as it is now must have a user base of around 200,000. That's a stand-alone viable market. If ten per cent of that base bought a game you'd have a 20,000 seller and the game companies would be ecstatic; five per cent, 10,000 seller and the game companies would still be ecstatic. So I'm not unduly concerned, because I believe that the STFM market is now large enough so that people will keep writing for it.

"I also believe that because the STE is totally STFM compatible, the soft option today is left to exploit the new features. Some programmers will, some won't and there'll be a crossover. And as the STE base develops, you get more and more software exploiting its features."

Looking further into the future, I wondered whether the TT might be the kind of machine ST owners would be buying in three or five years time: "The TT allows a second or third time buyer an upgrade path," Gleadow replied. "It's a machine you can expand: you can change the size of the drive, you can increase the size of the memory, you can use the half-height expansion slots. So it's a flexible, open architecture machine.

"I believe the initial market for the TT will be in universities as a very fast workstation, a very fast terminal, as a text and graphics engine. There's a number of products which will run significantly faster on a TT and therefore make a much more attractive proposition for professional use. So the *Calamus*, CAD packages: the TT gives them a performance benefit which makes them more than respectable. So we do see it moving into a professional market as a text and

graphics engine.

"So yes, we do see a number of ST users upgrading to it, because it will run their peripherals, it will run their software, and they'll be familiar with the look and feel of the machine when they're driving it."

In the US, incidentally, Atari's president has been talking up a good fight between the TT and Steve Jobs' NeXT system, saying that he expects it to "lobber them." We shall see.

## Tales from the computing twilight zone, 1

### The first in an occasional series

It was just an ordinary day when Mike Gerard - who incidentally writes for *ST Format*... £2.95... all good newsgagents... astonishing value... Where was I? Ah yes, it was just an ordinary day when Mike bought the excellent *Protext*, a sound move for someone, like him, moving up from the Amstrad PCW (or CPC). Or so he thought.

Anyway, Mike has an early single-sided drive ST, and Arnor were commendably swift in changing them for single sided disks. But that's not the problem, though it's part of it. When he'd installed *Protext* to run with his Star LC24-10 all seemed well until he tried to use underlining, italics or any other typeface than that currently in use on the printer: "The software and printer were battling for control," as Mike melodramatically puts it: "and the printer was winning!"

"This was puzzling," Mike goes on, "since the correct printer driver had been installed, as was confirmed by the *Protext* Status Line. Arnor were puzzled, too, since they'd had no similar complaints. And even a lengthy chat at the PC Show with these ever-helpful chaps failed to suggest a solution.

"It was then I noticed something odd: the printer driver on my start-up disk was smaller than the printer driver on the master disk. Funny, I thought." Funny indeed. Mike tried to re-install the driver, and a notice flashed up briefly that the disk was full and installation unsuccessful. As Mike points out, the fact that the disk was cataloguing as full was not initially that noteworthy, since some software companies use the "0 bytes available" as a protection device - indeed Arnor's dictionary disks are a little like this.

What had happened was that the printer driver had been opened and partly transferred, which was why it appeared on the Status Line. But not all the driver commands had gone across. Moral: in order to get the full driver on a single-sided start-up disk you have first to remove the CONFIG.PRG file and put it on another disk.

Mike is now living happily in Huntingdon, his *Protext* printer driver experiences a thing of the past. Yet it really happened...

If you have a computing Tale of the Twilight Zone, why not share it? Write to Club ST, NCE, 4 Queen St, Bath BA1 1EJ.

Steve Carey

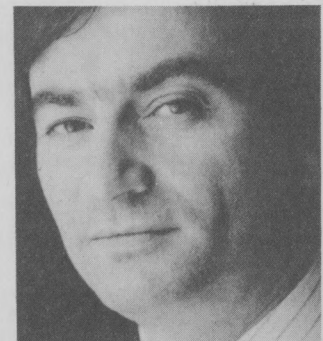

• Gleadow: Hopes to get some STEs out for Christmas

# PC UPDATE

## ROM screen fonts

The nature of a PC text screen was brought home to me the other day when I received a VGA card on loan. The card in question was a pukka job with 512K of video memory, so it should be just right for reviewing some VGA only products, such as AutoDesk's *Animator*. It installed OK, and seemed just the job, apart from some rather odd colour switches and one other unfortunate feature.

The characters that appear on any PC text-mode screen are drawn from a ROM attached to the video card. As well as being based on a different dot matrix, text for Hercules, CGA, EGA and VGA screens is dependent on the design of the characters in the video ROM. Those on this VGA card are so horrid, I'll be glad when the loan period's up. No attempt is made to account for the monospaced nature of the text, so capital 'i's are left wallowing in a sea of blank space, while 'm's and 'w's crowd out the other letters. 'C's are badly formed and the descenders on 'g's and 'y's look bitten off.

I'm not just being a typography bore - a screen of text on this card looks really messy. There's a lesson to learn, which I shall certainly bear in mind when I have to buy a VGA card. Check you can live with the text which appears on a text mode screen - after all, it's the mode you'll use most.

## Timeworks DTP 1.2

The new version of *Timeworks DTP* has arrived. Among the heralded changes to the program, like support for extra text and graphics formats and increased font usage, is another goody which GST haven't said nearly as much about. It is, nonetheless, of great importance to anyone loading a lot of text into a *Timeworks* document, and adds another Ventura-style feature to the program.

You can now add paragraph style names to a text file by enclosing them in angle brackets, <>, and *Timeworks* will automatically assign the style of that name to all succeeding paragraphs, or until another style is marked. This means that consistent use of embedded style marks can format a manuscript completely automatically - a great boon in producing longer documents.

## TopDOS 'Editor'

Having sung the praises of *TopDOS*, the MS-DOS improver which makes working with the operating system tolerable, I have to report a nasty which cost me not a few hours work the other day. The built-in editor, which is very handy and produces nice clean ASCII files, is not so clean when editing a file from a nearly full disk. When you come to resave the edited file, all seems to go well until you exit the editor and check the disk directory. The filename's there but the filelength is 0 bytes.

The file has not been saved and the old version has been erased. A pretty effective way of losing the data, as some sort of overwrite is performed on the disk, destroying the cluster links which would help a program like Norton Utilities from

undeleting it. The batch file which controls the *PC Plus SuperDisk* underwent this 'backup' the other week and had me working til one in the morning. *NewStar* need to do something about this.

## DOS batches

It's very easy to add new commands to DOS in the form of short batch files. These can easily be tailored to offer just the facilities you need. One function I've always wanted is to create and move to a new sub-directory in one operation. Typical use of such a function would be to create a directory when installing a new application. The following batch file, which you might save as *NEWDIR* or something similar, will do the trick:

```
echo off
cls
echo Making and moving to direc-
tory %1...
MD %1
CD %1
```

You would run it by typing *NEWDIR <directory name>*.

## BASIC 2 Plus

This morning I received a full production version of Locomotive Software's *BASIC 2 Plus*, the new version of the GEM-based language which was originally supplied with Amstrad PC 1512s and PC 1640s. It is a complete revamp, with lots of extra structures and commands, and gives many other modern languages a very good run for their money.

Perhaps the biggest single advance is in the use of modules. In many ways similar to a module in *Modula 2*, *BASIC 2 Plus* can pass parameters to separate pieces of code, which can themselves be in *BASIC* or machine code, and return values from them to the main program. Modules can be loaded and unloaded as needed while a *BASIC 2 Plus* program is running, and gives scope for larger programs than before.

The editor has also been overhauled, with full search and replace, auto-indentation of source code, an outline view of the program structure and a clipboard for moving sections of code around. The editor has been combined with a comprehensive set of debugging tools, including breakpoints, single stepping and an autotrace mode which bounces the cursor from one command to the next as the program executes.

Existing *BASIC 2* programs may need some minor amendments, as the syntax of the new version of the language is in some places tighter than before. Most will show some speed improvement, though. When I've had the chance to become more familiar with the language, I'll let you know how well it lives up to the foregoing claims. You can also see a review of the product in the next issue of *PC Plus*.

Simon Williams

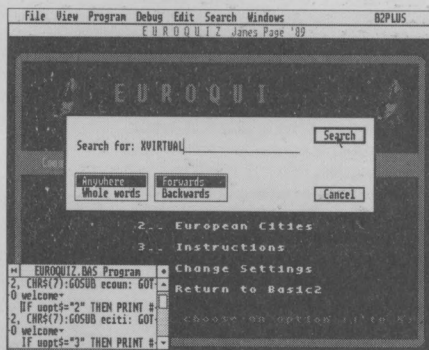

• *BASIC 2 Plus* includes a comprehensive search and replace function, but seems to dislike 'Z's

# YOUR FORMAT

MACHINE SPECIFIC COLUMNS

## WESTONING LTD

DISK BOXES		5 1/4"				
Hinged Lid Lockable 3 1/2" or 5 1/4" Capacity	50 £3.75	100 £6.25	25	50	100	
Add £2 P&P if not ordered with disks.		DS/DD £8 £12 £22 DS/HD £12 £22 £40				
Disks certified 100% Error Free		Including Sleeves & Labels				
3 1/2" DS/DD						
720K 880K	25 £17 £18	50 £31 £33	100 £55 £63	200 £105 £120	400 £205 £235	600 £305 £345
Including Labels						
Prices include VAT & Carriage			VISA		3 1/2" Disk Labels	
SAME DAY DESPATCH. NO QUIBBLE GUARANTEE			100 £3.00		1000 £10	
			State either coloured or white tractor feed			

Dept NCE, 12 Sanderson Road, Westoning, Bedford, MK45 5JY. Tel: (0836) 775600 (0525) 718668

## • A SMALL SELECTION FROM • OUR WAREHOUSE

HARDWARE & PERIPHERALS (OFFERS WHILE STOCKS LAST)	RRP	WAVE
64C Connoisseur's Pack inc. 64C, Neos Mouse, Software etc.	£249.99	£132.99 A
Amiga 500 inc. FREE Modulator, Workbench 1.3 & Paint S/W	£499.99	£389.99 A
Amiga 500 "Miles Better" Pack inc. 500 FREE Air Miles	£499.00	£419.16 A
Amiga 1000 + A1050 256K RAM Expansion + A1081 HR Colour Monitor (A Bargain Not To Be Missed, Very Limited Stocks)	£1155.75	£596.85 ANC
Commodore A1084S HR Colour Stereo Monitor - Amiga/PC	£299.00	£269.10 A
Commodore A1010 3.5" External Drive - A500/PC1	£286.35	£88.99 C
Vortex System 2000 40MB Ext. Hard Disc inc. PSU, Fan, Util.	£573.85	£482.03 A
Cumana CAX354 3.5" 80T DS 1Meg Drive - Amiga	£99.95	£84.96 C
Commodore A590 20MB External Hard Disc - A500	£399.99	£359.99 A
Commodore A501 512K RAM Expansion/Real Time Clock - A500	£149.99	£129.35 C
PL-2 Lead-Printer Centronics Parallel (Round Cable)	£19.95	£6.98 E
Star LC10 Colour Parallel F&T Printer	£343.85	£202.54 A
Star LC2410 Parallel F&T NLQ 24Pin Printer	£458.85	£230.38 A

ARE YOU A PUBLIC SECTOR COMPANY, EDUCATION AUTHORITY, HEALTH AUTHORITY, LOCAL/COUNTY COUNCIL, GOVERNMENT DEPARTMENT, ETC? THEN TO OBTAIN WHAT MUST BE THE BEST COMMODORE PC & AMIGA PRICES AVAILABLE WRITE TO US ASKING FOR OUR TRADE PUBLIC SECTOR DIVISION PRICE LIST.

### BLANK DISCS, SOFTWARE & BOOKS

Abacus Books Vol 1 Amiga for Beginners	£12.95	£10.36 E
Abacus Books Vol 2 Amiga BASIC - Inside & Out	£18.95	£15.16 E
Abacus Books Vol 3 Amiga 3D Graphic Programming in BASIC	£18.45	£14.76 D
Abacus Books Vol 4 Amiga Machine Language	£14.95	£11.96 D
Abacus Books Vol 5 Amiga Tricks & Tips	£14.95	£11.96 D
Abacus Books Vol 6 Amiga System Programmer's Guide	£32.95	£26.36 D
Abacus Books Vol 8 Amiga DOS Inside & Out	£18.45	£14.76 E
Abacus Disc for the Book (State Vol No: Req)	£13.95	£8.37 F
Verbatim 3.5" DS/DD 135TPI Bulk Discs C/W Labels. Pkt 10	£25.00	£8.75 E
YU-DS80L D.B. Lockable Storage Box Holds 80 3.5"	£23.77	£7.13 D

### DO YOU WANT TO SAVE MONEY? THEN SEND FOR OUR TRADE PRICE LIST

STATE FOR WHICH PRODUCTS AND ENCLOSE 3 x 19p STAMPS  
CAPTAIN CAVEMAN BBS NOW ON LINE 24 HRS MON-SAT 0229 473609  
ENG. MAINLAND post & ins.: (A) £5.75, (B) £4.60, (C) £3.45, (D) £2.30, (E) £1.15, (F) 58p  
(ANC) 3 Day £10.35, Next Day £13.80, COD + £2.30, Max. UK Postal Charge. £6.90 per 20kg/£500  
ALL PRICES INCLUDE V.A.T. All sales subject to our Trade Terms of Trading

W.A.V.E. (Trade Dept. NCE 1610)

WALNEY AUDIO VISUAL & ELECTRICAL DISTRIBUTION

1 Buccleuch Street, Barrow-in-Furness, Cumbria LA14 1SR

Tel: 0229-870000 (6 lines) Hours: Mon-Fri 10.00-5.00

### SPECTRUM TAPE TO DRIVE

Transpack I - for all drive systems. Includes CU5 and other software and sample transfers. Not for the novice...£12.00. For the difficult programs information books 1, 2 or 3 - 160 + Transfers per book with PT6...£2.50 each. Send S.A.E. for lists.

### M/DRIVE OWNERS - MICROMATES

It pays for itself!...£11.99. Format (approx 104K), Clone, Sector Editor, Rename, Reconditions & Repairs, Multi-erase, Cat Copies tape to drive (not games) & Reverse, Drive to drive on Cartridge.



Spectrum Cold Compressor .....£4.50  
M/Drive Cartridge (Min. 4) .....£1.75 each  
+3 Discs (Min. 4) .....£2.30 each



### SPECTRUM TAPE TO TAPE

TUC - copies most tapes. Measures loading speed, copies exactly blocks even over 51K + much more...£8.50

### PLUS - 3 MATE

For Spectrum +3. Plus 3 mate has 5 disk programme inc. full Cat, Disk Repair/Verify, Uneraser, Sector Editor, Multiple Erase + File Copier, Disk Info, Boot Prog., etc. Includes Clone whole disk copier (inc. protected disks) On Disk...£12.99.

### AMSTRAD/SPECTRUM VERSION Z80 TOOL KIT 2

Inc. Single Step - helps you understand/Debug M/Code, Assembler, + programme to do the reverse M/Code to Source. Disassembler, Hex to Dec, Tool Kit, Loader Mode, etc.  
Spectrum.....£8.99 Amstrad/PC Version.....£9.99

Send S.A.E. for details. Post Free in U.K. - Add £1.00 Europe - £2.00 rest. State your system when ordering. e.g. Spectrum +2 and Microdrive. Money back guarantee on software. Prop. L. Evans

LERM, Dept NCE 2, 11 Beaconsfield Close, Whitley Bay, Tyne and Wear, ME25 9UW, Telephone: 091 253 3615. Send S.A.E. for details

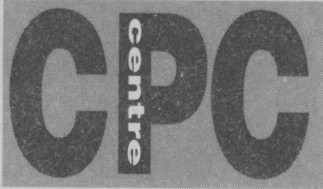

**Tuning in**

Amstrad is wooing currently CPC-less punters with a new 6128 bundle. For £399 you get a CPC 6128 with colour monitor and free TV tuner. This natty little (not so little, actually) device will turn your monitor into a fully-fledged colour TV, giving potential CPC-ers even more leverage when it comes to negotiating deals with the holders of the household finances. After all, with every 6128 purchased you're now getting a colour TV absolutely free!

And there's more. Included in the bundle are 17 games, including *Monopoly*, *Scalextric*, *Cluedo*, *Trivial Pursuit* and *Scrabble*.

Nice one, Amstrad!

**Chinese whispers**

I had a rather disturbing letter just the other day from a Miss J E Graham, who's just had an extremely bizarre communication following an order she sent to a certain mail order company. She writes:

"Could you please answer a question. Is the Amstrad CPC range being discontinued after Christmas? I wrote to this company for a price list of their Amstrad CPC peripherals and serious software. They replied saying it was not possible to forward a price list because it had been brought to their attention that Amstrad may be discontinuing the CPC range after Christmas. This was not certain but they had cause to believe it (1) because of the source and (2) because Amstrad have no plans to advertise the CPC

range over Christmas.

I have just bought *Stop Press* and mouse, and I was planning on purchasing some serious software such as *Protext* or *Brunword*, but I am reluctant to do so if this is true. I have had my Amstrad 6128 less than a year and must admit I am more than a little upset if this is true.

Please, if possible, tell me the truth. Is the Amstrad CPC done for? Should I cut my losses and by an XXXXX or XXXXX?" (Names deleted to avoid offending readers' sensibilities - ed.)

Well, Miss Graham, we can tell you the truth. (1) Amstrad is certainly not dropping the CPC. (2) Amstrad is spending £600,000 on promoting the CPC range, starting in November. Also, even when the CPC is finally dropped, support from the peripherals and software companies will continue for a long, long time given the large existing user base.

I spoke to the company you wrote to, and they told me they were still undecided about whether to carry on selling the CPC because of all the uncertainty, and felt it was only fair to warn people. You can't blame them, I suppose, but they're the ones who are going to lose out - it just goes to show how damaging unsubstantiated rumours and scaremongering are.

Fear not, Miss Graham, your CPC is good for many more years yet.

**Alternative humour**

With Christmas now all but upon us (well, two months away actually, which in the world of hype is the same thing), the first Christmas game has appeared.

*The Official Father Christmas* will be appearing on November 1st, courtesy of Alternative Software, and will set you back no more than £2.99. Even better is the news that all royalties from the game are to go to Save the Children. How worthy can you get?

In the game you play the rosy-cheeked

**Murderous cheat**

Fans of that unsung classic *Ninja Massacre* will no doubt be thrilled with this excellent cheat from Alec Warring of Burnham-on-Sea.

Simple hold down the T, A and G keys simultaneously when you start each game. This allows you to start from where you left off (or died) on the previ-

ous game, and also, when the game is first loaded, it will get you access to a special screen laden with goodies.

buffoon himself as you tackle a variety of levels of seasonal gameplay. In level one you have to build a sleigh, in level two you must collect toys from the elves who make them (who, being elves, are inclined to be mischievous and not let you have them), and in level three you must type out a list of toys to be delivered on Christmas Day. (Write this down: Rod Lawton, 64b Poorhouse Lane...)

Finally, in your role as Father Christmas, you must deliver your toys to locations throughout the world, including Europe, America, Australia and Africa.

**War - Huh! What is it good for?**

Well, it's good for a jolly good blast on the old CPC, actually. *War Machine* is a new budget release from Players. For £2.99 you get a good, solid blast-em-up with a fair bit of mapping and weapon-collecting thrown in too.

The plot centres on the fate of the mining installation on asteroid XR27B. Prime suspects are the Alien Syndicate, and if they gain control of the base there will be nothing to stop them etc etc.

Well, I'm sure you

get the idea. The plot is ever so slightly secondary to the action anyway, which is carried along by nice sprites, solid, colourful backgrounds and neat but nasty opponents. These include evil bio-mechanoid bloodsuckers, so be warned. One particularly nice touch are the armour-corroding acid baths awaiting the careless combat marine. These engulf your sprite in a cloud of ionising alloys (© O-Level Chemistry, 1974), finally finishing off your hero in a seriously psychedelic explosion if you don't jump out sharpish.

Rod Lawton



• Exclusive! Alternative's new Christmas game licence deal signed by the one and only real Father Christmas! Oh yeah? Pull the other one, it's got (sleigh) bells on it...



**The return of the Multiface**

Excellent news! Romantic Robot's spiffing peripheral the Multiface is good, honest, decent, legal and now back on sale. You'll probably remember the emotional scenes in Spex when the company announced that due to the passing of new copyright legislation the whole family of Multifaces were technically illegal to sell and had to be given a one way ticket to South America. Well now, after extensive advice, it's been decided that the amazing snapshot/hacking/back up device doesn't contravene the copy right bill and is a perfectly respectable member of the add on community.

Anyone with a Multiface tucked in the back of their Spectrum will tell you what good news this is because when it comes to perfectly legal but very troublesome operations like hacking, screen dumps and transferring tape based progs to disc, the Multiface makes them considerably hassle free. Every Spectrum owner should have one!

Details from Romantic Robot at 54 Dean-scroft Avenue, London. NW9 8EN

**New Outlet opens**

Outlet is the name of a techie based diskzine

that's received several bathroom's worth of plugs in past columns. Each mention has been much deserved too, because when it comes to the serious side of the Specky this mag provides everything a self respecting techno buff could want, every month and on every format, with one glaring exception. The hurrah-inducing news from the publication's publisher, Chezron Software, is that *Outlet* will now be made available to the one class of Spectrum owner which's been left out up 'till now - the hard done by +3 user. And although the 3-inch disk you get it on looks pretty much like every other three inch slab of plastic, +3 versions of *Outlet* will make use of a snazzy megaformat routine called *Supermat*.

This program somehow manages to squeeze an extra 38K out of every disc you ask it to format. The author of *Supermat* points out that means a saving of 22p on every 3-inch disc and £22,000 on every million disks you purchase. Chezron Software is obviously pretty generous because the aforementioned format extender is actually included on the latest issue of *OUTLET*, and the price is still under a million quid. Also on the latest issue (number 26) are some nicely programmed games, news, letters, reviews, programs and a truly impressive graphics demo called *Other Worlds*. A lot of the stuff on each issue is branded freeware, which like public domain software you're positively encouraged to copy and distribute amongst fellow users. In this case it's of a very high quality.

*Outlet* is absolutely essential reading for people who yearn and crave more material on the non-games side of the Spectrum and now that +3 owners are catered for, everyone can enjoy the fun. *Outlet*'s available on

microdrive cartridge, Discovery, +D and Disciple disk as well as humble cassette tape and, of course, +3 disc. Chezron are also planning a SAM Coupé version. Now no one's got an excuse not to try a copy. Send a blank disc/cartridge (not tape) for a free demo or £2 for a full blown. Send an S.A.E. for more details of the +3 version to: Chezron Software, 605 Loughborough Road, Birstall, Leicester, LE4 4NJ.

**Loyalty test**

I've just been the lucky recipient of a very nice letter from Rog Pile of Cornwall. Rog had some interesting things to say about Spectrum loyalty which I think you'd benefit from reading:-

"Have you noticed how many people say that they're going to buy a 16 bit machine but still intend hanging on to their Spectrums? It's curious how much loyalty the machine inspires. Well, actually, I'm going to get an ST too... and I'm hanging on to my Specky. Can anyone think of another machine which it's possible to get a wider range of quality budget games for?"

In a word, NO. They'd also be pushed to find a machine which gives you access to a wider variety or larger selection of highly playable, superbly programmed games that our machine offers.

Anyway, Rog also wants to recommend a purveyor of adventure software that he's a huge fan of. "Adventure game enthusiasts could do worse than get in touch with Linda Wright's Marlin Games at 19 Briar Close, Nailsea, Bristol. BS19 1QG." Rog tells me that this company offers excellent adventures at low prices and send orders return of post. Sounds like something the adventurous amongst you might want to check out.

Finally-"Whatever happened to the Plus 3 users club Lee Davis intended starting up? I wrote to him shortly after he published his address, enclosing an s.a.e., but no reply. Heard anything?" He asks. Unfortunately I haven't heard any more but if anyone out there has I'd be grateful for any info you could pass on.

Thanks to Rog for writing, keep sending your letters about any aspect of Spectrum-rum to Robin Alway, New Computer Express, 4 Queen Street, Bath, BA1 1EJ.

**Action pack**

Here's a tip for any purchasers of the new Sinclair Action Pack bundle:

Whatever you do, don't try to use the restyled Sinclair joystick lurking somewhere inside the package. To get straight to the point, it's the worst game controller ever. The handling's abysmal, the fire buttons only work once every five presses and it's the least aesthetically pleasing 'stick since, well the last one Amstrad bundled with the Spectrum. The thing looks like it cost Amstrad 3p to make and that's the number of minutes of use you'll get from it. This thing will ruin the best games. Don't even open the box.

Robin Alway

**Write on**

I'm always on the look out for interesting new Specky programs, hints tips, or whatever. If you know anything interesting drop me a line to Spex, Express, 4 Queen Street, Bath BA1 1EJ. Cheers!

# 520ST-FM SUPER PACK



**1Mb DISK DRIVE  
£450 OF SOFTWARE  
ARCADE GAMES**

Arkanoid II	Imagine	£19.95
Beyond The Ice Palace	Elite	£19.95
Black Lamp	Firebird	£19.95
Buggy Boy	Elite	£19.95
Chopper X	Mastertronic	£9.99
Ikari Warriors	Elite	£14.95
Marble Madness	Electronic Arts	£24.95
Quadralien	Logotron	£19.95
Ranarama	Hewson Consultants	£19.95
Return To Genesis	Firebird	£19.95
Roadwars	Melbourne House	£19.95
Starquake	Mandarin	£19.95
Test Drive	Electronic Arts	£24.95
Thrust	Firebird	£9.95
Thundercats	Elite	£19.95
Wizball	Ocean	£19.95
Xenon	Melbourne House	£19.95
Zynaps	Hewson Consultants	£19.95

**SPORTS SIMULATIONS**

Eddie Edwards Super Ski	Elite	£19.95
Seconds Out	Tynesoft	£19.95
Summer Olympiad '88	Tynesoft	£19.95

**PRODUCTIVITY SOFTWARE**

Organiser	Triangle Publishing	£49.95
-----------	---------------------	--------

**JOYSTICK**

Atari CX40 Joystick	Atari Corp	£4.99
---------------------	------------	-------

**FREE ATARI BUNDLE VALUE: £458.97**

**£399**  
INCLUDING VAT

With SM124 mono monitor: £498 INC VAT

With SC1224 colour monitor: £698 INC VAT

# 1040ST-FM PROFESSIONAL PACK

**NOW WITH TV MODULATOR**

For the serious home user and the small business, we are pleased to announce a new package based around the 1040ST-FM. The 1040ST-FM has 1Mbyte RAM and a 1Mbyte built-in disk drive. In addition, the 1040ST-FM now comes with a TV modulator built-in. (The previously available 1040ST-F was designed for use with a monitor only and did not come with a modulator.) This modulator only and did not come with a modulator.) This modulator only allows the 1040ST-F to be plugged directly into any domestic TV set, and comes complete with a lead to allow you to do so. The new 'Professional Pack' from Silica includes the new 1040ST-FM with modulator plus four high quality software packages including a spreadsheet, database, word processor and programming language. This 'Professional Pack' software will enable you to get straight down to business with your new computer. In addition to this software (worth £384.84), if you buy the Professional Pack from Silica Shop, you will also receive the Silica ST Starter Kit (worth over £200). Free Of Charge. Return the coupon for further information.



**£499**  
INCLUDING VAT

With SM124 mono monitor: £598 INC VAT

With SC1224 colour monitor: £798 INC VAT

ATARI 1040ST-FM	(Computer)	£499.99
VIP PROFESSIONAL	(Spreadsheet)	£149.95
MICROSOFT WRITE	(Word Processor)	£149.95
SUPERBASE PERSONAL	(Database)	£59.95
BASIC DISK & MANUAL	(Language)	£24.98

**NORMAL RRP: £884.82  
LESS DISCOUNT: -£385.82**

**PROFESSIONAL PACK PRICE: £499.00**

# 2Mb & 4Mb MEGA ST

The MEGA ST computers are styled as lightweight keyboard with a separate CPU, connected by a coiled telephone style cable. There are two versions of the MEGA ST, one with 2Mbytes of RAM and the other with 4Mbytes. Each version has a 1Mbyte double sided disk drive built-in to the CPU unit. The MEGA STs do not come with modulator built-in and must therefore be used with a monitor. With every MEGA ST purchased, we will add the 'Professional Pack' software (worth £384.83) detailed above, plus the Silica ST Starter Kit (worth over £200) both Free Of Charge. Return the coupon for further details.



**2Mb MEGA ST**

**£899** INC VAT

+ mono monitor = £998

+ colour monitor = £1198

**4Mb MEGA ST**

**£1199** INC VAT

+ mono monitor = £1298

+ colour monitor = £1498

# DTP PageStream £149 +VAT =£171.35

Desktop Publishing (DTP) is one of the fastest growing applications for personal computers. We are pleased to announce a powerful low cost package for the Atari ST called PageStream. PageStream costs only £149 (+VAT=£171.35) and, because it works with an Atari 1040ST and a Seikosha SP-180AI printer, you can be up and running with a complete system for less than £1000. Some of the features of PageStream are listed to the right. If you would like further information on this program, complete and return the coupon below, ticking the DTP box in the corner.

- \* TEXT-FLOW AROUND GRAPHICS
- \* ROTATION OF TEXT & GRAPHICS
- \* SLANT OR TWIST ANY OBJECT
- \* POSTSCRIPT COMPATIBLE
- \* TAG FUNCTION
- \* AUTO/MANUAL KERNING & HYPHENATION
- \* GROUPING OF OBJECTS

# ATARI ST COMPUTERS

The range of Atari ST computers offers something for everyone. From the games enthusiast who wants the challenge of the very best in arcade action, to the businessman who wants to make financial forecasts or faultless presentations. The ST offers high quality graphics, sound and speed for the gamer, whilst providing a fast, user friendly and affordable solution to business. The ST is now firmly established in the home environment and boasts a wealth of users in education, local government, television, and a variety of different businesses. Software for the range stretches to cover applications as diverse as ENTERTAINMENT, ACCOUNTS, ART, COMMUNICATIONS, COMPUTER AIDED DESIGN, DATABASES, DESKTOP PUBLISHING, EDUCATION, MUSIC, PROGRAMMING, SPREADSHEETS, WORD PROCESSING and more. For a full list of the software available, as well as details of the ST range, complete and return the coupon below.

All prices correct at the time of going to press. £80E.

# 520ST-FM EXPLORER PACK WITH BUILT-IN 1Mb DISK DRIVE



The value for money offered by the Atari ST range is reflected in the Explorer Pack featuring the 520ST-FM computer with 512K RAM. The 520ST-FM computer now comes with a built-in 1 Mb double sided disk drive as well as a free mouse controller and a built-in TV modulator. The new 520ST-FM Explorer Pack includes the 520ST-FM computer, the arcade game Ranarama, a tutorial program and some useful desktop accessories. In addition, if you buy the Explorer Pack from Silica, we will give you the Silica ST Starter Kit worth over £200, FREE OF CHARGE. Return the coupon for details of our Starter Kit and of the full ST range.

**£260**  
ONLY £2.51 PER WEEK  
RETURN COUPON FOR DETAILS  
+VAT=  
**£299**

+ SM124 mono monitor: £398 INC VAT

+ SC1224 colour monitor: £598 INC VAT

# WHY SILICA SHOP?

Before you decide when to buy your new Atari ST computer, we suggest you consider very carefully WHERE you buy it. There are MANY companies who can offer you a computer, a few peripherals and the top ten selling titles. There are FEWER companies who can offer a wide range of products for your computer and expert advice and help when you need it. There is ONLY ONE company who can provide the largest range of Atari ST related products in the UK, a full time Atari ST specialist technical helpline and in-depth after sales support, including free newsletters and brochures delivered to your door for as long as you require after you purchase your computer. That one company is Silica Shop. We have been established in the home computer field for ten years with an annual turnover in excess of £8 million and can now claim to meet our customers requirements with an accuracy and understanding which is second to none. But don't just take our word for it. Complete and return the coupon below for our latest literature and begin to experience the Silica Shop specialist Atari service.

- SILICA STARTER KIT:** Worth over £200, FREE with every Atari ST computer bought from Silica.
- PROFESSIONAL PACK:** Free business software with 1040ST-FM and MEGA STs bought from Silica.
- DEDICATED SERVICING:** 7 full-time Atari trained staff with years of experience on Atari servicing.
- THE FULL STOCK RANGE:** All of your Atari requirements from one place.
- AFTER SALES SUPPORT:** The staff at Silica are dedicated to help you get the best from your ST.
- FREE CATALOGUES:** Mailed direct to your home as soon as we print them, featuring offers as well as all of the new releases.
- FREE OVERNIGHT DELIVERY:** On all hardware orders shipped within the UK mainland.
- PRICE MATCH PROMISE:** We will match competitors on a 'same product same price' basis.
- FREE TECHNICAL HELPLINE:** Full time team of Atari technical experts always at your service.

**FREE SILICA STARTER KIT  
WORTH OVER £200**  
WITH EVERY ST - RETURN COUPON FOR DETAILS  
ALL PRICES QUOTED INCLUDE FREE UK DELIVERY

# DO YOU OWN AN ATARI ST?

If you already own an Atari ST computer and would like to be registered on our mailing list as an ST user, let us know. We will be pleased to send you copies of our price lists and newsletters FREE OF CHARGE as they become available. Complete the coupon and return it to our Sidcup branch and begin experiencing a specialist ST service that is second to none.

**SILICA SHOP:**

<b>SIDCUP (&amp; Mail Order)</b>	<b>01-309 1111</b>
1-4 The Mews, Hatherley Road, Sidcup, Kent, DA14 4DX	
OPEN: MON-SAT 9am - 5.30pm LATE NIGHT: FRIDAY 9am - 7pm	
<b>LONDON</b>	<b>01-580 4000</b>
52 Tottenham Court Road, London, W1P 0BA	
OPEN: MON-SAT 9.30am - 6.00pm LATE NIGHT: NONE	
<b>LONDON</b>	<b>01-629 1234 ext 3914</b>
Selfridges (1st floor), Oxford Street, London, W1A 1AB	
OPEN: MON-SAT 9am - 6.00pm LATE NIGHT: THURSDAY 9am - 8pm	

To: Silica Shop Ltd, Dept NCE 1089 \_1-4 The Mews, Hatherley Road, Sidcup, Kent, DA14 4DX  
**PLEASE SEND FREE LITERATURE ON THE ATARI ST**

Mr/Mrs/Ms: ..... Initials: ..... Surname: .....

Address: .....

.....

.....

.....

.....

.....

.....

.....

.....

.....

Do you already own a computer  
If so, which one do you own? .....

Postcode: ..... Dept NCE 1089

DTP

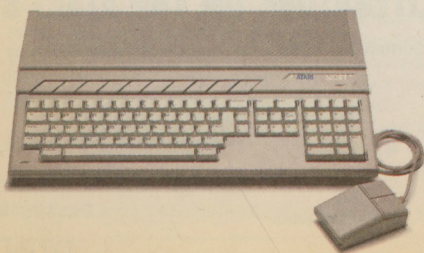

There's no catch. We're giving you the Atari 520 STFM and £500 worth of great software titles for just £399.99.

The twenty-three superb titles include some of the greatest games and three excellent programs which introduce you to the BASIC programming language, computer-created music and the more

**The Atari Power Pack.  
With £500 worth of software for starters.**

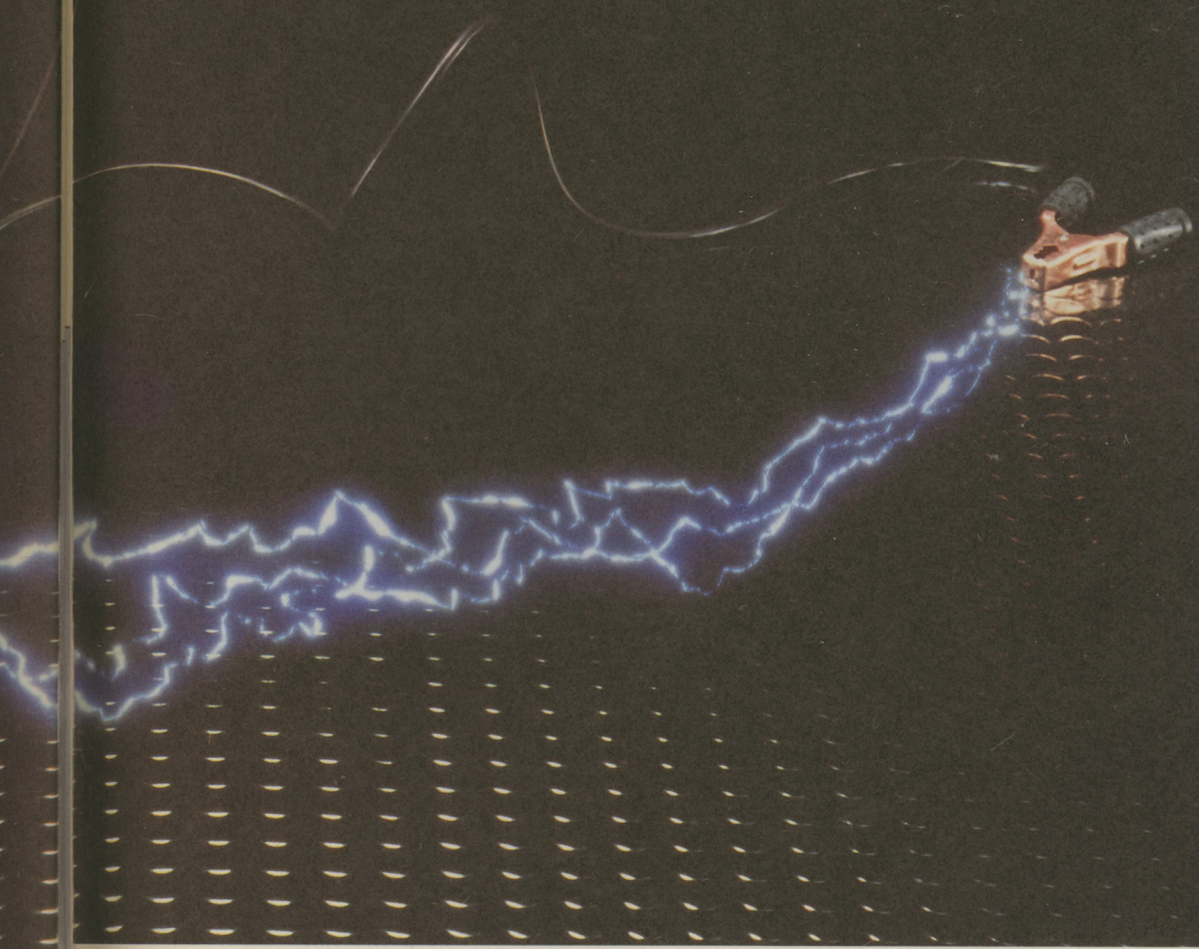

popular computer applications such as word processing and spreadsheets.

So take advantage of this great offer now. And be a bright spark.

For further information, just fill in the coupon.

Please send me details of this and other Atari products.

Name: \_\_\_\_\_

Address: \_\_\_\_\_

Phone No: \_\_\_\_\_

**ATARI POWER PACK**

## BEEB BOX

### Travelling man

The 'If it's Tuesday it must be England' syndrome doesn't often hit this particular scribe, but it certainly has this week. Off to a show in Holland one minute, back at another in England the next I feel distinctly jet lagged (well ferry lagged anyway) at the moment.

However the Big Ben meeting in Holland was as ever superbly well organised by Harry Linsen. A good time was had by all, not least the Dutch for whom the show is a welcome opportunity to catch up on English magazines and software. By the way if you ever feel hard done by for the cost of *New Computer Express*, in Holland up to seven quid for a British computer magazine is not uncommon. In spite of the cost there was a wide range of publications available, from the super glossy Byte type right down to DTPed mags produced by clubs. Two things only marred my trip. Lager louts on the ferry outwards made sleep impossible, and the theft of my camera bag in Amsterdam by a junkie was an unpleasant reminder of the crime prevalent in that city.

### Shareware club

Peter Cumberland of the Auntie BBEB shareware club has been in contact again. Latest

new from him is that the club has decided to concentrate on larger programs such as their BASIC to ROM compiler, now named SideRAM. Current projects the group is working on include a complete BASIC compiler, a DTP program and a PC emulator for the BEEB! Could be interesting, if it works. The group have now acquired an A3000, and the capability to develop programs for both machines using that system.

On the subject of shareware I was talking recently to Ian Copestake author of the *Wordpower* wordprocessor recently and his observations make interesting reading. "People don't quite understand the concept of shareware in the BBC market" He also added "I've had several responses from your piece, (in NCE) but what I really need is my address published" My response to the last comment is that everyone who wants to make use of the shareware concept needs to think about their marketing strategy very carefully. Just this once I will publish an address, but it's certainly not my policy to give free advertising. What you should be doing is talking to the advertisement department of the magazine so that the marketing effort is a coordinated one.

Ian Copestake Software, 10 Frost Drive, Wirral, L61 4XL.

My last point to would be shareware authors regards the actual program itself. And the message is; RAM IT DOWN THEIR THROATS! Put messages in the program itself explaining how to pay up. Don't rely on people reading documentation, they usually don't. Irritate someone enough and they might just fork out.

Andrew Brown

## SECTOR 64 SECTOR

### Hotter tips than a soldering iron

David Knowles of Great Barr, in Birmingham, has supplied yet more tips. He describes them modestly as 'short bits of nonsense' - not bad for nonsense, David!

#### Sideways

This one line routine appears rather odd, but type it in exactly as shown. Once it has been listed, it will appear a little different from the original. If a mistake is made, you must restart from the beginning as it cannot be edited. Remember that the square brackets contain a description of the key to be pressed - don't type in the square brackets!

```
10 FORI=1TO40:PRINT"[home][csr rt]";:
FORJ=1TO24:PRINT"[csr
left][inst][inst][inst][del][csr
down][csr rt]";:NEXTJ,I
```

Put something on the screen and run this routine. Watch it slide in to action.

#### Tintinabulation

Don't reach for the dictionary. Just type in this single line and run it for the answer.

```
5 S=54272:POKES+24,15:POKES+1,110:
POKES+5,9:POKES+6,9:POKES+4,17:
POKES+4,16
```

#### Program heading

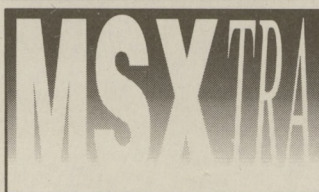

### Anyone for...

The MSX now has two versions of tennis for you to choose from, Konami's old *Tennis* and now Imageworks' new *Passing Shot*. Now Konami's *Tennis* was a pretty good name, and was as near to real *Tennis* as you will get on a home computer. How well then was *Passing Shot* going to compare with the former title. *Passing Shot* is supplied on cassette, and upon loading asks you for a skill level. An opponent is picked for you and it is then onto the game. You are presented with a back view of your player, which then changes to an overhead view immediately after service. The first thing that strikes you as odd, is the fact that you only see part of the playing area, the screen scrolling as you move your player around.

Now on the MSX this isn't too bad, as our computers offer a fairly large on screen picture. I can imagine the Commodore and Spectrum versions of this game are far harder to play due to their smaller playing area. Positioning your player for a return shot could be pretty difficult for a novice, and the scrolling playing area does take some getting used to. Graphics and sound are both pretty good, the action scrolling very smoothly. I have read reviews of this game on other formats, and it was only given a luke warm reception. My main crit-

John Torofex

If you would like to put a neat heading at the start of your BASIC program, simply add this line to the start of the treasured creation. Just press the keys referred to. Do not type in the square brackets.

```
0 REM""[del][rvs on]TTTTT[rvs off]
NOW TYPE THE HEADING YOU WANT
```

#### Wallpaper

Did you know that your C64 can produce a wallpaper pattern catalogue from just one line of BASIC?

Seeing is believing. Press the keys named but don't type in the square brackets.

```
5
A$="[blk][brn][grey1][yel][blu][grn][
pur]
[cyn][red][wht]";:N=N+1:FORJ=1TO1040:
R=JANDN:?:MID$(A$,R+1,1)"[rvs
on][space]";:NEXT:GOTO5
```

The colours will appear in the listing as reversed graphics symbols. When you are tired of the first 255 patterns alter the length and makeup of A\$ for a complete new catalogue!

#### Easy script music

No that's not what I mean! *Easyscript*, the well known word processor, is not capable of writing music.

However some issues of the program do contain an additional surprise. In command mode, press the F1 function key, then hold down CTRL while pressing key 3 (or the f key).

Try it for a patriotic interlude, but don't feel cheated if nothing happens on your version!

Thanks again to David for these tips.

Raj Chatterjee

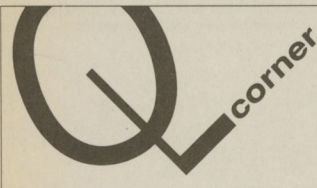

### Crashing QL

My QL recently started playing up; crashing a few minutes after being switched on. Following my own advice in this column, some months ago, I checked the obvious things like the mains plug, and the voltage regulator, but couldn't find anything wrong. I then pressed all the socketed chips firmly into their sockets and tried the machine out. As expected, this cured the problem.

This is well worth trying if your QL suddenly becomes unreliable; it only takes a few minutes, and could save you an unnecessary repair bill of £25 or more.

Sinclair used "cheap and nasty" sockets in the QL, to save a few pence, and chips sometimes work loose, because of thermal cycling. IC pins also get oxidised, resulting in intermittent contact problems.

### Another Hard Disk Interface

The latest issue of the Quanta newsletter mentions yet another hard disk system for the QL, produced by West German firm ABC-Elektronik. This plugs into the QL expansion port, and has a buffered through-connector for another peripheral card. Like the Miracle Systems interface, the ABC product is designed to take a low-cost PC/XT controller card. The cost of the inter-

face, with controller card, will probably be around £130.00.

This makes a total of four hard-disk systems for the QL (three commercial offerings and one DIY design). Not bad for a "technical oddity, not worth buying", as the QL was recently described in this magazine!

### Bristol Quanta Workshop

Quanta, the QL user group, is holding a one-day workshop in Portishead, near Bristol, on Sunday 12 November. As always, everyone is welcome. Contact Phil Borman on (0472) 49850 for details. There will be a "bring and buy" stand at the meeting, organised by the Bristol sub-group, and it is hoped that Tony (QDOS) Tebby, and Chas (*The Editor*) Dillon will be available, for question and answer sessions.

### Disk Firmware Upgrades

If you bought a disk interface for your QL a long time ago, or you have recently fitted a second-hand interface, it might be worth checking with QJump that you have the latest version of the firmware, in the EPROM on the interface. QJump can either re-program your old EPROM, or supply a new one. If you use one of the Micro Peripherals interfaces, with its non-standard firmware, QJump can provide an upgrade that makes the interface compatible with everyone else's. Apart from Micro Peripherals, all other interface manufacturers used AJump firmware.

QJump is at 24 King Street, Rampton, Cambridge, CB4 4QD. Tel: (0954) 50800.

cism is that it might be too easy, as I reached to semi final on the hardest level the first time I played the game, (must be years of playing Konami's version). Otherwise *Passing Shot* is a fair game, not as good as Konami's, but reasonable value at £9.95.

### News time

The good news for the MSX user is that many companies are still producing software for our machines.

- Grandslam have two titles coming our way shortly, *Liverpool* and *Peter Beardsley*, both of which appear to be somehow related to soccer (that took some working out).
- Titus confirmed that *Pipeline* will be their next release, but don't hold your breath waiting for it's appearance - it is not due for release until March next year.
- Blade Software, a relatively new company tell me that after the release of *Laser Squad*, look out for *Man Utd* (another football game) and *Lords of Chaos*.
- Not so good news from Level 9: they have no plans to convert any of their future titles to the MSX, probably because the market for English text adventure games on the MSX is so limited, MSX software being produced mainly for export.
- Ocean will be converting more titles to the MSX, but were being very cagey about revealing the names of the titles due for release. It wouldn't surprise me to see *Batman* converted to our format in the near future.
- Dinamic from Spain still write for the MSX, but as the UK market is so small, it is unlikely that we will see any more of their games over here.

Keith Neale



**A xxxing fortune**

It was Yorkshirewoman Vivian Nicholson who vowed on winning the pools to 'spend, spend, spend'. All my Dad would spend if he won a fortune would be his life drunk. If I won a million pounds, I'd probably just put it towards paying off my mortgage.

Anyway, you can find out what it's like to win a fortune with the help of a new pools prediction program, Poolsmaster, from Intraset, and a bit of luck, of course.

The program costs £18.95 from 02572 76800. Apparently there's already been a winner - a Mr Hammond of Chigwell, Essex, who pocketed £10,000. Should just about pay off his poll tax.

**Hard facts**

MK Chakravarti of Delhi asks me about hard disks for his PCW. He wants to get hold of one when he next comes to England, saying that hardware isn't too easy to get in India!

Well, Mr Chakravarti, I suggest you go for the Cirtech Diamond from Cirtech on 0896 57790. You can auto-boot from it, unique among hard disks.

It's also faster than any other hard disk, taking just 80 seconds to transfer a 1Mb file! It costs £465 for the 32Mb version or £545 for the 48Mb.

Other possibilities are the WEB (20Mb, £499, Timatic 0329 236727) or the System

2000 (40Mb, £499, Ideal Hardware 01 390 1211) - either would suit any small business or heavy private user fine.

**X ray aye**

Mr Chakravarti also wonders if the data on his disks will be adversely affected by the X-ray machines in use at airports (and particularly in Indian airports, where security is very friendly, but very tight indeed).

I've never heard of disks being corrupted by these machines, and one doctor I know even put a LocoScript disk in an X-ray tube. It still worked afterwards despite being given a minute's burst!

As always, you're best requesting a hand search of anything sensitive, but I don't think you need worry too much.

Besides, you keep a backup at home, don't you?

**Key sera sera**

Frequent users of BASIC may find it helpful to use the SETKEYS facility to assign to the function keys strings such as LIST, RUN [RETURN], EDIT, and SAVE.

For the last command remember you don't need the closing quote on the filename before hitting return.

You put a quotation mark into a setkeys file by typing "" and, er, that's it.

**Pig out**

A couple of people have asked me if I saw the letter in *Express* 46 from the nice lady who runs a farm outside Hereford and has named one of her pigs 'Basil' after me.

Yes, I have, and apparently Basil is doing very well, and should be in the freezer by Christmas. Ahh...

Basil Pigg



**Minerva multistore**

Another offering at the PC Show, and there were plenty, was the new database from Minerva. Not content with having one of the leading products in the Archie database market, *MultiStore* is a fully RISCOS program with some definite advantages over the company's earlier release, *System Delta Plus*. Firstly, it's fully multitasking. This means you can lift data from *MultiStore* straight into a RISCOS word processor or DTP (memory permitting). Secondly, it's fully relational, so you can link fields between databases and avoid storing the same data twice. You can, of course, display cards from more than one file on screen at once. Existing *System Delta Plus* files can be loaded directly into *MultiStore*.

The price of the product, £299, puts it firmly into the professional league, but that cost does include a report generator and mailmerge software for your mailing lists. Being RISCOS compatible also gives it access to Acorn's outline fonts and these are supported within the product for producing fancy labels and the like. Phone Minerva on (0392) 437756 for more details.

**Mandelbrot zoom**

It can get rather tedious when envious own-

ers of other micros continue to deride the Archie as only good for school kids and Mandelbrot. Nonetheless, it has to be said that Acorn's super-PC is very good at Mandelbrot.

There's a program called *Mandelbrot Zoom* in the public domain which illustrates this excellently. Starting with a picture of the entire set, which it draws in a couple of seconds, it lets you zoom in on any area, drawing new screens in well under a minute (unless you pick a completely black section). The display is in 256 colour mode 13 and looks more and more spectacular as you increase magnification. Being a Mandelbrot set, of course, you can zoom in as far as you like, revealing ever greater detail. The core calculation is written in ARM code, but everything else is in BASIC V.

I have a similar program, written in compiled C code which I occasionally run on my PC. This is a fast machine as PCs go, with an 80386 processor running at 25 MHz. The program does much the same as *Mandelbrot Zoom*, with one small difference - it takes up to an hour to draw each new screen!

**Economy drive**

I'm in the process of putting together a second floppy for my Archie. I've got together an old tape streamer case with power supply and a 40/80 track switchable 5.25-inch from a friend in the trade (I will pay you, honest, Tim). I've got all the cabling together and spent yesterday evening soldering the whole shebang together. It should work, but for one missing component. Down in the wilds of the South Hams it's hard to get hold of a sub-miniature 2A mains fuse!

Bertrum Carrot

**WAREHOUSE CLEARANCE**

JUST IN TIME FOR CHRISTMAS

**ATARI 520 STFM**

Never before at this incredible price. No so-called free-gifts, no worthless offers. Just great value for money. Package contains Atari 520 STFM, Operating Software, Manuals, Mouse etc, and all at the incredible low prices as below:-

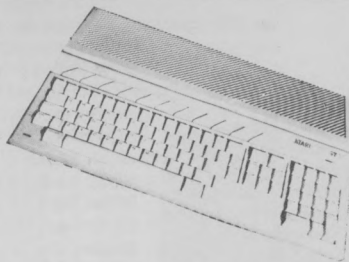

**520 STFM (1/2 Meg Drive) £175.00**  
**520 STFM (1 Meg Drive) £240.00**

All our prices include VAT  
Postage extra at £5.00

**WE HAVE VERY LIMITED STOCK, SO ORDER NOW OR BE DISAPPOINTED.**

**AMIGA A500**

The fabulous AMIGA A500 at an unfabulous price. Everything you want from a computer, and at an affordable price. Package consists of A500 Computer, T.V. Modulator, Mouse, Software and Manuals, etc.

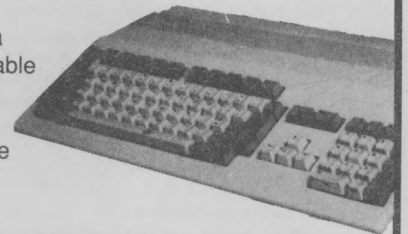

**ONLY FROM US AT THIS PRICE**  
**A500 £299.95 inc VAT**

Postage extra at £5.05

**WE HAVE VERY LIMITED STOCK AT THIS PRICE, SO ORDER NOW OR BE DISAPPOINTED.**

VISA/ACCESS orders welcome. Prices subject to change without notice. All transactions are subject to our standard conditions of sale, available upon request. Personal callers welcome by appointment.

All prices include VAT.  
Cheques/Postal orders with order.

**UK HOME COMPUTERS**

82 Churchward Avenue, Swindon, Wilts. SN2 1NH

Telephone: (0793) 695034



# TECH TIPS



**Personal computer problems? Express' Agony column has the answer. Write in strictest confidence to Uncle Techtip. The best tips win a freebie - so don't forget to tell us your address and machine**

## HELP! Driving on home

Here is an Amiga A500 problem that I would like you to solve for me.

Can I connect a CBM 1570 disk drive to my Commodore Amiga A500 and Datel twin external drive? If so, how much will the hardware and software cost?

Please advise where the items required can be purchased and also if there are any limitations.

J. J. A. Gurhy, Bamfurlong, Wigan.

I'm afraid not J. J., the 1570 is a serial drive with a lot of on-board controlling electronics that make connection of the drive to other computers very difficult. A nice idea, but it just won't work.

## HELP! Horse 'n' SCART

Recently I have heard and seen about a socket connection called

SCART. From what I gather, this allows you to connect your computer to a television giving better resolution. Can you please give other readers and myself all the information on this system?

S. J. G. Reeves, Solihull.

SCART is not a system. It's just another one of thousands of attempts to find the perfect connector between two electronic devices. A SCART plug looks like a slightly misshapen D, with a series of pins contained within. The SCART connector is used extensively on the continent to connect videos to TVs etc., and started to make in-roads into computing a few years with the advent of home computers. Unfortunately for the persons responsible for SCART (and who they are I have no idea - and care less so don't write) the connector standard has remained relatively obscure when compared with DIN and other methods of connection.

SCART in itself will not provide your computer with a higher resolution display on a standard television. What it will

do, is to allow you to connect a computer to a television offering composite or RGB input. Using these display standards you will get a clearer, sharper picture than with ordinary TV pictures which rely on the input signal being encoded then decoded (thereby deteriorating the picture quality).

## HELP! Creating a DIN?

I would be very pleased if you could help me with a small problem I have. I currently own an Atari ST, accompanied by a Philips TV/monitor with an RGB DIN connector. For some time now I have been using the TV display, and to be honest I don't think my eyes can take it for much longer.

I use this machine for graphics and for most of the time I find myself squinting at what I am doing (dark colours are the worst). For a couple of months now I have been looking for a lead which will fit the DIN connector and I still can't get hold of one. I would be very grateful if you could tell me of a place that can supply a suitable lead/DIN connector

W. Jackson, Blackley, Manchester.

Problem solved! Treble H Computing of Stevenage, Herts sells a wide variety of leads of all configurations. Bung them a cheque or postal order for the sum of £9.95 stating what you want and before

you can say Bob's your Aunt's live in lover, there'll be a satisfying thud on the doormat and the lead will have arrived, OK?

## HELP! Bare drives!

I'm thinking about buying a second disk drive for my Amstrad CPC6128. I'm thinking about a 3.5 inch drive, but instead of buying one of the 'plug in and go' units, I'd like to buy the drive mechanism unit on its own and build my own power supply. The trouble is, I've not got a clue where to get these drives, so could you please print the address of someone who supplies them and give me an idea of the price?

P. Harrison, Wigston Fields, Leicester.

Siren Software (84-86 Princess Street, Manchester M1 6NG) are the acknowledged leaders in drive supplies for the Amstrad CPC range. The company's 3.5-inch drive including Ramdos (which you'll need to get anything out of the drive) costs a reasonable £109.99 and comes with everything you need to get going.

If you're really bent on being difficult, you could buy the Siren Software offering, tear out the parts you don't want, throw them away and build your own. Alternatively, and I'm not being facetious, consult the Leicester Yellow Pages wherein you'll discover a veritable Aladdin's cave of computer suppliers who can let you have a drive. Cost should be about £70. Then you'll need to talk to

## HELP! Portable passion

I am looking for a portable or a laptop computer with a disk drive and a printer port. I dare say I will need a fair amount of memory or the possibility of expanding at a later date. What I want the computer to do is to handle lists of text, dates, years, and valuations and word processing.

As I am working on a small budget I intend to go to an auction, so if it is possible to suggest a few models that would fit the bill I would be very grateful.

As to the software, can you name any for the particular tasks in question or would I need some custom software written? If so how do I find a programmer?

C. Condron, East Ham, London.

Although you don't specify the fact, a portable/laptop computer with a disk drive almost certainly means a PC compatible portable or laptop, which means you're instantly transported to the over-£500 price bracket, and that's for the very cheapest, very flimsiest, most poorly specified machine you can find. However, buying a PC compatible portable does mean that you will have at least 512K (probably 640K) of valuable RAM memory to play with so the applications you wish to use will run quite happily.

So what's available, that's cheap, easy to use and

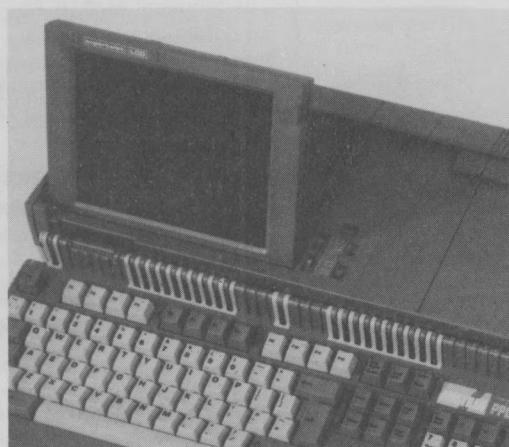

• Fancy a take away? The PPC could be the answer for C. Condron

provides all of the features necessary for competent computing? The Amstrad PPC range of machines are very usable, don't cost a great deal (they're the cheapest portable by far on the market), and are very well specified.

The range begins with the PPC512, a 512K RAM,

single floppy disk portable with a full size keyboard, printer and external monitor and user ports. Moving through a twin drive version, there's the PPC640, and it is this machine that has aroused the interests of jaded computer hacks everywhere. There's a built-in V21, V22, V23, V22bis modem of incredible quality which is almost worth the price of the computer alone. 640K RAM, a full size keyboard and more ports than you can shake a stick at complete the specifications. You can pick up a discounted PPC640 for around £600.

The idea of visiting an auction is a good one and should produce the desired result, although Amstrad computers do tend to hold or even expand their price a little at auction. But don't worry. Fix a ceiling on the amount of moolah you're prepared to part with, and don't sneeze or scratch your nose, or you may end up with more than you bargained - and bid - for.

You won't need to employ the services of a freelance programmer. They charge anything from £20 per hour upwards and anyway, there are commercially available programs covering everything.

If money is a little tight, have a rummage in the public domain for some freebies. Details of PD suppliers can be found in the back of Express and our sister magazine PC Plus.

Maplin Electronic Supplies (01 748 0926) to get the requisite parts for the power supply (probably about another £20). And finally you'll have to buy a copy of *Ramdos* or *Rodos* in order to make use of the drive. Are you beginning to see how the Siren Software deal is the best? Take some sound advice from your dear old Uncle - buy the Siren Software drive (can I have my palm crossed now please, Siren?).

## HELP! Looking for adventure

I have owned an Atari STFM for about two months now and so far I'm impressed as I used to have a Commodore 64. I am however, having problems with various aspects of word processing and programming. I am trying to start writing my own programs, adventures and such for the public domain. I know the basics of programming but I need to understand certain points in order to complete the adventures, so could you please explain the following points:

1. When writing an adventure how do you stop the computer from printing all possible choices? At the moment the text scrolls up the page before there is time to read it. Could you please show me a program that would pause the scrolling with a **MORE>** prompt at the bottom to give the adventurer time to read the text.

2. Could you also show me a program that would protect any unauthorised personnel from listing the program or in some way reviewing the program.

3. When I bought my computer the company provided disks with various programs to use running from GEM. On all the disks there are data files as well as program files. This really shows how uneducated I am at programming. I assume that most of these data files contain information that has to be printed out before it can be seen or used. But is there any way of actually accessing the program? On one disk there is an adventure game that I simply cannot gain access to. I would be very grateful if you could tell me how I can use such programs.

Roger Wyber, Bickleigh, Plymouth.

1. and 2. As you are obviously a novice programmer I don't think writing adventures is a good way to begin on the great road to programming proficiency (!). Begin by paying a visit to your local book store and buying a book detailing programming in BASIC which will help you to understand the finer points, and make solving the problems adventure writing present.

That doesn't solve the problem of giving vent to your adventurish creative bent does it? So why not invest £20 or so in STAC (*ST Adventure Creator*) from Incentive Software (call the company on 0734 817288). This program allows you to create wonderful adventures which can also feature pictures imported from graphics and paint packages, simply by defining the text you wish to print out, the locations and descriptions you wish to use etc., the program does all the hard work. It's an excellent package which received deservedly good reviews.

3. You can't just have access to the

programs on the disk. What you must do is to fire up the Atari BASIC program which came with the machine (full instructions in the ST's manual) then RUN the program from within BASIC. However, you may still encounter problems because the adventure program was written with an early version of ST BASIC which featured one or two wrinkles not supported by later versions. So if you encounter error messages when you try to run it, don't worry! It isn't the computer, but Atari's lousy programming.

## HELP! Colour micro?

I am about to make up my mind about which PC compatible to buy but I am a bit confused about monitors.

My main use will be word processing but I would like to progress into graphics and games later. Should I go for a colour monitor? Can I use my existing Hitachi TV for colour?

David Eldridge, March, Cambs.

I'm afraid you won't be able to use the Hitachi television to display colour on your PC compatible. If you can afford it, buy a machine with a colour monitor (there are many manufacturers offering deals on colour displays at the moment). If not, then buy a standard PC compatible and upgrade it with a CGA colour adapter card and colour monitor at a later date (many machines are shipped as standard with a CGA card).

A CGA adapter will cost you about £60 and a colour monitor will cost about £250. If you can stretch to a machine with colour monitor now, then expect to pay about £700, maybe less. The moral is 'shop around'.

TVs cannot be used to display signals output from PC compatible computers directly, although several companies do produce TV modulators which plug in to the expansion slots of the Amstrad range, reflecting their more games oriented image. ●

## HELP! Power PC?

I am a university student undertaking a degree in electrical and mechanical engineering, and now I need a powerful computer to help me in my own engineering work. The computer will preferably cost between £500 and £800 with a keyboard and high resolution monitor.

I am not after a computer with excellent quality output, but I am after power, cleverness and a computer that with its ability to cope with changing climates would not be swept off the market so easily. I want a computer that in itself contains the minimum of built-in features and one which is ingeniously designed machine which I can expand internally.

The prospective computer must be IBM compatible, it should be interesting to use and capable of undertaking the work of a professional.

At the moment I have been thinking about an Amiga 500 and an Archimedes 3000. But the Amiga seems to be a games machine and also seems to be rather outdated (! - Uncle TT), while the



• The sheer power of an Archimedes 3000 could tempt Mario Fillets

Archimedes 3000 is a super powerful computer but has no software to work with. Mario Fillets, Anttard, Malta.

Phew! A bumper crop of requirements there kids. Right, down to business. The Amiga 500 is a powerful computer that is rather under supported when it comes to serious software, although that position is changing all the time. As you said, the Archimedes is super powerful but again is under supported software-wise. You won't be able to get the power you require if you plump for one of the many PC

compatibles so what does that leave? Acorn's latest baby the Archimedes A3000 is a very nice machine. Using the same RISC technology as the Arc 310 but significantly cheaper (around £600) and with built in BBC and PC emulators it can make use of lots of existing serious software and there are machine specific software titles appearing all the time. It's fast, and sleek and powerful and there are advertisers in this and other magazines just itching to sell you one.

So what are you waiting for? Rush out and buy one...

## TIP Joystick japes

I had problem with my Atari ST computer and new joystick that I think your readers should here about so that they don't fall into the same trap. Although a pensioner (although a pensioner what? - Uncle Techtip) I play a large amount of shoot-'em-up and arcade style games and decided to buy an one of these latest autofire joysticks, so I went to my local computer supplies shop and bought one.

I took it home and plugged it into the ST but the computer hung up. Try as I might I just couldn't get the ST to respond to mouse or keyboard commands, it was completely locked up. I thought it must be broken so I bundled it into its packaging and took it to the shop where I bought it.

Guess what? When the engineer looked at it, it worked perfectly. I took it back home, feeling really pleased that I didn't have to spend any of my meagre funds to repair the computer, plugged in my new joystick to play a game and found that once again, the machine refused to work. It just sat there sulking. Anyway, to cut a long story short I realised that it was the joystick! Whenever it was plugged into the computer with the autofire option switched on, it sent so many signals to the computer that it couldn't cope and just locked up!

I hope that this is a warning to other Atari ST users who may be suffering the same annoying problem.

Andrew Petal, Kingsbridge, Devon.

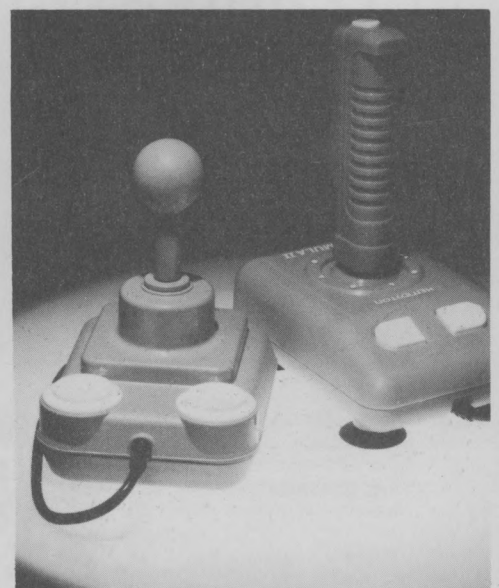

• ST owners beware - autofire joysticks can really screw you up

# COMPUTER CHAOS

*More microcomputer mayhem from the vaults of Mel Croucher*

## **USAF Malmstrom, Montana, USA**

The Pentagon confirms that a large part of the West's nuclear deterrent was out of action throughout 1986. They also confirm that during the 12 months nobody noticed. As the best brains in the land supervise the annual Christmas reprogramming of the Minuteman nuclear missiles, incorrect codings are fed into their failsafe systems by Strategic Air Command technicians. This means the rockets will not obey their electronic launch orders because they do not match the on-board codes. Naturally when the error is discovered the following Christmas the missiles are recommissioned to make the world a safer place.

## **Houston, Texas, USA**

Darlene Alexander is a school teacher with a clean credit record. She drives a second hand but fully paid up Datsun. On September 12th she applies for a \$75,000 mortgage. She is turned down because her credit records show her to be heavily in debt to American Express, Mastercard and Visa, as well as owing \$28,000 on a 1988 Chevrolet Camaro. Although she produces her own records to disprove these accusations she is still refused credit wherever she goes. It seems that a crook has stolen her identity, because of her perfect credit record, and run up a mass of fraudulent

debts. This leaves Miss Alexander with the prospect of taking the advice of Houston police lieutenant J F Rabago - to change her name fast "because nobody is going to change her record, and it stinks."

## **Software Symposium, Keele University**

The following statistics confirm that governments continue to spend taxpayers' money in the traditional manner. An analysis of £4 million of software used in nine government projects studied shows that 47 per cent was delivered but never used once, 29 per cent was paid for but never delivered, 19 per cent was delivered but abandoned as useless, three per cent was used after modifications, and a massive two per cent was used as delivered.

## **Long Beach, California**

Dr Yik San Kwok is director of research at the Long Beach Memorial Medical Centre. He invents a computer controlled robot arm to perform with pinpoint accuracy during brain surgery. The device calculate angles and dimensions and then performs drilling through the skull and needle biopsies on human heads. Naturally, it is carefully secured to prevent any accidental movement, which could be fatal, and the software is thoroughly tested before use. During

the second operation the second operation a power surge causes the arm to be an inch off target just as it is about to drill through the patient's skull. A quick-thinking neurosurgeon pulls the plug and comments "an inch is as good as a mile in the brain". After consultation with an electrician Dr Kwok has now added a surge suppressor to the power line.

(*New York Times*)

## **Sydney, Australia**

Sydney's new monorail has a GEC-140 Programmable Logic Controller located in its nose. Its job is to provide maximum comfort, safety and efficiency for passengers as they are whisked around town. Since last August, the automated system has developed a taste for little pranks, which include ignoring requests to stop, going home for a clean, and holding three dozen passengers prisoner for two hours while sucking out their fresh air and trying to cook them alive. The GEC programmer comments "You'd behave the same if you had to deal with those \*\*\*\*ers all day."

(*Computing Australia*)

## **Southampton, UK**

A Budd Co. assembly robot has apparently committed suicide after sniffing glue. Programmed to apply a complex bead of fluid adhesive non-stop, the robot grabs a handful

of caustic solvent then proceeds to shoot itself in its electronic chest. It is declared dead at the scene of the accident.

## **Mission Control, Volvo**

The following letter was sent to the recipient by their car dealer. 'Volvo has determined that a defect which relates to safety exists in Volvo cruise control systems of 1986 and 1987 Volvo automobiles... a malfunction in the microprocessor may unexpectedly engage the cruise control. We have also found that the application of the brake cancels the malfunction... Accordingly, we will replace the microprocessor of your cruise control at no charge to you.'

## **The Pentagon, USA**

A thief steals a computer from the Strategic Defense Initiative 'Star Wars' office during the night of April 10th. Consultants are rushed in to check the automatic security system, which has been expertly sabotaged, and also discover that the computerised video cameras have been emptied of recording tape. They repair the system. That night, a thief steals another computer from the same office, by sabotaging the automatic security system. Fortunately, the intruder forgets to tamper with the videos. Unfortunately, the consultants have forgotten to load the cameras.

## SHOPPING EXPRESS

BUYERS' GUIDE

AMIGA

ESSENTIALS

The guide to the vital software on your computer

Plus: The best computing bargains

Only 58p!

## DISPLAY TECHNOLOGY

■ How monitors are taking on the future

## IMAGE PROCESSING

■ The latest graphics techniques

## HOW WE WORK

■ The inside story of how Express is put together

## NEW COMPUTER EXCESS

■ The real facts behind the facade of the computer world

AND ALSO... The very latest in news WITH... Lively letters, terrific tech tips, fierce features, racy reviews, brilliant bargains, juicy jobs, value-added vouchers, hard-hitting humour

# FREE! TENSTAR PACK WORTH OVER £229!



FREE! - AMEGAS - by Players



FREE! - INSANITY FIGHT - by Microdeal



FREE! - ART OF CHESS - by SPA

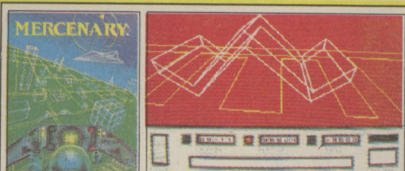

FREE! - MERCENARY COMP - by Novagen



FREE! - BARBARIAN, ULT WARRIOR - by Palace



FREE! - TERRORPODS - by Psygnosis

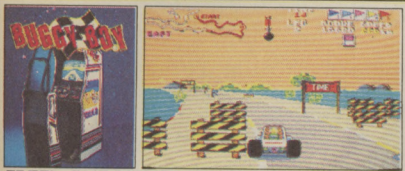

FREE! - BUGGY BOY - by Elite



FREE! - THUNDERCATS - by Elite



FREE! - IKARI WARRIORS - by Elite



FREE! - WIZBALL - by Ocean

# Commodore AMIGA



ONLY £3.34 PER WEEK  
RETURN COUPON FOR DETAILS

# £346.95

+VAT= £399

INCLUDES FREE UK DELIVERY

The Amiga 500 is one of a new breed of technologically advanced computers, which are now emerging as the new standard for home computing, based around the new Motorola 68000 chip. The A500 has 512K RAM and a 1Mbyte double sided disk drive built-in. It can be connected directly to a wide range of monitors, or to a domestic TV set through a TV modulator. Designed with the user in mind, the A500 features a user friendly WIMP environment and comes supplied with a free mouse. And, when you buy your Amiga from Silica Shop, the UK's No1 Amiga specialists, you will experience an after sales service that is second to none, including a technical support helpline and free newsletters and price lists. Return the coupon below for our current information pack, which will give details of the Silica service and the very latest Silica Amiga offers. E&OE

## WHY SILICA SHOP?

Before you decide when to buy your new Commodore Amiga computer, we suggest you consider very carefully WHERE you buy it. There are MANY companies who can offer you a computer, a few peripherals and the top ten selling titles. There are FEWER companies who can offer a wide range of products for your computer as well as expert advice and help when you need it. There is ONLY ONE company who can provide the largest range of Amiga related products in the UK, a full time Amiga specialist technical helpline and in-depth after sales support, including free newsletters and brochures delivered to your door for as long as you require after you purchase your computer. That one company is Silica Shop. We have been established in the home computer field for ten years and can now claim to meet our customers requirements with an accuracy and understanding which is second to none. Here are just some of the things we can offer you:

**THE FULL STOCK RANGE:** The largest range of Amiga related peripherals, accessories, books and software in the UK.

**AFTER SALES SUPPORT:** The staff at Silica Shop are dedicated to help you to get the best from your Amiga.

**FREE NEWSLETTERS:** Mailed direct to your home as soon as we print them, featuring offers and latest releases.

**FREE OVERNIGHT DELIVERY:** On all hardware orders shipped to Silica Shop customers within the UK mainland.

**PRICE MATCH PROMISE:** We will normally match our competitors offers on a 'same product same price' basis.

**FREE TECHNICAL HELPLINE:** Full time team of Amiga technical experts to help you with your technical queries.

But don't just take our word for it. Complete and return the coupon below for our latest Amiga literature and begin to experience the Silica Shop specialist Amiga service.

## PHOTON PAINT PACK

A500 Computer	£399.99
TV Modulator	£24.99
Photon Paint	£69.95
TenStar Pack	£229.50
<b>TOTAL RRP:</b>	<b>£724.43</b>
<b>LESS DISCOUNT:</b>	<b>£325.43</b>
<b>PACK PRICE INC VAT:</b>	<b>£399</b>

## 1084S MONITOR PACK

A500 Computer	£399.99
1084S Colour Monitor	£299.99
Photon Paint	£69.95
TenStar Pack	£229.50
<b>TOTAL RRP:</b>	<b>£999.43</b>
<b>LESS DISCOUNT:</b>	<b>£350.43</b>
<b>PACK PRICE INC VAT:</b>	<b>£649</b>

## FREE FROM SILICA

When you buy the Amiga 500 from Silica Shop, you will not only get a high power, value for money computer, we will also give you some spectacular free gifts. First of all, we are now including a TV modulator with every A500 stand alone keyboard, so you can plug your Amiga straight into your TV at home (the modulator is not included with the A500+A1084S pack as it is not required for use with monitors). Secondly, we have added a free copy of Photon Paint, an advanced graphics package with an RRP of £69.95. Last (and by no means least!), so that you can be up and running straight away, we are giving away the sensational TENSTAR GAMES PACK with every A500 purchased at Silica Shop. This pack features ten top Amiga titles which have a combined RRP of nearly £230! Return the coupon for details.

## FREE TENSTAR PACK

When you buy your Amiga 500 from Silica Shop, we want to make sure you get the best deal possible. That is why we are giving away the TENSTAR GAMES PACK worth nearly £230, absolutely FREE with every A500 purchased from us. The TenStar Games Pack includes ten titles for the A500, each individually packaged in its own casing with instructions.	<table border="0"> <tr> <td>Amegas</td> <td>£14.95</td> </tr> <tr> <td>Art Of Chess</td> <td>£24.95</td> </tr> <tr> <td>Barbarian, Ult Warrior</td> <td>£19.95</td> </tr> <tr> <td>Buggy Boy</td> <td>£24.95</td> </tr> <tr> <td>Ikari Warriors</td> <td>£24.95</td> </tr> <tr> <td>Insanity Fight</td> <td>£24.95</td> </tr> <tr> <td>Mercenary Comp</td> <td>£19.95</td> </tr> <tr> <td>Terrorpods</td> <td>£24.95</td> </tr> <tr> <td>Thundercats</td> <td>£24.95</td> </tr> <tr> <td>Wizball</td> <td>£24.95</td> </tr> <tr> <td><b>TOTAL RRP:</b></td> <td><b>£229.50</b></td> </tr> <tr> <td><b>INC VAT</b></td> <td><b>£229.50</b></td> </tr> </table>	Amegas	£14.95	Art Of Chess	£24.95	Barbarian, Ult Warrior	£19.95	Buggy Boy	£24.95	Ikari Warriors	£24.95	Insanity Fight	£24.95	Mercenary Comp	£19.95	Terrorpods	£24.95	Thundercats	£24.95	Wizball	£24.95	<b>TOTAL RRP:</b>	<b>£229.50</b>	<b>INC VAT</b>	<b>£229.50</b>
Amegas	£14.95																								
Art Of Chess	£24.95																								
Barbarian, Ult Warrior	£19.95																								
Buggy Boy	£24.95																								
Ikari Warriors	£24.95																								
Insanity Fight	£24.95																								
Mercenary Comp	£19.95																								
Terrorpods	£24.95																								
Thundercats	£24.95																								
Wizball	£24.95																								
<b>TOTAL RRP:</b>	<b>£229.50</b>																								
<b>INC VAT</b>	<b>£229.50</b>																								

## DO YOU OWN AN AMIGA?

If you already own an Amiga computer and would like to be registered on our mailing list as an Amiga user, let us know. We will be pleased to send you copies of our price lists and newsletters FREE OF CHARGE as they become available. Complete the coupon and return it to our Sidcup branch and begin experiencing a specialist Amiga service that is second to none.

### SILICA SHOP:

**SIDCUP (& Mail Order)** 01-309 1111  
1-4 The Mews, Hatherley Road, Sidcup, Kent, DA14 4DX  
OPEN: MON-SAT 9am - 5.30pm LATE NIGHT: FRIDAY 9am - 7pm

**LONDON** 01-580 4000  
52 Tottenham Court Road, London, W1P 0BA  
OPEN: MON-SAT 9.30am - 6.00pm LATE NIGHT: NONE

**LONDON** 01-629 1234 ext 3914  
Selfridges (1st floor), Oxford Street, London, W1A 1AB  
OPEN: MON-SAT 9am - 6.00pm LATE NIGHT: THURSDAY 9am - 8pm

To: Silica Shop Ltd, Dept NCE 1089 1-4 The Mews, Hatherley Road, Sidcup, Kent, DA14 4DX  
**PLEASE SEND ME FREE LITERATURE ON THE AMIGA**

Mr/Mrs/Ms: ..... Initials: ..... Surname: .....

Address: .....

Postcode: ..... Dept NCE 1089

Do you already own a computer  
If so, which one do you own?

# DATTEL ELECTRONICS

FULL  
720K  
CAPACITY

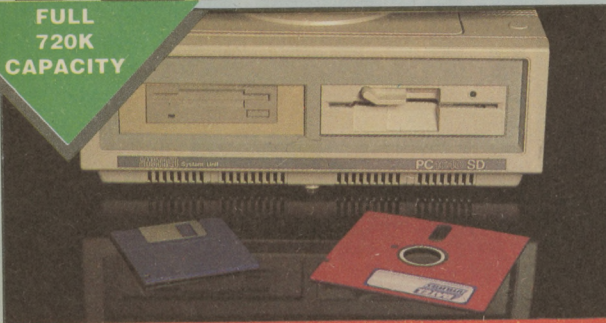

## 3.5" 1 MEG INTERNAL 2nd DRIVE FOR AMSTRAD 1512/1640 SD

- Easy to fit 3.5" 1 meg unformatted drive unit.
- Give your 1512/1640 a high capacity 720K drive for less than the price of Amstrad's 5.25" unit. No soldering or knowledge required.
- Now you can exchange data with portable Amstrad PC's or indeed any other 3.5" MSDOS machine.

- Easy to fit, comes complete with mounting tray/facia - takes about 10 minutes.
- Comes with install disk and utilities.
- Please state whether unit is required to fit on Right or Left Hand Side

**ONLY £89.99**

COMPLETE

NOW WITH  
STYLUS OPTION

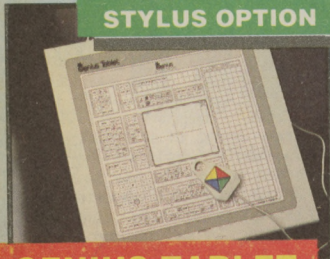

## GENIUS TABLET

- Top quality graphics tablet complete with graphics software, including Menu Maker & Dr Halo III packages (see Genius Mouse ad for full details of software).
- Data rate up to 19200 baud (switch selectable) RS232 or TTL outputs.
- Compatible with most leading CAD and Graphics packages, including: AUTOCAD, TURBOCAD, GENERIC CAD, FASTCAD, VERSACAD, ORCAD, EASYCAD, GEM, AUTOSKETCH, SYMPHONY, ETC. ETC.
- Comes complete with template for AUTOCAD.
- Operates in MM Serial (SUMMAGRA PHICS) mode or Microsoft or PC Mouse Emulation.
- Superbly styled complete with Puck and Flip Stand.

**ONLY £299.99**

Genius Tablet now has an optional Stylus available for extra flexibility.

**ONLY £29.99**

REMEMBER  
ALL OUR PRICES INCLUDE  
V.A.T. & CARRIAGE

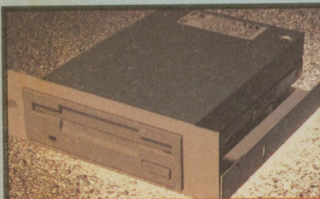

## 3.5" INTERNAL DRIVE FOR IBM/CLONES

- Simply fits into position for 5.25" drive - complete with mounting tray/facia.
- Full 720K formatted capacity.
- Top quality drive mechanism.
- Comes with install disk.

**ONLY £89.99**

## MEMORY UPGRADE FOR AMSTRAD 1512

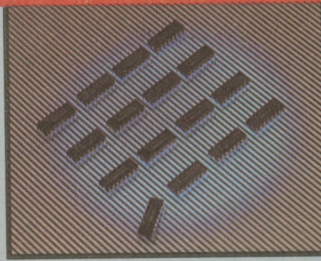

- Complete kit to upgrade your 1512 to a full 640K!
- 18 Fastram Chips - plus full instructions.
- Easily fitted in minutes.

**ONLY £39.99**

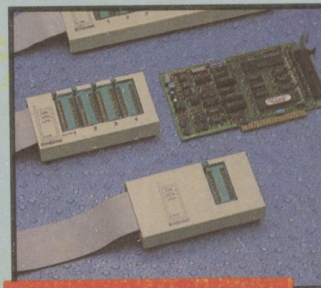

## EPROM PROGRAMMER

- New design unit to program even latest devices.
- Full menu drive option including:
- Device type - 2716 to 271024
- Voltage 12.5, 21.5V
- Normal, Quick Pulse, NGS MOS, User Algorithms.
- Copes with both 27 & 87 series.

Full Verify, Check, Read, Write, Blank Check, Modify, etc.

**ONLY £109.99**

## 4 GANG UNIT

- Same features but allows 4 chips to be programmed together.

**ONLY £139.99**

## QS-113 DELUXE JOYSTICK/INTERFACE



- Smooth tracking control sticks (can be set in either auto-centering mode or free-floating mode).
- X & Y-axis trim control switches.
- Auto-fire ON/OFF switch with positive response fire buttons.
- Contoured base with suction cups.
- IBM PC/XT/AT compatible half-size expansion card.
- Two 15-way D-type game ports and on-line selectable clock speed with 3-position speed selector.

**ONLY £29.99** COMPLETE

JOYSTICK & INTERFACE  
EXTRA JOYSTICKS AVAILABLE AT  
£17.99

FOR AMSTRAD  
2000 SERIES



## EXTERNAL 5.25" DRIVE

- High quality 360K (formatted) drive unit for all 2086 models.
- Plugs directly into external drive socket. Acts as drive B.
- Takes power directly from Amstrad.
- Attractive case in computer colours.
- Ready to go.

**PRICE £99.99**  
COMPLETE



## EXTERNAL 3.5" 1 MEG DISK DRIVE

- Now you can add a full 1 Meg (720K formatted) drive externally to your PC XT & compatibles.
- Acts as drive B - can be switched in or out to replace internal B drive for maximum flexibility.
- Very easy to install - top quality mechanism.

**ONLY £99.99**  
COMPLETE

## 3.5" SECOND DRIVE FOR PPC'S

- Top quality drive mechanism with biege facia.
- Direct plug in unit with full 720K capacity.
- Please state model type.

**ONLY £79.99**



## REPLACEMENT MOUSE 1512/1640

- High quality direct replacement for mouse on 1512/1640 models.
- Teflon glides for smoother movement.
- Rubber coated ball for minimum slip.
- Optical system counting - 500/mm.

**Special Offer - FREE Mouse Mat + Mouse House (worth £7.99).**

**ONLY £29.99** COMPLETE

ALL ORDERS NORMALLY DESPATCHED WITHIN 48 HRS

## HOW TO ORDER ...

### BY PHONE

0782 744707  
24hr Credit Card Line

### BY POST

Send cheques/POs made payable to "Datel Electronics"

### FAX

0782 744292

UK ORDERS POST FREE  
EUROPE ADD £1  
OVERSEAS ADD £3

PRICES AND SPECIFICATIONS CORRECT AT TIME OF PRESS AND SUBJECT TO CHANGE WITHOUT NOTICE

CALLERS WELCOME - Please reserve goods by telephone prior to visit.

# DATTEL ELECTRONICS

DATTEL ELECTRONICS LTD., FENTON INDUSTRIAL ESTATE  
GOVAN ROAD, FENTON, STOKE-ON-TRENT, ENGLAND.

SALES ONLY  
0782 744707

TECHNICAL ONLY  
0782 744324