

P E R S O N A L

COMPUTER

weekly

NEWS

JUNE 30 • 1984 • No 67

50p

MEMOTECH DRIVES
From home to business with
a CP/M disk system

SPECTRUM AID
The toolkit to help
Basic programmers

64 IN FLIGHT
Reach the heights with
an ace simulator

ATARI IN ACTION
A program to enhance
your graphic displays

Torch lights the way with Unix on the BBC



ANIROG



BONGO

Flight Path 737



Space Pilot

Bongo

Enjoy the hilarious antics of the comical mouse as he collects the lost diamonds. He climbs ladders, slides down chutes, use transporter and trampolines to jump across the divide. Multi screen game with three levels of difficulty.
Commodore 64 £7.95 — Vic 20 £7.95 — Spectrum £5.50

Space Pilot

Realise your dreams of being king of the open skies. Fly your aircraft into unrelenting dog fights with enemy fighters. Prove how well you can handle your craft. Five stages of tough engagements.
Commodore 64 £7.95 — Spectrum £5.50



Flight Path 737

An advanced Pilot Trainer. Written by a flight simulator instructor and pilot. Panoramic Pilot's eye view.
Commodore 64 £7.95 — Vic 20 £7.95

Also available on Disk at £9.95

TRADE ENQUIRIES: ANIROG SOFTWARE LTD. 29 WEST HILL DARTFORD KENT (0322) 92513/8
MAIL ORDER: 8 HIGH STREET HORLEY SURREY 24 HOUR CREDIT CARD SALES HORLEY (02934) 6083
PAYMENT BY CHEQUE P.O. ACCESS/VISA 50p POSTAGE & PACKAGING £2.00 OVERSEAS

REGULARS

Monitor 2

QL — now you have a choice, page 2; ACT scores Symphony coup, page 3; Vault attacks pirates' Trojan Horse, page 4; OFT raps Sinclair's knuckles, page 5; and Hewlett-Packard unwraps its PC packages, page 7.

PCN Charts 6

Latest moves in the games arena, plus the best-selling machines.

Random Access 8

Readers letters — and we pay for the best. This week: the Sinclair watchers respond to Sir Clive's comments reported in Issue 65.

Routine Inquiries 10

Problems solved here. This week: advice for Memotech, 64, Oric and Spectrum owners.

Microwaves 14

The place for your tips and routines. This week: help with Atari and Spectrum displays, and hints for BBC and Oric programmers.

Clubnet 15

We find some serious computing in north London where the club meets four nights a week.

Readout 16

Give your trigger finger a rest and take a look at the new computer books. We pick the best from the bunch.

Software Pre-View 36

A taste of things to come where we look at the packages that arrived in PCN's office this week.

Billboard 51

Pick up a bargain, or find a buyer for your unwanted equipment in our weekly micro marketplace.

Quit/Datelines 56

The bit at the back — essential reading for idiot-watchers. Plus forthcoming computing events in Britain and around the world.

SPECIALS

Atari on display 18

If the Display List Interrupt is giving you trouble, check out this explanation of how it works and add a little dash to your graphics.

MENU

June 30, 1984

No 67



Cover photograph by Pete Smith

COVER STORY

Light up the Beeb 28

Unix is the year's trendiest operating system. Once the province of mainframes, it's now becoming available for the larger business micros but Torch has broken new ground with its Unicorn add-on for the BBC Micro. Richard King puts the system through its paces.

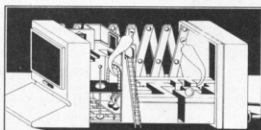
**Dragon slayers 21**

GO 21. READ PAGE. EXAMINE ARTICLE. Mike Gerrard takes a look at adventuring on the Dragon.

Z80 assembler 22

Continuing our look at programming this processor in its native language.

PERIPHERALS

Apples and mice 25

Continuing the rodent revolution started by Lisa and maintained on the Macintosh, Apple has put a mouse on the II series. Geof Wheelwright uncages the beast, complete with bundled software.

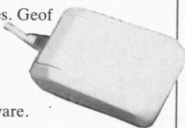
**Memotech disks 26**

The FDX disk system turns the Memotech from a home micro to a powerful system. We test the big, black box and examine the possibilities.

SOFTWARE

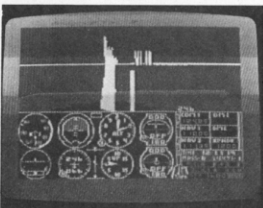
**64 in flight 38**

Reach for the sky with this red-hot flight simulator for the Commodore 64. Peter Worlock dons flying cap and goggles for the latest version of the renowned IBM flying machine.

Spectrum helpline 41

A new toolkit for Spectrum programmers gives you more of what you need to take the strain out of machine code program development.

GAMEPLAY

Dragon 43

Fast-shooting action with Laser Zone and Buzzard Bait. Survival is the watchword.

Spectrum 45

Action and strategy combine in The Warlock of Firetop Mountain and Worse Things Happen at Sea.

PROGRAMS

BBC Model B 47

Fast, arcade-style action in Hunchy, a colourful version of the arcade favourite.

GST takes them all on

By Ralph Bancroft

In a bold move to try to spring a new operating system on the world GST of Cambridge is launching 68K/OS as a low-cost alternative to Unix for 68000-based systems. Its springboard is a board version of the QL that it plans to sell on behalf of Sinclair.

GST was commissioned to write the operating system for the QL by Sinclair, but Sinclair finally decided to use the operating system written by an in-house team.

Since both systems were written to the same specification there are several similarities between 68K/OS and QDOS, though it is unlikely that programs written under QDOS will run under 68K/OS.

A brief demonstration of the GST product running on the QL showed significant advantages over the Sinclair offering, not least in Microdrive access times.

Motorola has taken a sufficient interest in 68K/OS to make it the

first European product to be added to its list of directly-supported software. Only five or six other companies, such as Digital Research, have received this accolade.

The operating system has been designed to be as compact as possible while offering a large amount of functionality under the memory- and hardware-intensive Unix.

As a result, 68K/OS can be accommodated on 32K of ROM and offer single-user, event-driven, multi-tasking with multiple screen windows and Unix-like pipes to transfer data between tasks.

The number of tasks that can be run concurrently is limited solely by the amount of memory that is available.

The disk filing system uses a number of advanced techniques to improve performance and speed of operations.

As with Unix, 68K/OS uses a customisable shell program as the

warns that severely damaged disks should be regarded as write-offs.

■ On the subject of fragile floppies, Inmac (09285 67551) has come up with a simple piece of hardware designed to extend the life of 5.25in or 8in disks. Operating on the same principal as reinforcing rings for sheets of paper in ring binders, Inmac's Fortifier kit lets you clamp a vinyl hub ring on to a floppy disk. For £9.50 you get an aluminium gizmo to centre the ring, a hand-press and 20 self-adhesive rings. Next week: a uniquely formulated depilatory to remove unsightly hair from your Mouse.

Flipped disks

Far be it from PCN to suggest the Commodore 1541 disk drive is accident-prone—we merely report the news, which in this case concerns a disk repair program called Doctadisk.

Doctadisk, from Mermaid Software (01-951 3355), has been launched for the 1541 and other D4 format drives. For £15.95 it promises you the opportunity to retrieve corrupted data and recover data from damaged disks. The program is said to be easy to use but Mermaid

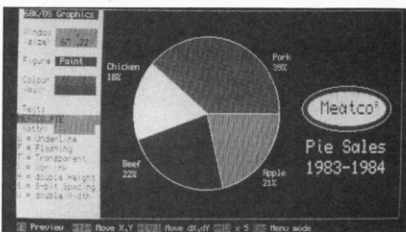

GST's 68K/OS shows off its graphics.

user interface. The standard shell features scrollable menus within screen windows and single-key selection of options and commands.

The operating system is designed to allow portability of programs between 68000-based machines. A device-independent input-output subsystem (IOSS) provides a standardised interface between applica-

tions programs and the hardware.

Meanwhile, QL owners may find 68K/OS available as a ROM upgrade to the QL. GST is emphatic that it has no intention of selling the system to end users. 'But we would be more interested in licensing the system to a distributor who wants to sell it to QL users,' said Jeff Genton, GST's managing director.

AT&T sets up IBM clash

Two of the world's biggest companies could clash head-on if American Telephone & Telegraph (AT&T) makes its expected announcement this week.

AT&T owns 25 per cent of Olivetti and currently has the option of increasing this to 40%.

AT&T's contender will run Unix as well as MSDOS, concurrent

CPM-86, the UCSDp-System and PCOS.

But both companies concerned were tightlipped about the launch. A spokeswoman for British Olivetti said: 'We know about it, but aren't in a position to talk about it.' Meanwhile, at AT&T in New York, spokeswoman Wilma Mathews also declined to comment. 'I can't confirm or deny,' she said.

The basic memory on Olivetti's M24 is 128K expandable to 384K and this, with two 320K floppies, costs £2,178.

ACT drops out

ACT's bid for Victor Technologies, maker of the Sirius micro, has fallen through.

The company has also announced its intention to launch a new product, currently code-named the Rascal, at the Royal Albert Hall this week.

ACT gave the reason for the collapse of the Victor negotiations as the time taken to finalise the talks.

The two companies have been in negotiation since February (Issue 49) and, according to ACT, it appeared the talks could drag on for another six weeks.

'As a result, ACT decided it was no longer viable to acquire the manufacturing base in California, and made a revised offer covering solely the French and West German (distribution) subsidiaries,' the company said.

'This revised proposal has been rejected by the creditors' committee, and negotiations are now at an end,' it said.

ACT submitted its revised offer in the wake of a fall in sales of the Sirius from 1250 a month earlier this year to around 700 a month. In the meantime sales of the Apricot have bounced up to an average of 4,000 machines a month.

The company was also facing two rival bidders for Victor which were prepared to pay a much higher amount than ACT had offered.

Much speculation surrounds the Rascal project which ACT says will 'make a measurable contribution' to the company's profits by the end of the year.

It seems likely the Rascal will be the low-cost alternative to the Apricot that PCN exclusively predicted (Issue 46).

Still aimed at business users it will be less powerful than the Apricot but offer compatibility with the more expensive machine.

Some sources suggest the machine will be a lap-held portable.

Full details will appear in next weeks issue.

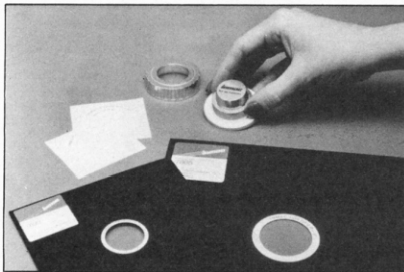

Fortify your floppies — Inmac's hub cap.

Amstrad meets its deadlines

Within the computer industry it is becoming the norm to advertise products for sale that have not been designed. Not so for Amstrad—the CPC 464 (Pro-Tested Issue 65) went on sale in London's West End last Thursday.

According to Amstrad you

should be able to purchase the CPC 464 at local computer dealers from this week. But the advertising campaign will not commence for a couple of months yet while a large enough stock of machines is built up to meet what is expected to be great demand.

ACT tunes up

By David Guest

ACT is expected to announce this week that the Lotus integrated package Symphony has been implemented on the Apricot.

Deliveries of Symphony for the IBM PC and XT are due to begin early next month. The schedule that Lotus Development Corporation produced for other machines did not originally include the Apricot, but the establishment of a software development group at Lotus Development (UK) laid the foundations of the Apricot version.

The system requirements for Symphony, Lotus's follow-up to the highly successful 1-2-3, on the Apricot are a minimum of 512K of RAM and either dual 3½in floppy disks or one floppy and one hard disk.

Apricot users can expect deliveries of the five-in-one Symphony package to begin in September. ACT is not expected to include the price of the software in the price of a new system; instead Symphony will be marketed for the Apricot as for

any other machine — either as a new product costing £550 or as a trade-up from 1-2-3 via the Lotus Users Club.

The software development group at Lotus UK's head office in Windsor is still being built up and a spokesman said that the Apricot work represented the start of support for European manufacturers. He declined to specify which systems might be the next to catch the company's eye.

The deal is a considerable coup for ACT, which has managed to announce Symphony in the week that the product is being introduced to dealers in the UK for the first time.

Symphony was first mooted last November, and as it has approached readiness it has generated widespread interest.

The package includes a word processor, database, graphics, spreadsheet, and communications, with window management and a command language also included. Lotus 1-2-3 users will be able to

move to Symphony by joining the Lotus Users Club for a fee of £200 — the difference in price between 1-2-3 and Symphony.

Emco Electronics, a London-based monitor and display company, has launched a £175 12in monitor for the ACT Apricot.

The Apricot normally comes with a 9in monitor and some users feel this is too small for some purposes. The Emco monitor is manufactured by Indesit, better known for its cold-care products, and will be available in two models styled to match both the Apricot and the Apricot xi.

An optional tilt and swivel stand will not be available until October but the monitor itself will be available in mid-July. Since the launch, ACT has announced it will also produce its own 12in monitor but this will cost £339 if bought separately.

If bought with the Apricot, the price of the machine and monitor increases by £100 over that of a system with the 9in monitor.

News in brief

Osborne clears final hurdle

A US bankruptcy court has approved Osborne's plan for reorganisation and cleared the way for the stricken portable manufacturer to start afresh.

Osborne US effectively becomes a new company under the plan. Its patient creditors will receive \$15.5 million, taking 20 per cent of the stock of the new firm. Osborne says it is now looking for investment capital for multiple new product development.

Tycom update

Plans to refloat Microframe-maker Tycom were proceeding in London last week despite inaccurate reports to the effect that the company had been bought by US businessman Ira Gale.

The City consortium which bought Tycom (Issue 65) is called Firefloat. Alan Timpany, managing director of Tycom, is likely to figure prominently in the new venture and the Tycom name will also be retained.

Inmos CMOS

As discussions continue over the future of Inmos, the UK's most controversial semiconductor firm has produced its first CMOS product.

The IMS 1423 is a 4Kx4 static RAM intended for use by the designers of such items as cache memories, DMA buffers, digital signal processors and graphics.

Meanwhile the row over the possible sale of Inmos to the US telecoms giant AT&T continues to simmer. The Government, which owns 75 per cent of Inmos, is known to be anxious to sell its stake but no announcement is expected for several weeks.

Disco sounds price retreat

Disk drives are coming down in price again. Disco Technology has introduced a half-height drive for the BBC and Apple computers at £149.

Imported in bulk, the drive comes complete with cables and manual but will obviously need the interface to be fitted inside the BBC.

For more information contact Disco Technology on 01-930 3619.

Intec turns to BBC storage

Hard disk maker Intec has released a range of Winchester disk add-ons for the BBC micro.

Units of 5Mb, 10Mb and 20Mb start at £1,399. They include on-board diagnostics, password handling, and directory sub-volumes. Intec claims that from a cold start you can set a system up in a matter of minutes.

EAGLE'S PACK — Risking no end of confusion a company called Eagle has launched a machine with Andromeda in the title and Sanyo written all over the numbering scheme. Eagle Consultants (01-839 6080) calls its Andromeda PMBC 550 Series 'the iron hand in a leather glove' but there is also a rugged version in an iron glove. Both models have 128K RAM as standard, an Intel 8088, and the capacity to take IBM PC floppies. The basic model costs £395 and the range includes a Winchester disk system at £2,395.

The line, incidentally, includes a model that boasts a 9in colour screen with WordStar included in the price of £1,490. Another unit, the version with the case built to military specifications, has performed normally after being immersed in 20 metres of water for a week.



US Xtra battles IBM

IBM's PC price cuts (Issue 65) continue to reverberate around the US business micro scene, but UK users can't expect any windfalls yet.

ITT is the latest to cut its prices in response — its Xtra competes directly with IBM's PC and XT.

Its prices are down by between 20 and 24 per cent, and the specifications of some models are rejigged. This puts the entry-level machine at \$1,895 compared to \$1,995 for the basic PC. Add \$100 to bring the ITT memory up to IBM level and the two are neck and neck.

STC, which sells the Xtra in the UK, says there is currently no need to reduce pricing here because IBM

cut prices shortly before the UK launch of the Xtra, and Xtra pricing was adjusted to reflect this. A spokesman told PCN that the company didn't see a price war starting in the UK, and saw the battleground as being more performance than price. Within six months to a year the basic PC/Xtra machines are likely to have 256K RAM as standard, while prices remain stable.

All this, of course, presupposes IBM doesn't up the ante by dropping prices some more.

Back in the US, Columbia, Corona, Televideo and Zenith are among the compatible manufactur-

ers which have cut prices, and others are expected to follow. Compaq, which is something of an industry standard among imitators of the industry standard, is currently denying that it intends to cut prices further.

How many of these price movements will reach the UK is an open question. When IBM cut its prices here earlier in the year it immediately found itself unable to meet demand, and dealers have been on a rota system of supply ever since. Since its recent US cuts are not to be repeated in the UK in the foreseeable future, prices may remain stable among the competition

VIEW FROM AMERICA



Shivers as micros miss tax relief

By Chris Rowley

In a move that sent a shiver through the microcomputer market this week, Congress set new restrictions on tax deductions for expensive cars and microcomputers.

Analysts immediately predicted much sharper attention to pricing details in the high end market. Furthermore, since surveys have shown that as many as 71 per cent of those planning to buy a computer this year cited tax preparation and financial management as their prime purchasing motive, loss of the tax deduction will actually boost sales of inexpensive home systems, such as from Commodore 64 or Coleco, which have slowed lately but which can easily handle the ordinary person's financial planning.

All of this comes at a bad time for high end micro makers. The summer doldrums are upon us. Schools and universities are not making purchasing decisions; small business is at the beach.

Even IBM just had to slash prices for PCs by up to 23 per cent since supply and demand for the phenomenally successful IBM PC has come into 'balance'.

Shortly afterwards IBM stock — 'the bell weather of Wall Street' — actually dipped below 100 for a day or so.

Among the IBM clones there is increasing gloom on Wall Street. Companies such as Eagle, Columbia and Compaq are trading just above their lows of the year, which are pretty low; Eagle has sunk from 24½ to 2¼, for instance.

These companies have, of course, traded in the rather plush gap between IBM's retail price and the real cost of assembling an IBM PC. Now that Big Blue is tightening the margins the future of most PC compats may be in doubt.

The fact is that all those confident projections of sales of more than 6,000,000 micros this year are being trimmed back sharply. Approximately 1.5 million projected home computer customers are now described as 'having absented themselves from the marketplace'.

Just possibly they over-reacted to the National Inquirer's recent campaign under banner headlines — 'HOME COMPUTERS — NEW THREAT TO MARRIAGES'. Yes, a wave of 'Personal Computer Love Triangles' is sweeping the land as spouses discover that the computer can never say no.

Purchasing a home computer has become a daunting task for the novice, it would seem. Can you imagine being one of the poor suckers who actually bought a full price PC Junior? Got stuck with an Osborne Dot? Bought a defective Adam? ... ugh, ugh, Americans like consumer durables they can feel proud of.

On Wall Street all this is regarded as confirmation of the warning given by spring bears when they mauled computer stocks on their way out of the market months ago.

Indeed there is now to be heard a faint whispering of 'the end is nigh for IBM' heresy! How anyone can believe this of a company that just reported \$1.2 billion profits off \$9.5 billion in revenues in the first quarter of the year is hard to imagine. But hold. The juju goes like this: 'IBM is taking advantage of its quasi-monopoly in large systems in large organisations,' says William Zachmann of International Data Corp, 'to ratchet up total costs in pursuit of profit objectives.'

Thus users of MVS/XA mainframe systems are paying as much as \$20,000 a month per computer for basic operating systems software. Some big IBM customers are starting to peel out of formation as a result and just over the horizon are Hitachi and Fujitsu who will be offering powerful new mainframes shortly.

Even closer at hand is AT&T and the Unix operating system which might conceivably bring AT&T into Big Blue's market.

Some analysts point to the PC Junior and its irrational pricing as evidence that the main company doesn't really understand microcomputers. Others point to the downward spiral in the costs of chips and hard disk memory storage and pose the question: a decade from now just where will the lines be drawn separating micro/mini/mainframe and will IBM get to draw them?

Beware pirates

A company that claims a world lead in software protection devices has opened a second front against pirates — through the courts.

The Vault Corporation (issue 25) has drafted an extension to existing contract law to cover illegally copied software. Vault's president Krag Broby was in London recently to look for a means of approaching the UK Government with the idea.

'The copyright law is too narrow,' he said, 'and patent law is better, but our Software Licence Enforcement proposal makes it a purely commercial matter. It's a popular approach because the legislators don't have to extend themselves,

and it's in the consumers' and the business's best interests.'

The proposal will make it possible for a software supplier to sue for breach of contract anybody found duplicating software. 'Our copyright protection system (Prolok) can cut out the casual copier; now we're going after the organised criminal.'

Prolok itself, he said, was selling well with more than one million Proloked disks in the field. Asked whether anybody would ever buy Prolok again if his proposal came on to the law books, Mr Broby commented: 'There are laws against breaking and entering but people put locks on their doors.'

Parker's new coverage

Atari software from Parker Video Games will soon become available to Spectrum and Commodore 64 users. Parker is heralding this move into pastures new with a change of name — it will now be known as Parker Software.

It is releasing three arcade games — Gyross, Star Wars and Dr Do's Castle plus Frogger II and Monte-

zumas Revenge.

Parker will not be issuing its games on cassette. For the Spectrum the games will be on ROM cartridge. They will be compatible with all Spectrum cartridge interfaces and will retail at around £20.

Commodore games will be on disk and will retail at around £28. Rae Potter, European product manager, predicts disk software playing a more prominent role in 1985.

Parker still intends to make all games available for the Atari 2600 and cartridges will cost around £30.

FLYING DUTCHMAN — Philips Business Systems, currently involved in talks with Warner's over a stake in Atari and with the French electronics giant Thompson over a home micro, is minding its own business with the launch of the P3100. It is claiming an advanced degree of IBM-compatibility, with 128K driven by an 8088; floppy disks of 320K may be used in pairs with a 10Mb hard disk. A prime feature is its display — characters are 16 x 13 dots, and in graphics mode 640 x 325 pixels. The P3100 base model costs about £2,000.



Redwood signs Uniplex pacts

CP/M is dead, long live Unix. This was Redwood's message as it announced a number of deals with system builders for its integrated Uniplex package on Unix micros.

Many of the deals will see Uniplex bundled with OEM equipment, while others will make Redwood's packages available to end users through distributors.

The Uniplex suite includes word-processing, database management via the IBM query language SQL, spreadsheet, menu design, screen

building and so on. Users should be able to purchase each application module for about £650, while the systems applications should cost about £200.

The package is written in C and Redwood has made sure users can tailor packages to their own whims, and even translate prompts to native languages with ease. The package is portable across Unix systems and Redwood is currently porting the system on to a variety of Unix micros.

Sinclair rapped

By Ralph Bancroft

Sir Clive Sinclair and his company have been forced to promise the Office of Fair Trading (OFT) that they will not 'induce customers into contracts with the company for the purchase of goods by knowingly, recklessly or negligently making false statements about the time within which goods are to be delivered.'

Failure to abide by the assurances could result in court action and if they fail to comply with a court

order, officers of the company and Sir Clive could end up in jail for contempt of court.

Sinclair was required to give the assurance following persistent complaints that between February 1980 and November 1982 the company promised in its advertising campaigns for the ZX80, ZX81 and the Spectrum deliveries within 28 days.

Yet during the summer of 1982 Sinclair's own estimate of delivery times was up to 12 weeks and some customers had to wait up to 16 weeks for delivery.

Although the OFT has been investigating the complaints for some time it has yet to check the enthusiasm with which Sinclair promised delivery on the OL when it was launched earlier this year.

But with the threat of court action now hanging over its head it is likely that Sinclair will want to ensure that it has a guaranteed supply before it continues to promote its new product.

It still faces a large backlog on OL orders and doesn't expect to clear the backlog before the end of August.



Sir Clive — on the run from the Office of Fair Trading?



CALL TO ARMS — The robots are coming, or so it would seem from the numbers currently being released. The above clutch are available from Powertran Cybernetics priced from £95, for the Hebot II (front and centre), to £1476 for the Genesis P102 (right). The latter is a hydraulically-powered arm with six degrees of freedom, its own microprocessor and RS232C inter-

face. All the robots are supplied in kit form with full assembly and programming instructions. For the more intricate (or lazy) among us, they are available ready assembled by special arrangement and probably cost. For further information contact: Powertran Cybernetics, Portway Industrial Estate, Andover Hants. Tel: 0264 64455.

RM trims disk drive prices

Research Machines has cut the price of disk drives for its 480Z from ludicrously expensive to plain old expensive. The drives give 328K storage per drive formatted, and now cost £492 for a single unit and £799 for a dual drive, down from £616 and £924 respectively.

The 480Z has a certain following in schools, which can expect a 10 per

cent educational discount, with possibly a further 10 per cent discount for bulk.

The units contain an intelligent disk controller, and support CP/M. They also have a facility allowing them to be shared between a number of machines, and this makes them more attractive for educational/institutional uses.

PERIPHERALS

The new releases

Joysticks

A programmable joystick interface that will put 'any software from any supplier' under joystick control is what dk'Tronics (0799 26350) says of its latest black box. The unit takes any Atari-style stick and is compatible with Interface 1 and the Microdrives. It costs £22.95. AGF Hardware (0243 823337) has launched Protocol 4, designed to let you use any joystick or trackball with any Spectrum software. It costs £29.95. Acorn distributor LVL (0602 394000) has branched out into hardware with joysticks for the BBC. The joysticks, which spring back to centre, cost £21.95.

On the trackball front CBS Electronics (0253 28928) is launching a Roller Controller and a Super Action Controller for the Colovision and Adam systems. Each unit will cost £45 to £50.

Monitor

Electrohome (051-356 1365) has added a 23in screen to its range of

industrial and commercial monochrome monitors. The EVM 2319 features a proprietary development called Scanguard — the picture size remains constant over a wide range of brightness changes. The monitor will cost about £475, but prices may change with different dealers.

Sound Synthesis

To clear your Spectrum's throat dk'Tronics has released a three-channel sound synthesiser incorporating a beep amplifier. It allows you to program your own music or sundry noises with various possibilities. The synthesiser costs £29.95, the amplifier £14.95.

Data Transmission

An interface unit to extend RS232 data links at high transmission rates has been unveiled by Sumatron (0428 54717). Called the RS 422 it lets you communicate with remote peripherals up to 3,000ft away. Swedish telecoms giant Ericsson

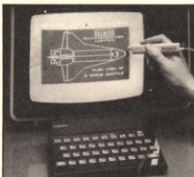

Datapen: new Spectrum version.

(01-606 0425) launched its Series 7 modems last month; they range from baseband through to units operating at 9,600bps. Interleak (0734 589551) has gained BABT approval for its versatile Portman, which costs £195 plus VAT.

Light Pens

The Gibson light pen with five accompanying pieces of software — to draft, paint, animate, compose and manipulate applications — is now available from P&P (0902 43913) for Apple users, costing

£249. On a different level is dk'Tronics' Spectrum light pen, £19.95-worth of hardware and software. It's been upgraded to run faster and lets you draw free-hand and animate five screens. Datapen Microtechnology (0256 770488) has launched another pen for the Spectrum, with two programs to put it to work. The pen costs £29.

Printers

The US interface card Uniprint, a parallel printer interface, has found its way on to P&P's shelves (0902 43913). Each package, at £69.95, includes a Centronics-compatible cable and a manual with a quick reference card. From one side it is compatible with Apple DOS, ProDOS, Pascal, Logo and CP/M, and in the other direction more than 25 printer types will work with it. CPU Peripherals (01-836 2205) is offering a £365 dot-matrix printer from the Esprit range, with switch-selectable serial/parallel 100cps, 9 × 11 matrix and graphics.



On offer: dk'Tronics Spectrum of sound.



LVL Joysticks: distributor's first step.

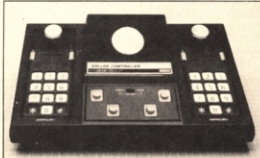

CBS: in early for Adam users.

THE GREAT SUMMER SALE

100K (ACORN DFS) / 200K (DOUBLE DENSITY DFS) BBC DRIVE
ONLY £110 + VAT = £126.50 Carriage £8 extra

FULL YEAR WARRANTY
ACCESS WELCOME



* EDUCATIONAL ORDERS WELCOME!
* DEALER AND EXPORT ENQUIRIES INVITED

Slimline, half height, top quality disk drive from CHINON, Japan featuring full microprocessor control (no LSI gimmick!), quietest operation and lowest power requirement in the industry (+5V @ 450 mA and +12V @ 190 mA).

Beautifully boxed in metal case and in matching BBC colour and supplied complete with:

- ★ Disk Drive Cable and Power Lead
- ★ Formatter Disk
- ★ DFS Manual

TELEPHONE FOR INCREDIBLE PRICES ON FULL RANGE OF BBC DRIVES!



micronix computers Ltd

Suite 2, 26 Charing Cross Road, London WC2. Tel. 01-240 0213/0217. Telex. 295173 VILORD G

HISOFT PASCAL DEVPAC

Quality System Software

HISOFT PASCAL 4T

"... I haven't seen any other compiler that could match Hisoft's Pascal" ... *Using the Spectrum Micro* — Autumn 1983.

"This is a very impressive product ... of benefit to any Spectrum programmer" ... *David Bolton ZX COMPUTING Aug/Sept 1983.*

Just two comments from full length reviews of our powerful and virtually full implementation of Standard Pascal. The advantages of using the Pascal language are many: fast, self-documenting and truly structured programming — many schools and universities insist on a good knowledge and understanding of Pascal for their Computer Studies courses.

Now you can learn and use Pascal on your home micro; Hisoft Pascal is available for a wide range of home computers, including the 48K Spectrum. Typically, compiled programs run 40 times faster than their interpreted BASIC equivalent — and sometimes up to 1,000 times faster!

Hisoft Pascal supports all the Standard Pascal data structures and statements: INTEGERS, REALS, CHARACTERS, ARRAYS, SETS, RECORDS, POINTERS, Enumerated types, FOR ... DO, REPEAT ... UNTIL, WHILE ... DO, CASE ... OF and many pre-defined Procedures and Functions (e.g. SORT, TAN, SIN, COS, INLINE, PEEK, POKE etc. etc.) — it is not a Tiny Pascal but a powerful educational and development tool which allows the user to develop true high-level language skills while attaining execution speed close to that of machine-code.

Hisoft Pascal for the ZX Spectrum now comes complete with ZX Microdrive support (anything you can do with tape you can do with Microdrive) and a Turtle Graphics package which allows easy creation of complex graphic programs.

HISOFT DEVPAC 3

"... DEVPAC is most highly recommended. The documentation is first class" ... *Your Computer* — May 1983.

"... it is impossible to recommend any other development package for the Spectrum over DEVPAC." ... *Adam Denning* — *ECM* April 1984.

Need we say more? DEVPAC 3 is a very powerful assembler, editor and disassembler/debugger. Forget about buying lots of separate packages for your machine-code development — it's all in DEVPAC 3. A full Z80 assembler with conditional assembly, all standard directives, full arithmetic (*, /, +, -, OR, XOR, AND, MOD), many assembler commands for controlling object code generation, listing, printing etc., full line editor with advanced facilities like search/replace string, "include" facility that lets you assemble from tape (or Microdrive) without taking up memory for your source text AND a superb disassembler/debugger with "front panel" display of Z80 registers and flags with commands like search for string of bytes, copy memory, disassemble memory (to an assembler textfile, if you wish), list memory in ASCII, set multiple breakpoints, and, above all, single-step through machine code programs, one instruction at a time, EVEN IN ROM!

DEVPAC comes complete with a 45 page user manual.

On the ZX Spectrum, DEVPAC fully supports the ZX Microdrive, allowing assembly from microdrive, saving of text to and from Microdrive and saving of object code to Microdrive — DEVPAC still fully supports tape as well.

Prices:

Hisoft Pascal 4T (ZX SPECTRUM) £25 inclusive
(NewBrain, SHARP MZ700 etc) £35 plus VAT
Hisoft Pascal 4D, many disk formats £46 inc.

Hisoft DEVPAC 3 (ZX SPECTRUM) £14 inclusive
(NewBrain) £25 inclusive

HISOFT

13 Gooseacre, Cheddington
Leighton Buzzard, Beds. LU7 0SR
Tel: (0296) 668995



*and others

H-P gains new heights



The 110—Symphony next on the bill?

By David Guest

In the Year of Our Lord 1968 one of the founders of Hewlett-Packard visited the Winter Olympic Games in Grenoble and said: "It is meet and right that we should be here—let us erect a European facility."

Sixteen years on, H-P's Grenoble plant has become the focus of the European launches of three PC products — the IBM-compatible portable HP 110, a portable disk pack, and a portable non-impact printer.

At last week's launch there were also revelations concerning a battery-powered acoustic coupler, a sub-\$3,000 laser printer, a dumb terminal that speaks ten languages, and a view of the personal computer

and a front-end called the Personal Applications Manager. Help functions are also written into ROM.

The 110 has a 5.33MHz 8086 and its speed is an immediately impressive feature. The LCD screen's traditional drawbacks are partially overcome by the provision of portly hinges, which let you tilt it for the best viewing angle, and a contrast control key. The machine is very light, weighing in at 9 lbs, and eminently portable.

The keyboard, with real keys — albeit very slight depression — has a 75-key grid and eight function keys. During processing the screen displays the function of each key along the bottom two lines. Nit-picking reviewers have complained that the

board, but H-P is by nature a cautious company and the final word was more conservative.

In spring next year you should be able to add Symphony on ROM, at an additional cost that will correspond to the difference in cost between 1-2-3 and Symphony (as with Lotus Development's own arrangements).

H-P has committed itself to provide a family of personal productivity systems and there are plenty of numbers between 110 and 150, the touch-screen desktop system. With a disk drive, a printer and an acoustic coupler it has taken care of one side of this equation but there is a strong possibility that a transportable is just around the corner.

This is despite the fact that last week H-P men from all over Europe poured scorn on those manufacturers that build desktop machines with a carrying handle and call them portable. As the HP110 draws on the company's compression skills developed with pocket calculators, so a luggable will almost certainly represent an H-P speciality of one sort or another. Cyril Yansouni, general manager of H-P's Personal Computer Group, said of the group's approach: "We've had to conform to industry standards. But we feel we can innovate on top of the industry standards."

It intends to sell the 110 to professional users who either travel or take work home with them. In either category it will also offer portable (ie battery-driven) disk storage and printing.

The HP9114A is a disk drive that takes double-sided 3 $\frac{1}{2}$ in floppies on which much of the 110's software will be supplied. Their total capacity is 710K, and the batteries will run for eight hours between charging stops. The battery level on the 110, incidentally, is displayed on the screen — 16 to 18 hours is the expected maximum without a pit-stop.

The 9114A costs \$795 in the US, and the 110 \$295. No European prices have been set yet but H-P expects to improve substantially on



H-P's headquarters in Grenoble.

the £1 = \$1 conversion rate.

A battery-powered version of the Thinkjet printer is not quite ready, but when it is the system with disk and printer will weigh less than 20 lbs. At US prices it will cost \$4,285; \$214 per pound.

The Thinkjet alone costs \$495. It has no tubes to clog, no ink reservoir, and no moving parts at the business end. The central feature is its cartridge/head unit, a disposable item that costs \$7.50 to replace. It prints fan-fold or single sheets at 150eps.

Whether anybody will want portable printing and storage on top of portable computing remains to be seen, but H-P aims to make the most of its existing advantages, and peripherals are an aspect of this. Communication is another area that it is addressing, with advanced plans for a local area network and with the capability of connecting its personal computers to other types of machines — notably IBM. The US version of the 110 includes a

DOT-ADDRESSABLE GRAPHICS
96 x 96 dots/inch
96 x 192 dots/inch

Four PRINT PITCHES
Compressed (142 characters/line)
Normal (80 characters/line)
Expanded compressed
Expanded

One-pass underline

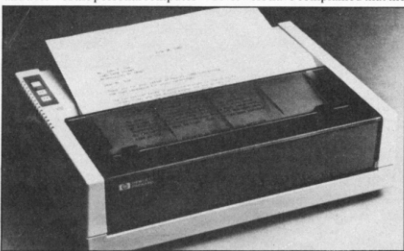

Thinkjet—portable personal hard copy.

business that closes the door on any would-be emulator of Adam Osborne.

There was also speculation: of a luggable on the way from H-P, of the chances of Symphony appearing on the 110, and of course on developments at IBM. H-P claims third place in business micro sales, behind IBM and Apple, but it doesn't appear to worry very much about Apple.

The 110 (issue 61) is a trim IBM-compatible distinguished by a large LCD screen (80 columns, 16 lines) and a large memory (272K of RAM, 384K of ROM, both the CMOS variety). It carries Lotus 1-2-3, Hewlett-Packard's Memomaker word processor, MSDOS,

screen guide doesn't line up precisely with the position of the keys but this is a quibble. The explanation of the functions more than compensates.

H-P's Memomaker is an unpretentious piece of software that was implemented on the 110 when it became apparent that Lotus' Symphony was not going to be ready in time. With the 110 due for its first European deliveries in September the probability is that Memomaker will be the system's word processor for the rest of the year, but H-P hopes to have Symphony available as an upgrade option as soon as possible. Optimistic H-P executives said that the European version would appear with Symphony on



110—as an element of an H-P network.

Sinclair interview: cynical carping

Your article about Clive Sinclair (Issue 65) is professionally cynical. It is a measure of the QL's impact that journalists are forced to find something to say about it each issue and, like the dailies, you feed on apparent conflict.

While journalists revile, reviewers and first recipients seem enthusiastic.

Anyone that would pay £400 in advance when they could pay the day of despatch by credit card deserves to be temporarily out of pocket.

*D Mitchell
London, N16*

I have worked in a large bureau for 12 years and delays of this sort aren't confined to home computers. Objective, Mr Mitchell, not cynical. This was the first time Sir Clive had answered his QL critics. We thought you should have his explanations in full and as he gave them. What you think of them is another matter. — Ed.

Sinclair interview: cheque cash cheek

So Sir Clive wonders why Sinclair has taken so much stick over the QL when other manufacturers have also been late. (Issue 65).

As far as I'm concerned, the answer is simple. No other manufacturer has had the cheek to take my money while the machine was still being designed. I sent a cheque in January, which was promptly cashed. The machine arrived in May.

Sir Clive says 'what else were we to do with the money?' I know of no law which forces him to cash a cheque immediately. He could have left the cheques in a safe.

I now have the machine. The software is full of bugs, and I have yet to receive the Basic manual. And he still considers the criticism 'unfair'. How much has to go wrong before criticism becomes 'fair'?

*MJ Baker,
Telford, Shropshire.*

Sinclair interview: retailer's MSX rap

So, Sir Clive blames retailers for promoting MSX (Issue 65). He is concerned at the 'fairly stupid attitude from some British retailers about MSX'.

I call this crass hypocrisy. Sir Clive has probably done more harm to the independent retailer, together with Acorn, than any other manufacturer by his policy of creaming off the market with mail order and then offering the bulk of supplies to the newsagents.

RANDOM



Would you like to see your name in print? Here is your chance on PCN's letters page.

When the independent retailer is eventually offered the leftovers, the margins are pitifully small, even though the customer expects the independent to offer advice and after sales service of a higher standard than the newsagents and chemist.

The Japanese will succeed because they will offer the retailers decent margins, reliable machines and adequate stocks. If the British computer manufacturers go the way of the motorcycle makers of old, they have only themselves to blame.

*R Cornforth,
Diskwise, Plymouth.*

Sinclair interview: Mac stands up to QL

Sir Clive Sinclair's comparison of the QL with the Macintosh (Issue 65) really highlights the difference of emphasis between Apple and Sinclair.

While both companies stress technology leadership, the development of Macintosh has been carried out with one simple premise in mind, namely that computers are going to be much more useful if they're easier to use.

It's Apple's view too that whatever makes the system work is largely irrelevant to a user. Just as a car's camshaft design may be interesting to the engineer or enthusiast, it is of no interest to a driver whose thoughts are on the car's performance, economy and comfort.

The myth of the 16-bit computer as being some kind of advance in technology has already been exploded. The advances of 32-bit technology will only affect the user if they provide real benefits — not interesting technological curiosities.

*Michael Spring,
Marketing Services Manager,
Apple Computer.*

Suitable games for children

Play for Life, an organisation linking parents, teachers and the toy industry, is compiling a guide which will include a section on computer programs, mainly for the five- to twelve-year olds, but our interest extends to children of all ages. For this reason I am looking for suitable software.

The criterion for inclusion is that the programs should be constructive, creative entertainment, such as utilities that encourage the users to extend themselves, and their imaginations. Graphic and music utilities are excellent examples.

Alien zapping, dragon-slaying games are out and dictatorial power simulations are excluded. A lack of overt violence is no qualification; such games may still be aggressively competitive. We are looking for simulations that deepen understanding, role-play games where the player helps others, arcade games that encourage coordination and swift reaction, but not if they depend on or include violence and aggression, and multi-player games that require the participants to work together.

*Keith Ollen,
Crowborough,
E Sussex.*

Shops suffer from late deliveries too

I am concerned at the increasing number of cases where companies advertise, people order and goods are not sent. I work in a computer shop and the situation is definitely getting worse.

I recently ordered some ROM boards for the shop. After a few weeks I rang the company and

asked why they hadn't come. They said the boards had been sent. They still had not come after another few weeks. This went on for quite a long time. Eventually I ordered from another company and the ROM boards came in a week. There are many other cases too numerous to mention.

These cases, and the others that happen day-to-day must stop, and customers and dealers be treated fairly. After all, no customers, no companies.

*Paul Charles,
Nottingham.*

Interesting that it's not just the individual who suffers in this way — Ed.

British Telecom ignores micro users

I have been interested by the growth of British Telecom's advertising campaign. It is broken into three fields: everyday use of the phone, business facilities and the high-technology power behind the button stuff, where BT boasts its technological excellence, computer link-up and satellites. Yet it is with great irritation that I continually ask: what about the modest home computer user?

It is particularly apparent now, as the price and availability of modems makes them a great attraction

PCN £10 Star Letter



and excellent extension to the home computer. This is where the greatest excitement lies; it opens up the world of computers. However, why has Micronet only a mere 8,900 subscribers (PCN issue 63)? Surely it is not because there are only 8,900 users out there who fancy being linked to a world outside their room and VDU? No, I feel BT is at fault.

Micronet and modems are very tempting, but one major point against is the cost of phone charges and various extras. I am not a subscriber to Micronet or the like, nor do I have a modem to go with my Spectrum. Quite frankly the phone charge frightens the hell out of me and so I am confined to my VDU

Air your opinions, share your experiences or just point out our occasional blunders. If you have an impressive way with words you may gain £10 for the star letter.

WRITE TO: Random Access,
Personal Computer News,
VNU, Evelyn House, 62
Oxford Street, London W1A
2HG.

RANDOM ACCESS

and Spectrum and my room.

I considered buying a modem but after weighing up how a student at secondary school was to pay for the charge (BT's) I reluctantly decided against. Surely British Telecom has the power to give the computer user a better deal? Surely it could set up a cheaper network for modem users with some kind of reduced charge?

I realise that data transfer is a big business and BT is the transferer and that there are some serious users who use the lines without worrying about the charge, but surely it would be in BT's interest to help introduce home users to the system with attractive, realistic prices, and help the idea grow, giving the modest home user the excitement of a bigger computer world and the users the power behind their buttons.

Paul Connolly,
Newcastle,
Co Down.

Help wanted with the Lynx

I own a Lynx and know that whatever happens to Computers it will be a long time, if ever, before new soft or hardware is produced.

After my exams I will have about 12 weeks in which to write machine code routines, to enhance the Basic, and other general pieces of

software, including a full disassembly of the Rom. In the hardware area I am interested in adding a light pen and maybe a user port.

If anyone can help in the soft or hardware area, I'd be interested to hear from them. In return I would be willing to supply information that they require as in the eight months I have owned a Lynx, I have built up a substantial library of information. Anybody interested please write to:

R Parkes
22 Chichester Close,
Graham,
Lincs, NG31 8AS.

Nice to see you responding to the crises. Good luck — Ed.

Memotech club opens its doors

We are forming a Memotech Owners' Club, which will produce a monthly magazine for its members. The club will bring together people's ideas and programs for the expanding Memotech market.

To use this machine to its full potential, an interactive link between the owners is necessary, which the club will provide. For more details send an SAE to:

Phil Eyles,
23 Denmead Road,
Harefield,
Southampton, SO2 5GS.

Acorn user unplugged

Recently perusing some copies of PCN, I came across an advertisement for the Acorn Electron. In one of the pictures, a woman declares: 'Experts like What Micro?' and I rate the Electron higher than any of the competition.'

Well, with so many experts around, shouldn't one of them advise the lady studiously bent over her keyboard to plug in the power cable?

David Rawlinson,
Rotherham,
S Yorks.

Thus illustrating the old adage: If it doesn't work, turn it on — Ed.

TV static at Sinclair

At the beginning of last November I wrote to Sinclair asking for a brochure about the flat screen television. Several days later a large envelope came through the door, containing a picture of the television and only a small paragraph about its wonderful technology. The letter said that all orders would be treated on a first-come-first-

served basis and when the television was ready for despatch you should send your money.

I filled the form in and sent it off. On November 23 a letter from Sinclair acknowledged my order of one television and one mains adaptor, a cost of £87.90. I was given a 'unique' customer number and told there was not a firm delivery date yet, and I would hear from them again in January.

A quarter of the way through February another letter apologised for the delay, saying production build-up was slower than they would have liked and only 1,000 televisions had been sent to customers.

In April they were confident my television would be in stock.

On April 25 another letter said my television was not in stock but production was building up slowly and all the signs pointed to my television being in stock in May.

One month later a lengthy letter from Sinclair (TV Division) explained at length my television would not be in stock until June. It closed saying my television should be in stock by June 18.

Now I am completely uninterested and will probably decline the offer.

This, to my mind, is worse than the Sinclair QL saga.

Peter Ball,
Preston,
Lancs.

COURSEWINNER

The Punters Computer Program

COURSEWINNER allows you to use the power of your computer to get the edge on the bookmaker.

● COURSEWINNER contains a database of full detailed information on all English and Scottish flat courses.

The ten leading jockeys and trainers, and effect of the draw is detailed for each course.

This information can be displayed on the screen at any time.

● The program analyses these factors combined with the results of the last three outings, starting price and weight carried.

● COURSEWINNER is simple and quick to use, yet very powerful.

● Bored with detailed instruction booklet.

Price £12.50 all inclusive IMMEDIATE DISPATCH (RETURN OF POST)

Available for: SPECTRUM (48K), BBC (B), COMMODORE 64, DRAGON, APPLE II/IIe, ATARI (48K).

POOLSWINNER

The Ultimate Pools Prediction Program

● POOLSWINNER is the most sophisticated pools prediction aid ever produced. It comes complete with its own massive database.

● Can be used for Scoredraws, Draws, Aways and Homes.

● The database contains over 20000 matches (10 years league football). It updates automatically as results come in.

● The precise prediction formula can be set by the user. This allows development of your own unique method.

● Package is complete with program, database and detailed instruction booklet.

Price £15.00 all inclusive IMMEDIATE DISPATCH (RETURN OF POST)

Available for: SPECTRUM (48K), ZX1 (16K), BBC (B), COMMODORE 64, DRAGON, APPLE II/IIe, ATARI (48K).

Available from dealers or direct (return of post) from:



37 Councillor Lane, Cheadle, Cheshire. Phone: 061-428 7425

DRAGON, BBC, SPECTRUM DEALERS

BBC B Computer 1.2 O.S.	£399.00
1.2 ROM	£8.00
Microvitec Monitor	£229.00
Sanyo Green Monitors	£97.00
Disc Drives from:	£175.00
Joysticks (Pair)	£17.90
Wordwise Word Processor	£39.00
Acorn Electron	£199.00

All connectors, plugs and sockets for BBC, ribbon cable, discs C20 C15 C12, cassettes etc. in stock.
Centronics Printer Cable (BBC & Dragon) £12.90

R.T.T.Y. Program for BBC B	£7.50
R.T.T.Y. Circuit Board including instructions	£7.00
R.T.T.Y. Eprom Version	£20.00
BBC Slow Scan Receive Program & Circuit Board	£17.50
G3LIV R.T.T.Y. Interface	£75.00
Computer Dust Covers	£3.00
Star Gemini 10X Printer incl cable	£275.00
CP80 Printer (Inc. Cable)	£230.00
Printer Cable (BBC or Dragon 32)	£12.90
Epson RX80, FT, FX80	(Phone availability)

DRAGON SERVICE CENTRE

Dragon 32	£150.00
Dragon 32 Disc Drive (Inc. Controller)	£275.00
Joysticks (pair)	£14.90
ZX Spectrum 48K	£129.00
Memotech MTX 512 (64k)	£315.00
Memotech MTX 500 (32k)	£275.00

Wide range of software for BBC, Dragon 32, ZX Spectrum etc. Please send SAE for full list. Post and package on small items £1. All available mail order. Access and Visa, 24 hour phone. All prices include VAT at 15%.

S P ELECTRONICS

48 Linby Road, Hucknall, Notts NG15 7TS.

TEL: Notts (0602) 640377

Lost in a maze of bits and bytes, trapped in a forest of errors, bugged by Basic? Whatever the problem, CALL on us. Our panel of experts is at your command.

Write to: Routine Inquiries, *Personal Computer News*, VNU, Evelyn House, 62 Oxford Street, London W1A 2HG.

Memotech manual confused me

Q I'm glad to see Memotech articles appearing in PCN, but I'm still having problems. First, when writing to the VDP registers, how do you work out the DATA byte? I find the manual very confusing on this subject.

Also, when defining the Register byte, the manual says the lowest three bits make up the destination register number. How is this done, and what do the other five bits do?

Chris Banks, *Grimby, Humberside.*

A Writing to the VDP registers involves sending the DATA byte first, followed by the Register number. You do this by sending via Port 2 DATA: REG NUMBER.

There are two save configurations that you can use for data when setting up the VDP registers on the MTX. This is not to say that you cannot use any other configurations, but these are the most commonly used settings.

The MTX configures the addresses as follows:

```
Register 0 1 2 3 4 5 6
Data 02 C2 0F FF 03 7E 07
Other configuration
Register 0 1 2 3 4 5 6
Data 02 C2 06 FF 03 38H 07
You write to the VDP as follows:
```

Assume that register E holds data byte and register D holds VDP register number:

```
LD A,E ; Get data
OUT (02),A ; send it
LD A,D ; Get register
OR 80H ; Make sure bit 7 is 1
           so that computer
           knows it is a write
           VDP
```

```
Out (02),A ; send it
RET ; return for more.
```

Using the first configuration the addresses are as follows:

```
Text Screen: 1C00H: Pattern
Gen Text: 1800H: Screen Mode 2:
3C00H: Pattern Gen 0000—
17FFH: Colour Table: 2000H
Sprite Attribute: 3F00H: Sprite
Generator: 3800H.
```

You work the data byte out as

below, taking register 2 as an example. The manual states that in graphic mode 2 the VDP register 2 defines the name table address which is register 2 data + 400h (1k).

Therefore, using the MTX table above, register 2 is loaded with 0FH which is 15x1024 = 15360 = 3c00h which is the start of the screen. The other registers are worked out in the same way but watch out — further on in the manual it points out that the colour table must have all the LSB bits set to 1 which means that the data for Register 3 is FF, or 03.

For instance, to set the colour table @ 0000 = 64 (40h) x 0 = 00000000
Set LSB's to 1 = 00000011 = 03 (data byte)

When bit 7 is set, the VDP knows that it is a write to VDP Registers (OR 80H)

When bit 7 is zero and bit 6 is set = write to VRAM (OR 40h)

When bit 7 is zero and bit 6 is zero = read from VRAM

You can ignore the bits in between. For further sub-routines relevant to setting up VDP see issue 46.

64 can play the stock market

Q I want to be able to follow about 20 investment shares on the Stock Market using my Commodore 64 and disk or tape drives. The information I need includes total costs, any scrip issues and increases. I would also like to see comparisons as histograms or bar charts using colour.

FT Holt, *Portsmouth, Hants.*

Spectrum's roundoff hitch

Q My Spectrum issue 3 does not give an answer to this perfectly simple equation:

```
1Ø FOR M=1 TO 1Ø
2Ø FOR N=1 TO 1Ø
3Ø FOR P=1 TO 1Ø
4Ø IF (2.49*M) + (2.97*N) +
(3.84*P) = 6Ø AND M+N+P=2Ø
THEN PRINT M;N;P:STOP
5Ø NEXT P:NEXT N:NEXT M
```

The computer should print 6, 10, & 4 and does not, but if you substitute in line 40, 21 instead of 20 then it works and gives the answer 14, 2, & 5.
A D Wilson, *Dartford, Kent.*

A This problem is due to roundoff errors and the way the multiplication and addition routines treat their arguments. Roundoff occurs

A The 64 is perfectly capable of performing the tasks you mention, even with its very primitive Basic. Essentially, you'd need an array to hold your 20 shares with a subscript for each of the different categories associated with each share. For example, in addition to the three points you mention, you might want the high price, low price, percentage change and so on. To take ten lots of information on each share DIMENSION your array: DIM SHARE (19,9).

You then need to write an input routine which would simply be two loops, one for shares, one for the ten items of data. The program could handle all of the calculations.

Plotting bar charts would also be simple using the 64's block graphics and the 40 x 25 text screen could handle 20 shares comfortably.

If you don't feel up to writing the program at least two packages on the market might fit the bill. Vizastar 64 from Viza Software is a combined database, spreadsheet and graphics package — possibly a case of overkill for the application you describe. One extra you may find useful is that it will print your screen displays on a range of printers, dot matrix and daisywheel.

The other package to check is Maggie from Audiogenic, another combined database, spreadsheet and graphic utility.

Vizastar costs £99.95 on disk from Viza Software on Medway 813780. Maggie costs the same but comes on cartridge. Contact Audiogenic on Reading 664646.

Upgrading my Oric to the Atmos

Q The Oric Upgrade Service told me it would cost £135 to upgrade to a 48K Atmos. Surely it would be cheaper to sell my Oric, add the extra cash and buy it from the shops?

Also would it be wise to wait a while before upgrading, since there are rumours that Oric may produce another machine, taking into account the fact that I can only afford between £170 to £180?

I am also having trouble with tuning. The screen jumps, flickers and loses its colour.

M Musa, *New Southgate, London N11.*

A Upgrading a 16K Oric 1 to a 16K Atmos costs £60, and it costs £60 to upgrade a 48K Oric 1 to a 48K Atmos. Oric isn't doing upgrades of the 16K Oric 1 to the 48K Oric 1, so you have to take the £135 direct route.

A quick check of the small ads reveals asking prices for a 48K Oric 1 from around £80 to £120. One optimist was asking £100 for a 16K Oric.

There's no firm information on new Orics yet, but if Oric goes for the QL/business market it's liable to be outside your price range anyway.

As regards your TV problems, the signal definitely isn't getting through, so cross check everything. If you can borrow another Oric to check it out, do so, switching the various parts of the system around. Then check your system with another TV.

because numbers on the Spectrum, or any computer for that matter, are only evaluated to a certain number of decimal places, the last one being rounded up or down. This will only affect certain values since many of them will be rounded in the right way and, hence, come out correctly.

Numbers are stored in the memory in floating point form as five bytes, the first being the mantissa, and the rest the power to which two is raised to obtain the number, since any number can be represented as: mantissa + 2^e, where e is the last four bytes. This format means that numbers cannot be stored absolutely and need to be rounded off — see pages 169-170 of the user manual.

What this all boils down to, is that even though M+N+P=20, (2.49*M) + (2.97*N) + (3.84*P) does not necessarily equal 60 since the multiply routine deals with numbers differently to the addition routine. Try (2.49*M) + (2.97*N) + (3.84*P) - 60 and the roundoff can be seen.

PCN CHARTS

GAMES

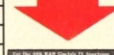
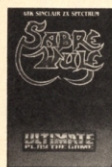

	GAME TITLE	PUBLISHER	MACHINE	PRICE
▲1	5 Sabre Wulf	Ultimate	SP	£9.95
▲2	3 Beachhead	US Gold	C64	£8.95
▲3	4 Psytron	Beyond	SP	£7.95
▲4	2 Code Name Mat	Micromega	SP	£6.95
▼5	1 Jet Set Willy	Software Projects	SP	£5.95
▲6	15 Mugsy	Melbourne House	SP	£6.95
▲7	7 Fighter Pilot	Digital Integration	SP	£7.95
▼8	6 Trashman	New Generation	SP	£5.95
▲9	16 Blade Alley	PSS	SP	£5.95
▲10	10 Solo Flight	Microprose	C64	£14.95
▲11	25 Jack & The B'stalk	Thor	SP	£5.95
▲12	13 Night Gunner	Digital Integration	SP	£7.95
▲13	12 Hunchback	Ocean	SP, C64, Dragon	£6.90
▲14	17 Blue Thunder	Wilcox	SP, C64, Atari	£5.95
▲15	18 Bigger	Alligata	C64	£5.95
▲16	8 Space Pilot	Anirog	C64	£7.95
▲17	19 Ad Astra	Gargoyle	SP	£5.95
▲18	11 Flight Path 737	Anirog	Vic, C64	£7.95
▲19	27 Aviator	Acornsoft	Acorn	£14.95
▲20	23 Scuba Dive	Martech/Durell	SP, C64, Oric	£6.95
▲21	24 Chequered Flag	Psion	SP	£6.95
▲22	28 Manic Miner	Software Projects	SP, C64	£5.95
▲23	— Lords Of Midnight	Beyond	SP	£7.95
▲24	9 Atic	Ultimate	SP	£5.50
▲25	— Chuckie Egg	A&F	SP, C64, Dragon	£7.90
▲26	— Football Manager	Addictive	SP, Acorn	£6.95
▲27	— Twin Kingdom Valley	Bug Byte	C64, Acorn	£9.50
▲28	— Son Of Bigger	Alligata	C64	£7.95
▲29	21 3D Lunar Attack	Hewson	SP	£7.95
▲30	— Fortress	Amcom	Acorn	£8.95

MICROS

Top Ten over £1,000

TW	LW	MACHINE	PRICE	DISTRIBUTOR
▲1	2	IBM PC	£2,390	IBM
▼2	1	APPLE III	£2,755	AP
►3	3	ACT Sirius	£2,525	ACT
▲4	9	DEC Rainbow	£2,359	DEC
▼5	4	ACT Apricot	£1,760	ACT
▲6	8	Televideo TS1603	£2,640	TH
▼7	6	Kaypro	£1,604	CKC
▼8	5	Wang Professional	£3,076	WANG
▲9	—	Philips P2000	£1,484	MD,KDS
►10	10	NCR Decision Mate V	£1,984	NCR

Top Ten up to £1,000

TW	LW	MACHINE	PRICE	DISTRIBUTOR
▲1	2	Spectrum	£99	SI
▼2	1	CBM64	£199	CBM
▲3	5	Vic 20	£100	CBM
►4	4	Electron	£199	AC
▲5	7	Oric Atmos	£175	OR
▼6	3	BBC B	£399	AC
▼7	6	Memotech 500	£275	MTX
►8	8	Dragon 32	£175	DD
▲9	—	Atari 800XL	£250	AT
▲10	—	Oric 1	£100	OR

These charts are compiled from both independent and multiple sources across the nation. They reflect what's happening in high streets during the fortnight up to **June 21**. The games chart is updated every other week.

Neither mail order nor deposit-only orders are included in these listings. The prices quoted are for the no-trills models and include VAT.

Information for the top-selling micros is culled from retailers and dealers throughout the country and is updated every month.

PCN Charts are compiled exclusively for us by RAM/C, who can be contacted on 01-892 6596.

Unicorn. Five new channels.

Here's the full



The ZEP 100

- Z80 Extension Processor
- 4MHz Z80A
- 64K RAM
- 24K ROM

The object of any upgrade kit is to improve processing ability and to increase data storage capacity. The UNICORN ZEP100 is the first stage upgrade which opens channels into the world of serious computing.

The ZEP100 is the proven 8 bit second processor for the BBC Model B micro. A Z80 extension processor which enables the use of the well established CP/M operating system, giving access to the vast range of applications programs and languages available for all CP/M[®] micros. When fitted to a BBC model B microcomputer with compatible high quality disc drives it provides a complete business or scientific computer which can run large applications programs or use advanced languages, with the ability to switch back to standard BBC programs at any time.

Any ZEP100 can be linked, via the Econet[®] option on the BBC, to a network of other TORCH computers to provide a workstation running on TORCHNET. Full TORCHNET operating systems software is provided to allow access to information anywhere on the network, or to communicate with other computers.

The 24K ZEP100 is supplied with full software support including word processing, spreadsheet, database and utilities. The ZEP100—around \$299 (ex. VAT).

The new UNICORN range from TORCH Computers gives the enthusiast and professional user a choice of upgrades which takes the BBC Model B Micro to the ultimate height of performance.

The result of TORCH'S total commitment to the BBC Micro is the only complete range of high performance hardware available. Offering every BBC Micro owner five new upgrade channels, UNICORN will transform your BBC into a fully communicating workstation, a CP/M[®] compatible business machine or the ultimate in high powered 32-bit data processing.

At the top of the range, THE UNICORN, offers the power and sophistication of System III UNIX[®] whilst other channels make available the flexibility of languages such as FORTRAN, PASCAL, BCPL and COBOL. All models, with the exception of the HDP240, provide BBCBASIC (Z80) on the Z80 rather than the Model B's 6502.

Tune in to the Channel that most suits your requirements. Whichever level you choose you can be sure of a system with infinitely expandable potential for a confident future in the world of computing.



Channels for the BBC. programme.



The ZDP 240

- 4MHz Z80A ● 64K RAM
- 24K ROM
- Twin, double sided 400K floppy discs
- Independent integral power supply



The UNICORN ZDP240 (Torch Z80 Disc Pack) is the proven upgrade for the BBC Model B micro-computer. Offering the use of more powerful and flexible languages such as Fortran, Pascal, BCPL and Cobol, it provides 800K of disc storage plus a Z80 second processor with 64K RAM running TORCH's own CP/M™ compatible operating system based in ROM.

This advanced design means that almost all of the 64K RAM provided by the Z80 board is available for CP/M™ programming use—an advantage no other BBC micro upgrade can offer.

If your BBC micro has the Econet® option, there is a further benefit the ZDP240 can offer. TORCHNET can link together up to 254 upgraded Model B's on a local area network, so for enthusiasts, Clubs and Schools it is a simple and low-cost way to achieve networking facilities.

The discs can be used for storage under the Acorn DFS system or for CP/M™ programs and data.

A comprehensive software package is provided with the disc pack. It includes word and data processing and a spreadsheet program, along with utility programs and manuals.

The TORCH Z80 Disc pack is recommended by the CDTA for government use. The ZDP 240—around £699 (ex. VAT).



The HDP 240

- 20Mbyte hard disc Winchester
- Double sided 400K floppy disc
- Integral power supply

For users who need much more storage capacity than is available on floppy discs and who require the large speed gains that a Winchester hard disc provides, the third new channel is now available. The UNICORN HDP240 combines a 400K floppy disc drive with a 20Mb hard disc and its associated controller. The pack connects directly to the disc and 1MHz bus sockets on the BBC Model B.

In conjunction with a ZEP100, it provides a powerful business computer for running CP/M™ programs with large amounts of data. The floppy disc can be used for storage with the Acorn DFS system, and both discs can be used by other TORCH systems on the TORCHNET local area network. The HDP240—around £1995 (ex. VAT).



The HDP68K

- 8MHz MC68000 ● 6MHz Z80B
- 256K RAM (68000)
- 64K RAM (Z80)
- 20 Mbyte hard disc Winchester
- Double sided 400K floppy disc
- Integral power supply

The fourth channel in the UNICORN range is for users who need the extra processing power of a 68000 32 bit processor, as well as the Z80 running standard software. The UNICORN HDP68K provides the ultimate in performance, offering an extra 256K RAM and a 68000 processor running at 8 million cycles per second. It also contains a Z80 processor to allow the running of existing TORCH software.

The HDP68K—around £2495 (ex. VAT).



The Unicorn

Spec. as HDP68K PLUS UNIX® operating system.

UNIX® System III is the recognised operating system of the '80's. A very powerful and sophisticated multi-tasking system, it includes a vast library of utility programmes.

The fifth channel and top of the range. THE UNICORN, puts UNIX within reach of the individual user, at a price unmatched by any other UNIX® systems, by combining the reliability of the BBC micro with advanced technology from TORCH Computers.

TORCH UNIX operates under the network operating system. Using UNICORN products, a low-cost network of BBC Micros can be configured to offer the most complete range of educational computing facilities available anywhere.

Other facilities available include UCSDp-System, LISP FORTH, PILOT and PROLOG. The UNICORN—around £2895 (ex. VAT).



UNICORN

Open channels for the BBC micro.

To: Torch Computers Ltd., Abberley House, Great Shelford, Cambridge CB2 5JQ, Telephone: Cambridge (0223) 811000.

Please send further information on the UNICORN range plus your FREE 1981 Software Catalogue.

Name _____

Address _____

Tel _____

Post Code _____

PCN 276

TORCH COMPUTERS

CP/M is a registered trademark of Digital Research Inc. Econet is a registered trademark of Acorn Computers Ltd. UNIX is a registered trademark of Bell Telephone Laboratories Inc. UK version Model B necessary. Disc interfaces are necessary for use with the Unicorn range.

Text and Graphics provided by BBC Model B. Keyboard provided by BBC Model B.



More hints and tips from our readers to make programming a little easier.

You all know the feeling: after hours, days or even weeks spent on a particular problem you suddenly see the answer. Or on one of those late-night expeditions through the memory map you find some undiscovered feature. Well don't keep it to yourself — send it here. We pay £5 for every tip and routine printed and £25 for the Microwave of the Month.

Send your contributions to: *Microwaves, PCN, 62 Oxford Street, London W1A 2HG.*

Bits and bods of BBC tips

Here are a few undocumented tips for the BBC micro.

To stop the screen scrolling in any mode use %D0=2. This will enable you to type in the last position of the screen without the screen scrolling. The command %D0=0 will return the machine back to normal.

It is possible to get more memory from your Beeb by typing PAGE=&900 <Return>. This means, however, that you are not able to use disks, user defined keys or user defined characters or your program will be corrupted.

Finally here is a sneaky way of improving your skills on arcade style games for the BBC. If the <Return> key is used as the fire button, type the following before loading:

```
*KEY 8 :M:M:M:M:M:.....
until you hear the line full message. Now using the f8 key for fire you should find you have a good chance of winning!
```

Danny Tucker, King's Lynn, Norfolk

A DOKE gives Oric 1 protection

The following routine for the Oric 1 will assure full list protection and even Reset protection.

To do this you DOKE location 27 with F43D. This needs to be operated at the beginning of the program. The program will not be protected until it is run so I suggest that you save the program on AUTO.

```
20 DOKE 27,F43D
30 PRINT "PLEASE ENTER YOUR CODE":NS
40 IF NS="234-8796" THEN DOKE 27,CBED ELSE NEW
50 REM ACCESS
```

This is a very simple program that, when run, will only allow the one code to be entered. The second DOKE to location 27 sets the reset and break back to normal.

There is only one catch to using this method of list protection. Once the program has been run it makes the computer inactive, which means you have to turn the computer off and on again.

C Collins, Frankley/Rednal, Birmingham

Brightening up Spectrum graphics

Here are several routines for the Spectrum demonstrating some of its graphics and colour capabilities:

```
10 FOR F=0 TO 75
20 PLOT, F,F
30 DRAW 0.1,F,5:NEXT F
The following routine produces four circles in a row:
10 FOR F=0 TO 28
20 CIRCLE 100,50,F
30 CIRCLE 125,50,F
40 CIRCLE 125,50,F
50 CIRCLE 75,50,F
60 NEXT F
```

This routine will print lots of coloured squares at the bottom of the screen in random positions:

```
10 FOR F=1 TO 25 STEP 5
20 FOR G=1 TO 25 STEP 5
30 POKE 23000+RND*295,
RND*255
40 NEXT F:NEXT G:GOTO 10
```

Finally, this program demonstrates the high resolution graphics of the Spectrum:

```
10 INK 3: PAPER 0: BORDER 2
20 CLS
30 FOR F=-PI TO PI STEP .2
40 PLOT 50,85
50 DRAW 150,0,F
60 NEXT F
70 FOR F=-PI TO PI STEP .2
80 PLOT 120,160
90 DRAW 0,-150,F
100 NEXT F
```

Stuart Gibson, London SE18

Commodore garbage

Commodore programs which use a lot of string manipulation will sometimes appear to hang up, or pause inexplicably. This is caused by garbage collection of unused strings when the micro needs to free some string storage spaces.

You can often alleviate the problem by forcing a garbage collection during a non-critical part of the program. Simply add a line: XX = FRE(0).
Y Hall, London SW5.

Giving Atari text colour independence

Atari graphics modes 1 through to 8 are split screen displays consisting of a graphics window above a 4-line text window.

Generally, the graphics window makes use of colour registers 0 through 4; in addition, the text window uses register 1 for character luminance and 2 for its background colour.

This restricts the use of registers 1 and 2 because any change in them affects both windows.

The program here sets up a display list interrupt routine which changes registers 1 and 2 for the text window thus making its colours independent of the graphics window.

In the routine: location 1540 holds the text window's background colour, and location 1542 holds the text window's character luminance.

N Pearce, St Leonards-on-Sea, E Sussex.

```
900 7 *GRAPHICS MODE (1-8)*:INPUT G: GRAPHICS G
910 DLIST =PEEK(560)+256*PEEK(561)
920 FOR I=DLIST+6 TO DLIST+201
930 IF PEEK(I)<>66 THEN NEXT I:END
940 POP :POKE I-1,PEEK(I-1)+128
950 FOR I=8 TO 19 : READ J:POKE 1536+I,J:NEXT I
960 DATA 72,136,72,162,58,169,12,141,18,212
970 DATA 141,23,208,142,24,208,104,178,104,64
980 POKE 512,8:POKE513,6:POKE 54286,192
```

BBC Autoruns rings around the pirates

Here is a program called 'Autorun' for the BBC Model A or B which disables Break, Control/Break and Escape.

This is very useful for software protection because it makes it impossible for a user to list or copy a program once it is run. Of course, the program is still vulnerable before it is run.

The program changes the Break vector so that it points to an assembly routine which disables Escape, enters the Basic commands OLD and RUN into the keyboard buffer and returns to Basic. 'Autorun' can be merged onto the start of any program.

This version has a short program to explore magazine preferences. Save the program before running it because typing errors could prove fatal! If the computer gets into an infinite loop when Autorun is being used the only solution will be to switch the computer off and on.

Jonathan T A Ball, Southport, Merseyside

```
10 REM AUTORUN
20 REM (C) JONATHAN BALL
30 OSBYTE=&FFFF
40 CLI=&FFFF
50 #FX229,1
60 #FX247,76
70 #FX248,112
80 #FX249,23
90 DIM ESCSTOP 28
100 #ESCSTOP=&FX229 I*CHR#13
110 P%=&800
120 I
130 OPT 0
140 LDX #ESCSTOP MOD 256
150 LDY #ESCSTOP DIV 256
160 JSR CLI
170 LDA #130
180 LDX #0
190 LDY #ASC("0")
200 JSR OSBYTE
210 LDY #ASC(",")
220 JSR OSBYTE
230 LDY #13
240 JSR OSBYTE
250 LDY #ASC("R")
260 JSR OSBYTE
270 LDY #ASC("N")
280 JSR OSBYTE
290 LDY #ASC("M")
300 JSR OSBYTE
310 LDY #13
320 JSR OSBYTE
330 RTS
340 )
350 #FX15
360 REPEAT
370 INPUT "What is the best computer magazine in the world",CM#
380 IF CM#<>"PCN" THEN PRINT"WRONG": UNTIL FALSE
```

Clubnet goes to North London where Wendie Pearson discovers a full schedule of training courses.

Dedicated to improvement

Acorn has been the latest entertainer at the North London Hobby Computer Club demonstrating Z80 second processors for the BBC. The club's open day (this takes place once a month) also featured various business packages.

Open Monday to Thursday, the club has a different user group each night, and Thursday features the BBC group which is building Eprom programmers and doing robot control projects.

Not forgotten are training courses — member Ted Ball does one of the favourites: machine code programming for 6502 and Z80.

Other courses include the building of program generators, software using various languages — beginners' and advanced Basic courses.

If you can stand the pace, trot up to Holloway where the club meets at the Polytechnic of North London. Contact Robin Bradbeer on 01-607 2789.



'Unfortunately we seem to have one or two bugs in our robotics program.'

SOFTWARE FROM FLITE: FILE BASE

**YOUR BBC OR ELECTRON DISC DRIVE
NOW HAS A WORTHY CARD INDEX DATABASE
AT AN EVEN WORTHIER PRICE.**

Use it in the home, club, office or school.
It's very versatile.

1. Records are designed by the user.
2. May be used with one disc drive.
3. Allows selective label/envelope addressing or full record recall.
4. Search using ANY field.
5. Random access for fast operation.
6. Very user friendly.
7. 40 or 80 track versions. A 40 track disc will hold up to 400 records depending on size.
8. Sort, amend, recall, print—supports professional standard features.

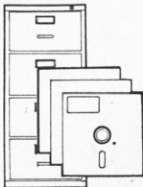

price: £15.90

Disc only. Please specify whether 40 or 80 track.
ACCESS, Barclaycard(VISA) and official orders welcome.

FLITE
software

Findrum, Convooy, Co. Donegal, Ireland.
Telephone (074) 47227
Mail Order (074) 22286 & (074) 22025

A NEW FORCE IN COMPUTERS HAS ARRIVED!

SE

COMPUTER SERVICES

'the user-friendly people'

WE SPECIALISE IN **UPGRADES AND REPAIRS** FOR ALL POPULAR MAKES BUT WE CAN ALSO READILY SUPPLY **ACORN BBC MACHINES** AT PRICES CHEAPER THAN MOST RETAIL SHOPS WITH TO YOUR DOOR DELIVERY AT NO EXTRA COST.

RING US TODAY ON:

(01) 591-4726

BUSINESS AND EDUCATIONAL ENQUIRIES WELCOME

Need some help? Or just looking for a little computer-related reading? Let us advise you.



'Understanding Oric' by Ian McLean, published by Prentice Hall at £7.95 (paperback, 284 pages).

Manuals which come with computers are not always up to scratch and the Oric 1 user guide is certainly no exception. But an abundance of authors are ready to fill the gap with further volumes.

This is one of them. It may seem late, but a sticker on the cover says it's for Atmos owners as well.

The author of this hefty tome has split the book into 17 chapters and seven appendices. The approach to understanding is a slow and long-winded explanation of the Oric's features with plenty of cartoons and diagrams. Such pretty graphics can always help explain subjects, but in this book they are used to excess.

Mr McLean does touch all the relevant topics, dwelling on them at length but without providing much real substance. The programming examples are of the Mickey Mouse variety, that do not fully demonstrate features under discussion.

Eventually wading through the whole book, I did pick up a wealth of information along the way.

DJ

'Getting More From Your Oric' by Henry Hicks, published by Sigma Technical Press at £6.95 (paperback, 202 pages).

When I see a book which contains the words 'getting more' in the title, I'm immediately sceptical. Many of these merely offer information not included in the manuals of the machines.

I was, therefore, relieved to find that 'Getting More From Your Oric' contains original

information presented in an interesting way.

This book is for those with the Oric 1 with V1.0 ROM, or those with an Atmos with a version 1.1 ROM.

It differs from many in that it not only describes the Basic of the Oric and Atmos, but also the workings of the machine and its main components. Also, different features such as the sound and graphics commands are examined together with how the hardware copes with those tasks.

This mixture of hardware and software is a relief, and it answers many questions. Knowing how Basic does this or that is one thing, but knowing how the machine copes with a task is another.

Much of the text is devoted to how the Oric and Atmos work as a system, with chapters covering machine code, the operating system, useful programs and so on.

For an insight into how things work with these machines, I recommend this title.

DJ



'Learning Lisp' by Gnosis, published by Prentice Hall at £13.45 (paperback, 200 pages).

Lisp, once a language used almost exclusively for teaching, is now available on micros and this book can help the hobbyist learning by the light of his own screen.

It teaches, not just as a language, the concept of Lisp, the ideas behind it, particularly recursion and trees, and analyses plenty of example programs. It should make you a competent Lisp programmer — though it's not easy to learn.

Gnosis is a company that sells a Lisp system (P-Lisp) to US educational establishments and, although several people

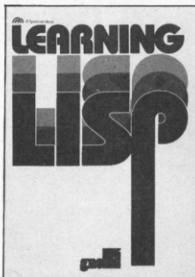

worked on the book, the screens don't show.

The book was reviewed in use with a BBC running Acornsoft's Lisp. An environment disk, referred to as an accompaniment to the book but not available for review, would have saved typing time since the many brackets in Lisp programs don't match.

However, Lisp could be learned from the book without a Lisp system in front of you. It provides a better tutorial introduction to Lisp than Acornsoft's guide, but is twice the price. Although aimed at students, it reads well and could be used with any Lisp environment, once the system specific commands have been understood.

The P-Lisp system costs \$80 and is available for Apple systems II, IIe and III.

PL

'Programs for the TI Home computer' by Steve Davis, published by Prentice Hall at £13.45 (A4 paperback, 126 pages).

Books of programs usually aim to either provide entertaining programs at far less cost than cassette- or disk-based soft-

ware or to teach programming. The really good volumes achieve both.

The 'fun' sort often survive as listings alone, and, where necessary with instructions on how to use them. The other books need explanations and ideas about the development of the programs listed.

This book fails on the first count, because although 50 programs are provided, most are not stimulating enough to justify the effort of typing them in. The games are playable and the utilities are usable, but there's little exceptional. As the author points out, 'this book is not intended to be the last word in TI basic programs'.

It nearly succeeds on the second count. It's possible to improve your knowledge of TI Basic by seeing how the programs were written for it. But to do well on this score it would have helped to include program explanations — there are few enough REM statements as it is, since the author didn't want too much redundant material. Understandable, but not an excuse for omitting to explain how the programs were written.

Good value for 50 programs of any kind, but like so many books it would have been better with more forethought and effort.

PL

'The Chess Computer Handbook' by David Levy, published by Batsford at £4.95 (paperback 129 pages)

This year sees potentially the most exciting world chess championship since the headline-grabbing Fischer-Spassky match 12 years ago and interest in the game is bound to increase yet again, particularly among computer users.

An abundance of chess software is available and practically all the programs can out-play anyone below county standard, so a knowledge of how they work and a guide to their strengths and weaknesses is invaluable to any grandmaster hopeful.

David Levy, chairman of Intelligent Software, has every credential for helping computer chess fans. He is an International Master whose own scepticism of computer-play drove him to accept a bet in 1968 that he would lose to a program within ten years. As he writes: 'The

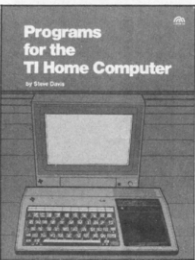

Which book would your micro want you to buy? PCN's review pages help you to choose.

programs got stronger, I got weaker, but I still won the bet in September 1978.'

Since then he has estimated that a computer will be able to play at strong Grandmaster level by the year 2000, but he retains his reservations as to whether any machine could beat the intuitive genius of a human such as Fischer.

This book is a fascinating study of all types of chess computer, dedicated and prog-

rammed, and highlights some flaws still spoiling otherwise excellent versions of the game. It seems inexcusable that some still refuse to recognise casting or automatically promote a pawn to a queen, regardless of your wishes or the computer's own position.

Mr Levy makes relevant chess theory easily understandable to the computer-oriented reader and gives excellent hints on ways to beat the machine and its value as an aid to improving your game. Indeed, it is the latter aspect of chess programs which he acknowledges as the most valuable, and stresses that the game must retain its fun element.

A chapter on the way a program searches for a move and anticipates responses is invaluable to even the moderately serious chess player and to anyone hoping to create their own strategy games.

The book's general style and well-indexed format make it well worth the fiver you could lose against your next opponent.

SC



'Creating adventure games on your dragon 32' by Clive Difford, published by Interface Publications at £4.95 (paperback, 168 pages).

Adventuring is a pastime which must be keeping millions awake trying to defeat elusive creatures, collect treasure and, more importantly, survive.

After much adventuring many players begin to think they could come up with more interesting ideas than those in the games they use. But writing

your own adventures is more difficult than it might at first seem. For one thing, there are so many ways to approach the task.

This book may help. It starts with the assumption that you have played and enjoyed adventure games. Then it shows you how to write adventure games by example rather than by explanation alone.

It contains several complete adventures and a heap of adventure-type utilities including tunes and drawings. The adventures, which are quite good vary in difficulty. Original scenarios, like a city in the 1950s, make these fun to use, while offering insights into the structure, design and programming of adventures.

The book loses points on its lack of index and rather useless contents page, giving only chapter and page number where headings are needed.

Nevertheless, this provides a good start to adventure programming, and it's nice to get a book for £5, when many now cost much more.

PL

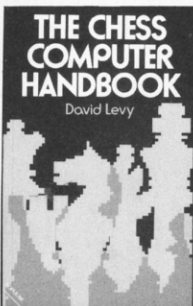

COMET ATTACK

Light Fantastic with Comet Attack

Comet Attack is an exciting new Arcade game.

Defend your territory & penetrate your opponents!

Comet Attack is fast, frenetic and fun. Totally absorbing. Once you start playing you won't be able to stop.

Compatible with Atari 400, 800 & XL, BBC and Dragon computers.

ONLY £6.95 INCLUDING P&P

Comet Attack is available exclusively by mail order from CZ Software, 128 Birch Road, Dextleyheath, Kent Telephone Crayford 527919

FREE Programming Tapes for the 1000 Operations

Phone BBC £6.95 Dragon £8.95 Atari £8.95 (Overseas Required) Prices include Postage & Packaging

SOUTH LONDON'S LATEST RIVAL FOR THE BEST IN HOME AND BUSINESS COMPUTING

— We carry a large selection of Hardware, Software, Accessories for the BBC; ELECTRON; SPECTRUM and CBM 64

Phone now for our SPECIAL OFFERS

MICROS BBC B £395 + D.F.S. FOR £69 SPECTRUM £125 CBM 64 £199 ELECTRON £199	PRINTERS EPSON RX80 F/T £306 EPSON RX80 £250 JUKI £345
MONITORS NOVEX (1414) £228 SANYO DM2112 £80	C15 CASSETTES £0.55 DATALIFE SF-DD £19.95
CASSETTES SANYO DR101 £39.95 SANYO DR202 £44.95 ACORN £34.95	WORD PROCESSORS MERLIN SCRIBE WORDWISE WORD PROCESSING SYSTEMS FROM £999-£1999 DISK DRIVES FROM £140

BUSINESS SYSTEMS DESIGNED TO SUIT YOUR OWN NEEDS, INCLUDING WORD PROCESSING; PAYROLL; INVOICING; STOCK CONTROL ETC. NO BUSINESS IS TOO SMALL OR LARGE

- SPECIAL SYSTEMS DESIGNED FOR
- EMPLOYMENT AGENCIES
- CHEMISTS

AVAILABLE NOW

We are also a professional software house — Always on the look-out for in-house technical or educational software of any kind

CYB
BEST SERVICES

**9 CROWN PARADE, CROWN LANE
MORDEN, SURREY
TEL: 01-542 7662**

MAP

CYB MORDEN UNDERGROUND

BARCLAYCARD ACCEPTED

A short machine code routine can improve your Atari's graphics, says Richard Hawes.

Colourful Antics



The greatest factor in the Atari computer's success has been its graphics, and the greatest contribution to the Atari's graphic capabilities is the enormous range of colour available.

The computer is capable of generating 256 colours, more than any other micro currently available. Regrettably, the Atari Basic language allows you to choose from a maximum of only 16 of these colours at one time. However, with the help of a little machine code in the form of a routine,

more colours and other graphic effects can be achieved.

The program presented here uses one capability of the dedicated Antic graphics chip. The display list interrupt, DLI, Antic, displays the screen by following the program. At the end of every screen various registers such as for colour are checked and the drawing process is started again.

The program Antic follows to draw the screen is called the display list and a

machine code routine in the form of a DLI can be used to interrupt the Antic processor and change the way it draws the screen. The demonstration program fills the screen with 16 vertical bars using 16 brightnesses of one colour. Then a DLI is placed at regular intervals down the screen at 15 different points.

The DLI increments the colour count at each point, making Antic change the base colour for each band of different brightnesses. The screen is now filled with 16 bars

varying through 16 brightnesses of each colour producing 256 colours.

Before the screen is redrawn, the colour registers are reset according to the value of the locations and so the process starts again.

The routine is stored in a reserved area of basic memory known as page 6. A simple explanation of the program is included in the listing.

The display list is obviously the heart of the Atari graphics system but DLIs are not the only embellishment provided. Commands which can be inserted into the display can produce fine horizontal and vertical scrolling and messing about with other display list locations can produce coarse horizontal and vertical scrolling.

The various commands in the display list's program decide which mode lines to display and can be changed to mix up lines from different modes to produce a custom-made screen.

This power of the display list — coupled with other graphic features such as the Atari player and missile graphics system (a

form of sprites), the use of colours and the ability to redefine the character set into as many incarnations as you have memory for — makes the Atari such a notable graphic machine.

This has been exploited mostly in games programs but business and educational software programmers use many of these features to enhance the quality of the software. Business packages such as Book Keeper and Timewise use colourful menus to give quick recognition of the menu selection required. Educational programs such as Marathon and Maths for Fun use sprites for special cursors and redefined characters for more eye-catching and interesting screen displays.

Obviously the graphics on any computer system are important but additional hardware can also strengthen the graphic potential of a computer. Peripherals for the Atari come in the form of graphic touch-tablets, colour printers and joystick-controlled graphic generation programs.

The touch tablet allows immediate translation of pen movements to the screen

display and the utilities provided within the touch-tablet program simplify picture-drawing. Atari's four-colour printer allows you to plot and draw on paper in much the same way as you would on the screen, making colourful hard copy pictures and diagrams easy.

PCN

Line 10 Sets up the computer in the sixteen shade mode, mode 9.

Lines 20-40 Send the computer to the different set-up subroutines.

Line 50 Tells the computer where in memory our display list interrupt will start.

Line 55 Sets the location we are going to use as a counter to 16.

Line 60 Enables DLIs.

Line 70 Continuous loop to stop the computer from returning to mode 0.

Lines 100-140 Fill the screen with sixteen vertical bands in differing shades.

Lines 150-160 Divide the screen into 256 squares. These lines could be left out to alter the display slightly.

Line 190 Terminates the subroutine.

Lines 200-240 Change the positions in the display list specified by the data statements to enable a DLI to occur at that position.

Line 250 Data for previous loop.

Line 260 Terminates this subroutine.

Line 300-320 Pokes the ML routine into the 'safe' area of memory called page 6.

Lines 330-340 Data for the ML routine.

Line 350 Terminates subroutines.

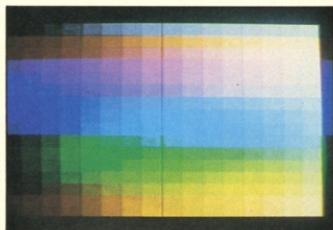
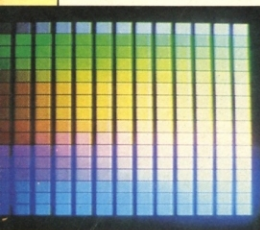

```

10 GRAPHICS 9:REM CHOOSE 16 SHADE MODE
20 GOSUB 100:REM SCREEN SETUP
30 GOSUB 200:REM DISPLAY LIST CHANGES
40 GOSUB 300:REM POKE IN SUBROUTINE
50 POKE 512,0:POKE 513,6:REM STARTS ON PAGE SIX
55 POKE 1536+60,16:REM SET COUNTER LOCATION
60 POKE 54286,192:REM ENABLE DLI'S
70 GOTO 70:REM STOP COMPUTER RETURNING TO MODE 0
100 REM SCREEN SET UP ROUTINE
110 FOR T=0 TO 15
120 COLOR T:FOR U=0 TO 4
130 PLOT T*5+U,0:DRAWTO T*5+U,191
140 NEXT U:NEXT T:REM FILL SCREEN
150 COLOR 0:FOR T=0 TO 191 STEP 12:PLOT 0,T:DRAWTO 79,T:NEXT T:REM
DIVIDE SCREEN HORIZONTALLY
160 COLOR 0:FOR T=0 TO 79 STEP 5:PLOT T,0:DRAWTO T,191:NEXT T:REM
DIVIDE SCREEN VERTICALLY
190 RETURN:REM REMOVE LINES 150/160 FOR DIFFERENT EFFECT
200 REM MAKE CHANGES TO DLIST
210 DLIST=PEEK(560)+256*PEEK(561)
220 RESTORE 250:FOR T=0 TO 15:READ A
230 POKE DLIST+A,128+15
240 NEXT T:REM POKE IN DLI INSTRUCTIONS
250 DATA 15,27,39,51,63,75,87,102,114,126,138,150,162,174,186,198
260 RETURN
300 REM DLI ROUTINE (STARTS AT 0600)
310 RESTORE 330:FOR T=0 TO 42
320 READ A:POKE 1536+T,A:NEXT T:REM POKE IN DLI ROUTINE
330 DATA 72,138,72,24,173,60,6,201,240,240,20,216,24,173,60,6,105,16,
141,10,212,141,26,208,141,60,6,104,170
340 DATA 104,64,169,0,141,10,212,141,60,6,104,170,104,64
350 RETURN
    
```

Moving cartoon-style Dragon adventures have appeared. Pete Gerrard tries them for pace.

Dragon on the move



The moving graphic adventure has arrived in Dragonland at last, now that Dragon Data is releasing *Sea Quest* and *Shenanigans* along with graphics versions of two earlier text adventures, *Calixto Island* and *Black Sanctum*. There are plenty of illustrations, and several of the locations have movement as well, with clouds drifting, water running, and fish swimming.

The first location of *Calixto Island* is a good example of the way the moving graphics operate. You start off in Professor Lagarto's comfortable study, complete with roll-top desk, oriental rug, antique table, a flight of stairs and a clock with a swinging pendulum.

If you move the rug you uncover a trap door, and the scene on the screen shifts. Similarly, opening the trap door registers on the screen, too. It's nothing breathtaking, but it's nicely done.

In all four adventures it's important to examine everything, even if it's not in the description you're given, as this can reveal secret passages, clothes and other objects. In *Calixto Island* you may go on to discover

the professor's secret laboratory, where the moving graphics are flashing electrical equipment.

From there you may also be able to transport yourself to a jungle setting, leading to an ancient Mayan pyramid which holds some of the treasures you have to find.

Black Sanctum was the only title that came to me without a solution, so I had to solve it without being tempted to peek at the answers. The fact that I solved it in about three hours is an indication of how difficult these adventures are. Much as the graphics in all four can be admired, they don't leave much room for tricky tasks, and they're not liable to appeal to those who like their adventures to drag on for months.

The first tasks are to work out the best order in which to do things, and how to move objects around when you can carry only a limited number. Most problems are solved logically, as every object has a purpose. In *Black Sanctum*, for instance, you have to catch a raven at one point, and you don't need David Attenborough to tell you to do this with the butterfly net rather than the shovel. So no red herrings here—not even in *Sea Quest*.

Of the two new titles, *Shenanigans* is a piece of Irish-American whimsy which has you searching for the pot of gold at the end of the rainbow, and this involves the magical shamrock and O'Shaunasee's beer. You begin in your room, look around, get dressed, but can only go downstairs and get out if you can pay the landlord his rent. Walking along the street there are muggers to molest you, and the bar to enter. There, you're offered a choice of three beers—not too hard to work out

which to take, as a sign on the wall tells you. A slug of the right stuff, though, and you're all too likely to find yourself at least half-way to rainbow country.

All these adventures have in common a rather sexist nature, which assumes that the player is male. Something else they have in common is the poor response of the Dragon's keyboard. It is very frustrating, in games where you spend a lot of time ferrying objects back and forth, to constantly find that the result of your typing is OEN DOR OR GO WNDOW.

Of course, this is much more a hardware than a software problem.

Sea Quest again involves bringing treasures back to base, but gives you a longer and trickier game than *Shenanigans*, particularly as one of the mazes you have to explore is under the ocean. At first you're moving your boat N/S/E/W to explore the ocean up above, but at any point you can GO OCEAN to see what's lurking beneath the waves—sometimes nice, sometimes nasty. This assumes you've first gathered together the equipment you'll need to allow you to dive to the depths. Again, good use of graphics, but the average player should be able to polish the adventure off in two or three sessions at most.

It's good to see these four titles added to the limited range of Dragon adventures, but don't expect too much of them. If you feel it's worth trying one to see how you get on with it, then *Calixto Island* and *Sea Quest* are the two that will probably tax you the most.

Sea Quest, *Shenanigans*, *Black Sanctum*, *Calixto Island*, published by Dragon Data at £7.95 each.

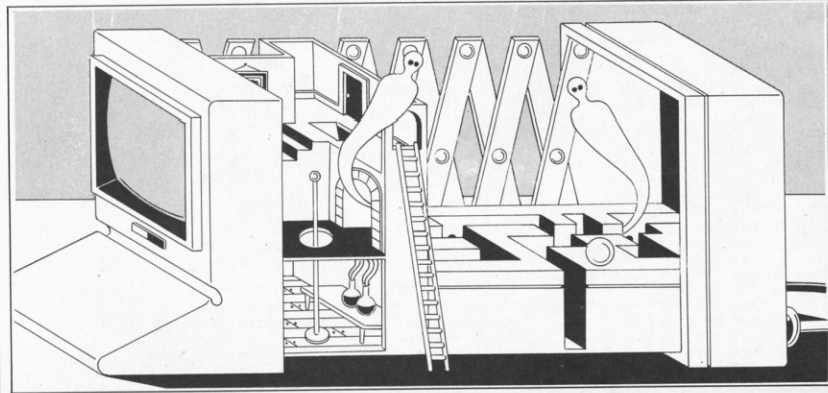

LOOKING FOR SOFTWARE?

WE HAVE BUILT A LIBRARY OF
INFORMATION ON WHAT IS
AVAILABLE

A PHONE CALL IS ALL IT WILL
COST YOU TO GET SOMEONE
ELSE TO COME UP WITH
THE ANSWER

01-625 5404

Hopping about in your programs is the next stage in Keith Hook's assembler programming series.

Jumping Jack flash

Jump instructions cause normal, sequential program execution to branch to a different part of the program. There are basically two types: JP, 3C00 Hex — Absolute Jump, and JR, START — Relative Jump. These instructions can be split into two further groups:

- The unconditional jump, which causes a branch to another part of the program regardless of any conditions; and
- The conditional jump, which forces a branch to another segment of the program if one or more stipulated conditions are met.

	2 ⁷	2 ⁶	2 ⁵	2 ⁴	2 ³	2 ²	2 ¹	2 ⁰	
	7	6	5	4	3	2	1	0	
0	█	█	█	█	█	█	█	█	= 129
1	█	█	█	█	█	█	█	█	= 66
2	█	█	█	█	█	█	█	█	= 60
3	█	█	█	█	█	█	█	█	= 66
4	█	█	█	█	█	█	█	█	= 129
5	█	█	█	█	█	█	█	█	= 90
6	█	█	█	█	█	█	█	█	= 36
7	█	█	█	█	█	█	█	█	= 231

Data for Graphic

In the example in figure 1, NEXT can be located at any address within the range of -128 to +127 bytes from the current instruction LD A, (BUFFER). The relative jump saves one byte over the JP instruction, and code constructed using JR type jumps is relocatable. The assembler will calculate the correct displacement for you and insert it in the object code on assembly.

Conditional Jump

Basic: LETA = X; IF X = 3 THEN GOTO 1500

Assembler: LDA, ; get value
(BUFFER) ; from buffer
CP 3 ; is a = 3
JP Z, FINISH ; yes then
 ; goto finish.

Relative Unconditional Jump:

Basic: LETA = X; GOTO 1500

Assembler: LDA, ; Jump to
JR NEXT ; segment
 ; labelled
 ; NEXT

Figure 1

If you use a JR instruction illegally the assembler will point out the error.

There are some differences between conditional JPs and JRs:

- The conditional absolute JP: JP NC, FINISH can test four different flags, and a branch can be forced of the following conditions: Zero: Not Zero: Carry: No Carry: Parity Odd: Parity Even: Positive: Minus.

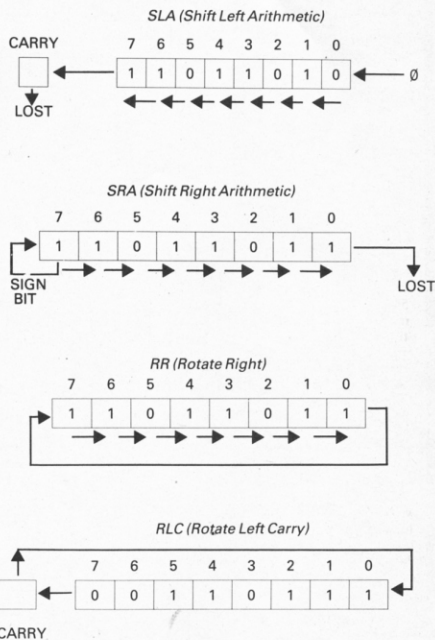

```

:
: *****
: *
: * GRAPHIC GENERATOR *
: * ASCII NUMBER 16 *
: * (C) P.C.N 1984 *
: *
: *****
:
: LIST OF EQUATES
BLOCK: EQU 16H ; SOLID BLOCK GRAPHIC █
MATCHR: EQU 0E9H ; ASCII NUMBER 16 █
:
: INPUT: EQU 0049H ; MATRIX GRAPHIC □
: ; MUST HAVE HIGHER VALUE THAN
: ; ASCII 16
: ; GENIE KEYBOARD SCAN
: ; EQUATE YOUR COMPUTER
: ; IN KEY# ADDRESS HERE.
: ; SPACE BAR
: ; 'S' KEY
: ; UP ARROW
: ; DOWN ARROW
: ; BACKSPACE
: ; TAB RIGHT ARROW
: ; ENTER-RETURN KEY
: ; CLR KEY
: ; 8 LINES DOWN - 17 COLS IN
: ; COLOUR GENIE GRAPHIC RAM
: ; INSERT YOUR OWN MACHINE'S
: ; LOCATION OR USE BUFFER
: ; AS FERNHENT LOCATION.
:
: SPC: EQU 20H
: SET: EQU 53H
: UP: EQU 08H
: DOWN: EQU 0AH
: LEFT: EQU 08H
: RIGHT: EQU 09H
: ENT: EQU 00H
: CLR: EQU 1FH
: SCR#: EQU 4551H
: GRAPH: EQU 0F400H

```

Figure 2

● The relative jump can test for only two flags, Zero Flag and Carry Flag. It cannot test the Parity/overflow or Sign Flags.

Shifts

A powerful type of jump instruction, the DJNZ, is used to terminate loops. It decrements the B register then jumps to a specified location so long as the B register is not zero (NZ). In Basic:

```
100 FOR I=0 TO 9
110 LET A=A+1: NEXT I
```

In assembler:

```
LD B, 09; B register = 9
LOOP: ADD A, 01; Value in A reg incremented by 1
DJNZ LOOP; Decrement B if not = to zero; go to it again.
```

Shifts are frequently used to multiply or divide by the power of two. For instance, suppose an eight-bit number is shifted right by one bit position. The result is the same as dividing by two, with the remainder being discarded. On the other hand, shifting an eight-bit number left by one bit position is the same as multiplying by two (Issue 57).

There are two shift instructions to move bits to the right — one arithmetic shift and one logical shift. The SRL (Shift Right Logical) operates in exactly the same way as the SLA instruction with the carry bit being lost and a zero being moved into the seventh bit. However, the SRA (Shift Right Arithmetic) preserves the sign bit 7.

Rotates are identical in operation to shifts except that the seventh bit, which would normally be lost, is rotated and preserved.

Now on to graphic design, one of the most tedious programming tasks. Fortunately, most computers use the eight-bit formula for storing and generating graphics, and this makes designing a compatible program a lot easier.

Alterations

The graphic generator we'll design should allow the display of an 8x8 matrix, and it should be possible to move the cursor around this matrix with predefined keys. One key should set a graphic block at the cursor position, while the space bar should delete a block at the cursor position. The designed graphic should be displayed actual size on screen, and the data for the graphic stored in a buffer in a sequential format, such as ASCII 0-255.

Some form of altering a graphic already in the program, which means that the graphic characters already designed must be displayed in such a way that the user can choose which graphic to alter. Other refinements will be added as the program develops.

The addresses used within the program are for the Colour Genie, but it can be converted for most machines by using different values as documented. No calls are made to the system ROM so the program is machine convertible.

```
START: JP START2
BUFFER: DS 400H ; ASCII CHARS 128 TO 255
; ; ; B * 128 = 1024 BYTES.
;
START2: ; * THIS SECTION TO FOLLOW LATER
;
; SUBROUTINE TO DISPLAY AN 8*8 MATRIX AND ALLOW USER TO
; DESIGN, DELETE, ALTER GRAPHICS. ROUTINE CALLED FROM
; MAIN PROGRAM. NOTE ** HL POINTS TO COLOUR RAM LOCATION
; ON ENTRY NOT VIDEO RAM AND CURSOR IS A COLOUR BYTE THAT
; HIGHLIGHTS ANY PIXEL SET IN MATRIX IN WHITE ALTERNATING
; WITH RED.
;
GRAPHIC: LD BC, 8090H ; REG B = 80H - REG C = 80H
; THESE VALUES USED AS REFERENCE
; POINTS TO KEEP CURSOR IN MATRIX
SUB3: LD (HL), 72H ; CURSOR COLOUR RED
CALL INPUT ; CHECK IF ANY KEY PRESSED
LD (HL), 83H ; CURSOR COLOUR NOW WHITE
CP CLR ; CLEAR KEY ?
JP Z, INPUTG ; YES
CP ENT ; ENTER KEY ?
IF Z, STORE ; YES
CP LEFT ; BACKSPACE ?
JR NZ, SUB1 ; NO GO TRY ANOTHER KEY
RLC B ; YES BACKSPACE SO ROTATE B
JR NZ, SUB2 ; LEFT IF CARRY NOT SET THEN
; CURSOR STILL IN MATRIX
RRC B ; CARRY SET SO CURSOR OUT OF MATRIX
; SO RESTORE TO ORIGINAL POSIT
; AND HAVE ANOTHER TRY
SUB2: JR SUB3
SUB1: DEC HL ; DEC CURSOR POSIT IN COLOUR RAM
; AND DISPLAY AT NEW POSITION
CP RIGHT ; RIGHT ARROW ?
JR NZ, SUB4 ; NO
RRC B ; YES SO ROTATE RIGHT B
IF NO CARRY SO INC CURSOR
ELSE RESTORE TO ORIGINAL POSIT
; TO STOP CURSOR GOING OUT OF MATRIX
SUB5: INC HL ; INC CURSOR POSITION
; AND DISPLAY NEW POSITION
SUB4: CP UP ; UP ARROW ?
JR NZ, SUB6 ; NO TRY NEXT KEY
RLC C ; YES SO THIS TIME ROTATE LEFT C
IF CARRY NOT SET STILL IN MATRIX
ELSE RESTORE CURSOR TO STOP IT
; GOING OUT TOP OF MATRIX
SUB7: LD DE, 0FFD8H ; FFD8 ADDED TO HL DECS 28H FROM POSIT
ADD HL, DE ; (FOR 40 CHAR SCREENS)
JR SUB3 ; DISPLAY NEW POSITION
SUB6: CP DOWN ; DOWN ARROW ?
JR NZ, SUB8 ; NO
RRC C ; YES ROTATE RIGHT C TEST FOR OUT
OF BOTTOM OF MATRIX
IF Z, RESTORE
AND GO TRY AGAIN
SUB9: LD DE, 28H ; ADD 28H (40 COL SCREENS)
ADD HL, DE ; NEXT LINE OF MATRIX
JR SUB3 ; DISPLAY NEW POSITION
SUB8: CP SET ; 'S' KEY ?
JR NZ, SB1 ; NO
PUSH HL ; SAVE CURSOR POSIT IN COLOUR RAM
LD DE, 5400H ; 5400H ADDED TO HL = SCREEN LOCATION
ADD HL, DE ; IN VIDEO RAM
LD (HL), BLOCK ; SET BLOCK IN MATRIX
SB3: POP HL ; RESTORE COLOUR RAM POSITION
JR SB2 ; CHECK NOT OUT OF MATRIX
; BEFORE DISPLAYING NEW CURSOR POSIT
SB1: CP SPC ; SPACE BAR ?
JR NZ, SUB3 ; NO GO TRY SCAN AGAIN
PUSH HL ; ELSE SAVE POSITION
LD DE, 5400H ; ALIGN TO VIDEO RAM
ADD HL, DE ; TO DISPLAY MATCHR
LD (HL), MATCHR ; ON SCREEN
JR SB3 ; THEN GO GET CURSOR POSIT
; TO TRY IT ALL AGAIN
; TO BE CONTINUED.....
```

The final of part of Keith Hool's introduction to assembly language programming will appear in Issue 69.

SOFTWARE FOR THE MEMOTECH FDX-HDX

LANGUAGES

MICROSOFT BASIC
PASCAL — FORTRAN

BUSINESS

PEACHTREE
SAGE
WORDSTAR
PEACH TEXT

APPLICATIONS PROGRAMS

D BASE II
CARDBOX
MACRO 86

Many others now available. Please call or telephone for further details.

TIMATIC SYSTEMS

LIMITED

Newgate Lane,
Fareham,
Hants. PO14 1AN.
Tel: (0329) 239953

Portable Software!

for the
TRS-80 MODEL 100
NEC PC-8201A
OLIVETTI M10

MPLAN £46.00

- 90 Row x 26 Column SPREAD SHEET
- Labels, Constants, Variables, Formulae
- Full Replication, Direct and Relative
- Save/Load to/from RAM or Cassette
- Many Special Math & Printing Functions

MSOLVE £46.00

- MULTIPLE EQUATION SOLVING Package
- 20 Equations & 99 Variables per System
- 10 Extra Functions & AON Calculator

M BRAIN £28.75

- Full RPN CALCULATOR w/visible stack
- 30 Functions, 6 Special Calculators
- Double Precision Accuracy

MICROTIME INTERNATIONAL LIMITED
106A BEDFORD ROAD, WOOTTON, BEDS MK43 9JB
Tel. (0234) 76758/766351
(literature available on request)



UNBELIEVABLE SAVINGS

** COMPUTERS **

		EX VAT
APRICOT	256K 315Kx2 MONITOR	£1425.00
APRICOT	256K 720Kx2 MONITOR	£1825.00
APRICOT	XI 256K 5MB MONITOR	£2175.00
APRICOT	XI 256K 10MB MONITOR	£2295.00
APRICOT	Optional 12in MONITOR	£220.00
CIFER	9000 Multi User 21MB	£5995.00
COMMODORE	8250 DISK DRIVE	£785.00
COMMODORE	8296	£895.00
COMMODORE	SX-64 PORTABLE	£875.00
COMMODORE	64	£152.17
COMMODORE	DISK 1541	£165.21
COMMODORE	IBEK PARALLEL INTERFACE	£59.50
COMMODORE	1530 CCN CASSETTE	£32.00
COMPAQ		£1895.00
EPSON	10X10	£1600.00
KAYPRO	II	£945.00
KAYPRO	QXMB	£1995.00
OLIVETTI	M20 160KB 2x320KB Drives	£1295.00
OLIVETTI	M24 128KB 2x360KB Drives	£1650.00
OLIVETTI	M24 128KB 10MB Hard Disk	£3315.00
OSBORNE	I	£1175.00
SAGE	II & IV	POA
SANYO	MBC 555 128K 2x160K Drives	£795.00
SIRIUS	256K 10MB	£2850.00
SIRIUS	256K 2.4MB	£2095.00
SIRIUS	128K 1.2MB	£1545.00
SIRIUS	Memory Expansions from	£222.00
SIRIUS	Express Accelerator Boards	POA
SIRIUS	PLUS 5 External Hard Disk Drives	POA

** VDU'S & TERMINALS **

CIFER	T4	£760.00
HAZELTINE	ESPRIT Fixed Keyboard	£395.00
QUME	QVT 103 (VT100 VT131)	£695.00
TELEVIDEO	910	£489.00

** SOFTWARE **

ALL MAJOR SOFTWARE PROGRAMS SUPPLIED AT LOW COST

Plus:

Not only do we offer top quality products at low prices. We also support and develop Software with the assistance of our long established software dept.

** MATRIX PRINTERS **

		EX VAT
ANADEX	DP-6500 500cps	£2019.00
ANADEX	WP-6000	£1908.00
BROTHER	EP44	£1799.00
BROTHER	HRS	£1239.00
CANON	PW1080A 160cps (NLQ)	£2779.00
CANON	PW1156A 160cps (NLQ)	£3339.00
EPSON	RX 801 100cps	£1939.00
EPSON	RX 80FT 100cps	£2200.00
EPSON	FX 80 160cps	£324.00
EPSON	FX 100FT 160cps	£430.00
EPSON	LQ 1500 200cps (NLQ)	£895.00
HONEYWELL	POA	£199.00
MANNESMANN	MT 80 80cps	£190.00
MANNESMANN	MT 180 160cps (NLQ)	£590.00
NEC	PINWRITER	POA
NEC	DRE 8950 300lpm	£2095.00
NEC	DRE 8925 240cps	£1385.00
OKI	82A 120cps	£255.00
OKI	84A 200cps	£630.00
OKI	OKI 82P 160cps	£379.00
OKI	OKI 2410P 350cps	£1535.00
SEIKOSHA	GP100A	£165.00
SHINWA	CP80 Model II FT	£175.00
STAR	DELTA 1A 160cps	£329.00
STAR	DELTA 15 160cps	£445.00
STAR	GEMINI 10X 120cps	£199.00
STAR	GEMINI 15X 120cps	£295.00
STAR	RADIX 10 200cps (NLQ)	£449.00
STAR	RADIX 15 200cps (NLQ)	£549.00
STAR	1550 120cps	£485.00
TEC	TH2100H 192cps	£1275.00
TOSHIBA	TREND	£1350.00
TOSHIBA	930 200cps NLQ 80cps	£1350.00

MAYFAIR MICROS

BLENHIM HOUSE, POMDORRE ROAD,
LONDON SW18 1AJ

TEL: 01-870 3255

We accept official orders from UK Government and Educational Establishments. Mail Order and Export Enquiries welcome. Callers by appointment.

** DAISYWHEEL ** ** PRINTERS **

		EX VAT
BROTHER	HR1	£445.00
BROTHER	HR15	£329.00
BROTHER	HR15 Keyboard	£135.00
BROTHER	HR15 Sheetfeeder	£185.00
BROTHER	HR15 Tractor Feed	£52.00
BROTHER	HR25	£549.00
CANON	AP400 KSR	£760.00
POA	DAISYSTEP	£240.00
POA	2000 20cps	£240.00
DIABLO	630 AP1	£1315.00
DIABLO	Sheet Feeder	£490.00
DIABLO	SP830 RO (S) 80cps	£1185.00
FUJITSU	6100 18cps	£325.00
JUKI	2010 Serial 20cps	£645.00
NEC	2030 Parallel 20cps	£645.00
NEC	3510 Serial 35cps	£1149.00
NEC	3530 Parallel 35cps	£1149.00
NEC	7710 Serial 55cps	£1499.00
NEC	7730 Parallel 55cps	£1499.00
OLYMPIA	ESW103	£825.00
QUME	1140 RO	£1185.00
QUME	1155 RO	£1370.00
QUME	945 RO	£1550.00
QUME	955 RO	£1900.00
RICOH	RP1300S	£895.00
RICOH	RP1600S	£1190.00
RICOH	1550 FLOWWRITER 8k	£1249.00
RICOH	1550 FLOWWRITER 8k	£1299.00
RICOH	IBM PC	£459.00
RICOH	RP1600S Sheet Feeder	£138.00
SILVER REED	EXP500 (P) 16cps	£570.00
SMITH		
CORONA		
TEC	TPI 12cps	£195.00
TEC	STARWRITER 1040 40cps	£895.00
TEC	STARWRITER 1055 55cps	£1235.00
TEC	Sheetfeeder	£459.00
TEC	Tractor	£138.00
TEC	UCHIDA	£230.00
TEC	DWX-305 (S or P) 18cps	£230.00

** PLOTTERS **

MANNESMANN	PLOTTER	£495.00
GOULD	PLT/LOTTER	POA

HOUSE MOUSE

The latest offspring for Apple micros is tested by Geof Wheelwright.



Howard Kingsworth

By using a mouse on its Macintosh and Lisa micros, Apple has made WIMPs (Windows Icons Mice Programs) this year's chic piece of kit—something no mouse should be without.

Because of this, it seems natural that Apple should want to have its other machines decked out with this year's gadget. The mouse interface for the Apple II and Apple IIe machines is aimed at doing just this. I tested the mouse add-on package with Apple's new IIc, but was told by Apple that the package for the II and IIe is functionally identical. The only practical difference is that the II and IIe interfaces come with plug-in card which gives the machine a standard mouse socket at the back (the IIc comes with this socket fitted).

Presentation

The IIc mouse comes in a box about the size of an IBM PC manual and contains one disk, a brief user's manual and the good old mouse.

The mouse itself is identical to those used on the Macintosh and the Lisa.

Installation

On the IIc, the mouse is as easy to install as a joystick — it simply plugs in a socket at the back of the machine. On the II and IIe machines, the expansion card is easily fitted and the mouse hole (socket) comes out of the back of the machine on the edge of the card.

Documentation

The manual is very brief and to the point, comprising 42 pages, of which only few talk about using the mouse. Most of the manual is devoted to telling you how to use the Mousepaint program and the section on the mouse is mainly about maintenance.

Once you've dispensed with learning Mousepaint, the most useful section of the manual is that on accessing the mouse from programs in Basic.

This comes in the form of a five-page appendix with two example programs. One can't help but feel this section of the manual could have been expanded con-

siderably — although the argument could be made (and obviously was) that anyone using the mouse isn't likely to be writing masses of programs in Basic for it.

That argument would also, unfortunately, suggest that until any other Apple II mouse programs are released, you will be buying the mouse interface just to use Mousepaint.

In use

The IIc mouse is one of those pleasant peripherals that actually comes with its own software.

The Mousepaint program is functionally identical to the MacPaint program included with the Macintosh, although Mousepaint doesn't have quite the same resolution and flexibility as its counterpart.

Mousepaint is written under the ProDOS operating system and greets you with a series of menu options that allow you to run through a mouse-driven tutorial, use Mousepaint, or quit the program. If you're impatient, you will probably opt for going straight into Mousepaint — which turns out to be so easy to use that a tutorial is almost redundant.

Mousepaint looks extraordinarily like MacPaint, with its painting 'options' down the left-hand side of the screen, pattern boxes along the bottom, and the input/output pull-down options along the top. All the paint features you would expect from such a package are there: paintbrush, pencil, rubber, various-shaped boxes and circles, text, an editing box (to mark an area for movement, copying or cutting), fat bits (to edit a picture pixel by pixel), show page (to preview a finished page), and a grabbing hand to move the page left, right, up and down.

It is not completely identical to MacPaint as things move a little slower and the movement of objects around the screen tends to flicker. Apart from that, it is an excellent implementation of the Mac-style painting package.

The mouse is well-built but quite susceptible to dust and dirt. You have to make sure that you operate the mouse on a clean and dry surface if you don't want to have to clean it every half-hour. It operates by sensing the movement of a little rubber ball against two rollers on an X-Y axis system.

The two rollers have slotted rotating disks attached to them, through which the movement is sensed.

This is the alternative to using a light beam that bounces off the surface over which the mouse is moved.

Verdict

The mouse is a good addition to any Apple. The ultimate usefulness of this ultra-chic product will, however, be determined by how quickly Apple and others can bring out more Apple II software that uses it.

Product Apple Mouse for the Apple II, IIc, IIe
Price £135, includes the expansion card for the II and the IIe. **Distributor** Any Apple dealer. For list of dealers ring 0442 60244.

Memotech's disk drive system could make all the difference between a competent home micro and a business-like workhorse. It turns the MTX 512 into a CP/M system, and home users will be attracted to its potential for program development under assembler conditions.

The FDX is impressive in its matt black aluminium cabinet. It measures 19 by 11½in and, though large by normal standards, should look equally well in the home or on an executive's desk.

The front panel houses two disk drives, labelled B and C, the on/off switch, and the fan outflow grill. All necessary input/output connections are neatly tucked away on the back panel. These include 16-colour RGB and composite (B/W) video outputs and single channel sound. There are three slots on the back for future add-ons: two are for extra disk drives, 5¼in and/or 8in, and the third for bus expansion. To the left is a low voltage power output allowing the computer to draw its power from the drives.

Inside the FDX disk system are the 80-column card, floppy disk controller, and space for up to four of the MTX Silicon (fast access RAM) disks. These can be used to simulate CP/M drives A to M, and when fitted, are treated as physical drives.

M · T · X Gets Serious

The FDX disk drives made Keith Hook's MTX 512 into an attractive CP/M system.



pressed immediately after switch on, the machine goes into 'input mode'. This mode can be used to set up a number of boot-up options from the keyboard. The FDX system was very reliable and the visual displays were clean with good colours. Routing the composite video output through a video recorder and into a Sony television gave remarkable results.

Software

Three pieces of software are bundled with the FDX: a CP/M 2.2 system disk, a Supercalc spreadsheet, and the New Word word processor. The CP/M system disk is a standard version with a few customised commands for setting up and controlling the RAM disks tacked onto the rear.

New Word appears to be a modified version of Wordstar tailored for the Memotech's keyboard. Memotech is adamant that the few bugs in the review version have been fixed.

Documentation

Three of the manual's four sections cover the software packages. The fourth, on technical aspects of the machine, is well documented though it fails to cover the layout of the screen configurations.

The CP/M is dealt with on a step by step basis with details of each command. The manual does not delve deeply into the Editor, Assembler and Debugger commands, but specialist books are available.

Verdict

These drives are good, especially for the price, though MTX Basic is sadly not available under FDX. Memotech hopes to remedy this but until it does the user is left with the outdated MBasic.



The back of the FDX shows the expansion slots and the fan inflow grill.

Name FDX disk system (for the Memotech MTX512) **Price** £870 inc carriage **Manufacturer** Memotech Microcomputers, Station Lane, Witney, Oxon. Tel: 0933 2977.

The Alpha PROM divides into three parts. The first section contains the 96 standard characters, the second contains 96 alternate characters, and the final 64 characters are special graphics symbols. The Graphics PROM contains all 256 possible combinations of the eight pixels making up a graphics character.

Characters are printed to the display using the appropriate control and escape codes for colour, attribute, and character set selection. Since the attribute byte has different effects according to whether the display is monochrome or colour, it is possible to get underlining, bright characters, and reverse video instead of colours.

The visual display system built into the 80-column board is powerful and complex. It contains 2K×16-bit words of memory — each of the 1920 (80×24) character locations has one 16-bit word associated with it.

Two character generator PROMs are provided, one for the Alpha characters and one for the bit mapped Graphics characters, each containing 256 shapes. The 16-bit character word associated with each shape contains two pieces of information; the most significant eight bits refer to the character number, the least significant eight bits refer to the attributes that control the display of the character.

The rear of the MTX 512 showing the ribbon cable for connection to the FDX disk drives.

If the system is bought as an add-on, as was the review model, the RS232 communications board needs to be fitted into the computer, which is a straightforward ten minute job, following the instructions.

In use

The 80-column card gives a choice of two character sets and a 64 element graphic set, all obtained from the keyboard by pressing a combination of keys. In addition there is a teletext character set that can be used from within programs. This 80-column card is a sophisticated piece of hardware, and was a dream to use.

On power up, the FDX carries out a RAM check and, on insertion of the system disk, boots up the system. The VDU now displays the configuration of the disk drives, top of available RAM etc. Physical drive B is mapped onto logical drive A to give the normal 'A>' prompt.

It is possible for drive A to be mapped onto any of the physical drives so that the bootstrap PROM can boot from any of the installed drives. If the carriage return is

Try pulling a stunt like this on your Spectrum

Leap on a moving train... jump from carriage to carriage... duck under fast-approaching bridges.

But before you do *anything*, make sure it's with Sinclair's new action-packed game - 'Stop the Express'.

That way, you can try dramatic feats like Buster Keaton's - without risking your neck!

'Stop the Express' is one of five exciting new games from Sinclair. Its graphics are superbly fast and sharp. The action is non-stop. And the challenge is a very tough one.

On top of a racing express, you're chased by knife-throwing bandits. And inside the express, there's even more trouble.

Will you ever get to the front and halt the train? Or will you be well and truly bumped off?

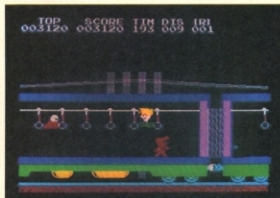

All five new Sinclair titles - Stop the Express, Bubble Buster, Zipper Flipper, Eric and the Floaters, and Driller Tanks - are for a 48K Spectrum. You'll find them in the shops - today.

At only £5.95 each, they're destined to be big stars on the small screen!

Selected Sinclair software lines are available from W.H. Smith computer stores, larger branches of Boots, John Menzies, Greens and most other software stockists nationwide.

Sinclair Research Ltd, Camberley (0276) 685311.

© Sinclair, ZX and ZX Spectrum are trade marks of Sinclair Research Ltd.

sinclair

FIRE UP THE BEEB

Unix for the BBC, tried and tested by Richard King.

The BBC micro is among the first to benefit from microcomputing's newfound interest in Unix. Until recently, the high cost of this powerful mainframe operating system restricted it to commercial use. But a change in pricing policy has enabled Torch to implement it on the BBC. The Torch version, Uniplus, runs on Unicorn, a system based around the MC68000 processor with Winchester hard disk, and 5.25in floppy drive.

As reviewed, the Unicorn isn't a stand-alone system. It requires a BBC Model B as a kind of high-speed terminal, to which the Unicorn is connected by three separate channels.

What makes it a Unix machine is a card carrying a 68000 processor; the rest is actually a Torch Winchester disk-pack.

The 68000 card can be plugged into any Torch computer to give the same system from an operational point of view.

Superficially Uniplus differs little from real Unix and underneath not enough. If you forget that the processor is next to you, instead of in the basement, it feels like Unix on a VAX. It responds at about the same speed, and at times I couldn't believe a 68000 was in there.

For instance, when I activated so-called

concurrent processes which all produce screen output, I was forced to conclude that process-swapping was a more apt description.

The program in question runs two programs as sub-processes: one draws raindrops which splash on landing and the other makes worms wriggle.

The term concurrent usually means tiny slices of time (100ths of seconds) being allocated to each of the active processes so that they appear to run smoothly, even if only more slowly.

Uniplus, it would appear, uses larger slices—more like 10ths of seconds. So you get a few raindrops which then freeze, the worms move a bit and stop, then the rain resumes.

Otherwise, Uniplus is an excellent implementation. It's complete, has the tools associated with a full system, and several more exotic ones.

Documentation

Documentation has as much massed and close-spaced text as anyone could want, but remains usable. Accurate and comprehensive, with a standard format, it was written, manipulated, formatted, indexed and set on Unix.

TORCH
COMPUTERS



Installation

Connecting the Unicorn to a BBC involves three ribbon-cables which plug into the Tube, 1MHz bus and disk port. As with most of the BBC filing systems, a ROM must be fitted, in socket 5. Then you can power-on (Unicorn first) and the system should boot.

Apparently this can take quite a while. According to the documentation the next stage is to partition the hard-disk before loading up as much of the system as you require from floppy disk. This may or may not be the whole lot, depending on whether you want to keep part of the Winchester for use with other operating systems such as CPN, but Unix must have at least 4Mb of space, and really prefers 8Mb or more. If this isn't available, you may have to leave out essentials.

The physical design of the Unicorn is its most obtrusive feature and its least likeable. Part of the problem lies in the shape of the case, which is taller than usual for a desk-standing item, particularly one without a screen. Since it's attached to the BBC by a 12in cable, you find it standing so close you can't even push it back to clear the edge of the keyboard, so your hand keeps banging into it.

C language

C is among the newer generation of high-level languages. It was developed in the early '70s and descended from Martin Richards' BCPL language via the experimental language B.

One of its first important uses was in rewriting the Unix operating system. This had originally been composed in machine code, but apart from the low-level drivers, is now almost completely written in C.

33 ▶

The main board carries the memory bank with the 68000 chip at the bottom and Z80 beneath that.

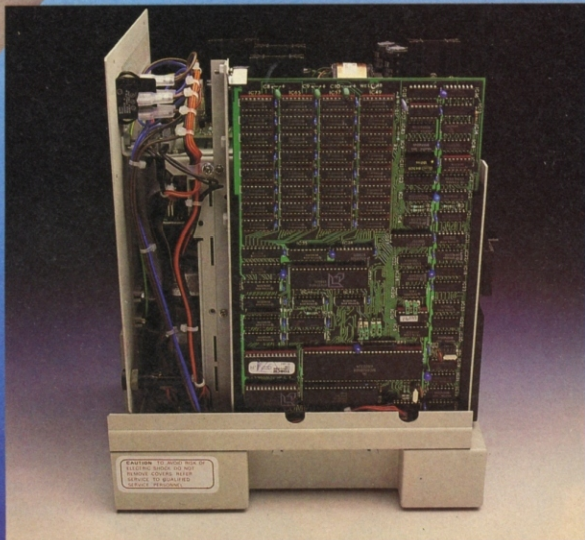
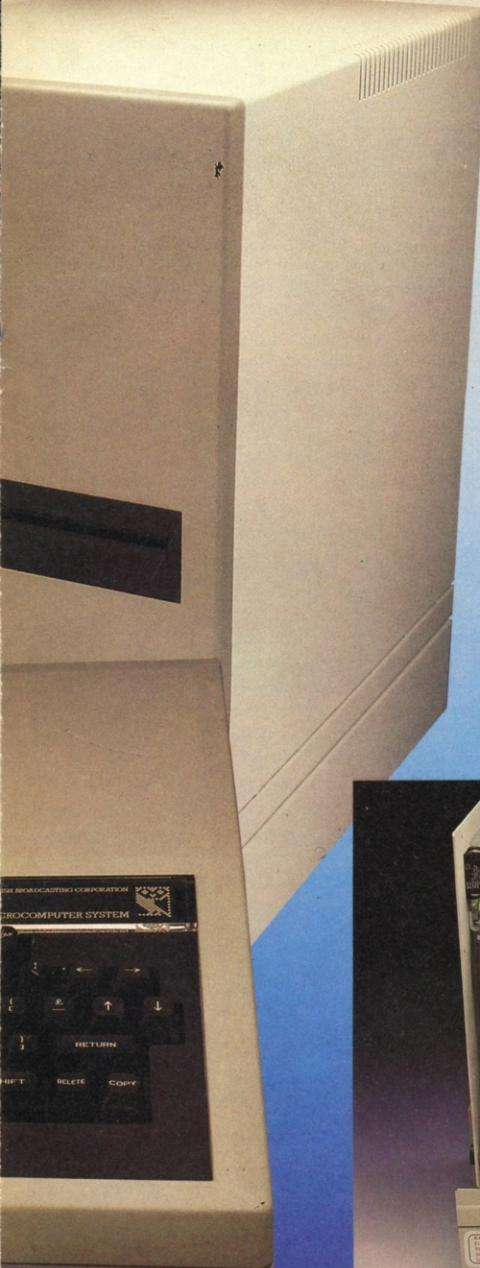

Small business can now stop going by the book.

For under £1,000 a small business can now equip itself with a BBC Microcomputer, a disc drive, a word processor and printer.

(All tax deductible by the way.)

Once you've parted with that money, you'll find that business has never been brisker.

Because now, there's a new series of floppy disc software specially for the smaller business.

It has been developed by Acornsoft, the software division of Acorn Computers who are the manufacturers of the BBC Micro.

For only £24.95, each disc can store volumes of vital bookwork which can be updated and amended in a fraction of the conventional time.

And there is a disc to cover most aspects of paperwork and book-keeping.

The Invoicing package.

This program stores details of products, VAT numbers and, of course, the names and addresses of your customers. As orders come in, you simply record them. Then, when it's time to invoice, you just press a few keys and each invoice or credit note is printed automatically in seconds.



Allowing for variable terms of trading, the system calculates and prints discounts. And it should help to improve your cash flow dramatically.

The Order Processing package.

With this program, you can confirm your customers' orders, prepare and print despatch notes and make fast analyses of individual orders or of all the orders stored on disc.



The Accounts Receivable package.

Now, it couldn't be easier to keep your customer accounts under control.

In an instant, you can analyse debtors, produce statements, keep a check on any credit limit and calculate VAT output automatically.

Using this package in conjunction with the invoicing package, you can also keep tabs on payments received against payments outstanding.



The Accounts Payable package.

This package will keep you fully up-to-date on how much you owe and who to. In addition, it calculates



input VAT and, used with the Accounts Receivable package, produces instant VAT returns.

It also highlights settlement discounts, produces remittance advices and provides an immediate analysis of all creditors.

The Stock Control package.

Touch a few keys and you have instant access to stock status and automatic analysis by quantity and value.

Consequently, it's easy for you to maintain correct stocking levels, having an early warning of out-of-stock situations or the likelihood of over-stocking.



The Purchasing package.

All your suppliers' names and addresses go onto the disc. Then they can be retrieved instantly for preparing and printing orders.

All order data can be recalled in seconds, allowing you to check on orders, and suppliers' invoices and to record all deliveries.



The Mailing package.

Instead of the shotgun method of sending mailshots, this package enables you to refine each mailing down to the customers who are most likely to respond.

It gives you a rapidly accessible mailing file of your customers, according to any criterion you choose. Size of company, for instance, or type of business.



Average value of the business they do with you, or whether they are good or bad payers.

Then, when you are doing a mailing, you simply choose the group or groups of customers you want.

At £24.95 each, these packages could be priceless.

Each package comes with clear instructions on how to get the program running so that you can devote much more of your time to more profitable activities.

If you're a credit card holder, you can order any or all of the packages by ringing: 01-200 0200 anytime. Or 0933 79300 during office hours.

(By ringing the same number, you can get the address of your nearest stockist, or full details of the BBC Microcomputer system if you don't already have one.)

Alternatively, you can order the packages by sending the order form below to: Acornsoft, c/o Vector Marketing, Denington Estate, Wellingborough, Northants NN8 2RL. Please allow 28 days for delivery.

☎ Credit card holders, phone 01-200 0200, anytime. Or 0933 79300, during office hours.

To: Acornsoft, c/o Vector Marketing, Denington Estate, Wellingborough, Northants NN8 2RL.
Please send me the following business software packages at £24.95 each.

PROGRAM	QUANTITY	TOTAL	(Code Acornsoft use only.)
Invoicing			SNB 08
Order Processing			SNB 12
Accounts Receivable			SNB 10
Accounts Payable			SNB 13
Stock Control			SNB 11
Purchasing			SNB 14
Mailing			SNB 09
TOTAL			

I enclose PO/cheque payable to Acornsoft Ltd. Or charge my credit card.

Card Number _____
Amex/Diners/Visa/Access (Delete)

Please send me details of the BBC Microcomputer System

Name _____ FCN6

Address _____

Postcode _____

Signature _____

Registered No. 1524763

VAT No. 215 8123 85

ACORNSOFT

A STAR IS BORN



PRESTEL, MICRONET, BBC to BBC file transfer, Terminal Emulation.

Comstar is unique and complete, a total solution. Imagine, a single Eprom based package of sophisticated communications software that caters for all your requirements.

Imagine Comstar

Take for example British Telecom's Prestel service offering access to a multitude of up-to-the-minute information pages, world news or weather and much more. Instant access to Micronet 800 with many free programs that can be downloaded in seconds, free advice and news. Expand your horizons and find out just how versatile our computer can really be!

How many times have you wanted to get a copy of a program to a friend or a business colleague, quickly? With Comstar you can transfer a file of ANY type, between two BBC's (which may be thousands of miles apart), in the space of a phone call.

It really is that simple. Comstar is 'intelligent', it offers many advanced features to ensure simple and effective communication with the remote system.

Consider the following features:

Prestel Mode

Prestel mode features full colour Prestel graphics including double height and flashing characters. Full Teletextware capability is offered allowing the many free programs offered by Micronet 800 to be downloaded into your computer. Pages of particular interest may be 'marked' for later retrieval and display. Page images may be copied and saved to a file on the current filing system.

Terminal Mode

In terminal mode all input may be copied into a buffer in memory or spooled directly on to disc. Full control over buffered data is provided allowing it to be listed to screen or printer, sent to the RS423, saved to or loaded from the current filing system (including TAPE).

Comstar allows full configuration and easy control over the protocols used. Send and receive baud rates, word length, parity and number of stop bits are selected from a simple table of options.

When in chat mode (80 or 40 column), characters transmitted by the host will be displayed on the BBC screen and characters typed on the BBC will be sent to the host.

Comstar allows ANY type of file (not just ASCII) to be transferred 'safely' using XMODEM protocols. In fact, four individual methods of transmission are provided for within Comstar (giving great flexibility).

Using a disk based 'emulation file' Comstar can be configured to emulate virtually any terminal type including VT100, within the capabilities of the BBC.

In addition to the above, most MCG commands can be executed from within Comstar, errors are trapped by Comstar's own error handling routines and an optional elapsed time clock may be displayed. Data filter, Local Echo, Auto line feed, printer on/off and NON-DTP products may be toggled in or out by a single key press, extensive use being made of the function keys.

Finally, Comstar may be fitted into any of the sideways ROM sockets and is provided with a comprehensive manual.

C34 inc. VAT & Carriage.

A revolutionary new approach to program development aids.

Toolstar is a powerful new utility from that will open up a whole new world for BBC micro users. Toolstar adopts a revolutionary new approach to program development aids. It has been designed specifically to assist both Basic and Machine code programmers by providing an integrated set of powerful building blocks which rapidly become an indispensable complement to the built in facilities of your BBC micro.

This package contains the Toolstar firmware in Eprom and a very comprehensive manual (over 150 pages), containing many examples and illustrations to help you make the best use of Toolstar's exciting capabilities.

Toolstar sheds new light on your BBC micro

Toolstar, being Eprom based will be permanently resident in your computer allowing all of its commands to be immediately available. It is 'transparent' to both the user and the operating system, once a command has been executed, control is returned to Basic, or whichever ROM had control prior to the command.

Full error handling has been incorporated and for new users there are a full help menu describing each command and its syntax.

Powerful building blocks for Basic programmers?

Within Toolstar there are 22 commands, 8 of which operate between PAGE and TOP ie, on the current Basic program or Basic programming environment. These commands obey standard Basic command syntax rules.

Reveal the deepest secrets of your discs

Toolstar allows the operations of Formatting, Verifying, reading or writing a disc sector to be carried out very simply from Basic i.e. all the necessary building blocks required to develop a comprehensive set of disc utilities, simply and effectively.

Lost your memory? - No more armrests with Toolstar!

In addition to the commands described above there are 9 commands which operate on the whole of the BBC's memory and are designed to complement the BBC's built in assembler. These include a full feature disassembler and memory dump, each with forward and reverse scrolling.

If this is not enough Toolstar can be Extended!

There are three help menus on Toolstar which may be obtained by typing HELP TOPS, HELP MICROE or HELP EXTEND. The third option menu will initially display the following:

HELP EXTEND

EXTEND -HMM addrs:

i.e. typing 'EXTEND -address' will allow the user to extend the facilities of Toolstar with routines which are supplied by himself. The manual describes fully how this operation is carried out and illustrates it with several examples.

In the future such utilities will be made available on disc and cassette from Pace, thus allowing a comprehensive library of utility programs to be built up.

C34.00 inc. VAT & Carriage.

Access and Barclaycard Dealer Enquiries welcome

Send for more information to:

PACE

92, New Cross Street,
Bradford BD5 8BS.
Telephone: 0274 729306
Telex: 51564

429 C and Unix are almost inextricably linked, and whether the language is available on a huge mainframe or a small micro, the essential features of Unix are duplicated or simulated.

These include the library of subroutines which, though not formally part of the language, are always in any serious implementation. They provide, among other functions, a standardised means of handling the various input and output facilities of the system.

About half these subroutines are coded in C, particularly the advanced input and output formatting routines `printf()` and `scanf()` and their alternates, `fprintf()`, `sprintf()`, `fscanf()` and `sscanf()`, with the others such as the string-handling, floating-point and trigonometry functions written directly in machine-code for reasons of speed.

In fact, the only formal definition of C is a smallish book by Brian Kernighan and Dennis Ritchie, and is the final definition and sole arbiter of its use.

In this respect, the Unicorn scores highly — unlike other versions of C, which are cut-down or re-written-to-fit, this is the real thing, complete with all the bits and pieces you read about in the Unix-for-beginners-and-experts books.

Tagging along for the ride are all the bits of the compilers — preprocessor, passes 1 and 2, assemblers, linker-editor and so on, as well as the usual tools for finding, listing and changing files such as `sort`, `unique` and `grep` (Get Replicated Pattern).

Heavy-duty system-building tools like *Lex* — the LEXical program generator — *yacc* (Yet Another Compiler Compiler) and scores (literally) of others, together with *sccs* and its attendants are keeping everything in order and make sure you have or can get some idea of what program or file is where and in what state.

C is a compiled language, which means that the process of converting a program into running code is fairly time-consuming, and has none of the immediacy of Basic or other purely interpreted languages. However, a kind of interpreted C is available in the *c-shell*, which is invoked by typing `csh` at the keyboard.

Deliberately designed to look and work in much the same way as the compiled language, it's close enough to consider as a dialect with most of the expected operators, data- and control-structures. It isn't an exact duplicate, so though you get the advantage of being able to hammer in some code, type its name to make it run, and quickly see some results, you can't then compile it. The stuff needs considerable massage before being acceptable to the compiler.

If you don't like C or have some reason to use another language, that's easy too, since Fortran and RM-Cobol are also available, and if you want to use those, but prefer to use a more C-like syntax, you can have *m4* (another pre-processor) change it all around for you.

At its simplest, it can be used to give more expressive names to such symbolic

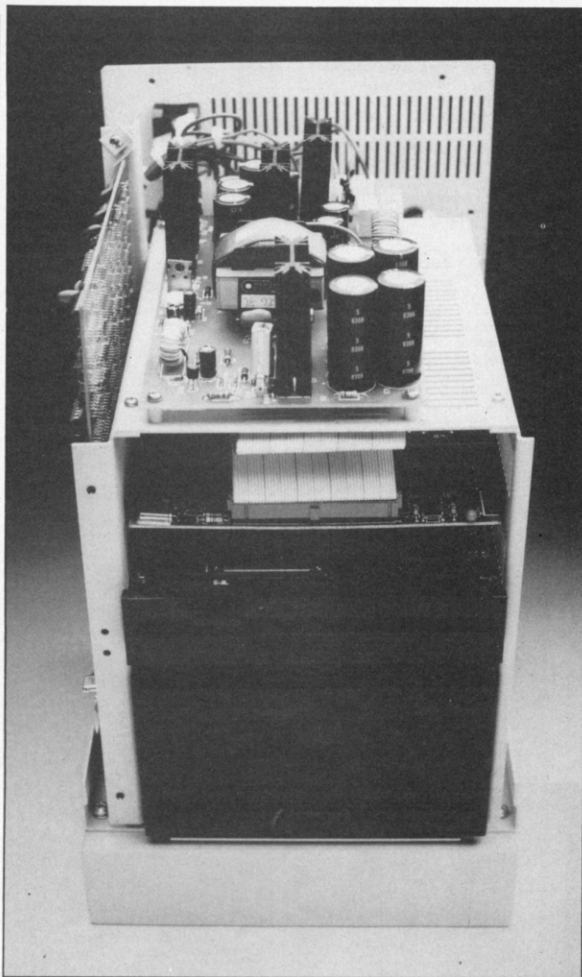

All the boards are installed on runners allowing for easy access. The floppy disk drive is on top of the hard disk drive.

constants as TRUE and FALSE, which are usually 1 and 0, as well as letting the programmer replace complex statements with purely arbitrary symbols, thus making programs more readable. Used really creatively, it can even do most of the work of converting from one language to another. So real Unix is in a different league to the normal micro OS.

MC68000

Of all the different 16-bit processors, both real and pseudo, the Motorola MC68000 appears to be the most popular, and its use

in the Unicorn will spread its familiarity.

Its popularity is partly due to a strong resemblance in electrical terms to the MC6800, an earlier Motorola cpu which is still widely used in the likes of intelligent controllers.

This makes the more capable 68000 simple to interface, and provides plenty of ready-made hardware support such as I/O boards with 6821 PIA chips, VDUs with 6845 CRTCs, clocks using the 6840 Programmable Timer and disk-controllers using the 6843 FDC, as well as others.

One other advantage of the 68000 liked

◀ 33 by computer designers is the width of the separate data- and address-busses. Each bit has its own pin, too — they aren't multiplexed as on the 8086 and 8088 or Z8000.

This means the processor can run as fast as the rest of the system will permit, and in general, that means fast.

From the programmer's point of view, however, the 68000 has many advantages over most 16-bit processors, because of the symmetry of its registers and the rich instruction set, which add up to an elegance the others generally don't share.

All of this makes it easier to implement and run a fully-featured Unix system such as the Unicorn.

A distinction is made between the address and data registers, though they are exactly the same size, and in most respects are operated upon in the same way by the same instructions. As a result, it may often be necessary to move data from an A-register to a D-register, fiddle with it as data, then move it back to the A-register again. It would have been easier if Motorola had allowed any register to be used as either data or an address.

Also, redundancies in the instruction-set result from what might be called addressing-mode cross-over. This phenomenon arises because the addressing-modes are so varied that sometimes one means exactly the same as another, despite having been arrived at by different instructions.

In general, however, the MC68000 provides a fast and acceptably efficient cpu, which is becoming more and more widely used.

In the past year it has been used in Apple's Lisa and Macintosh, Sinclair's QL, and many multi-user business machines.

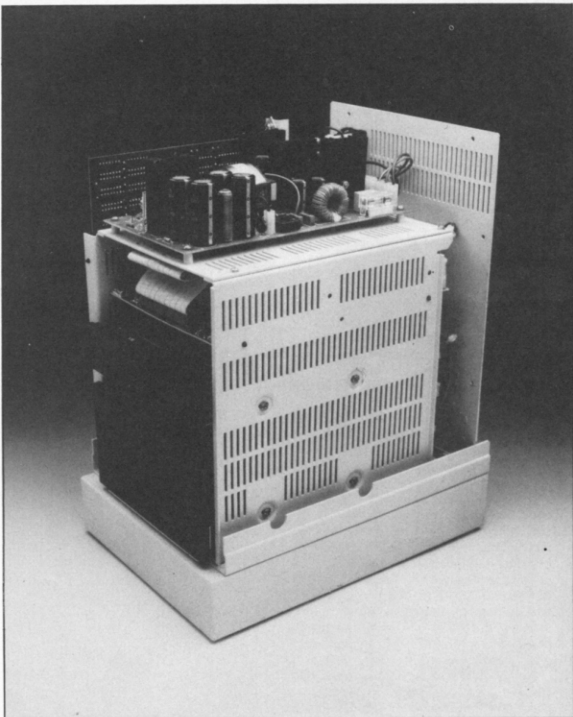

The power supply sits neatly on top of the drives.

It allows designers to provide features which would have cost tens of thousands of pounds only a couple of years ago, and looks set to become as popular in the next generation of machines as the Z80 and 6502 were in the current generation.

Verdict

If you do a lot of highly-interactive keyboard work, using a spreadsheet or writing, then the Unicorn probably isn't ideal, mostly because the response times aren't all that wonderful. It's all right as long as you don't have background processes running, but if you do, you'll find the frequent short pauses fatiguing.

However, if your work is amenable to batch-processing, then it might well prove

cost-effective. The text-editing, formatting and typesetting features of the system are ideal for this kind of work.

The main question is whether the applications software, the greatest strength of CP/M, can be transferred, translated or duplicated under Unix. If this happens, then Unix must offer the richest combination of features and facilities of any OS. As it stands, the Unicorn has to be the biggest and most impressive add-on for the BBC micro yet.

Overall, Uniplus is a complete, accurate and up-to-date implementation of this highly-capable operating system, which should provide experienced users with all the space, precision and flexibility they would expect on an 11/70.

PCN



All connections to the BBC are made via ribbon cables — 2 sockets on the back and one on the side.

SPECIFICATIONS

Price	£2,895 excl VAT
Processor	MC 68000
ROM	8K + 16K in the BBC
RAM	256K
Operating System	Unix
Software	Unix Pack — Program development pack containing C-compiler <i>etc</i> ; text processing pack Torch Computers, Abberley House, Shelford, Cambridge CB2 5EQ
Distributor	

ONLY
£3.50

For sufferers of PCNitus THE PCN BINDER

Since March 1983, a mysterious malady has afflicted thousands of people in Britain — PCNitus. The symptoms are perplexing. . . Those afflicted are found fighting their way through piles of Personal Computer



News magazines muttering strange things like 'can't find the Electron Pro-Test' and 'The Spectrum Micropaedia must be here somewhere . . .' But a recent breakthrough has brought instant relief to PCNitus sufferers.

The cure is called the *Personal Computer News binder*. It's red, yellow and silver and holds four months' copies completely flat, even when full. You'll be able to read them easily and refer to them quickly.

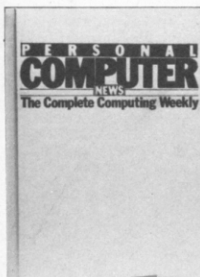

So if you recognise the symptoms above — take the cure now!
Just fill in the coupon at the bottom of the page and send it with payment (£3.50 inc postage, VAT and handling) to the address below.

BINDER ORDER CARD. Please rush me _____ PCN binder(s) at £3.50 each. I enclosed my cheque made payable to Personal Computer News. Please charge my Access/Visa/Diners/American Express card (cheque where not applicable)

Account No. Name

Address Town Postal code

..... Signed

Send to Personal Computer News, Binders Department, 53/55 Frith Street, London W1A 2HG

SOFTWARE

• WHAT'S NEW • WHAT'S NEW • WHAT'S NEW •

Note to software publishers: If you wish your company's product to be included, please send only the very latest releases to Bryan Skinner, PCN, Software Editor, 62 Oxford Street, London W1A 2HG; and please don't forget to include prices and a telephone number.

Games

For the second week running we have received more software releases for the Commodore 64 than any other machine. It is possible that this is setting the scene for software releases nearer to the Christmas period.

Creative Sparks has launched *River Rescue* on a variety of machines. The original version of *River Rescue* was on cartridge for the Atari home computer. Now owners of other machines have the opportunity to play this excellent game on their own micros. You take control of a boat in a crocodile infested river. Men on one bank have to be rescued and dropped off on the opposite bank. Watch out for the logs, islands and crocodiles: if you hit any of these you will end up as crocodile fodder.

Micro Power has converted a

number of its most popular games onto the Commodore 64, including *Felix in the Factory* — a game in which you guide Felix along conveyor belts while leaping packages, shinning up ladders and pitchforking the Gremlins that infest the factory. Also released is *Ghouls*, a *Manic Miner* type of game that has only recently been released on the BBC. All these games use one of the new fast loading routines which are becoming standard with Commodore 64 cassettes.

Cityfighter from Choice Software is a Commodore 64 conversion of their Spectrum game of the same name.

Software Farm has released its second high-resolution games program for the ZX81 called *Rocketman*. Its first high-resolution game *Forty Niner* was an instant success, and it looks as if it has another winner on its hands with *Rocketman*. The aim in this game is to collect diamonds on the left hand edge of the screen while avoiding a rampant Bulboid. You also have to collect fuel for your rocket pack: once you have enough fuel you can strap on

your rocket pack and fly around the screen.

Dragon owners can now take part in a game of American football with *Superbowl* from Cable Software. This game has fully animated sprites, quite an unusual feature for a Dragon game as there are no sprite routines built into the machine. Cable is planning to convert *Superbowl* for the Spectrum, Commodore 64 and BBC.

Galaxy's Edge for the BBC is two games in one. On the first side of the tape there is a standard text-only adventure called *The Discovery*. Side two of the tape offers something completely different. Not only do you require two players to play this game called *Escape From Solaris*, but you also need access to two BBCs and monitors. The BBCs are linked together by the RS423 ports and each player has their own computer to play the game on. Again, *Escape From Solaris* is an adventure game, but now you can cooperate or compete with the other player.

Utilities

For Spectrum owners who are

having problems keeping a record of how much they are spending, Creative Sparks has released *Money Manager*. The program keeps a record of all income and expenditure. A budgeting facility allows you to plan your finances in advance making sure that you don't get nasty letters from the bank manager.

Minix provides the Dragon owner with an easy to use text editor which can be used to generate text for Basic programs, word processing, or a database. Up to 400 lines or records can be entered on the 32K machine, this is somewhere around six pages of A4.

Quicksilver's *Electro Art* for the Acorn Electron is the rewrite of the BBC program *Beeb Art*. It is designed for use by all the budding artists who wish to draw pretty pictures on your Electrons.

Also from Quicksilver comes *Drum Kit* for the BBC. This program will turn your BBC into a fully programmable rhythm synthesiser with four drums and percussion, and on screen display of beats.

ATARI

River Rescue £8.95 Creative Sparks 0252 543333

BBC

Word Skill £12.25 Chalksoft 0905 55192
 Gatecrasher £6.95 Quicksilver 0703 20169
 Drum Kit £9.95 Quicksilver 0703 20169
 Beam Scan £40.00 Beamscan Computer Software
 01-202 8656
 Galaxy's Edge £7.45 Magic Software Ltd 0359 40940
 Crib £9.14 Micro Aid 0209 831274

COMMODORE 64

Stranded £7.95 English Software 061-835 1358
 River Rescue £7.95 Creative Sparks 0252 543333
 Cityfighter £6.95 Choice Software 09603 69129
 Traffic £7.95 Quicksilver 0703 20169
 Felix in the Factory £6.95 Micro Power 0532 458800
 Swoop £6.95 Micro Power 0532 458800
 Ghouls £6.95 Micro Power 0532 458800
 Cybertron Mission £6.95 Micro Power 0532 458800
 Graphix IV £9.99 Zipprint 0202 37000
 Star Wars £24.95 Parker Software 01-631 4547
 Gyrrus £24.95 Parker Software 01-631 4547
 Obert £24.95 Parker Software 01-631 4547

DRAGON

Minix £9.95 Microplot 0203 503038
 Editor £7.95 Microplot 0203 503038
 Folly Farm Chicken Run £7.95 Imsoft 01-675 5577
 Superbowl £6.95 Cable Software 0582 591493

ELECTRON

Note Invaders £9.25 Chalksoft 0905 55192
 Gatecrasher £6.95 Quicksilver 0703 20169
 Electro-Art £14.95 Quicksilver 0703 20169

IBM PC

Jack 2 £355.00 Hytek Software 0777 708555

ORIC/ATMOS

Velnor's Lair £6.95 Quicksilver 0703 20169
 Mined-Out £6.95 Quicksilver 0703 20169

SPECTRUM

Moder-80 £6.95 Seven Stars 01-485 7775
 River Rescue £6.95 Creative Sparks 0252 543333
 Gatecrasher £6.95 Quicksilver 0703 20169
 The Inferno £6.50 Richard Shepherd 06286 63531
 Chart £7.50 Juke-Box Software
 Money Manager £6.95 Creative Sparks 0252 543333

VIC 20

River Rescue £9.95 Creative Sparks 0252 543333

ZX81

Poolster £13.00 Naigram Software 01-434 1366
 Climber £3.95 Unicorn Micro Systems 0202
 532650
 Bears in the Wood £3.95 Unicorn Micro Systems 0202
 532650
 Rocketman £5.95 Software Farm 0272 731411

This is no game This could be your reality Is there life after guarantee?



**With a GLOBEL no quibble guarantee* the answer is
YES!**

*Our warranty covers the holder for one year, all electronic components within their computer including all labour charges and if necessary we will replace F.O.C. the whole computer. No other company can offer your computer Globel protection. All repairs are undertaken within our own workshop by fully qualified engineers.

**Don't play games! Send today for the GLOBEL no quibble guarantee
Dare you afford not???**

For the price of a first class software game you get first class hardware protection from GLOBEL: **The largest home computer maintenance company in the United Kingdom.**

	<i>Machine up to 24 months old</i>	<i>Over 24 months</i>
CBM 64	16.50 per year	20.00 per year
SPECTRUM 16K	8.00 "	14.00 "
SPECTRUM 48K	10.00 "	16.00 "
BBC B	19.50 "	25.00 "
VIC 20	8.00 "	14.00 "
ORIC	8.00 "	14.00 "
DRAGON 32K	16.50 "	20.00 "
ELECTRON	16.50 "	20.00 "
MTX 500	18.50 "	24.00 "
ATARI 600XL	16.50 "	20.00 "
SINCLAIR QL	25.00 "	

**If your machine is not stated
please enquire for price of
yearly contract at address
below.**

**Or telephone
01-571 4416**

TO GLOBEL COMPUTER CONSULTANTS

NAME COMPUTER

ADDRESS DATE PURCHASED

..... SERIAL NO.

..... (ENCLOSE RECEIPT IF POSSIBLE)

I enclose cheque/PO for £..... for a yearly maintenance agreement or alternatively enquire direct for information and copy of our warranty.

GLOBEL COMPUTER CONSULTANTS

CHARLES HOUSE, BRIDGE ROAD, SOUTHALL, MIDDX UB2 4BD. TEL: 01-571 4416

PCN PRO-TEST SOFTWARE

The fact that flight simulators are in demand for the Commodore 64 is proved by the speedy appearance in the PCN Charts of two recent products. Until recently the 64 was the most poorly served of the home micros in this area — but that has changed. With the release of Flight Simulator II from Sublogic, the 64 is now the micro if you have the urge to head for the wide blue yonder.

FSII is a relative of the highly acclaimed IBM PC simulator from Microsoft which produced its version under a deal with Sublogic. The 64 version is not only streets ahead of the PC package, I would go so far as to say it outshines every other piece of 64 software available. It is a masterpiece of the programmer's craft — author Bruce Artwick has squeezed every last bit of performance out of the 64's 8-bit processor and graphics chip.

Features

The most instantly impressive feature is the full colour, high-resolution display. A few of the best flight simulators give out-the-cockpit views; FSII gives full 360 degree vision in 3D perspective and the detail is astounding. There are skyscrapers, road networks, towns and mountains but the most staggering experience is a flight across Manhattan Island where you can fly around the Statue of Liberty, the Empire State Building, the World Trade Centre and the Manhattan suspension bridge.

These are all in 3D with hidden-line removal and if you try to fly through them

your trip will end with shocking speed.

The instrumentation is superb — no digital readouts here but lots of dials that work like real instruments matching the view out of the window. In addition to

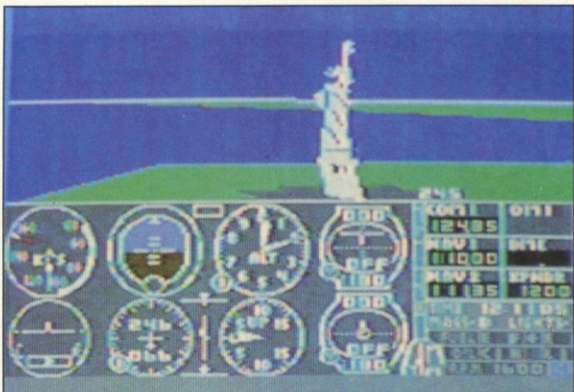

speedometer, turn and bank indicators, VSI and gyrocompass, there are two VORs (for instrument navigation) that allow you to select frequencies for different radio beacons, and a communication radio. Set the frequency for your destination airport and you get a message from air traffic control advising on weather, visibility and your take-off and landing runway.

Some airports have ILS (instrument landing systems) so you can practice flying and landing blind.

There is also a real-time clock — a necessity since time in the simulator matches reality and if you're in the air when night falls you'll have to learn instrument navigation in a hurry. It really does get

dark outside although you can see the airport lights if the weather is fine.

Weather is also handled realistically. You can choose any of the four seasons with suitable changes in weather. Fly the northern states in winter and there'll be snow on the ground, and you can set wind direction and strength at three altitudes, and two levels of cloud. Select low cloud and the sky changes from bright blue to an oppressive grey and if you enter the cloud bank you go to zero visibility. You can fly above it though.

All the features are available through an editor which covers everything mentioned so far and much more. You can select easy or reality flight mode, set your aircraft's position anywhere within the simulator's world, and even set a reliability factor to make life even more interesting: how would you cope with instrument failure at night in thick cloud?

Documentation

The documentation matches the standards set by the programming. FSII comes with a 90-page glossy booklet which covers not only the program, but provides a simple guide to small aircraft flight in general. Instrumentation, flight controls, radio equipment and navigation are all covered thoroughly, as well as use of the editor. There is also an extra sheet of late changes to the program and a handy reference card for the controls and instruments.

Finally, four maps cover the main areas

POISED FOR FLIGHT

A flight simulator for the Commodore 64 had Peter Worlock walking on air.

There has been a boom in flight simulators for the Commodore 64. The only surprise is that it took so long for them to appear. However, though FSII may be comparatively expensive it must be said that beside it, everything else is distinctly second-rate.

If it is completely out of your range, take a look at *Solo Flight* from Microprose Software. This is available on disk or cassette at about £15 and merits the 'best of the rest' accolade. It offers some of the best features of FSII, including three scenery areas in Kansas, Seattle and

Colorado, and instrument flight capabilities. Changing weather also plays a part.

The major difference is that you get no out-the-window view — you see the aircraft you're flying from above and behind (rather like the racing car in *Pole Position*). It's also a bit easy and you'll quickly master flying. A bonus is the inclusion of a race game where you have to deliver mail between towns.

You're up against the clock as well as changing weather and an unreliable aircraft.

Much cheaper at £7.95 is *Flight Path*

737 from Anirog (cassette only). Written by a flight simulator instructor and pilot says the advertising but remember this is no recommendation as to quality unless the pilot is a hot-shot programmer too.

One that might be worth keeping an eye out for is *Airliner* from Protek. Currently available for the Spectrum, a 64 version is promised soon.

All should be available at your local 64 software shop. As with all software the answer is to see them running before weighing up the features against the price.

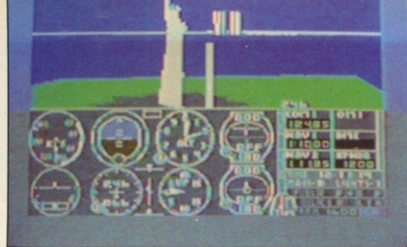

A view over Manhattan

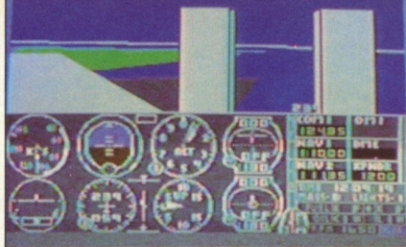

Flying dangerously close to the towers of the World Trade Centre.

in the simulator's world: Chicago, Los Angeles, New York and Seattle. They contain the necessary information about airport altitudes, runways, latitude and longitude settings for the editor, navigation and communication radio settings, plus crucial bits and pieces like whether your target airport has refueling facilities. You can't just press a reflex key.

In use

FSII takes the idea of real-time simulation to breathtaking limits and actually flying the simulator is a joy. The sound of the engine changes realistically with changing revs and the scenery is a delight.

Loading from disk takes nearly three minutes but even here there is nice attention to detail. The screen border flashes to let you know things are happening and should you get a disk error it's not a question of starting from scratch. You can choose to ignore the error, which works sometimes, or try again from the last successful disk access. Two or three retries was always enough to get over the problems. You also get to specify whether you're using monitor or TV in colour or black and white.

You then find yourself in easy mode, in user mode 0. One of the most exciting features of FSII is the opportunity to build up a mode library of different locations in different weather and time settings. User mode 0 puts you at a small airport on the shore of Lake Michigan with Chicago off to the left.

Take-offs are quite easy, regular flight a little tricky, and landings frustratingly difficult. After a while you can put it on the ground without crashing but getting it onto a runway takes hours of practice. In reality mode, landing on runways becomes crucial if you want to avoid becoming bogged

down in mud, or tearing off your undercarriage.

A smoke trail feature leaves a 3D track of your progress in the sky. You can then fly around it and see how your turns and approaches look.

You control the aircraft either from the keyboard or joystick, or a combination of the two. If there is any criticism of the package it is in the choice of keys for some of the secondary controls. I would have preferred to see the function keys used for some controls instead of the actual CTRL combinations. However, the system is workable and this is very much a minor quibble.

The aircraft in the simulator (a Piper Cherokee Archer) is not rated for aerobatics and I failed to get it to loop but you can have a lot of fun with rolls, stall turns, spins and the like. You can even fly upside down for a while but it usually ends in a fatal dive.

However, the real fun of the simulator is the scenery. You can undertake marathon cross country flights in real time which forces you to plan your course with refuelling stops, taking in some of the sights along the way. In Illinois there are large towns and rivers, skyscrapers in Chicago, and Lake Michigan; New York features the stunning Manhattan Island trip; Los Angeles has the harbours of LA and San Diego and the Santa Ana mountains; Seattle features lakes and bridges and Mount Rainier. Much of the scenery is taken from aerial photographs and Sublogic promises the release of new library disks with further areas. You may one day undertake transatlantic or round-the-world flights.

Finally, when you think you've really mastered the aircraft you can try the World War I air age game. Here you're at the controls of a 1917 biplane where you have

to bomb enemy fuel dumps and factories and shoot down six German fighters. Two of them are aces and will quickly demonstrate the difference between a good pilot and a turkey.

You need to shoot down five to be classed an ace; after hours of practice I've never done better than two before having my wings shot off.

Verdict

If there is ever going to be a better piece of software for the 64 I can't wait to see it. This is superb programming that realises the potential of the 64 to the full, in effect turning the machine into a dedicated 64K colour flight simulator.

By the standards of entertainment software it is expensive, but it's still good value for money.

At present, only Apple owners can share the delights (although a version for the 64K Ataris may be forthcoming) and it is ironic that 'boring, old' 8-bit technology has produced this kind of masterpiece.

Owners of other machines can only look on in envy and I suspect that Flight Simulator II will sell an awful lot of disk drives and quite a few Commodore 64s.

PCN

RATING (5)

Features
Usability
Documentation
Performance
Reliability
Overall value



Name Flight Simulator II System Commodore 64 and disk drive Price £42 Publisher Sublogic Corporation Format disk only Other versions Apple II Outlets retail.

South of Chicago - radar scan over the Great Kanakakee River.

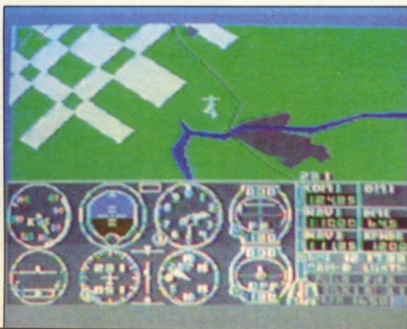

WW1, Europe 1917 - enemy air ace approaching. Note snow on mountains.

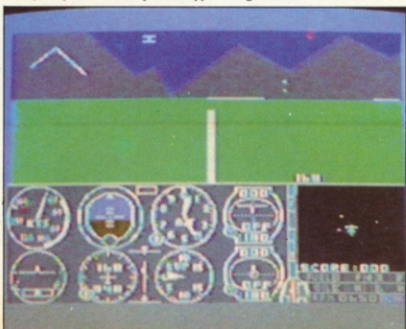

Dyneer: Daisies with perfect characters

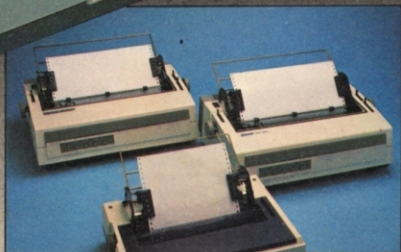
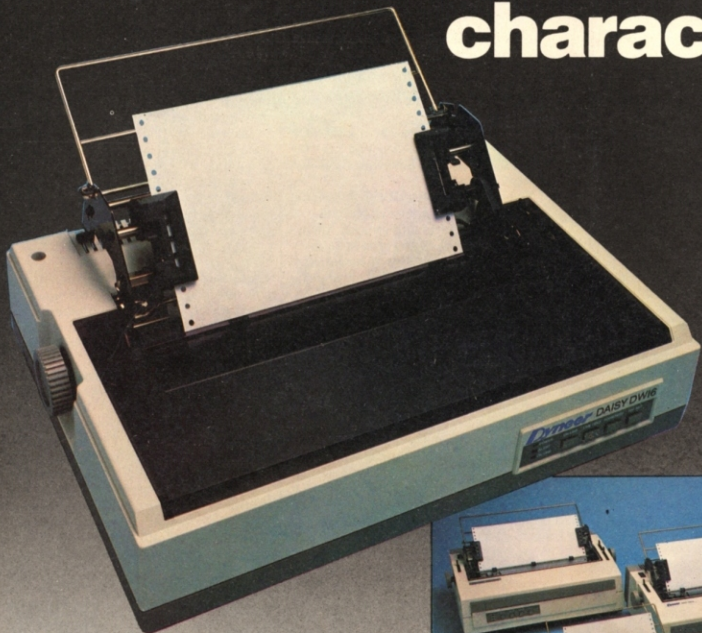

THE DYNEER DW16 – pictured above – offers Daisy-Wheel-Perfect print at a price you'll find difficult to believe.

With a print speed of 16 cps (Shannon Text at 14 cps), the DW16 features bi-directional printing up to 10 inches wide on 12 inch (max) paper, and offers a choice of tractor or friction feed systems.

If you need higher performance, the DW20 and DW36 offer maximum print speeds of 20 cps and 36 cps respectively, printing up to 13.2 inches wide on 17 inch (max) paper. Plus an

optional automatic cut-sheet feeder for users needing maximum correspondence throughput.

But whatever the print speed, every Dyneer Daisy is built to the most stringent engineering standards and is compatible with most popular word-processing packages. And all feature the Dyneer Hallmarks: Quality, Reliability and Unbeatable Price/Performance.

Ring us for details and you'll have to agree we're right. Printers of perfect characters – and at prices you'll hardly credit.



X-DATA

THE NAME BEHIND
THE PRODUCTS IN FRONT



X-DATA LIMITED, 750 DEAL AVENUE, SLOUGH TRADING ESTATE, SLOUGH, BERKS SL1 4SH. TEL: SLOUGH (0753) 72331

a **Dyneer** company

Basic necessities

Helping Basic programmers do the tricky little things that can sometimes take forever is the aim of Super Toolkit.

Nectarine claims this machine code utility will enable Spectrum users to skip through jobs like renumbering, block deletion and crunching, among others, with a single keystroke, and by and large it succeeds.

The package has a version of the program for both the 16K and 48K versions of the Spectrum and even includes a demonstration program.

When loaded, Toolkit sits above Ramtop, occupying some 2506 bytes, knocking a fair chunk of RAM from the 16K machine.

Commands in Toolkit are given by pressing ENTER, along with the required key.

Documentation

The cassette comes in a largish plastic wallet, and the instruction booklet is a slim 16-page volume.

There is a warning on page three: the program will not function with the ZX Microdrive, nor will it work with Interface 1 connected. This may be bad news for some owners. But fear not, a version of the program for use with Microdrives is in the pipeline.

The manual has no index, but the commands are listed on the back page of the manual and the on-screen prompts are quite adequate.

Features

Toolkit uses the interrupt system of the Z80, so you have to deactivate it if you want to use machine codes routines that also make use of interrupts, such as a printer driver. Turning Super Toolkit on and off is just a matter of entering the relevant RAND USR commands.

If you NEW a Basic program after invoking Toolkit, you must reactivate it with the relevant RAND USR command before progressing. To renumber, you press ENTER and R. You're then prompted for the starting line number and the increment.

While renumbering is a very useful facility, not even this one will cope with computed GOTOS or GOSUBS, such as GOSUB 100*X. Of more significance is the fact that it won't handle GOTOS to non-existent line numbers (one of Sinclair Basic's more curious features). So you have to do the rest by hand.

The manual warns you that when you renumber a program you must make sure to choose a step size which will not make the higher line number exceed 9999, the highest allowed by the Spectrum. If this does happen, you'll get some curious line numbers, though the program will still run all right. You're recommended to renumber with a smaller step.

PCN PRO-TEST SOFTWARE

Good news for Spectrum programmers brought by Kevin Bergin.

One command lists in a Basic program all the variables given in the order in which they appear in the code. This makes for easy and fast debugging as you trace the occurrence of any variable.

Super Toolkit Commands

B	Block delete
C	'Crunch' program
F	Free memory
H	Header Reader
K	Replace Keyword
L	List variables
M	Memory map
O	Trace off
P	Length of program
R	Renumber
T	Trace on
V	Memory used by variables



The block delete command erases a block of lines in the range given. This is a great time-saver; it takes a lot of hours and patience to delete a lengthy sequence of lines using Sinclair Basic.

Any keyword in a program can be replaced with another. Sounds neat, but when would you need to do it? The manual suggests that you could replace all PRINTS with LPRINTS. But apart from that, I couldn't think of a reasonable application for this facility. What would have been useful is a search and replace function to allow you to change things like variable names.

You can check the byte length of a program, and Trace displays the current line and statement numbers in square brackets at the bottom right of the screen. This is probably the most useful debugging aid, because you can also step as slowly as you wish through the program. It's a pity Nectarine couldn't have taken this a step further and let you have the values of selected variables displayed as well.

Still, it's far more useful than the TRACE built in to most micros.

Turning off TRACE requires a rather odd set of actions: you have to BREAK or STOP the program, then enter a dummy command like REM or PRINT, to make the Spectrum and Toolkit work normally again.

You can also check the number of bytes used by your program variables and there's a memory map routine. This gives the current state of many system variables and updates them as the program is altered. The Memory map function gives you this sort of information:

Microdrive maps:23734
Channel info:23798
Program address:25068
Variable address:34059
Calculator stack:34674
Machine stack:64543
Rantop:65288

Another routine allows you to read any tape header, even that of Toolkit itself. The manual points out: 'It enables you to identify programs very quickly. The information includes the program name, type, length, autostart line number or start address.'

Verdict

At just under £10, Super Toolkit may be pretty good value. However, Nectarine really should have spent more time on tidying up the screen displays and producing a better deal.

The conclusion has to be a grateful nod of approval to Nectarine, but why can't manufacturers provide such basic facilities in ROM? There's a crying need for many of the functions provided by toolkits such as this on all machines, but should we have to pay extra to get them?

PCN

RATING (5)

Features

Documentation

Performance

Usability

Reliability

Overall value



Name Super Toolkit Price £9.95 System Spectrum
16K/48K Publisher Nectarine, Foulsham & Co,
Yeovil Road, Slough, Berks SL1 4JH Tel (75)
26769 Format Cassette Other versions None
Outlets Mail order/retail

DRAGON

Cannon law

Name Laser Zone System Dragon 32 (+ joysticks) **Price** £7.95
Publisher Salamander Software, 17 Norfolk Road, Brighton, Sussex. Tel: 0273 771942 **Format** Cassette
Language Machine code **Outlet** Retail/mail order.

The warfiends of Zzyax — not apparently noted for their friendliness — are intent on taking you apart. Faced with such awesome opposition, I had little choice but to attempt valour and fight them off.

Objectives

There are 32 levels to clear before mankind is safe from the beasts. You can start as high as level 15, but you need to fight your way through to get any higher.

In play

The screen has two axes on it and your cannons travel along each. In the solo mode, the joystick moves both, but they can move independently — if you can master it. Team up and you can play as a pair.

Your cannons will fire only when they are opposite a notch on the track, a skill which needs quite a bit of practice. A training mode is available to help.

The meenies at first travel down in nice neat rows, but they soon degenerate into random order. I was relieved to find they don't fire back at you but you're kept busy trying to keep the screen clear.

When enemies reach your

cannon track, they'll change direction and start after you. Then you have two methods of killing them: firing an electro-bolt which clears a path (you're immune to that of course) or firing diagonal bursts from your cannon, from the other track.

Even with practice, your cannons can be wiped out if you're not careful. Playing as a pair makes the task easier, but there's likely to be cross words when you wipe out your comrade.

The higher skill levels had another terror in store. The aliens move quicker and little flashing pods appear. I thought this was some kind of bonus, but peppering it with enough bullets to sink any normal alien, the thing split into two and destroyed both my cannons. Back to the instructions to discover that the pods always stop opposite the cannons and you must move away fast.

The diagonal firing method is the secret to survival, especially as your electro bolts are limited to four per game.

A rather brief high-score chart is offered, and there's only room for the top player.

Verdict

Good graphics and sound combined with attractive presentation make this a first rate game. It's a pleasant change to be able to team up with someone in a shoot 'em down game.

Jim Ballard

RATING (/5)

Lasting appeal 

Playability 

Use of machine 

Value 

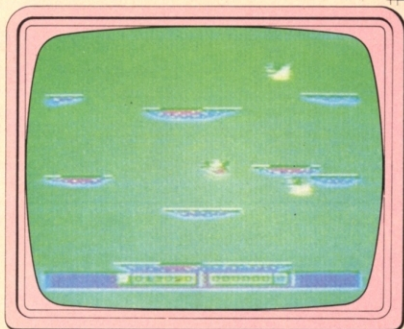

Extra for eggs

Name Buzzard Bait System Dragon + joystick(s) **Price** £9.95 **Publisher** Tom Mix Software Ltd, 41 Truro Road, St Austell, Cornwall **Format** Cassette **Language** Machine code
Other versions To follow **Outlets** Mail order/retail

Buzzard Bait is the game selected by Tom Mix and Microdale to launch their software protection device, the dongle.

The custom chip inside the dongle is encased in epoxy resin, and unless the device is plugged into the joystick port the game won't load from tape. This should cut a lot of simple tape-to-tape copying. But is the game worth the extra £1.95 the dongle puts on the price?

Objectives

It's a joust-type game in which you control the movements of a bird which flaps about the screen, lance beneath its wing, attempting to knock out other birds invading its air-space.

In play

You start with three lives, with a bonus one every 10,000 points, and there are seemingly limitless waves of attackers on slowly changing screens. The first wave is just three enemy birds, the second wave four, but then the numbers increase with alarming rapidity and some of the platforms you can rest on start to disappear while the highly nasty pterodactyls put in more appearances.

The basic technique is the same on each wave. The joystick controls only left and right

movement, with the fire button flapping you up into the air. To 'unseat' opponents you must try to get above them, as a head-on collision has you rebounding across the screen in spectacular style. The action is fast and it takes a while to master the unusual joystick control needed, but once you've done this the game really takes off.

If you unseat an opponent it lays an egg which bounces around for a time before coming to rest. You earn bonus points for touching the egg, which you must do before it hatches.

On some screens you earn extra points for finishing quickly, but a greater incentive is the pterodactyl which starts to fly about the screen after a certain time. This gets the better of you in most encounters.

Every so often there's an Egg Wave, with no buzzards baiting you but eggs slowly hatching. On later waves part of the ground is replaced by fiery furnaces into which you can be dragged.

An unusual feature is the 'P' for Pause key, which you can stab at repeatedly to advance the action a movement at a time to have a close look at the marvellous graphics.

Verdict

It's hardly surprising this is the game that's been chosen to launch the dongle device, as it's one of the best-ever pieces of Dragon software.

Mike Gerrard

RATING (/5)

Lasting appeal 

Playability 

Use of the machine 

Overall value 

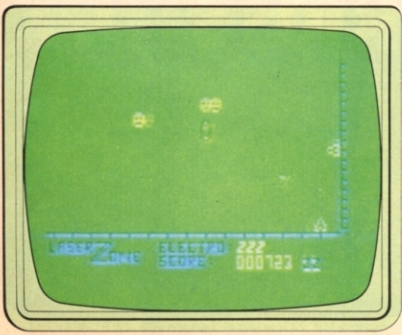

CheetahSoft



Soft we're not

FOR SPECTRUM 48K



CONQUEST

CONQUEST A tactical game which even veteran players will find both challenging and rewarding.

Mediterranean Europe is divided into grid squares. Your aim, as Emperor, is to gain 100 squares of territory as quickly as possible – at the same time dealing with Barbarian counter-attacks, plagues, civil war and rival Emperors.

5 levels of skill, plus a continuous 'Conquest' game where all the difficulty levels are thrown in together.

3D BAT ATTACK An all action, 3 dimensional maze game where you gather up blocks of gold, at the same time pitting your wits against vicious vampire bats whose only purpose in life is to locate, hunt and kill you.

4 levels of skill. At each level the game gets faster and more complicated, and the vampires more dangerous.

CheetahSoft



Soft we're not

FOR SPECTRUM 48K



3D BAT ATTACK

AFTER THESE, THE REST IS KIDS STUFF.

Are you ready for CheetahSoft?

There's only one way to find out.

But be warned: these vampire bats know a good meal when they see one. And our friend with the scythe has had years of experience...

CheetahSoft



Soft we're not

So don't play unless you're ready to play the game for real. Because you'll find there's one sure thing about CheetahSoft: Soft we're not.

£6.95 at all good stores.

48K SPECTRUM

Beat the Warlock

Name The Warlock of Firetop Mountain **System** 48K Spectrum **Price** £6.95 **Publisher** Penguin Books, Bath Road, Harmondsworth, Middlesex **Format** Cassette and paperback (cassette only £5.50) **Language** Machine code **Other versions** None **Outlets** Mailorder/retail

At first glance this appeared to be *Halls of the Things* without the Things. This version of the Crystal game is tied in with a paperback for the new Puffin Personal Computer Collection.

Objectives

Your purpose in both book and game is to get through the maze hiding the Warlock's fabulous treasure, while battling off Orcs, Spiders, Slime Moulds and other creatures. You must also collect 15 keys randomly hidden about the enormous maze, then escape again with the treasure chest they unlock.

In Play

You won't be surprised to learn that you need 19 fingers to cope with the controls. A joystick option would have been very welcome, but the keyboard must cope with facing or moving in four directions, drawing or sheathing your sword, firing your bow, opening and closing doors, pausing the game, turning music on and off, and plenty more.

Lots of work to do, but you can't get back to the instructions for reminders once you've

started playing, so perhaps they should have been printed out on the cover.

The vast maze offers simple graphics for corridors and large chambers while well-designed creatures wander around the place at random. As soon as they get a glimpse of you, they come after you.

The best defence is often to run like mad before the spiders, as getting in the right position to fire an arrow or hack with your sword can be tricky.

The base of the screen displays the extent of your wounds, and obviously you can only suffer so much before ascending (or not) to that Great Hall of Fame in the Sky.

You score 100 points for each key you collect, and different points for any monsters you kill. Or at least I've been given 100 points for each of the paltry few keys I've managed to collect so far.

Even although there's only the one fast-moving skill level, it will take a very good player to collect all the keys, the chest, and escape again.

Verdict

If you've already got *Halls of the Things* then you won't be interested in this, and although it's rather a contrived way of linking a book with a computer game at least they've both already proven their quality.

Mike Gerrard

RATING (/5)

Lasting appeal



Playability



Use of machine



Overall value

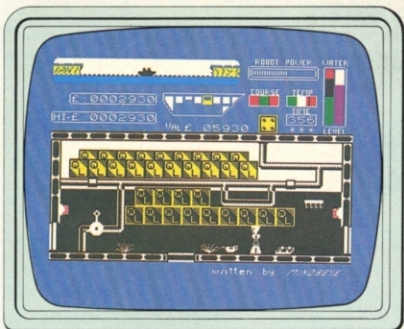

Ahoy, me hearties

Name Worse Things Happen at Sea **System** 48K Spectrum **Price** £5.95 **Publisher** Silversoft, London House, 271-273 King Street, London W69LZ 01-7484125 **Format** Cassette **Language** Machine code **Other versions** None **Outlets** Mailorder/retail

Worse Things Happen at Sea, so they say, but this oddest of computer game titles does reflect an unusual scenario.

As captain of the *SS Sinclair* (sic) your task is to deliver cargo, but the *Sinclair* is more than a bit of a leaky old tub; it's a veritable colander.

Objectives

To make port successfully, you'll need to take careful stock of just where leaks occur, then move your trusty C-Droid to effect a patch. You can also have the droid bale you out of difficulties by manning the pumps.

As the water levels in the cargo holds rise, so the value of your cargo decreases. Then the droid gets rustier and may need replacing at further expense and of course the ship will need pumping out before you can set sail again.

In play

The screen has a number of displays. A chart at top left shows how far you are between ports. Display panels indicate data like the value of the cargo; the robot's power; the temperature of the boiler; where there are leaks; and so on. The main part of the screen shows a side view of the hold the C-Droid is in at the time.

After spying the leaks map, you can send your droid off to pick up a patch to slap on a leak — they look like mini-fountains — do some pumping, or recharge its power. The patches are always just inside doors and you shouldn't leave hatches open or water, being what it is, will find its own level and scupper your chances of a safe, let alone profitable, journey.

You also have to position the droid just right, or the patch doesn't make an effective seal. If you take too long about it, your robot will run out of steam, dump the patch and zoom back to the main control room.

For the upper decks a power transporter lets you jump between compartments quickly; on lower decks you just have to slog it out, and if you're wading through water the robot power drain is frightening.

It's not all plain sailing; as you progress up the ladder of seamanship you'll have to make sure the droid maintains the ship's course and keeps the boiler temperature down to a safe level.

Verdict

Silversoft has come up with an unusual and difficult game, reminiscent of Beyond's *Psytron*. The better you get the more things you have to keep an eye on.

It's not as complex as *Psytron*, but like seaweed, it can grow on you. I'm still trying for level four...

Bryan Skinner

RATING (/5)

Playability



Lasting appeal



Use of machine



Overall value



THIS IS THE BIG ONE!

The 2nd Official Acorn User Exhibition

OLYMPIA AUGUST 1984

Thursday 16th – 10am to 7pm
Friday 17th – 10am to 6pm
Saturday 18th – 10am to 6pm
Sunday 19th – 10am to 5pm

* Please note 10am to 2pm on Thursday 16th
is Trade Morning – By invitation only.

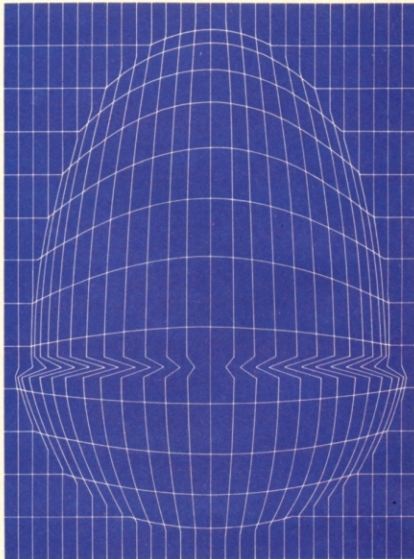

BIG VALUE

The success story of Acorn Computers, the BBC Micro and Electron is mirrored by suppliers who have produced more and more hardware, software, supplies and services. And they'll all be at the exhibition – disk drives, plotters, printers, monitors, joysticks, robots, books and magazines, all kinds of software – everything for the Acorn owner.

And of course Acorn will be there in force with all their latest developments and software.

There'll be special offers, competitions, advice centres and special events as well.

And all this for only £3.00 at the door, under sixteens £2.00. (Use the coupon to beat the queues and save £1.00).

BIG VENUE

Olympia 2 is the brand new exhibition centre next to the old Olympia. It's got everything, wide gangways, lots of space to sit down and rest, plenty of catering areas.

Getting there is easy too, it's got its own tube station, bus routes 9, 27, 28, 33, 49, 73 and 91 go right past the door, and there's car parking too!

BIG SUPPORT

Remember this is the *Official Acorn User Show*, it's the most informative prestigious and influential user show in the country. Whether you're a businessman, serious user or games enthusiast there's something for you.

For details of exhibition stands and advance ticket sales contact the organisers.

Computer Marketplace (Exhibitions) Ltd. A Rushworth Dales Group Company, 20 Orange Street, London, WC2H 7ED Tel: 01-930 1612

BEAT THE QUEUES! SAVE MONEY! ORDER YOUR TICKET IN ADVANCE.

Buy your ticket now and save queuing. There will be special entrances for advance ticket holders.

Please send me _____ (qty) tickets at £2.00 and _____ (qty) under sixteen tickets at £1.00. I enclose my cheque/PO
to the value of £_____ or debit my Access card. No. _____

NAME _____ SIGNED _____

ADDRESS _____

POSTCODE _____

GROUPS – Order 15 or more tickets and you qualify for a further 20% discount.

To: Computer Marketplace (Exhibitions) Ltd. A Rushworth Dales Company, 20 Orange Street, London WC2H 7ED.

Hunchy by Stephen and Philip Galea and Peter Assopardi of Hornchurch, Essex, is an excellent recreation of the arcade game *Hunchback*. It uses fast multicolour graphics and full sound effects. It also runs on the Electron if all mode 7s are changed to mode 6—the Electron not having mode 7 would lock-on and fail to produce all the teletext mode characters.

You play the role of Hunch whose princess, Esmerelda, has been incarcerated in the castle cell. To save her you must run along the castle wall avoiding all manner of obstacles.

You have to clear eight screens which involves jumping over ramparts, avoiding rocks, lightning fast arrows and bouncing balls, and jumping on a raft to cross a pool.

You control Hunch with the z and x keys which move him right and left while the shift key jumps him over oncoming rocks and bouncing balls and onto his raft, although you must be careful not to jump too soon as Hunch seems to fall off the wall as easily as Humpty Dumpty.

Hunchy is listed in two parts, *Hunchy* and *Hunchy 1* where *Hunchy* is the loader program which defines characters and envelopes, prints instructions and chains *Hunchy 1*, the main program. The program can be saved by first typing in listing 1 and saving as *Hunchy* and then saving the main listing as *Hunchy 1*. Chaining *Hunchy* runs the first program and then automatically searches for *Hunchy 1*.

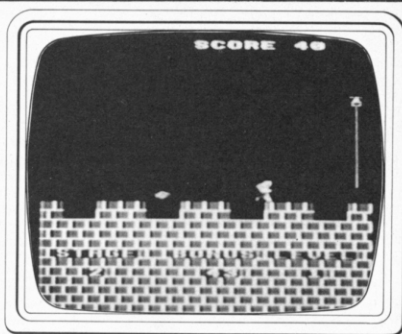

Title: Hunchy
Machine: BBC B
Language: BBC Basic

Application: Game
Authors: Stephen Galea, Philip Galea, Peter Assopardi

HUNCHY

Listing 1 — (loader program)	380	Reserves space for machine code	490-520	Prints second page of control instructions
80-370	390-400 410-480	Defines envelopes Prints first page of instructions	530-540	Sets up text window and chains <i>Hunchy 1</i> , the main program

>LIST

```

10 REM*****
20 REM*** P. AZZOPARDI *****
30 REM*** P. GALEA *****
40 REM*** S. GALEA *****
50 REM*****
55 REM*** P.P.S SOFTWARE *****
60 REM*****
65 REM*** LISTING NO.1 *****
70 REM**TYPE IN FIRST THEN SAVE**
75 REM*****
80VDU23,224,14,26,114,240,240,124,124
,62
90VDU23,225,14,30,28,14,12,0,24,15
100VDU23,226,60,24,24,56,112,224,224,1
35
110VDU23,227,60,0,4,12,142,134,135
120VDU23,228,0,24,24,24,24,24,24,0
130VDU23,229,60,0,0,0,0,0,28
140VDU23,230,112,88,78,15,15,62,62,124
150VDU23,231,112,120,56,112,48,0,24,24
0
160VDU23,232,60,24,24,28,14,7,7,225
170VDU23,233,60,0,32,32,48,113,97,225
180VDU23,234,60,0,0,0,0,0,56
190VDU23,236,0,0,0,0,60,0,0,0
200VDU23,237,0,0,0,65,194,65,0,0
210VDU23,238,0,56,110,250,252,56,0,0
220VDU23,240,24,60,90,94,94,82,60,24
230VDU23,241,16,16,56,56,124,84,84,108
240VDU23,242,254,0,0,0,0,16,16,16
250VDU23,243,49,123,255,0,255,123,49,0
260VDU23,244,0,0,0,255,0,0,0,0
270VDU23,245,140,222,255,0,255,222,140
0
280VDU23,246,0,0,0,0,255,136,136,255
290VDU23,247,6,15,9,15,15,15,9,247
300VDU23,248,0,254,254,254,254,254,254
,254
310VDU23,249,0,247,247,247,247,247,247
,247
320VDU23,250,62,6,18,98,10,18,3,3
330VDU23,251,0,24,28,28,28,28,12,12
340VDU23,252,12,44,12,124,124,0,0,60

```

```

350VDU23,253,0,62,62,62,62,62,62,0
360VDU23,254,62,62,62,127,62,0,12,0
370VDU23,255,0,62,62,127,127,127,0,28
380 DIMZ$0
390 ENVELOPE1,1,0,0,0,0,0,0,-1,-4,-6
,126,100
400 ENVELOPE2,1,100,10,100,1,10,1,-1,-
3,-1,-126,126,126
410MODE7
420 VDU23:B20;0;0;0;
430PRINTTAB(12,2);CHR#145;CHR#157;CHR#
141;CHR#131;"HUNCHY ";CHR#156;TAB(12,3
);CHR#145;CHR#157;CHR#141;CHR#134;"HUNCH
Y ";CHR#156
440 PRINTTAB(0,5);"In HUNCHY you are t
he brave and courageous HUNCH w
ho is trying to save his fair princess f
rom living in a cell.You must, to save h
er,jump over hurling boulders,lightening
fast arrows and bouncing balls."
450PRINTTAB(0,11);"You must clear eigh
t screens before ringing the bell and mo
ving closer to saving your lady.If you s
ucceed then the next screen will increa
se in difficulty."
460 PRINTTAB(12,18);CHR#135;CHR#141;"GO
OOD LUCK";TAB(12,19);CHR#134;CHR#141;"GO
OD LUCK"
470 PRINTTAB(7,22);"PRESS SPACE FOR CO
NTROLS"
480 REPEAT UNTIL INKEY=99
490 CLS
500 PRINTTAB(12,2);CHR#131;CHR#141;"CO
NTROLS";TAB(12,3);CHR#141;CHR#133;"CONTR
OLS"
510 PRINTTAB(5,10);CHR#129;"Z - To mov
e HUNCH left";TAB(5,12);CHR#131;"X - To
move HUNCH right"
520 PRINTTAB(5,10);CHR#129;"Z - To mov
e HUNCH left";TAB(5,12);CHR#131;"X - To
move HUNCH right";TAB(5,14);CHR#132;"SHI
FT - To make HUNCH jump"
530 VDU28,10,22,30,19
540 CHAIN"HUNCHY1"

```

HUNCHY

240	Repeats unless lost a life or cleared a screen		
250	If variable V is set to one then a life has been lost: calls proclife and goes to line 150	650-730	
260	If variable V is set to two, a screen has been cleared: calls proccarrive and goes to line 140	740-790	
270	No lives left: calls PROCDEAD	800-820	
280-320	DEFPROCLIFE: plays tune and checks if you have any lives left. If you have then subtract one; if not then calls PROCDEAD	830-880	
330-370	DEFPROCARRIVE: checks if you have reached phase eight.	890-940	
380	Goto line 140	950-980	
390-480	DEFPROCJUMP: reads data to make Hunch jump then calls PROCgame	990-1020	
490-500	Data for jump	1030-1060	
510-570	Procedure to move Hunch right and checks if he is dead or has reached	1070-1110	
			the end of the screen. Plays tune Procedure to move Hunch left Routine to print Hunch being lifted up, calls PROCgame Defines current phase, checks if you have fallen off the wall and decrease bonus Rock movement for phase 1 and 2 Produces moving raft and checks to see that you are on it. Calls PROCROCKs for phase three Bouncing ball routine Arrow routine, checks whether you have been hit Routine for moving rocks and arrows, checking for collision High or low flying rock Moves rocks and checks and prints their current position

XLIST

```

10 REM*****
20 REM*** P. AZZOPARDI *****
30 REM*** P. GALEA *****
40 REM*** S. GALEA *****
50 REM*****
55 REM*** P.P.S SOFTWARE *****
60 REM*****
65 REM***TYPE IN LISTING NO.2****
70 REM*** SAVE AS HUNCHY1 *****
75 REM*****
80*FX12,2
90*FX15
100MODE2:VDU23:8202:0:0:0:0:COLOUR5:PRINTTAB(5,10):"H U N C H Y":COLOUR15:PRINTTAB(3,20):"PRESS SPACE-BAR TO START":REPEATUNTIL INKEY=99:PROCTUNE1
110PROCINIT
120PROCDCODE
130PHASE=1:LEVEL=1:LIVE#=#A#*CHR#11+A#:SC=0
140PROCBRICKS
150PROCSCREEN
160REPEAT
170IF INKEY=67PROCROIGHT:GOTO190
180IF INKEY=98PROCLEFT:GOTO200
190IF INKEY=67AND INKEY=1RESTORE490:PROCJUMP:GOTO230
200IF INKEY=98AND INKEY=1RESTORE500:PROCJUMP:GOTO230
210IF INKEY=1PROCJUMPUP:GOTO230
220FOR L=1 TO 100/LEVEL:NEXT
230PROCGAME
240UNTIL V<>0
250IF V=1PROCCLIFE:GOTO150
260PROCARRIVE:GOTO140
270PROCDEAD
280DEFPROCLIFE
290 FOR X%=200 TO 100STEP-5 :SOUND1,1,X%,1:NEXT
300IF LENLIVE#=#10RLENLIVE#=#2 PROCDEAD:F
ORT=1 TO 10000:NEXT:RUN
310LIVE#=#LEFT#(LIVE#,LENLIVE#-20):V=0
320ENDPROC
330DEFPROCARRIVE
340IF PHASE=#PROCSEMERELDA:PHASE=1:LEVELO=LEVEL+1 ELSE PHASE=PHASE+1
350SC=INTBON+SC
360 SOUND&201,1,200,20:SOUND&202,1,250,20:SOUND&203,1,150,20
370ENDPROC
380GOTO140
390DEFPROCJUMP
400 SOUND1,2,10,20
410FORB=1 TO 6:READC,D
420IF X%=1120V=2
430IF V=1ORV=2B=#6:GOTO470

```

```

440MOVEVX%,Y#:PRINT#:#X%=X#+C:Y%=Y#+D:IFX%<=32X%=32
450MOVEVX%,Y#:PRINT#:#
460PROCGAME
470NEXT
480ENDPROC
490DATA16,32,32,16,32,32,32,-32,32,-16,16,-32
500DATA-16,32,-32,16,-32,32,-32,-32,-32,-16,-16,-32
510DEFPROCROIGHT
520IF X%>=1120V=2:ENDPROC
530SOUND0,1,1,1
540MOVEVX%,Y#:PRINT#:#X%=X#+32
550S#=#-S#:IFS#=#1Z#=#ELSEZ#=#B#
560MOVEVX%,Y#:PRINT#:#
570ENDPROC
580DEFPROCLEFT
590IF X%<=32ENDPROC
600SOUND0,1,1,1
610MOVEVX%,Y#:PRINT#:#X%=X%-32
620S#=#-S#:IFS#=#1Z#=#ELSEZ#=#B#
630MOVEVX%,Y#:PRINT#:#
640ENDPROC
650DEFPROCJUMPUP
660SOUND1,2,55,15
670FORB=32 TO -32STEP-8
680IF V=1B=-32:GOTO720
690MOVEVX%,Y#:PRINT#:#
700Y#=#Y#+B:MOVEVX%,Y#:PRINT#:#
710PROCGAME
720NEXT
730ENDPROC
740DEFPROCGAME
750ON PHASE GOSUB800,800,830,890,890,950,950,990
760IF POINT(X#+16,436)=0ANDY#=#S12V=#1
770BON=#BON-(0.2*LEVEL):VDU4:COLOUR6:PRINTTAB(10,25):INTBON:VDU5:IFBON<=0VDU4:P
RINTTAB(11,25):":":VDU5
780IF INTBON=#V=1
790ENDPROC
800IFR#=#GOTO1030
810PROCROCK
820RETURN
830IFR#=#1152MOVEVX%,RY#:PRINT#:#RX%=#0:MOVEVX%,RY#:PRINT#:#SOUND0,1,4,5
840PROCROCK
850IF POINT(X#,436)=2ANDY#=#S12MOVEVX%,Y#:PRINT#:#X%=X#+LS:MOVEVX%,Y#:PRINT#:#
860MOVEVX%,448:PRINTI#:#L#=#L#X#+LS:MOVEVX%,448:PRINTI#:#
870IFL#=#256ORL#=#896L#=#-LS#
880RETURN
890IFB#=#576ORB#=#480B#=#-B#S#
900IFB#=#0ORB#=#1152B#=#-B#S#

```

HUNCHY

1120-1160	Moves arrows and checks and prints current position	1340-1370	phase one Rock movement and fortress walls for phase two		
1170-1220	Sets up windows and colours and calls machine code for wall. Prints stage, level and bonus	1380-1410	Defines rock variables, prints pool and moving logs		
1230-1310	Initialises all variables, moves Hunch, produces bell or Esmerelda and appropriate wall depending on phase	1420-1450	Same routine as phase two but prints bouncing ball	1490-1520	phase six Same as phase two and six but prints bell for phase seven
1320-1330	Rock movement for	1460	Prints ball and goes to 1420	1530-1580	Prints tower and Esmerelda for phase eight
	1470-1480	Defines movement for arrows and rocks in			

```

910MOVEBX%,BY%,PRINT#:BX%=BX%+BX%:BY
X%=BY%+BY%
920IFPOINT (BX%+32,BY%-12)<>0DRPOINT (BX
%,BY%-12)<>0V=1
930MOVEBX%,BY%,PRINT#
940RETURN
950IFAX%=0MVEAX%,AY%:PRINT#:AX%=1152
:MOVEAX%,AY%:PRINT#
960IFRX%=1152MVERX%,RY%:PRINT#:RX%=0
:GOSUB1040
970PROCARROW:PROCROCK
980RETURN
990IFAX%=0MVEAX%,AY%:PRINT#:AX%=115
2:MOVEAX%,AY%:PRINT#
1000IFRX%=1152MVERX%,RY%:PRINT#:RX%=
0:GOSUB1040
1010PROCARROW:PROCROCK
1020RETURN
1030MVERX%,RY%:PRINT#:RX%=1216
1040IFRND(2)=1RYX%=54ELSERYX%=420
1050MVERX%,RY%:PRINT#:SOUND0,1,4,5,
1060RETURN
1070DEFFPROCROCK
1080MVERX%,RY%:PRINT#
1090RX%=RY%+RSX%:IFPOINT (RX%,RY%-12)=0
:POINT (RX%+32,RY%-12)<>0V=1
1100MVERX%,RY%:PRINT#
1110ENDPROC
1120DEFFPROCARROW
1130MOVEAX%,AY%:PRINT#
1140AX%=AX%+ASX%:IFPOINT (AX%,AY%-12)<>0
:POINT (AX%+32,AY%-12)<>0V=1
1150MOVEAX%,AY%:PRINT#
1160ENDPROC
1170DEFFPROCBRICKS:VDU5,19,131,129:0:BC
DL6,1:SCOL0,131
1180VDU24,0:0:1279:448:CLR:VDU26:GCDD0
:128
1190MOVE0,448:CALL START:MOVE0,448-32:
CALL BEGIN
1200VDU9,131,131:0
1210VDU4:COLOURS:PRINTTAB(1,23):"STAGE"
:1TAB(14,23):"LEVEL":TAB(8,23):"BONUS":CO
LOURS:PRINTTAB(3,25):PHASE:TAB(16,25):LE
VEL:1TAB(10,25):1:VDU5
1220ENDPROC
1230DEFFPROCSCREEN
1240LX%=896:AY%=1152:AY%=544:RX%=1152:R
Y%=544:Z%=A%:S%=1:LSX%=64:XS%=32:Y%=512:V
=0:ASX%=-64:Y%=F%:RSX%=-64:BN0=50
1250VDU9,135,135:0
1260VDU24,0:448:1279:023:CLR:VDU26:MD
VEAX%,Y%:PRINT#
1270MOVE1216,768:GCOL3,6:DRAW1216,500:1
F PHASE=B MOVE1192,800:PRINT# ELSE MOVE
1192,800:PRINT#
128000 PHASE GOSUB1320,1340,1380,1460,1
420,1470,1490,1530
1290MOVE32,1000:PRINTLIVE:MOVE576,1000
:GCOL0,1:PRINT"SCORE":*SC:GCOL0,7:MOVE58
6,1000-2:PRINT"SCORE":*SC
1300SOUND0,1,4,5
1310ENDPROC
1320MVERX%,RY%:PRINT#
1330RETURN
1340MVERX%,RY%:PRINT#
1350 BX%=1279
1360FORB=100TO BX:STEP320:MOVEB,448:VDU9
,9,127,127,10,9,9,127,127:NEXT
1370RETURN
1380RY%=544:RX%=0:RSX%=96:MVERX%,RY%:PR
INT#
1390MOVE1088,448:FORB=1014:VDU127:NEXT

```

```

1400MVELX%,448:PRINT#
1410RETURN
1420 BX%=1279
1430GOSUB1360
1440BY%=512:BX%=1088:BY%=-32:BX%=-64:
MOVEBX%,BY%:PRINT#:AY%=576
1450RETURN
1460GOSUB1440:RETURN
1470AY%=512:AX%=1152:MOVEAX%,AY%:PRINT#
#:RY%=540:RX%=0:MVERX%,RY%:PRINT#:RSX%=
64:ASX%=-32
1480RETURN
1490 BX%=1279
1500REMMOVE1216,768:GCOL3,6:DRAW1216,6
40:MOVE1192,800:PRINT#
1510GOSUB1470:GOSUB1360:ASX%=-48
1520RETURN
1530 BX%=1000
1540 MOVE 1118,780:DRAW1279,780:MOVE111
8,900:DRAW1279,900:MOVE1128,920:PRINT#
1550 GCOL0,6:MOVE 1118,600:DRAW1118,900
:MOVE1279,448:DRAW1279,900
1560 MOVE 1068,448:DRAW1068,500:DRAW111
8,600
1570GOSUB1470:GOSUB1360:ASX%=-48
1580RETURN
1590DEFFPROCINIT
1600DATA18,3,2,224,8,18,3,5,225,8,10,18
,3,4,226,8,18,3,6,227
1610DATA18,3,2,224,8,18,3,5,225,8,10,18
,3,4,228,8,18,3,2,229
1620DATA18,3,2,230,8,18,3,5,231,8,10,18
,3,4,232,8,18,3,6,233
1630DATA18,3,2,230,8,18,3,5,231,8,10,18
,3,4,228,8,18,3,2,234
1640DATA18,0,1,235,8,18,0,3,236
1650DATA18,3,1,237,8,18,3,3,236
1660DATA18,3,6,238
1670DATA18,3,3,241,8,18,3,5,242
1680DATA18,3,3,243,245,8,8,18,3,2,244,2
44
1690DATA18,3,4,250,8,18,3,3,251,8,10,18
,3,1,252,8,18,3,2,253,8,10,18,3,2,254,8
,18,3,4,255
1700RESTORE1600
1710FORA=1TO20:READB:A%=A%+CHR#B:NEXT
1720FORA=1TO20:READB:B%=B%+CHR#B:NEXT
1730FORA=1TO20:READB:C%=C%+CHR#B:NEXT
1740FORA=1TO20:READB:D%=D%+CHR#B:NEXT
1750FORA=1TO9:READB:E%=E%+CHR#B:NEXT
1760FORA=1TO9:READB:F%=F%+CHR#B:NEXT
1770FORA=1TO4:READB:G%=G%+CHR#B:NEXT
1780FORA=1TO9:READB:H%=H%+CHR#B:NEXT
1790FORA=1TO12:READB:I%=I%+CHR#B:NEXT
1800 FOR A=1 TO 31:READB:K%=K%+CHR#B:NE
XT
1810I%=CHR#18+CHR#3+CHR#4+CHR#240
1820 DIMZ50
1830 ENVELOPE1,0,0,0,0,0,0,0,-1,-4,-6
-126,100
1840 ENVELOPE2,1,100,10,100,1,10,1,-1,-
3,-1,-126,126,126
1850ENDPROC
1860DEFFPROCPCODE
1870OSWRCH=#FFFE
1880DSNEML=#FFFE7
1890P%=Z%
1900
1910 .START
1920DF7
1930LDY#2
1940.R0W

```

HUNCHY

1590-1850	Defines colour graphics, sets up envelopes	2260-2300	tune
1860-2180	Machine code for printing brick wall	2310-2350	Plays tune 1
2190-2250	Raises Hunch and plays	2360-2460	Plays tune 2 Prints game over and defines and plays tune 3
1950LDAE248		2280FORN=1T032:READA,B:SOUND1,1,A,B:SDU	
1960LDXE20		ND2,1,A-4B,B:NEXT	
1970.BUILD		2290DATA121,3,113,3,105,5,121,3,113,3,1	
1980JSR OSMRCH		05,5,121,3,113,3,105,5,105,5,125,3,1	
1990DEX		,121,3,113,5,125,3,121,3,113,5,125,3,121	
2000BNE BUILD		,3,113,5,113,5,113,5,133,3,133,3,133,5,1	
2010JSR OSNEWL		21,3,121,3,121,5,105,3,121,3,105,3,85,10	
2020DEY		2300ENDPROC	
2030BNE ROW		2310 DEFPROCTUNE2	
2040RTS		2320RESTORE2340	
2050.BEGIN		2330 FORN=1T08:READA,B:B=B+1:SOUND1,1,A	
2060LDYE7		+4B,B:SOUND2,1,A+4B,B:SOUND3,1,A-4B,B:NE	
2070.R0		XT	
2080LDAE249:LDXE20		2340DATA113,5,97,5,105,5,77,10,77,5,105	
2090.MAKE		,5,113,5,97,10	
2100JSR OSMRCH		2350ENDPROC	
2110DEX		2360 DEFPROCTUNE3	
2120BNE MAKE		2370 PROCTUNE3	
2130 JSR OSNEWL		2380 VDU4:RESTORE2390:COLOUR1:FOR t=2T0	
2140DEY		18 STEP2:READ V#:PRINTTAB(t,12):V#:FOR R	
2150BNE RO		=1 TO 400:NEXT	
2160RTS		2390 DATA"6","A","M","E"," ","0","V","E	
2170J		","5"	
2180 ENDPROC		2400 ENDPROC	
2190 DEFPROCTUNE2		2410 DEFPROCTUNE3	
2200 MOVEXZ+64,YZ-32:VDU127		2420 RESTORE2450	
2210 MOVEXZ+64,YZ:VDU127		2430*FX15	
2220 VDU5:FOR X=544+64T0 848		2440FOR E=1T013:READA,B:SOUND2,1,A,B:SD	
2230 MOVE 1120,X:PRINTA#:VDU10,B:NEXT		UND3,1,A-4B,B:NEXT	
2240 PROCTUNE2		2450 DATAB9,8,149,8,149,8,145,8,137,8,1	
2250 ENDPROC		17,8,121,13,117,4,109,8,101,8,97,8,97,13	
2260 DEFPROCTUNE1		,89,8	
2270 RESTORE 2290		2460 ENDPROC	

If an advertisement
is wrong we're here
to put it right.

If you see an advertisement in the press, in print,
on posters or in the cinema which you find
unacceptable, write to us at the address below.

The Advertising Standards Authority. ✓

ASA Ltd, Dept 3 Brook House, Torrington Place, London WC1E 7HN

BBC V, 1.20s + cassette recorder, worldwide ROM, lots of software including language and all Acornform games, £399. Tel: 0705 92006 (near Portsmouth).

Original BBC Micro software for sale: Acornsoft, Superior Software, Program Power, etc. May consider swapping. Tel: Lodge Hill 49249, ask for Victor, after 7 pm.

90 Lynx, with manuals, leads, demo programs, Lynx User newsletters, Lynx computing book, and programs from various magazines, £175. Tel: Sheffield 42414, evenings.

Master Miner, Infinite number of lives for Wily (Spectrum only). For instructions send £1 + s/c to G. Pracy, 46 Vincent Road, Norwich, Norfolk, NR1 4HH.

Wanted Atari discdrive, either model. Also for sale, Atari Trak-Ball, brand new, £25. Data Recorder, £25 also one software. Tel: 0909 475142.

Atari UCS with 2 joysticks, 14 games, including Donkey Kong and Pitfall. Only £140. Tel: Weybridge 41235, evenings.

Atari 640K and 1010 program recorder plus cartridge and cassettes to value of £260. Want £180. Tel: Mark on 0450 76856, after 4.15 pm.

Commodore 64 software to sell or swap. Titles include Zaxxon, Flight Simulator II, Colossus, Chess and many others. Contact A. Gerard PO Box 116, Liege X, Belgium.

Oric-1, 48K plus Hunchback, Harrier, Orion, Forth and others, plus subscription to 'Oric Owner', plus books, £118. Tel: Southend 0702 612283.

128K, 16K, Fuller keyboard, soundbox, joystick, interface, graphic ROM/UDG, repeat key, £30-worth of games, books, and maps, £100. Tel: Richard, 01-679 4254, evenings/weekends.

Commodore 64, typewriter style keyboard, 14 software cassettes (including Mugsy, Zaxxon), machine code, worth over £260, will sell for £195. Tel: 705129 (Penarth).

Magazines, Your Computer, 28 issues from 1981 to 1984, £5.50. Personal Computer World, April 1978 to date, buyer closes after 1987. Tel: 0252 878965.

Dragon 32 software for sale, cheap. Large selection of games, utilities, etc. Original tapes, complete with documentation. Owner moving up to OS9. Tel: 0252 878965 evenings.

Spectrum software for sale. Valued at over £100. Titles include Hobbit, Arcadia, Velnor, Circus, Apocalypse. All originals in perfect condition, £60. Tel: 0554-820717.

Commodore 64, and Supersaver Datasheet recorder, Arcadia, Panic, Cost £260. Sell £195. Boxed as new with instruction. Tel: 0851 4475, after 4.30 pm.

Bargain! Oric-1 48K hardly used, excellent condition, leads and manual, Xenon 1 and Oric Trak games. Worth £186.50, will sell for £85. Tel: B.Mth (0202) 765394.

32 Interface 2, 5 months old, hardly used, £10 one. Tel: Jonathan Edwards, 051-648 1694, after 6 pm, not Sundays.

Oric-1, complete with leads, manuals, over £150-worth of software including Zorgon and Fantasy. Good condition, £150. Tel: Needham Market (0449) 721176.

BBC-B, disk interface. Almost new — want new music centre for relaxation, £390 one. Tel: Hatfield 74319.

Atari 400 48K, Disc drive, Program Recorder, Basic, joysticks, over £300-worth of software. Only £350. Tel: 0922-408056.

Z8181, 16K, keyboard, many books, 10 games incl. Monster Maze, 32 Grand Prix, £50, quick sale. Tel: 082572 2315. P. W. slide keyboard.

Micro ROM Assembler for CBM64. Very fast and comprehensive, excellent reviews, £30 one. (£57.50 new.) Tel: 0922-408056.

VC 20, tape recorder, word processor, data file, Basic 1, Basic 2 cover, joystick, money manager, Saigon chess, seven books, 16K RAM, 20 games, 50 tapes, maps, listings, all £225 one. Tel: 092-857253.

48K Spectrum, two adaptors, books, Farganise's joystick, utilities and 120 games. Will swap for CBM64 + extras. Sell to highest bidder. Tel: 0703-505004, evenings, Paul.

Bargain! Beech disk drive! 400K, 514", including Kenda DMPS kit. Complete with manual, new, unused. Half-price, just £200! Tel: 01-788 8749.

Bargain! Beech disk drive! 400K, 514", including Kenda DMPS kit. Complete with manual, new, unused. Half-price, just £200! Tel: 01-788 8749.

Oric-1, 48K + £30-worth of games, including Zorgon's Revenge, 3 books, good condition with box and leads, £120 the lot. Tel: Fleet (02514) 7730.

Oric-1, 48K + £30-worth of games, including Zorgon's Revenge, 3 books, good condition with box and leads, £120 the lot. Tel: Fleet (02514) 7730.

HP-41C, programmable scientific calculator, with financial pack and two extra memory packs, £50. Tel: Saffron Walden (0799) 2424, evenings.

Sharp MZ80, immaculate, manual and demonstration tapes, £300 one. Tel: 01-546 4800, evenings.

T1 99/44 peripherals wanted for expansion box. In exchange for Fleischmann 'N' gauge railway equipment. Majority new and unused, value £1,400. Tel: 0202 433704 anytime.

Commodore 64 and C2N cassette plus books. Offer used about 5 times, £175. Tel: 01-848 0315, Ask for Steve.

BBC Model B, Acorn 800K disk drives, 051 2, Basic 2, solidisk 32K RAM board, joysticks, vast collection of software, £900 one. Will split. Saffron Hill 01-340 0534.

Spectrum 48K plus joystick interface, printer, monitor games. Any trial Sundays. £135 cash all-in. No offers. Edwards, 60 Queens Road, Tel: Devizes 5241.

VC 20 pack including tape recorder and word pro, £90. Commodore 1541 disk drives, £190. Commodore 1525 printer, £150. All boxed and under guarantee, £400 the lot. Tel: 01-658 3389.

Oric-1 48K, with Zorgon's Revenge, Xenon-1, Oric-Forth and many others. Also Oric Owners and books. Cost £280, only £125, including postage. Tel: Tonbridge (0732) 351898, after 4.30 pm.

Lynx 48-96K, serial printer pack, Sultan's Maze, Grid Attack, Giemppack III & IV, Invaders, Colossal Adventure, Moonfall, the 128K, Tel: 01-856 2004, after 6 pm.

Tandy TRS-50, 16K model 1, level 1 + monitor + tape recorder + books 2 games. As new, little used, bargain at £195. Tel: Littlewick Green 3476, after 5 pm.

Apple IIe DataStar package, new unregistered, includes Z80 card CP/M operating system, five manuals (Reprostar, Datastar) runs all Micropro and other CP/M software, £170 one. Walters. Tel: 0734 56526.

Ritman printer, BBC compatible, 120cps, 80xol, 9x9 dot matrix, HiRes leads, ribbons, screen dump, £210, brand new. Tel: 01-794 0979.

Epson RX200 portable computer with built-in microcassette recorder. Perfect condition, very little use, £300. Tel: Winchester 0703 4988, after 6.40 pm.

Atari games for sale. All originals, send see for list to A. Hughes, Thomas Spencer Hall, Grand Depot Road, Woolwich, London SE18.

Z8181 + 16K, eight months old. Two games, also included three Basic programming books. All for £65 one. Tel: Mr Tupper, (095) 50158.

TRS-90, model 1, 48K, including monitor, expansion interface, disk drive, LPVH printer and manuals, upper case letters only, £450. Tel: Hayling Island 3793, after 6 pm.

BBC 'B', software, all originals, good condition including Vortex, £4, Planetoid, £6, Atarion, £4, Trench, £4, Galactic Commander, £3.50, Rocket Raid, £6. Tel: (0622) 2530.

44K Apple IIe, + 80 column + RS232C + £80, 5 1/4" disks, brand new, brand new FX80 printer + Wordstar/Mailmerge, Calstar, Superstore. Offers over £1,000. Tel: 0257-45226, after 6 pm.

HP-41C, programmable scientific calculator, with financial pack and two extra memory packs, £50. Tel: Saffron Walden (0799) 2424, evenings.

Sharp MZ80, immaculate, manual and demonstration tapes, £300 one. Tel: 01-546 4800, evenings.

T1 99/44 peripherals wanted for expansion box. In exchange for Fleischmann 'N' gauge railway equipment. Majority new and unused, value £1,400. Tel: 0202 433704 anytime.

Commodore 64 and C2N cassette plus books. Offer used about 5 times, £175. Tel: 01-848 0315, Ask for Steve.

BBC Model B, Acorn 800K disk drives, 051 2, Basic 2, solidisk 32K RAM board, joysticks, vast collection of software, £900 one. Will split. Saffron Hill 01-340 0534.

Spectrum 48K plus joystick interface, printer, monitor games. Any trial Sundays. £135 cash all-in. No offers. Edwards, 60 Queens Road, Tel: Devizes 5241.

VC 20 pack including tape recorder and word pro, £90. Commodore 1541 disk drives, £190. Commodore 1525 printer, £150. All boxed and under guarantee, £400 the lot. Tel: 01-658 3389.

BBC Model B and Hitachi monitor for sale, 1.20S, good condition. £360 cash, London SW1. Tel: 01-834 0143.

Dragon 32 with joysticks and £65 worth of software inc. Donkey King, Galactic Ambush, Cosmic Zap, Frogger. Worth £250. Accept £150. Call David Medway. Tel: 64279.

Kenda DMPS for BBC. No user RAM required, £75. Tel: 01-866 4586.

48K Spectrum complete with DK'ronics keyboard plus 2K/4K Epson program — thrown in for free. Only £130. Tel: 01-881 1237.

RML 3802, 56K, colour graphics, one 8" (S00K) disk drive, £1,500 (one). Tel: 0533 766439 (night) or 0533-554455 ext 78 (day).

Sinclair Spectrum 48K with prism VT x 5000, joystick + interface, cassette recorder, software, £250 one. Sell for CBM64 + extras. May separate. Tel: 0386 48457.

VC-20 16K RAM Simplicak, Vicfile, games, chess, intruder. Basic programmers reference book, £100. 01-947 0401.

Spectrum 48K, Tasword, Database programs, manuals £110. Williams, Kynston, Medway Heath, Gillingham, Wedmore, Somerset. Tel: 0934 712344.

BBC Model II, Disc Doctor, Rom Plus games, Rom 100K disc drive printer, software, Mag. Health, £250 one. Sell for £150. Tel: Rayleigh 770027.

Commodore 64 software to swap or sell. Titles include Colossus, Chess, Zaxxon, Master Miner and more. Contact A. Gerard P.O. Box 116, Lieges, Belgique.

Apple IIe DataStar package, new unregistered, includes Z80 card CP/M operating system, five manuals (Reprostar, Datastar) runs all Micropro and other CP/M software, £170 one. Walters. Tel: 0734 56526.

VC 20 pack including tape recorder and word pro, £90. Commodore 1541 disk drives, £190. Commodore 1525 printer, £150. All boxed and under guarantee, £400 the lot. Tel: 01-658 3389.

Partner, Tandy C90, 115, 40, 80 characters in 4 colours, also does graphics. Boxed with manual and as new, £95 one. Tel: 0325 312417.

Partner, "Super Cobra" cartridge for Colecovision, £20. Atari 400 (no Basic etc) plus "Super Cobra" (Atari version), £55. Intellivision plus 5 cartridges, £40. Tel: (0703) 869778.

Oric-1 48K vgc + ten top software titles including Oric, Fourth with manual and Zorgon's Revenge. Also includes joystick adaptor, £120 one. Tel: Wiville 93981.

Kenda disk interface for BBC B, 20K density 40/80 track. Offers over £80. Tel: Rusty 7298, Colchester.

Atari Omnium ROM wanted will swap for original software, or reasonable amount. DE RE Atari and inside Atari-3200. Offers over £500. Will be taken. Tel: Roy Payne (0767) 260470, 6pm.

Dragon 64 plus single disk drive, many games and books plus joysticks, tape recorder, £500 one. Offer £200. Tel: Ongar 363991 evenings only.

Disquettes 3M Scotch new unopened box of ten, 35p 35off retail price. Fits most computer systems. Details from Dave 01-851 0723 (evenings).

BBC Teletext adaptor, hardly used, £185. Also original Acornsoft software, books. Acorn User magazines. Tel: 01-668 5906 after 7pm, for details.

Lynx 48K, boxed with games and Lynx Computing book. £130. Tel: Fleet (02514) 8212.

Atari 1, have a Siliex shop credit note for £50 and will sell for £35. Mr Price 27, Crawford Gardens, St Andrews, Fife.

Dragon 32K with manual, two joysticks, lightpen and £130 worth of software. All for £200. Tel: 051-931 3004 (after 6pm).

T1 99/44 peripherals wanted for expansion box. In exchange for Fleischmann 'N' gauge railway equipment. Majority new and unused, value £1,400. Tel: 0202 433704 anytime.

Commodore 64 and C2N cassette plus books. Offer used about 5 times, £175. Tel: 01-848 0315, Ask for Steve.

Put 32K, 3000 series, Okidata CP110 dot matrix printer and interface software and books, £375. Tel: 0244 67652.

Billboard Buy & Sell Form

To place your Billboard ad, fill in the form on the left, with one word per space, up to a maximum of 24 words. Send the completed form, together with a cheque or postal order for £1.50 made payable to VNU Business Publications, to: **Billboard, Personal Computer News, 62 Oxford Street, London W1A 2HG.** Note that we cannot guarantee that your ad appears in any specific issue, and that we cannot accept ads from commercial organisations of any sort.

Your name:

Address:

Telephone:

MICROSHOP

Rates: £12 per single column cm. Minimum size 3cm. Series discount available. Also spot colour available. **Mechanical Data:** Column width, 1 column 57mm, 2 colours 118mm, 3 columns 179mm. **Copy Dates:** 10 days prior to publication.
Contact: Christian McCarthy on 01-323 3211

NEW

£39.95

GET TO THE HEART OF YOUR DRAGON 32

S-22

THE MACHINE CODE DEVELOPMENT AID

- Simple to use cartridge
- Includes many features
- Manuals easy to understand.
- Co resident with basic

An ideal tool for learning machine code programming.
A permanent addition to your computer power.

ASHBY COMPUTER CENTRE
247 ASHBY HIGH STREET, SCUNTHORPE DN16 2JR
TEL: SCUNTHORPE 871756
MAIL ORDER FROM STOCK TRADE ENQUIRIES WELCOME

NEW FROM DR. GONZA SOFTWARE

SPECTRUM 48K

CASH-PLANNER

By **Loke**

THE PROFESSIONAL PLANNER ANYONE CAN USE

Designed by a chartered Accountant

- Perfectly programmed to produce **FAST BUDGETS & CASHFLOWS** for the year ahead.
- Many labour saving features including **ROLL FORWARD** by changing the **START-MONTH**
- Find out **FAST** if you can afford the holiday in Spain or payments on a new car
- CASH-PLANNER's** number-entry system and displays are a delight
- FORGET** fussy spreadsheets and complex manuals — machine code sound and colour and superb on-screen instructions guide you along
- CASH-PLANNER** makes the real-life money game irresistible
- A minimum of typing-in, plus really easy updating will make this your favourite planning assistant.

Ideal for PERSONAL or SMALL BUSINESS use

Up to 40 items of income/expenditure with amounts up to £1m per year

Optional screen copies to ZX PRINTER if connected

Good planning pays dividends
J. Paul Getty

MAIL ORDER: £4.95 to DOCTOR GONZA SOFTWARE (PCN)
75 ALBERT ROAD WEST, BOLTON BL1 5HW
Enquiries: Telephone 0204 44272

NEW FROM COMPEAK

No longer use binary to design your characters

GRAPHSET

An 8 x 8 grid changes the characters and it is a Copy, rotate, reverse, view, reset, save and load facility. 7 usable demo programs on side 2.

ONLY £6.50

SAVE HOURS OF PROGRAMMING

PEAK SERVICES, 1 LAMBERT HOUSE
BUSSEY, W17 1BB

A MUST FOR ALL 48K SPECTRUM PROGRAMMERS

bubble bus software

magical games and utilities for the Commodore 64 and VIC 20

Available from:
W. H. SMITH, LASKYS, LIGHTNING DEALERS, SPECTRUM SHOPS, GREENS, HMV SHOPS, GAMES WORKSHOPS, CENTRESOFT and PCS STOCKISTS and all Good Dealers.

or direct from:
bubble bus software
87 High Street, Tonbridge
Kent TN9 1RX
Telephone: 0732 355962



MORGAN CAMERA CO.

Have a vacancy for a sales manager for the new and used computer shop. Working knowledge of computer operation and an ability to learn their values necessary.

Please ring **Bob Nicklin** on
(01) 388 2562

Immediate Impact?

To advertise in the largest sell display section of any micro magazine call

CHRISTIAN MCCARTHY
on 01-323 3211 ext. 342

dgh software centre presents

Flight Simulator II for the Commodore 64

(as reviewed on pages 38 and 39)

£35.00 plus 50p (p&h)
10 North Street, Ashford Kent.
Tel: 0233 32597

ACCESS & VISA WELCOME
ALMOST 1,000 TITLES IN STOCK
FOR MOST POPULAR MICROS

BACK-UP TAPE COPIERS

Unique machine code programs to allow security back-up copies of the majority of protected software.

Available for:

COMMODORE 64	£5.95	ELECTRON	£5.95
VIC 20	£5.95	ATARI	£5.95
BBC	£5.95	SPECTRUM	£5.95

TAPE TO DISK TRANSFER UTILITIES

Speed loading and transfer your games, etc. to disk.

Available for:

COMMODORE 64	£9.95
BBC	£9.95
ATARI	£9.95

ALL COMPLETE WITH FULL INSTRUCTIONS.

Price includes VFC, Print & Packing, Cheques or Credit Card Number too.

EVESHAM MICRO CENTRE
Bridge St., Evesham, Worcestershire
Tel: 0586 49641

NEW SHOP NOW OPEN - Plus Cash
115A Phoenix Rd, Colwyn Bay, Merseyside Tel: 021-558 6566

INCREDIBLE BARGAIN OFFER!

IMPROVE THE QUALITY OF YOUR MICRO BY 100% WITH A COLOUR VIDEO COMPUTER MONITOR that is suitable for most leading microcomputers including BBC, Commodore, VIC 20, Dragon, Disc and Atari (please telephone for details of other machines). Features include: 4 switched audio and video channels, 17" screen, a remarkably compact size. * Why buy hundreds of pounds for monitors when our re-manufactured models are only £29.99 + VAT. ** HURRY, as only 50 are initially available!

So telephone David at
HAYES TV RECONDITIONERS
NOW ON 01-561 0562
Trade Enquiries welcome.

INTERFACE PROBLEMS? SOLUTION 4!

SERIAL-2 WAY CENTRONICS £74.95

For owners of computers with RS 232 outputs who wish to connect to two (or more) printers and save money on leads and effort on swapping leads, especially suitable for EPSON HX20, FX18, NEWBRAIN, SINCLAIR, INTERFACE 1, GL, etc. For other solutions, please write to us, or contact us at.

Tyepro
30 Campkin Rd., Cambridge CB4 2NG.
Tel: 0255 422087 Day 0223 322394 Eve.

2 Sales people wanted

to sell the Microgem range of home and small business computer products and accessories to retail outlets in the following areas:

- (1) Merseyside, Greater Manchester, Yorkshire
- (2) London and Home Counties

Applicants must reside on the territory and must have an interest in and knowledge of home computers and their applications. Please apply in writing to **Sales Manager, Diamond Stylus Plc, Colwyn Bay, Cwyd LL28 5HD, North Wales.**

MICROSHOP

COMPUCLUB

CUTS THE COST OF YOUR COMPUTING

SOFTWARE, RIBBONS, DISKS,
BLANK TAPES, ACCESSORIES

IN FACT ALL YOU NEED FOR
YOUR COMPUTER AT DISCOUNT
PRICES

MONTHLY NEWSLETTER WITH
SPECIAL OFFERS

ANNUAL SUBSCRIPTION £5

Details from:

COMPUCLUB
FREEPOST HP6 5BR
AMERSHAM
BUCKS

ASTROLOGY

Save yourself hours of
tedious calculation and open
up a whole new view of life with our
Self-Teaching and Accurate Calculation
Programs for

Sharp MZ80A V/700 Commodore 64, VIC 20
BBC Electron, BBC 1 Home
Sinclair 100, 2001, and 600 Spectrum
Dragon 32, 64 NewBrain
Colour Genie Video-Genie Genie
Tandy and PET

Many routines include Natal progressions, transits, solar & lunar returns,
midpoints, harmonics, chart wheels, etc. Standards as taught by the main
astrological schools or build your program by your specification.

Please send see form—

ASTROCALC

67 Peascoat Road, Hemel Hempstead,
Herts HP3 8ER, tel: 0442 51809

SPECTRUM KOPYCAT

Simply the best. Slipping any 16-bit Spectrum program is as easy as
LOADING & SAVING your own programs. Even untoppable programs can
now be loaded up.

Only £4.95

IT CAN EVEN COPY ITSELF

NEW

MICRODRIVE KOPYCAT

Transfer your cassette-based software onto the ZX Microdrive, RELOCATES
programs. Slips & rewrites programs ESSENTIAL for MS-DOS transfer.

Only £4.95

FREE Header Reader Despatched by Return of Post

MEDSOFT

PO Box 84, Basingstoke, Hants

64 SPECIALISTS

1541

Disk drives with £180 of free software
£229 — plus

DUAL 1541 BACKUP PROGRAM

If purchased separately £9.95

PAYROLL 64

Overtime/piecework rates with NI and
SSP. Full payslip, Deduction card &
Coinage printout. £11.40

FLIGHT SIMULATOR II

for 64 and Apple

The ultimate with 80 airports!! Fly round
the Statue of Liberty and under the Golden
Bridge!! Disk only £37.95

ALL IN STOCK AT YOUR 64 SPECIALISTS

MILTON KEYNES MUSIC & COMPUTERS

17 Bridge Street, Leighton Buzzard, Beds.

Tel: (0525) 376622. Closed Thursdays.

ASK FOR OUR FREE LISTS

BLANK CASSETTES

Rely on the professionals for guaranteed top quality computer/audio
cassettes of great value budget prices. Packed in boxes of 10,
complete with labels, inlay cards and library case.

Prices include VAT, post & packing

LENGTH	BOX PRICE (10)	QTY.	VALUE
5 mins (c.5)	£4.55		
10 mins (c.10)	£4.40		
12 mins (c.12)	£4.45		
15 mins (c.15)	£4.50		
30 mins (c.30)	£4.70		
60 mins (c.60)	£5.30		
90 mins (c.90)	£7.00		

Cheque/Postal Order enclosed for
TRADE ENQUIRIES WELCOME. SET BEST TERMS. SERVICE A PRODUCT BUY
DIRECT FROM MANUFACTURERS OF PROFESSIONAL BRAND CASSETTES.

NAME _____
ADDRESS _____

PROFESSIONAL MAGNETICS LTD

Cassette House, 329 Hummel Road, Leeds LS10 2TY

FREEPOST Tel: (0532) 706066

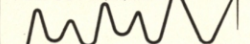

SHARP MZ700

Software, books and peripherals. Large
S.A.E. for list.

TEXAS TI 99/4A

Software, books and peripherals. Large
S.A.E. for list.
Small business accounts and VAT on disc
for Commodore 64 £150 + VAT. Demo
cassette available.

Secondhand computers, software and peripherals bought and
sold. Anything considered.

Station Electrical

Coastal Rd, Hest Bank Lancaster, Lancs. LA2 6HN
Tel: (0524) 824519

SPECTRUM & DRAGON TAPE COPIERS

Makes BACK-UP COPIES OF ALL SPECTRUM programs
(including headerless, misc. unstoppable) that we are aware
of, with MANY unique features.

LOADS in all program parts CONTINUOUSLY. Verifies,
Slips, Aborts, Program Names, HEAD data
+ FULL instructions, very user friendly. MDRIVE copies
onto microdrive.

Cost only £4.75 or £5.75 with MDRIVE.
(Overseas: + £1 Europe: £2 others).

Dragon Copier: £8.99.
5 STARS FROM THE HCW REVIEW. With 3 out of 4 ratings of
100%!
FULL MONEY BACK GUARANTEE if you are not
satisfied.

LERM, Dept PCN
10 BRUNSWICK GDNS, CORBY, NORTHANTS

ORIC SOFTWARE

PERSONAL FINANCE

Account Book — for home, club or small business

EDUCATIONAL

Picture Book — colourful spelling game for young children
Story Book — challenging game to develop reading skills
*** Review Ratings (HCW)

For details phone 0923 53482 or write to:

Softbacks, (Dept. PCN)
FREEPOST, Watford, WD1 8FP.

Software

WANTED

PERSONAL COMPUTERS

all models bought for cash

Morgan Camera Company

160 Tottenham Court Road,

London W1. Tel: 01-388 2562

Recruitment

INPUT

The leading home computer software
publication has vacancies for

★ EXPERIENCED PROGRAMMERS

★ WRITERS or EDITORS

who have detailed knowledge of one or more of these machines

Sinclair Spectrum, Commodore 64,
BBC B or Dragon 32

Candidates must be able to work to tight deadlines under pressure.
Vacancies are for full-time staff or freelance contributors.

Please apply in writing, enclosing a CV to
Jennie Otway-Norwood

Input

Marshall Cavendish Limited
58 Old Compton Street
London W1V 5PA

Copies of Issues 1 to 12 are still available from our Back Issues Department (see order form on next page). For details of their contents please call Gina Setchfield on 01-439 4242.

Issue 13, June 3-9.

Pro-Tests: Televiter for Dragon 32, Aberforth Forth for Spectrum, GIPS graphics processing system for Apple II+; joystick, rulle; Ajile. **Features:** Dragon meets Tandy. **Programs:** Word processor (BBC), Fruit Machine (Spectrum). **Microcopia:** Sound, part 1.

Issue 14, June 10-16. **Pro-Tests:** peripheral. **Programs:** Everest Ascent (Spectrum), Colour Game roundup, Micro Maze (Jupiter Ace), Qix (Atari), Alien (Dragon 32), Time Bomb (Atari).

Issue 15, June 16-22. **Pro-Test:** Com 3, Address Manager (Spectrum), Sytes (Commodore 64), MST Database (Epson HC20), Voice Input Module (Apple II). **Features:** Newbrain Basic part 2. **Gameplay:** Cleared for Landing, Playing the Ace (Apple II), Vulcan, Star Jammer (Dragon 32). **Programs:** Cards: Mover (BBC B), Sprite Clock (Commodore 64), Fate Island (Atari, 3 of 9), Mirror-mind (Colour Game), Brickbat (Dragon 32). **Databases:** Hardware. **Microcopia:** Spectrum, part 2.

Issue 16, June 23-29. **Pro-Tests:** Atari v Acorn, word processing for the Commodore 64, Simplefile (CPM), MPF-II printer. **Features:** ZXSI Maths, US mail order, Atari graphics. **Gameplay:** Computer Scrabble (Spectrum), Education (BBC), Horace and Spiders (Spectrum), Catcha Snatcha (Vic 20). **Programs:** Cards: Video Tiler (T1994A 3 of 6), Bowling (Spectrum), Pirate Island (Atari cont).

Issue 17, June 30-July 6. **Pro-Tests:** Diet-16, The Organizer (CPM), Trace and ZXII Text (Spectrum), Jaks6000/danceit, Video Ultra Term (Apple II). **Features:** Leaving part 1, Atari screen action. **Gameplay:** Orc chess, Grand Master (Commodore 64), Escape from Orion (BBC), Jet Pac (Spectrum), The Ring of Darkness (Dragon 32), Spectrum spectacle.

Issue 18, July 7-13. **Pro-Tests:** Tandy 10, RS232 interface (ZX81), ROM pack (Commodore), Interface primer buffer, IBM Personal Basic, Spectrum assembler, Newbrain VP. **Features:** Leaving Part 2, Lynx music. **Gameplay:** Spectrum Backgammon, BBC Snooker, Commodore 64 round-up, Serpentine (Vic 20), Pat (Spectrum), Spectrum Safari. **Programs:** Cards: Word processor (BBC), Fruit Machine (Spectrum). **Microcopia:** Sound Part 2.

Issue 19, July 14-20. **Pro-Tests:** 16-bit chips, Stock control (Epson HC20), Multiplus (Torco), Smith-Corona daisy-wheel, ZXSI word processing. **Features:** Insurance, buying cash and hand. **Gameplay:** Escape MCP (C64), Escape from Perlas (Atari), Apple round-up, Temple of Aphai (C64), Health (Spectrum). **Programs:** Cards: Colour Code (Atari), Weapons (Dragon art), Dragon scrolling. **Microcopia:** Sound, part 3.

Issue 20, July 21-27. **Pro-Tests:** Rade barbeard, Vic digital tape drive, Seikoha colour printer, Foodkit (Spectrum), Bonus (Fet payroll), Newbrain monitor. **Features:** Computer art, Dragon scrolling. **Gameplay:** Rabbit Trail (T1994A), Aztec Challenge (Atari, Vic 20, T1994A), BBC round-up, Joust (Spectrum), Molar Mail (Spectrum), Print Shop (Spectrum), Time-Lords (BBC). **Programs:** Cards: Tumbler (Oric), Greed (Dragon), Atari Errors, Speed Race (Vic) part 4. **Microcopia:** Sound, part 4.

Issue 21, July 28-August 3. **Pro-Tests:** BBC graphics, Newbrain assembler, BBC turtle, Oric printer, Triumph printer. **Gameplay:** Franklin's Tomb (Dragon), Hummer Hero of Horror (Spectrum), Jumpman (64), Jumping Jack (Spectrum), Fourth Encounter (Vic), Cyclons (64). **Programs:** Cards: Collections (Vic), Bomber (64), Defender (BBC). **Microcopia:** Sound, part 5.

Issue 22, August 4-August 10. **Pro-Tests:** Spectrum Forth, BBC graphics, Music synthesizers, IBM plotter, Brother daisywheel, Maltron keyboard, Mup. **Features:** Gene assembler, Dragon machine code. **Gameplay:** Rescue, Orc Attack (Atari), Zork (64), Knix in 3D, JD Combat Zone (Spectrum), Moria (Oric), Velnor's Lair (Spectrum). **Microcopia:** CP/M part 1.

Issue 23, August 11-August 17. **Pro-Tests:** Sort Basic-C, Tasword, BBC Collections, Microdrive, Tandy Model 4. **Features:** Dragon machine code, Atari screen action. **Gameplay:** Bridge Master, Sxyx, Manic Minic (Spectrum), Atari roundup, Candy Floor (Jargon (Oric), Everest (Dragon). **Microcopia:** CP/M, part 2.

Programs: Video Tiler (T1994A cont), Pirate Island (Atari cont), Word processor (BBC). **Microcopia:** Sound, part 1.

Issue 18, July 7-13. **Pro-Tests:** Tandy 10, RS232 interface (ZX81), ROM pack (Commodore), Interface primer buffer, IBM Personal Basic, Spectrum assembler, Newbrain VP. **Features:** Leaving Part 2, Lynx music. **Gameplay:** Spectrum Backgammon, BBC Snooker, Commodore 64 round-up, Serpentine (Vic 20), Pat (Spectrum), Spectrum Safari. **Programs:** Cards: Word processor (BBC), Fruit Machine (Spectrum). **Microcopia:** Sound Part 2.

Issue 19, July 14-20. **Pro-Tests:** 16-bit chips, Stock control (Epson HC20), Multiplus (Torco), Smith-Corona daisy-wheel, ZXSI word processing. **Features:** Insurance, buying cash and hand. **Gameplay:** Escape MCP (C64), Escape from Perlas (Atari), Apple round-up, Temple of Aphai (C64), Health (Spectrum). **Programs:** Cards: Colour Code (Atari), Weapons (Dragon art), Dragon scrolling. **Microcopia:** Sound, part 3.

Issue 20, July 21-27. **Pro-Tests:** Rade barbeard, Vic digital tape drive, Seikoha colour printer, Foodkit (Spectrum), Bonus (Fet payroll), Newbrain monitor. **Features:** Computer art, Dragon scrolling. **Gameplay:** Rabbit Trail (T1994A), Aztec Challenge (Atari, Vic 20, T1994A), BBC round-up, Joust (Spectrum), Molar Mail (Spectrum), Print Shop (Spectrum), Time-Lords (BBC). **Programs:** Cards: Tumbler (Oric), Greed (Dragon), Atari Errors, Speed Race (Vic) part 4. **Microcopia:** Sound, part 4.

Issue 21, July 28-August 3. **Pro-Tests:** BBC graphics, Newbrain assembler, BBC turtle, Oric printer, Triumph printer. **Gameplay:** Franklin's Tomb (Dragon), Hummer Hero of Horror (Spectrum), Jumpman (64), Jumping Jack (Spectrum), Fourth Encounter (Vic), Cyclons (64). **Programs:** Cards: Collections (Vic), Bomber (64), Defender (BBC). **Microcopia:** Sound, part 5.

Issue 22, August 4-August 10. **Pro-Tests:** Spectrum Forth, BBC graphics, Music synthesizers, IBM plotter, Brother daisywheel, Maltron keyboard, Mup. **Features:** Gene assembler, Dragon machine code. **Gameplay:** Rescue, Orc Attack (Atari), Zork (64), Knix in 3D, JD Combat Zone (Spectrum), Moria (Oric), Velnor's Lair (Spectrum). **Microcopia:** CP/M part 1.

Issue 23, August 11-August 17. **Pro-Tests:** Sort Basic-C, Tasword, BBC Collections, Microdrive, Tandy Model 4. **Features:** Dragon machine code, Atari screen action. **Gameplay:** Bridge Master, Sxyx, Manic Minic (Spectrum), Atari roundup, Candy Floor (Jargon (Oric), Everest (Dragon). **Microcopia:** CP/M, part 2.

PERSONAL COMPUTER



Issue 24, August 18-24. **Pro-Tests:** T-Maker II, Spectrum Fifth daisywheels surveyed, Spectrum digital tracer, Laser. **Features:** Videotex, Dragon machine code. **Gameplay:** Oric roundup, Sea Egg Farm, Xadom (Spectrum), Cokill (Atari), Lustrane (Dragon 64), The Island (64). **Microcopia:** Commodore 64, part 1.

Issue 25, August 25-August 31. **Pro-Tests:** IBM, Simons Basic, Oric monitors, Microdrive. **Features:** Newbrain map, Acorn Atom, Dragon machine code. **Gameplay:** Suspended (64), Terror Dakis, Tranz AM (Spectrum), Dragon roundup, Jagger (Oric), Frogger (IBM). **Microcopia:** Commodore 64.

Issue 26, September 1-September 7. **Pro-Tests:** Microtan 85, BCL, BBC tracer, 80 column Pet, Oric interfaces. **Gameplay:** Magic Mountain, Smugglers Cove (Spectrum), Spectrum roundup, Matrix (64), Ninja Warrior (Dragon), Dallas, (Oric), Call to Arms (IBM). **Microcopia:** Commodore 64.

Issue 27, September 8-September 14. **Pro-Tests:** Sharp MZ20, BBC Logo, Apple editor, IBM mice, ZXSI surgery. **Gameplay:** Zip-Zap, Zoom (Spectrum), Spectrum roundup, Hover Boyver, Beni-Space Rescue (64). **Microcopia:** Dragon, part 1.

Issue 28, September 15-September 21. **Pro-Tests:** Zenith Z100, Seal Logo, Atari Supergraphics, Newbrain CPM, IBM mice. **Gameplay:** The Witness, Super Scramble, Siv(64), Harrier Attack (Oric), Morocco Grand Prix (Dragon), Pharaoh's Tomb (Spectrum). **Microcopia:** Dragon, part 2.

Issue 29, September 22-September 28. **Pro-Tests:** Portico Miracle, Dragon editor, BBC toolkit, Dragon features, Apple light pen. **Features:** H20 assemblies, TI transformation. **Gameplay:** Griddler, Gloopert, California Gold Rush (64), Oric roundup, Bomb Alley (BBC), Splat, General Election (Spectrum). **Microcopia:** Dragon, part 3.

Issue 30, September 29-October 5.

Pro-Tests: NEC's Advanced Personal Computer, Financial Planner (IBM), Kongman's a.b.c. Countabout Hot Dog Spotter (Spectrum), Prism VTX500, Extended Basic (Dragon). **Features:** Spectrum machine code. **Gameplay:** Halls of Death/Sword of Fargal (64), 747 Flight Simulator (BBC), Dragonfly (Dragon 32), Forensic Note Invaders (BBC). **Programs:** Search (ZX81), Composter (Oric). **Databases:** Hardware. **Microcopia:** Everything you want to know about programming, part 1. **Clubnet:** Clubs.

Issue 31, October 6-October 12. **Pro-Tests:** Atari 600XL, Condor Series 20 (IBM), Acacia Non-volatile Diary-Filing system (BBC), ROM extension board (BBC). **Features:** Oric sound routines. **Gameplay:** Greedy Gulch (Spectrum), Kong (Spectrum), Crazy Kong (64), Cuthbert Goes Walkabout/Movie Producer (Dragon). **Programs:** Composer (Oric), 555 (Spectrum), Anagrams (Dragon). **Databases:** Peripherals. **Microcopia:** Everything you want to know about programming. **Clubnet:** User Groups.

Issue 32, October 13-October 19. **Pro-Tests:** Mattel Computer Adapter/Intelligence, Sprite-Gen (BBC), Typing Strategy (Apple), MCode (Spectrum), Citech Epron Programmer (Apple). **Features:** Telescope options, Inside the Gameplay: Space Shuttle Frogger (Dragon 32), Atari roundup, Spectralrow 2/Football Pools Program (Spectrum). **Databases:** Software. **Clubnet:** Clubs. **Programs:** Bees Away (BBC), Composer (Oric). **Microcopia:** Everything you want to know about programming, part 3.

Issue 33, October 20-October 26. **Pro-Tests:** ZWP's Cortex, Sinclair ZX Interface 2, Watford DFS (BBC), Wordsworth (BBC), Atariwriter. **Features:** Oric Operating System, Gameplay Dragon roundup, Hunter (64), Cricket/Luna Crabs (Spectrum), 3 Deep Space (BBC). **Programs:** Cards: Key Utility Files, Bees Away (BBC), Text Card (Apple). **Microcopia:** Everything you want to know about programming, part 4.

Issue 34, October 27-November 2. **Pro-Tests:** NEC's PC-8201A, Simply File (64), The Forest (Spectrum), Ancom DFS (BBC), Currah Microspeech (Spectrum). **Features:** Oric Machine Code. **Gameplay:** Fort Apocalyp/Poyan (Atari), Death Cruise/Crime (Dragon), Trench/Canyon (BBC), Football Manager/Pool (Spectrum). **Programs:** French Text (Apple), Babafal (ZX81), Count (Vic 20), Men/Arith (Vic), Court (Vid Hog BBC). **Databases:** Hardware. **Microcopia:** Everything you want to know about programming, part 5.

Issue 35, November 3-November 9. **Pro-Tests:** Kaypro 10, Stock Control (Spectrum), Educational games (BBC), Brother EP22 electronic typewriter, ADS Centronics Interface (Spectrum), Jupiter Ace). **Features:** Tandy Graphics, BBC Operating System. **Gameplay:** Vihalla (Spectrum), 64 round-up, Slinky (Atari), Hexport (64). **Programs:** Mini Math (Spectrum), Multi-Square (Apple). **Databases:** Peripherals. **Microcopia:** Everything you want to know about programming, part 6.

Issue 36, November 10-November 16. **Pro-Tests:** Tiger from H.H. ZX81-Forth, Eamon (Oric), ZX81-Forth, Exon, Growth Tracker/Daisy Mator (Spectrum), U-Com 2 (Apple). **Features:** Newbrain sound, BBC FX commands. **Gameplay:** Creepers (Vic 20), Extraterrestrial (64), Spectrum roundup, Death Miles of Sirus (Dragon). **Programs:** Falklands Raid (BBC), Orion Math (Spectrum), Pyramid (Spectrum). **Databases:** Software. **Microcopia:** Everything you want to know about programming, part 7.

Issue 37, November 17-November 23. **Pro-Tests:** Agricop, Paint (Atari), BBC Micro Toolbits, Spectravideo Computer (Atari VCS2600), Big Cars. **Features:** Flight simulators, Spectrum screening. **Gameplay:** Empire/Treasure Tomb, Crystal Challenge, Temple of Gons (Dragon 32), Gobos Maze/Bewitched (Vic 20), Cosmic Com-puter/Planetfall (64), Bugaboo/Gorilla (Dragon 32). **Programs:** City Defense (Oric), Falklands Raid (BBC), Pyramid (Spectrum), Monitor (64). **Databases:** Clubnet. **Microcopia:** Everything you want to know about programming, part 8.

Issue 38, November 24-November 30. **Pro-Tests:** Atari 800XL, Atari 800XE, Atari 800X, Atari 800M, Atari 800C, Atari 800D, Atari 800E, Atari 800F, Atari 800G, Atari 800H, Atari 800I, Atari 800J, Atari 800K, Atari 800L, Atari 800M, Atari 800N, Atari 800O, Atari 800P, Atari 800Q, Atari 800R, Atari 800S, Atari 800T, Atari 800U, Atari 800V, Atari 800W, Atari 800X, Atari 800Y, Atari 800Z. **Features:** Atari 800XL, Atari 800XE, Atari 800X, Atari 800M, Atari 800N, Atari 800O, Atari 800P, Atari 800Q, Atari 800R, Atari 800S, Atari 800T, Atari 800U, Atari 800V, Atari 800W, Atari 800X, Atari 800Y, Atari 800Z. **Microcopia:** Atari 800XL, Atari 800XE, Atari 800X, Atari 800M, Atari 800N, Atari 800O, Atari 800P, Atari 800Q, Atari 800R, Atari 800S, Atari 800T, Atari 800U, Atari 800V, Atari 800W, Atari 800X, Atari 800Y, Atari 800Z.

Issue 39, November 31-December 7. **Pro-Tests:** Atari 800XL, Atari 800XE, Atari 800X, Atari 800M, Atari 800N, Atari 800O, Atari 800P, Atari 800Q, Atari 800R, Atari 800S, Atari 800T, Atari 800U, Atari 800V, Atari 800W, Atari 800X, Atari 800Y, Atari 800Z. **Features:** Atari 800XL, Atari 800XE, Atari 800X, Atari 800M, Atari 800N, Atari 800O, Atari 800P, Atari 800Q, Atari 800R, Atari 800S, Atari 800T, Atari 800U, Atari 800V, Atari 800W, Atari 800X, Atari 800Y, Atari 800Z. **Microcopia:** Atari 800XL, Atari 800XE, Atari 800X, Atari 800M, Atari 800N, Atari 800O, Atari 800P, Atari 800Q, Atari 800R, Atari 800S, Atari 800T, Atari 800U, Atari 800V, Atari 800W, Atari 800X, Atari 800Y, Atari 800Z.

Issue 40, December 8-December 14. **Pro-Tests:** Atari 800XL, Atari 800XE, Atari 800X, Atari 800M, Atari 800N, Atari 800O, Atari 800P, Atari 800Q, Atari 800R, Atari 800S, Atari 800T, Atari 800U, Atari 800V, Atari 800W, Atari 800X, Atari 800Y, Atari 800Z. **Features:** Atari 800XL, Atari 800XE, Atari 800X, Atari 800M, Atari 800N, Atari 800O, Atari 800P, Atari 800Q, Atari 800R, Atari 800S, Atari 800T, Atari 800U, Atari 800V, Atari 800W, Atari 800X, Atari 800Y, Atari 800Z. **Microcopia:** Atari 800XL, Atari 800XE, Atari 800X, Atari 800M, Atari 800N, Atari 800O, Atari 800P, Atari 800Q, Atari 800R, Atari 800S, Atari 800T, Atari 800U, Atari 800V, Atari 800W, Atari 800X, Atari 800Y, Atari 800Z.

Issue 41, December 15-December 21. **Pro-Tests:** Atari 800XL, Atari 800XE, Atari 800X, Atari 800M, Atari 800N, Atari 800O, Atari 800P, Atari 800Q, Atari 800R, Atari 800S, Atari 800T, Atari 800U, Atari 800V, Atari 800W, Atari 800X, Atari 800Y, Atari 800Z. **Features:** Atari 800XL, Atari 800XE, Atari 800X, Atari 800M, Atari 800N, Atari 800O, Atari 800P, Atari 800Q, Atari 800R, Atari 800S, Atari 800T, Atari 800U, Atari 800V, Atari 800W, Atari 800X, Atari 800Y, Atari 800Z. **Microcopia:** Atari 800XL, Atari 800XE, Atari 800X, Atari 800M, Atari 800N, Atari 800O, Atari 800P, Atari 800Q, Atari 800R, Atari 800S, Atari 800T, Atari 800U, Atari 800V, Atari 800W, Atari 800X, Atari 800Y, Atari 800Z.

Issue 42, December 22-December 28. **Pro-Tests:** Atari 800XL, Atari 800XE, Atari 800X, Atari 800M, Atari 800N, Atari 800O, Atari 800P, Atari 800Q, Atari 800R, Atari 800S, Atari 800T, Atari 800U, Atari 800V, Atari 800W, Atari 800X, Atari 800Y, Atari 800Z. **Features:** Atari 800XL, Atari 800XE, Atari 800X, Atari 800M, Atari 800N, Atari 800O, Atari 800P, Atari 800Q, Atari 800R, Atari 800S, Atari 800T, Atari 800U, Atari 800V, Atari 800W, Atari 800X, Atari 800Y, Atari 800Z. **Microcopia:** Atari 800XL, Atari 800XE, Atari 800X, Atari 800M, Atari 800N, Atari 800O, Atari 800P, Atari 800Q, Atari 800R, Atari 800S, Atari 800T, Atari 800U, Atari 800V, Atari 800W, Atari 800X, Atari 800Y, Atari 800Z.

Issue 43, December 29-December 31. **Pro-Tests:** Atari 800XL, Atari 800XE, Atari 800X, Atari 800M, Atari 800N, Atari 800O, Atari 800P, Atari 800Q, Atari 800R, Atari 800S, Atari 800T, Atari 800U, Atari 800V, Atari 800W, Atari 800X, Atari 800Y, Atari 800Z. **Features:** Atari 800XL, Atari 800XE, Atari 800X, Atari 800M, Atari 800N, Atari 800O, Atari 800P, Atari 800Q, Atari 800R, Atari 800S, Atari 800T, Atari 800U, Atari 800V, Atari 800W, Atari 800X, Atari 800Y, Atari 800Z. **Microcopia:** Atari 800XL, Atari 800XE, Atari 800X, Atari 800M, Atari 800N, Atari 800O, Atari 800P, Atari 800Q, Atari 800R, Atari 800S, Atari 800T, Atari 800U, Atari 800V, Atari 800W, Atari 800X, Atari 800Y, Atari 800Z.

PERSONAL COMPUTER



Issue 37, November 17-23. **Pro-Tests:** Agricop, Paint (Atari), BBC Micro Toolbits, Spectravideo Computer (Atari VCS2600), Big Cars. **Features:** Flight simulators, Spectrum screening. **Gameplay:** Empire/Treasure Tomb, Crystal Challenge, Temple of Gons (Dragon 32), Gobos Maze/Bewitched (Vic 20), Cosmic Computer/Planetfall (64), Bugaboo/Gorilla (Dragon 32). **Programs:** City Defense (Oric), Falklands Raid (BBC), Pyramid (Spectrum), Monitor (64). **Databases:** Clubnet. **Microcopia:** Everything you want to know about programming, part 8.

Issue 38, November 24-30. **Pro-Tests:** Atari 800XL, Atari 800XE, Atari 800X, Atari 800M, Atari 800N, Atari 800O, Atari 800P, Atari 800Q, Atari 800R, Atari 800S, Atari 800T, Atari 800U, Atari 800V, Atari 800W, Atari 800X, Atari 800Y, Atari 800Z. **Features:** Atari 800XL, Atari 800XE, Atari 800X, Atari 800M, Atari 800N, Atari 800O, Atari 800P, Atari 800Q, Atari 800R, Atari 800S, Atari 800T, Atari 800U, Atari 800V, Atari 800W, Atari 800X, Atari 800Y, Atari 800Z. **Microcopia:** Atari 800XL, Atari 800XE, Atari 800X, Atari 800M, Atari 800N, Atari 800O, Atari 800P, Atari 800Q, Atari 800R, Atari 800S, Atari 800T, Atari 800U, Atari 800V, Atari 800W, Atari 800X, Atari 800Y, Atari 800Z.

Issue 39, November 31-December 7. **Pro-Tests:** Atari 800XL, Atari 800XE, Atari 800X, Atari 800M, Atari 800N, Atari 800O, Atari 800P, Atari 800Q, Atari 800R, Atari 800S, Atari 800T, Atari 800U, Atari 800V, Atari 800W, Atari 800X, Atari 800Y, Atari 800Z. **Features:** Atari 800XL, Atari 800XE, Atari 800X, Atari 800M, Atari 800N, Atari 800O, Atari 800P, Atari 800Q, Atari 800R, Atari 800S, Atari 800T, Atari 800U, Atari 800V, Atari 800W, Atari 800X, Atari 800Y, Atari 800Z. **Microcopia:** Atari 800XL, Atari 800XE, Atari 800X, Atari 800M, Atari 800N, Atari 800O, Atari 800P, Atari 800Q, Atari 800R, Atari 800S, Atari 800T, Atari 800U, Atari 800V, Atari 800W, Atari 800X, Atari 800Y, Atari 800Z.

Issue 40, December 8-14. **Pro-Tests:** Atari 800XL, Atari 800XE, Atari 800X, Atari 800M, Atari 800N, Atari 800O, Atari 800P, Atari 800Q, Atari 800R, Atari 800S, Atari 800T, Atari 800U, Atari 800V, Atari 800W, Atari 800X, Atari 800Y, Atari 800Z. **Features:** Atari 800XL, Atari 800XE, Atari 800X, Atari 800M, Atari 800N, Atari 800O, Atari 800P, Atari 800Q, Atari 800R, Atari 800S, Atari 800T, Atari 800U, Atari 800V, Atari 800W, Atari 800X, Atari 800Y, Atari 800Z. **Microcopia:** Atari 800XL, Atari 800XE, Atari 800X, Atari 800M, Atari 800N, Atari 800O, Atari 800P, Atari 800Q, Atari 800R, Atari 800S, Atari 800T, Atari 800U, Atari 800V, Atari 800W, Atari 800X, Atari 800Y, Atari 800Z.

Issue 41, December 15-21. **Pro-Tests:** Atari 800XL, Atari 800XE, Atari 800X, Atari 800M, Atari 800N, Atari 800O, Atari 800P, Atari 800Q, Atari 800R, Atari 800S, Atari 800T, Atari 800U, Atari 800V, Atari 800W, Atari 800X, Atari 800Y, Atari 800Z. **Features:** Atari 800XL, Atari 800XE, Atari 800X, Atari 800M, Atari 800N, Atari 800O, Atari 800P, Atari 800Q, Atari 800R, Atari 800S, Atari 800T, Atari 800U, Atari 800V, Atari 800W, Atari 800X, Atari 800Y, Atari 800Z. **Microcopia:** Atari 800XL, Atari 800XE, Atari 800X, Atari 800M, Atari 800N, Atari 800O, Atari 800P, Atari 800Q, Atari 800R, Atari 800S, Atari 800T, Atari 800U, Atari 800V, Atari 800W, Atari 800X, Atari 800Y, Atari 800Z.

Issue 42, December 22-28. **Pro-Tests:** Atari 800XL, Atari 800XE, Atari 800X, Atari 800M, Atari 800N, Atari 800O, Atari 800P, Atari 800Q, Atari 800R, Atari 800S, Atari 800T, Atari 800U, Atari 800V, Atari 800W, Atari 800X, Atari 800Y, Atari 800Z. **Features:** Atari 800XL, Atari 800XE, Atari 800X, Atari 800M, Atari 800N, Atari 800O, Atari 800P, Atari 800Q, Atari 800R, Atari 800S, Atari 800T, Atari 800U, Atari 800V, Atari 800W, Atari 800X, Atari 800Y, Atari 800Z. **Microcopia:** Atari 800XL, Atari 800XE, Atari 800X, Atari 800M, Atari 800N, Atari 800O, Atari 800P, Atari 800Q, Atari 800R, Atari 800S, Atari 800T, Atari 800U, Atari 800V, Atari 800W, Atari 800X, Atari 800Y, Atari 800Z.

Issue 43, December 29-31. **Pro-Tests:** Atari 800XL, Atari 800XE, Atari 800X, Atari 800M, Atari 800N, Atari 800O, Atari 800P, Atari 800Q, Atari 800R, Atari 800S, Atari 800T, Atari 800U, Atari 800V, Atari 800W, Atari 800X, Atari 800Y, Atari 800Z. **Features:** Atari 800XL, Atari 800XE, Atari 800X, Atari 800M, Atari 800N, Atari 800O, Atari 800P, Atari 800Q, Atari 800R, Atari 800S, Atari 800T, Atari 800U, Atari 800V, Atari 800W, Atari 800X, Atari 800Y, Atari 800Z. **Microcopia:** Atari 800XL, Atari 800XE, Atari 800X, Atari 800M, Atari 800N, Atari 800O, Atari 800P, Atari 800Q, Atari 800R, Atari 800S, Atari 800T, Atari 800U, Atari 800V, Atari 800W, Atari 800X, Atari 800Y, Atari 800Z.

Issue 44, January 1-7. **Pro-Tests:** Atari 800XL, Atari 800XE, Atari 800X, Atari 800M, Atari 800N, Atari 800O, Atari 800P, Atari 800Q, Atari 800R, Atari 800S, Atari 800T, Atari 800U, Atari 800V, Atari 800W, Atari 800X, Atari 800Y, Atari 800Z. **Features:** Atari 800XL, Atari 800XE, Atari 800X, Atari 800M, Atari 800N, Atari 800O, Atari 800P, Atari 800Q, Atari 800R, Atari 800S, Atari 800T, Atari 800U, Atari 800V, Atari 800W, Atari 800X, Atari 800Y, Atari 800Z. **Microcopia:** Atari 800XL, Atari 800XE, Atari 800X, Atari 800M, Atari 800N, Atari 800O, Atari 800P, Atari 800Q, Atari 800R, Atari 800S, Atari 800T, Atari 800U, Atari 800V, Atari 800W, Atari 800X, Atari 800Y, Atari 800Z.

Issue 45, January 8-14. **Pro-Tests:** Atari 800XL, Atari 800XE, Atari 800X, Atari 800M, Atari 800N, Atari 800O, Atari 800P, Atari 800Q, Atari 800R, Atari 800S, Atari 800T, Atari 800U, Atari 800V, Atari 800W, Atari 800X, Atari 800Y, Atari 800Z. **Features:** Atari 800XL, Atari 800XE, Atari 800X, Atari 800M, Atari 800N, Atari 800O, Atari 800P, Atari 800Q, Atari 800R, Atari 800S, Atari 800T, Atari 800U, Atari 800V, Atari 800W, Atari 800X, Atari 800Y, Atari 800Z. **Microcopia:** Atari 800XL, Atari 800XE, Atari 800X, Atari 800M, Atari

Issue 38, November 24-November 30.
Pro-Tests: Coleco's Adam, Small Business Accounts (Spectrum), Minterfile (BBC), Monitor roundup.
Features: Apple programming, NewBrain editor part 1, Dragon action part 1.
Gameplay: Dragon roundup, Zepherus Blue Max (Atari), Star Wars Falcon Patrol (64), 737 Flight simulator (BBC).
Programs: Shipment (Spectrum), Monitor (64).
Databases: Hardware.
Microspedia: Guide to Monitors.

Issue 39, December 1-December 7.
Pro-Tests: Dragon 64, Tandy CGP-220, White Knight II (BBC), Cross Reference Unity (BBC).
Features: NewBrain editor part 2, Dragon Action part 2.
Gameplay: Orc roundup, Haunted Hedges/Corridors of Genos (Spectrum), Microbe One Hundred & Eighty (BBC), Atari roundup.
Programs: Lower CLS (Spectrum), Shipment (Spectrum), Monitor (64), Base Search (BBC), 49.
Microspedia: Buyer's Guide to Micros.

PERSONAL COMPUTER
DRAGON 64
 New life for an old friend?
 FREE THIS WEEK

Issue 40, December 8-December 14.
Pro-Tests: Times 2008, Thermal Printing TP-10, Cambridge Computing (Spectrum), Beeb-sport, Synthesis Music System (BBC), Vizavizite/Vizaspell (64), Education games (Spectrum).
Gameplay: Pinball Wizard (Vic 20), The Basics of Merrygold (64), Wavy Savage Pond (Atari).
Programs: Link Four (Spectrum), TIB (Dragon).
Microspedia: Buyer's Guide to Peripherals.

Issue 41, December 15-December 21.
Pro-Tests: Apple IIe, Byte Drive 500, INMAC Power Cleaner, Commodore 1701 Colour Monitor, BC:Base (64), Database-MST-Calc (Dragon).
Features: Psychotrophy (BBC), Spectrum Display.
Gameplay: Microbol/Pettigree's Diary (Dragon), 64 rounder, Dimension Destroyers/Super Panic (Spectrum).
Programs: Colony Invader (Spectrum), Grid Bike (Vic 20).
Microspedia: Buyer's Guide to Software.

Issue 42, December 22-January 4.
Pro-Tests: Spectrum add-ons (I-Microcomputers system), Oracle Fleeter, Games Designer (Spectrum).
Features: Microw of 1983, Computer Security, BBC word processing, Dragon Action part 4.
Gameplay: International Football (64), Grouch/Quequered Flag (Spectrum), Way Out/Bot Jack (Atari), Supervaders/Outback (Vic 20), Danger Ranger/Lip/Periscope (Dragon 32).
Databases: Clubnet.
Microspedia: Games Special.

Issue 43, January 7.
Pro-Tests: IBM Junior, Grafpad (BBC), Walters WMS0 printer Display (Spectrum).
Features: Compuserpac, Spectrum Display, Tabs on Orc.
Gameplay: Trace Race/Pinball (Dragon 32), Colour Genie roundup, Hunter Killer/Mr. Wimpy (Spectrum), Crazy Cavern/Goodness Gracious (64).
Programs: Jungle Chase (Spectrum), Screen Dump (BBC).
Databases: Hardware.
Microspedia: Electron part 1.

Issue 44, January 14.
Pro-Tests: Hitachi MBE-16002, Acorn Teletext (BBC), Integrex Colourjet printer, DTL-Base (64), DiamMicroprint 425/1/Multifont (Spectrum).
Features: Adventure games, Colourscape (Commodore 64).
Gameplay: Devil Assault/Wasps + Dragon Racer (Dragon 32), Siriven City/Fordshades Forest (64), Survival/Countdown (Vic 20).
Programs: Minifield.
Databases: Peripherals.
Microspedia: Electron part 2.

Issue 45, January 21.
Pro-Tests: Fortables - Commodore SX60, Olivetti M10, Acorn sparkjet printer, Turbo 20 daisy-wheel (Spectrum), Atari/Commodore 64 round-up.
Features: Bargain buys; Making money with your micros.
Gameplay: Viking and Pub Crawl (Dragon), Traxx and Wild West Hero (Spectrum), Atari/Commodore 64 round-up.
Programs: Battletank Fighter (Commodore 64).
Databases: Software.
Microspedia: Electron part 3.

PERSONAL COMPUTER
PC/EOMP
 Another world in the marketplace

Issue 46, January 28.
Pro-Tests: Atari/MSX/MIB: BBC sideways ROM board; IEEE interfaces for Commodore 64; Silver Reed EX44 typewriter/printer; Bridge on Spectrum and Dragon; BBC filing program.
Features: Buying by mail order; programming the Memotech.
Gameplay: Barry Burgers and Gargles (Spectrum), Binde Barage and Plankwalk (BBC), Blue Moon and Dancing Feats (Commodore 64).
Programs: Caves of Treasure (ZNS).
Clubnet
Microspedia: Modems and communications.

Issue 47, February 4.
Pro-Tests: Sinclair QL; Atari Touch Tablet; Silver Reed EXP500 daisy-wheel; IBM Cobot; BBC Spell Check.
Features: Programming the Memotech part 2; Low cost printers.
Gameplay: Mothership and Outsize Warrior (Commodore 64), Two Gun Turtle and Multigames (Orc), Apple adventures, Dragon roundup.
Programs: Pot Hole (Dragon).
Databases: Hardware.
Microspedia: A to Z of Atari part 1.

PERSONAL COMPUTER
ATARI 800XL
 The first look at Sinclair's new OS!

Issue 48, February 11.
Pro-Tests: Spectravision 328; Atari 800XL; Dragon 3in disk drives; low cost monitors; Aztec C (Apple); BBC educational software.
Features: Sideways printing on Epson HX20.
Gameplay: Bedlam and Morris Meets the Bikers (Spectrum); Commodore 64 round-up; Zor-

gon's Kingdom and Flight Zero-One-Five (Vic 20).
Programs: Gridtrap (Lynx).
Databases: Peripherals.
Microspedia: A to Z of Atari part 2.

PERSONAL COMPUTER
ATARI 2600
 A new world in the marketplace

Issue 49, February 18.
Pro-Tests: Orc Atmos; tracker ball controllers, Spectrum speech synthesiser; Rainbow Writer (Dragon); Colour Genie assembler; Spectrum educational programs.
Features: Computer jargon; 42-column display on Spectrum.
Gameplay: Quidratt and Jetpac (Vic 20), Crayn Ballons and Supacatchatropa (Commodore 64).
Programs: Sprite generator (Commodore 64).
Databases: Software.
Microspedia: A to Z of Atari part 3.

Issue 50, February 25.
Pro-Tests: Sanyo MBC50; Commodore speech synthesiser; BBC real-time control interface; Beech machine code trace; Atari home utilities.
Features: Expanding your Spectrum; introduction to Lisp.
Gameplay: Livian Upiatt and Godzilla and the Martians (Spectrum), Shurtlaze and Hooked (Dragon).
Programs: Minscape (Orc).
Clubnet
Microspedia: Printers part 1.

Issue 51, March 3.
Pro-Tests: Sharp's PC500; Graphics Package (Orc), Fancy Font (CP-M, Torch), Superbase Application Database (64), Printer Board roundup, IEEE 486 Interface (BBC).
Features: Microdrive data files.
Gameplay: Spectrum selection, Robopods (TTP/4A), Batty Builders/Bradex (Atari).
Programs: Millipede (BBC/Electron).
Databases: Hardware.
Microspedia: Printers, part 2.

Issue 52, March 10.
Pro-Tests: Wren, MSX, Multisynth 64, Mr T's Number Games etc (BBC), Spectrum, 64, Hybridcable (Orc, Atom).
Features: Adventure games.
Gameplay: Dragon roundup, Snorter/Free Fall (BBC), Spectrum roundup.
Programs: UFO (Vic 20), Morse Code (BBC), Gary the Guitarr (64).
Databases: Peripherals.
Microspedia: Printer, part 3.

Issue 53, March 17.

Pro-Tests: Yamaha Y1550, Tandy TRS-80 model (RS232), MDPDFS (BBC), Toolkit (BBC), The Quail (Spectrum).
Features: Screen technology, Atari graphics.
Gameplay: Megahawk/Megawarz (64), Castle of Doom/Fly Fish-Business (Dragon 32).
Programs: Battle Stations (Spectrum), Atari graphics, 64 round-up.
Databases: Software.
Microspedia: Reaching for the Atmos, part 1.

Issue 54, March 24.
Pro-Tests: IBM's Portable PC; Spectrum keyboards, Beebfont, Games Designer (Vic-20).
Features: Atari graphics, Chip shortage.
Gameplay: Almirite 2/Pole Position (Spectrum), BBC roundup.
Programs: Othello (64), Charpatt (CGL M-5).
Clubnet: User groups and clubs.
Microspedia: Atmos, part 2.

PERSONAL COMPUTER
ATARI 2600
 A new world in the marketplace

Issue 55, March 31.
Pro-Test: H-P 150, Light pens (BBC), 64, Micro-Prolog (Spectrum), Electron Graphics System.
Features: Spectrum routines, Consumer reports.
Gameplay: Patience/Metagalactic Llamas Battle at the Edge of Time (Vic-20), Loko/Rat Split (Orc), Tennis (Atari).
Programs: Fast Draw (Dragon 32), Flash simulator (Atari).
Databases: Communications, part 1.

Issue 56, April 7.
Pro-Tests: Vorzax Type 'n' Talk, Micro Commodore (BBC, Spectrum, 64), Commodore 1001 disk drive, Apple's Macintosh, Animator (Dragon 32), Knoware (IBM).
Features: Spectrum maths, Adventure in history.
Gameplay: Hunchback Aztec Challenge (64), Defence Force/Psycho II (Orc), Volcanic Planet (Spectrum).
Programs: Ape King (Vic-20), MIX VAP.
Databases: Peripherals.
Microspedia: Communications, part 2.

Issue 57, April 14.
Pro-Tests: Microkey, Morex Disk Drive Interface (Spectrum), Atari 800 colour printer/dotter, FT Monizey (IBM PC, Sirius).
Features: Assembly course, Portable.
Gameplay: Learning games (Spectrum), Orc, Air Traffic Control

Super Spy (Dragon), Neptune's

Issue 58, April 21.
Pro-Tests: Wip, Bit Rabbit, Fruit Apple graphics, EdwardBBC word processor, Bynamic Graphics/Picasso/Melbourne Draw graphics toolkits on Spectrum, Premier Sprite board for Dragon.
Features: Commodore 64 extended Basic, Microdrives made easy.
Programs: C-File database for Spectrum 486.
Microspedia: Spectrum 64, BBC games reviewed.

Issue 59, April 28.
Pro-Tests: Grid Compass, Husky Hunter, Canon X-07, Apple Homeworld, Commodore 64/CP-M, Dragon Sprite Magic, Atari printers, Minor Miracles modem.
Features: Assembly language.
Programs: Huebner for Orc.
Microspedia: Spectrum, BBC, Dragon, Atari games reviewed.

Issue 60, May 5.
Pro-Tests: TRS80 4P portable, BBC Disk Doctor, Spectrum Tasword II, Quinkey keyboard, Bob robot.
Features: Orc FILL, Commodore Gameplay; Flytron and Red Baron (Spectrum), Avenger and Dragon Hawk (Dragon), Colour Genie round-up.
Programs: Poison Touch on Commodore 64, Orc and Atari.

Issue 61, May 19.
Pro-Tests: Epson XZ-88, Apple Pro-DOS, Commodore 64 Colossus 2 chess, Dragon Sprint compiler, Solidisk RAM expansion for Spectrum.
Features: Artificial intelligence, assembler Pt 3.
Gameplay: Atari round-up, Commodore 64 round-up, Quest and Operation Atlantis (Spectrum).
Programs: IBM/Commodore 3D graphics, Orc renumber, Commodore 64 split screen graphics.

Issue 62, May 26.
Pro-Tests: Compaq, Dragon OS9, Spectrum educational packages, ExpressBase II, BBC baggies, Commodore 64 kuala graphics pad.
Features: Spectrum sound, jagged peripherals.
Gameplay: Rapedes and 1984 (Spectrum), House of Death and Operation Gremlin (Orc).
Programs: Dragon hi-res graphics, Commodore 64 graphics, Spectrum array sort.

Issue 63, June 2.
Pro-Tests: Apple IIc, Sord IS11, Canon dot matrix printer, Orc disk drives, Acorn 6802 processor and Bistonic graphics system, Dragon sound packages, Commodore 64 Microkey system.
Features: Orc Budget, assembler Pt 4.
Gameplay: Galactic Warriors, Magic Meannies (Spectrum), Flying Feathers and Plumb Crazy (Commodore 64).
Programs: Orc assembler/dissembler.

ORDER FORM

Any one issue is 75p, additional copies 55p, post & packing inclusive. Overseas readers please add £1 per copy airmail postage. Please allow up to 21 days delivery.

Name Telephone (day)

Street

Town Post Code

Please send me issues of PCN, issue nos I enclose my cheque/PO made payable to Personal Computer News or please debit my credit card: Visa/Access/Amex/Diners

Card no Signature

Send to: PCN Back Issues Service, 53-55 Frith Street, London W1A 2HG.

Mating game

Myles na' Copaleen, erstwhile doyen of the columns of the Irish Times, once held that it was immoral to use a bicycle of the wrong sex, and that furthermore there was a danger of bicycle and owner merging to result in some weird, wheeled, centaur-like creature. Little did he know that the computer age would spawn a new menace to public morality.

Inmac is not a company with a reputation for immorality, but its Shielded Gender Changers could well change all that. With scant regard for public decency the company says: 'One mates two male RS232 (V24) connectors and the other joins two females.' Not if one was brought up properly, one doesn't.

But that's not the half of it. 'Change your gender without in-

terference with Inmac's Shielded Gender Changers.' The National Health Service may be a little hard-pressed for operations of this sort, but we should stress that Inmac does not have one single practising GP on the board. We call on PCN readers to start a public outcry by phoning them on Run-corn 67551.

SLANTAX ERRORS

The programs listing for Mult in issue 64 is missing the following user-defined graphics:

Line 55 "AB AB"
56 "AB"
620 "C"
920 "DE"
960 "F"

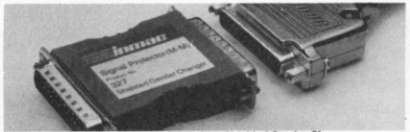

On show — Inmac has proudly released its Shielded Gender Changers.

Over the wall...

Apple's Macintosh week is over but the traces remain. Or perhaps it was true love that inspired the graffiti in a dingy subway at London's Baker Street station: 'Mac/Lisa'.

NEXT WEEK

Encore Scoop! — We give you an exclusive look at the portable that Osborne hopes will bring it back into the limelight.

Take a Memo — Thinking of text processing on a Memotech? Little Noddy is one possibility.

Hobbit guide — Find your way around the Hobbit and Urban Ustart with this adventurer's guide.

Electron joy — First Byte's joystick interface gets in early for Electron

arcade game players.

Towards 2000 — We Pro-Test Tandy's PC-compatible Model 2000.

Gameplay — Under review this week are games for the Spectrum and the Dragon.

Programs — Orc users can drum up some support with our free listing.

Meet me in a phone booth

The murky world of the organised software pirate was explored recently by Vault Corporation, developer of the copyright protection device Protok.

Vault personnel replied to an ad in the Los Angeles Times where 'any IBM software' was offered at \$25 a shot.

The phone number in the ad proved to lead to an answering machine, but Vault's message was answered later by a gentleman who outlined plans for the completion of the transaction — to take place in a telephone booth.

The transaction duly took place and the company came away with its illegally copied software. But \$25, outrageously cheap for some IBM software, proved to be \$25 more than it was worth — the disks couldn't be made to work. 'Maybe the crime was fraud rather than piracy,' said a Vault executive.



PCN DATELINES

PCN Datelines keeps you in touch with up-coming events. Make sure you enter them in your diary.

Organisers who would like details of coming events included in

PCN Datelines should send the information at least one month before the event. Write to PCN Datelines, Personal Computer News, 62 Oxford Street, London W1A 2HG.

UK EVENTS

Event	Dates	Venue	Organisers
National Conference and Exhibition on Computers in Personnel Networks '84	June 26-28	Royal Lancaster Hotel, London	Peter Merrington Exhibitions 0277 232030
PC User Show	July 3-5	Wembley Complex	Online Conferences 01-868 4466
Microtrade '84	July 3-5	Novotel Hotel, London W6	Daniel Evans 01-837 3699 ext 244
Artificial Intelligence for Society Conference	July 4-6	Barbican, London	Montbault Ltd 01-486 1951
What Micro? Computer Show	July 6	Brighton Polytechnic	Dr Gill, 0273 693655
Electron & BBC Micro User Show	July 14-15	Battersea Park, London SW11	Sue Holiday, VNU, 01-636 6890
Advanced Technology	July 19-22	Alexandra Palace, London	Database Publications, 061-456 8383
Acorn User Exhibition	August 9-13	St George's Hall, Liverpool	Advanced Technology, 051-236 0121
Electron & BBC Micro User Show	August 16-19	Olympia, London	Computer Marketplace Exhibitions 01-930 1612
Computers in Action	August 31-Sep 2	UMIST, Manchester	Database Publications, 061-456 8383
	October 30-Nov 1	Anderson Centre, Glasgow	Trade Exhibitions, 0764 4204

OVERSEAS EVENTS

Event	Dates	Venue	Organisers
National Computer Conference and Exhibition	July 9-12	Las Vegas, USA	American Federation of Information Processing Societies Inc. 0101 703 620 8900

EDITORIAL: Editor Cyndy Miles **Managing editor** Peter Worlock **Sub editors** Harriet Arnold, Leah Batham **News editor** David Guest **News writer** Ralph Bancroft **Features editor** John Lettice **Software editor** Bryan Skinner **Peripherals editor** Kenn Garroch **Hardware editor** Stuart Cook **Programs editor** Nickie Robinson **Art director** Jim Damsie **Art editor** David Robinson **Assistant art editor** Floyd Savers **Publisher** Mark Eisen **Publishing assistant** Jenny Dunne **Group publisher** John Cade **Publishing Admin** Jackie Searle

ADVERTISING: Group advertising manager Duncan Brown **Advertisement manager** Bettina Williams **Assistant advertisement manager** Sarah Barron **Sales executives** Christian McCarthy, Laura Cade, Paul Evans, Debbie Quinn, Yvonne Charatynowicz **Production** Noel O'Sullivan **Advertisement assistant** Karen Isaac **Subscription enquiries** Gill Stevens

Subscription address 53 Frith Street London W1A 2HG 01-439 4242 **Editorial address** 62 Oxford Street London W1A 2HG, 01-636 6890 **Advertising address** 62 Oxford Street London W1A 2HG 01-323 3211 **Published by** VNU, Business Publications, Evelyn House, 62 Oxford Street London W1A 2HG © VNU 1983. No material may be reproduced in whole or in part without written consent from the copyright holders. Photoset by Quickest, 184-186 Old Street, London EC1. Printed by Chase Web Offset, St Austell, Cornwall. Distributed by Seymour Press, 334 Brixton Road, London SW9, 01-733 4444. Registered at the PO as a newspaper

WIN! THIS FABULOUS GOLDEN TREASURE, THE FAMOUS GOLDEN JEWELLED HARE OF 'MASQUERADE' OR £30,000

WITH
HARERAISER
FROM
HARESFT



HARERAISER is an intriguing puzzle of animated graphics and text produced in 2 parts, purchasers of which will have the necessary information and be eligible for entry into a competition to discover the location of the Hare. To avoid desecration of the countryside, the treasure has not been buried, the winner merely having to pinpoint its location, to claim this superb prize. Part 1, *Hareraiser (Prelude)* is on sale NOW. Part 2, *Hareraiser (Finale)* from mid-September. (Both parts can be ordered on one application). This is a **UNIQUE** opportunity, you or your family could solve this adventure puzzle and win this beautiful treasure. Be sure of your participation. Order NOW and avoid disappointment. Finders keepers!

HARESFT LTD. P.O. Box 365, London NW1 7JD. Tel: 01-388 3910

I enclose my cheque/P.O. (No.) made payable to Haresoft Ltd. for £

or please debit my Access Card No.

Name Signature

Address

Post Code Tel: Date

SUTTLE FOR	BBCB	ORIC/ATMOS 48	DRAGON 32
SPECTRUM 48	CBM 64	VIC 20 EX	AMSTRAD

COMPUTER	PRELUDE/FINALE	QTY.	PRICE	TOTAL
			8.95	
			8.95	
			8.95	

48 hour despatch.

Price incl. p & p U.K. only

A World Of Information

Available to you with Nightingale, the new multi-function modem from Pace.

Nightingale is by far the most versatile modem available, at the price, for either home or business use. It offers Prestel/Viewdata baud rates (1200/75 & 75/1200) alongside 300/300 baud full duplex for communication between the BBC and other computers, including bulletin boards.

Nightingale will operate at both European and Bell frequencies for compatibility with CCITT and American systems.

The state-of-the-art modem chip technology employed in Nightingale requires minimal support circuitry resulting in low power consumption, low cost, high quality and extreme reliability.

Nightingale being 'hard wired' is not subject to the noise interference errors common to outdated acoustically coupled devices. In addition Nightingale features a simple self test facility for easy installation.

Nightingale utilises a fully buffered RS 423/232 serial interface and is supplied complete with a lead suitable for connection to the BBC micro, other leads are available on request.

However, in order to use such a versatile modem to its fullest potential, you will require equally sophisticated software. This is where Pace can offer you a total solution — Commstar, unquestionably the most comprehensive communications software available for the BBC.

Supplied on Eprom, Commstar is instantly accessible, simple to use and extremely flexible. Just look at the possibilities:— access Prestel, Micronet, Viewfax, Homelink and Telecom Gold, rummage through bulletin boards and chat to literally thousands of other computer users, but there's more. Commstar can be used to emulate specific terminal types such as VT 100 by means of a configuration disc, thus providing the opportunity to use the BBC as an inexpensive workstation for a main frame or mini-computer.

The complete Nightingale/Commstar package for the BBC micro including the modem, cabling and the Commstar Eprom and manual is just £139 plus V.A.T. Nightingale is available separately for the BBC and other computers at £119 plus V.A.T. and Commstar is £29.57 plus V.A.T. Further details are available, please telephone or write for comprehensive fact sheets.



PACE

PACE SOFTWARE LTD.
92 NEW CROSS STREET,
BRADFORD BD5 8BS.
Tel. (0274) 729306 Telex 51564

This modem incorporates the very latest in communication technology and is therefore not yet B.A.B.T. approved.

