

Personal Computer

ADD
SOUND TO
YOUR MICRO

US \$2.00/F £8.80/LIRE 1700/DM 3.80/FL 4.00/BFr 59
DKr 10.75/SKr 7.65/NKr 10.50/A Sch 28/S Fr 3.50/Pts 136

World

OCTOBER 1980 60p

EUROPE'S LEADING MICRO MAGAZINE



ON COURSE FOR ATARI
Exclusive UK test of the new generation of home computers

The best computers PLUS the best service

At MicroCentre, we're concentrating our resources on what we genuinely believe are the very best computers available today... Cromemco computers, naturally. This way we can offer you the best deal possible.

What we don't do

What we don't do is spread our expertise thinly amongst umpteen different systems, or try to stock every S100 product on the market. We don't claim to offer "impartial" advice on the best buy. And we don't sell from price lists or catalogues.

The MicroCentre approach

Some micro-computer suppliers work like that, but we don't. Because we realise that when you're buying a computer you want more than the "brochures and boxes" approach. You want to see computers running; to try them out with different software products; to study the documentation; above all, you want expert answers to your most searching questions.

Cromemco specialists

That's why we've specialised in Cromemco systems. Not simply because we think Cromemco systems are the best serious computers available at the price.

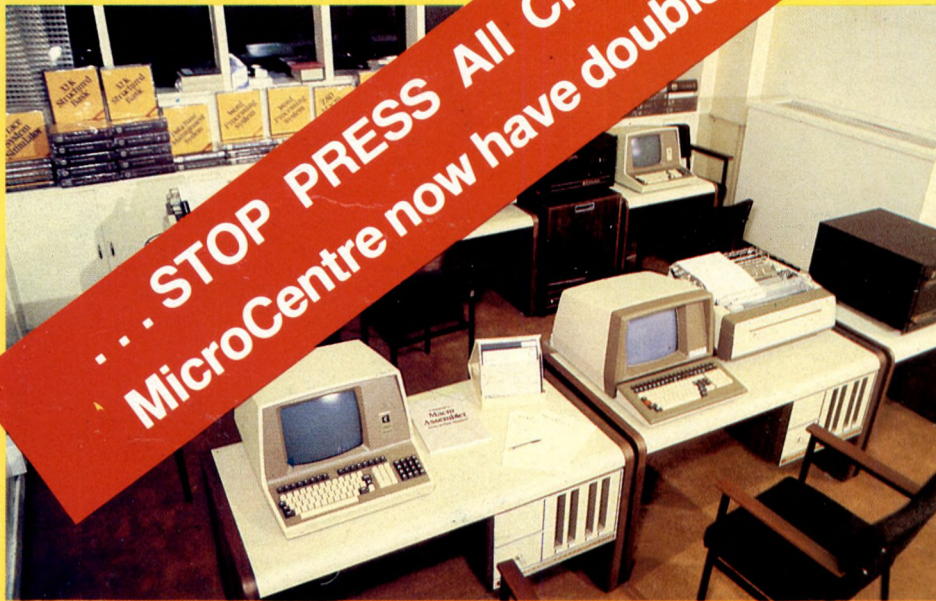

MicroCentre's Cromemco demonstration room, with the full range of Cromemco computers, peripherals, operating systems and software products on permanent exhibition. Why not pay us a visit? We're only an hour's Shuttle flight from Heathrow!



Cromemco Model Z-2H hard disc computer system. Includes Z-80 computer and 64K memory. MicroCentre also stocks a range of floppy discs.

But because by doing so we can offer you the highest standard of support possible. Expect the full range of our time, energy and resources to be devoted to Cromemco peripherals; single-user and multi-user systems; and interactive graphics.

Dem

Expect to find a permanent

Software

Expect a choice of operating systems and compilers to evaluate; expect complete documentation; and expect the largest collection of Cromemco systems software in the UK.

Expertise

Expect to find in-depth professional expertise at MicroCentre, the kind that is only acquired by installing Cromemco systems all over Britain. Expect a thorough appreciation of how Cromemco systems can be applied... in business, scientific research, industrial engineering, medicine and education.

Support

Expect to get frank, accurate answers to your questions at MicroCentre. Above all, once you've bought a Cromemco system from us, expect to get a very high standard of technical support with your hardware enhancements and continuing software needs.

At MicroCentre, simply expect the best.

For  **Cromemco... call the experts**

**NOW IN SPACIOUS
NEW SHOWROOMS**

Tel. 031-556 7354

Micro Centre

**STILL IN
CENTRAL EDINBURGH**

Complete Micro Systems Ltd., 30 Dundas Street, Edinburgh EH3 6JN

CONTENTS

Volume 3 No 10 October 1980

Founder
Angelo Zgorelec

Editor
David Tebbutt

Deputy Editor
Peter Rodwell

Executive Editor
Bruce Sawford

Editorial Office
01-637 7991

Consultants
John Coll, Mike Dennis,
Michael James, David Heb-
ditch, Sheridan Williams,
Dr Adrian Stokes, Dr
Stephen Castell.

Advertisement Manager
Stephen England
01-631 1786

**Advertisement
Executive**
Patrick Dolan
01-636 4463

Micromart
Jacquie Hancock
01-631 1682

Group Advertising Director
Richard Howell 01-631
3187

Production Manager
Dick Pountain

Art Director
Paul Carpenter

Art Editor
Julia Hunt

Art Assistants
Shelley Gray
Sarah Castell

Typesetter
Jane Hammell

Published by Sportscene
Publishers (PCW) Ltd., 14
Rathbone Place, London
W1P 1DE, England. Tel:
01-637 7991/2/3. Telex:
8954139 A/B 'Bunch' G
London.

Copyright notice
Personal Computer World is
published by Sportscene Pub-
lishers (PCW) Ltd. © 1980
Felden Productions. No
material may be reproduced
in whole or part without
written consent from the
copyright holders.

Printed by Riverside Press
Whitstable.

36 NEWSPRINT: Guy Kewney reports in his unique style.

43 YANKEE DOODLES: Tom Williams mounts his Californian soapbox.

45 COMMUNICATION: Our readers in their own write.

47 BACK ISSUES: Find out what you've missed!

48 SOUND ADVICE: Add sound to your micro — David Harper tells how.

55 CALIFORNIAN JOLLY: Visit the 6th West Coast Faire!

57 ANOTHER DIMENSION: Give your graphics three dimensions.

60 BOOKFARE: Malcolm Peltu reviews the latest offerings for micronovices.

63 BENCHTEST: Exclusive first-ever British tests of Atari's new machines.

72 BENCHTEST: Another PCW first — Sue Eisenbach tests the DAI.

77 GATEWAYS TO LOGIC: Continuing Derrick Daines' unique guide to teaching microcomputing to others.

82 PARKINSON'S PEP-UP: Speed up your programs the David Parkinson way.

85 COMPUTER GAMES: David Levy continues his look at computer chess.

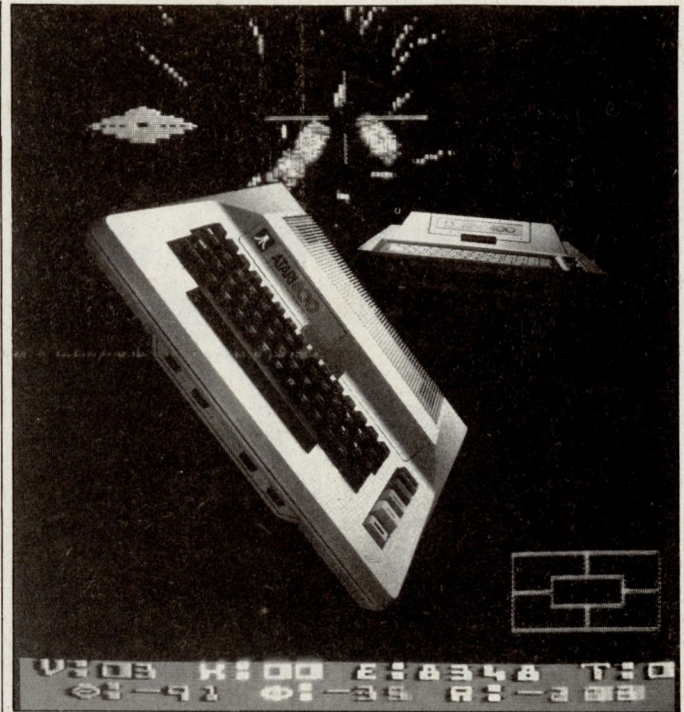

Cover photography Ian Dobbie

88 COMPUTER ANSWERS: Sheridan Williams and his team answer your queries.

92 HELPING THE HANDICAPPED: A look at a US company specialising in this field.

95 MICROCHESS: Our resident expert, Kevin O'Connell, reports.

97 YOUNG COMPUTER WORLD: Especially for you younger readers.

99 ROBOTICS: Les Solomon with a 'think piece' on computer-controlled robots.

105 CALCULATOR CORNER: Dick Pountain reviews a remarkable book.

106 FACE TO FACE: David Hebditch looks at formatted dialogues.

107 BENCHMARKS: What they do and what they mean.

108 PCW SUB SET: Alan Toothill presents some more useful subroutines.

111 SYSTEMS ANALYSIS: Continuing Lyn Antill's series for the would-be micro user.

114 NEWCOMERS START HERE: Our quick intro to the world of microcomputing.

115 DIRECT ACCESS: With IN STORE, USER GROUPS, DIARY DATA and TRANSACTION FILE.

124 PROGRAMS: More offerings from our readers.

131 LEISURE LINES: J J Clessa poses more problems.

131 BLUNDERS: We confess all.

167 CHIP CHAT: Europe's leading microgossip page.

Freedom for the PET... and the busy user.

Now PET users can achieve previously 'impossible' configurations without recourse to tedious machine code routines.



THE KC NETKIT

A new concept hardware/firmware package from Kingston.

We're in the age of day to day communications between computers—and the age of tight budgeting.

The KC Netkit hardware/firmware package from Kingston comes to your aid by dramatically widening the scope of the PET without great additional cost.

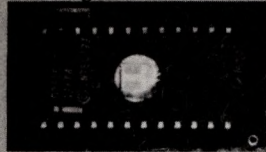

The core of the Netkit system is an ingenious instruction set on ROM.

IEEE 488 port. It assists busy or inexperienced programmers with ten new SERIAL BASIC commands, enabling them to achieve previously 'impossible' configurations without hours of tedious machine code routines.

The PET can now act as a smart or dumb terminal which can accommodate

How does it work? It frees the PET from many of the limitations associated with the creation of RS232C (V24) serial access via the

most of the protocol and character conversion that the user may require. Using the KC Netkit, the PET can now exchange data and programme files freely. It can be remotely controlled and can open up a wide range of high speed networking. It can be grouped with other PETs to achieve greater real time number cracking power.

More Powerful. In short it makes the PET a more powerful beast...bringing electronic mail and data retrieval systems like Viewdata,

multi-access and user applications and inter-office data transfer within the range of PET users.

The KC Netkit is British designed and

developed by the manufacturers, Kingston Computers, part of the £25m Dale Electric Group, who make standby power systems for industrial-type computers.

The new product is the result of months of intensive research and development work and comes to the PET user only after thorough and prolonged testing. There is a generous 12 month parts and labour guarantee, backed by your dealer, Kingston Computers and the Dale Group. The KC Netkit comes in a

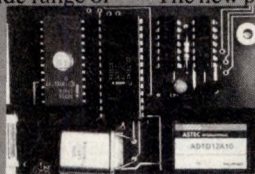

All British design — and built for quality and reliability.

handsome black enamel, all-round case for easy handling. Just plug in, at the PET memory expansion connection and to one of the free ROM sockets with a ribbon cable, and you're on the way to working PET in a network.

A visiting computer enthusiast said "the sky's the limit" with KC Netkit and the Basic Serial PET. That's with anything except the price.

From £135, the KC Netkit is an inexpensive way to extend and develop your PET system without additional cost or trouble.

See your Kingston dealer, or write directly to Kingston Computers for more details, name and address of dealer or distributor.

The KC Netkit from just £135.
A dramatic new freedom for the PET. COMPLETE THE COUPON TODAY.

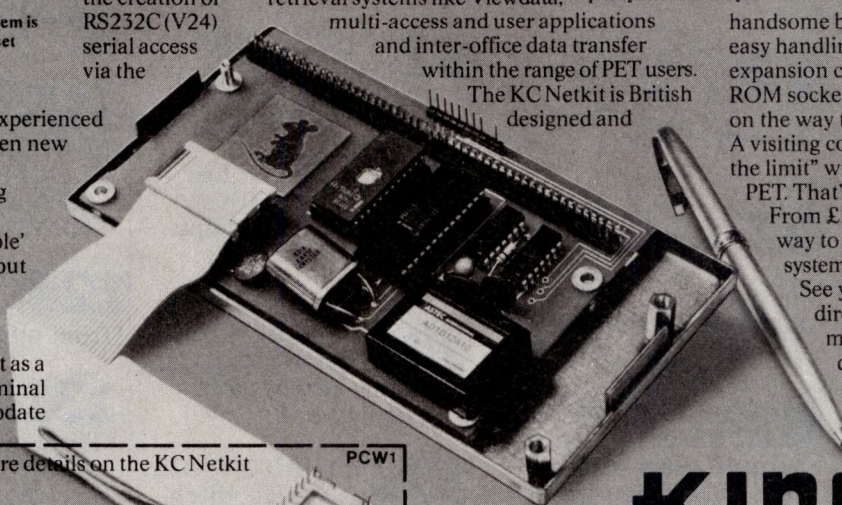

Please send me more details on the KC Netkit

PCW1

Name

Address

Kingston Computers Limited, Scarborough House, Scarborough Road, Bridlington YO16 5NS. Telephone: 0262 73036.

KINGSTON

ideas and products to extend
your system inexpensively.

Kingston Computers Limited, Scarborough House, Scarborough Road, Bridlington YO16 5NS. Telephone: 0262 73036

& Computers & Peripherals

Leading-make hardware
at hard-to-beat prices

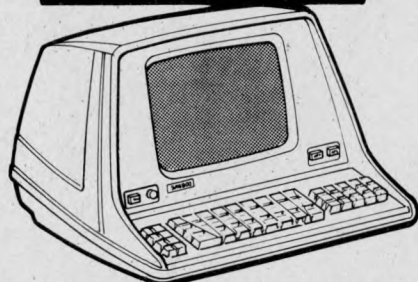
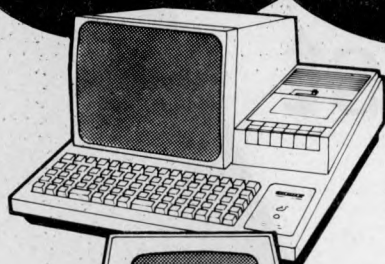

Model	User Ram	£
Sharp MZ80K		
20K	6K	380.00
36K	22K	423.00
48K	34K	475.00
MZ80FD	Twin floppy disk drive	650.00
MZ80P3	Matrix Printer	431.00
MZ801/0	Expansion Interface	83.00
PC1211	Pocket Computer	83.25
CE121	Cassette Interface for PC1211	11.75
Commodore		
2001-8	Integral Cassette/small keyboard	367.00
3008	8K with full size keyboard	389.00
3016	16K with full size keyboard	454.00
3032	32K with full size keyboard	600.00
3040	Twin 5 1/4" Disk drive	600.00
3022	80 Col. 93cps Tractor printer	367.00
3023	80 col. 93cps Friction printer	325.00
C2N	Add on cassette deck	48.00
	Computer to disk cable	18.00
	Disk to printer cable	22.00

For full retail price list and
Conditions of Sale relating to these
offers, contact

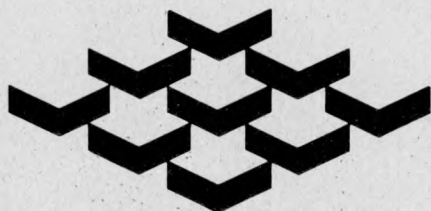

HB COMPUTERS

22 Newland Street
Kettering
Northamptonshire
Telephone 0536 520910
Telex 341297

ACT 800 Series

ACT 808	Computer and 800K disk system	2950.00
ACT 824	Computer and 2.4M disk system	3750.00
ACT 400	400K PET disk	625.00
ACT 800	800K PET disk	795.00
ACT 1.6	1.6M PET disk	995.00

Printers

Teletype 43 Pinfeed. 30cps	775.00
Decwriter LA34 Friction Feed. 30cps	775.00
Qume Sprint 5 45 RO	1518.00
Qume Sprint 5 55 RO	1605.00
Qume Sprint 5 45 SKR	1695.00
Qume Sprint 5 55 KSR	1810.00
Ricoh RP 1600 Daisywheel (PET interface)	1025.00
Ricoh RP 1600 Daisywheel (HITYPE interface)	900.00
Centronics 702	1300.00

Array Processing from Silicon Glen on the West Coast of Scotland

Video Vector Dynamics Ltd announce what will be one of the most significant innovations in microcomputing during the 1980's — The VP 9500 Vector Processor.

For more details contact:

**Video Vector Dynamics Ltd
39 Hope Street,
Glasgow G2 6AE
Telephone number 041-226 3481/2**

REMEMBER THIS ?



THE PETMASTER SUPERCHIP

JUST LOOK AT WHAT YOU WILL BE ABLE TO DO WHEN YOU PLUG IN YOUR PETMASTER SUPERCHIP.

- Automatic repeat facility on all keys or just insert/delete, space and the cursor movement keys
- Adjustable repeat delay/speed
- Graphics/lower case toggle
- Variable cursor flash speed
- Scroll screen up or down
- Escape from quote mode
- Erase line up to cursor
- Erase line from cursor
- Insert or delete line

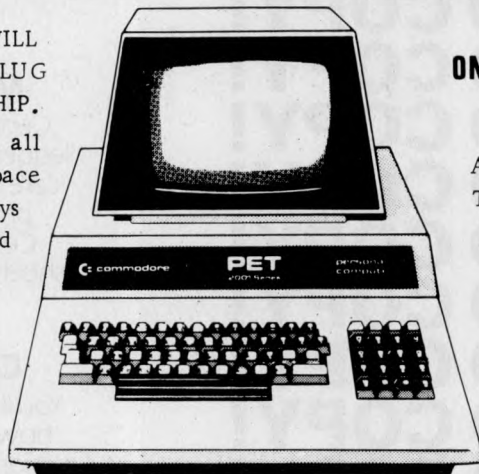

ONLY **£45** PLUS VAT

ADD COUNTLESS NEW FEATURES TO YOUR EXISTING MACHINE : Many of the SUPERCHIP's useful functions are similar to those only available on the new 8000 series Superpets. And most may be accessed either from the keyboard or from Basic.

WRITE NOW FOR MORE DETAILS

PLUS

- SINGLE KEY ENTRY OF 26 OF THE LONGEST AND MOST COMMON BASIC WORDS
- RETRACE FACILITY WHICH ENABLES YOU TO DISPLAY AT ANY TIME THE LAST 10 LINES EXECUTED. OTHERWISE RETRACE IS INVISIBLE TO THE USER :
- 'SHRINK' routine which eliminates REMs and unnecessary spaces from your program
- 'REVERSE' routine which reverses any part of the screen (black/white to white/black)
- 'MOVIT' subroutine for instantaneous transfer of any area of memory

Fits in 3rd. spare ROM socket

TOOLKIT COMPATIBLE !

NEW ROM VERSION AVAILABLE NOW

OLD ROM OWNERS WRITE FOR DETAILS



SUPERSOFT

28 Burwood Avenue - Eastcote - Pinner - Middlesex
Phone 01-866 3326 anytime

THAT WAS THE AD THAT STARTED IT ALL (PCW August, page 154)

SINCE THEN HUNDREDS OF PET/CBM OWNERS HAVE BEEN DISCOVERING THE FULL POTENTIAL OF THEIR MACHINES

WE TOO, HERE AT SUPERSOFT, HAVE BEEN FINDING OUT MORE

see what we've added !

- 10 USER-DEFINABLE FUNCTION KEYS
- USER-DEFINABLE MESSAGE (instantly accessible)
- SCROLL WINDOW FACILITY (protect up to 24 lines at the top of the screen while scrolling the rest)

AND, BY THE WAY, ANYBODY WHO BOUGHT THE ORIGINAL VERSION HAS BEEN OFFERED A FREE EXCHANGE FOR THE NEW MODEL

Old & New ROM available

Now available on Earth



THE SHARP MZ-80 COMPUTER SYSTEM

Sharp have been associated with many major advances in electronic technology in space and here on Earth. We have introduced the most sophisticated production techniques for electronic circuitry to set world renowned standards of reliability into every product.

That's why the MZ-80K and its range of peripherals is going to change the way you think about microcomputers. The Sharp MZ-80 System now includes the MZ-80K processor backed with the MZ-80FD dual drive, double sided mini-floppy disk unit to give rapid, effective, sequential and random access, to huge amounts of stored information with incredibly fast response times.

Our new MZ-80P3 printer makes a good impression as well. Its fine definition dot matrix

head prints across 80 columns, at 100 characters per second, with full graphics capabilities.

The Sharp MZ-80 System is a new approach to computer applications, and their efficient use by human beings.

Our aim is to make computers and their related equipment relatively simple and therefore better understood and better used by those they are designed to serve.

Whether you are looking for a business system, or a system for educational or personal use—take a look at Sharp, it will change the way you think about computers.

Send me details of the complete Sharp MZ-80 System and the name and address of my nearest stockist

Name _____

Address _____

PCW10

Sharp Electronics (UK) Limited, Sharp House, Thorp Road, Newton Heath, Manchester. M10 9BE Tel: 061-205 2333



COMPUTER APPLICATIONS

Buying the right apple software to do the job, at the right price, can be a job in itself!

But it doesn't have to be.

Micro Management now have available a comprehensive range of quality software for business and commercial applications. Each package is user-tested before being released, and when released, carries our own guarantee. Software of such a high standard at a realistic price is hard to find, so end your search by asking for Micro Management software.

Micro Management software is available from your nearest dealer, or direct from us. We also offer a tailor-made service to suit your company's individual requirements.



13-15 Connaught Avenue, Frinton-on-Sea, Essex. Tel: (02556) 4592 and 32 Princes Street, Ipswich, Suffolk. Tel: (0473) 57871

PAYROLL

The Micro Management Payroll offers the following facilities and benefits:

- Credit Transfers
 - Pay Slips
 - Day Books
 - Cash Breakdown
 - Dept Analysis
 - Year End Print Out
 - Average of 100 Employees in 10 minutes
 - Six Variable Additions/Deductions
 - All Tax Codes
 - Easy Tax Changes
 - Operator Code Protected
 - No Computer Knowledge Needed
- Only £145 incl. p&p (ex VAT)

6502 PROGRAMMERS

Owing to company expansion we have vacancies for experienced assembler programmers who are fluent in 6502 code and willing to work at home.

Applications are invited for full time employment and for contract work. Outstanding salaries are available for outstanding personnel.

Please write, enclosing full C.V., to:
David Levy,
Philidor Software,
104 Hamilton Terrace,
London NW8 9UP.

COMPUTERS FOR HOME BUSINESS EDUCATION

WIDE RANGE OF ELECTRONIC GAMES

Exidy Sorcerer

16K - £860 32K - £918 48K - £976
S100 Expansion Box 6-slot - £276.00
Micropolis Dual Disc Drive - £1,380.00
NEC Spinwriter (receive only) - £2185

Z-89 ALL-IN-ONE COMPUTER

The new all-in-one computer from Zenith is the most versatile micro-computer available today.
• 'Intelligent' video terminal • two Z80 microprocessors • floppy disc storage system • expandable to 48K RAM
Easy to programme. Simple to operate. It is capable of a multitude of high-speed functions and speaks the language of today's most popular software. Price from £1805



The most advanced microcomputer yet.

WH 14 SERIAL PRINTER
With a compact table top configuration, the WH-14 is designed for a broad variety of uses in any computing environment.



Microprocessor based, it is compatible with any computer providing standard RS 232C or 20mA current loop interface connections. Price £596.50

Video 100
12" BLACK & WHITE LOW COST VIDEO MONITOR
£90.00



RADAT 5" 10 MHz Scopes
only £189.00
SELECTION OF SOFTWARE GAMES & BUSINESS

5K FLOPPY DISK for TRS 80 Team FD50A Single Drive £267.50 Dual Drive £506.00 Integral Power Supply



TRS80 LEVEL 2 18K only £440 K8D only expansion box 32k £340.00

Large range of computers etc. books. Send for List SAE with all enquiries - All prices inclusive.
SUPPLIERS TO BUSINESS, EDUCATION & HEALTH AUTHORITIES



N.I.C

Day 01-808 0377
Eve 01-889 9736



Base 2

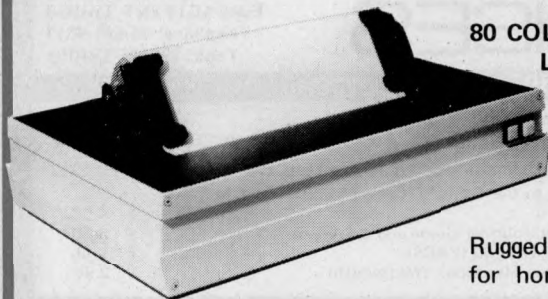

80 COLUMN HIGH PERFORMANCE
LOW COST IMPACT PRINTER

The ideal companion for PET, Apple, TRS80, Exidy, Superboard, Compukit and most Micro's.

Rugged metal enclosure makes it ideal for home computing, small business systems, data logging etc.

Look at these standard features:

- * RS-232, 20mA, IEEE488 and Centronics I/O
- * 16 baud rates to 9600
- * 60 lines per minute - Bidirectional
- * 6 print densities - 64, 72, 80, 96, 120 or 132 characters per line
- * Self test switch
- * 96 character ASCII Standard

- * Auxilliary User Defined Character set
- * Accepts 8½" max paper - pressure feed
- 9½" max paper - tractor feed
- * Tractor & Fast Paper Feed/Graphics
- * 2k Buffer

ONLY £359 + VAT

Compukit UK101 DISC DRIVES

with up to 32k RAM expansion

free games disc

NEW

- * 9 Digit extended Basic
- * Plugs straight into 8k Compukit requires no hardware mods. (5v.5A required for 610)
- 610 Expansion (8k) ONLY £159 + VAT
- Disc Drive with DOS ONLY £285 + VAT

Oki Microline 80



Small, light, quiet matrix printer.

40, 80 or 132 cols.

6 or 8 lines per inch.

96 ASC II + 64 graphics character set with Centronics compatible interface

£425 + VAT
RS232 version available.

Axiom - Ex 850 VIDEO PRINTER

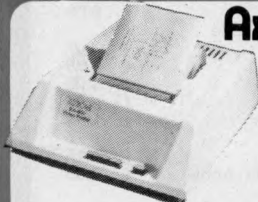

Composite Video I/P or separate

£790 + VAT

The EX-850 Video Printer sets new standards for flexibility in low cost printing. By using a unique video controller, the EX-850 dispenses with the need for any interfacing between the user's CRT display/terminal and printer.

Ohio Superboard II & Challenger 1P

- the no fuss start to Micro's.

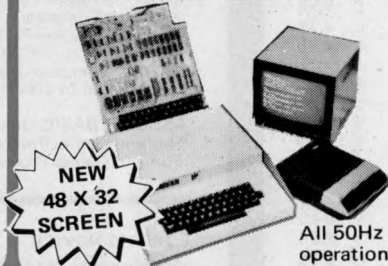

NEW 48 X 32 SCREEN

All 50Hz operation

* Ready Built *8k Microsoft in ROM, 6 digit floating point basic plus full features.

SUPERBOARD II.	£159 +VAT
SUPERBOARD II (48x32).	£199 +VAT
POWER SUPPLY 5v. 3A	£27 +VAT
CASE	£29 +VAT
CHALLENGER 1P (Cased SII)	£215 +VAT
CHALLENGER 1P (48x32)	£255 +VAT
STATIC RAM 2114, 1-12 each	£3 +VAT
13+ each	£2.50 +VAT

Mauro

MP-250 GRAPHIC PLOTTER

£499 + VAT

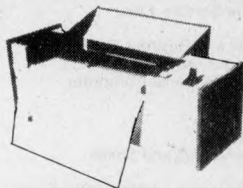

Ideal for educational, hobby and industrial use. Plots on standard paper sheet size up to 11" x 17". Plotting speed 2.5" per sec. Optional I/P RS232 Direct Apple or TRS80 interface.

Qume Sprint 5

- Daisywheel quality printer.

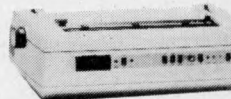

50 different type styles including APL, Scientific symbols and International character sets. 43 Qume defined commands for operating control. Built in diagnostics. Serial or parallel. £1595 + VAT

LOW COST BUSINESS/PROFESSIONAL USE

Anacom 150

150 CPS, 15" carriage, dot matrix printer

- an unbelievable £699 + VAT



NEW

The ANACOM 150 is a highly dependable receive only printing terminal.

The features include:

- * 150 characters per second
- * 9 x 9 dot matrix
- * 10 characters per inch horizontal
- * 6 or 8 lines per inch vertical.
- * 136 columns, 13.6" line length
- * 94 ASCII Characters
- * Upper and lower case with decs.
- * Double width chrs. programmable
- * 1.5" to 15" wide paper
- * Programmable top of form feed
- * Original + 4 copies
- * Centronics and/or RS232 Interface 110-9600 baud
- 256 character buffer

Mighty Micro

for a Mighty good deal !!!

Please add V.A.T. at 15%. Carriage extra, will advise at time of order. Official orders welcome.

61 NEW MARKET SQ., BASINGSTOKE, HANTS. RG21 1HWC Tel: 0256 56468 & 56417 also in association with O.S.I. COMPUTERS, ESHER, SURREY. Telephone: 0372 62071

Buy in confidence. If on receipt of your order the goods do not meet with your satisfaction, return within 7 days for full refund. Credit facilities arranged.



Mail Order, Visits,
Trade Enquiries
Welcome, Credit
Card Orders Accepted
by telephone/telex.
Payment must be in
sterling on UK Bank.

ENTERPRISES

Room PCW
8 Cambridge House
Cambridge Road, Barking
Essex IG11 8NT, England.
Telephone: 01-591 6511
Telex: 892395 LPRISE

BOOKS/MAGAZINES/SUBSCRIPTIONS

BY OSBORNE

Introduction to Microcomputers Series

Vol 0: Beginners Book	£ 5.95
Vol 1: BASIC Concepts	£ 6.30
Vol 2: Some Real Microprocessors (without binder)	£ 18.95
Vol 2: Some Real Microprocessors (with binder)	£ 24.70
Vol 2: Updating supplement set Nos. 1-6	£ 18.95
Vol 3: Some Real Support Devices (without binder)	£ 11.95
Vol 3: Some Real Support Devices (with binder)	£ 17.70
Vol 3: Updating supplement set Nos. 1-6	£ 18.95
1 binder (Specify for Vol 2 or 3)	£ 5.75
1 Updating supplement (Specify for Vol 2 or 3)	£ 4.00
PET and the IEEE 488 (GPIB) bus	£ 9.95
6800 Programming for Logic Design	£ 6.30
8080 Programming for Logic Design	£ 6.30
Z80 Programming for Logic Design	£ 6.30
Z80 Assembly Language Programming	£ 8.15
6502 Assembly Language Programming	£ 8.25
8080A/8085 Assembly Language Programming	£ 7.95
6800 Assembly Language Programming	£ 7.95
Accounts Payable and Accounts Receivable (specify Wang or CBASIC)	£ 13.15
Payroll with Cost Accounting (Specify Wang or CBASIC)	£ 13.50
General Ledger (Specify Wang or CBASIC)	£ 12.25
Some Common BASIC Programs	£ 7.95
Running Wild	£ 2.50

GENERAL

See Magazines and Subscriptions!

See Osborne Books!

Microprocessors from Chips to System	£ 7.00
Microprocessor Interfacing Techniques	£ 9.95
Cheap Video Cookbook	£ 4.30
IC OP-AMP Cookbook	£ 8.95
RTL Cookbook	£ 4.25
Ciarcias Circuit Cellar	£ 5.50
Buyers Guide to Microsoftware	£ 2.40
Calculating with BASIC	£ 3.95
Computer Programs that Work (In BASIC)	£ 3.95
Dr Dobbs Journal, Volume 1	£ 13.95
Dr Dobbs Journal, Volume 2	£ 13.95
Dr Dobbs Journal, Volume 3	£ 13.95
Best of BYTE	£ 8.95
Soelbi BYTE Primer	£ 8.95
Best of Creative Computing, Vol 1	£ 6.95
Best of Creative Computing, Vol 2	£ 6.95
Program Design	£ 4.25
Programming Techniques: Simulation	£ 4.25
Numbers in Theory and Practice (A BYTE publication)	£ 5.50
PIMS - A Database Management System	£ 5.95
Best of Interface Age - Software	£ 9.95
Programming the Z8000	TBA
Microsoft BASIC University Software Inc., (listings)	
Home and Economics Programs	£ 15.00
Education and Scientific Programs	£ 20.95
Small Business Programs	£ 29.50

CONCERNING LANGUAGE

SCALBAL - BASIC Language Interpreter (Source Code)	£ 15.00
Instant BASIC	£ 6.95
Basic BASIC	£ 6.50
Advanced BASIC	£ 6.00
My Computer likes me... when I speak in BASIC	£ 2.75
Users Guide to North Star BASIC	£ 10.00
A Practical Introduction to PASCAL	£ 3.95
Microsoft BASIC (A guide)	£ 6.50
Secret Guide to Computers	£ 4.00

FOR THE 6800

See Magazines and Subscriptions!

See Osborne Books!

6800 Software Gourmet Guide & Cookbook	£ 7.15
6800 Tracer - An aid to 6800 Program Debugging	£ 3.95
Tiny Assembler	£ 5.75
RA 6800 ML - An M600 Relocatable Macro Assembler	£ 15.95
Link 68 - An M6800 Linking Loader	£ 5.50
MONDEB - An Advanced M6800 Monitor Debugger	£ 3.50

FOR THE 8080

See Osborne Books!

8080 Programmers Pocket Guide	£ 1.95
8080 Hex Code Card	£ 1.95
8080 Octal Code Card	£ 1.95
8080 Software Gourmet Guide & Cookbook	£ 7.15
8080/8085 Software Design	£ 6.75
8080 Standard Monitor	£ 9.95
8080 Standard Assembler	£ 9.95
8080 Standard Editor	£ 9.95
8080 Special Package: Monitor, Editor, Assembler	£ 20.00
BASEX: A Simple Language and Compiler for the 8080	£ 5.50

FOR THE Z80

See Osborne books!

32 BASIC Programs for the TRS-80 (Level III) 16k	£ 10.10
Introduction to the T-bug (TRS-80 Machine Lang. Monitor discussion)	£ 4.50
Z80 Software Gourmet Guide and Cookbook	£ 8.50
Programming the Z80 (ZACS)	£ 9.95
Z80 Instruction Handbook (Wadsworth)	£ 2.95

FOR THE 6502

See Magazines and Subscriptions

See Osborne Books

Best of Micro, Vol 1	£ 5.50
Best of Micro, Vol 2	£ 5.50
Programming the 6502 (Zacs)	£ 7.95
6502 Applications	£ 7.95
6502 Software Gourmet Guide and Cookbook	£ 7.25
32 BASIC Programs for the PET	£ 10.10
First Book of KIM	£ 7.00

FOR FUN

Starship Simulation	£ 4.50
SARGON - A Chess Game (for the Z80)	£ 9.50
BASIC Computer Games	£ 5.00
More BASIC Computer Games	£ 5.50
What to do After you Hit Return	£ 8.95
8080 Galaxy Game	£ 6.95
SUPER-WUMPUS - A game in 6800 Assembler Code & BASIC	£ 4.25
Computer Music Book	£ 6.75
Computer Rage (A board game)	£ 6.95
Artist and Computer	£ 3.95
Games, Tricks and Puzzles for a Hand Calculator	£ 2.49
Introduction to TRS-80 Graphics	£ 5.75
Take My Computer Please... (Fiction)	£ 3.25
Introduction to Low Resolution Graphics for Pet, Apple, TRS80	£ 5.50
Microsoft BASIC University Software Inc., (listings)	
Fun and Games Programs 1	£ 9.50
Fun and Games Programs 2	£ 9.50

FOR THE NOVICE

See Magazines and Subscriptions!

See Osborne Books!

How To Make Money With Your Microcomputer	£ 5.75
From the Counter to the Bottom Line	£ 10.00
Your Home Computer	£ 5.95
Introduction to Personal and Business Computing	£ 5.50
Getting involved with Your Own Computer	£ 5.50
How to Profit from Your Personal Computer	£ 5.50
Microcomputer Potpourri	£ 1.95
Hobby Computers are Here	£ 3.95
New Hobby Computers	£ 3.95
Understanding Microcomputers and Small Computer Systems	£ 6.95
Understanding Microcomputers and Small Computer Systems and Audio Cassette	£ 8.75
Getting Down to Business With Your Microcomputer	£ 5.50

MAGAZINE BACK ISSUES

Micro 6502 Journal	£ 1.75
Personal Computing	£ 1.95
Interface Age	£ 2.95
Dr Dobbs Journal	£ 1.95
Computer Music Journal	£ 3.75
Recreational Computing	£ 1.95
BYTE	£ 2.95
Creative Computing	£ 1.95
Calculators and Computers	£ 1.95
Kilobaud Microcomputers	£ 2.95
Compute - for the 6502	£ 1.95
68' Micro	£ 1.95
80-Microcomputing	£ 2.25
On Computing	£ 1.95
Compute II - for the Single Board	£ 1.95
Magazine Storage Box (Holds 12)	£ 1.50
S-100 Microcomputing (For CP/M Users)	£ 1.75

MAGAZINE SUBSCRIPTIONS (all processed within 3 weeks)

Micro 6502 Journal	(12 issues)	£ 13.50
68 Micro	(12 issues)	£ 17.50
Personal Computing	(12 issues)	£ 17.50
Interface Age	(12 issues)	£ 25.50
Dr. Dobbs Journal	(10 issues)	£ 15.00
Recreational Computing	(6 issues)	£ 10.50
BYTE	(12 issues)	£ 25.00
Creative Computing	(12 issues)	£ 17.00
Kilobaud Microcomputing	(12 issues)	£ 22.00
Compute for the 6502	(6 issues)	£ 10.50
80' Microcomputing	(12 issues)	£ 21.00
Compute II - for the Single Board	(6 issues)	£ 10.50
S-100 Microcomputing (For CP/M Users)	(6 issues)	£ 9.50

Mail Order, Visits,
Trade Enquiries
Welcome, Credit
Card Orders Accepted
by telephone/telex.
Payment must be in
sterling on UK Bank.

L.P. ENTERPRISES

Room PCW
8 Cambridge House
Cambridge Road, Barking
Essex IG11 8NT, England.
Telephone: 01-591 6511
Telex: 892395 LPRISE

SOFTWARE

	Software & manual	Manual only
BYROM SOFTWARE <i>Software & Manual/Manual only</i> BSTAM - Utility to link one microcomputer to another also using BSTAM		£70/5
COMPUTER PLUS FMS 80 (File Management System) Demo Pack (includes manual and disc) Complete System		£35 £395/25
COMPUTER SERVICES Bidirectional driver for Diablo Hytype printers for use on CPM & CDOS systems		£65/10
CP/M USER LIBRARY 42 Volumes on 8" disc 42 Volumes on 5" disc		£4 £8
CREATIVE COMPUTING For CP/M CS-9001 BASIC Computer Games disc 1 CS-9002 BASIC Computer Games disc 2 CS-9000 Both discs purchased together		£12 £12 £20
DIGITAL RESEARCH (Most formats now available) MPM 1.1 CP/M 1.4 CP/M 2.2 SID ZSID MAC TEX DESPOOL PL/1		£175/18 £65/18 £90/18 £45/12 £55/12 £55/15 £45/12 £30/5 TBA
INFORMATION UNLIMITED WHATSIT (Database Management System) on North Star on CP/M on APPLE 2:48k (requires int Basic) on Apple 2:32k (requires int Basic) on ITT 2020 (see Apple)		£59 £75 £72 £59
KLH SYSTEMS Spooler for CPM systems		£65/5
L.P. ENTERPRISES Diablo driver runs 110 to 9600 baud with autoloader for CP/M or CDOS OMNIX - UNIX like multiuser, multiasking operating system for Z80 i.e. IMS, Cromemco, Horizon MULTIFORTH		£30/5 £250/30 £65/20
MICAH INC. CP/M for CDOS Users: Program to Expand CP/M system to be compatible with Cromemco CDOS software Disc Utilities: Pack one of CDOS users includes: Fast disc copy, Track test, Disc test, Compare files and others Pack two for CP/M users includes same as pack one Pack three for Cromemco users includes same as pack one and spool and print		£59/5 £30/5 £30/5 £65/5
MICROSOFT INC. <i>Software & Manual/Manual only</i> BASIC-80 BASIC Compiler FORTRAN-80 COBOL-80 EDIT-80 MACRO-80		£175/17 £195/17 £220/17 £355/17 £45/11 £80/11
MICHAEL SHRAYER INC. Electric Pencil Word Processor SSII for tty etc DSII for Diablo TRS-80 Cassette/disc		£100 £105 £50
MICROFOCUS LTD. CIS COBOL version 4.2 FORMS 2		£425/25 £100/10

	Software & manual	Manual only
MICROPRO INC. WORD-MASTER 1.7 TEX-WRITER 2.6 WORD-STAR 2.00 SUPER-SORT: version 1 version 2 version 3 WORD-STAR/MAIL MERGE DATASTAR		£70/20 £35/15 £240/25 £120/20 £100/20 £75/20 £310/25 £165/25
NORTHSHARE Multi-user system for Horizon Users		£24/5
SOFTWARE SYSTEMS (compiler systems) CBASIC v2.05		£65/15
SOFTWARE WORKS Northstar Format Only Inventory-1 (Stock Control) Inventory-2 with order entry, invoicing Mailroom Preventive Maintenance Housekeeper-2 (Coming soon)		£50/10 £130/15 £50/10 £75/15 £TBA
STRUCTURED SYSTEMS Sales Ledger Purchase Ledger Nominal Ledger Stock Control Letterright Analyst (File management Reporting System) NAD (Name and Address selection system) OSORT		£275/15 £275/15 £325/15 £275/15 £95/10 £115/10 £50/10 £50/10
TINY-C ASSOCIATES Tiny-C language for 8080, 8085, Z80 systems		£50/35
BYTE NYBBLE REPRINTS a) A TMS-9900 Monitor b) BASIC Cross-Reference Generator c) A Micro Word Processor d) 'Tiny' PASCAL in 8080 Assembly Language ('e' needed to use this) e) A 'Tiny' PASCAL Compiler f) An APL Interpreter in PASCAL g) Computer Assisted Flight Planning h) Computerized Wine Cellar		£ 3.50 £ 1.25 £ 4.50 £13.00 £13.50 £13.00 £ 2.35 £ 2.00
ORDER INFORMATION: Software prices reflect distribution on 8" single density discs. If a format is requested which requires additional discs a surcharge of £4 per additional disc will be added. Please add VAT and £2.50 for first class postage, packing and insurance. If required, DATAPOST D service is available for an extra charge of £7.50 + VAT. All software on this Advertisement is available from stock and a 24-hour return service is thereby offered on all prepaid orders. When ordering CP/M software please specify the format you require otherwise software will be dispatched on an 8" single density disc.		
OEM TERMS AVAILABLE For more information on any of these items, please phone, write or visit. (We are open during office hours).		
All publications are published in the U.S.A. and are stocked in Britain by L.P. Enterprises. Prepaid orders are despatched by return of post, or advice concerning.		
HOW TO ORDER: Send cash postal order, cheque or (Access/Barclaycard) No. to L.P. Enterprises, Room PCW, 11 Cambridge House, Cambridge Road, Barking, Essex IG11 8NT. All payment must be in Sterling and drawn against a U.K. bank.		
Due to fluctuations of the dollar, prices are subject to change without notice.		
TRADE ENQUIRERS WELCOME		

APPLE® II DISK DRIVES

DUAL DISK UNIT

£498

DISK CONTROLLER CARD

£ 49

- * Two Disks in one Cabinet
- * Has its own Power Supply Unit
- * Connects to standard Apple Disk Controller Card
- * Runs all Apple Software including Pascal
- * Japanese quality and reliability

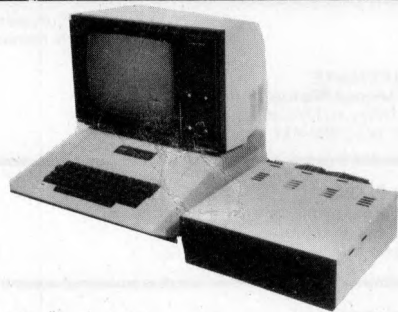

APPLE DEALERS:- Write or phone direct to Cumana and specifications plus dealer discounts will be mailed to you.

TRS-80® DISK DRIVES

DUAL DISK UNIT

2 x 40 Track Drives
2 x 77 Track Drives

£440
£645

SINGLE DISK UNIT

1 x 40 Track Drive
1 x 77 Track Drive

£236
£345

TRS 80 DISK CABLES

2 Drive Cable
4 Drive Cable

£20
£32.50

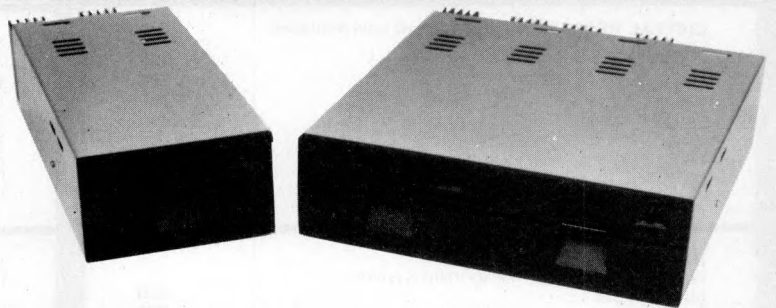

TRS-80 DEALERS:- Write or phone direct to Cumana and specifications plus dealer discounts will be mailed to you.

MAIL ORDER MINI FLOPPY DISK DRIVES

	Qty	Price Each
TEAC FD-50A 40 TRACK 5¼ inch	1-5	£155
DOUBLE/SINGLE DENSITY DRIVES	6-12	£145
PRICE INCLUDES WARRANTY, SPECIFICATION MANUAL AND MAINTENANCE MANUAL	13-25	£135

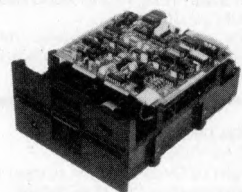

Call your nearest dealer for a demonstration:

RADIO SHACK LTD.,
188 Broadhurst Gardens,
LONDON NW6
Tel: 01-624-7174

**LONDON COMPUTER
CENTRE,** 43 Grafton Way,
LONDON W1.
Tel: 01-388-5721

MICRO CONTROL LTD.,
224 Edgeware Road,
LONDON W2
Tel: 01-402 8842

**TRANSAM COMPONENTS
LTD.,** 59-61 Theobalds Road,
LONDON WC1
Tel: 01-405-5240

N.I.C., 61 Broad Lane,
Tottenham, LONDON N15
Tel: 01-808-0377

EWL COMPUTERS LTD.,
8 Royal Crescent, GLASGOW
Tel: 041-332-7642

**KATANNA MANAGEMENT
SERVICES,** 22 Roughtons,
Galleywood, CHELMSFORD,
Tel: 0245-76127

ENSIGN, 13-19 Milford Street,
SWINDON, Wilts.
Tel: 0793-42615

SEVET TRADING,
14 St. Pauls Street,
BRISTOL 2.
Tel: 0272-697757

**HEWART MICRO-
ELECTRONICS,**
95 Blakelow Road,
MACCLESFIELD.
Tel: 0625-22030

**PORTABLE MICRO-
SYSTEMS,** 18 Market Place,
BRACKLEY, Northants.
Tel: 0280-702017

**CAMBRIDGE COMPUTER
STORE,** 1 Emmanuel Street,
CAMBRIDGE
Tel: 0223-65334

HARDEN MICROSYSTEMS,
28-30 Back Lord Street,
BLACKPOOL
Tel: 0253-27590

I.C. ELECTRONICS
Flagstones, Stede Quarter,
BIDDENDEN, Kent
Tel: 0580-291816

PARWEST LTD.,
58 Market Place,
CHIPPENHAM
Tel: 0249-2131

COMPUTERAMA LTD.,
5 Cleveland Place East,
LONDON ROAD, BATH
Tel: 0225-333232

COMPSHOP LTD.,
14 Station Road,
NEW BARNET, Herts.
Tel: 01-441 2922

CUMANA LTD 35 Walnut Tree Close, Guildford, Surrey, GU1 4UN.
Telephone: (0483) 503121. Telex: 859680 (Input G).

*Please add VAT to all prices.
Delivery at cost will be advised
at time of order.*

Does your computer do exactly what you want?

Most of them don't.

They use programmes that aren't sophisticated enough to adapt to a way of working that suits you best.

Now, though, there's a new programme called OZZ that's going to cause a revolution.

It runs on a standard Commodore 8032 system but performs functions that are far from standard.

It draws up file formats, stores and retrieves information, calculates, analyses and prints documents exactly the way you tell it to.

So at long last the computer is the quiet, ultra-efficient servant.

And you are the complete master. Even if you've never been near a computer before.

Now that's exactly what you want.

Contact:

BRISTOL SOFTWARE FACTORY

ST. MICHAELS HILL,
COTHAM, BRISTOL.

TEL: 0272 20801 TELEX:449477



For the first time you're in complete control.



SIRTON COMPUTERS

76 Godstone Road, Kenley (Nr Croydon)
Surrey CR2 5AA
Tel: 01-668 0761/2

MIDAS S100 SYSTEMS

MIDAS 1 : From £750
MIDAS 2 : From £1580
MIDAS 3 : From £2150
MIDAS 4 : From £5900

ITHACA-DPS 1 : From £1075

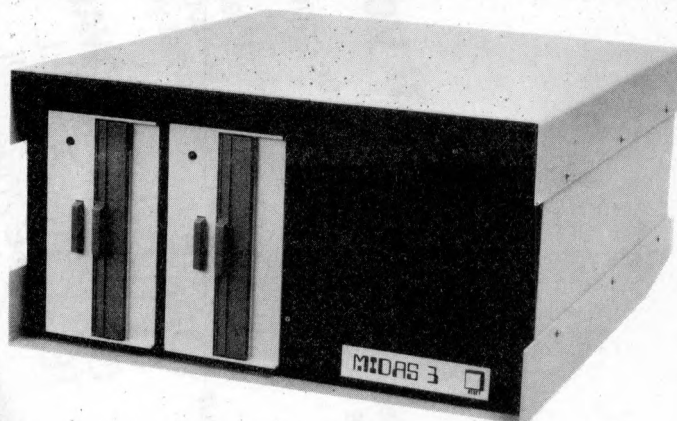

- Our versatile Z80 Microcomputers are available as standard units or custom configured to your exact specification from a comprehensive range of stocked S100 boards.
- Disc storage capacity of the MIDAS 3 can be 2M Bytes, expandable to over 20M Bytes with a Winchester Hard Disc Unit in our MIDAS 4 range.
- MIDAS runs CP/M and MP/M is also available. Other Software includes M-BASIC, C-BASIC, FORTRAN, COBOL, CIS-COBOL, PASCAL and Word Processing.
- A MIDAS 3, with 64K RAM and 2M Bytes storage on two 8" drives with two Serial I/O Ports and CP/M 2 only £2600.
- Printers, VDUs and other peripherals stocked to give complete package systems at keen prices.
- Business Packages include Accounts, Stock Control, Purchase Ledger etc etc.

Boards stocked from Ithaca, Godbout, SSM, S D Systems, Vector, Micromation Mullen, Mountain Hardware, Hi-Tech, Video Vector, Pickles & Trout, Central Data, Cromemco, Thinker Toys – Send for full Price List (many available in kit form).

PROCESSOR

Z80 Starter Kit	£188
SBC100	£208
SBC200	£237
Z80 CPU's4 MHz	from £130

EPROM

2708 EPROM (16K)	£60
2708/2716 Programmers from	£134

VIDEO

16 lines, 32/64 ch	from £104
24 Lines, 84 ch	from £265

DISC CONTROLLERS

Versafloppy S/D	£198
Doubler D/D	£280

SOFTWARE

CP/M 1 & 2, MP/M, PL/1, C-BASIC 2, M-BASIC V5, XYBASIC, FORTRAN 80, COBOL 80, CIS-COBAL, PASCAL/Z, PASCAL (UCSD), PASCAL M/T, Forth, MAC, ZSID, Disassembler, Wordstar, Datastar, Magic Wand, Wordmaster, Supersort etc etc.

RAM

Dynamic RAM 16K – 64K	from £205
Static RAM 8K – 64K	from £95
Memory Manager	£52

I/O

2S/4P prov 4K RAM/4K ROM	£169
2S/2P or 2S/4P or	
3P/1S or 4S/2P	from £135
Analogue 8 or 12 bit	from £287
Optically isolated I/O	£114
IEEE 488 Interface	£350

MISCELLANEOUS

Real Time Clock	£180
High Dens Graph/8K RAM	£333
Hi-Tech Colour	£295
Motherboards – various from	£34
Extender Board/logic probe	£39
Maths Board AMD 9511	£330

NEWBURY NEWBURY NEWBURY

Smart Micro-based Visual Display Terminals

24 lines of 80 characters per line. 96 ISO/ASCII character set. Dual interface - CCITT V24 and 20/60 mA current loop. Selectable half or full duplex. Green phosphor non glare display.

7000



Hard copy print out
Numeric pad
Video output for external monitors

7002

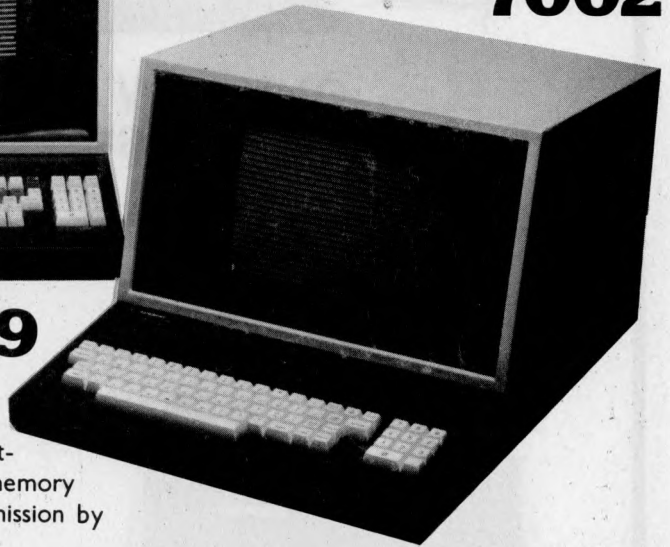

7007/9

Full keyboard editing features. Additional 6 pages of memory (7009). Block transmission by line or page.

Matrix Printer



125 cps printing speed
CCITT V24 (RS232) interface
80-132 characters per line
from **£460***

Prices from **£495***

Emulations:

APL, DEC VT52, ICL 7181 Honeywell
VIP 7006 & 7250

*Prices inclusive of delivery in UK and cables ready to plug in.

Free standing Monitor

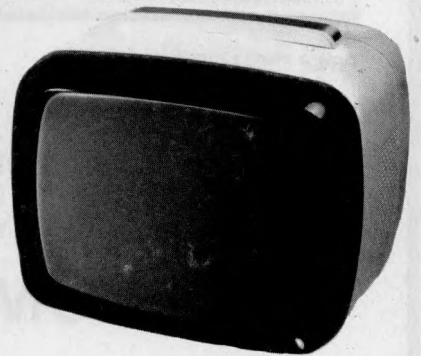

NEWBURY LABORATORIES LTD

Head Office & Sales:
King Street, Odiham, Hampshire RG25 1NN
Tel: 025-671 2910 Telex: 858815

Sales and Service:

North East Tel: York (0904) 412043
North West Tel: Stockport 061-491 0134
Midlands Tel: Birmingham 021-707 7170
East Anglia Tel: 0223 64862

WE HAVE MOVED

FROM



TO

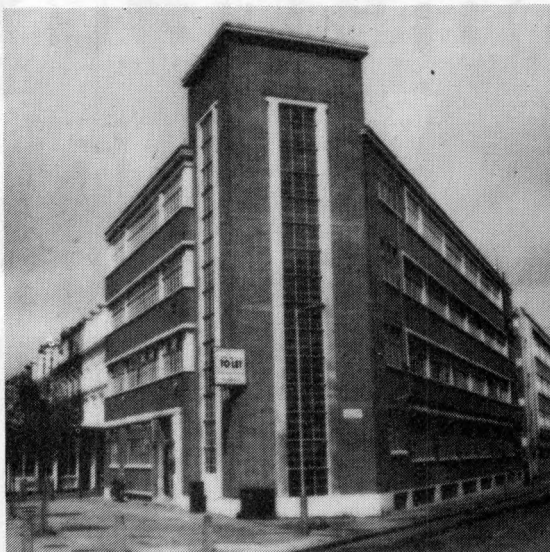

OUR NEW ACCOMMODATION IS IDEALLY SUITED FOR YOU TO SEE

THE LATEST DESKTOP
MICROCOMPUTER
HP 85

AND

THE LATEST POCKET COMPUTER
SHARP PC1211
COMPLETE WITH CASSETTE I/F

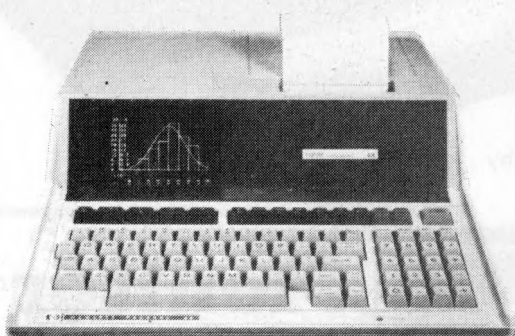

PRICE FROM £1830 + VAT



PRICE £117 inc. VAT & CARRIAGE COMPLETE

DEMONSTRATIONS BY APPOINTMENT AND ORDERS TAKEN BY PHONE.
government, EDUCATION AND COMPANY ORDERS ACCEPTED FOR THE ABOVE
AND MOST MAKES OF CALCULATORS AND MICROCOMPUTER SYSTEMS.
ACCESS AND BARCLAYCARD HOLDERS WELCOME.

SUMLOCK BONDAIN LTD

NEW ADDRESS:
263/269 CITY ROAD,
LONDON EC1V 1JX.
(700 Yards from Angel Underground)
PHONE: 01-250 0505
OR
TELEX: 299844

1.6 meg. disk on Pet



STACK NOW HAVE A
2 MEGABYTE
(1.6 megabyte formatted)
DISK FOR PET

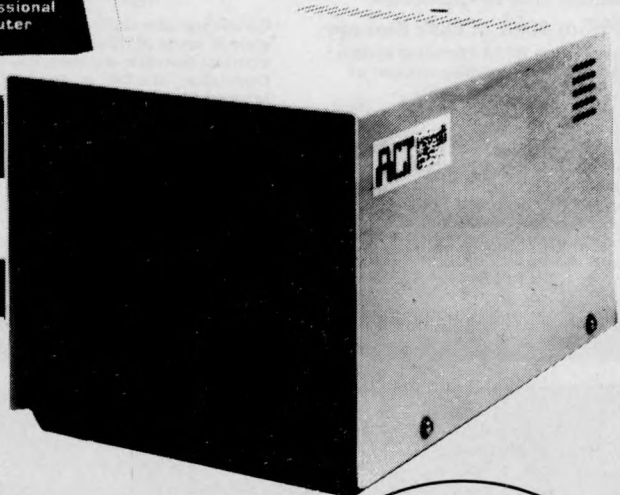

£1395 plus VAT

- * 5¼" Drives
- * 80 Track double density/double sided format
- * Data and program files
- * Random and Sequential Access
- * New improved Diskmon operating system
- * Improved error handling routines
- * Compatible with all existing software on 800K and 400K units
- * Ex-stock

Ring us
for availability
of an 80 column Pet
with the 1.6
megabyte
Computhink
Disk

FOR MORE INFORMATION CUT OUT THIS COUPON

I am interested in particular aspects of microcomputing
please send me details as new products appear.

Subjects of interest

- Pet
- Industrial
- Educational
- Consumables
- Apple
- Commercial
- Printers

Name _____

Address _____

Please send to **STACK COMPUTER SERVICES LTD**
290-298 Derby Road, Bootle, Liverpool 20.
Telephone 051-933 5511 for all your enquiries.



GW Computers Ltd

89 Bedford Court Mansions, Bedford Avenue, London W.C.1.
call only by appointment



SUPERBRAIN™

Intelligent Video Terminal Systems

350K or 700K of Disk Storage

SuperBrain's CP/M operating system boasts an overwhelming amount of available software in BASIC, FORTRAN, COBOL, and APL. Whatever your application . . . General Ledger, Accounts Receivable, Payroll, Inventory or Word Processing, SuperBrain is tops in its class. And the SuperBrain QD boasts the same powerful performance but also features a double-sided drive system to render more than 700K bytes of disk storage and a full 64K of RAM. All standard!

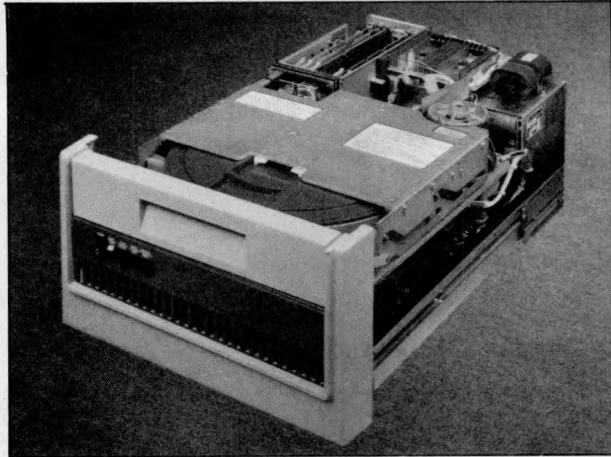

COMPUSTAR™

MULTI-USER TERMINAL SYSTEM

CompuStar user stations can be configured in a countless number of ways. A series of three intelligent-type terminals are offered. Each is a perfect cosmetic and electrical match to the system. The CompuStar 10-a 32K programmable RAM-based terminal (expandable to 64K) is just right if your requirement is a data entry or inquiry/response application. And, if your terminal heads are more sophisticated, select either our CompuStar 20 or CompuStar 40 as user stations. Both units offer dual disk storage in addition to the disk system in the CompuStar. The Model 20 features 32K of RAM (expandable to 64K) and 350K of disk storage. The Model 40 comes equipped with 64K of RAM and over 700K of disk storage. But, most importantly, no matter what your investment in hardware, the possibility of obsolescence or incompatibility is completely eliminated since user stations can be configured in any fashion you like — whenever you want — at amazingly low cost!

DISK STORAGE

Options for the Superbrain and CompuStar Video Terminal

"Backup" for the 20 megabyte Century Data drive is provided via the dual disk system housed in the CompuStar or the SuperBrain. The Control Data CMD Drive features a removable, front-in-sertable top loading cartridge of 16 megabyte capacity plus a fixed disk capacity of either 16 or 80 megabytes.

Each drive is shipped equipped with an EIA standard 19" rack mounting system and heavy duty chassis slide mechanisms to permit easy accessibility for fast and efficient servicing.

**** WIDELY USED IN UK AND USA ****
**** TESTED AND PROVEN ****
**** POWER AT YOUR FINGERTIPS ****
**** JUST COMPARE THIS LIST ****

No other program in the world combines these feature in one. Many other programs, less integrated, do not provide even some of those features to be found on our 'bus'.

- 1 = Total integration of sales 'purchase 'nominal 'stock 'addresses etc
- 2 = Full random access enables retrieval of any record in a second
- 3 = Flexibles prompts enables word change even to foreign language.
- 4 = Files may be named and set to drive default, maximising storage.
- 5 = Easy to use, menu driven, no serious need of manual.
- 6 = Tested and debugged in many installations world wide.
- 7 = Priced less than the acquisition of a library of programs.
- 8 = The program is *** totally *** in core, maximising disk space.
- 9 = Core program means that disks may be interchanged during use.
- 10 = Core program means your main drive is *** free *** for data
- 11 = Numerous reports may be generated (eg: sale ledgers up to 30).
- 12 = Invoice produces immediate stock update + double journal entry.
- 13 = Reference on invoices enable cost centre build-up on ledgers.
- 14 = Stock valuations and re-order reports easily generated.
- 15 = Bank balance and reports plus standard mailing facilities.
- 16 = Customer statements and invoices printed on plain paper

Also at: Gamma Data Systems, Dollard House, Wellington Quay,
Dublin 2. Tel Dublin 711877

***** MAIN MENU DISPLAY *****

**New! Produced in U.K. and widely used in England and the U.S.A.
Complete Business Package**

**INCLUDES EVERYTHING FROM INVENTORY TO SALES SUMMARY
PROMPTS USER AND VALIDATES ENTRIES. MENU DRIVEN**

BUS VER 3.00 TO ver 9.00 PET AND CP/M
APPROXIMATELY 60-100 ENTRIES/INPUTS REQUIRE 2-4 HOURS WEEKLY
AND ENTIRE BUSINESS IS UNDER CONTROL

* PROGRAMS ARE INTEGRATED .. SELECT FUNCTION BY NUMBER .. .

- | | |
|--------------------------------------|--|
| 01=*ENTER NAMES & ADDRESSES. | 13=*PRINT CUSTOMERS STATEMENTS |
| 02=*ENTER/PRINT INVOICES | 14=*PRINT SUPPLIER STATEMENTS |
| 03=*ENTER PURCHASES | 15=*PRINT AGENT STATEMENTS. |
| 04=*ENTER A'C RECEIVABLES | 16=*PRINT TAX STATEMENTS |
| 05=*ENTER A'C PAYABLES | 17=GENERAL HELP |
| 06=*ENTER' UPDATE INVENTORY. | 18=ALTER VOCABULARIES |
| 07=ENTER' UPDATE ORDERS | 19=PRINT YEAR AUDIT |
| 08=*ENTER' UPDATE BANKS | 20=PRINT PROFIT' LOSS A'C. |
| 09=*REPORT SALES LEDGER | 21=ENDMONTH MAINTENANCE. |
| 10=*REPORT PURCHASE LEDGER | 22=PRINT CASHFLOW FORECAST |
| 11=*INCOMPLETE RECORDS. | 23=ENTER PAYROLL (NO RELEASE) |
| 12=*EXAMINE PRODUCT SALES | 24=EXIT SYSTEM |

..... ENTER WHICH ONE?

DATABASE MANAGEMENT INCLUDES
*** FILE CREATE'DELETE'SEARCH *** RECORD CREATE'DELETE'SEARCH/4 OPTION PRINT *** RECORD
SORT ANY FIELD ALPHA OR NUMERIC *** INDEX SEARCH OR GENERAL SCAN'PRINT IN ANY FIELD (EG
TOWN OR NAME) *** 4 ARITHMETIC FUNCTIONS TO USE AS CALCULATOR ON LAST 4 FIELDS *** AUTO
CHECK TO PREVENT DOUBLE ENTRY TO FILE MANAGEMENT SYSTEM, DYNAMICALLY ALLOCATING
INFORMATION TO MINIMISE DISK SPACE CONSUMPTION

VERY FLEXIBLE, EASY TO USE

G.W. COMPUTERS U.K. ARE THE PRODUCERS OF THIS BEAUTIFUL PACKAGE

VER 3.00 (EXC PROG 19,20,22,23)=475.00, VER 4.00 INCLUDES AUTO STOCK-UPDATE=575.00, VER 5.00
INCLUDES AUTO BANK UPDATE=675.00, VER 6.00 IN CORE=875.00, VER 7.00 (INC 19,20,22,23) NOT YET
RELEASED=975.00, VER 8.00 RANDOM ACCESS=1000.00, VER 9.00 TRANSLATEABLE=1075.00 +++EACH
LEVEL OVERRIDES LOWER ONE

WE EXPORT TO ALL COUNTRIES CALLERS ONLY BY APPOINTMENT

CONTACT TONY WINTER ON 01-636 8210

89 BEDFORD COURT MANSIONS, BEDFORD AVENUE, LONDON W.C.1.

**NOTE!!! All versions, especially 9.00 use broad financial principles and 9.00 is
one 16K core program releasing both disk drives for data storage, as well as
being translateable into any foreign language**

**IMPORTANT!!! We also sell the hardware for the above tasks to enable the purchase from one source.
Note that A*** complete *** CBM system with Bus Ver 3 is 2215 pounds and A *** complete ***
superbrain system with bus ver 3 and dec printer is 3345 pounds.**

PET +	PET +	PET +	PET +	SOFTWARE	+	SOFTWARE	SUPERBRAIN	+	SUPERBRAIN
CBM 3032 32K			650.00	BUS VER 3.00		475.00	SUPERBRAIN 320K		1795.00
CBM 3040 DISKS			650.00	BUS VER 4.00		575.00	TWIN Z80 64K+CRT		
CBM 3022 PRINTER			425.00	BUS VER 5.00		675.00	+2 D'D-S'S DRIVE		
CBM 8032 32K			875.00	BUS VER 6.00		775.00	SUPERBRAIN 700K		2300.00
CBM 8050 1MEG DISKS			875.00	BUS VER 7.00		875.00	TWIN Z80 64K+CRT		
CBM EPSON PRINTER			395.00	BUS VER 8.00		900.00	+2 D'd-D'S DRIVE		
CBM MULTI USER			650.00	BUS VER 9.00		975.00	M'USER S'BRAIN		3950.00
CBM 3032 + EPSON +			0	CBM WORDPRO II		75.00	LINKS UP TO 16		
CBM 3040 + BUS V3			2215.00	CBM WORDPRO III		150.00	SUPERBRAINS ON		
				CPM WORD-STAR		250.00	MULTI TASKING		
PRINTERS	+	PRINTERS		CPM MBASIC 80		150.00	COMPUSTAR		
DIABLO 1650 40CPS		2150.00		CPM COBOL 80		320.00	16 MEG ADD-ON		3950.00
DOLPHIN 125CPS BD80		495.00		CPM PASCAL MT		150.00	S'BRAIN HARD DSK		
OKIDATA MICROLINE		575.00		CPM FORTRAN 80		200.00	INTERTUBE III		450.00
PAPER TIGER 195CPS		575.00		CPM DATASTAR		175.00	SUPERBRAIN 800K		
TELETYPE 43SR 30CPS		875.00		CPM PASCAL-M		250.00	TWIN Z80 32K + CRT		
DEC-LA34 TRACT 30CP		875.00		CPM BYSTAM S'BRAIN		75.00	+2 D'd - D's Drive		£1695.00
NEC-SPINWRITER		1595.00		CPM SUPERSORT		120.00			
QUME DAISY SPRINT5		1950.00		CPM BASIC COMPILER		190.00	TANDY MODEL II		1950.00
TEXAS 810 150		1390.00		CPM DESPOOL		30.00	APPLE II 16K		675.00
				CPM BYSTAM IMS'N-STAR		75.00	COMPUCOLOR 32K		1750.00
SPECIALS	+	SPECIALS		CPM TEXTWRITER		75.00	IEEE TO RS 232		150.00
N'STAR QUAD .7 MEG		1500.00		CPM POSTMASTER		75.00	IEEE TO PARALLEL		160.00
IMS 5000 48K D'D		1500.00		CPM SELECTOR 3		180.00	IEEE'RS232 BI'DI		195.00
COMPUTHINK * 800K *		795.00		CPM CBASIC		75.00	IEEE MODEM		295.00
2 WAY CRDLESS PHONE		£135.00		CPM MACRO 80		75.00	CAT MODEM		135.00
TELEPHONE ANSWER		230.00		CPM W'STAR M'MERGE		310.00			
SHUQART SA 400 DRIVE 5 1/4"		135.00					WARRANTY		
				BUS MANUAL *****		9.00	90 DAY FREE REPLACEMENT		

**SPECIAL INSTITUTION AND UNIVERSITY DISCOUNTS
STOCK AND COMING ROUND. (BARCLAYCARD WELCOME OTHERWISE
CHEQUE WITH ORDER)
CONTACT TONY WINTER 01-636 8210
89 BEDFORD CT MANS. BEDFORD AVE W.C.1.**

DON'T BUY A TOY . . .

. . . unless you just want to play around

BUY A SBS 8000 SYSTEM a real computer

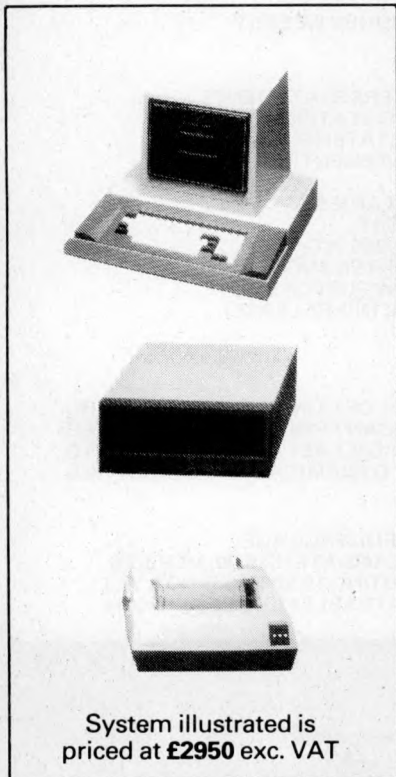

System illustrated is priced at £2950 exc. VAT

The SBS 800 is aimed at the business and educational markets and is unbeatable in its price/performance range. Here are just some of the features:—Z80 CPU, 64K memory, 80 key query type keyboard, mini or full size floppys, 12 inch screen, printer 5x7 matrix. Available shortly 24x80 green screen, larger printer Pascal, CP/M, business packages etc. The 24K super basic interactive, offers ease of operation and powerful disk operating commands. The system can handle long variable names (up to 253 significant characters), procedure calls with parameters (instead of GOSUB line number), special inkeys for interactive programming; it boasts unique page structure whereby up to 16 programmes can be stored in memory at the same time, 16 significant digits in double precision, 16 user defined keys, recursive programming where procedures can call themselves. Double sized characters can be easily utilised on the VDU and printer etc, etc.

For more details
contact . . .

MANHATTAN



SKYLINE LTD

SOUTH REACH,
DENFORD,
NORTHANTS, ENGLAND
Telephone:
Thrapston (080 12) 3442
Telex No. 341 445

aculab

floppy tape,

The tape that behaves like a disc,
For TRS-80 LEVEL II.

Connects directly to TRS-80 Level 2 Keyboard. Operating and file handling software in ROM. 8 commands add 12 powerful functions to Level 2 BASIC. No buttons, switches or volume controls. Full control of all functions from Keyboard or program. Daisy chain multiple drives. Certified digital tape in endless loop cartridges. Reads and writes in FM format at 9000 Baud. Soft sectored with parity and checksum error detection for highly reliable operation—just like discs. Maintains directory with up to 32 files on each tape, tapes may be write-protected. Supports Basic and machine-language program files, memory image and random access data files. 12 character filespecs —: "FILENAME/EXT:d" (d is drive no. 0-7). Automatic keyboard debounce. Full manual with programming examples and useful file-handling routines.

COMMANDS (usually followed with a filespec and possible parameter list).

@SAVE, @LOAD, @RUN —for BASIC programs, machine language programs and memory image files. **@GET, @PUT**

—moves a 256-byte record between a random access file and BASIC's data buffer. **@KILL** —removes a file from the directory and releases tape sectors for immediate re-use. **@LIST** —displays file directory along with sector allocation and free sectors. **@NEW** —formats tape and creates a blank directory.

Master drive with PSU, Manual and a selection of tapes.

£167-00 +£2-00 pp+vat.

Slave drives with PSU £122-00 +£2-00 pp+vat.

(Export orders pp charged at cost)



For further
information,
Telephone
0525 371393

aculab Ltd.
24 Heath Road,
Leighton Buzzard,
Beds. LU7 8AB

**WE HAVE ALL THE NEW ATARI®
VIDEO GAME PROGRAM™
CARTRIDGES.**

ATARI £86 + VAT

SILICA SHOP

ELECTRONIC GAMES

ATARI



**SPECIAL PRICE
£86 + VAT**

INTELLIVISION MATTEL



£173.87 + VAT

Available August 1980
This is the most advanced TV
game in the world.
Expandable
next year into a full
microcomputer.
COLOUR CATALOGUE
AVAILABLE WITH
DETAILS ON ALL THE
CARTRIDGES

CHESS COMPUTERS



Send for further details.

NEW RANGE
AVAILABLE
AUGUST 1980
We specialise in
computer chess
machines & stock
over 13 different
models from
£20 to £300

TELETEXT



RADOFIN
TELETEXT
Add on Adaptor

£199 + VAT

SPACE INVADERS



HAND HELDS + CARTRIDGES
ATARI ACETRONIC
PRINZTRONIC
RADOFIN - DATABASE etc.

We keep a full range!
Send for cartridge lists stating which
machine you own.

BRIDGE COMPUTER



- * Plays 1/2/3 or 4 Hands
- * Problem Mode
- * Audio Feedback
- * Instant Response
- * Auto scorekeeping

BACKGAMMON COMPUTERS



From £38 to £108. Send for further details.

- OMAR 1
- OMAR 2
- CHALLENGER
- GAMMONMASTER

DRAUGHTS COMPUTER

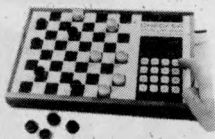

- * Solves Problems
- * Rejects illegal moves
- 2 level machine
£43 + VAT
- 4 level machine
£77.78 + VAT

LEISURE

- * CHEAP TV GAMES
- * TELEPHONE ANSWERING MACHINES
- * AUTO DIALLERS
- * CALCULATORS
- * DIGITAL WATCHES
- * PRESTEL
- * HAND HELD GAMES

**27 TUNE
DOOR
BELL
£17.13
+ VAT**

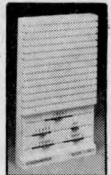

**FREE
CATALOGUE**

For a free copy
of our 32 page
catalogue, send
a 12p stamp to
Silica Shop Ltd
or Telephone
01-301 1111

MAIL ORDER SERVICE - Free postage & Packing

TELEPHONE & MAIL ORDERS - accepted on:
Access * Barclaycard * American Express * Diners Club

CALLERS WELCOME - at our shop in Welling - Demonstrations daily
Open from 9am-5pm Mon-Sat (9am-1pm Wed)

GUARANTEE - Full 12 months + After Sales Support!

We have comprehensive brochures on all products. Please let us know what you are interested in and we will send you detailed brochures AND our own
32 page catalogue covering most games on the market.

SILICA SHOP

SILICA SHOP LTD., Dept. PCW 9b
102 Bellegrove Road
Welling, Kent DA16 3QF
Tel: 01-301 1111

Get the latest on PET...



Dial 01-579 5845.

Adda make it their business to get in first on all that's best and new in PET hardware and software...and in finding out how to make the latest advances work more profitably for you.

All the advice, assistance and arrangement of demonstrations you could ask for are there for the taking. And that's just for starters. Long term Adda look after your future requirements with software, full engineering support and maintenance contracts that can include machine loan.

In addition to the 16k PET 3016 and 32k PET 3032, Adda offer you the new 32k PET 8032—with 80 columns, 12-inch screen and a keyboard that really gets down to business. Recent advances make possible some exciting applications for these mighty micros.

Link the 32k PET up to the Wordcraft word processing program and you have a very sophisticated word processing system for less than £4000. It's a word processor and more—because it can also be used as a small business machine.

The Wordcraft program comes on a mini floppy disc ready for use on a Commodore 3040 diskette drive. The whole system gives you word processing to standards achieved by expensive

purpose-built machines; and you can use a large selection of output printers including dot matrix, golfball and daisy wheel. So much for words—now for some action: phone 01-579 5845.

If you're looking for mainframe access, the Communicator 1 mainframe-PET link enables file transfer to be made in both directions... with a PET Communicator system configured with either dual floppy disc or cassette tape drive and a printer.

Files transferred from mainframe to PET can be manipulated locally and data transfer monitored on the PET screen. It's a fast way of cutting costs on bureau time share—and it also doubles up as a fast normal terminal. The Communicator 1 mainframe-PET link paves the way to big cost savings. Your first step is digital input to 01-579 5845.

More cost savings can be realised when you link up three to eight PETs to one Commodore disc drive and a printer using Mu-pet (Multi-User PET)—and you don't have to make any program changes. As a Mu-pet dealer, Adda can put you fully in the picture. Just phone 01-579 5845 for a demonstration of Mu-pet being put through its paces.

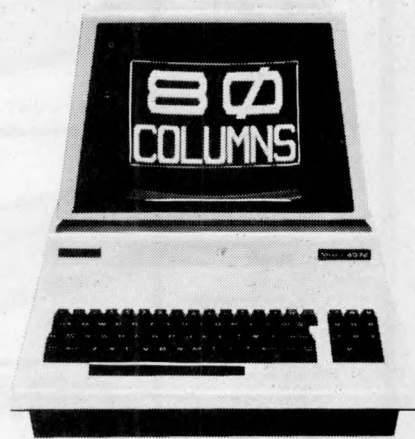

adda

Adda Computers
14 Broadway
West Ealing
London W13 0SR
Entrance in
Kirchen Road

we add up to a great deal.

What will you do with 12-year-old programmers when they reach 16?

Any microcomputer is a major investment for an educational establishment. Many potential users feel that a BASIC only computer is ample for their needs. That may be fine today, but with computer education starting so early you may in a surprisingly short time find you want more than current implementations of BASIC.

The 380Z is a computer that can grow to match your needs.

In the design of the 380Z our target user is the graduate research scientist. This ensures that the expandability and versatility needed tomorrow has been provided for in the computer you buy now.



Might you want to add disc storage in the next few years?

If you do:

Given good hardware, software availability completely determines the flexibility and usefulness of your system. There is absolutely no question that a Z80 based micro-computer which uses the industry-standard CP/M* disk operating system has several times more software on the market available to it than non CP/M computers.

Today you can purchase a mature CP/M BASIC, FORTRAN, COBOL or Text Processor for the 380Z. Soon there will be CP/M Pascal and Database Management systems.

CP/M software is several years ahead of software available for non CP/M family machines.

If you don't:

Remember that professionals writing packages for your cassette system will themselves often use a disk 380Z, and the power of their tools will influence what they produce.

For many people a disk machine is too expensive—but at least the 380Z

approach will allow your students to advance.

380Z BASIC is not frozen in ROM. An enhanced BASIC could be loaded in mid 1980 and a BASIC with structured features sometime later.

On the 380Z the memory used by a BASIC interpreter can also be used for other software.

Does our research-oriented design pay off in classroom hardware?

Our scientific graphics was produced for the professional user. Interest in it for classroom use has been surprising.

The 380Z has the best graphics now available on a microcomputer,

allowing multiple resolutions, multiple paging, fading and accurate control over colour. All these features help bring excitement to efforts in computer assisted learning.

Our standard machine comes with low resolution graphics and support for this from BASIC allows you to plot a point directly with a plot command—useful for training and teaching.

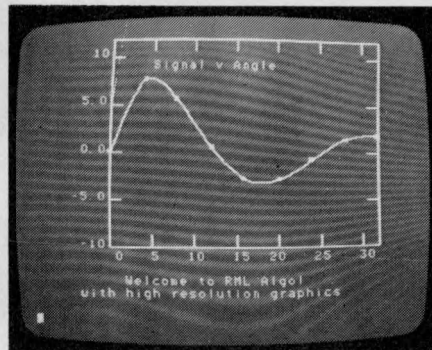

It is worth remembering too that neither our low resolution graphics nor our optional scientific (high resolution) graphics has any limiting effect on your memory usage, and in both you can



freely mix upper and lower case text and diagrams.

Mains noise can cause system crashes which result in loss of programs and data. All current 380Zs include a mains filter which significantly reduces the chances of this happening.

Don't buy a 380Z on patriotic grounds.

Please only buy it if you would have bought it anyway. But remember, because it is designed and manufactured here you are bound to have better access to us for influence and help than if we were on the other side of an ocean.

Prices range from a 16K cassette 380Z @ £897 to a 56K Dual Full Floppy Disk 380Z @ £3322.

LOWER COSTS

Three things have happened which make it easier to buy a 380Z.

ONE: From 1st November 1979 most prices have been reduced.

TWO: Schools and some colleges can now get a 5% discount on computer orders.

THREE: A new Local Authority quantity discount scheme has been introduced to make it easier for more users to benefit from quantity purchasing.

Please contact the Sales Office for details.

RESEARCH MACHINES

RESEARCH MACHINES Ltd,
PO. Box 75, Mill Street, Oxford, England.
Telephone: Oxford (0865) 49791/2/3.
Please send for full sales information.
Prices do not include shipping costs or VAT @15%:

* Trademark, Digital Research.

ROSTRONICS Z-PLUS – THE EXPANDABLE MICRO THAT SPEAKS YOUR LANGUAGE



- JOB COSTING
- PLANNING
- BUILDING MAINTENANCE
- VEHICLE MAINTENANCE
- WORD PROCESSING
- SOCIAL SERVICES
- LICENSING

One Megabyte £3950

Two Megabytes £4450

ROSTRONICS
LIMITED

115 -117 WANDSWORTH HIGH STREET,
LONDON SW18 4HY

Telephone: 01-874 1171 Telex: 8813089

The new
powerful
personal
computer
from
Sweden...



... now looking
for powerful
retailers
to be appointed
for many areas
in UK

Now available from
UK stocks

ABC80

The microcomputer which out-
sells all others in Scandinavia.

Write: Dator Mark Ltd. / Fox Oak / Seven Hills Road / Walton-on-Thames / Surrey kt 124 dg



RABBIT SOFTWARE.

01-863-0833.

380. STATION ROAD.
HARROW.
MIDDX - HA1. 2DE.

A DIVISION OF CREAM COMPUTERS LTD

APPLE / IIT 2020	OUR DISCOUNT PRICE	FOR	PET.	OUR DISCOUNT PRICE
APPLE WRITER	£ 35.00	PLEASE RING FOR FREE COMPREHENSIVE LIST OF OUR SOFTWARE.	WORDPRO II	£ 69.00
VISICALC	£ 87.00		VISICALC NEW	£ 115.00
DESK TOP PLAN	£ 55.00		DATABASE UTILITY	£ 15.00
MAILING LIST.	£ 49.00		COMBIS	£ 135.00
MODIFIABLE DATA BASE.	£ 49.00			

NEW CREAMWOOD BUSINESS MANAGER (SALES) DEMONSTRATION DISK £ 35.00

SHARP PC 1211 NEW
Hand held computer-1K Ram. Basic language. Alpha-numeric keyboard-24 character display
£ 79.95.

SHARP CE 121
Tape interface **£ 12.95.**

ADD 15% V.A.T. ALL MACHINES GUARANTEED 12 MONTHS

NEW CREAMWOOD BUSINESS CONTROLLER (SALES) DEMONSTRATION DISK FOR 8032 SUPER PET. £ 35.00
COMMODORE SOFTWARE.

LEISURE.

TRANQUILITY MOONBASE	DISK	£ 10.00
RELOCATED INTEGER MK2.	"	£ 12.00
SPACE INVADERS INT	"	£ 10.00
BRIDGE	"	£ 10.00
MICROCHESS	"	£ 13.00
MICROGAMMON	INT "	£ 10.00
MICROGAMMON	" TAPE	£ 9.00
STARWARS	" DISK	£ 10.00
OTHELLO	" DISK	£ 10.00
PINBALL	" DISK	£ 10.00
SEVENS	" DISK	£ 10.00
APPLE PACK 13 PROGRAMS		£ 10.00
HIGH RES GRAPHICS INT DISK		£ 12.00
LOW RES GRAPHICS INT DISK		£ 12.00

ALL BY STOCK

LEISURE.

NEW ARCADE GAMES	
NIGHT DRIVE	£ 6.00
CAR RACE	£ 6.00
ACROBAT	£ 6.00
INVADERS	£ 6.00
3D STARTREK	£ 6.00
BREAKTHROUGH	£ 6.00
NEW TREASURE TROVE GAMES.	
NUMBER 11	£ 8.50
NUMBER 12	£ 8.50
NEW PET MASTER SUPERCHIP	£ 45.00

PLEASE SEND FOR **FREE** BROCHURE BY RETURN.

Name

Address

QUANTITY	DESCRIPTION	PRICE.

I enclose my *cheque/charge my Access/Trustcard/Barclaycard/Visa No

Signature

ADD 15% V.A.T.	
TOTAL	

ALL PRICES ARE EX. VAT.
PLEASE ADD 50p p&p ON SMALL ITEMS £2.50 ON LARGER ITEMS

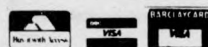

CARD HOLDERS 'PHONE YOUR ORDER
*Delete as applicable

ELIMINATE YOUR BACK-UP PROBLEMS

with our low cost cartridge drive



PRICE
£3950*
PLUS VAT

*One-off OEM price

The Equinox KB10 Cartridge Drive allows S100 microsystems to transfer, read and write data at high speed. Its 5MB fixed and 5MB removable discs eliminate the need to provide separate data back-up. The removable 5MB disc allows for fast back-up and therefore unlimited off-line storage. Without sacrificing high performance, multiple users can operate the Equinox KB10 simultaneously using multi-user software. Equinox provides support for such software i.e., MVT/FAMOS, MP/M and OMNIX. CP/M is also supported.

EQUINOX
COMPUTER SYSTEMS LIMITED

Kleeman House, 16 Anning Street, New Inn Yard,
London EC2A 3HB. Tel: 01-739 2387/9 and 01-729 4460

WEST MIDLANDS

If you want a computer
for business use
consult the experts!

PAYROLL
STOCK CONTROL
PURCHASE/SALES
STOCK/INVOICING
INSURANCE BROKERS
VISICALC
WORD PROCESSING
MAILING LIST
etc.

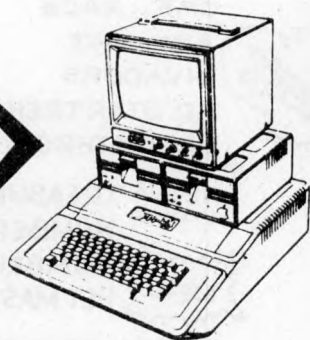

apple II SALES AND LEASING

LEASE AN APPLE II 48K SYSTEM INCL.
TWIN DISK DRIVES, MONITOR AND PRINTER
From £11.50 per week!

MICRO BUSINESS CENTRE LTD.

Castle Bridge House, Lichfield Road
Wednesfield, Wolverhampton
Tel: 0902 725687 for Sales and Service

FERGUSSON COMPUTER SERVICES

For All Your

apple & ITT 2020

SALES AND SERVICE

Contract Maintenance:-

- * On-site repair contracts
- * Total system or only items required
- * 24hrs response to calls
- * Very competitive rates

Ad-hoc Repair Service:-

- * Ring for repair quotation
- * Same day service
- * Collection from Red Star if required

Hardware and Software Sales:-

- * 32K RAM free with each system purchased with this advertisement
- * Totally Integrated Ledger system complete for £3262.00

For further information ring
Byfleet (09323) 45330

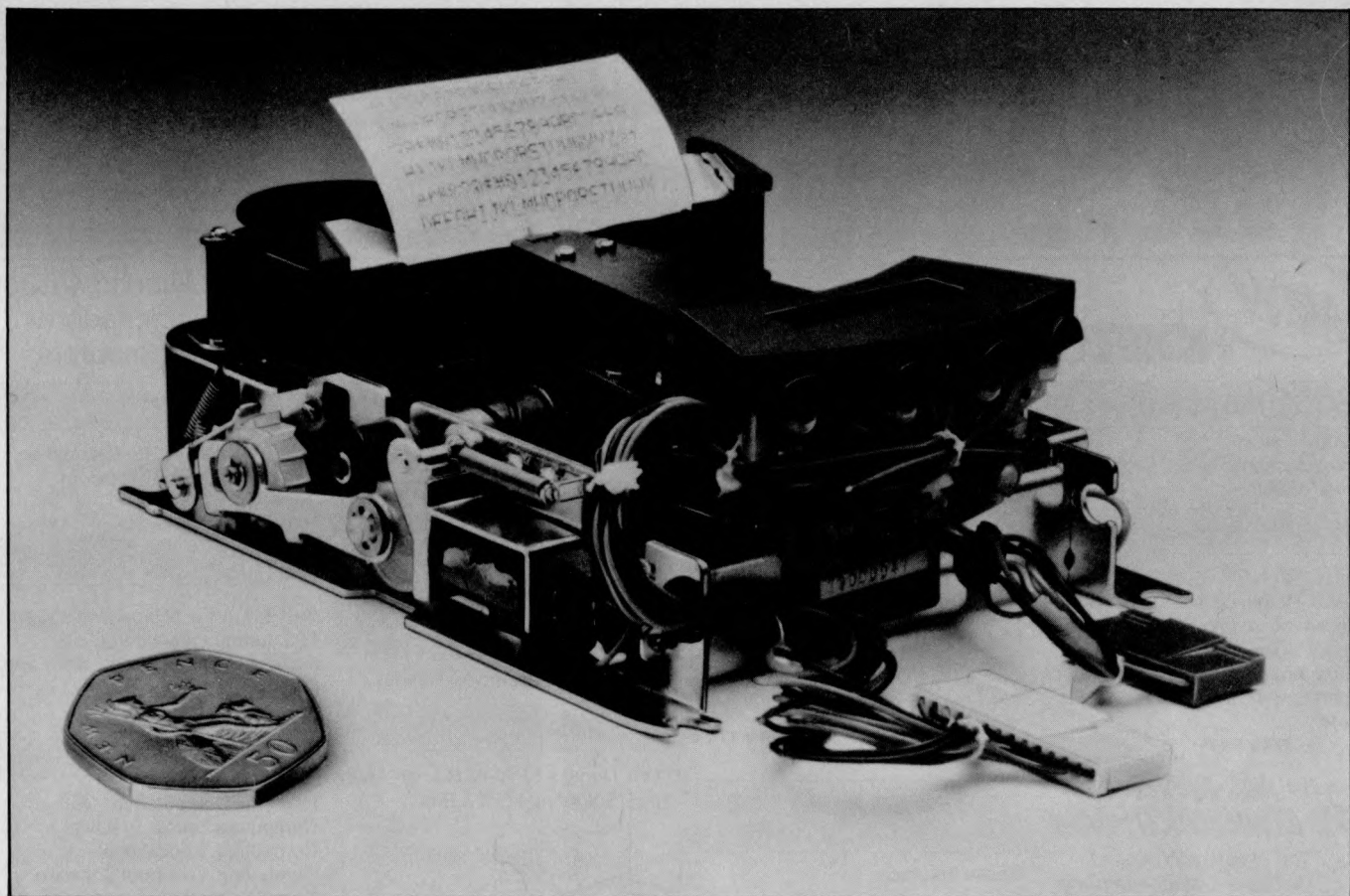

At just £50, this top quality impact needle printer has got to be the best buy on the market today.

Roxburgh introduce the 822 impact needle printer offering top quality at the lowest price.

It consists of a seven needle mobile head which is moved across the paper to produce up to 21 alpha numeric characters per line on a 5x7 matrix. The unit operates entirely from 12V d.c. to give a maximum speed, including line feeds, of 2.5 lines per second. Standard paper 2¼" wide is used in single or two ply carbonless form. The single colour ribbon automatically reverses. And there's a low cost replaceable head, just in case it's

ever needed. A control chip, type DPC-1, is available enabling easy interfacing to most 8 bit microprocessors.

At just £50 one off the 822 represents unbeatable value. And it's just one of a range of money saving printers available up to 80 columns, plus card readers and digital recorders.

Get more information right now. 'Phone Keith Evans, Roxburgh Printers Limited, 22 Winchelsea Road, Rye, East Sussex TN31 7BR. Tel: Rye (079 73) 3777. Telex: 957066.



ROXBURGH
PRINTERS LIMITED



Some new introductions by the Midlands Computer Centre...

We celebrate our first birthday with news of new introductions available from the Micro Computer Centre.

NEW

HORIZON

NEW

CROMEMCO

NEW

NEWBRAIN (As soon as available)

In addition to Nascom and Commodore micro computers

PERIPHERALS	ADD-ONS FOR NASCOM	BITs & PCs	SOFTWARE
(Excluding printers) Sharp Cassette Decks. Crofton 10" Cased Monitors.	Input/Output Board. PIO Kit. Counter Timer Kit. UART Kit. (Colour Board Programmable Character Generator Board. Floppy Disc System (Single Drive) available in September). Nas-Pen Text editor. ZEAP 2.0 in EPROM or on Tape. Nas-Sys 3 Enhanced version of Nas-Sys 1. Nas-Dis - Disassembler. Debug - Dynamic Debugger.	Tool Kit. Port Probe. Hex Key Pad.	Northstar. CAP-CPP. Cromemco. Petsoft. Supersoft. Nascom Games.
PRINTERS		WILLIAM STUART	BOOKS
Nexos Ricoh RP 1600 Daisy Wheel Printer. Diablo Daisy Wheel Printer. Nascom Micro Imp. Dot Matrix Plain Paper Printer. Centronics Dot Matrix. Anadex Dot Matrix. Newbury Laboratories Dot Matrix Impact Printer.		Colour Graphics for Nascom 1 & 2.	Very full range of books on 6502, Z80, Languages, Interfacing, Introductory books and games and General Programs.
		MERSEYSIDE NASCOM USER GROUP	MAGAZINES
		ROM/EPROM Board for Nasbus.	Personal Computer World. Computing Today. Practical Computing. Educational Computing. Liverpool Software Gazette. Printout.
		EXTRAS	
		Henry's EPROM Burner. Antex Soldering Irons & Bits.	

ASK ABOUT THE KENILWORTH CASE
The "Kenilworth" Case. Microtype Case. Veroframe.

BUSINESS & LEISURE MICROCOMPUTERS
Castle Interface.

EXTRAS
Henry's EPROM Burner. Antex Soldering Irons & Bits.

Business & Leisure Micro Computers

16 The Square, Kenilworth, Warwickshire CV8 1EB. Tel: (0926) 512127

New and exciting Applesoft programs

NEW!
the correspondent
By Roger Wagner

by R. Wagner
THE CORRESPONDENT is sure to be one of the most versatile programs in your library! It can be used as:

A Text Processor: Upper/lower case, 1-80 cols. (4-way scrolling). Text move/copy/insert/delete, tabbing, justify text, auto-centering and more!

A Database (with or without printer!) Extremely fast find routine and easy editing make it a natural for free-form data files. Create and fill out forms, access phone lists or index your magazines.

A Programming Utility: (printer or not). Examine, edit, transfer random or sequential text files. Create versatile exec. files. Even put bi-directional scrolling in your own programs!

Apple disk £29.95 + VAT

Roger's Easel

by R. Wagner
At last a program which allows you to draw colour pictures in lo-res graphics, and then permanently link them to your own Integer or Applesoft programs. Linked pictures can be displayed on either text/graphics page. (Integer basic).

Apple disk £14.95 + VAT

Apple-Doc *By Roger Wagner* An Aid to the Development and Documentation of Applesoft Programs

This 3 program set is a must to anyone writing or using programs in Applesoft! It not only provides valuable info. on each of your programs, but allows you to change any element throughout the listing almost as easily as you would change a single line!!

With Apple-Doc you can produce a list of every variable in your program and the lines each is used on, each line called by a GOTO, GOSUB, etc., in fact, every occurrence of almost anything! You can rename variables, change constants and referenced line numbers or do local or global replacement editing on your listing.

Apple-Doc is a must for the serious Applesoft programmer.

Diskette complete with full documentation £24.95 + VAT

tridee *©Robin L. Frost*

An exciting new addition to your Pascal library - enables you to create 3D graphics, viewable from any angle and distance. As easy to use as Turtlegraphics.

Procedures include Ortho, Perspec, Rotate, View, Move to-3, View-from.

Complete with comprehensive instructions £49.95 + VAT

Apple World **STOP PRESS!** is here. The fast 3D graphics package that runs on your Apple II plus. Zoom, pan, tilt and scale your own designs on the Apple screen, at only **£24.95 + VAT**

Plus a complete range of "off the shelf" programs for finance, commercial, scientific and education. Keep yourself up to date, send for our "Fact Sheets" giving full program details.

LEICESTER
computer centre limited

109 QUEENS ROAD LEICESTER LE2 1TT
Tel: 0533 709841

apple computer
Sales and Service





HEWLETT PACKARD HP85

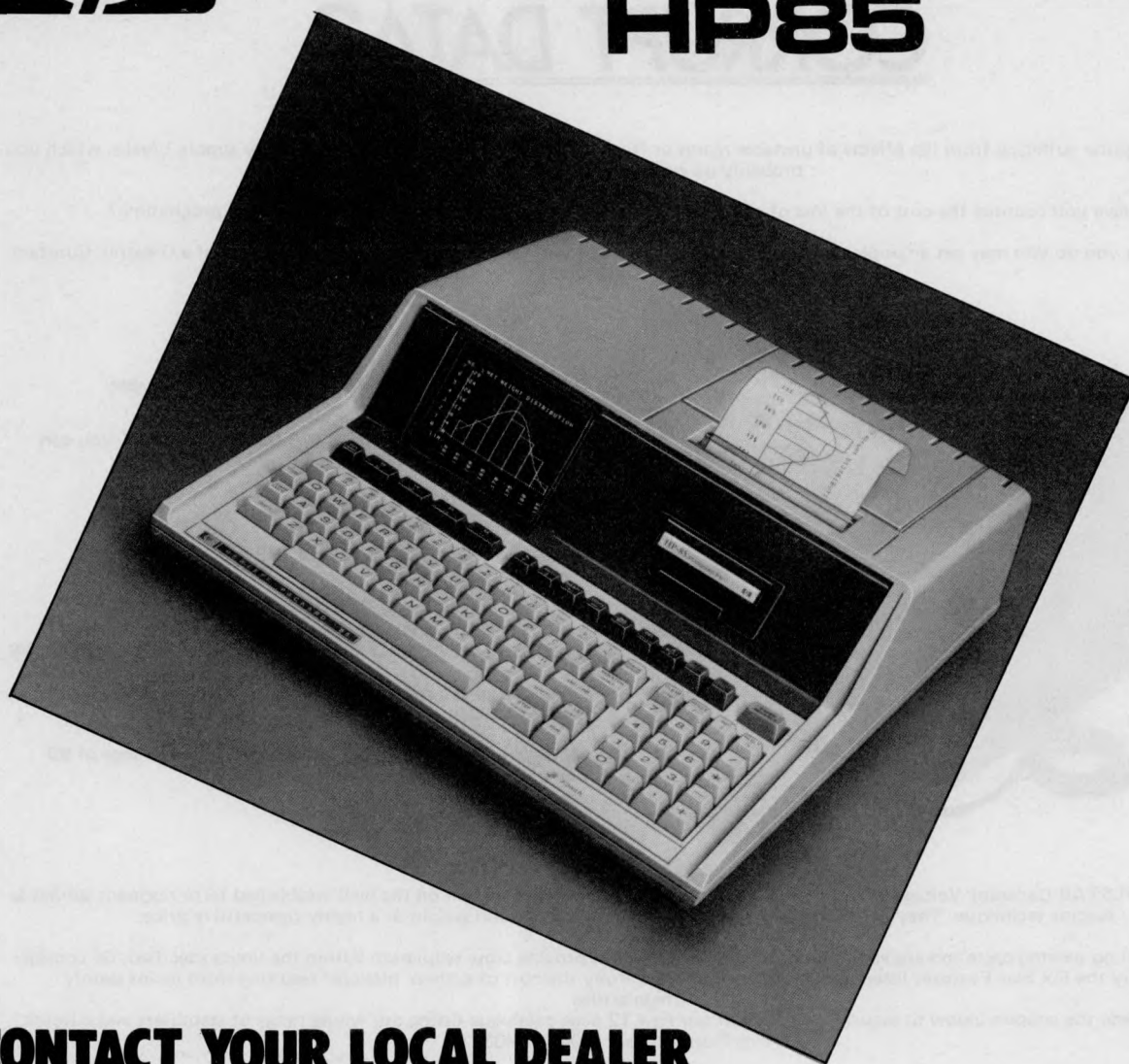

CONTACT YOUR LOCAL DEALER

Anglo-American Computing
9 Coventry Road
Coleshill
Warks
0675 65396

Automated Business Equipment
Mersey House
Heaton Mersey Industrial Estate
Battersea Road
Heaton Mersey
Stockport
Manchester (061 432) 0708

Business & Electronic Machines
7 Castle Street
Edinburgh
Edinburgh (031 226) 4294

Central Southern Calculators
12 Wokingham Road
Reading
Berks
Reading (0734) 61492

Decimac Business Machines
Decimal House
Thomas Lane
Bristol
Bristol (0272) 294591

Euro-Calc Ltd
128-132 Curtain Road
London EC2
01-729 4555

Holdene Ltd
10 Blenheim Terrace
Leeds
Leeds (0532) 459459

Office Machinery Engineering
73 London Road
Brighton
E. Sussex
Brighton (0273) 689682

Rockliff Brothers
Systems Centre
2 Rumford Street
Liverpool (051 521) 5830

Robox Limited
Unit 4
Anderston Shopping Centre
Glasgow
Glasgow (041 221) 5401

Sumlock Bondain Ltd
15 Clerkenwell Close
London EC1
01-250 0505

Sumlock Services
Epic House
Charles Street
Leicester
Leicester (0533) 29673

Taylor Wilson Ltd
Oakfield House
Station Road
Dorridge
Solihull
W. Midlands
Knowle (056 45) 6192

This is a list of dealers participating in Associated Advertising and not a full list.

DIRTY MAINS! CORRUPT DATA?

Is your computer suffering from the effects of unstable mains or from high voltage transients and momentary supply breaks, which you probably do not even notice otherwise?

Have you counted the cost of the loss of a day's data input or, worse still, the corruption of a whole programme?

If not, when you do you may get an unpleasant surprise — particularly if you then compare it with the low cost of a Galatrek Constant Voltage Transformer.



C.V.P.'s stabilisers cut-outs, filters & uninterruptable power supplies

For a cost ranging from only £75 (ex works) + VAT you can get:—

- * STABILISATION OF $\pm 1\%$
- * TRANSIENT ATTENUATION
- * MOMENTARY POWER BACK-UP
- * RAPID RESPONSE
- * OUTPUT TOTALLY ISOLATED
- * PROTECTION FOR STABILISER AND EQUIPMENT UNDER OVERLOAD AND SHORT-CIRCUIT CONDITIONS

Standard range covers ratings from 250VA to 5kVA. Higher ratings to order.

Model AK250 at £75 ex works + VAT, part of a range of 90 one of a range of 90 models covering most voltages.

Galatrek VOLSTAB Constant Voltage Transformers are based on a Galatrek innovation on the well established ferro-resonant saturable reactor technique. They offer high performance with minimal size and weight at a highly competitive price.

They contain no moving parts and are very reliable in service. They will provide close regulation within the limits specified. So consider carefully the Six Star Features listed above. And consider carefully the cost of system 'hiccups' resulting from mains supply irregularities.

Then complete the coupon below to secure your copy of our new 12 page catalogue listing our whole range of stabilisers and cutouts. Or ring Ron Koffler on 0492 640311.



Scotland Street, Llanrwst,
Gwynedd LL26 0AL. North Wales, Britain.
Telephone: Llanrwst (0492) 640311
Telex: 617114 Answer back—GALAHU
Telegraphic Address GALAWATT.

U.K. Marketing Agent:
Danesbury Marketing Ltd.,
Tavistock House,
Bedford MK40 2QD
Tel: 0234 213571 Telex: 825633 OTSS-B

TRADE & OEM ENQUIRIES WELCOME

PCW 10.8

CUTOUT NOW AND POST TODAY

Mark first class

PLEASE recommend a stabiliser for the following: application (Please state rating in watts of each unit).

.....

.....

PLEASE send me your new 12 page catalogue

Name

Sent By.

Tel No

Tick if trade Tick if OEM

Address

.....

.....

ANDREWS COMPUTING LTD

TRS-80 NASCOM 1 & 2

Now there is a range of quality software at real value for money prices.

For TRS-80 Level II (16K+)

PASCAL Development System £18.00

Pascal Compiler
Run Time P-Code Interpreter
Compiler source code (in Pascal)
Pascal Guide

Take a step into the future with this exciting product, which runs many times faster than Basic.

BASIC III - The Level III Basic £18.50

Extended High Speed Graphics
Renumber Basic Programs
Append Basic Programs
Single key entry of Keywords

Includes many features of Disk Basic and a superb demonstration program.

GAMES Tape No. 7 £7.50
33 Programs (Excellent Startrek)

R-BUG Machine Code Monitor £8.50
All standard monitor facilities
Enables System Tapes to be copied for backup purposes.

For NASCOM 1 & 2

RENUMBER Nascom Basic £6.00

Renumbers Microsoft/Starbase (ROM or Tape) Basic. Available for T2, B-Bug, T4 and Nas-Sys monitors

For further details of our extensive range, send for free catalogue. All prices include VAT and P & P. Please state computer type when ordering.

ANDREWS COMPUTING LTD
21 Lime Tree Drive, Farndon, Chester

THE SHARP MZ-80 COMPUTER SYSTEM



As one of Sharp's largest systems dealers we supply complete MZ-80 systems including FLOPPY DISCS and PRINTERS.

We have considerable experience in implementing SALES, PURCHASE and NOMINAL LEDGERS, PAYROLL, STOCK CONTROL, FOREIGN EXCHANGE and FINANCIAL PROGRAMMES.

Contact us now for details on 01-247 8506.

SCOPE Stone House, Houndsditch Entrance
128-140 Bishopsgate
London EC 2M 4HX



Z19.



The Intelligent terminal.

The Z19 'intelligent' Video Terminal, from Zenith Data Systems, is ideal for a wide variety of high-speed data handling tasks.

Compatible for use with EIA RS-232 or 20mA current loop, it has all the capabilities and features you'd expect from a top-of-the-line peripheral.

- Z80 Microprocessor based electronics
- Special deflection system for sharp resolution
- Full editing functions, plus user-definable keys
- Reverse video by character
- 24 lines of 80 characters plus 25th user status line
- 5 x 7 Dot matrix (upper case)
- 5 x 9 Dot matrix (lower case)
- 128 characters (95 ASC11 and 33 Graphic)
- ANSI and DEC VT 52 compatible

And there's one feature of the Z19 you wouldn't expect. The price. Just £735, exclusive of VAT and delivery charges.

Generous OEM discounts are available.

Zenith data systems



For full details about the Z19, complete this coupon and return it to:

Zenith Data Systems Division, Heath Electronics (UK) Ltd.,
Dept. (), Bristol Road, Gloucester, GL2 6EE.

Name _____

Company _____

Address _____

Z19

**See us at
COMPEC'80
stand 6181
Olympia
Nov 4-6**

Almarc + Vector Graphic

The complete partnership
in Micro computers

System 2800.

- * S-100 bus.
- * Switch-selectable asynchronous baud rates between 110 and 9600 bits/second.
- * Vector-3 console chassis with 12-inch CRT (18" W x 12 1/2" H x 21" D).
- * Capacitance Keyboard 6 slot motherboard, and power supply.
- * Z-80 based single board computer with 1 serial port, 3 8 BIT parallel ports, 3 PROM slots, and

1K RAM, Flashwriter II, Video board, 64K dynamic memory board and disc controller. DUALSTOR enclosure with two 8-inch double density disc drives, total disc storage capacity 2.4 m bytes.

* Version 4 extended systems monitor on PROM, Vector CP/M 2.2, SCOPE, Screen Oriented Program Editor, full screen dynamic simulating debugger, ZSM Z-80 assembler, Microsoft BASIC-80 Release 5.

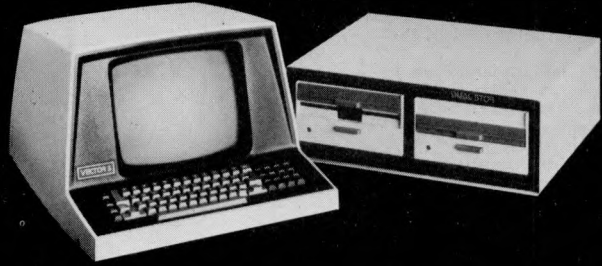

System 3030.

- * Vector-3 console chassis with 12-inch CRT (18" W x 12 1/2" H x 21" D), capacitance keyboard, 6-slot S100 motherboard, and power supply.
- * ZCB Z-80 based single board computer with 1 serial port, 3 parallel ports, 3 PROM slots, and 1K RAM. Flashwriter II Video board, 64K dynamic memory board, floppy disc controller board, Winchester disc interface board, Megastor enclosure with 8-inch Winchester 3-platter hard disc drive, and

2 Micropolis Mod II quad density mini-floppy disc drives (20 1/8" W x 7 1/8" H x 16 3/4" D).

* Capacity Hard Disc 32 M bytes.
* 2 5 1/4" MICROP DISC DRIVES giving 630 Kbytes, Storage Capacity.

* Version 4 extended systems monitor on PROM, Vector CP/M 2.2, SCOPE, Screen Oriented Program Editor, full screen dynamic simulating debugger, ZSM Z-80 assembler, Microsoft BASIC-80 Release 5.



System 'B'

- * 64K Bank Selectable Ram (56K available to user).
- * 3 Serial Ports, 2 Parallel Ports.
- * Twin Disc Drives, 630K Capacity.
- * Z-80 CPU, with Fast 4MHZ Clock.
- * Interrupt Handling on I/O Board.

* 18 Slot Motherboard.
* Vector Mindless Terminal.
* Flashwriter II Video Board (24 x 80).
* CP/M 2.2 Operating System.
Plus Microsoft Version 5 BASIC SCOPE, Screen Oriented Program Editor, Full screen dynamic simulating debugger, ZSM Z-80 Assembler.



At Almarc Data Systems, when you buy Vector Graphic Micro-Computers, you are assured of Almarc's experience of over 350 systems installed throughout the U.K. — plus their back-up of full service facilities carried out by experienced staff.

Almarc are Specialists in Vector Graphic equipment which includes Micro-Computers for research, laboratory work, word

processing, business systems, schools, colleges, universities and industry. Plus an ever growing list of compatible software including Pascal, Fortran, Cobol, APL, Algol, Basic Compiler and others.

We will be pleased to demonstrate how Almarc + Vector Graphic Systems equates to The Complete Partnership in Micro-Computers.

DATA SYSTEMS LTD

906 Woodborough Road, Nottingham NG3 5QS.

Tel: (0602) 625035

it's soft at the top!

Business software at competitive prices for CBM PETS – to keep you on top of your business.

- Petaid Filing & Retrieval system
- All purpose program structure
- Incomplete records
- Planner
- Mailing
- General accounting
- Residential or part time courses
- Estate Agents

The sign of good software for the small businessman

Send for our catalogue

STAGE ONE SOFTWARE

6 CRITERION ARCADE, Old Christchurch Road
Bournemouth. Tel: 0202 23570



OHIO SCIENTIFIC SUPERBOARD II

50ZH BLACK AND WHITE VERSION
£159.95 +15% VAT POST FREE.
50HZ COLOUR VERSION £215 + 15% VAT.
+ THIS UNIQUE SPECIAL OFFER.

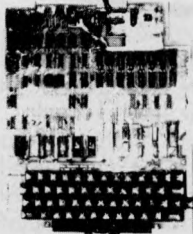

If bought with superboard or colourboard these items are at the reduced prices shown first. Also sold separately at the bracketed prices. Add 15% vat. Modulator and power supply kit £7.95 (£11). 4K extra ram £20 (£24). Display expansion kit approx 30 lines x 54 characters £15 (20). Case £23 (£26). Colour conversion board £15 (£20). Case £23 (£26). Colour conversion board fully assembled £55 (£55). Cassette recorder £13 (£15). Extended monitor £20 (£20). Assembler/Editor £25 (£25). 610 Expansion Board £160 (£275).

SHARP MZ-80K
The brilliant new Japanese computer which is beating the hell out of PET. 20K ram expandable to 48K. Built in VDU screen, music function and cassette. Displays 40 characters x 25 lines and 80 x 50 on graphics. £465 + 15% VAT.



SUPER PRINT 800MST

The ideal impact matrix printer for Superboard, UK101, pet, apple, trs80, mz-80k. 60 lines/minute. 72, 80, 96, 120, and 132 chr/line. Tractor and friction feed. Graphics and user definable chr sets. RS232, 20ma, IEEE488 and centronics I/O. SPECIAL OFFER:— Supplied with free word processor program and interface components £359 + 15% VAT.



SWANLEY ELECTRONICS

Dept. PCW, 32 Goldsel Rd., Swanley, Kent BR8 8EZ.
Mail order only. Please add 35p postage. Prices include VAT unless stated. Lists 27p post free. Overseas customers deduct 13%. Official credit orders welcome.

Z89.



Altogether a better computer.

All the power and built-in peripherals for business and educational computing in one compact, desk top unit.

The Z89 Series Microcomputer.

Designed and built to the highest specification, the Z89 combines reliability and efficiency with ease of operation. And is backed, of course, by our excellent after sales service.

Features include:

- Z80 CPU
- Built-in floppy Disc with optional dual external drives
- Built-in Z19 VDU
- Up to 65K RAM
- Three serial RS-232 I/O
- Operating systems C/PM & H.DOS.
- Languages: M-Basic, C-Basic, Fortran, Pascal, etc.

And with generous OEM discounts available you can see why the Z89 is a better computer.

Zenith data systems



For full details about the Z89, complete this coupon and return it to:

Zenith Data Systems Division, Heath Electronics (UK) Ltd.,
Dept. (), Bristol Road, Gloucester, GL2 6EE.

Name _____

Company _____

Address _____

Z89

What every OEM will want to know about DELTA DP/NET: the small business system that's the start of something big.

"Convince me!"

First you'll have to debug your mind of the limitations you've been conditioned to accepting about micros - because with DELTA DP/NET there aren't any!

"So what's so different about DELTA DP/NET?"

It's a totally new systems concept using the new CP/NET* operating system resulting in the world's most powerful microcomputer network. DELTA DP/NET gives a new dimension to distributed processing and configurability.

"But flexibility is what I'm looking for..."

Then you've found it. DELTA DP/NET has a CPU which uses the S-100 bus system - more flexible, more serviceable and potentially more powerful than computers without a bus. There's 64k bytes of RAM in the host computer as standard - expandable to 256k bytes; and 1-4 Mb of floppy disc storage with hard disc expansion capability to 165Mb. Each intelligent terminal in the network has up to 64k bytes of memory, which

in turn can be expanded to 700k bytes of local floppy disc storage. And of course, each intelligent terminal has the S-100 bus.

The system can start with a 5" minifloppy 32k terminal. More terminals and more storage can simply be added on. And you can go on doing this as required with up to 16 intelligent and semi-intelligent terminals connected to one host computer and sharing the same database. Host computers can be linked and slave computers added to meet ever-increasing work loads.

"At what sort of cost?"

Hardware costs are extremely competitive - and the hardware is totally cost effective since a customer never has to buy more computing power than he actually needs.

"What sort of configurability are you talking about?"

You name it - DELTA DP/NET will supply it. Any compatible combination of hosts, slaves, storage devices, peripherals and communication links - and we mean any!

"But surely all this expansion is going to bog the system down."

Not at all. The DP/NET mode of operation is so entirely different from other micro systems that it just doesn't happen.

"What sort of software back-up is provided?"

Standard application packages that can be supplied include Word Processing, General Ledger Accounting, Order Entry and Invoicing, Payroll, Company Purchases System (Accounts Payable), Company Sales System (Accounts Receivable), Stock Control for Distributors or Manufacturers, Estate Agents, Employment Agents and Agriculture.

A range of compilers and interpreters can be supplied including FORTRAN, COBOL, BASIC, C BASIC, PL1, PASCAL and ASSEMBLER.

"So where do I go from here?"

Straight on to Terodec - the sole U.K. distributors of the world's most powerful microcomputer system, DELTA DP/NET.



TERODEC

Terodec (Microsystems) Ltd.
Unit 58, Sutton's Park Avenue,
Earley, Reading, Berks RG6 1AZ
Tel: 0734 664343/4

17 The Gallop
Yateley, Camberley, Surrey GU17 7SG
Tel: 0252 874790

*Trademark, Digital Research

OHIO..

..24 hours a day!

Yes that's right, we are at your service 24 hours a day offering a complete OHIO SCIENTIFIC service, giving technical information, advice on hardware expansion and satisfying your requirements in any of the following:

OSI SYSTEMS-including the popular SUPERBOARD II and CHALLENGER 4P as either cassette or disk based systems.

OSI SOFTWARE-cassette and disk based software covering a broad spectrum of uses. Some of the cassette based software can be run on the UK101.

BEAVER SOFTWARE-business, educational and entertainment software -professional programs with full listings and documentation. Also available for other programs especially the UK101.

BEAVER PROGRAMMING AIDS-including video workpads, BASIC workpads, machine code workpads, cassette index cards, labels and blank cassettes, all available for OSI UK101 and TRS-80.

In addition to the above, we also have available cases for the SUPERBOARD II (and others).

Demonstrations of all the systems and software available can be arranged in your own home or business premises (within a 50 mile radius of Oxford).

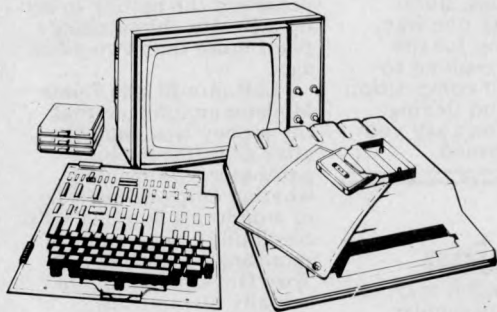

BEAVER
SYSTEMS

Norlett House, Dormer Road, Thame, Oxon OX9 3UC
Telephone Thame (084421) 5020 (24hr)

PARAMOUNT COMPUTERS LTD

42/45, New Broad St. London EC2M 1QY.
Tel. 01-403-4746.

TRY A 'NIBBLE'

THE BEST MAGAZINE FOR USERS OF

APPLE & ITT 2020

CONTAINS PROGRAMME LISTINGS, TECHNIQUES
FEATURE ARTICLE, NEW PRODUCT REVIEWS. etc.

MAIN PROGRAMME AVAILABLE ON DISK

ASK FOR OUR COMPREHENSIVE SOFTWARE
& HARDWARE CATALOGUE

Cheque payable to "Paramount Computers Ltd"

Order Form

Name

Address

.....

.....

Subscription £17.50 p.a. inc. post. 8 Issues

Amount Enclosed. £

WH14.

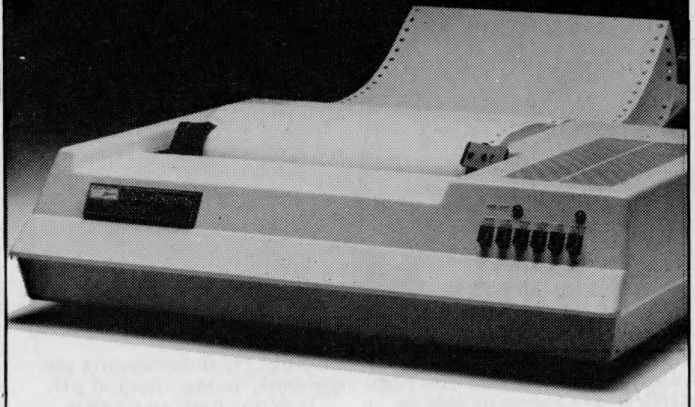

First in line.

If you're looking for an above average line printer at a lower than average price then the WH14 from Zenith Data Systems is your first choice.

Microprocessor controlled, this compact table-top unit can be used with most computers through a standard serial interface. It provides hard-copy output of your programmes as you execute them, plus handy copies of address lines, lists and other programming data for educational or business applications.

Features include:

- 5 x 7 Dot matrix printing
- Clear easy-to-read images
- Upper and lower case characters
- Operator/software selectable line width: 132, 96 and 80 characters per line.
- Sprocket paper feed with adjustable spacing
- Stepper motor feeds allows 6 or 8 lines per inch vertical.
- Form feed operator/computer control
- Microprocessor based electronics

And at £510, exclusive of VAT and delivery charges, the WH14 puts economy first in line too.

Generous OEM discounts are available.

Zenith
data
systems



For full details of the WH14, complete this coupon and return it to:

Zenith Data Systems Division, Heath Electronics (UK) Ltd.,
Dept. (), Bristol Road, Gloucester, GL2 6EE.

Name

Company

Address

.....

.....

WH14



You'll be pleased to hear that, despite his recent elevation to the Editorship of trade rag Datalink, Guy Kewney has decided to stick with PCW. Here he is with his latest crop of news, rumours and gossip.

PO on the prowl

Today, anybody can hire a microcomputer from the Post Office. Next year or maybe the year after, you'll be able to hire a Post Office microcomputer — which is not quite the same thing.

For users, the news must be good: another supplier in the market can only mean a better choice. And once the Post Office's National Data Processing Service starts building its own microcomputers — which is what this is all about — it'll have a direct interest in using its resources to make its own micros easier to use. And that means all sorts of good things.

The good things will include very cheap software, distributed down the phone lines. The people designing the PO micro are bright enough to know that software is free; anybody smart enough to borrow a disk or tape and copy it can have a program, in the same way that anybody smart enough to tape a radio broadcast can have free music. The current pricing level puts software at three different cost points: cheap (£5 or so), reputable (£100 or so) and quality (with stars and a nice, hard-to-understand manual, at £300 or so) — all for very similar programs. This is a very temporary trend. In five years' time, software will cost £50 (by then, I'm assuming, £50 will buy an LP or a round of drinks) or £50,000 in a dealer pack, allowing you, the dealer, to sell off copies for £50.

The PO, with Telecom's wires to distribute, can transmit software direct to a user machine for the cost of the phone call — and that's at a profit. Now while all this may be some way in the future, it's the sort of thing we can expect the PO to work towards once it gets into the micro market: and the move is much closer than many people suspect.

The biggest surprise has been for the people who already make micros and who supply them to the PO for rental to its customers. They're finding that sales to

internal PO departments are suddenly being blocked off.

It is not easy to do this, of course, and the trend will evaporate quickly once internal departments twig that permission to buy a Rair Black Box, or Research Machines RML 380Z, or Casu, is likely to be refused on the grounds that "you'd better wait until our own product is announced," which is what's happening now. Instead of asking permission, they will fall back onto the many tried and trusted dodges — buying 'process control equipment,' or 'office storage systems' or 'automatic monitoring devices' out of adequate special budgets set aside for these things. "Microcomputer?" they will say innocently, when asked to explain a North Star Horizon on the desk, "is that a microcomputer? We bought it as a sophisticated staff clocking-out registry device and all it does apart from that is Star Trek and a few other games — cost accounting, and that sort of thing..."

But the PO's own microcomputers, for there are two, will be eye-openers when they come. For a start, they'll be multi-user: the designers are not limiting their vision to today's slow eight-bit micros but are looking wistfully into the next five years, when any competent micro will be a 16-bit mini.

Second, they will not be built by the automatic PO choices for the past few decades — the branches of Plessey, Standard Telephones and Cables, and GEC — but by the company which tenders successfully for the licence to build them. And they will be built by a second source, the PO's factories division. Few people know that the PO has a factories division — they tend to think of a specialist outfit, making £2000 transistors for undersea cables. They can forget it: Sir Keith Joseph has decided that the PO must face competition, because it will be healthy for the PO.

Actually, what he meant was that it would be healthy

for the rest of industry, which could march into the PO territory and take over from the fat slugs. But it won't work only one way. It will be healthy for the PO, which will respond to the cold wind of competition by waking up and flexing its muscles ... don't say you haven't been warned.

Hard Diskussion

Impressive though it may be to say that one particular manufacturer of computer back-up store can boast Bill Schneider "who was director of product planning for the Memorex Corporation", it is time that suppliers of imported US products realised that they had one little problem: when they say "the product I am importing is the best in its field," they are laying themselves just a teeny bit open to charges of bias.

Rack Data imports mini-winchester disk drives made by Priam (who boasts Bill Schneider, etc) and "regards Priam as being the best of the independent suppliers" of these disk-drive sized storage devices. Really? Did Rack Data have the option of Shugart and turn Shugart down?

INMOS- the late news

How much is £25 million, if you are building a chip fact-

ory? It depends, doesn't it, on whether you got it two years ago or now; Inmos was promised the money to set up a British chip-making plant more than two years ago.

Last month, the Prime Minister announced that the money was available after all (after the long pantomime of deciding whether chips would sell, of wondering whether GEC could do it better, and of agonising over whether a Tory Government could actually do *anything*, especially if it had been started by Jim Callaghan) and Inmos started making plans.

Well, the plans are rather less grand than the original ones were; £25 million may be more money than I will see this decade (next decade it'll be the price of a house, I dare say) but it doesn't stretch to the sort of plans that Inmos made when they first started drawing lines on paper.

The Bristol factory has been moved to South Wales. Originally, that would have helped some 200 school leavers in South Wales but wouldn't have done anything for Inmos. Catch-22 says that if you set up shop in a development zone, you get a Government grant but that if you already have a grant, the second grant is deducted from the first. Inmos was set up under a Government grant.

That has been changed: now it looks as though Inmos will gain £3 million or more

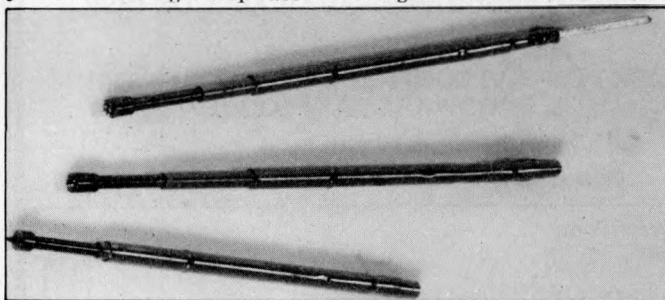

These ain't pins, they's probes. Vero has produced them for automatic board testing, before or after components are loaded. One part is spring loaded and fits into the other part, which is fitted to the board to be tested; you put the board on a bed of pins which are all wired to your test rig — which may be as simple as a volt meter or as complex as a signature analyser — and contact is made. Details on 04215 66300.

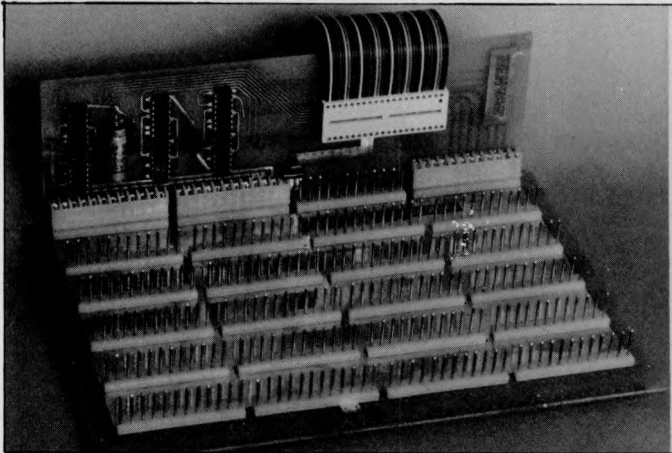

It's not easy to plug extras such as data storage disks, or extra memory, or printers, into the typical Ohio Scientific computer at the single board level of the Superboard (or the imitation, Chris Cary's Compukit UK101) — for the simple reason that the machine is a single board, without a nice standard bus to plug things into.

A product which offers such a plug-in bus has been released by Zen Computer Services of Sale in Cheshire. It comprises two boards with a 40-wire connection to the main computer board. The first board plugs into the second which is a mother-board, taking up to five other expansion devices) and merely boosts the electrical signals, providing a 'buffer'. Details on 061-962 3251.

by getting Government assistance to set up in South Wales, a high unemployment area. Even with that, the plans for a corporate headquarters at the factory have had to be scrapped. Instead, it will keep its rented office space in Bristol for a headquarters and will only build a factory in Wales. The saving will be enormous but necessary.

Ah well, it still doesn't bring the magic day any nearer, the day when products with Immos chips inside will be sold. Immos is designing a microcomputer, no secret about that, and it will be available sooner than its competitors expect. But it isn't going to be a challenge for anything we now use; for the Zilog Z8000, yes, but only far, far in the future.

¿Qué?

You may think these translation calculators are a joke. You wait until some foreigner tries to pronounce a simple phrase such as "Do you have the right time?" from the anti-phonetic spelling of the English language, as provided by his pocket phrase book, and you will realise why the only firm with a chance in this business is Texas Instruments.

The Texas translator talks. It may sound like a machine talking, and it may be monotonous but when it speaks French, it sounds like a monotonous machine with a French accent, a very important point.

Panasonic has introduced a translator which doesn't talk: "Designed for use by the travelling businessman,

tourist, or student," says the announcement sent to me recently, "it is ideal for vocabulary practice..." I bet. "Hello = bonjour," it says. It even detects spelling errors.

The reason for mentioning it is that this one (costing £105) can also be used as a calculator for simple arithmetic, plus a converter from imperial miles, feet, pounds and pints to metric kilometres and so on. So, even if the translator turns out to be useless, you haven't wasted your money.

Worth a Try

Second-hand computers — 650 of them — have been sold to UK buyers by CFL, a Coventry based systems house which also sells new Honeywell and General Automation minicomputers. So far the company is not into used micros but bigger machines. If you've got one to sell, this company is now moving into the Middle and Far East and on the strength of this has boosted its income by 60% over last year (the new figure is £1.2 million turnover).

If you have one to buy, it sounds from these figures as if the average used-computer price must have been (at the outside maximum) £10,000, assuming that all 650 used machines — and no new ones — were sold last year; in fact, that obviously isn't the case and it looks like CFL can sell £5000 used machines. Check it out on 0203 58318.

Amusing Jobs

Smart lad/lass wanted: one of the most fascinating jobs

one could ever imagine has just been set up by the Government as part of its £9 million project to boost computers in education.

The project is one of the jobs to be done by MUSE — minicomputer (and micro) users in secondary education — and it involves working out a way of transferring software written for one machine onto a different one.

John Coll, chairman of MUSE, hopes to appoint two school-leavers as research assistants for this project.

"With a relatively small number of different makes of micro computers in schools," Coll observes, "it seems sensible to have a team making programs available for all."

The two assistants will be appointed to Oundle school, where Coll works, and to Birmingham, which will be a part time job. MUSE is hoping to get something like £30,000 out of the Government project, to be spent over the next academic year. It isn't clear what happens next year, however. The same applies to MUSE's other project — a central information service offering expert advice for teachers struggling with the new technology and discipline of data processing.

MUSE should approach the National Research Devel-

opment Corporation and ask for a further £30,000 to actually develop a machine-based system for software conversion. Not only would this be of much more long-term use to MUSE and the schools it serves, but it might also make MUSE some money, enabling it to hire its assistants for rather more than a year.

But I bet there's some civil service regulation which says you can't finance good ideas like this. Anyway, MUSE can be contacted through Bob Coates, Netherhall School, Cambridge on 0223 42931.

On the Buses

People who buy a computer with a bus inside it do so because they intend to plug extra boards into the computer, not because they think the actual bus itself (the pattern of wires and the signals they carry) is intrinsically good. Yet Zilog has launched a new bus family and justifies the move on the grounds that the bus is intrinsically good.

It's competing with the S100 bus, which will take micro users well into the

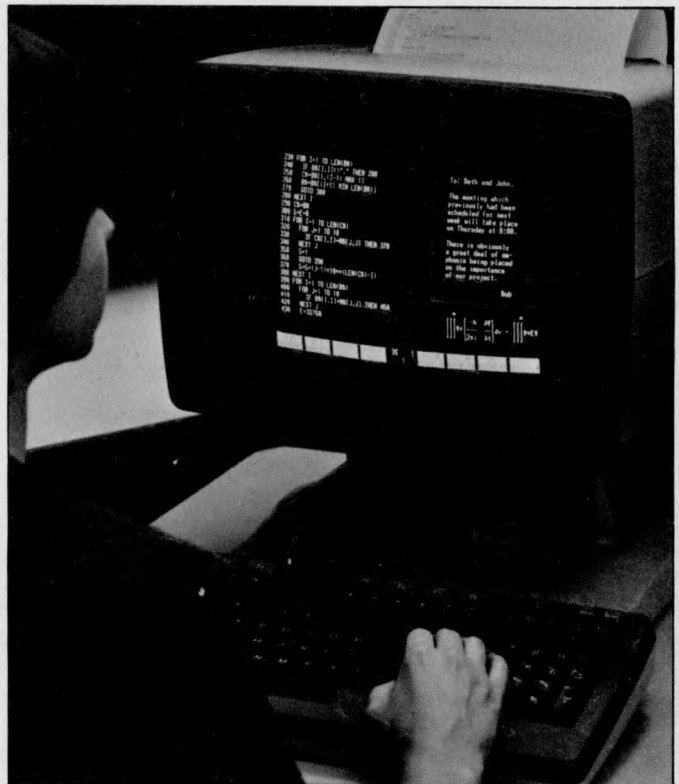

When a manufacturer talks of moving 'up-market', ask the executives how their video output compares with HP's 2626A terminal.

As the photograph shows, it's clear enough to register on film in normal light. It's divided into four independent work areas; each area can be on the screen, or off the screen and moving one around doesn't affect any of the others. Hewlett-Packard calls this multi-window, which describes the process quite well once you understand it. Don't ask how much it costs unless you're going upmarket yourself — price is not its selling point. Oh, all right: it sells for £2275. Also it can talk to two computers at the same time. Details 9734 61022.

1980's and 16-bit computers, and it's competing with Intel's own, rather more expensive, Multibus, which is starting to look as if it won't. Zilog hopes that its Z-bus Component Interconnect (ZBI) will do so.

The reason the Intel Multibus may not last as long as the S100 bus (the one which most computers advertised in this magazine are based) is the ironic one that it was always more ambitious.

Systems using the Multibus as the method of connecting component modules have always tried to go faster, be more sophisticated and more reliable than systems 'thrown together' on the much cheaper S100 bus.

The logic may have a flaw: granted, there are always people who want a superlative product rather than an adequate one but are there enough of them? Intel's Multibus has appealed to many customers but these have been relatively small-volume people compared with the numbers sold on the S100 system. And they remain picky which means that while the people who used the S100 will be able to get by for the next decade by making a few adjustments, the people who wanted the Multibus are now saying that it is running out of steam. It may still be better than the S100, but it isn't good enough.

Zilog say its ZBI is good enough to move into the days of the 32-bit micro. For those of us who need a 32-bit micro, this must be good news...hullo, I seem to have

lost my audience. Surely somebody here wants a 32-bit micro? Not this decade? I understand, sir: sorry.

Wiping Up

Most recent addition to a whole range of cleaning aids for the computer room (the range is called Texwipe) is this packet of Bluewipes, a multi-purpose wiping cloth made from non-woven fabric (like J-cloth) which is durable and absorbent, yet is unaffected by water, detergent and alcohol and contains no additives.

What Mike Brewer of Microsense's parent company (Data Efficiency) doesn't say — but ought to — is that normal tissues do contain additives and they aren't funny. In order to pamper the mucous membranes of the human nasal and anal orifices, tissue paper and bogroll is crammed full of talc. And you know what talc can do for a disk...details on 0442 57137.

Catching the Bug

It's some while since I went into print with news of problems on the Anadex DP9500 printer. The problems then were that it was supposed to be available 'off-the-shelf' which should mean immediately, and yet people were waiting months for them; it also misbehaved when asked to run at its higher speed.

It's a very nice printer on

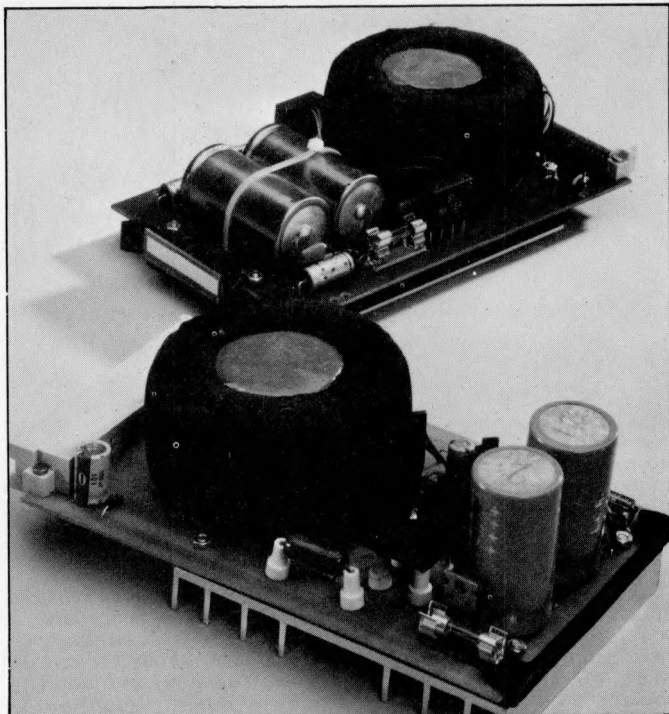

Many power supplies sold with microcomputers are quite powerful enough to drive the computer, but tend to run out of capacity once the user expands. Vero has introduced a supply which provides the standard five volts — but at nearly twice the normal power. It's a 25 watt supply, capable of providing five amps without cooking the wax out of the transformer or turning off the regulator. Either eventuality is what you expect from an inadequate supply. Details 0703 440611.

paper (sorry) and when the bugs are proveably out and the price drops a trifle, it will sell well. It has nice features, such as being able to print a dot anywhere the program specifies along a line, not just in character positions defined by the character generator chip; that means it can draw very detailed pictures. It'll print across 132 characters per line, and at full speed, will print a line in under a second — making it pretty fast.

Its speed, however, is currently the only thing it has over the Oki Microline-80 which sells for half the price and seems to be rather more reliable. It may be that by the time this gets into print, Anadex will have traced the fault, and told me what caused it but until they do, make sure the printer will actually run at its fast speed *on the computer you will be using*. On some, it doesn't. Details from Midlectron, on 077 382 6811, or from Anadex direct.

Siriously Now

For £60, you can add a board to any SS50 based computer an use it to generate the sound of a raspberry tart (rhyming slang) directed at me.

The board is the latest product of the famed Sirius Cybernetics outfit — not Corporation, outfit — in Leamington Spa. It's a

programmable sound synthesiser (the board not the outfit) which can be programmed from either assembler language or Basic programs to produce "a vast variety of sound effects and music from a combination of three independent sound channels which can produce a tone and a white noise."

With the publication of this item, we come to the end of the long-running saga, wherein Sirius Cybernetics and its very existence were the subject of considerable Kewney scepticism. I will admit that I still find it hard to tell people, with any real conviction, that a company was named Sirius Cybernetics roughly at the time when the radio programme *Hitch Hiker's Guide to the Galaxy* was so successfully entertaining Britain with its Sirius Cybernetics Corporation — by people in Leamington who had never heard of the radio show. Stranger coincidences have happened, I know; but I find some of those a bit hard to swallow, too.

However, since my personal scepticism is not a marketable item, I have no shame or hesitation in telling you that I was proved wrong in extending it from a disbelief in coincidences. I was wrong to conclude that Sirius Cybernetics was merely a practical joke, being perpetrated on the world's press.

The company really exists and really has computer

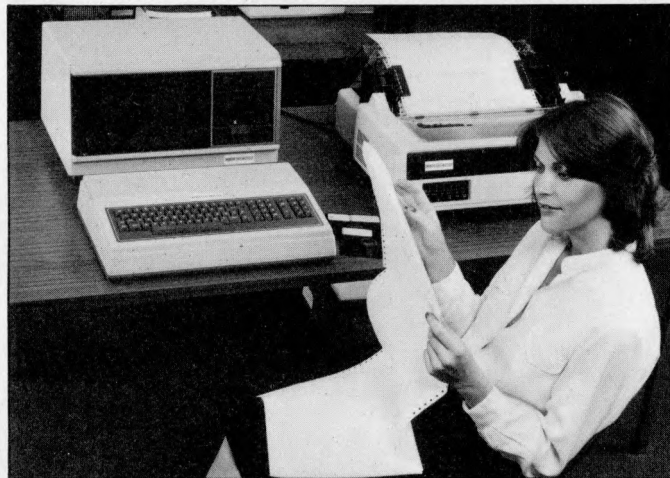

It hurts to admit it, but I can't really say that my old friend Graham Barrat has picked a winner with his £4500 microsystem from Sanyo of France.

His machine looks to stand comparison with the Intertec SuperBrain, which KGB of Slough is now offering at £1500 or so (64 kbytes, minifloppy, nice screen and keyboard all in box and starting to look like a serious rival to the Apple II). For the extra money, the Memory System 7000 (as the Sanyo machine is called here) seems to offer rather more disk capacity, plus whatever quality is built into the software.

Mind you, I have little doubt that the software will be good — Barrat used to run a big computer bureau and should know what users like — then again, at £400 to £500 each, these programs really better be good. Details of Memory System 7000 on 01-836 5342.

Buy a microcomputer for and you could be on your own! Unless it's a Commodore PET



Commodore produce Britain's number one microcomputer. But we don't stop there. We also insist on providing comprehensive support throughout our national dealer network.

Our dealers can examine your needs and demonstrate which hardware and software will suit you best. Their trained engineers are always at hand and a 24-hour field maintenance service is available. Your local dealer can tell you more about the following Commodore Services.

Commodore PET

The Commodore PET computer range covers everything from the self-contained unit at under £500 to complete business systems at under £2,500.

Commodore Business Software and Petpacks

Our software range covers hundreds of applications. Business software includes Sales and Purchase Ledgers, Accounting, Stock Control, Payroll, Word Processing and more. In addition over 50 Petpacks are available covering such titles as Strathclyde Basic Tutorial, Assembler Development System, Statistics, plus our Treasure Trove and Arcade series of games.

Commodore Approved Products

Compatible products of other manufacturers with Commodore's mark of approval are also available.

Commodore Courses

Commodore offer a range of residential training courses and one day seminars. An excellent start. And when you have installed your system the PET User's Club Newsletter can keep you informed of new ideas and latest developments.

LONDON AREA

Adda Computers Ltd,
W5, 01-579 5845
Advanced Management Systems,
EC2, 01-638 9319
Byteshop Computerland,
W1, 01-636 0647
C.S.S. (Business Equipment) Ltd,
E8, 01-254 9293
Capital Computer Systems,
W1, 01-637 5551
Centralex-London Ltd,
SE13, 01-318 4213
Cream Microcomputer Shop,
HARROW, 01-863 0833
Da Vinci Computer Shop,
EDGWARE, 01-952 0526
L & J Computers,
NW9, 01-204 7525
Home and Business Computers,
E12, 01-472 5107
Merchant Systems Limited,
EC4, 01-353 1464
Metclean Ltd,
SW1, 01-828 2511
Micro Computation,
N14, 01-882 5104
Micro Computer Centre,
SW14, 01-878 3206
Sumlock Bondain Ltd,
EC1, 01-250 0505
Sumlock Bondain Ltd,
EC4, 01-626 0487
T.L.C. World Trading Ltd,
WC2, 01-839 3894
TOPS TV LTD,
SW1, 01-730 1795

HOME COUNTIES

G. M. Marketing,
ANDOVER, 790922
HSV Microcomputers,
BASINGSTOKE, 62444
MMS Ltd,
BEDFORD, 40601
Elex Systems Ltd,
BRACKNELL, 52929
DDM Direct Data Marketing Ltd,
BRENTWOOD, 229379
Amplicon Micro Systems Ltd,
BRIGHTON, 562163
RUF Computers (UK) Ltd,
BURGESS HILL, 45211
T & V Johnson (Microcomputers
Etc) Ltd, CAMBERLEY, 20446
Cambridge Computer Store,
CAMBRIDGE, 65334
Wego Computer Ltd,
CATERHAM, 49235
Dataview Ltd,
COLCHESTER, 78811
South East Computers Ltd,
HASTINGS, 426844
Alpha Business Systems,
HERTFORD, 57423
Brent Computer Systems,
KINGS LANGLEY, 65056
Isher-Woods Business Systems,
LUTON, 416202
South East Computers Ltd,
MAIDSTONE, 681263
Micro Facilities Ltd,
MIDDLESEX, 01-979 4546
J. R. Ward Computers Ltd,
MILTON KEYNES 562850
Sumlock Bondain (East Anglia) Ltd,
NORWICH, 26259
T & V Johnson (Microcomputers
Etc) Ltd, OXFORD, 721461
H.S.V. Microcomputers,
SOUTHAMPTON, 22131
Super-Vision,
SOUTHAMPTON, 774023
Xitan Systems Ltd,
SOUTHAMPTON, 38740
Stuart R Dean Ltd,
SOUTHEND-ON-SEA, 62707
The Computer Room,
TUNBRIDGE WELLS, 41645
Orchard Electronics,
WALLINGFORD 35529

Petalect Ltd,
WOKING, 63901
Oxford Computer Systems,
WOODSTOCK, 811976

MIDLANDS AND SOUTH HUMBERSIDE

Byteshop Computerland,
BIRMINGHAM, 622 7149
CPS (Data Systems) Ltd,
BIRMINGHAM, 707 3866
Camden Electronics,
BIRMINGHAM, 773 8240
Computer Services Midlands Ltd,
BIRMINGHAM, 382 4171
Cattlands (Computers) Ltd,
BURTON-ON-TRENT, 812380
Ibek Systems,
COVENTRY, 86449
Jondane Associates Ltd,
COVENTRY, 664400
Davidson-Richards Ltd,
DERBY, 366803
Caddis Computer Systems Ltd,
HINCKLEY, 613544
H.B. Computers,
KETTERING, 83922
Taylor-Wilson Systems Ltd,
KNOWLE, 6192
Machsize Ltd,
LEAMINGTON SPA, 312542
Office Computer Techniques Ltd,
LEICESTER, 28631
Lowe Electronics,
MATLOCK, 2817
Betos (Systems) Ltd,
NOTTINGHAM, 48108
Byteshop Computerland,
NOTTINGHAM, 40576
Keen Computers Ltd,
NOTTINGHAM, 583254
Tekdata Computing,
STOKE-ON-TRENT, 813631
Systems Micros,
TELFORD, 460214
McDowell Knagg & Associates,
WORCESTER, 427077

YORKSHIRE AND NORTH HUMBERSIDE

Ackroyd Typewriter & Adding
Machine Co. Ltd, BRADFORD, 31835
Allen Computers,
GRIMSBY, 40568
Microware Computers Ltd,
HULL, 562107
Microprocessor Services,
HULL, 23146
Holdene Ltd,
LEEDS, 459459

South Midlands Communications Ltd,
LEEDS, 782326
Yorkshire Electronics Services Ltd,
MORLEY, 522181
Computer Centre (Sheffield) Ltd,
SHEFFIELD, 53519
Electronic Services,
SHEFFIELD, 668767
Hallam Computer Systems Ltd,
SHEFFIELD, 663125

NORTH EAST

Dyson Instruments,
DURHAM, 66937
Currie & Maughan,
GATESHEAD, 774540
Wards (Office Supplies) Group,
GATESHEAD, 605915
Elfton Ltd,
HARTLEPOOL, 61770
Fiddes Marketing Limited,
NEWCASTLE, 815157
Newcastle Computer Services,
NEWCASTLE, 615325
Format Micro Centre,
NEWCASTLE, 21093
Tripoint Associated Systems
Consultants Ltd,
SUNDERLAND, 73310

SOUTH WALES AND WEST COUNTRY

Radan Computational Ltd,
BATH, 318483
Computer Corner,
BAYSTON HILL, 4250
Bristol Computer Centre,
BRISTOL, 23430
C.S.S. (Bristol) Ltd,
BRISTOL, 779452
T & V Johnson (Microcomputers
Etc) Ltd, BRISTOL, 422061
Sumlock Tabdown Ltd,
BRISTOL, 26685
Sigma Systems,
CARDIFF, 34869
Office and Business Equipment
(Chester) Ltd, DEESIDE, 817277
A.C. Systems,
EXETER, 71718
Micro Media Systems,
NEWPORT, 59276
J.M. Computer Services Ltd,
NEWQUAY, 2863
Devon Computers,
PAIGNTON, 526303
J.A.D. Integrated Services,
PLYMOUTH 62616
Business Electronics,
SOUTHAMPTON, 738248
Computer Supplies (Swansea),
SWANSEA, 290047

NORTH WEST AND NORTH WALES

Tharstern Ltd,
BURNLEY, 38481
B+B (Computers) Ltd,
BOLTON, 26644
Preston Computer Centre,
PRESTON, 57684
Cattlands (Computers) Ltd,
WILMSLOW, 527166

LIVERPOOL

Aughton Microsystems Ltd,
LIVERPOOL, 548 7788
B.E.C. Computers,
LIVERPOOL, 263 5738
Rockcliff Brothers Ltd,
LIVERPOOL, 521 5830

MANCHESTER AREA

Byteshop Computerland,
MANCHESTER, 236 4737
Computastore Ltd,
MANCHESTER, 832 4761
Cytel (U.K.) Ltd,
MANCHESTER, 872 4682
Executive Reprographic Ltd,
MANCHESTER, 228 1637
N.S.C. Computer Shops Ltd,
MANCHESTER, 832 2269
Sumlock Electronic Services
(Manchester) Ltd,
MANCHESTER, 834 4233
Professional Computer Services Ltd,
OLDHAM, 624 4065
D. Kipping Ltd,
SALFORD, 834 6367
Automated Business Equipment Ltd,
STOCKPORT, 061-432 0708

SCOTLAND

Holdene Microsystems Ltd,
EDINBURGH, 668 2727
Microcentre,
EDINBURGH, 556 7354
Aethrol Consultancy Services,
GLASGOW, 641 7758
Byteshop Computerland,
GLASGOW, 221 7409
Robox Ltd,
GLASGOW, 221 5401
Mac Micro,
INVERNESS, 712203
Thistle Computers,
KIRKWALL, 3140

IRELAND

Softech Ltd,
DUBLIN, 784739
Medical & Scientific Computer
Services Ltd, LISBURN, 77533

To: Commodore Information Centre,
360 Euston Road, London W1 3BL. 01-388 5702

PCWD4

Please send me further information about the Commodore PET.

Name _____

Position _____

Address _____

Intended application _____

Do you own a PET? YES NO

commodore

This list covers dealers participating in our advertising.



In tests, eleven out of ten PCW staff were unable to tell the difference between Tandy's new hand-held micro and the Sharp PC1211. To confuse things yet further, Tandy's new offering is called the TRS-80 Pocket Computer — I really wish Tandy would think of a TRS-something else. It will be on sale here in October and will cost £119 inc VAT; the cassette interface is priced at £17.95. Tandy says that software packages will also be sold at prices between £8.95 and £13.95.

boards for sale. And it now includes a telephone number on its letterheading: 0926 87342.

But don't mention my name when you ring. Or, if you do, spell it Em You Dee.

Texas Talk

Making a computer talk in an American accent is now possible for the home builder as well as the built-system buyer. A guide to designing speech circuitry with Texas Instruments chips, such as the set in the home 99/4 computer, is available. It's the *Solid State Speech Products and Services Brochure*, and details are available on 0234 67466.

The Soft Sell

The biggest potential competitor in the market for ready-cooked software, the market currently dominated by Petsoft, has yet to really show its paces.

Microtrend, set up by our own contributor David Hebditch with Dutch money, has announced an initial range of various packages for several micros but still hasn't made the impact that it may do once it gets the distributors to stock its products. In the meantime, it's extended its range of machines with a deal, signed with a Swedish micro company's UK agent, to cover the Luxor ABC-80.

This micro is marketed in the UK by Dr Frank Taylor, once a consultant with the NCC and now working for himself. He's a standards expert, and his company, Microtech, distributes the Luxor machine — which he claims is "currently a best seller in the discerning Scandinavian marketplace."

So far, the ABC-80 has proved to be a slightly expensive rarity in this country and has relatively few devotees. It doesn't use the S100 system, nor any other American-designed standard bus, and software for it is therefore hard to come by.

If Microtrend gets itself right off the ground, this situation may change. Microtech will handle the work of converting Hebditch's software to run on the Luxor computer, but Microtrend will help distribute and market the programs.

I wish I knew how well Hebditch's chess playing program, Gambiet 80, did in the PCW championships (I'm scribing this just before the event). That was written for the Z80 micro (which is in the Luxor machine) and Hebditch made impressive claims for its playing ability before the games. He said it had beaten Sargon, among a great many others. If it's that good, Taylor's lot will want to convert it quite quickly.

Details from Microtech on 0565 52911 and from Microtrend on 0423 711878.

S100 Graphics Boost

Now that we have a cheap British machine with S100 standard slots, the Transam Tuscan, devices like the high resolution graphics board built to this standard by Digital Devices' supplier become more directly relevant to the less affluent users.

The board is the Matrox ALT-256**2, which is a daft name for something you have to ask for over the counter. It provides an 'image' for a video output and ensures that whenever the computer alters that image, the resulting flashes don't get transmitted to the screen, thus avoiding the common snowstorm effect of less careful systems. Some 256 x 256 dots are covered; that fills around 8 kbytes of 'image memory' which is higher resolution than many, even if not the highest on the market.

No price is available yet, from which you can deduce that it isn't the price which sells it. Details on 0892 37977.

Approved PET Food

A catalogue of Commodore-approved software for the PET computer is available. It's a list of dealers, each starring a favourable item or a few items of code under various headings, such as Business, Medical, Education and so on. Some 50 programs are described in enough detail that you can tell whether they will run on your machine; memory size, type of PET, type of peripherals needed and so on, are given in most cases.

Less interestingly, the catalogue also includes PET peripheral products. While it's nice to know that there are products which carry the Commodore seal of approval, evaluation of a printer is a much simpler matter than the problem of finding out whether you actually like the way a particular program runs.

The catalogue is available from Commodore's London information centre on 01-388 5702.

KGB Swoop

The list of dealers for the SuperBrain, given in this column by the Editor last issue, has just been overtrumped. An independent operator, KGB Microcomputer Systems, has set up in Slough High Street, flogging them at £400 off for around £1500.

At that price, these nice machines should start to sell. So far there are only some 500 to 700 SuperBrains in this country, the same order of magnitude of the number of dealers in America.

KGB isn't the approved dealer, or even one of the approved dealers. The company is not saying where it gets its supplies, or how... just in case the angry authorised dealers move to have them cut off, perhaps, or

in case it turns out to be the manufacturer, trying to put a bomb under the market. Either way, it looks like the beginning of a good slanging match, because I'll bet that the next thing the authorised dealer network says is "He can't support them at that price."

The machine that plays with itself

Chess master David Levy has announced his very own chess-playing micro and has been inconsiderate enough to tell me about it for this issue. This means that the World Chess Championships for microcomputers will be over and done by the time you read this but I have to write about it beforehand. What a shabby trick! (*Don't worry — it's not competing — Ed*).

The micro is unique, claims Levy, in eight ways. First, it's a sophisticated game, not just a plug-in program for a video ping-pong set; it displays the chess board and pieces in full colour on a TV (a colour one, of course).

Second, it includes a built-in video cassette recorder (not admittedly, one which can record Starsky and Hutch) to record up to 1000 full games on ordinary audio cassette tape. The player can add his own commentary: "This is where the machine made a fatal error," or "That error the machine made earlier now turns out to have been less fatal than I originally thought."

Third, each game comes with a free audio cassette to teach you how to operate the machine. There are other cassettes, including all the tournaments and match games ever played by Bobby Fischer, all Karpov's games (about 800 each) and all named opening variations, about 300.



Intelligent Chess, the new chess computer from Optim Games. See 'The Machine That Plays With Itself'

BASF gives a Good Deal

To an entrepreneur building up his own business, or to a company needing to distribute its data processing, the BASF 7120 gives a good deal.

Our 7120 is basically a stand-alone microprocessor giving high performance at low cost. It's a powerful desk-top computer for around £5,500.

The main features include:

- * Main memory of 64 K bytes
- * File control system memory of 24K
- * Dual Z80 microprocessors
- * Extended BASIC for business applications
- * CIS COBOL and CIS FORMS 2 for interactive programming
- * Specially designed keyboard to ease operator interface
- * Free word processing package.

The whole deal is offered by BASF, whose computer interests also include supplying media, CPU's, add-on memory and plug-compatible peripherals for large mainframes.

Finally the deal is completed by selected dealers providing sales and technical support where you need. Including Computer Services in Canterbury, Dataforce in Bristol, Dataview in Colchester, Davies & Brown in Shoreham, HB Computers of Kettering and Verles in Birmingham.

For more information and the name of your nearest dealer, please contact: BASF Computers, Haddon House, 2-4 Fitzroy Street, London W1. 01-637 8971. Ext. 30.



BASF

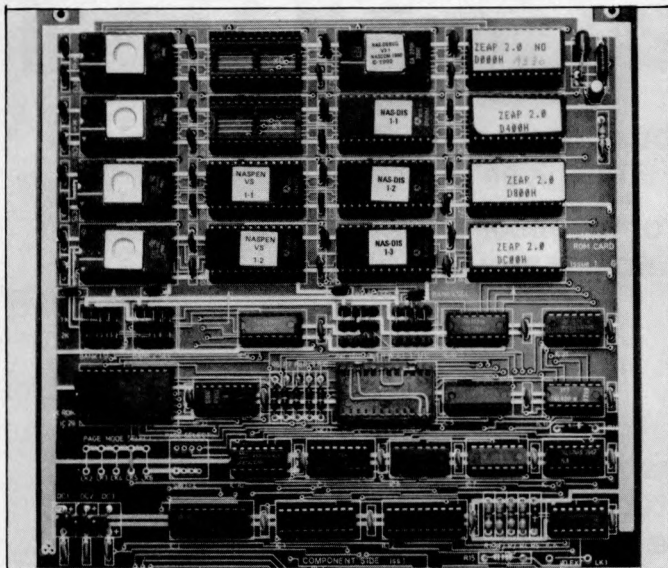

If nobody else likes Nascom, its founder does. John Marshall's new company is Interface Components and just about its first announced product is a board to hold Nascom firmware — up to 40 kbytes of it. The board will attach to both Nascom 1 and 2 and has room, for example, for the Naspen letter writer, the Zeap assembler and editor, the Nas-dis disassembler and Nas-debug and still you can plug your own programs into another six sockets. Details on 02403 22307.

Fourth, any square on the board (or squares) can flash. This may be useful in teaching chess, I suppose.

Fifth, the computer can be tortured into revealing what its next best move would have been, and compelled to play that move. And the next best, and the next, right down to the only move left.

Sixth, the machine can be stepped through a pre-recorded game move by move.

Seventh, it can unplay a game to the point where you want to play something cleverer.

And finally, it can be left alone to play games with itself, in a shop window or at an exhibition.

It costs a mere £295 including tax, and will be available from October. Mike Johnson, winner of our first championship, wrote the software, and Barry Savage, designer of the Softy PROM programmer, designed the circuits. Levy provided the blueprints. Details: Optim Games on 0279 54547.

Motor Control Chips

A chip to build into any system that must control electric motors has been released by Motorola. It's a complex type of chip, using the magnetic characteristics of the alternating current series motor to provide information feedback to a triac (which slices the power up into fat or thin pulses to run fast or slow) — which drives the coils. Details on 0908 610035.

Info Happenings

Nobody would ever bother to report all of the 400 conferences, seminars, tutorials, briefings and other happenings organised by Infotech for the rest of 1980 — except, of course, Infotech itself. The booklet runs to 25 pages, and is available free from Maureen Nichols at Nicholson House, Maidenhead. Details on 0628 39101.

ZX80 Add-ons

It was quite cheeky of Clive Sinclair to claim that his ZX80 microcomputer could be used to control a power station or run a business but for those who took this statement at face value, help is on the way: it may be able to control a toy train. Extra components to add on to the ZX80 can be expected to appear from several outside suppliers, now that the original machine has passed the 20,000 sales mark (at the time you read this, that is). First to appear are an add-on memory board, which also offers some control over external devices, and a power supply.

The add-on memory looks like a much better bargain than Uncle Clive's own product which provides a mere 4 kbytes of RAM. This one costs £79 (built assembled and tested) and provides 16 kbytes; for an extra £10, the board will include 24 parallel input and output lines "for controlling music synthesizers, model train layouts,

or whatever you wish," says the maker, Timedata. The power supply will drive the memory board and will also drive the ZX80 itself. It costs £29, and if used to drive the ZX80, takes the heat-producing job of voltage regulation out of the micro's own case, cooling it down somewhat. All these prices include tax. Details from 57 Swallowdale, Basildon, Essex.

Well I never

Amateur computerists are putting memory chips to uses that their makers certainly never planned. One of the strangest of these is the harnessing of EPROMs as tapes.

Amateurs who have written long programs tend not to like waiting the quarter-hour or so that it takes to read the code into their systems from a cassette tape. Instead, they load it into a blank EPROM with a PROM programmer. Then, when they have tired of it, they erase the chips with ultra-violet light.

All of which explains why Newbear is happily selling EPROM-erasing cabinets, not just to big software houses which retail software in chip form but also to people who can't even afford a disk. Details from Jon Day on 0635 30505.

Nascom Lives!

At the time of writing, Nascom (Britain's first and biggest computer kit company) appears saved. The deal had not been signed but was looking certain.

The deal was between Manas Heghoyan, who runs a printed circuit board company in Watford and the receiver of the company

(accountant Cork Gulley) and all that remained to do was to take stock and make sure the books were straight.

Heghoyan won't say what he paid for the company, but sources indicate that it was quite a bit less than the half million sterling which the company owed when it was originally put into liquidation. Grovewood Securities, the backer which backed out, is therefore presumed to be paying for its timidity in dropping the company just as it was starting to make money.

The new boss is quite a different person from John Marshall, the founder. He started his career as a computer designer, putting together the high technology of English Electric's 1965 vintage System 4 mainframes which were killed off when the ICT 1900 range was selected by ICL as 'the way to go'. He built up his PCB factory in Kington, Hertfordshire, literally from the ground, acting as architect, builder, and financier and obviously plans to build future Nascom products himself.

One thing he is not (at the time of writing) is an expert on Nascom. Unlike many however, he did not try to cover ignorance when I met him. Instead in a determined drive to pull the company back into good shape he was busy hiring the consultancy services of Tony Rundle, one-time software director of Nascom, and now working for Systec consultants. If I were one of the 19,000-odd users of the Nascom design, I would be pleased to see him take over.

Clean Sweep

Any gonzo with a tongue depressor and some rubbing

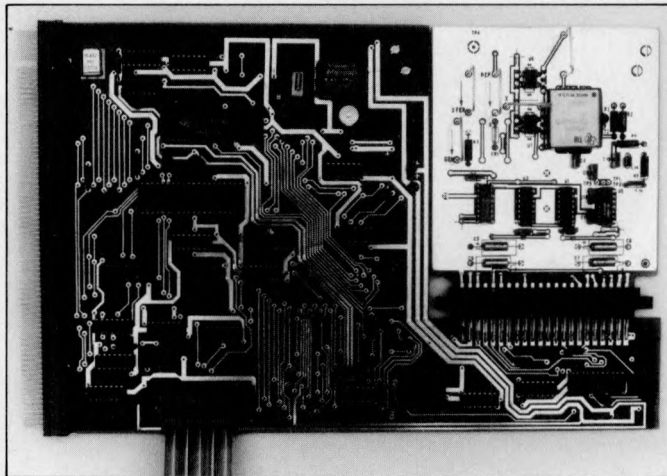

The first British micro kit to have a bubble memory may be your Nascom. A new board has been announced by Microdata Computers which offers a small storage capacity of 92,304 bits (that is, around 10 kbytes) which will never evaporate, even if you turn the power off by my own favourite method of tripping over the power cable. The bubbles are in that square tin can in the white section of the board — which carries a little map of Texas, indicating that they are Texas Instruments bubbles. Details and prices from 01-848 9871.

alcohol can set up in business cleaning disks. Cleaning the drive which holds the disks when in use, isn't so easy and if you think it isn't necessary, you haven't seen the sort of disaster I saw recently at the offices of Commodore's publicity agency. There, the simple process of putting in a new window in a partition wall had filled the drive with enough dust to ruin four disks.

To clean the drive, you put a special cleaning disk into it. Some 20% of its surface is wet with a special cleaning fluid, the rest is dry, and as the drive tries to read it, the cleanser alternately wipes the heads with the solution and then with the dry surface. Neat, isn't it? Details on 01-941 4066, from BFI Electronics.

everybody uses it and yet they don't use Zilog's own very special language for programming it, PL/Z. Learn the language through Software Architects, authorised course-runners for Zilog, in a three-day course at the Holiday Inn in North London; get details on 01-734 9402.

using the £34 light pen announced by Bill Unsworth's company, U—Microcomputers of Warrington. A simple PEEK instruction checks the light pen's photoelectric sensor, to see if the part of the screen it's pointing at is emitting light and then software follows the pen around the screen. There is a sample program available (which comes free with the pen) on cassette, in case you think it's too complex. Details on 0925 54117.

PL/Z Revealed

Zilog makes the Z80 micro;

Making Light

Draw on the television screen of your Apple computer by

YANKEE DOODLES

Tom Williams reports from California with some thoughts on the future



This is by way of being a gadfly, a bubble-popper, indeed little short of a wet blanket. There are a lot of illusions and tacit assumptions afoot about the future of microcomputers, which, while not impossible, do tend to gloss over many of the problems standing in the way of all those delirious dreams.

“...compromises have been made which turn out to be quite inefficient.”

Computers are getting bigger as they grow smaller. We are now witnessing the spectacle of galloping hardware development outracing the ability of the software industry to keep up — let alone to fully utilize the enhanced capabilities of the newer processors. Not only have newer operating systems come along which try (not always successfully) to be compatible with existing applications programs but in trying to adapt existing operating system software to newer hardware, compromises have been made which turn out to be quite inefficient.

A classic example came with the introduction of hard disks to micros. Existing operating system software was not able to efficiently handle the increased capacity because the sector size was geared to floppies and required too great a percentage of disk space to keep track of directory and other house-keeping. In a couple of instances the hard disk itself was not treated as a physical entity, but was divided up into “virtual disks” that appeared to the programmer just like a large number of floppies. This may at first seem to be a convenience from the user's point of view, but it's really just a patch and terribly wasteful of

space on the hard disk.

So what are people going to do with 16-bit micros, and (saints preserve us) the 32-biters? No doubt there'll be a great many fascinating things that can be done with them, but it will be a shame if the software proves to be an impediment. The increased speed and capacity of the new machines could really bring about the level of simulation — colour, real time, complex parameters, etc. that have been in the dreams of educators but which are not yet really possible on today's 8-biters. It's well to realize that hardware alone won't do the trick.

Another popular myth, prevalent in one form in Britain and another in the States, is that access to huge data bases will instantly give us all that information we need to make our lives simpler and more productive. Yes, data bases will contain a great deal of information, but getting to that information and getting it in a form we can easily use is not a problem that's seen a lot of attention.

“...a shame if the software proves to be an impediment.”

The shape and organisation of a data base tends to reflect the interests and priorities of the people who created it and not those of a broad and general public. We often walk into a library to research a problem that we've only vaguely defined in our minds. It's only after interacting with the ‘data base’ and with human resources (librarians and bibliographers) that we are able to focus the direction of our search. This direction may take us on an entirely different path than we originally anticipated. The point is that in a library — a social institution — we're dealing with more than just structured information. In today's data bases, the

user is left on his own to find a way through the maze, or, worse yet, is led along a narrow path wearing blinkers which prevent him from seeing things that might aid his quest.

At the risk of sounding downright reactionary, I'll allow myself the following analogy. It's been said of microcomputers that they represent to the human mind what steam engines of the Industrial Revolution meant to human muscles. Human production did take a quantum jump as a result, but there's another side to the analogy... over-reliance on machines caused some people's muscles to go flabby. I submit that the same can be said of micros.

I'm thinking, for example, of the newer cash registers, which instead of numbers on the keys, have pictures of the sandwiches, drinks, etc. served by the establishment. Theoretically, one could train an orangutan to operate such a machine (the only impediment being the unions) but what if something goes wrong? It's here that I cease my ravings and turn to substantive items.

There's long been talk of a new Radio Shack computer with colour capability and despite Tandy's efforts, it hasn't been able to hide the fact that it has been working on it. The recent introduction of the Videotex terminal indicates that it might have the same screen configuration — 40 characters — 16 lines, and relatively low resolution

“...hardware alone won't do the trick.”

graphics. This would be in keeping with Radio Shack's arrangement with MicroNET, by which the network service will change its display format to be compatible with the new terminal. If these suspicions turn out to be true, the long awaited new TRS-80 may turn out to be something of a disappointment.

On a more business orientated front, however, look for something new from Germany in the near future. A certain company there is preparing to market a machine put together out of the German Kontron system, a very sophisticated machine with high resolution black-and-white graphics and the new 5¼” Winchester disk drive by Shugart Technology (not to be confused with Shugart Associates, the original company). This should mark the first instance of a consumer/personal computer using the new, small Winchester.

For much more sophisticated systems, National Semiconductor has introduced a new family of 16-bit microprocessors, the NS 16000 line. One member is especially adapted to handle high level languages, and another can, in combination with a memory management chip (MMU), be used to construct a computer with virtual memory capabilities.

“...the user is left on his own to find a way through the maze.”

In virtual memory, the processor generates ‘virtual addresses’ and the memory manager then translates these into physical addresses which can be either in RAM or on disk. The important thing is that to the programmer, all addresses appear as if they are part of one, continuous memory. It may well be said that such capabilities are beyond the abilities or needs of users of personal computers. But, bearing in mind my earlier tantrum, if proper software is developed to take advantage of the power — software that is a *superset* of existing software — then human imagination will do the rest, and we needn't worry about our brains going flabby.

COMPUTECH for apple

COMPUTECH for ITT

Well proven software (several hundred packages already licensed) for business applications on the ITT 2020 and Apple microcomputers.

Prices excluding V.A.T for cash with order. F.O.B London NW3

PAYROLL	(300+ Employees, 100 Departments, hourly, weekly, monthly. Very powerful but easy to use).	£375
SALES LEDGER	(500+ Accounts, 100 Departments).	£295
PURCHASES LEDGER	(500+ Accounts, 100 Departments).	£295
GENERAL (OR NOMINAL) LEDGER	(1000 Accounts, 100 Analyses, multi-purpose package).	£295
UTILITIES DISK 1	(Diskette patch, slot to slot copy, zap etc).	£20
APPLEWRITER	(Word Processing)	£42
VISICALC	(Financial Modelling, Costing, Analysis)	£95

AND NOW HARDWARE!

COMPUTECH DIPLOMAT H/S SERIAL INTERFACE £80

This card has been designed and built to the same professional standards that have resulted in the success of our software. The DIPLOMAT observes the proper "handshaking" protocol so that you can drive fast printers and send and receive data from other peripherals at high speeds without loss of data. Switch (& software) selectable baud rates to 19200 and many other options. Plug compatible with 'terminal' or 'modem' wired peripherals. Guaranteed.

MICROLINE M80 PRINTER £450

This neat, reliable machine prints at 10 characters per inch, 80 characters on an 8 inch line, or 40 expanded characters, or 132 very readable characters, upper and lower case and graphics, 9 x 7 dot matrix, 6 or 8 lines per inch. Parallel interface is standard, serial optional. Both friction and sprocket feed are standard, tractor optional. We can also supply the parallel interface card for Apple System computers for £80 and a driver to enable both text and graphics to be used. Optional custom colour matching for Apple or ITT.

THE FABULOUS MICROMUX 8000 from £800

This is a brand new product, an asynchronous serial multiplexor with up to 16 ports, any one of which may communicate with any other independently, like a 'telephone exchange' for data! Built in test function. Firmware may be customised for special applications. Available in multiples of 4 ports up to 16.

COMPUTECH SYSTEMS

168, Finchley Road, London NW3 6HP. Tel: 01-794 0202

AGENTS THROUGHOUT THE UK AND OVERSEAS

PCW welcomes correspondence from its readers. Be as brief and concise as possible and please add "not for publication" if your comments/questions are to be kept private.

Address letters to: "Communications", Personal Computer World, 14 Rathbone Place, London W1P 1DE.

Talkers wanted

I am trying to organise a series of talks for the Kirklees Computer Club on the following subjects: Monitors, assembler languages (particularly 6502), error-handling techniques, disk operating systems (particularly CP/M), Pascal, Fort, Fortran. The audience will comprise people ranging from those with little or no knowledge or experience of personal computers to those who have owned one for some years.

Can I appeal for anyone who is willing to come to Huddersfield on a Monday night to talk on one of the above subjects for about two hours to write to me or phone Dudley Stilton on Huddersfield (0484) 652862. A Starkey, 46A Mill Moor Road, Meltham, Huddersfield

Animistics 1

I found Mr Frude's article on Animistics fascinating and it is all too possible that 'your plastic pal that's fun to have around' will one day be introduced by, who else, the Sirius Cybernetics Corporation. However, I feel that people's attitudes to computers are changing in such a way that many will cultivate relationships with straight off-the-shelf micros despite their inhuman, technical appearance. Microcomputer operating systems are becoming so complex that each machine has a 'personality' all of its own; indeed, here in Oxford the computer freaks talk of 'getting to know a new software release' or 'discovering a quirk in the video output' of their favourite machine. This does not mean that the computer is thought of in human terms; the relationship is of a completely different kind. Perhaps a 'hard' relationship with a flashing box is more appropriate to today's mechanised, computerised society than one with a cuddly pet/companion or even with another person: one is master of one's personal computer and the reward for a continuing, successful relationship is greater mastery and control over it — the machine needs no reward in the form of considerate treatment and behaviour towards it, unlike pets and humans. The more one becomes involved

in the hardware/software specifics of one's machine (the things animistics tries to hide behind 'user friendliness') the more it will assume a character, and the more uses one finds for it the more indispensable it becomes. For those of us not spending our time exploring the intricacies of CP/M subroutines it is unlikely that we could have a close relationship with anything which does not involve friendship, trust and caring, but to youngsters brought up with TV games instead of teddy bears, shunning the company of other children to play with hand-held Astro-Invader games, it might well prove to be a natural development. It is hard to decide which is the more daunting prospect: a society which prefers the company of life-size friendly androids to the real thing, or a society which rejects the real thing, preferring to gaze intently at a screen and occasionally tap at a keyboard.

Stephen Page, St Johns College, Oxford

Animistics 2

I read with fascination Neil Frude's article 'Animistics' (July PCW).

While we are running barefoot through the outer fringes of technology, how about a replacement of the blow-up female simulcra advertised in *Playboy* and such like. The blow-up doll market would collapse like a pricked balloon under the onslaught of a computer controlled responsive 'Randy Raquel'. Slot-in ROM pacs can cater for whatever perversion is your bag of beans and vocabulary pre-programmed from murmurs to howls of appreciation.

You may not like the idea but to extend Frude's criteria of probability, 'there is money here, so no doubt they will be built'. No doubt readers will view it as prostitution of technology but this will not stop it (remember $E = MC^2$?).

This is not a new concept. Anyone remember a film called *The Stetford Wives*? Anyhow whatever the final outcome I am sure that it will give a new nuance to the phrase 'dolly birds'. J D Swift, Surrey

Viatron System 21

In reply to Mr Dion's letter in the August issue of PCW, I have a manual entitled *Information for Operators 2111 Data Management Station* which I would be pleased to loan to Mr Dion. This gives no technical information about the circuits or connections on the back of the brute. I understand that there is no micro-processor chip in the system and that it is basically a stock keeping system, and that

1. the company making them has ceased to exist;
2. most of the chips were purpose made;
3. the British agents for the system are Data Design on 01-207 1717 who have the circuits but want about £600 for a copy of the set.

The magnificent keyboard is a mechanical opto system with a nasty tendency to jam up or rather for a key to stay down and corrupt the coding. The keyboard coding does not seem to conform to any of the recognised systems involving 13 bits.

My own feeling is that unless the built-in operating system is what one wants, the best use of the brute is as a case, power pack and a VDU. With a little bit of adjustment I have found the VDU will resolve 32 lines of 64 characters. If Mr Dion has information on the chips, I would be very grateful if he would make this available. J H Whittaker, Tonbridge, Kent.

LA users

My department has recently acquired a PET micro-computer and I would be interested to hear from any Local Authority user or other interested body of their experiences with micro-computers.

In particular I would welcome observations on the level of support for the establishment of a user group for the interchange of experience and software related to design/administrative/management information systems within a technical department.

A J R Evans, Director, Engineering Services, Dudley Metropolitan Borough.

Rip-off?

Time and again when software crosses the Atlantic to this country it seems that the \$ sign is directly replaced with a £ sign for the price. Just what sort of a rip-off is being made by the so-called 'software houses'? While it is understandable that some markup is necessary to pay for import charges of a master copy and for the licensing agreement with an American software house, a 120% increase in the price appears ludicrous.

Surely it is time for someone like yourselves to help micro owners by giving the breakdown in costs of importing a piece of software; this should be done independently as I expect UK software traders can justify any price hike.

Mike Gettings, Wantage, Oxon.

Unfair tape tax

The national press (*Guardian*, 22 Aug) has reported that the Government is to impose a £1 surcharge on blank cassette tapes to benefit the British Phonographic Industry by offsetting losses caused by record piracy.

I regard this as unfair and an imposition on personal computer owners who owe nothing to the BPI. Perhaps readers who agree will lobby or write to their MPs as I have done.

J R Handford, Gosport, Hants.

We agree that personal computerists should not be penalised in this way and we certainly advise readers to lobby their MPs. We might, however, feel a little differently if the £1 surcharge on cassettes sold for computers could be forwarded to programmers whose work had been ripped off — Ed.

No jobs for the boys

I am writing to you in connection with the shocking unemployment figures that exist at present in this country especially relating to the younger group of people.

I would like to know if your magazine could help by

setting aside half a page for any companies or businesses who wish to acquire the services of young and keen computer users to train to the level that will be of service to them.

This letter was prompted by my own experience when I tried to obtain a 26 week training period in a field related to computers/electronics. At present I am at South Bank Poly on an HND Elect.Eng. course and in the course of trying to obtain this training (and I stress training not sponsorship) I wrote to over 65 companies in London and the south-east.

The reply was consistent, no training for students given, however if I contacted them again when qualified, they could guarantee a job for me.

Business is out of touch with reality, they do not seem to realise that no training by a company means no qualification as the diploma/certificate is withheld until this training has been done. Catch 22!!!

I finally got a job in a local government department teaching degree qualified officers how to program in Basic on a 32k PET. The trouble is that I am the one who is supposed to be trained.

Thank you for letting me air my thoughts, keep up the good work in your excellent tome.

Graeme Caselton, Orpington, Kent.

PET pranks

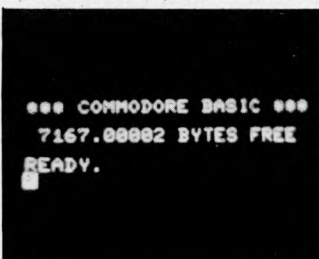

I thought you might like to see the enclosed photo of an 8k PET screen after power-on. It seems to prove that even micros have a sense of humour or perhaps it had just had a good night's rest previously. Anyway, I can deny it represents my efforts at getting a small foothold in the add-on memory business. R D Eberst, Edinburgh

North Star GETting

There's an easier way of GETting characters in North Star Basic ('Computer Answers', August PCW). Version 6 Basic, which comes with Version 5 DOS and is probably what Mr Kirby is using, provides the INCHAR\$() function. This

```
10 PRINT "TOUCH A KEY PLEASE",
20 B$=INCHAR$(0)\REM ASSUME CONSOLE IS DEVICE 0
30 PRINT B$
40 GOTO 10
```

waits for input from the specified device and then returns the character. CTRL-C will interrupt the program as usual, unless it has been disabled in the way Sheridan describes. The sample program thus becomes:

S Withers, University of Warwick.

3D improvement

I was interested in Malcolm Banthorpe's article on 3-D plotting in your July issue. With slight modification, his program is very suitable for use on the HP85. It is possible, by adding a couple of lines, to show also the visible underside of the surfaces and

this I believe improves the picture. Enclosed, with program listing, is an HP85 plot of a variant of his second figure, with visible underside shown.

Professor R H Macmillan, Cranfield, Bedford

```

• 10 SCALE 0,255,0,191
• 20 X1=128 @ X2=X1*X1 @ Y1=96 @
  Y2=96
• 30 FOR X=0 TO X1
• 40 X4=X*X
• 50 A=SQR(X2-X4)
• 60 FOR I=-A TO A STEP 6
• 70 R=SQR(X4+I*I)/X1
• 80 F=(R-1)*COS(18*R)
• 90 Y=I/3+F*Y2
• 95 IF I=-A THEN M=Y @ M1=Y @ Y=
  Y1+Y @ GOTO 120
• 100 IF Y<M THEN 160
• 110 M=Y @ Y=Y1+Y
• 120 PENUP @ PLOT X1-X,Y
• 130 PENUP @ PLOT X1+X,Y
• 140 NEXT I @ NEXT X
• 150 END
• 160 IF Y>M1 THEN 140
• 170 M1=Y @ Y=Y1+Y @ GOTO 120

```

Genie graphics

Research Machines 380Z users will of course be aware of two particularly useful graphics commands, these being GRAPH 1 and GRAPH 0. The former restricts the scrolling of data and instructions to the bottom four lines of the screen, while leaving the graphics intact. The latter command simply reverts the screen to its full scrolling format.

Since changing systems to my own Video Genie (which uses TRS-80 Level II Basic), I have felt the loss of these two commands. Even though Level II Basic is very similar to RML 9k Basic, the graphics on the 380Z are without doubt far superior, but are much easier to use. I would be grateful if you could print two sub-routines which perform the functions described above, and I am sure that all TRS-80/Video Genie users will find them very useful and will save a lot of frustration.

A word of warning for all those who own, or planning to own a Video Genie: while it's an excellent system (I prefer it to the TRS-80), it does have one drawback concerning software compatibility. Since the Genie lacks two TRS-80 keys, the right arrow key and the clear key, any program which relies upon these keys cannot be used to its full potential without modification. However, in using Tandy's excellent new 'Cassette Scripsit' word processing package, I have not found this much of a problem.

R N Braybrooke, Keston, Kent

Anyone out there care to offer the subroutines -- Ed.

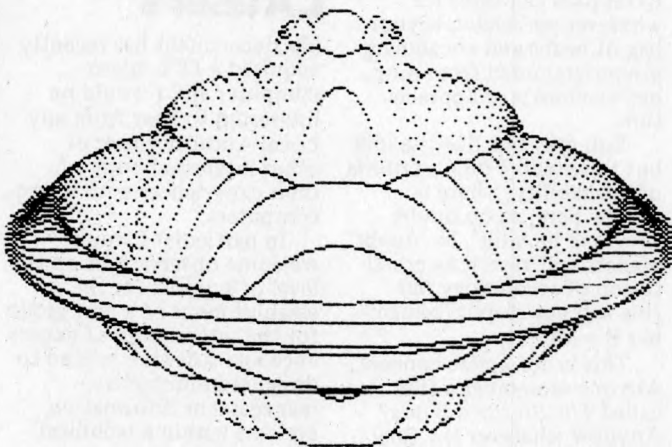

Ohio quickie

In response to your call for short programs, I'd like to offer the following for an Ohio Superboard:

```
1 S=53692+Y :
V=PEEK(S)=49 : POKE
S,49+V : Y=V-V*Y :
GOTO 1
```

Note that V=PEEK(S)=49 is not an error.

P Smith, Middlesbrough, Cleveland.

We haven't tried this and we've no idea what it does, so you're on your own! — Ed.

Personal Computer

World

FEATURE INDEX

Index to current volume, up to, and including, last month. (Previous volumes were indexed in March and April 1980 issues)

Hardware Projects

Z80 Homebrew	3-1
Selective PROM copier	3-3
TV to Monitor conversion	3-3
MK-14 Expansion	3-4
Teleprinter conversion	3-5
Adding a Z80 to a 6800 system	3-7
VCR to PET interface	3-8
MK14 large I.EDs	3-9

Benchtest

Luxor ABC 80	3-1
WH 89	3-2
ACT System 800	3-2
Panasonic JD 700U	3-3
Sinclair ZX-80	3-4
Challenger C2 4P	3-4
Texas TI 99/4	3-5
Altos ACS 8000-2	3-5
Hewlett Packard HP-85	3-5
Benchmark Timings summary	3-5
TRS-80 Model II	3-6
Sintrom Periflex 630/48	3-6
Acorn Atom	3-7
DDE SPC/1	3-7
SuperBrain	3-8
BASF 7120	3-9
CBM 8032	3-9

Series

PASCAL	3-1,2,3,4,5
David Levy's Games	3-1,2,3,4,5,6,7,8,9
On the line	3-1,2,3
Viewdata	3-4,5,6
Pascal Part 10 — Concluded	3-6
IEEE interface — Part 2	3-6
Chess	3-7, 8, 9
Gateways to Logic	3-7, 8, 9
Face to Face — the man/machine interface	3-7, 8, 9
Network Notes	3-7, 9
Secrets of Systems Analysis	3-9
PCW Sub Set	3-9

Fact Sheets

6800 opcodes	3-1
6502 opcodes	3-2

Personal Opinion

The end of work? Lord Avebury	3-1
Protest against technological determinism	3-3
Who needs the CRA?	3-4
Schools computing — David Firnberg	3-4
Stating the obvious	3-5
Micros in big businesses	3-5
Animistics — a look at 'friendly' computers	3-7
Computer/Information technology & the law	3-8

Evaluations (Checkout)

Video Genie	3-2
Vector Graphic Flashwriter II	3-2
Apple II Symtec light pen	3-3
Microdata UV8 EPROM eraser	3-5
Softy intelligent EPROM programmer	3-6
Exatron stringy floppy 380Z High	3-6
Resolution Graphics ROMPLUS+ for Apple II	3-7
Hi-Tech VDU board	3-9

Calculator Corner

TI 58/9 Pseudo opcodes	3-1
Casio Fx 502P Brag	3-1
Casio Fx 501/2P Master Pack	3-2
TI 58/9 Economics Simulations	3-2
Programming efficiency	3-3
Casio random number generator	3-3
HP 41C review	3-4
Artificial Intelligence	3-5
Accounts on TI-59	3-5
Data Packing	3-6
Sharp PC1211 evaluation	3-7
Pentathlon program	3-8
Aid for the blind	3-9

Special Features

Computer Retailers' Association	3-1
Christopher Evans tribute	3-1
Show chess results	3-1
The British Computer Society	3-2
Astrology — case study	3-2
IEEE-488 bus explained	3-2
Economic simulation	3-3
Modem evaluations	3-5
5th West Coast Faire report	3-5
Wave Synthesis on Nascom 1	3-5
Overcoming PET printer problems	3-5
Random numbers	3-5
Sound to colour conversion	3-3
American report	3-3
Simple approach to programming	3-3
Communication aid for disabled	3-4
Imphex — intelligent game PET	3-4
House of Commons report	3-4, 9
Interrupt handling	3-6
Case Study — Compucolor installation	3-6
Poem	3-6
Power supplies explained	3-6
Power supply design	3-6
Program structuring in Basic	3-6
Sandbach school system	3-6
M68000 preview	3-7
Case Study — Apple Installation	3-7
3-D Plotting	3-7
Cassette files	3-8
Printer survey	3-8
Basic Basic	3-9

Package evaluations

Sales Ledger	3-1,8
Purchase Ledger	3-2
Payroll	3-3
Word Processing	3-4
Information retrieval & databases	3-5
Integrated accounts packages	3-6
Stock Control	3-7

Indexes

Back Issues 1-1 to 2-4	3-2,3
Back Issues 2-5 to 2-8	3-4

Programs

BASIC Star Wars	3-1
PET Alien Attack	3-1
Revas (conclusion) Reverse assembler for Z80	3-1
Planet name generator — 6800	3-1
MK-14 scrolled messages	3-3
6800 Keyword retrieval system	3-3
PET Kaleidoscope	3-3
Efficient character storage Z80 Assembler	3-3
UK101 Dodgems	3-4
TRS-80 Fox and hounds	3-4
MZ 80K Sine wave addition	3-4
PET Backgammon	3-5
UK101 Nedge	3-6
PET Horse race	3-6
BASIC Renumber	3-6
Naming Nascom files	3-2
380Z Pictures	3-2
Fuel tank calculations — PET	3-2
PET large numeral generator	3-2
PET tank battle	3-2
BASIC string handling routines	3-2
UK101 Dogfight	3-6
MK14 Frequency counter	3-6
North Star Maths test	3-6
PET Sweeper	3-6
PET Delete/Renumber	3-6
PET Cat and Mouse	3-7
UK 101 Graph Plotter	3-7
UK 101 Black Box	3-7
TRS-80 Graphics	3-7
PET Robot Nim	3-7
PET Golf	3-7
PET Nightmare Park	3-8
PET Dots & boxes	3-9
PET Bloopers	3-9
PET Demolition	3-9
Apple Showpiece	3-9
PEEK & POKE for Apple Pascal	3-9
PET Giant Slalom	3-9

SOUND ADVICE

Adding sound to your micro computer opens up a whole new range of possibilities but until recently it tended to keep the CPU rather busy. Now there's a simpler way, using the easy-to-interface GI AY-3-8910 programmable sound generator chip, as David Harper explains.

The 8910 is well-suited to such tasks as adding sound effects to computer games, or generally giving your micro the power of whines and groans, if not indeed of speech itself. It has 16 programmable registers which control three independent tone generators, a white noise generator, three logarithmically-tapered output level controls, a set of mixers and an envelope shaper with a variety of profiles and variable repetition frequency. As a bonus, the chip also provides two user-defined 8-bit input/output ports. The whole device, which comes in a 40-pin DIL package, draws a modest 60 mA from a single 5 volt supply and is available at around £8.25 + VAT. There's also a 28-pin version, the AY-3-8912, which is identical to the 8910 but provides only a single 8-bit port; this IC, however, does not appear to be as readily available as the 8910 at the time of writing.

With all these facilities at the call of

a micro, you can create from software an almost infinite variety of sounds from explosions, gunshots, whistles and whines to piano notes, clock chimes, and even drum beats and cymbals. The 16 independent registers can be easily and efficiently controlled from Basic via PEEK and POKE commands and the device is also extremely economical of CPU time. Even for fairly complex sounds such as a repeated chime or piano note, it is only necessary to set the registers once at the start of a sequence and the PSG will continue to produce sounds until the CPU resets it. This of course gives it great advantages over less sophisticated sound generators which can monopolise the CPU completely during sound output.

Interfacing

The 8910 was designed for compati-

bility with the CP1600 CPU and since the latter device uses a shared address and data bus, the 8910 cannot be directly hooked up to CPUs such as the 6502 or Z80, whose buses are separate. The easiest way to interface these CPUs to the PSG is to connect the CPU data bus more or less directly to the PSG's shared bus and to use software to generate data which the PSG can use either as an address or as true data depending on the state of its control lines. All that is then required is to create the appropriate set of control signals, which inform the PSG whether the data on its bus is to be used as an address or as true data and whether data is to be read or written.

Figure 1 gives a circuit which does just this; it was evolved for use with the Compukit UK101 and because this machine has no parallel port the circuit was designed to connect to its expansion socket; with very little

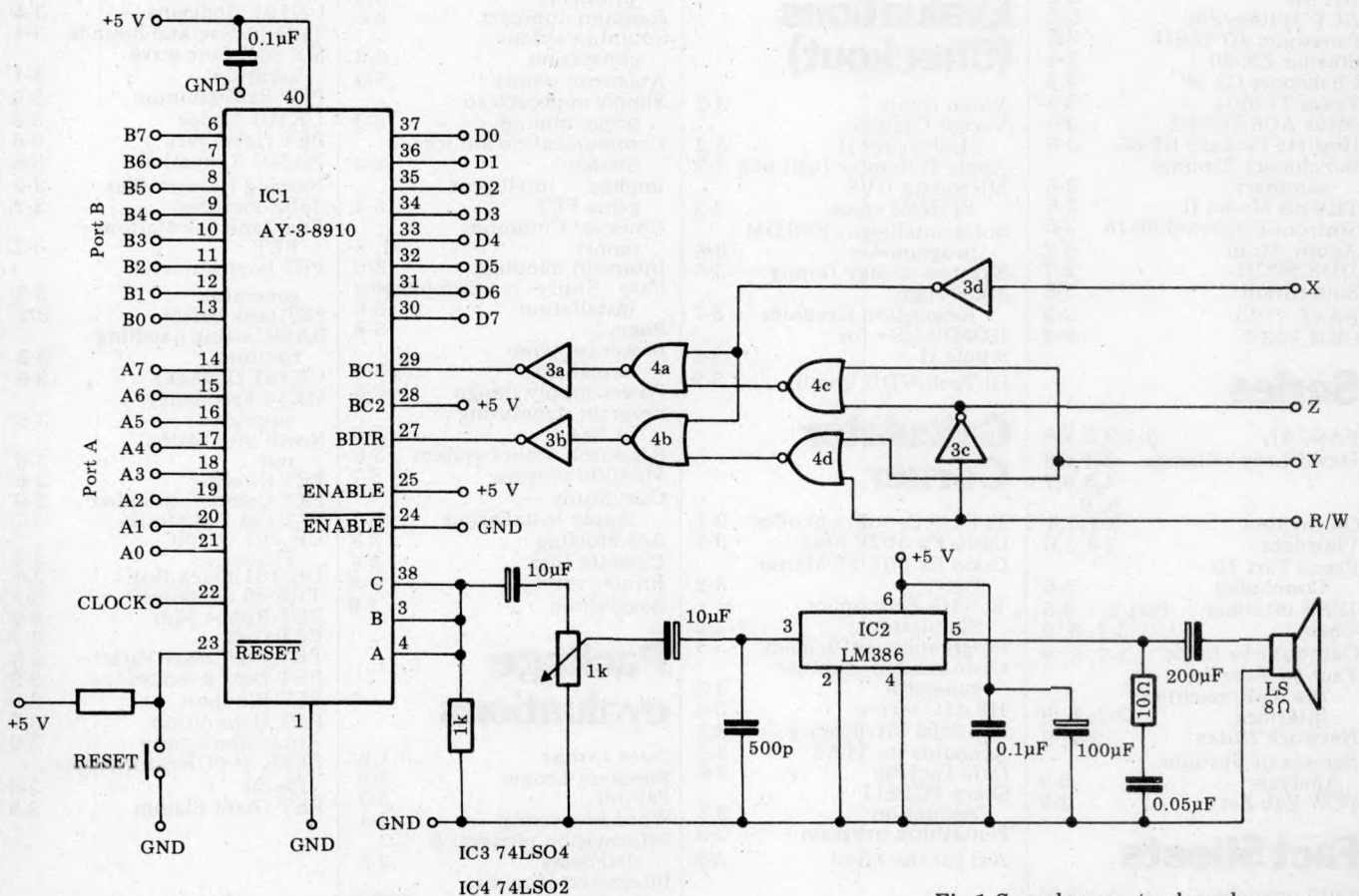

Fig 1 Sound generator board

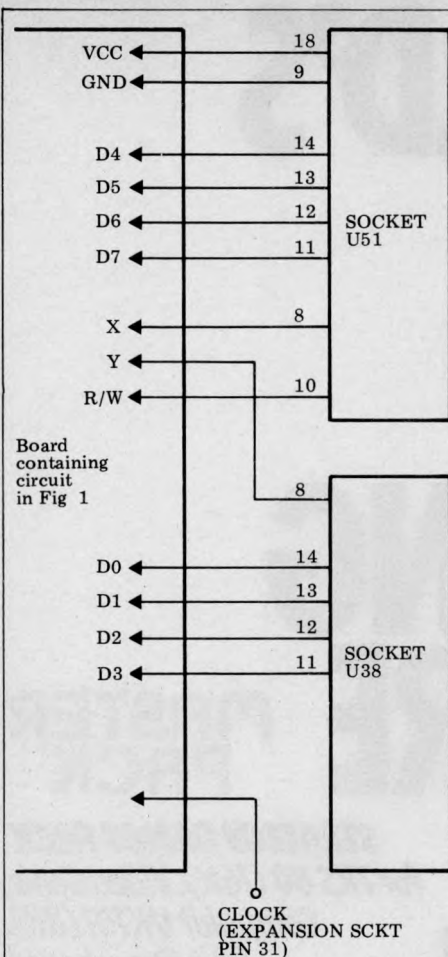

Fig 2 Sound generator board connections to top 2k RAM sockets on UK101. Note that all four 2114s of the top 2k must be unplugged — sockets U37 and U52 must be empty.

modification it should function satisfactorily with almost any 8-bit micro which has separate data and address buses. It is also possible to interface the 8910 to 10 lines of a parallel output port such as is found on many micros and details of this method will be given later. It should be noted, however, that although the hardware for this latter interface is much simpler than for the former, it does suffer from a number of disadvantages. Not the least of these is that it ties up 10 lines of an output port with a device which, because of its great utility, will quite probably be permanently connected to the micro. It also requires rather more complex software, as will be clear later, and of course the ports must be initialised each time after a reset, and between read and write operations. The proposed circuit suffers from none of these disadvantages and achieves the generation of control signals using only two 14-pin DIL packages.

The full circuit for the interface is given in Figure 1. It will be seen from this that pins 30-37 of the PSG carry its shared bus and this should be wired to the CPU's data bus. The chip also has two chip-select pins (24 and 25), though these have been hard-wired since this function is performed via the BC1 and BDIR lines whose operation is explained below. The RESET line is wired to a separate push-button; closing this zeros all registers. Alternatively this line could be wired to the CPU's RESET circuitry (it is 6502-compatible). Pin 22 requires a clock pulse of between 1 and 2 MHz from

which the various tone outputs will be derived, after division by the data held in the PSG's note control registers. It operates well from the UK101's ϕ 2 1 MHz clock, although for production of an equal-tempered chromatic scale I suggest you use a clock frequency of 1.78977 MHz. This is half the standard colour crystal frequency; for further details see GI's 8910 data manual.

Audio output from channels A, B and C appears on pins 4, 3 and 38 respectively. The three signals may be combined directly as in Figure 1, or, preferably, via separate manual mixers, since although the three output levels are individually controlled when the PSG's envelope shaper is not in use, all revert to maximum volume when put under envelope control! Inserting a variable resistor of about 50 or 100k between pins 3 and 38 gives control of the level on channel C and this has proved most useful in some simulations.

The audio output from the chip is considerable (about 1 volt p-p at maximum volume) so that almost any audio amplifier may be used with it. That shown in Figure 1 is based on the circuit suggested by GI; it has the great advantage of operating from a single 5 volt supply and was found to perform well.

The function of the circuitry to the right of the PSG chip in Figure 1 is essentially to simulate the status signals that the PSG would normally receive from a CP1600 CPU along its three control lines BDIR, BC1 and BC2. Table 1 gives the states of these lines during PSG operation and since BC2 may remain high in each case, it has been hard-wired. The gates shown in Figure 1 serve to produce the states on BDIR and BC1 appropriate to the four functions of Table 1. The states are generated in response to the CPU READ/WRITE line (high READ, as for the 6502) and to the two address-decoded, low-enable lines X and Y. When X goes low, the PSG will take

data on its bus to represent a register address, while when Y is low it will use the bus for data associated with the last selected register, and will either write into that register if the R/W line is low, or read from it if R/W is high. Thus suppose that line X was enabled by address 35,000, while line Y by 35,001, then the following Basic commands would place the value 254 into register 7 of the PSG:

```
POKE 35000,7
POKE 35001,254
```

Changing the contents of register 7 to 250 immediately afterwards would simply require the statement: POKE 35001,250, since register 7 of the PSG has already been called up. Read operations are performed in a similar manner. Thus in order to read the contents of register 8 for example, it is necessary to POKE the pseudo address 8, before PEEKing 35001:

```
POKE 35000,8
PRINT PEEK(35001)
```

Now let's look at the production of the two Enable lines from which the circuitry of Figure 1 is controlled. If your machine is a CompuKit and you are not at present using more than 6k of RAM, then you can plug the circuit in Figure 1 directly into two of the unused 2114 sockets in your machine. The wiring of the two 18-pin DIL plugs required is given in Figure 2. For address X, any number between 6144 and 7167 will suffice, while for address Y the range is from 7168 to 8191. The easiest to key in would be 6666 and 7777. Thus:

```
POKE 6666,2
POKE 7777,15
```

will put 15 into register 2 of the PSG, while

Function	BD1R	BC1	BC2
Inactive	0	0	1
CPU read from PSG	0	1	1
CPU write to PSG	1	0	1
Latch address of PSG register	1	1	1

Table 1 8910 control line functions

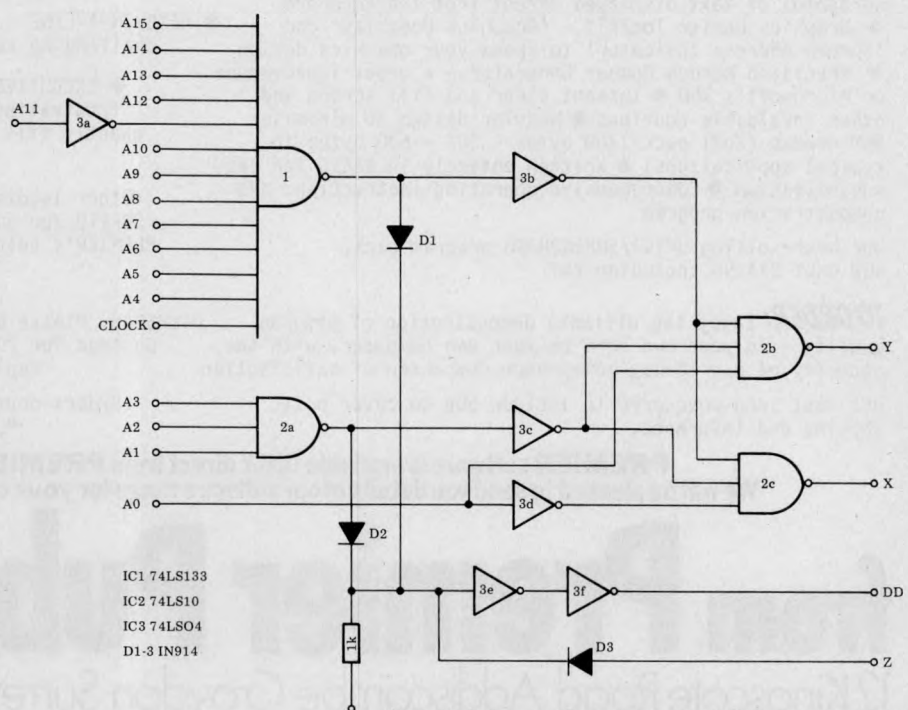

Fig 3 Address decoding. Point Z connects with the circuit of Fig 1 to pick up a R/W line.

THE WORLD'S FINEST HOBBY COMPUTING SOFTWARE

MASTER
PACK

MASTER
PACK

**UTILITIES PACK for
CompuKit UK101 and
Ohio Superboard
(all screen formats)**

Sixteen utility programs that will revolutionise your programming techniques. All programs feature NEW logical screen address system (line 1 column 1 is address 101) with FULL protection against under/over poking.

- * Simple and complex graphics created with single GOSUB calls
- * Inputs displayed at any screen address without scrolling
- * Strings displayed at any screen address without scrolling
- * Full page of strings displayed by defining just one variable
- * TEXTRA text display - a full screenful of text displayed direct from the keyboard
- * Graphics Design Toolkit - 'Graphics Underlay' and 'Screen Address Indicator' to speed your graphics design
- * Precision Random Number Generator - a great improvement on Microsoft's RND
- * Instant clear and fill screen and other invaluable routines
- * Modular design to minimise RAM needed (full pack 1300 bytes - 500 - 600 bytes in typical applications)
- * Written entirely in BASIC for easy customisation
- * Comprehensive operating instructions and demonstration program.

Our best-selling UK101/SUPERBOARD program pack!
NOW ONLY £14.95 including VAT

TO ORDER: Enjoy the ultimate demonstration of program quality - in your own home on your own computer, with the security of our 10-day money-back guarantee of satisfaction

UK: Just send cheque/PO to include 50p to cover post, packing and insurance.

for the
**TRS 80 Level II
COMPUKIT UK 101
SHARP MZ-80
OHIO SUPERBOARD
VIDEO GENIE
CASIO 501/502P**

**STRATEGY GAMES PACK
for TRS 80 (16K), Video Genie,
CompuKit UK101 (8K),
Ohio Superboard
(standard screen, 8K),
and Sharp MZ-80K**

Three extra-special games GUARANTEED to appeal to enthusiasts who want something a little more thought-provoking than Space Invaders!

- * SQUARE SOLITAIRE - Solitaire brought up to date. Unique REPLAY feature gives you a slow-motion replay of all your moves, and allows you to resume play at any point, helping you to develop winning strategy. Incredible graphics!
- * NINE-IN-A-LINE - The age-old game of Reverse with new and challenging variations to keep you engrossed for hours.
- * EXECUTIVE JIGSAW - An entirely new game that's as frustrating as it is fascinating. Use your skill to exactly fill the jigsaw frame. Great fun (even if you don't like ordinary jigsaws).

Other leading software publishers would probably ask £8-£12 for just one of these 'Rolls-Royce' games. But PREMIER's value-for-money price is only £12.95 for all THREE, and that includes VAT.

OVERSEAS: Please deduct VAT (divide price by 1.15) and add postage for 200 grams weight OR send two International Reply Coupons for quotation/program details.

Orders normally despatched within five working days
PLEASE SPECIFY YOUR COMPUTER WHEN ORDERING

**PREMIER software is available ONLY direct from PREMIER PUBLICATIONS
We will be pleased to send you details of our software range for your computer - phone or write today**

from Premier Publications

12 Kingscote Road Addiscombe Croydon Surrey Telephone 01-656 6156

Britain's biggest hobby software specialist - over 90 000 programs sold to date!

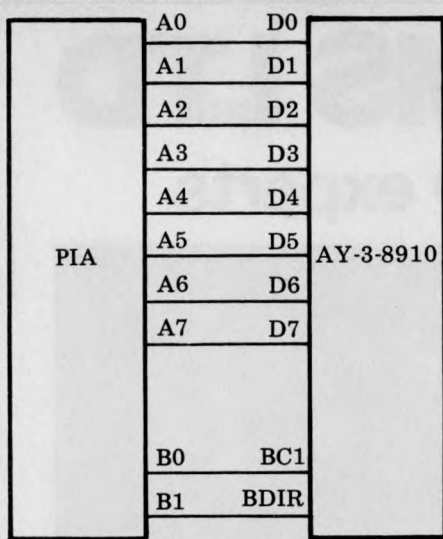

Fig 4 Interfacing the PSG to 10 lines of a parallel port.

POKE 6666.5
PRINT PEEK(7777)
will print the contents of register 5.

If your machine is not a Compukit, or if you are not prepared to sacrifice the top 2k of the Compukit's RAM space, then you will need to decode two appropriate addresses from the CPU's address bus. Figure 3 gives a circuit which does this with a minimum of components; three diodes and three ICs are used. As it stands, the circuit will decode the addresses 63486 and 63487. These fall in an unused area of the Compukit's address map, just below the 2k monitor. For use with other machines the circuit may need to be modified so that the two addresses decoded are not ones used for other purposes. This can be done by changing the position of the inverter on address line 11 to a different line (or by adding inverters to other lines. Note in this context that IC3 of Figure 1 contains two unused inverters). Moving it from A11 to A12 would decode the addresses 61438 and 61439.

The circuitry involving the three diodes in Figure 3 produces a Data Direction signal, required by all interfaces plugged into the Compukit's on-board expansion socket involving a Read operation. The DD line must be forced low for the bidirectional data buffers in the machine to allow the CPU to read data at the expansion socket. If this part of the circuit is not included, or fails to function, then it will only be possible to write to the PSG — which will be sufficient for many purposes.

It should be a fairly simple matter to modify the circuit of Figure 3 to suit the needs of individual machines. As suggested, however, there's a much simpler way to interface the PSG if your machine possesses 10 bits of parallel port which you are prepared to devote to sound generation and do not object to extra software complexity. The remarkably simple circuit for this, based on one suggested by GI, is given in Figure 4. In this approach the BDIR and BC1 status lines are controlled directly by two lines of the output port.

Using this circuit it will obviously take several POKE commands to fill one of the PSG's registers with data or to read from it, since the control lines must be made inactive before the port

A lines can be changed. Thus in order to put the number 16 into register 6 of the PSG, the following sequence of data must be put through ports A and B:

B 0 Begin with control lines in inactive state

A 6 Place pseudo address on port A
B 3 Latch the address register of the PSG

B 0 Return PSG to inactive state

A 16 Place data on the bus

B 2 Cause data to be written

B 0 Return PSG to inactive state

Thus from an initially inactive state, six POKE commands would be required to change the contents of any PSG register, and since programming the 8910 for a particular sound effect can involve anything from three to 14 registers, it is clear that this simple hardware solution is not without its

cost. Note that if you do use this method, port B should not be left in the non-zero state for more than a fraction of a second; in testing this circuit, this caused random data to be written into the registers. Once the software was modified to return to port B to zero immediately after each operation, no further problems were encountered with this interface.

Register layout

Table 2 shows the 8910's 16 registers. The device contains three independent audio channels, and the register pairs 0 & 1, 2 & 3, and 4 & 5 determine the time period of the notes produced on channels A, B and C respectively. The second of each register pair, the coarse tuning, is only four bits wide and together with the 8-bit fine tuning

Register	Function	B I T							
		7	6	5	4	3	2	1	0
R0	Channel A tone period	8-bit fine tune A							
R1						4-bit coarse Tune A			
R2	Channel B tone period	8-bit fine tune B							
R3						4-bit coarse Tune B			
R4	Channel C tone period	8-bit fine tune C							
R5						4-bit coarse tune C			
R6	Noise period					5-bit period control			
R7	Enable	In/out		Noise			Tone		
		I/O B	I/O A	C	B	A	C	B	A
R8	Channel A amplitude					Envelope enable		4-bit amplitude	
R9	Channel B amplitude					Envelope enable		4-bit amplitude	
R10	Channel C amplitude					Envelope enable		4-bit amplitude	
R11	Envelope period	8-bit fine tune							
R12		8-bit coarse tune							
R13	Envelope profile					4-bit control			
R14	I/O port A	8-bit parallel port							
R15	I/O port B	8-bit parallel port							

Table 2 8910 register layout

```

99 REM AY-3-8910 SOUND ROUTINE
100 FOR S=0 TO 15: PRINT : NEXT S
110 PRINT, "AY-3-8910 POKE/PEEK ROUTINE"
120 PRINT, "USING ADDRESSES 6666 & 7777"
124 PRINT, "(NOTE DATA > 255 CAUSES A READ)"
125 PRINT : PRINT
130 A = 6666 : D = 7777
140 REM ZERO ALL REGISTERS
150 FOR X = 0 TO 15
160 POKE A,X
170 POKE D,0
180 NEXT X
200 REM POKE/PEEK ROUTINE
210 INPUT " REGISTER"; A1
215 IF A1>15 THEN PRINT, "TOO LARGE, TRY AGAIN":GOTO 210
220 POKE A,A1
230 INPUT " DATA";D1
240 IF D1 >255 THEN 300
250 POKE D,D1
260 GOTO 210
300 PRINT, "CONTENTS OF REG"; A1; "="; PEEK(D)
310 GOTO 210

```

Fig 5 Program for experimenting with the PSG

XITAN SYSTEMS LTD

The South's CROMEMCO experts

Need a Hard Disk System with FAST RELIABLE Backup?

Xitan now have the answer with the Z-2H plus DC300 Tape cartridge BACKUP system (S100 controller, drive, psu & software).

The Cartridge BACKUP system is available separately for existing Z-2H users (13.4 Megabyte capacity – 1 Megabyte per 5 minutes).



Utilities/Software for CROMEMCO Systems.

Tired of XFER – Use FCOPY or DFCOPY. Single sided 8" copy in 54 seconds, Double sided 8" copy in 104 seconds, £50.00 ea. Need to build Assembler libraries – try LIBR at £50.00.

CP/M 2.2 and MP/M 1.1 available for System 3 and Z-2H systems.

EASYFORM. For creation/editing of forms on the 3102 VDU with structured Basic. Forms useable from Cobol, Fortran etc. £160.00.

BUSINESS SOFTWARE

CROMEMCO systems – a complete Business system based on the system 3 from CAP-CPP. Phone for an appointment to see it running.

For the smaller customer, we have an integrated Sales, Purchase and Nominal system for the North Star Horizon. Nothing fancy – but installed and running for over 7 months. IT WORKS!

WHATIF! Cash Flow, Accounts budgetting utility. Just released. Incredible value at £95.00.

Also available an Incomplete Records system for the Horizon.

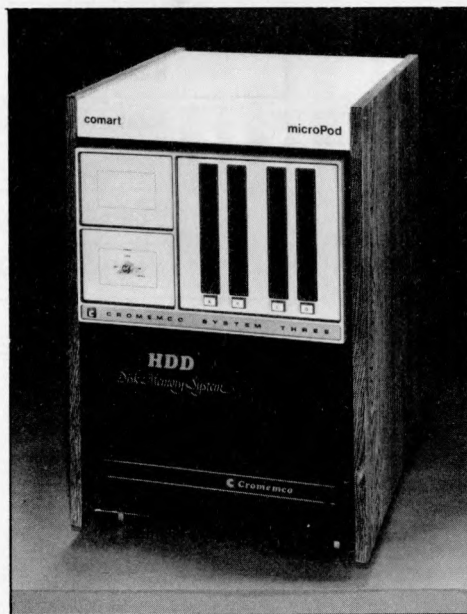

SPECIALS.

Real Time Clock – S100 – 100 microseconds up to 99,999 days £155.00. Hi-Tech S100 PAL colour card, 24 x 40 Prestel format £295.00. Video Vector Fastlib £495.00. Dual Tandon Double/sided 40 track mini-floppy sybsytsem £625.00.

INTEGRATED SPECIALIST SYSTEMS.

MEDIDATA 32,000 patient Doctors' system. Installed & running. Prices from £7500.00.

RETURNED ALE. Run a brewery? Keep track of returned ale and reclaim Excise Duty. Track down production & storage problems. Copes with 10,000 + barrels. Prices from £8500.00.

Xitan Systems also supplies and stocks vdus, printers, NORTH STAR HORIZON computers, Commodore Business Machines PETs, S100 boards, and books. We are here to demonstrate the range of quality microcomputer systems available for use today. Ring up for an appointment now! You'll not be disappointed. We have Osborne's Sales Ledger and Payable Ledger in source form for use on Cromemco System 3 with CBASIC2, and we can offer a customising service on these programs. Additional software includes Microsoft Basic Interpreter and Compilers, Cbasic, Macro80, and CP/M for the North Star Horizon.

Xitan Systems Ltd., 23 Cumberland Place, Southampton SO1 2BB.

Tel: (0703) 38740

Hours Tue-Sat 9.30 am to 5.30 pm

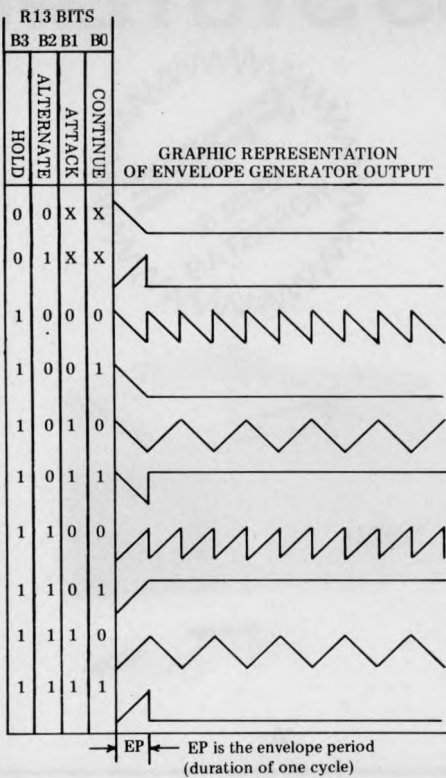

Table 3 Envelope profile control at register 13.

provides a 12-bit number which is divided into a constant frequency source obtained from the clock input. A high number in any pair of registers will therefore give rise to a low frequency note, and if both coarse and fine registers of a particular channel are at zero, then the tone generator for that channel will produce a square wave of one sixteenth of the clock frequency (62.5 kHz for a 1 MHz clock). Register 6 is five bits wide and controls the tonal characteristics of the white noise generator. Here again a large number results in a low frequency. Register 7 is the most difficult to use and actually requires some degree of thought. Its lowest six bits control mixers on all three channels, determining whether each should carry tone and/or noise or neither, while the highest two bits control the direction of the two ports. You need to be good at converting binary to decimal if you are POKEing this register in Basic, and the problem is slightly aggravated by the fact that a 1 disables rather than enables. To give an example, the number 180 (10110100 binary) in register 7 will have the following effect: port A will be set to input, port B to output, Channel A will carry tone and white noise, B will carry tone only, and there will be no output from channel C.

Registers 8, 9 and 10 control the amplitude of the outputs of the three channels; data can range from 0 to 15 (15 represents maximum volume) and the digital to analogue conversion is arranged logarithmically to suit the human ear. Placing a 1 in the fifth bit of registers 8, 9 or 10 (or any combination of them) causes channels A, B or C to come under the control of the envelope shaper rather than giving a continuous tone or noise output.

Registers 11 and 12 exercise fine and coarse control over the time constant of the envelope, while the low-

est four bits of register 13 control the envelope shape and determine whether it is one-shot or repeating. Table 3 gives the range of options offered here.

Experimenting

The listing in Figure 5 is a simple program for experimenting with the sound generator appropriate for interfaces of the type in Figure 1. To make it run on different machines it should only be necessary to change the two addresses A and D in line 130. If the parallel port method of Figure 4 is used, the program will need to be modified to initialise the ports and to set up the appropriate outputs on port B, as suggested earlier. The program first zeros all registers and then proceeds to ask the user for a register number and then the data to be put into it. It's so arranged that if a value greater than 255 is entered as data, then the program will cause a Read to be carried out at the last entered register, in place of a Write, and the result printed. As an example of the use of the PSG, Table 4 gives lists of data for two different sound effects which may be set up using this program.

Controlling the PSG

Once the CPU is used to vary the contents of the PSG's registers under program control an almost infinite range of sounds can be produced. FOR...NEXT loops can be used to particularly good effect on the tone frequency registers and of course when just a single register is being varied in this way it is only necessary to POKE the register address once at the beginning of the operation. When using the generator in games and other programs, the most straightforward approach is to use a series of subroutines to control it placed at the end of the program. This method is useful for adding sound effects to programs already written. The first routine encountered should be one which resets all PSG registers to zero and which designates variables to be used as shorthand for the two CPU addresses used for the device. And of course if you're using the parallel port method, this would also be an appropriate point to set its control registers. A suitable subroutine for zeroing the registers is:

1	Register	Data	2	Register	Data
	7	248		6	31
	8	16		7	7
	9	16		8	16
	10	16		9	16
	12	20		10	16
	13	8		12	20
	0	200		13	0
	2	201			
	4	100			

Table 4 Two sound effects:

- Electronic piano note: changing the data on register 2 to either 66 or 101 adds a 'twang' to the quality of the note,
- Explosion: entering another zero into register 13 will reproduce the effect and replacing the zero with 8 will cause it to repeat.

```
8000 REM AY-3-8910 ZEROING
8010 A=6666
8020 D=7777
8030 FOR X=0 TO 15
8040 POKE A,X
8050 POKE D,0
8060 NEXT
8070 RETURN
```

If you intend to use only one register configuration in a given program, then it is probably easiest to insert extra lines into the end of this routine which will set up most of the registers required for sound generation but which leave one vital register set for zero output (eg register 7 could be set to 255). When sound is actually required at a given point in the program it can then be turned on or off with a single command. But if a variety of complex sounds are involved that are produced in different ways, then it's probably better to set up the PSG from scratch each time a sound is produced, to avoid any subroutine leaving the registers in a state inappropriate for the next.

Sound effects for dodgems

As an example of the use of the 8910 under program control let's look at the way in which sound effects may be added to Dodgems, a nicely-written games program for the UK101 by N E Berry (PCW April 1980).

The first problem in adding noise subroutines is to identify the point in the program at which they are to be called. In games such as Dodgems there are two useful clues to look for: the easiest is the score-change statement associated with the event that you are using as a cue. Thus in Dodgems, sounds have been added both when the player crashes and when he hits a beacon; the relevant position in software was found by visually scanning the program for an SC=SC-100 (for a crash) and an SC=SC+200 (for a beacon). This task was made much easier because in writing the original program, Mr Berry used the mnemonic SC for the score variable. Tracing further changes in SC led to the discovery of the insertion point for a statement which produces two types of 'blips' during the game.

A second way to track down appropriate insertion points is to scan the program for statements containing relevant character codes. Thus one

NORTH STAR BUSINESS SYSTEM

WORD-PROCESSING
STOCK CONTROL
INVOICING
SALES & PURCHASE LEDGER
ETC. ETC.

FREE
CP/M &
WORDSTAR



C

B

A

**EX-STOCK PROVEN RELIABILITY
1 YEAR GUARANTEE**

SAMPLE RECOMMENDED SYSTEM (AS ABOVE):—

A	Horizon Computer (64K Ram 2 D/D Drives)	£2080.00
B	TVI-912C VDU, numerous features	£595.00
C	NEC RO Spinwriter (RS232) + tractors	£1775.00
	COMPLETE SYSTEM PRICE (Includes cables)	£4450.00
	ABOVE SYSTEM WITH DOUBLE-SIDED DRIVES	£4730.00
	FREE !! WORDSTAR plus CP/M with above system.	

INVENTORY Package — With Sales & Purchase Management System	£295.00
KDS Development System for North Star BASIC	£50.00
KDS Disk Despooler — North Star DOS despooler	£50.00
CP/M V2.2 — supports double-sided drives	£95.00
WORDSTAR V2.1 — Superb word processing package	£235.00
MAIL-MERGE — Adds form letter generation to WORDSTAR	£75.00
DATASAR — CP/M compatible Database Management System	£195.00
North Star UCSD PASCAL-D/Q System	£105.00
Microsoft BASIC interpreter V5.1	£155.00
Microsoft BASIC compiler V5.1	£195.00
Microsoft FORTRAN-80	£205.00
Econoram IIa — 8K Static Memory	£100.00
Econoram XX — 32K Static Memory with bank switching	£355.00
DMB-6400 — 64K Dynamic RAM with bank switching	£545.00
Godbout Interfacer 1 — 2 full RS232 serial I/O card	£135.00
Switchboard — 2 Serial, 4 parallel I/O card	£155.00
OKI Microline-80 Printer — Lightweight, 80 cps, Graphics	£425.00
Paper Tiger Printer — 2K buffer, full graphics, form-feed	£595.00
Anadex DP9500 Printer — Fast, bi-directional, logic-seeking	£895.00
Morrow 26Mb Hard Disk Sys. + Timeshaver CP/M-North Star DOS	£3495.00
Morrow 26Mb Hard Disk — Add on hard disk	£2495.00

PLEASE WRITE OR PHONE FOR LATEST PRODUCT CATALOGUE

PHONE US OR CONTACT
YOUR NEAREST DEALER

- CODAS LTD**
Pontypridd Wales Tel: 0443-406450
- CONQUEST COMPUTER SALES LTD**
Benfleet Essex Tel: 03745-59861
- DIGITAL DEVICES LTD**
Southborough Kent Tel: 0892-37977/9
- FYLDE MICROCOMPUTER SERVICES**
Blackpool Lancs. Tel: 0253-692954
- THE HARDWARE SOFTWARE CO.**
London NW3 Tel: 01-722 6436
- HOTEL MICROSYSTEMS LTD**
Middlesex Tel: 01-890 9696
- JAD INTEGRATED SERVICES**
Plymouth Devon Tel: 0752-626164
- KBS COMPUTER SERVICES**
Liverpool Tel: 051-236 8333
- KBS COMPUTER SERVICES**
Cardiff Wales Tel: 0222-394313
- KBS COMPUTER SERVICES**
Coventry Warwicks. Tel: 0203-27266
- LOVEDEN COMPUTER SERVICES LTD**
Grantham Lincs. Tel: 0476-72000
- MICRO FACILITIES LTD**
Hampton Hill Middx. Tel: 01-979 4546
- MICROSYS LTD**
Prescot Merseyside Tel: 051-426 7271
- MICROTECH COMPUTER SERVICES**
Liverpool Tel: 051-236 2208/9
- SAPPHIRE SYSTEMS**
Billericay Essex Tel: 02774-57743
- SPOT COMPUTER SYSTEMS LTD**
Doncaster Yorks Tel: 0302 50833
- S. SYSTEMS**
Crawley Sussex Tel: 0293-515201
- STAG TERMINALS LTD**
Teddington Middx. Tel: 01-943 0777
- SUMLOCK-BONDAIN LTD**
London EC1 Tel: 01-250 0505
- VIDEO VECTOR DYNAMICS LTD**
Glasgow Scotland Tel: 041-226 3481/2

INTERAM

UK Distributor:
INTERAM Computer Systems Ltd.
59 Moreton Street,
Victoria, London SW1V 2NY
Tel: 01-834 0261/2733
Telex: 925859

could tell in Dodgems when the player hits a beacon because there will be a look-ahead PEEK statement testing for the beacon's character code, which is 9. A visual scan of the program immediately identifies the line:

```
1155 IF PEEK(I)=9 THEN
SC=SC+200:FOR LL=1 TO 2000:
NEXT
```

In this case of course SC=SC+200 serves as a much more obvious marker to the line.

Figure 6 lists the modifications and additions to Dodgems to produce these four sound effects. The additions consist largely of three subroutines: the first zeros all registers, and then partially sets them up for sound production. This is possible because different channels of the PSG have been used for the different noises. Channel A gives the beacon noise, B the two types of 'blip', and C the crash, this latter using the envelope shaper. For the sake of economy of timing, the 'blips' are handled within the program itself with a minimum of POKE commands. Line 1154 decides the tone of the 'blip' and activates it, while line 1005 turns it off. The beacon and the crash noises provide examples of the use of FOR loops on the PSG's registers to produce two very different sounds and are handled in the subroutines at lines 4000 and 5000 respectively.

Finally

The options available of course do not end here. Sounds could well be added to accompany the 'GAME LOST' and 'YOU WIN' messages. The appearance

of a beacon and direction changes of the robot would also make good cues, or to really hot things up a second PSG could be added to give a stereo effect. There is no end to the possibilities that the exceptionally versatile

8910 offers the programmer and the complete transformation of previously silent programs which can be brought about using this device must, as they say, be seen and heard to be believed.

```
6 GOSUB 3700
1005 H=E : POKE GD,0
1154 POKE GA,2:POKE GD,150: IF PEEK(I)=213 THEN
SC=SC + 10: POKE GD,100
1155 IF PEEK(I)=9 THEN SC=SC + 200 : GOSUB 4000
2004 GOSUB 5000

3700 REM AY-3-8910 INITIALISATION
3710 GA = 6666 : GD = 7777
3720 FOR GE = 0 TO 15
3730 POKE GA, GE
3740 POKE GD, 0
3750 NEXT GE
3760 POKE GA,7 : POKE GD, 248
3770 POKE GA,8 : POKE GD, 15
3780 POKE GA,9 : POKE GD, 11
3800 POKE GA,10 : POKE GD, 16
3810 POKE GA,2
3820 RETURN

4000 REM BEACON HIT NOISE
4001 POKE GA,2 : POKE GD,0
4003 POKE GA,0
4005 FOR GG = 1 TO 10
4010 FOR GH = 255 TO 50 STEP -10
4020 POKE GD, GH
4030 NEXT GH : NEXT GG
4050 POKE GD, 0
4060 RETURN

5000 REM CRASH NOISE
5010 POKE GA, 12 : POKE GD, 30
5020 POKE GA, 13 : POKE GD, 0
5025 POKE GA, 4
5040 FOR GH = 255 TO 40 STEP -1
5050 POKE GD, GH
5055 POKE GD, 100
5060 POKE GD, 40
5070 NEXT GH
5075 POKE GD, 0
5080 RETURN
```

Fig 6 Sound effects for 'Dodgems'

COMPUTER FAIRE

A Conference & Exposition

on

Intelligent Machines

for

Home, Business, & Industry

Personal
Computer
World



Spring in San Francisco from £440

Enjoy a two-centre holiday in sunny California, 1 - 9 April, 1981
just in time for the 6th West Coast Computer Faire.

Lounge on Santa Monica beach, visit the first ever computer store or maybe even take a peek at Hollywood. Follow this with a few days in San Francisco visiting the Computer Faire and possibly pop down El Camino Real to Silicon Valley.

All this, and much more can be yours if you take advantage of Meridian Tours' special offer to PCW readers, details of which are now being finalised.

Three holidays are planned, each of which ensures that you are in San Francisco for the duration of the Faire, which must be the biggest micro-dedicated show in the world. The first holiday comprises one night in Los Angeles at the first-class Sheraton Miramar at Santa Monica Beach followed by six nights in San Francisco at the Civic Centre Holiday Inn, just round the corner from the Faire. The second holiday provides the chance to spend three nights in Los Angeles and four in San Francisco while the third allows you to 'do your own thing' for a week following one of the above holidays, simply returning to base for the journey home.

The holiday price includes all flights, hotel accommodation, supervised transfers between airports and hotels, entrance to the Faire, a copy of the conference proceedings and compulsory insurance. The cost does not include transport to and from Gatwick, meals abroad or additional accommodation for those wishing to stay an extra week.

Car hire can be arranged at special rates by Meridian before departure and special excursions may be booked with their local representatives while abroad.

Having said all that, this promises to become quite an event in the PCW year; it's bound to be fun - even for those who aren't too interested in computers. They can make the most of San Francisco with its Golden Gate Bridge, cable cars, Chinatown, Fisherman's Wharf - not to mention a more recent phenomenon, lobby watching in the Hyatt Regency.

For further information and a booking form write to West Coast Trip, PCW, 14 Rathbone Place, London W1P 1DE.

This holiday is being organised by Meridian Tours Midlands Ltd who are bonded tour operators (Air Tour Operator's Licence No. 700B)

Enter the Computer Age video genie system



£330
+VAT

12K MICROSOFT BASIC
16K RAM, UHF MODULATOR
INTERNAL CASSETTE
SECOND CASSETTE INTERFACE

£395
+VAT

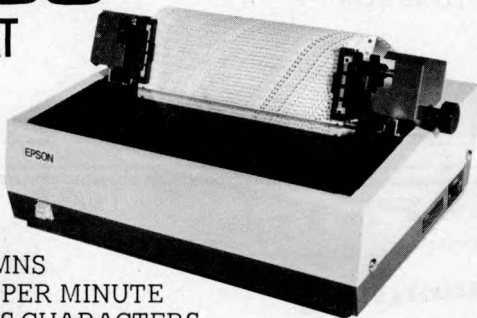

80 COLUMNS
70 LINES PER MINUTE
GRAPHICS CHARACTERS
INTERFACES TO MOST MACHINES



100's OF PROGRAMS AVAILABLE
TRS-80 LEVEL II SOFTWARE COMPATIBLE

See it at the following dealers

Advance Television
Services
Shipley 585333

Amateur Radio Shop
Huddersfield 20774

Allen TV Services
Stoke on Trent 616929

Arden Data Processing
Peterboro' 49577

Blandford Computers
Blandford 53737

Briers Polytechnic
Bookshop
Middlesbrough 242017

Buss Stop
Watford 40698
Newport Pagnell
610625

Cambridge Microcomput-
ers Ltd
Cambridge 134666

Cavern Electronics
Milton Keynes 314925

Computer Business
Systems
Lytham 730033

Computerama Limited
Bath 28819

Computopia Limited
Bath 28819

Computer and Chips
St Andrews 72569

Catronics Limited
Wallington 01-669
6700/1

Derwent Radio
Scarborough 65996

D B Microcomputers
Limerick 42733

Eiron Computers Limited
Dublin 808575/805045

Eley Electronics
Leicester 871522

Gemsoft
Woking 22881

G B Organs & Television
Jersey 26788/23564

Kansas City Systems
Chesterfield 850357

Kays Electronics
Chesterfield 31696

Leisurronics
Blackpool 27091

Matron Microcomputer
Services
Cogenhoe 890661
Melton Mowbray 812888

Matrix Computer
Systems Limited
Beckenham 01-658
7508/7551

Mighty Micro
Watford 38923
Basingstoke 56417

Mighty Micro Limited
Burnley 32209/53629

Microdigital Limited
Liverpool 227 2535

Midland Microcomputers
Nottingham 298281

MRS Communications
Cardiff 616936/7

Optelco
Rayleigh 774089

Q Tek Systems Ltd
Stevenage 65385

Rebvale Computers Ltd
Garboldisham 316

SMG Microcomputers
Gravesend 55813

3 Line Computing
Hull 445496

Tryfan Computers
Bangor 52042

Univ Radio Stores
(Nott'm) Ltd
Nottingham 45466

Ward Electronics
Birmingham 021-554
0708

Watford Electronics
Watford 38923

LOWE ELECTRONICS

MATLOCK
DERBYSHIRE DE4 5LE
BENTLEY BRIDGE
CHESTERFIELD Rd

Trade Enquiries Welcome



ANOTHER DIMENSION

Complex, moving three-dimensional computer graphics displays are still the preserve of big mainframe computers, yet there's plenty of scope for producing 3D images with microcomputers. Maurice Shepherd describes the maths involved and gives ideas for experimentation.

Points in three-dimensional space can be uniquely described by their Cartesian coordinates (x y z). The unit cube shown in Figure 1 can therefore be described by a set of eight (x y z) coordinates plus information about which points are joined by straight lines.

Since the 'joining' information remains constant even if the coordinates are altered by, for example, moving or rotating the cube, we can neglect this aspect for the moment and concentrate on the coordinates. Having defined the coordinates of a 3D object, we may want to transform these coordinates in various ways corresponding to, for example,

- a Translation — moving the object in 3D space
- b Scaling — making the object larger or smaller
- c Rotation — rotating the object about an axis

and obtain a set of transformed coordinates (x' y' z'). Ultimately these transformed 3D coordinates have to be represented on a 2D surface such as a video screen, X-Y recorder or graph paper. This requires a two-dimensional projection of the points (x' y' z') onto some plane, say the z=0 plane, to give a set of (x'' y'') coordinates. (Note that Figure 1 is a 2D projection!) It would also be useful, in some circumstances, to have a perspective view of the object.

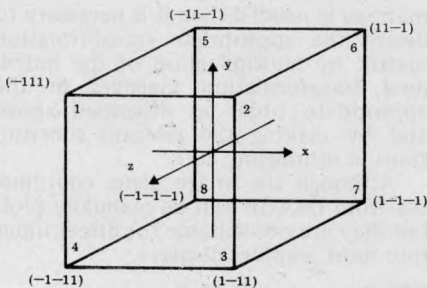

Fig 1 Cartesian coordinates of the vertices of a cube centred on the origin.

Although the above may appear to involve a great deal of complicated 3D geometry, it can all be done remarkably easily and elegantly using matrix algebra. Enough detail is given in the following sections to allow those reasonably familiar with matrix multiplication to develop programs for their own purposes; the material is also incorporated in the Basic program IMAGE and

the associated subroutines described below.

Homogeneous co-ordinates

The necessary matrix algebra requires the use of homogeneous coordinates instead of the more familiar Cartesian coordinates. Four homogeneous coordinates (X Y Z H) are necessary to define a point in 3D space. For our present purposes it is sufficient to know that the point with normal coordinates (x y z) can be represented by the homogeneous coordinates (x y z 1) or any one of the set of homogeneous coordinates (nx ny nz n) where n is not zero. In reverse, the Cartesian coordinates of a point represented by the homogeneous coordinates (X Y Z H) are (X/H Y/H Z/H). These conversions are easily programmed.

The transformation matrix

A set of n points in 3D space can therefore be described by an n X 4 matrix of homogeneous coordinates. Coordinate transformations and projection either with or without perspective can then be done, either individually or in combination, by multiplying this n X 4 matrix of the original coordinates by an appropriate 4 X 4 transformation matrix to give a product matrix of the transformed homogeneous coordinates, as shown in Table 1.

This is a straightforward operation particularly if you use a Basic which includes a MAT operation for matrix multiplication. Since MAT instructions are not usually available with the smaller Basic interpreters a suitable subroutine is given in the program IMAGE. However since the multiplication of an 8 X 4 and a 4 X 4 matrix, which would be necessary for the simple cube in Figure 1, is likely to take at least a second with a micro Basic interpreter, don't expect to obtain rapidly changing complex displays — they must still be left to the larger main-frame computers.

Rotation, scaling and translation

So, on to the 4 X 4 transformation matrix. We will first look at some specific coordinate transformation

matrices and then at the central projection technique. Individual transformation matrices for rotation, scaling and translation are given in Table 2. The three matrices R(α), R(β) and R(γ) produce rotations through angles of α, β and γ about the x, y and z axes respectively and are therefore special cases of a more general but also more complicated rotation matrix. A position rotation angle causes a counter-clockwise rotation of point(s) about the relevant axis when viewed along the negative-going direction of that axis.

Also shown in Table 2 are the matrices for scaling (local and overall) and translation. It may seem that

ROTATION

Rotate by angles α, β and γ about x, y and z axes respectively.

$$R(\alpha) = \begin{bmatrix} 1 & 0 & 0 & 0 \\ 0 & \cos \alpha & \sin \alpha & 0 \\ 0 & -\sin \alpha & \cos \alpha & 0 \\ 0 & 0 & 0 & 1 \end{bmatrix}$$

$$R(\beta) = \begin{bmatrix} \cos \beta & 0 & -\sin \beta & 0 \\ 0 & 1 & 0 & 0 \\ \sin \beta & 0 & \cos \beta & 0 \\ 0 & 0 & 0 & 1 \end{bmatrix}$$

$$R(\gamma) = \begin{bmatrix} \cos \gamma & \sin \gamma & 0 & 0 \\ -\sin \gamma & \cos \gamma & 0 & 0 \\ 0 & 0 & 0 & 1 \\ 0 & 0 & 0 & 1 \end{bmatrix}$$

LOCAL SCALING

Multiplies x, y and z by a, b and c respectively.

$$S(a,b,c) = \begin{bmatrix} a & 0 & 0 & 0 \\ 0 & b & 0 & 0 \\ 0 & 0 & c & 0 \\ 0 & 0 & 0 & 1 \end{bmatrix}$$

OVERALL SCALING

Multiplies x, y and z by 1/d.

$$S'(d) = \begin{bmatrix} 1 & 0 & 0 & 0 \\ 0 & 1 & 0 & 0 \\ 0 & 0 & 1 & 0 \\ 0 & 0 & 0 & 1/d \end{bmatrix}$$

TRANSLATION

Translates x, y and z by u, v and w respectively.

$$T(u,v,w) = \begin{bmatrix} 1 & 0 & 0 & 0 \\ 0 & 1 & 0 & 0 \\ 0 & 0 & 1 & 0 \\ u & v & w & 1 \end{bmatrix}$$

Table 2 Transformation Matrices (Continued over)

$$\begin{bmatrix} x_1 & y_1 & z_1 & h_1 \\ x_2 & y_2 & z_2 & h_2 \\ \vdots & \vdots & \vdots & \vdots \\ x_n & y_n & z_n & h_n \end{bmatrix} \begin{bmatrix} \text{The} \\ 4 \times 4 \\ \text{TRANSFORMATION} \\ \text{MATRIX} \end{bmatrix} = \begin{bmatrix} x'_1 & y'_1 & z'_1 & h'_1 \\ x'_2 & y'_2 & z'_2 & h'_2 \\ \vdots & \vdots & \vdots & \vdots \\ x'_n & y'_n & z'_n & h'_n \end{bmatrix}$$

n X 4 matrix of original coordinates

n X 4 matrix of transformed coordinates

Arrays:
OC(N,4)

T(4,4)

TC(N,4)

Table 1

(See IMAGE)

Table 2 (continued)

CENTRAL PROJECTION

Projects onto the xy plane with view-point at z=Z.

$$CP(Z) = \begin{bmatrix} 1 & 0 & 0 & 0 \\ 0 & 1 & 0 & 0 \\ 0 & 0 & 0 & -1/Z \\ 0 & 0 & 0 & 1 \end{bmatrix}$$

CONSECUTIVE ROTATIONS

About the x, y and z axes : see text

$$R(\alpha, \beta, \gamma) = \begin{bmatrix} A & B & C & 0 \\ D & E & F & 0 \\ G & H & I & 0 \\ 0 & 0 & 0 & 1 \end{bmatrix}$$

where

- A = $\cos\alpha \cos\gamma$
- B = $\cos\beta \sin\gamma$
- C = $-\sin\beta$
- D = $\sin\alpha \sin\beta \cos\gamma - \cos\alpha \sin\gamma$
- E = $\sin\alpha \sin\beta \sin\gamma + \cos\alpha \cos\gamma$
- F = $\sin\alpha \cos\beta$
- G = $\cos\alpha \sin\beta \cos\gamma + \sin\alpha \sin\gamma$
- H = $\cos\alpha \sin\beta \sin\gamma - \sin\alpha \cos\gamma$
- I = $\cos\alpha \cos\beta$

these particular operations could be more readily done by conventional multiplication and addition but the advantage of the matrix multiplication becomes evident when, as is usually the case, several consecutive transformations are required.

A series of consecutive transformations can be done using one 4 X 4 matrix which is the product of the individual 4 X 4 transformation matrices. Suppose, for example, that one requires consecutive rotations by angles α , β and γ about the x, y and z axes respectively. This can be done using the single matrix $R(\alpha, \beta, \gamma)$ where

$$R(\alpha, \beta, \gamma) = R(\alpha) \times R(\beta) \times R(\gamma)$$

This matrix is given in Table 2. Going a stage further one may derive the transformation matrix, RST, required to give the above rotation sequence followed by local scaling, followed by translation,

$$RST = R(\alpha, \beta, \gamma) \times S(a, b, c) \times T(u, v, w)$$

and show that

$$RST = \begin{bmatrix} aA & bB & cC & 0 \\ aD & bE & cF & 0 \\ aG & bH & cI & 0 \\ u & v & w & 1 \end{bmatrix}$$

where A to I are the corresponding elements of the $R(\alpha, \beta, \gamma)$ matrix. It is essential that the individual matrices are multiplied in the order in which the transformations are required. For example, a rotation followed by a translation does not give the same result as the same translation followed by the same rotation — or put another way, matrix multiplication is not commutative.

In the local scaling transformation it is apparent that the overall shape of the object is altered if a, b and c are not equal. The local scaling factors also allow reflections through the xy, yz and xz planes to be made eg $a=b=1$ and $c=-1$ cause a reflection of points through the xy plane — it changes the signs of all the z coordinates. if $a=b=c=-1$ then all points are inverted through the origin.

The transformation matrix RST has

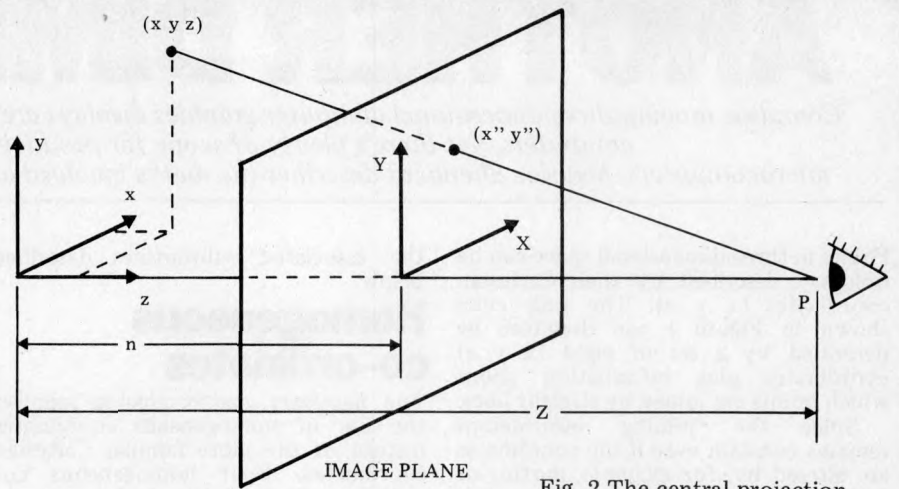

Fig 2 The central projection

nine input parameters ($\alpha, \beta, \gamma, a, b, c, u, v, w$) — remember A–I are functions of the rotation angles. The transformed 3D coordinates obtained using RST must now be projected onto a plane to give a set of 2D coordinates.

The central projection

The central projection method, illustrated in Figure 2, also allows perspective to be introduced. In this relatively simple projection method a viewpoint, P, is selected on one of the orthogonal axes and the 3D points are projected onto the image plane which lies normal to this axis.

In Figure 2 the viewpoint, or centre of projection, is on the z axis at $z=Z$ and the image plane is the $z=n$ plane. The straight line passing through coordinate (x, y, z) and P intersects the image plane at the image point (x'', y'') . From elementary geometry it may be shown that for a projection onto the $z=0$ (or xy) plane,

$$x'' = xZ/(Z-z) \quad \text{and} \quad y'' = yZ/(Z-z)$$

The effect of perspective decreases with increasing Z until in the limit of Z being infinite ($1/Z = 0$) we have what is known as an orthogonal projection, ie $x'' = x$ and $y'' = y$, in which all lines which are parallel in the 3D object are also parallel on the image plane. Orthogonal projections are often used in mechanical drawings.

The transformation matrix for central projection onto the $z=0$ plane, CP, is given in Table 2. Rotation, local scaling, translation and central projection can therefore be done using the transformation matrix, RSTCP, where

$$RSTCP = RST \times CP = \begin{bmatrix} aA & bB & 0 & -cC/Z \\ aD & bE & 0 & -cF/Z \\ aG & bH & 0 & -cI/Z \\ u & v & 0 & 1-W/Z \end{bmatrix}$$

Original coordinates are transformed by the RSTCP matrix, as shown below $(x, y, z, 1) \times RSTCP = (X, Y, 0, H)$ and the points in the image plane (x'', y'') calculated by dividing X and Y by the corresponding H ie a homogeneous to Cartesian coordinate conversion. Strictly this is not necessary with orthogonal projections because H is always unity. Now a Basic program to do all this.

Image

The Basic program IMAGE illustrates

the use of the transformation matrix, RSTCP, derived above. The starting Cartesian coordinates are stored, for convenience, as DATA and the program requires 10 input parameters ($\alpha, \beta, \gamma, a, b, c, u, v, w, 1/Z$) and prints the image coordinates (x'', y'') . At the expense of some extra programming it may be worth setting default values for these parameters of $(0, 0, 0, 1, 1, 1, 0, 0, 0, 0)$, ie an orthogonal projection of the starting coordinates.

Some typical results produced by IMAGE are plotted in Figure 3 for a series of transformations with and without perspective. Some care must be taken in choosing the value of $1/Z$; if the viewpoint is too close to the origin then a very distorted and unrealistic perspective view is obtained. Similarly some experience with using the other parameters will probably be necessary before you can readily achieve the desired views.

If a different sequence of transformations is needed then it is necessary to derive the appropriate transformation matrix by multiplication of the individual transformation matrices in the appropriate order as described above and by making the relevant substitutions in subroutine 300.

Although the image plane coordinates from IMAGE can be manually plotted they are not suitable for direct input into most graphics displays.

Videographics

Most micro video graphics systems allow individual points on the screen to be addressed by using an instruction such as PLOT(p,q). The display coordinates p and q are usually positive integers with machine-dependent ranges of, say, $0 \leq p \leq P$ and $0 \leq q \leq Q$, where P+1 and Q+1 are the number of rows and columns of addressable points on the display. These general principles also apply to X-Y recorders. For so-called high resolution micro graphics, P and Q are generally of the order of 300 and 200.

It's not a particularly difficult problem to take the IMAGE coordinates and convert them into a suitable form for a video display. Figure 4 illustrates a mapping of coordinates onto the display plane — $(x'', y'') \rightarrow (p, q)$ — with the origin of the image plane being mapped onto the centre of the display plane $(P/2, Q/2)$, and in this case,

$$p = x''Q/YD + P/2 \quad \text{and} \quad q = y''Q/YD + Q/2.$$

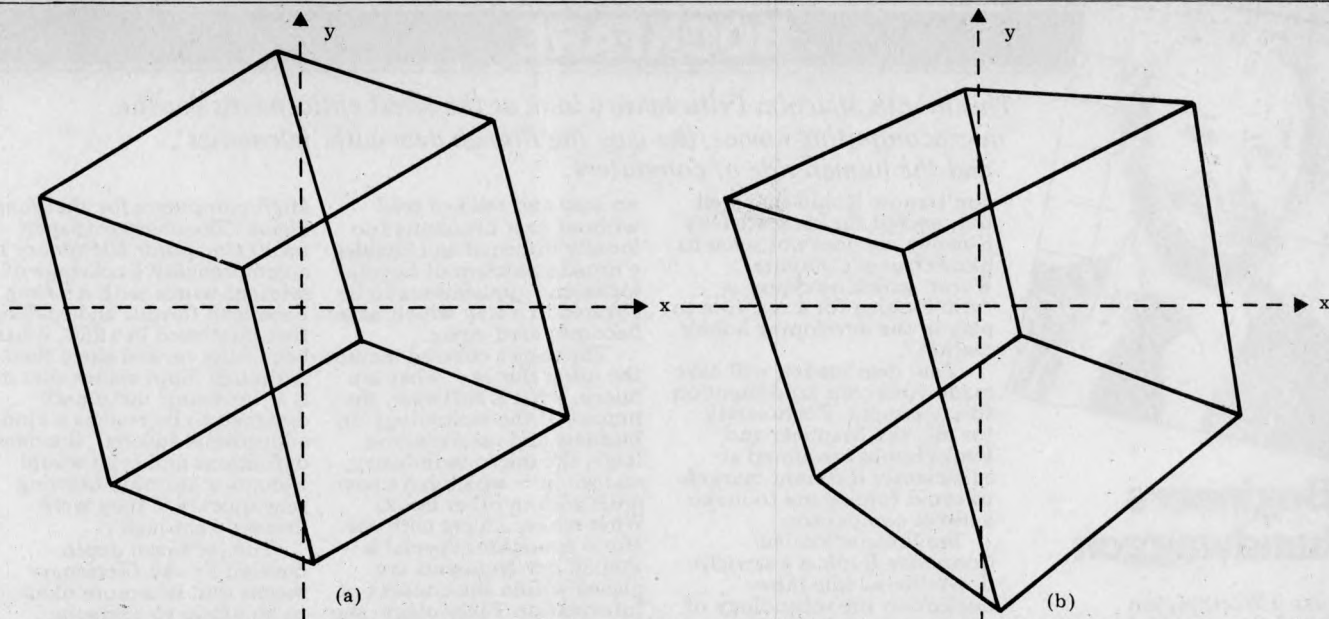

Fig 3 IMAGE results plotted for input parameters of (a) $(30^{\circ}, 30^{\circ}, 30^{\circ}, 1, 1, 1, 0, 0, 0, 0)$ and (b) $(30^{\circ}, 30^{\circ}, 30^{\circ}, 1, 1, 1, 0, 0, 0, 0.2)$ using the cube coordinate set.

The values of P and Q are obviously machine dependent but the value YD (or the starting coordinates) must be chosen with care to ensure that all image coordinates map onto the display plane. This is a common problem in computer graphics and offers scope for ingenious programming. It is also the problem you solve every time you successfully draw a graph!

The program IMAGE can be easily modified to give screen coordinates using the two equations above. The optional subroutine 700 given after the IMAGE listing will do this and could replace subroutine 600 in IMAGE — but remember to value P, Q and YD appropriately.

This image plane to display plane coordinate conversion involves an overall scaling and a translation. In view of the above, a much neater and faster means of doing it would be to incorporate these transformations in the transformation matrix. The appropriate transformation matrix, VIDEO, is derived from

$VIDEO = RSTCP \times S'(d) \times T(U, V, 0)$
 where $d = Q/YD$, $U = P/2$ and $V = Q/2$, ie an overall scaling of the image coordinates followed by a translation. The elements of VIDEO, although fairly complicated, are easily programmed following the general example of IMAGE.

$$VIDEO = \begin{bmatrix} A'+UC'/d & B'+VC'/d & 0 & c'/d \\ D'+UF'/d & E'+VF'/d & 0 & F'/d \\ G'+UI'/d & H'+VI'/d & 0 & I'/d \\ J'+UL'/d & K'+VL'/d & 0 & L'/d \end{bmatrix}$$

where A' to L' are the corresponding elements of RSTCP.

Joining information

The program IMAGE does not deal with the problem of joining the appropriate coordinates on the video screen. Most graphics systems however include an instruction to draw a 'straight' line joining two points on the screen, such as JOIN(x_1, y_1, x_2, y_2). The framework of the cube in Figure 1 for example, is defined by twelve specific lines and the drawing of these lines can be done with a Basic routine similar to that given in subroutine 800.

If a JOIN or similar instruction is not available then a separate routine must be written.

Further extensions

The information and example above give sufficient background to allow quite powerful graphics programs to be written. There are several areas which can test programming skills. For example, in order to allow transformations to be done in any order the individual transformation matrices could be stored and multiplied in the program as required. Defining the coordinates of a given object can be tedious and full use could be made of the symmetry properties, if any, of the object in order to reduce this problem. Judicious use of subroutines would speed up the matrix multiplication and the line drawing, both of which can be relatively slow using an interpreter. This would be especially useful if fairly rapidly-moving displays

The types of programs discussed here produce 'wire-frame' pictures. These pictures result in objects like cubes having the annoying tendency to turn inside out as you look at them, presumably the brain is struggling because it has no 'z' information. The problem of suppressing the 'hidden' lines to give an artist's drawing with hidden surfaces is however a difficult one and beyond the scope of this article.

One not totally flippant approach to recovering the missing 'z' information would be to produce two stereoscopic images. After all stereoscopic images are only 2D perspective projections with different viewpoints, an extension of the above discussion. Then, with the aid of colour graphics, display each stereoscopic image in a different colour, put on suitable viewing spectacles and you have real 3D graphics!

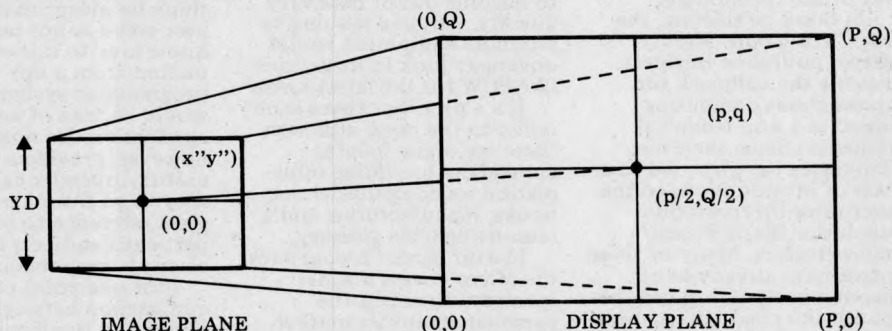

Fig 4 The image plane coordinates ($x'' y''$) mapped onto the display plane coordinates (p, q).

IMAGE Listing

```

10 GOSUB 200
20 INPUT "Rotation Angles"; ALPHA, BETA, GAMMA
30 INPUT "Local Scaling Factors"; A, B, C
40 INPUT "Translations"; U, V, W
50 INPUT "Reciprocal Viewpoint"; RZ
60 GOSUB 300
70 GOSUB 500
80 GOSUB 600
90 END
  
```

GOTO page 123 for remainder of listing.



Beginners bandwaggon

Like J Worthington Foulfellow and Gideon (the fox and cat) in Pinocchio, publishers around the world have spotted a fresh-faced innocent stepping out on the road of knowledge with a few quid to spare. Pinocchio was on his way to school when he was waylaid by Foulfellow and Gideon; the likely lads and lasses who interest modern publishers are off on the road to micro enlightenment.

At least Pinocchio had the wisdom of Jiminy Cricket and magic of the Fairy Queen to guide him; the seeker of computing truth is faced with a confusion of temptations, each claiming to be the ideal starting point for the computer beginner.

Personal Computer World led the populist computing bandwaggon in this country, following on the growth of the personal computing publishing scene in the States which first took the mystique out of the technology.

In book publishing, the late Chris Evans' *Mighty Micro*, published last year, became the hallmark for books about computing aimed at a non-technical audience. Since then the floodgates have opened to a rush of introductions to the micro/mini/information revolution/*Basic/Pascal/microetcetera*. Many of these intros have already been covered in Bookfare but this month the postman has been huffing and effing under the weight of the latest and largest wave. Of these, two British books emerge with distinction, *Living With The Micro* by Martin Banks and Robin Bradbeer's *The Personal Computer Book*. In addition, Uncle Howard Sams has launched a bunch of Stateside books in our direction. Other recent intros will, I am afraid, have to remain outtro for the time being.

Before proceeding with the Banks and Bradbeer reviews, I should declare my prejudices. I know Martin well — in fact I employed him on *Computer Weekly* to run the Micro News section. I

This month Malcolm Peltu takes a look at the latest enticements for the microcomputing novice, the way the French deal with 'telematics', and the human side of computers.

don't know Robin that well but, except for his mate Guy Kewney, he does not seem to like *Personal Computer World*, which he claims is "still looking for a real role to play in the developing hobby market".

You, dear reader, will have made your own judgement on this comment. Fortunately for me, the Bradbeer and Banks books are aimed at sufficiently different markets to avoid forcing me to make a direct comparison.

Bradbeer's *Personal Computer Book* is a straight-down-the-middle introduction to the technology of personal computers, the systems on the market and possible home applications. Although it lacks the laid-back West Coast style of many US hobbyist books on the same subject, it gains in strength by sticking to the basics without any frilly writing.

He has based the contents on his experiences at the North London Polytechnic, teaching electronics and running the local hobby club where he has had to answer the initial questions of computing innocents. He explains the components which comprise a computer lucidly with the help of cartoony diagrams and covers all the kinds of software and I/O capabilities that would be expected in a book of this ilk. There are also almost 50 pages containing product specifications, which seems an excessive amount of space for information that is bound to become out of date very quickly. Anyone wishing to purchase equipment would obviously look in magazines like PCW for the latest news.

It's a pity that there is no index to the book although there are many helpful appendices providing information on computer clubs, books, manufacturers and a reasonable little glossary.

Martin Banks' *Living with the Micro* covers a wider spectrum than just the personal computer market. As a survey of the way microelectronics fits into overall developments in information technology, it is one of the fullest, most rounded and gentlest of the many books on the subject.

Gentleness might seem a strange description to apply to a book about a new technological 'revolution' but it's the best way I can find of identifying the quality Banks has of offering the reader a touch of humanity and humour at those points in the book where the technological road might seem a bit harsh and rough, like describing software as "anything you can't kick". This gentle style infuses the book, making it

an easy and relaxed read without ever becoming too loosely informal and enables a broad spectrum of technologies and applications to be covered in a way which never becomes hard-going.

The topics covered include the usual things — what is a micro, what is software, the impact of the technology on business and on society at large, the micro in industry, and so on — which have been dealt with in other books. What makes *Living with the Micro* something special is that all developments are placed within the context of Information Technology, the subject which has been identified by governments around the world, starting with the Japanese in the late 1960s, as the strategic framework that brings together otherwise disparate developments in microelectronics, computing, telecommunications and other information sciences.

This coherent framework, coupled with the gentle writing style, means that Banks offers the reader a full, easily assimilated picture rather than the partial views which come from looking at one segment of the market or giving undue weight to any one of the information technologies.

But emphasising the need for any innocent abroad to retain a healthy degree of scepticism, Banks makes at least one major booboo when he says that information retrieval and dissemination does not require any knowledge of programming. I think he meant that from the user-end it is not necessary to know how to retrieve information from a pre-programmed system, but that would be true of any user application. He does, however, provide a very useful Appendix called *Where do you go from here?* which gives reference to books on particular subjects that would clear up any misconceptions.

Just one point of direct comparison between the Banks and Bradbeer books: the large, clear type of the *Personal Computer Book* is far more attractive to a novice reader than the smaller typeface of *Living with the Micro* and is a point that should be taken into account by publishers, even if the larger type adds to the cost.

Now to the bundle of Uncle Sams books. Howard W Sams has been one of the most prolific personal computing publishers. This summer, Prentice Hall made available a number of new Sams books in the UK.

They include two computer dictionaries by Charles J Sippl, *A Crash Course in Micro-computers and Introduction to*

Microcomputers for the Ham Shack. The cheaper (paperback) *Computer Dictionary* has a comprehensive coverage of relevant words with a strong American flavour and spelling; first published in 1966, it has been fully revised since then. Although Sippl claims that it is a 'browsing' dictionary designed to be read as a kind of educational tutorial, the dense definitions and type would become a bit mind-blowing very quickly if they were 'browsed through'.

The technical depth covered by the *Dictionary* means that it is more likely to be of use to someone deeply into computing — as a hobby or for business — rather than the kind of newcomer targeted by the Banks and Bradbeer books. The hardback *Computer Dictionary and Handbook* by Sippl includes the paperback dictionary in full plus an introduction to computing, operational research techniques and mathematical and statistical definitions, which I do not feel warrants the extra £11.00. The *Crash Course* is a self-tutorial book in which the student follows through a sequence of 'lessons' with blank spaces at key points for him to fill in before proceeding to the next lesson; at the end of each section there's a self-test quiz. If this type of approach grabs you, the book might appeal but I find it irritating and unhelpful and nowhere near as educationally appropriate as the self-instruction *Computer Programming in Basic* course from Cambridge Learning Enterprises which I reviewed in a previous Bookfare.

The *Ham Shack* introduction by Harry L Helms Jr is a more hardware-oriented version of the Bradbeer-type of book but does not contain the breadth of coverage or the useful local information obtainable from *The Personal Computer Book*.

French lesson

Britain needed a TV programme to alert its Establishment to the micro-inspired 'information revolution.' The French went about it differently.

In April 1975 the French Council of Ministers decided it was necessary to appoint an official to examine the potential impact of computers on society. Over a year later (I wonder why the delay?), Simon Nora, an Inspector General of Finances, was asked by President Giscard to undertake an 'exploratory mission' with two aims: to stimulate thinking on how the computerisation of society

should be carried out, and to define the nature and scope of the strategic policy decisions that will need to be taken. In January 1978, about the time Jim Callaghan initiated a British study into the impact of semiconductors and shortly before the BBC Horizon *Now the Chips Are Down* programme, Nora and a colleague who helped him on his study, Alain Minc, presented their report, which became an immediate best seller.

As a result, the French launched their telematic programme which includes giving a micro to every school, developing a cheapo mass facsimile device and putting a VDU into every home, starting with experimental uses of VDUs as electronic telephone directories. Meanwhile, Britain has thrashed about in a policy-making vacuum.

The Nora report has now been published by the Massachusetts Institute of Technology in a semi-English version under the title *The Computerization of Society*. The poor translation makes the book heavy going and difficult to understand in parts. The whole subject has also had such a mass media and book publishing bashing since Nora that the arguments now appear old hat. But it is still worth reading, both to provide an historical perspective on the way government intervention can play a positive role in directing developments and as an insight into the areas of technological impact which will have to be resolved during the 1980s.

The human view

The personal computer industry gave computing a human face: colour, graphics, voice and sound synthesis, etc are standard parts of the 'user friendliness' of personal computers.

The traditional business computing market, however, has been noticeable for its lack of concern shown for human factors in computer use. One reason why viewdata has proved attractive to businessmen is that it has colour displays whereas it was less than a year ago that IBM introduced the first colour business VDU.

Concern about the possible damage to the health of computer and word processor users through poorly-designed systems, particularly VDUs, first surfaced in the late 1970s when printing workers claimed that prolonged operation of VDUs damaged their eyesight. I remember running one of these stories when I was editor of *Computer Weekly*; by chance, it appeared on the same page as a VDU advertisement. When the irate manufacturer

complained about the juxtaposition I said I would publish any evidence that contradicted the claims against VDUs; the manufacturer replied that he knew of no research that proved that VDUs did *not* damage health.

As a result of the fears expressed in the printing industry, the International Research Association for Newspaper Technology commissioned a study into the human view of VDUs. The findings of that study is now published in the *Visual Display Terminals Manual*, which should be essential reading for anyone involved in managing or using computer systems.

The book looks far beyond just the question of potential damage to eyesight. It examines how methods of work organisation — for example giving operators suitable rest periods — can be used to increase productivity and job satisfaction. Detailed descriptions are provided of hardware characteristics and the best ergonomic designs that should be expected from suppliers. The way in which VDUs are located, the disturbing effects of screen reflections, glare, legibility and readability of characters, lighting, noise and positioning of VDUs in relation to windows are all factors which are discussed.

Psychological factors discussed include alienation at work, job design, fatigue and workload pressure. Many of the observations and recommendations are based on surveys of staff who have been using VDUs.

Ergonomic considerations of VDUs are becoming an intrinsic part of industrial relations negotiations because unions are asking for the specification of minimum health and safety standards as part of technology agreements which cover the conditions under which new technology is introduced. In Norway there is a Health and Safety Law which requires that new technology does not adversely effect the quality of the working environment and in Scandinavia in general it is becoming difficult to sell equipment which does not meet ergonomic considerations.

The subject of ergonomics, so long the Cinderella of the computer world, is therefore coming onto the centre stage. And about time too.

Sci-fi

The way in which a few science fiction writers have predicted future developments, like Jules Verne's submarines and Arthur C Clarke with communications satellites, has led to much discussion about how much sci-fi can be used to gain an insight into science reality.

Computer manufacturer Sperry Univac thought there was sufficient meat in this discussion to fly out a load of British journalists and sci-fi writers to Nice last year to chew the sci-fi cud in the sunshine. The proceedings have now been brought together in a book called *Future Imperfect*. It contains some interesting ideas from sci fi masters such as A E van Vogt, Harry Harrison and Clarke himself. Unfortunately, the editor of the book hasn't tightened up the text, some of which looks like verbatim transcripts of speeches which ramble a bit. It also assumes a knowledge of a lot of sci fi work as there are frequent references such as, "as Joe Lueker wrote in *Star Crinkles*"

But for sci fi freaks and others interested in the subject, it should provide an interesting read. And Sperry Univac is donating its royalties to The Save The Children Fund, so at least give *Future Imperfect* a chance.

This month's Bookfare featured:

Living with the Micro by Martin Banks (Sigma Technical Press, £4.50)

The Personal Computer Book by Robin Bradbeer (MCB Publications, £5.25)

The Computer Dictionary by Charles J Sippl (A Howard Sams publication, paperback, £8.40)

The Computer Dictionary and Handbook (A Sams publication, hardback, £19.45)

The Howard W Sams Crash Course in Microcomputers by Louis E Frenzl Jr (A Sams publication, £11.40)

Introduction to Microcomputers for the Ham Shack by Harry L Helms Jr (A Sams publication, £3.20)

Visual Display Terminals by A Cakir, D J Hart and T F M Stewart (John Wiley & Sons, £17.50)

Future Imperfect edited by Rex Malik (Frances Pinter, £4.00)

The Computerization of Society by Simon Nora and Alain Minc (MIT Press, £7.75)

All the Same publications mentioned are published in the UK by Prentice/Hall International.

TECHNICAL REVIEW

by Peter Rodwell

6502 Software Design Leo J Scanlon (Howard W Sams, £6.85)

While the Basic/Pascal/etc debate continues among high-level programmers, down at the low level there's a quieter, more fundamental rift between, on the one hand, those programmers working with the 8080/8085/Z80 family of register-orientated processors and, on the other, those used to the 6800/6502 memory-orientated CPUs.

I'll make no secret of my

allegiance to the former group and I suppose that, like most Z80 freaks, I've tended to look down somewhat on the 6800/6502 camp, a prejudice which, in my case at least, was based more on ignorance than any specific facts for there are good and bad points about both approaches to CPU architecture.

This book arrived just as I'd decided that I ought to make a serious effort to learn more about 6502 programming; after all, the damn thing is used by people like Commodore, Atari and Apple, so it can't be all bad news.

6502 Software Design is typical of books of this ilk, offering a basic grounding in the processor's architecture and its instruction set and then progressing to cover all the elementary aspects of assembler language programming which you'll need to get started on anything useful.

After the preliminaries, Scanlon goes on to discuss subroutines, time delays, lists and look-up tables (which get a whole chapter) and then looks at mathematical routines in some detail, including integer arithmetic and, more briefly, BCD (the 6502 has a handy BCD mode, unlike the Z80 which requires a special decimal adjust instruction after each arithmetical operation) and floating point number-base conversion is covered quite well, as are interrupts and resets. Frequent reference is made in the book to the Aim 65 and that machine's assembler mnemonics are used throughout, although you certainly don't need an Aim 65 to make sense of the book.

Having thus covered most of the useful things (although the use of the stack is dealt with a little cursorily), the book then goes into hardware with a handy section on 6502 compatible I/O devices. This is very useful because, of course, the assembler language programmer must have an intimate knowledge of the devices hooked up to the CPU in order to make them work. The book ends with a chapter on I/O in general, covering switches, software-scanned and encoded keyboards, Teletypewriters and seven-segment displays. Two appendices contain the apparently compulsory hex-ASCII look-up table and a 6502 instruction set summary.

I'm still not converted away from the Z80 but at least I'm now more aware of the 6502's potential, having read the book. On the whole it's a useful introduction to the subject, although I think you'd need at least some idea of what low-level programming is about before you started to read it as a certain basic level of knowledge is assumed.

Personal Computer

World

BINDERS KEEPERS
LOSERS WEEPERS

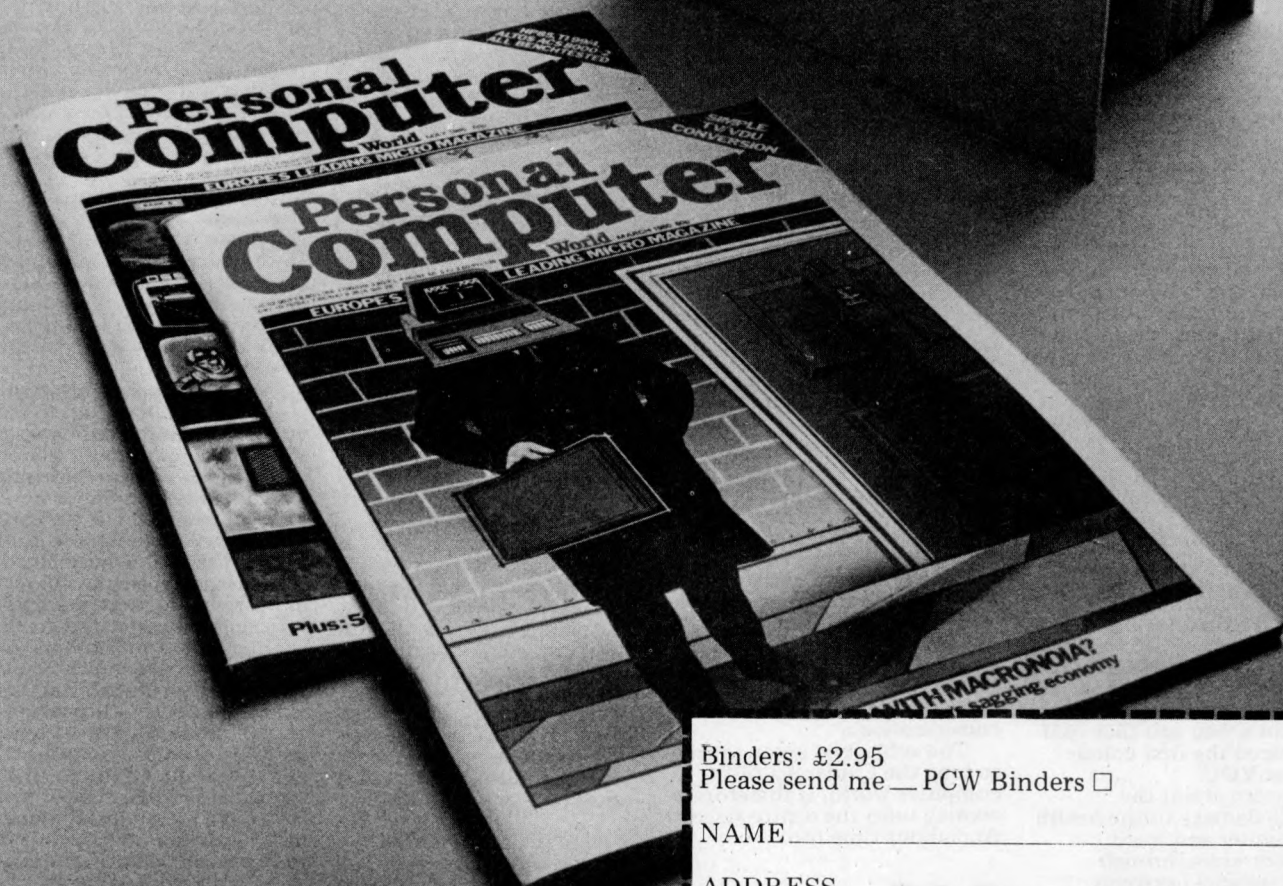
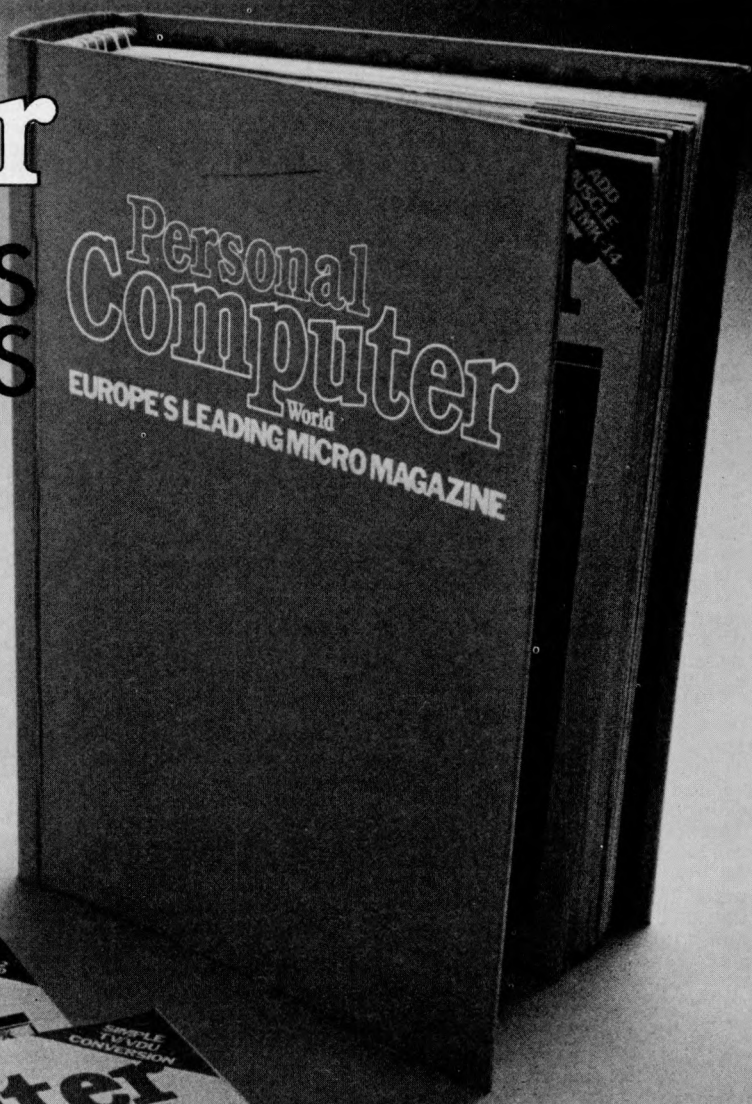

Half the people you meet today are not pre-occupied with pollution, perversion or persecution. It's worse than that — they've lost a copy or two of PCW and don't know where to find replacements.

So keep *your* copies of PCW in a beautiful bright yellow binder. £2.95 worth of smart security.

Just check the coupon at the foot of the page.

Binders: £2.95

Please send me PCW Binders

NAME _____

ADDRESS _____

(Block capitals please)

I enclose cheque/P.O. for £ _____ made payable to
Sportscene Publishers Ltd.

Send coupon to PCW (Subscriptions), 14 Rathbone
Place, London W1P 1DE. Allow at least 14 days for
processing.

**BENCH
TEST**

ATARI 400 & 800

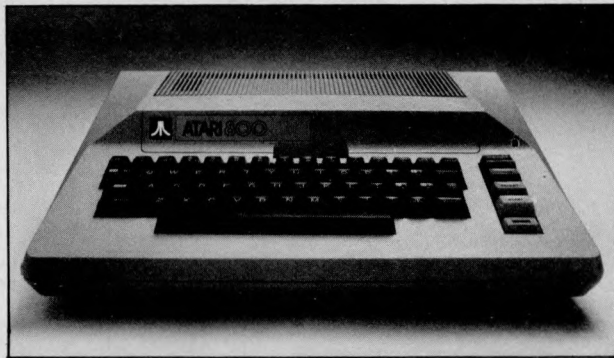

Once again PCW brings you an exclusive Benchtest — this time it's of two exciting computers to be launched early next year. By offering TV games and audio-visual education capabilities as well as normal computing, Atari says it has created the first machine to be aimed at the true home market. The easy-to-use computers plug into the domestic TV and through it provide a wide range of graphics, colours and sounds; David Tebbutt reports.

Atari claims its 400 and 800 series computers are the first of a new generation of home/personal computers. They are primarily aimed at the home user who will be able to play pre-packaged games, learn all manner of things with audio-visual educational packages, sort out his finances or simply compute. No doubt people running small businesses will be interested in this machine and many of them will find it suitable but at the moment it does have some limitations — all Atari printers use paper rolls as opposed to sprocket fed fan-fold paper and few business packages are available. It's quite possible that this will change so don't rule it out completely.

We've all been scratching around for years now wondering if and when the home market will ever exist — I think that Atari will create the market with the home education packages on this machine. One thing is very clear — as the rate of change in our society increases, so we shall have to learn new skills to cope with this change. It is well known that enjoyment goes hand-in-hand with learning — people learn more when they're having fun — so Atari has quite sensibly latched on to this and, bearing in mind the social climate, sees its educational packages being used by children and adults alike. The consumer education market is a big one; the Atari machine is well suited to it and it has the potential to do extremely well.

Both machines are well made and look quite pretty — a glance at this month's cover will tell you far more than any words I write. The 400 differs from the 800 in that it has a flat touch-sensitive keyboard and limited expansion capabilities. It is capable of doing everything that an 800 of the same memory size can do and anyone buying a 400 and then wishing to upgrade to

an 800 will be able to run all their existing programs on their new computer.

Both machines plug into the domestic TV (colour or black and white) and are very easy to use. Programs can be loaded from a cassette recorder (Atari), disk or they can be run from a plug-in cartridge. It's interesting to note that the cassette recorder is used for audio as well as digital information which means that the audio channel can be played back through the television speaker under program control — no doubt this feature forms the basis of the audio-visual packages mentioned earlier. The 800 contains a socket for a video cassette recorder — imagine the potential for this machine when video disks come along — it will be possible to access about 12,500 Mbytes of digital information on just one such disk.

Other peripherals available are disk drives, printers, an RS232 interface — necessary for talking to non-Atari devices (other printers perhaps) — games paddles (three types) and a light pen. Given the right marketing, the right price and right level of support Atari could do very well.

Hardware

I was supplied with a 16k model 400, a 48k model 800, a 90k single disk drive, a 40-column impact printer, two joystick controllers, a cassette recorder and a selection of disks and cartridges. The only problems encountered were with the TV display and the cassette recorder. The television display problem was caused by interference from one of the power supplies — a prototype made up for the review. This was quickly cured with the addition of a few smoothing capacitors which will now be incorporated in production models. A more serious problem occurred with the cassette recorder which would only

work properly about five percent of the time. We tried three different recorders, all of which worked before leaving Atari but none of which worked properly on arrival. My own mains power is the main suspect but at the time of writing the cause has not been found. Once it is, then I am quite confident that Atari will modify the equipment design to overcome similar problems in the future. Atari itself has had no problems with the recorders and a software house I know has been using the recorders (eight of them) for nine months now without any problems.

The model 400 measures 13½" x 11½" x 4½" and weighs 5¾ lbs. It has a flat keypad with each 'key' having raised edges, which makes for a much better feel than the more common totally flat keyboards. Having spent a week switching backwards and forwards between this and a conventional keyboard with real keys I definitely prefer the latter. In theory the 400 should only be connected to a printer and a cassette recorder but, in view of my cassette problems, I hooked up a disk drive and it worked. The disk operating system gobbled up rather a lot of memory with the result that I was left with just 4238 bytes for program storage. It is possible to reduce the DOS requirement by about 5 kbytes leaving just the bare minimum of routines to keep the disks running. Really, the 400 isn't a disk machine but you could probably get away with it — just.

Finally the 400 has one slot for exchangeable cartridges. I was supplied with a Basic cartridge and three games: Basketball, Star Raiders and Alien Invaders. It was very tempting to spend the week playing Star Raiders rather than preparing this review.

The 800 is clearly a more grown-up machine. It has a normal keyboard which came as a great relief after stubbing my



A useful configuration comprising an Atari 800 with disk drive, forty column printer, cassette recorder and a couple of joysticks.



Two views of the 800 showing the locations of the various plug in modules.

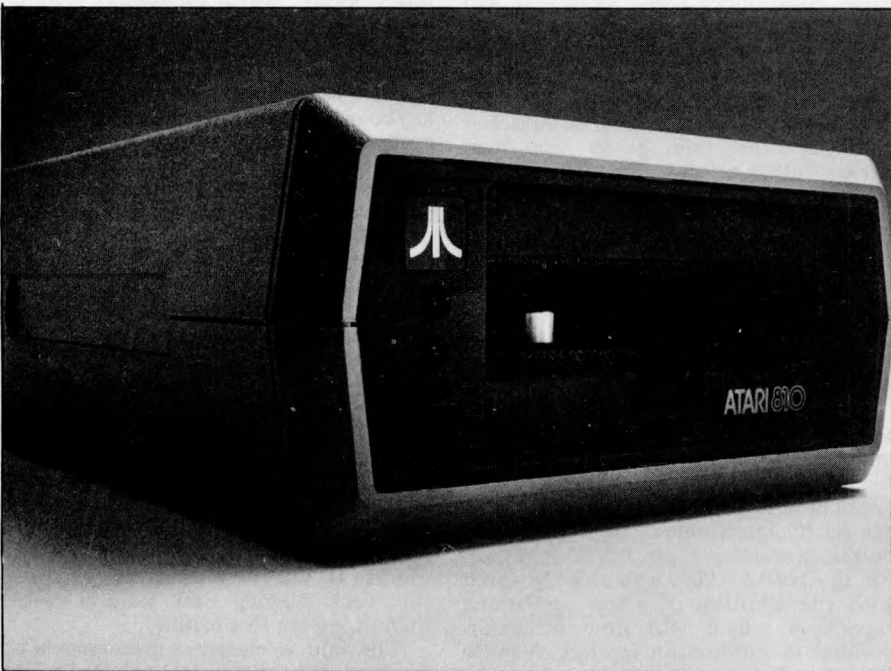

A close up of the 90k disk drive.

fingers on the 400 for a few days. The reset button is protected by a plastic surround which stops you pressing it inadvertently. For those buying a 400, don't worry — the reset doesn't clear your program. Two cartridge slots are provided: the left one is the equivalent of the one in the 400 while the other's a bit of a mystery. Somebody did mutter something about bubble memory but I think it was speculation rather than a fact. It seems to me that some cartridge programs will exceed the 8k limit and the second slot will enable them to overflow. The 800 has a DIN socket for connecting a VCR or an external monitor — see my earlier notes about video disks.

The 800 can be expanded using either 8k or 16k expansion memory modules. (Rumour has it that the 8k will be dropped and that a 32k is on its way.) Three slots are available giving a maximum of 48k if you use 16k modules. A fourth slot contains the 10k operating system. The fact that this occupies a plug-in slot must mean that the operating system can be easily upgraded. All these modules may be installed by the home user in about 30 seconds flat.

The cartridge slots occupy memory locations from 32k to 48k so if you have a 48k system you will lose 8k if slot A is in use and 16k if both are being used.

Like the 400 the 800 is compact measuring 16" x 12½" x 4½" and it weighs in at 9¾ lbs.

I have now covered all the main differences and the rest of the review relates to both machines. For convenience I shall call the machine the Atari.

The keyboard is arranged in the standard qwerty format with the addition of a number of control and special function keys. Each key may be used in three or four different modes: control, upper case, lower case and graphic character. With 57 keys this means that over 170 different characters can be generated. In addition to this, each character may be displayed in normal or inverse video giving a true range of over 340 choices. Each time a key is pressed the keyboard (not the television) 'peeps', very useful on the 400 when you can't always be sure you've made contact.

Cursor movement is as flexible as you're likely to need with up, down, left, right, clear screen and tab controls provided. It is possible to set and unset tabs anywhere along a single line on the screen. The manual suggested that tabs could be set anywhere in a logical line (up to 120 characters); if it's true I'd like someone to explain how. All keys repeat after they have been held down for about a second, which is especially useful when screen editing. All character modes — upper case, lower case, inverse video and graphics — may be 'locked' until changed. When the machine is in lower case mode, upper case characters can still be obtained by pressing the shift key just like a normal typewriter.

The screen format can be any resolution from 12 x 20 to 320 x 192 with up to five colours. In normal text mode it is 24 lines of 38 characters although the line may be altered to any length between one and 40 columns. A logical line is three times the physical line length and when nearing the end of a logical line the keyboard 'peeps' a warning. Character insertion and deletion is

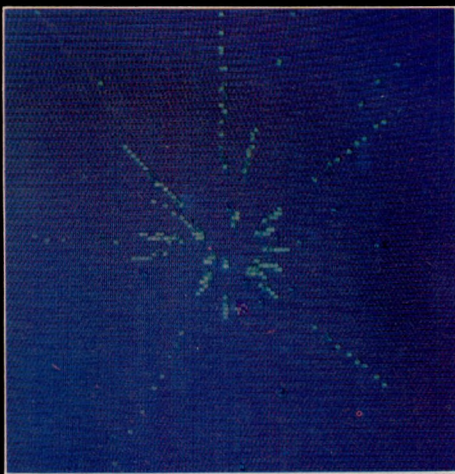

S100 COLOUR VIEW DATA DISPLAY

- S100 Bus, compatible with Northstar Horizon, Cromemco, Exidy Sorcerer, etc
- Outputs to an ordinary Colour Television UHF/PAL/625L
- Memory mapped for fast update
- Supplied with Driver Software (Z80/8080) which decodes Viewdata ESC Sequences. eg ESC A sets Red Alphanumerics
- Scroll/Page Mode, Visible/Invisible Cursor, Full Cursor Addressing
- Background Colour/Double Height/Separated Graphics/Hold Graphics, and all '76 Codes supported.
- Software available to store and retrieve Pictures from Disc (NSDOS/CP/M)

CD1 PAL or UHF **£295.00**

CD2 RGB & Syncs **£310.00**

Price includes Driver Software, P&P, but not 15% VAT.

hi-tech electronics
3 College Place, London Road, Southampton.
Telephone (0703) 581555

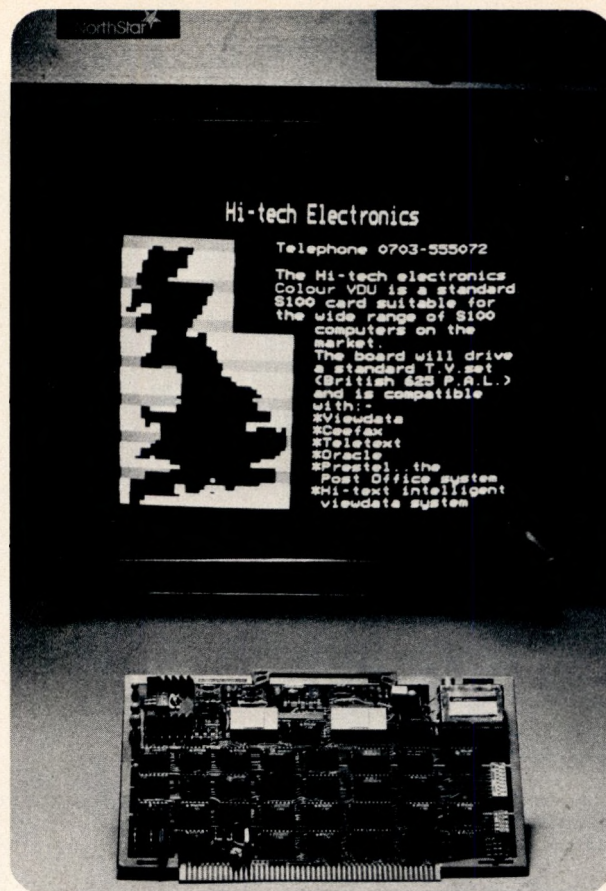

SUPERBRAIN from SUN

THE GROUP WITH A WEALTH OF HARDWARE AND SOFTWARE EXPERIENCE IN THE COMPUTER INDUSTRY

NOW WITH

■ TWO QUAD DENSITY FLOPPIES (788K)

OR TWO DOUBLE DENSITY FLOPPIES (320K)

■ TWIN Z80A MICROPROCESSORS

■ 64K RAM

■ CP/M OPERATING SYSTEM

■ M BASIC FORTRAN PASCAL COBOL

■ UP TO 90 MBYTE HARD DISK OPTION

■ WORDSTAR WITH MAILING CAPABILITY

■ INTEGRATED BUSINESS PACKAGES

REMEMBER, as major distributors we provide our dealers with:

"NO QUIBBLE" WARRANTY

FULL SUPPORT SERVICE

COMPETITIVE MAINTENANCE AGREEMENTS

IN HOUSE SOFTWARE DIVISION

DEALER ENQUIRIES WELCOME

SUN COMPUTING SERVICES LTD



Write or phone for the name and address of your nearest dealer:
138 Chalmers Way, North Feltham Trading Estate,
Feltham, Middlesex. Tel: 01-751 6695
Telex 8954428 SUNCOMG

SUPERBRAIN is a registered trade mark of Intertec Data Systems.

Unique in concept—the home computer that grows as you do!

The Acorn Atom

£120

plus VAT and p&p

Special features include

- * FULL SIZED KEYBOARD
- * ASSEMBLER AND BASIC
- * TOP QUALITY MOULDED CASE
- * HIGH RESOLUTION COLOUR GRAPHICS*



Also available ready-built
£150
plus VAT and p&p

● The picture shows mixed graphics and characters in three colours

* optional

The Acorn Atom is a definitive personal computer. Simple to build, simple to operate. A powerful, full facility computer with all the features you would expect. Just connect the assembled computer to any domestic TV and power source and you are ready to begin. (Power requirement: 8V at 800mA). There is an ATOM power unit available – see the coupon below.

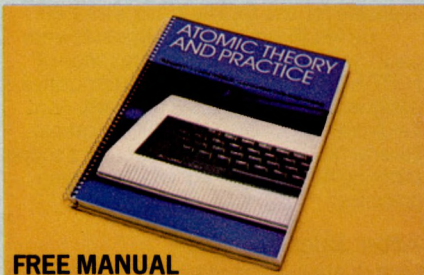

FREE MANUAL

Free with every ATOM, kit or built, is a computer manual. The first section explains and teaches you BASIC, the language that most personal computers and the ATOM operate in. The instructions are simple and learning quickly becomes a pleasure. You'll soon be writing your own programs. The second section is a reference

manual giving a full description of the ATOM's facilities and how to use them. Both sections are fully illustrated with example programs.

The standard ATOM includes:

HARDWARE

- Full-sized QWERTY keyboard
- 6502 Microprocessor
- Rugged injection-moulded case
- 2K RAM
- 8K HYPER-ROM
- 23 integrated circuits and sockets
- Audio cassette interface
- UHF TV output
- Full assembly instructions

SOFTWARE

- 32-bit arithmetic ($\pm 2,000,000,000$)
- High speed execution
- 43 standard/extended BASIC commands
- Variable length strings (up to 256 characters)
- String manipulation functions
- 27 x 32 bit integer variables
- 27 additional arrays
- Random number function
- PUT and GET byte
- WAIT command for timing
- DO-UNTIL construction
- Logical operators (AND, OR, EX-OR)
- Link to machine – code routines
- PLOT commands, DRAW and MOVE

The ATOM modular concept

The ATOM has been designed to grow with you. As you build confidence and knowledge you can add more components. For instance the next stage might be to increase the ROM and RAM on the basic ATOM from 8K + 2K to 12K + 12K respectively. This will give you a direct printer drive, floating point mathematics, scientific and trigonometric functions, high resolution graphics.

From there you can expand indefinitely. Acorn have produced an enormous range of compatible PCB's which can be added to your original computer. For instance:

- A module to give red, green and blue colour signals
- Teletext VDU card (for Prestel and Ceefax information)
- An in-board connector for a communications loop interface – any number of ATOMs may be linked to each other – or to a master system with mass storage/hard copy facility
- Floppy disk controller card. For details of these and other additions write to the address below.

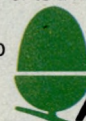

ACORN COMPUTER 4a Market Hill, CAMBRIDGE CB2 3NJ

Your ACORN ATOM may qualify as a business expense. To order complete the coupon below and post to Acorn Computer for delivery within 28 days. Return as received within 14 days for full money refund if not completely satisfied. **All components are guaranteed with full service/repair facility available.**

Please send me the following items:

Quantity	Item	Item price inc. VAT+p&p	TOTALS
	ATOM KIT – 8K ROM + 2K RAM (MIN)	@ £140.00	
	ATOM ASSEMBLED – 8K ROM + 2K RAM (MIN)	@ £174.50	
	ATOM KIT – 12K ROM + 12K RAM (MAX)	@ £255.00	
	ATOM ASSEMBLED – 12K ROM + 12K RAM (MAX)	@ £289.50	
	1K RAM SETS	@ £11.22	
	4K FLOATING POINT ROM (inc in 12K Version)	@ £23.30	
	PRINTER DRIVE		
	6522 VIA	@ £10.35	
	(inc in 12K version) LS244 Buffer	@ £3.17	
	MAINS POWER SUPPLY (1.3 amps)	@ £10.20	
		TOTAL	

To: Acorn Computer Ltd., 4a Market Hill, CAMBRIDGE CB2 3NJ

I enclose cheque/postal order for £ _____

Please debit my Access/Barclaycard No. _____

Signature _____

Name (Please print) _____

Address _____

Telephone No. _____

Registered No: 1403810. VAT No: 215 400 220

PCW/9/80



ALLOS



The true multi user computer system

The ALTOS ACS 8000 range of business/scientific micro computers creates a new standard in quality and reliability in high technology micro computers.

Hard Disk/Multi User Systems

The Winchester hard disk/multi user systems are now available supporting up to 4 simultaneous users and providing a maximum of 58 Megabytes of hard disk data storage.

The systems are truly flexible and allow expansion of the ALTOS floppy disk system to keep pace with the users requirements.

Still single board, features include

- a high speed I/O section with up to six serial ports and one 8 bit Parallel port
- up to 208K of on board R.A.M.
- High speed (4 MHz.) D.M.A. control as standard.

Yes, mini power and at micro cost too.

Hard Disk Security Back-up

The 17.5 Megabyte funnel tape unit permits selective dumping from the Winchester at a rate of 1 Megabyte per minute.

Built-in Reliability

The ACS 8000 range are true single board micro computers making them extremely reliable and maintainable. All electronics are socketed for quick replacement. Complete diagnostic utility software for drives and memory is provided.

The board and Shugart floppy disk drives are easily accessible and can be removed in less than ten minutes.

Quality Software

Unlimited versatility. The ACS 8000 range support the widely accepted CP/M and MP/M operating systems plus basic (Microsoft and CBasic), Cobol, Pascal, and Fortran IV. All available now.

Logitek in conjunction with its own microsoftware house, Interface Software Ltd. of Camberley are able to supply a wide range of proven 'off-the-shelf' business software including general accounting, word processing, stock control, mailing list etc.

There are already over 1000 micro computer installations using this software. A track record which we consider speaks for itself. Why 're-invent the wheel' when there is standard software of this quality available now?

Communication Software

Two new custom software packages are now available for the Altos Computer System operating with CP/M to enable it to communicate with remote machines over ordinary telephone lines. ASYNC is an asynchronous package that operates with almost any remote machine. SYNCH is a synchronous package for use with the IBM 3780 protocols.

Custom Graphics & Scientific Software

A full graphics and scientific package is now available for use for the Altos with FPP.

GRAFLIB is a custom Altos software package containing a complete range of FORTRAN-callable graphics subroutines. It is designed with DRE RG-512 board, or a Tektronix 4000 series graphics terminal. Several multi-colour X-Y plotters are supported allowing hard copy in addition to screen graphics.

After Sales Support

Logitek are supported by DDT Maintenance Ltd. who provide a nationwide field maintenance service for Altos products and offer the option of maintenance contracts.

Availability

Logitek carry deep shelf stocks of Altos hardware and compatible peripherals.

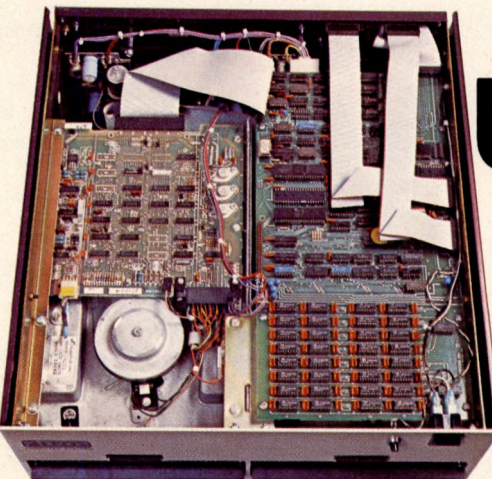

LOGITEK

LOGITEK, E.I.C. Electronics Ltd.

All enquiries to

8-10 Fazakerley St., Chorley,
Lancs. Tel: 02572 67615/70206

also at

30 Kelvin Ave.,
Hillingdon Industrial Estate,
Glasgow G52 4LH

Logitek are now the exclusive distributors of
Altos Computer Products for the U.K. and Eire

provided as well as line insertion and deletion. Line delete removes a whole logical line from the display but not from memory (if you're keying a program) whereas line insert makes space for a single physical line.

Four remaining keys on the right of the keyboard allow for system reset, select, option and start. Apart from reset these keys relate to the selection and initiation of functions in a cartridge.

The processor used is the 6502, the same as that in the PET, Apple and others. It runs at 1.8 MHz and gives benchmark timings which are a little slower than PET or Apple. The real time clock runs at 50 Hz, unlike the American version which runs at 60Hz so some US packages will run a little slow in the UK.

Four ports are provided at the front of the machine for attaching controllers — either knobs, joysticks or keypads. Up to eight controller knobs may be attached (in pairs) each returning a value from one to 228 depending on the knob's position. The joystick is a nine-position controller and up to four may be attached. As well as the positional controls, each device contains a trigger button. Up to four keypads may be attached, each containing keys 0 to 9, * and #.

One input/output port is provided on the side of the machine. Each device which can be attached has two sockets to enable others to be 'daisy chained'. The printer, disk drives, cassette recorder and RS232C expansion unit may all be connected in this fashion. A light pen plugs into one of the front controller ports.

The cassette recorder can be used with any high quality audio tape and reads from two channels — one audio, the other digital. It transfers digital information at 600 baud and is very sensitive to speed fluctuations. Sound is output through the television. The recorder has a tape counter to give the approximate position of a program and, as each recording has an 18 second leader, the precise location of the program start is not too critical.

The printer supplied was a 40-column impact machine with 5 x 7 matrix. With its on-board 6502, I reckon it could do more than I could find out. I managed to get the standard character set but no graphics. The documentation gives tantalising hints of more features, mainly to do with the ability to print horizontally and vertically but I couldn't get it to work.

Two other printers are available, a thermal 40-column device and an 80-column machine. All three printers use a paper roll which limits the scope of the machine a little.

The disk drive supplied was a 5¼" 90k single sided device whose origin appears to be Atari. I had a little peek inside and could find no manufacturer's references other than Atari itself. Up to four drives may be attached or, if you need more storage, a double density dual drive is available, giving about 160 kbytes per disk. Again, up to four of these drives may be attached, giving a total over 1.2 MBytes.

I consider the hardware to be very well made and certainly attractive enough to have in the home.

Software

The main operating system occupies a



A close look at the 400 keyboard and cartridge slot.

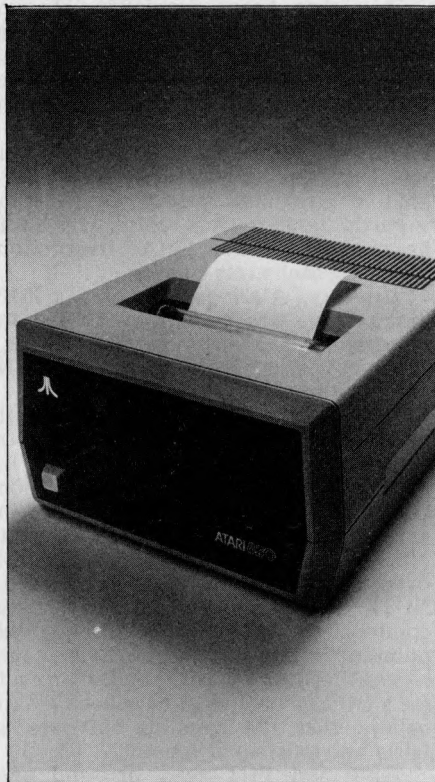

Outside and...



The special Atari recorder.

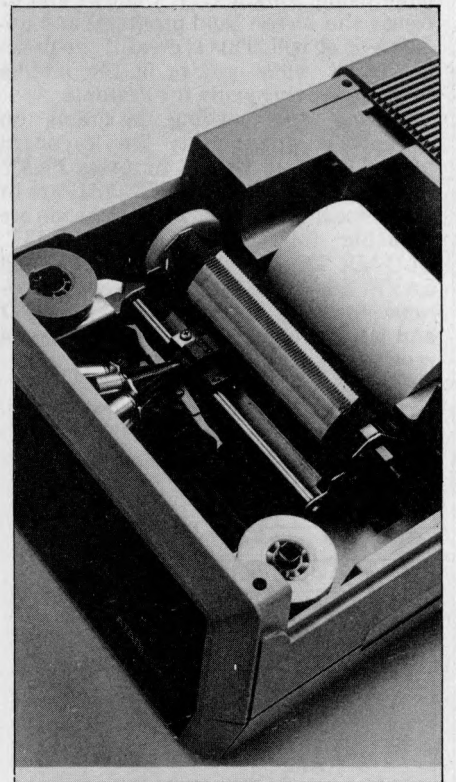

... inside the 40-column impact printer.

10k ROM slot, the disk operating system is loaded from disk and takes up almost 9k of user RAM and the Basic cartridge occupies the RAM from 40 to 48k. At the moment games and other package modules occupy the same slot as the Basic cartridge.

Every package comes with an instruction booklet which can be quite substantial: a 12-page booklet explains the Star Raiders game for example. To digress for a moment, the Star Raiders game is similar to many of the Star Trek type games *except* the television screen gives what appears to be a three-dimensional view of space. In fact it creates

the illusion of being the window of your spaceship. Believe me it's quite addictive and there are several levels of play, each rewarding you with a whole series of grades depending on your performance in your mission. It could take weeks, months even, to reach the highest rank of star commander.

I've been told by someone who knows about these things that the programs available now are nothing compared with what's coming along.

Two program libraries exist, one for 8k programs and the other for 16k. The latter contains this new generation of games as well as new programming lan-

guages and business information processing packages. An enormous amount of Talk and Teach courseware is being prepared, such as Basic Psychology, Basic Sociology, Effective Writing, Counselling Procedures, Supervisory Skills, Principles of Accounting, Principles of Economics, Spelling, History and so on...

A terminal emulator and an assembler/editor look like interesting cartridges to get hold of as well.

Basic

It would be impossible to give a full description of Atari Basic in this review. Instead I shall restrict my comments mainly to those aspects of the language which are different to the Basics normally encountered.

First of all a couple of points relating to program input and editing. Atari Basic checks command syntax quite carefully at the time of input and, if it detects an error, highlights it with a marker at the part of the line at fault. Unfortunately this admirable approach stops when programs are run. The user is presented with an error code number which has to be looked up in the manual. It's possible to use a reserved word as a variable name although Atari doesn't recommend it; I tried LET LET=10: GOTO LET, yes, you can GOTO a variable name. Finally CTL 1 allows you to freeze the screen (and program) and unfreeze it at will. This is great if the doorbell rings while you're in the middle of a fast moving game for example.

Saving and loading programs on cassette is quite neat; the keyboard 'peeps' once if you're to press PLAY and twice if PLAY and RECORD are to be pressed. A number of commands are available for these functions, LIST, CLOAD, LOAD, ENTER, CSAVE and SAVE. SAVE or LIST can record programs for later merging by the LOAD and ENTER commands. CSAVE saves a more compact version of the program.

Memory map

Operating system	FFFFFH
Floating point routines	DFFFH
Hardware registers	D7FFFH
Not used	CFFFH
Slot A or RAM	BFFFH
Slot B or RAM	9FFFH
Basic & RAM	7FFFH
DOS & RAM	2A7FH
System controls & RAM	12FFFH
	0000H

The string functions are adequate but hardly exciting. For a start all strings must be defined using a DIM statement, thus turning each string into a single dimension array, as in Cromemco's 16k Basic. No string arrays (in the normal meaning of the term) are allowed, which can be a bit of a nuisance. On the bright side, there's no limit on the length of a string although substrings are limited to a maximum of 99 characters. Substrings may be concatenated but not with the usual '+'; on the Atari it is necessary to devise an expression such as Z\$(LEN(Z\$)+1)=A\$; this adds A\$ to the end of Z\$. All string variables can be subscripted either with a single number or with two separated by a comma. A single character means 'from this character position to the end of the string', while two characters define the start and end positions within the string.

The INPUT instruction will accept commas as part of the string, unlike so many other Basics. Unfortunately the machine gives no warning if the string is too long for the space available to accept it — the poor thing is simply truncated. Another oddity about Atari Basic is that you can't include a prompt in the INPUT statement and it's necessary to precede it with a PRINT.

ADR returns the memory address in decimal of the start of any given string.

A matrix has a maximum of two dimensions as opposed to the more usual three. Unlike the ZX80 which can only work with integers, it is impossible to define integer variables on the Atari machine.

A nice feature is TRAP; this allows you to define an address to which program control must pass when an error is encountered — very useful. This must be reset with a new TRAP instruction following each error trapped.

Sensibly, Atari has included a POP instruction which enables you to remove the top entry from the stack, essential if you decide not to RETURN from a subroutine.

Disk handling is somewhat crude but nevertheless effective. It comprises three useful commands — NOTE, POINT and OPEN. I only mention OPEN because a file may be opened in append mode which is quite useful. The other two commands give direct control over where the disk is to be accessed. NOTE saves the current sector/byte combination while POINT sets internal pointers to the next sector/byte to be accessed. Think about it. Sadly I didn't see a DOS manual but I have been led to believe that file handling software is fairly non-existent at present.

GET and PUT read or send one character to a specified device and the

location pointer is then incremented by one.

Many instructions are quite lengthy so an XIO command has been provided to give a sort of shorthand. The required function is accessed by issuing an XIO with a command number selected from a table. It has one extra function not provided by any other command and that is to FILL a previously defined graphics area.

Surprisingly, user defined functions are not allowed in Atari Basic. There are, however, a number of functions, among which are RAD, DEG and CLOG. RAD or DEG selects whether results are to be in radians or degrees — the mode won't change until another RAD or DEG instruction is encountered. CLOG gives logarithms to base 10. Mathematics are to nine-place accuracy except for EXP which will be at least six.

The graphics on this machine more than make up for any minor deficiencies in the other departments. It is possible to select from 128 colour/luminance combinations and 17 different screen arrangements. Up to five colours may be displayed, depending on the particular graphics mode in operation. Table 1 gives the range of options together with their RAM requirements.

Two of the more useful commands are DRAWTO which draws a line from the last location plotted to the coordinates defined and SETCOLOR which is used to set each of the five possible colours. Mixed text and graphics are allowed, so it's necessary to move an 'invisible cursor' around the screen. This is done using the POSITION command; text sent to the graphics area will then appear at that position.

The graphics commands take a lot of effort to master but they are definitely worth it. You may even find a few modes that are not in the manual, as I did.

One look at the Basketball or Star Raiders games tells me that there are far more graphics facilities locked away inside the machine. Atari isn't telling though, so it will be left to some bright programmers to get inside the software and then to spill the beans. (To PCW perhaps?) For now I would suggest you go to a pub or an arcade where Atari machines are installed to get some idea of their potential. One of the interesting features is the 'simultaneous' movement in different directions of large graphic figures (people, spaceships etc).

Up to four sounds may be played simultaneously; the pitch of each may be varied from one octave below middle C to two octaves above it. Special

Basic Reserved Words

+	—	*	/	^	NOT		
BYE	CONT	END	LET	LIST	NEW	REM	RUN
FOR...TO...STEP...NEXT			GOSUB...RETURN		GOTO	IF...THEN	STOP
ON...GOSUB	ON...GOTO			POP	RESTORE	TRAP	
CLOAD	CSAVE	DOS	ENTER	INPUT	LOAD	LPRINT	NOTE
OPEN	CLOSE	POINT	PRINT	PUT	GET	READ/DATA	SAVE
STATUS	XIO						
ABS	CLOG	EXP	INT	LOG	RND	SGN SQR	USR
ATN	COS	SIN	DEG	RAD	ADR	FRE	POKE
ASC	CHR\$	LEN	STR\$	VAL		PEEK	SQR
DIM	CLR						
GRAPHICS	COLOR	DRAWTO	LOCATE	PLOT	POSITION		
SETCOLOR							
SOUND	PADDLE	PTRIG	STICK	STRIG			

distortion effects and separate volume controls may be applied to each voice, using the SOUND command, and once a sound is initiated it will continue until stopped by a reset, END or another SOUND instruction for the same channel.

You will see from the Basic reserved words table that there are many commands not even hinted at here. In my view it's a good Basic with just the one or two limitations mentioned above.

The disk operating system (DOS) must be booted in before programming starts, which is very important, not least because the machine has to be switched off before DOS can be loaded. It was difficult for me to evaluate the DOS properly as I didn't have the DOS manual; all I can say is that it worked for me — I had no disk problems at all and I was saving and loading both programs and files. A menu can be displayed which shows that DOS offers the usual functions such as file copy, delete, rename, lock, unlock as well as disk level commands such as copy, write DOS to disk, format disk and duplicate disk. I was disappointed not to find mention of any file handling procedures as this would save each user reinventing this particular wheel.

Benchmark timings (all times in seconds)

BM1	2.35
BM2	7.41
BM3	19.89
BM4	23.16
BM5	26.78
BM6	40.75
BM7	61.51
BM8	43.08

TECHNICAL SPECIFICATION

CPU: 6502, 1.8 MHz
Memory: 8-48k (16k limit on 400), 8k ROM Basic (40-48k RAM location) 10k ROM operating system.
Keyboard: Full qwerty + special keys. (61 keys including controls).
Screen: Domestic television. 12x20 to 320x192 resolution. Up to five selected from 128 colour/luminance combinations, 4-channel sound Digital, 600 baud. Audio channel. Tape counter.
Cassette: 40 col impact or thermal, 80 col impact.
Disk drives: 5¼" 90k. 5¼" twin 160k drive. Up to 4 drives per system.
Printers: Interface module gives RS232C. VCR socket on 800 (can be used for a monitor). 4 games controller/light pen sockets.
Ports: 10k operating system. 9k (almost) DOS in RAM.
System S/W: 8k Basic (others coming)
Language: 8k Basic (others coming)

	Graphics mode	Columns	Rows		No. of colours	RAM required
			Full	Split		
Text	0	40	24	—	2*	993
	1	20	24	20	5	513
	2	20	12	10	5	261
mixed text/graphics	3	40	24	20	4	273
	4	80	48	40	2	537
	5	80	48	40	4	1017
	6	160	96	80	2	2025
	7	160	96	80	4	3945
	8	320	192	160	1*	7900

* 2 luminances may be defined for one colour
 4 text lines are provided at the foot of each split screen.

Table 1 Graphics options

Potential use

Without doubt this machine is aimed at the home user and education in its widest sense. The audio visual facilities will find a place in the home, in commercial training establishments as well as in the school. The games will be an attraction to those already interested in computing while at the same time involving those who wouldn't normally touch a computer with a barge pole. The home computer will have a whale of a time while the more serious may reconcile their household accounts and taxes on it. The businessman may use it but probably only the smallest, the architect or engineer perhaps. The 400 should be ruled out for serious computing although it is ideal for games/computing/education. The 800 offers a more grown-up option with plenty of growth capability; disks and the RS232C interface will ensure that some quite serious users will buy.

Both machines are friendly, they have the solid backing of Atari and, behind it, Warner Brothers Communications.

This machine is probably the strongest contender for the home computer market in Britain today.

Documentation

A lot of effort has gone into the preparation of the documentation. It has been well produced although there is still some room for improvement. The operator's manuals are very clear as are the instructions for operating the various cartridges. A Basic manual written by Albrecht, Finkel and Brown was also quite excellent.

Aimed at the absolute novice, this book takes you through most of the various features and functions of Atari Basic. All except our friends the I/O commands, that is. Experienced programmers will probably dip into this book but I would recommend a beginner to work through it carefully. The Atari Basic reference manual is quite good for the experienced programmer but not a lot of use to the beginner except for the appendices which give all sorts of interesting information such as the derivation of mathematical functions in terms of Atari Basic, memory maps, useful POKE & PEEK locations, error codes and the various graphics modes.

I'd like to have seen more in Atari's own manual; I did feel that they skimped a bit on explanations, especially with regard to printer and disk operation.

Prices

Prices in the UK have not been finalised so I shall give Atari's "approximate anticipated retail" figures which include VAT.

16k 400	£395
16k 800	£695
Cassette Recorder	£55
90k Disk Drive	£525
80 column printer	£500
16k RAM	£145

My guess (not Atari's) is that the cartridges will range from £20 to £50.

Conclusion

I've said it all earlier in the review but for the benefit of those busy people who only read the introduction and conclusion, I think that Atari is doing a very professional job. The machines are clearly aimed at the home market where, as well as satisfying a demand for sophisticated games and Basic computing, they might spawn a completely new 'consumer education' boom. Self improvement is rapidly becoming a necessity and Atari seems set fair to help/capitalise depending on your viewpoint. Some small business owners may buy but they are unlikely to form a major part of the installed base. The official UK launch isn't until early next year so Atari has time to fix the odd hardware problems encountered during the review.

At a glance

**** excellent, **** V. good, *** good, ** fair, * poor.

FIRST IMPRESSIONS

Looks	****
Setting up	****
Ease of use	****

LANGUAGES

Basic	****
System software	**

PACKAGES

Business	not reviewed
Education	not reviewed
Home	****

PERFORMANCE

Processor	**
Cassette	see text
Disk	**

COMPATIBILITY

Hardware	**
Software	*

DOCUMENTATION

DOCUMENTATION	****
---------------	------

VALUE FOR MONEY

VALUE FOR MONEY	****
-----------------	------

DAI PERSONAL COMPUTER

Continuing this month's special look at home computers, Sue Eisenbach tests a new machine from Belgium.

Rumour has it that when Texas Instruments was designing its personal computer, it knew that producing a colour signal for English and European TV would cause difficulties and so it approached a Belgian firm, Data Applications International (DAI), to design a European microcomputer. The brief was wide — using Texas components, produce a personal computer with sound and good colour graphics that may be used with domestic televisions. By the time the DAI personal computer was developed, TI had had a change of heart: it decided to market the 99/4 in Europe with an American colour monitor — which increased its price but solved the 'European problem'. DAI was left holding a computer, the design of which had been funded by TI. . . and it is this machine that Data Applications [UK] Ltd has now launched onto the British market.

Hardware

The DAI personal computer is a single board based around the 8080A micro-processor. It's contained in a smart white lightweight case, which also holds the keyboard and is held together by four black plastic pins which can be pushed in or out by hand.

For mass storage the DAI expects an ordinary audio cassette recorder; two audio cassette interfaces with motor control work at 600 baud. The machine produces sound (more on this later) which can be output in mono through the loudspeaker of a domestic TV or through a stereo system for full stereo.

There's a socket on the PCB for the AMD 9511 maths chip, which the review machine contained. Benchmark 8 tests the speed of mathematical functions; I disabled (by software) the AMD 9511 and ran benchmark 8 a second time and it ran eight times slower.

The DAI plugs into a domestic TV and produces an excellent colour picture. According to the manual, it can also be plugged into SECAM and NTSC televisions or a colour monitor. The ASCII keyboard is fairly standard with cursor control keys on the left. On booting the system, the keyboard produces only upper case letters but there's a control key that toggles in a full typewriter-style keyboard. (The Basic does not accept lower case commands so this is a feature which may have limited use.) The reset button in the top left hand corner is recessed and requires pressure from a hard object (eg a pencil point) to activate. The computer contains a software keyboard

scan and encoder.

The DAI has an external connector for a flat cable to the DCE bus — the bus used by Data Applications' other bus-based computer. According to the manual this bus can also be used for connecting up to a parallel printer. There's also an RS232 connector on the back of the computer.

The dynamic RAM is divided into three separate memory banks which can contain 0, 4k or 16k of RAM. The RAM is seen by the program as a continuous memory block starting at 0000H. The first RAM bank (which may not exist) is for programs, while the second two are used for both programs and display data. The second two banks contain the low order and high order bits of the 16-bit words needed for the display. The RAM configurations allowable are 8k, 12k, 32k, 36k and 48k.

The Basic and other system software sits in ROMs starting at address C000H and extending to EFFFH. Addresses E00H through EFFH have four switchable banks of program address space giving a total ROM address space of 24 kbytes. Static RAM occupies the address range F800H to F8FFH which is used by the 8080A for stack space while the top of the address space is used for memory-mapped I/O.

The DAI has five programmable interval timers, two external interrupts and two serial I/O interrupts. According to the manual, it has the appropriate circuitry for connecting two games

paddles as input devices. Each paddle contains three variable resistors whose positions are read as values and one on-off event.

Basic

On power-up, DAI PERSONAL COMPUTER appears in large white letters on a bright green background; hitting any key clears the screen and puts BASIC V1.0 in small black letters on a white screen. The Basic occupies 24k and although written by DAI, shows a strong Microsoft influence, as can be seen from the table of Basic reserved words.

DAI variables can be up to 14 characters long. Both integer and floating point numbers are recognized; integers are 9 digits whereas reals are in the range 10^{-18} to 10^{18} (4 bytes) with 6-digit printout. All numbers are assumed to be floating point unless declared with a % sign after the variable name or by means of an IMP statement. IMP INT I-N declares all variables that start with I-N as being integer variables. Not only are there no rounding errors when using integers but there can also be a substantial improvement in speed. When I changed the variables in benchmark 1 to integers, the program ran in 0.68 seconds, or 73% of the floating point version of the program.

Leaving aside the graphics and sound commands for fuller treatment later, the commands that don't look like Microsoft include:



CALLM N, [V], which calls a machine language routine located at N. If the second parameter is included in a CALLM statement, then the HL register pair will contain the address of variable V. Upon return all 8080 registers and flags are restored to their original state; A = INP (#N) reads a byte off the Nth Port into A;

OUT #N, A puts A into Port N; A = PDL (I) sets A to the position of the Ith paddle potentiometer;

UT calls the machine language monitor;

CHECK scans a cassette tape (or disk) and examines all files to see if their checksums are correct;

LOADA loads an array (or machine language program stored as an array);

SAVEA saves an array on cassette (or disk);

STEP allows single-stepping through a Basic program;

A = VARPTR(B) variable A is set to the address of B;

HEX\$(I) returns a string of characters representing the hex value of the number I;

LOGT(X) calculates the logarithm base 10 of X;

RND(X) for which the user has the choice of a hardware or software generated random number.

Typing EDIT does not have the same effect as in Microsoft Basic. Rather, EDIT calls the editor, loads the current program into it and displays the first 24 lines of text. Once in the editor, a program can be easily altered by either moving the cursor (using the cursor keys) around to the appropriate place and retyping or by moving the text around (shift and cursor keys) and retyping. Up to 255 characters may be stored in a line and viewed by 'panning' the screen. Carriage returns are visible within the editor. If only a few lines are required then the editor can be called with EDIT N-M, EDIT N, EDIT N- or EDIT .N. The editor is very easy to use and can be left by pressing BREAK, followed by space (to keep the changes) or BREAK, BREAK if the edit is to be disregarded. I found the editor convenient and very easy to use.

DAI Basic is 'semi-compiling' — after each line is typed in, it is

translated into an intermediate code that is faster to execute than the Basic statement typed in. Usually a 'semi-compiling' Basic will not accept a line if it contains errors since it cannot translate it into intermediate code. This can be quite irritating if you have to type a long line again because of a silly typing error but DAI Basic has got around this problem. When an incorrect line is typed in, an error message immediately appears. When the program is listed, the erroneous line is there but has *** in front of it. These can be easily edited out when the line is corrected in the editor.

Every effort has been made in DAI Basic to help the user debug a program easily. As well as the debugging statements STEP, TRON, TROFF and the listing of error lines with ***, there are 25 distinct error messages. These are more helpful than the usual SYNTAX ERROR and are in English (eg COLOUR NOT AVAILABLE IN LINE 200).

Graphics

The DAI personal computer has three graphics definitions available (low, medium and high resolution) as well as an all character mode. The character mode displays 60 by 24 characters. The graphics definitions are: low — 65 x 88 pixels; medium — 130 x 176 pixels; high — 260 x 352 pixels.

At each level of definition the user has the choice of all graphics or four lines of text on the bottom. If an executing program uses a graphics only mode and the user breaks in, the DAI will move the picture up, switching into graphics and text mode. On typing CONT the picture rolls back down and the program continues.

The graphics takes up user RAM (see memory map) so you need at least 32k to use the high resolution graphics. The DAI provides 16 colours; if all of these were usable without restrictions, far too much of the user RAM would be occupied with the screen image. Instead, DAI has two modes, a full-colour mode and a restricted 16-colour mode for each graphics definition. In four-colour mode the user chooses four colours out of the 16 available (which can be

changed at will, and the existing picture changes colour immediately) and can use any of these colours anywhere on the screen. In a 16-colour mode, the screen is divided into vertical fields 8 pixels across. Within each field only two colours can be used.

A demonstration program was provided with the machine that followed a place through a full 24 hours. It started with a crescent moon in the left hand corner on a dark blue screen. As time went by, first stars came out and then the sky faded into light blue. After the horizon became visible the (perfectly round) sun slowly rose. When it was high in the sky a Dutch flag was raised on a flagpole. This was followed by the playing of the Dutch national anthem. When this was completed, clouds passed across the screen and night descended.

The colours were clear and the resolution seemed fine. The graphics can be accessed through machine code or by the following commands in Basic:

COLORG A B C D for graphics mode — this sets up the four colours to be used in four colour mode.

COLORT A B 0 0 for text — this sets up A as the background colour and B as the character colour.

DOT X, Y, A. This places a pixel of colour A at point X, Y.

DRAW X1, Y1 X2, Y2 A. This draws a line of colour A between X1, Y1 and X2, Y2.

FILL X1, Y1 X2, Y2 A. This fills a rectangle with opposite corners at X1, Y1 and X2, Y2 with colour A.

XMAX. The maximum allowable X value for the current graphics mode.

YMAX. The maximum allowable Y value for the current graphics mode.

SCRN(X, Y). The colour coordinates X, Y.

CURSOR X, Y. In text mode this moves the cursor to the Xth character in the Yth line from the bottom of the screen.

CURX. The Xth coordinate of the cursor.

CURY. The Yth coordinate of the cursor.

I found the graphics easy to use and impressive. My criticisms are twofold. Firstly, I'd like to see a set of sub-routines for drawing characters in graphics modes (graphs do improve with labels on their axes), and it would be nice (especially with the 48k machine) for there to be low and medium resolution modes that allow the use of 16 colours anywhere on the screen.

Sound

The DAI can generate sound using three independent programmable oscillators and a random noise generator. Each of the oscillator channels can be programmed to produce sound in the frequency range 30 Hz to 1 MHz at whatever amplitude is required. The noise generator which produces random frequencies is designed to simulate white noise and to provide a random sequence for random numbers. Oscillator channels one and two are used to produce sound for the left stereo output while channels two and three are used for the right stereo output.

A music program 'Music Tutor' came with the review machine. When run, staves appeared on the screen and the

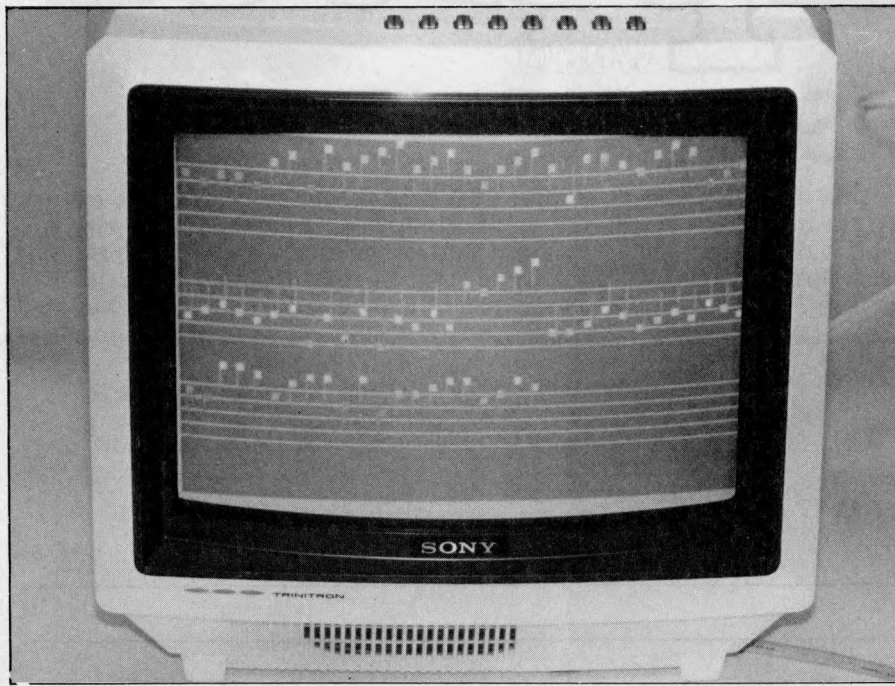



L&J COMPUTERS

3 CRUNDALE AVENUE, KINGSBURY NW9 9PJ 01-204 7525

THE "PET" SPECIALISTS



NEW LOW, LOW 'PET' PRICES!!

Pet 8K (large keys)	£420
Pet 16K	£499
Pet 32K	£630

Ext. cassette decks (+ counter) £55
PET Friction Feed printers £350

AVAILABLE FROM STOCK

Printers	Disc Drives	Sundries
PET 3023	PET 3040	Tool kits: library cases
PET 3022	Compu 400K	Disks: C12 cassettes
Centronic 779	Compu 800K	Paper (roll & tractor feed)
Spinwriter	Interfaces	Labels: Dust covers

TRY US!
YOU WILL NOT BE
DISAPPOINTED

WE ARE NOW TAKING ORDERS FOR THE NEW 8000 SERIES CBM'S

8032 (80 col. screen: new keyboard)	£895
8050 (974 K/Bytes: new DOS)	£895

(Sae for details: Demonstrations NOW)



COMPLETE SYSTEMS
FROM £1700!!

THE ESTIMATES WE SUPPLY & INSTALL ARE COMPLETE
ESTIMATES GIVEN FREE WITH NO HIDDEN EXTRAS:
FULL BACK-UP: GUARANTEED EXPERTISE.

PRICES DO NOT INCLUDE VAT

SOFTWARE

As well as a full range of Petsoft and Commodore Software, we have some highly reliable "Home-Brewed" programs available.

STOCK CONTROL & INVOICING £60
(Handles up to 500 items - 32k) (80 on 16K). Stock depleted on invoicing, search etc. Cassette, disk (& colour print option).

STOCK TAKING £230
Basic program which can be tailored to suit most trades. Beautiful print-out!

OUTSIDE SERVICES (For Mini-Cabs etc.) £220
Weekly or monthly invoices - cheque writing facility - optional deductions. (16 or 32K + disk + printer).

MACHINE HIRE £420
Covers hiring of machines, customers, due & overdue. Hiring Charges: Machine History: Printouts for all Sections. Ideal for Typewriter & Pland Hire Firms.

CASH BOOK £90
Enter daily/weekly amounts - printout and totals, weekly monthly analysis, totals and balances.

Sae for free software booklet

SPECIALISTS IN:

Commodore Business Programs: Superpay;
Bristol Trader, Item & Monitor: Word Processing

SPECIALISED SOFTWARE APPLICATIONS
UNDERTAKEN. RING FOR DETAILS

PERSONAL SHOPPERS WELCOME
Phone & Mail Orders accepted.

ALL GOODS SENT SAME DAY WHEREVER POSSIBLE
LARGE S.A.E. FOR LISTS ETC.



Personal Computer

World SUBSCRIPTIONS

Just over 2 years ago PCW became the first magazine in Europe to deal exclusively with the home and business use of Personal Computers. It has been an unqualified success. The current subscription list stands at well over 3,000, with a staggering 70%

renewal rate! PCW reader loyalty is already a by-word in the publishing business. We aim to keep it that way. So if you are having difficulty in obtaining PCW at your newsagent, why not take out a subscription and have the magazine mailed to you direct?

UK Subscriptions: £8.00
USA Subscriptions: £22.00 (airmail)
Europe Subscriptions: £13.00 (airmail)
Elsewhere: £25.00 (airmail)

I enclose cheque/P.O. for £ _____ made payable to
Sportscene Publishers Ltd.
Send coupon to PCW (Subscriptions), 14 Rathbone
Place, London W1P 1DE. Allow at least 14 days for
processing.

Please send me the next 12 issues of PCW

NAME _____

ADDRESS _____

(Block capitals please)

typing keyboard became a musical keyboard. Hitting a key produced both a sound and a note on the screen. Although not a sophisticated piece of software (all notes were crochets) it did demonstrate some of the potential of the DAI's sound capabilities. The bottom row of keys became a piano's white keys while the next row up contained the black keys. Pressing a key in the next row produced a chord while the top row was used to alter the quality of the notes produced. By pressing a key in the top row the volume could be increased or decreased or the duration of the notes hit could be altered from normal to either staccato or an organ-like (filled with overtones) legato.

The sound can be generated from either Basic or machine code. In Basic the commands are:

A = FREQ(N) — sets A to a number that can be sent to a sound generator channel to result in an N hertz rate.

ENVELOPE <ENV> [<V>, <T>;]
 ENV selects which of two envelopes is being defined, V is a volume level (0 to 16), and T is a time length in the range 1 to 254 (where each unit lasts 3.2 milliseconds). Anything in [] brackets is optional and can be repeated any number of times.

NOISE ENV VOL
 NOISE OFF

These commands turn the random noise generator either on or off.

SOUND <CHAN> <ENV> <VOL>
 <TG> FREQ <PERIOD> SOUND
 <CHAN> OFF
 SOUND OFF

CHAN selects programmable oscillator 0,1, or 2; ENV selects which of two previously defined envelopes should be used; VOL selects a volume for a sound which is multiplied by the volumes in the ENVELOPE command; TG is an expression in the range 0 to 3 which selects tremolo/no tremolo and glissando/no glissando; PERIOD sets the period of the required sound in units of 1/2 microseconds.

Documentation

The documentation comprises two books — a general introductory text designed for someone with no knowledge of computers and one entitled *Personal Computer Manual* which is more technical.

The introductory text is not a manual: it starts from unpacking the computer and introduces both hardware and software ideas slowly by solving the problem of getting colours on the screen. Solutions are reached but each solution except the last throws up more difficult problems to be tackled. This book takes quite a good approach for teaching a beginner about computing in general and the DAI in particular. Unfortunately, its tone is so patronising as to easily put off any novice.

Fortunately the manual is free of the textbook's tone. It's quite comprehensive about both hardware and software and even includes 40 pages of programs. Although there are ambiguous sections, overall it's quite clear and most features have limited examples. The manual is

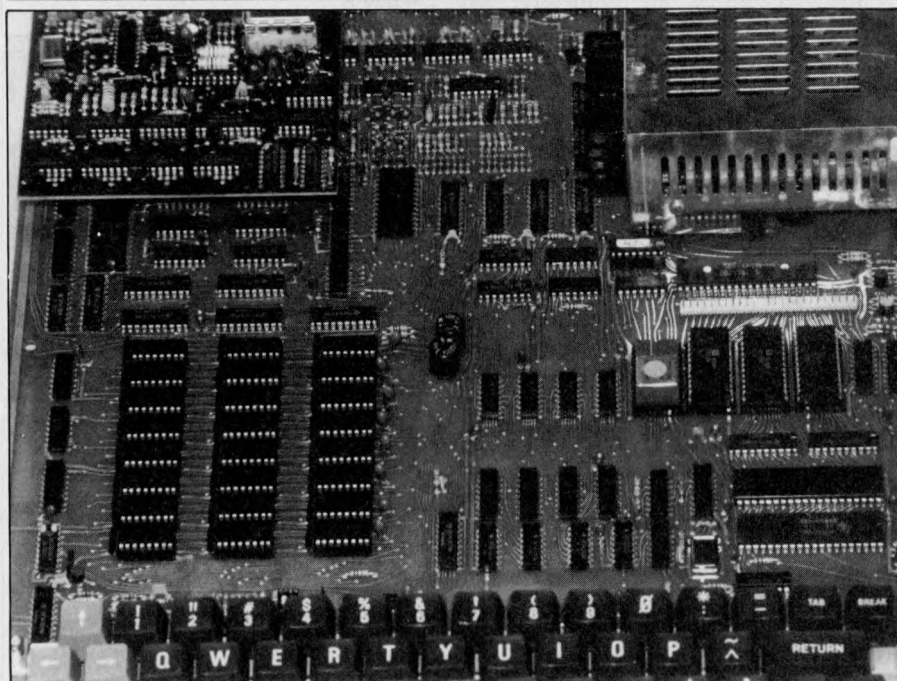

The complete DAI system (above) and (below) the machine's insides.

paginated and has an excellent table of contents (eg 'How to get Restarted if Accidental Reset During Program Keying or at End of Program'). The hardware sections contained justifications for design features (such as the graphics resolution) which make for interesting reading.

Expansion

The minimum system is an 8k black and white version with low and medium resolution graphics. This can be expanded to a system like the review machine; and with 48k and full colour graphics the single board is fully populated. There's a DCE bus connector which can be used to attach a DCE backplane and any number of DCE Eurocards, which include EPROM, RAM and a wide range of I/O cards.

Potential

In common with the other European machines that I have reviewed, the DAI personal computer has rather nice system software but no applications packages. At this stage the DAI micro is only interesting to programmers or people who want to learn to program.

As the DAI personal computer has a Data Applications DCE bus, it can be connected to those cards. Using an expanded system should enable the development of process control systems for example.

As a machine for educational purposes the DAI has advantages and disadvantages. For teaching Basic it has many fine features: the Basic is large (although missing ELSE) and the graphics and sound capabilities are not only impressive but are accessed via sensible Basic commands. The machine is light and portable but unfortunately

the box is too fragile for school use. Being limited to Basic makes this machine unsuitable for teaching programming at a higher level, yet it may have a place in higher education as a machine for monitoring and controlling experiments.

Both the sound and graphics capabilities could be put to good use in games programs, assuming that it's acceptable to tie up the TV and stereo for extended periods of time. With DAI real world cards a user should be able to wire up a home so that everything may be remotely controlled!

Assuming price is not a deterrent, the major disadvantage of the DAI machine as a home computer must be its lack (both current and proposed) of home application packages. I think if I bought a computer to play with I'd want arcade games and personal finance packages at least.

Conclusion

I found the DAI personal computer an entertaining machine to play with. With its range of add-on boards, its potential as a computer for process control is good. Both its colour graphics and sound capabilities are impressive and would make an interesting proposition

for someone who wanted to produce and record computer music.

I'm curious whether a machine with rather limited software will be able to compete with either the Apple or the current offerings from Texas and the American game manufacturers — such as the Atari machines reviewed elsewhere in this issue.

Prices

48k — £795, 32k — £725, 12k — £595, Hardware Maths Module £149. All prices are exclusive of VAT and delivery charges.

Machine Language Utility Commands

LOOK
DISPLAY
GO
FILL
SUBSTITUTE
MOVE
EXAMINE
EXAMINE REGISTERS
VECTOR EXAMINE
VECTOR EXAMINE BYTES
READ
WRITE

Memory map

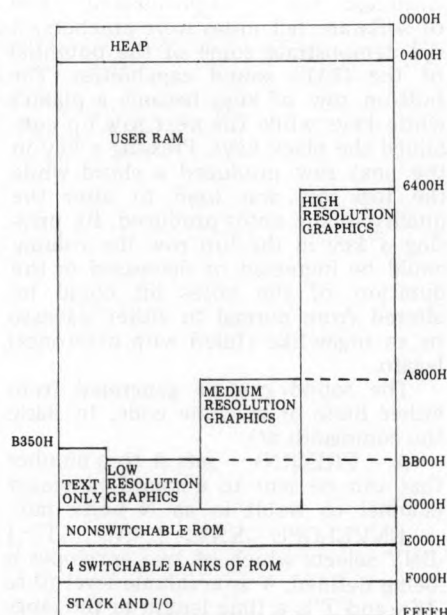

Technical Data

CPU: 8080A, 2 MHz
Memory: 48k dynamic RAM, 24k ROM, 262 bytes static RAM
Keyboard: 56 keys
Screen: Any colour TV, 60 x 24 char., 260 x 352 pixels
Cassette: Any audio cassette, 600 baud
Disk Drives: N/A
Peripherals: N/A
Bus: DCE-bus
Ports: Input: 2 paddles, RS232; output: 2 stereo channels, RS232
System software: Machine language utilities
Languages: Basic, 8080 machine code

Benchmark Timings (in seconds)

1	0.93
2	4.78
3	10.05
4	9.78
5	11.20
6	18.12
7	30.11
8	2.14

At a glance

FIRST IMPRESSIONS

Looks ****
Set up ***
Ease of use ****

HIGH LEVEL LANGUAGES

Basic ****
Fortran N/A
Cobol N/A
Pascal N/A
System Software N/A

PACKAGES

Business *
Education *
Home *

PERFORMANCE

Processor **
Cassette ***
Disk drives N/A
Peripherals N/A

EXPANSION

Memory ***
Cassette ***
Disk drives **
Bus **

COMPATIBILITY

Hardware *
Software **

DOCUMENTATION

VALUE FOR MONEY

***** excellent
**** very good
*** good
** fair
* poor

Basic reserved words

EDIT	SAVEA	ASN
IMP	CONT	ATN
LIST	REM	CHR\$
NEW	STEP	COS
RUN	TRON	EXP
END	TROFF	FRAC
FOR . . NEXT	CLEAR	HEX\$
GOSUB	DIM	INT
GOTO	FRE	LEFT \$
IF . . THEN	LET	LEN
ON . . GOSUB	VARPTR	LOG
ON . . GOTO	MODE	LOGT
RETURN	COLORG	MID\$
STOP	COLORT	PI
WAIT	DOT	RIGHT\$
CALLM	DRAW	RND
INP	FILL	SGN
OUT	XMAX	SIN
PDL	YMAX	SPC
PEEK	SCRN	SQR
POKE	CURSOR	STR\$
UT	CURX	TAB
DATA	CURY	TAN
GETC	SOUND	VAL
INPUT	ENVELOPE	IOR
PRINT	NOISE	IAND
READ	FREQ	IXOR
RESTORE	TALK	INOT
CHECK	ABS	SHL
LOAD	ACOS	SHR
LOADA	ALOG	AND
SAVE	ASC	OR

GATEWAYS TO LOGIC

Derrick Daines continues his unique series on teaching others the basics of microcomputing.

CHAPTER 4: BINARY ARITHMETIC

At the most fundamental level, all computers, silicon chips and allied gadgetry work with binary arithmetic. Tell most people this and they throw up their hands in horror: "I don't know anything about binary!" they exclaim and give up there and then. Of course they know about binary — far more than they realise. How many hands have they got? How many legs, arms, eyes, ears, nostrils and knee caps? In every case the answer is two, unless accident or surgery has deprived them. If you know that two halfpennies make a penny, then you know almost everything that there is to know about binary.

Thinking about it, binary is the simplest and most natural kind of arithmetic there is. Of course, we are more familiar with decimal (counting in tens), but only through many years of practice. In fact we count in tens simply through an accident of nature — we all have ten digits on our two hands. Had we all been born without a little finger, we'd have counted in eights — which, by the

To Weigh	WEIGHTS AVAILABLE				
	16oz	8oz	4oz	2oz	1oz
1oz					*
2oz				*	*
3oz				*	*
4oz			*		*
5oz			*		*
6oz			*	*	*
7oz			*	*	*
8oz		*			*
9oz		*			*
10oz		*		*	*
11oz		*		*	*
12oz		*	*		*
13oz		*	*		*
14oz		*	*	*	*
15oz		*	*	*	*
16oz	*				*
17oz	*				*
18oz	*			*	*
19oz	*			*	*
20oz	*		*		*
21oz	*		*		*
22oz	*		*	*	*
23oz	*		*	*	*
24oz	*	*			*
25oz	*	*			*
26oz	*	*		*	*
27oz	*	*		*	*
28oz	*	*	*		*
29oz	*	*	*		*
30oz	*	*	*	*	*
31oz	*	*	*	*	*

Table 1 Binary weighing

00001
00010
00011
00100
00101
00110
00111
01000
01001
01010
01011
01100
01101
01110
01111
10000
10001
10010
10011
10100
10101
10110
10111
11000
11001
11010
11011
11100
11101
11110
11111

Table 2
Binary notation

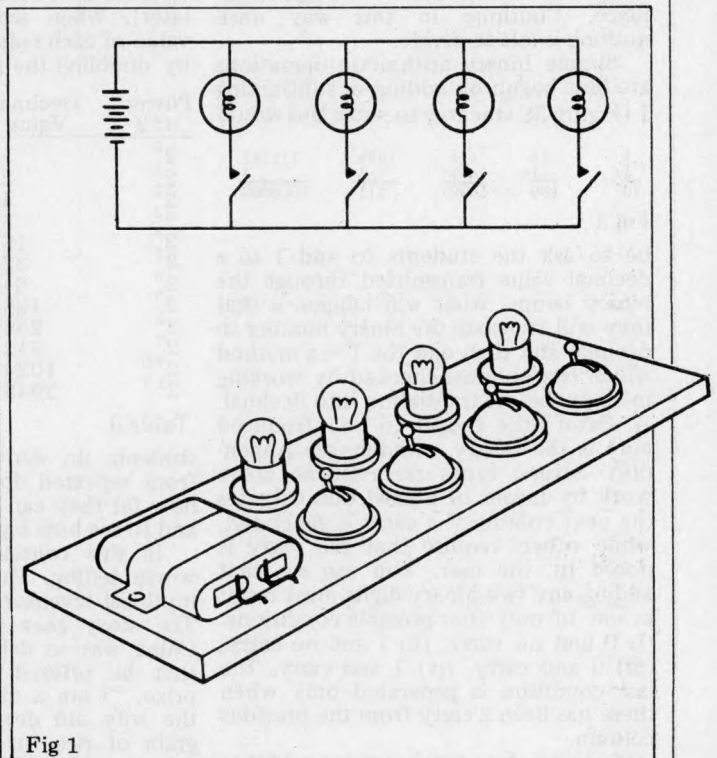

Fig 1

way, is more useful than decimal.

For evidence that binary is better, I refer the reader back to a previous chapter. Something possesses an attribute, or it does not. That dress contains silk or it does not. Only two conditions prevail — yes or no, on or off, true or false; halfpenny or no halfpenny.

When introducing binary for the first time, a good plan is to present the following problem: a certain grocer had a set of scales but a limited set of weights — 1 ounce, 2 ounces, 4 ounces, 8 ounces ($\frac{1}{2}$ lb), and 16 ounces (1 lb). Substitute grams if the spirit moves you. The question you ask is, how can he weigh all weights up to 31 ounces? If he wishes to weigh out 1 ounce then of course he uses the one ounce weight; if two ounces, the two ounce weight, while if he want to weigh out 3 ounces, then he must use both the one and the two ounce weights (Table 1). Give the students the first five or six examples and then let them finish the table on their own.

If a new table is drawn up from the first, putting the figure 1 in place of the cross and inserting 0s in all the blank spaces, we have the binary representation of the first 31 numbers — or 32, if you count zero as the first (Table 2).

Any handiman can wire up a few lamps and switches as in Figure 1 and although the battery drain can at times be quite heavy, I personally find it far safer than a mains-powered board — particularly for school use. Many useful and happy hours can be passed using this tool, transmitting decimal number values in binary form. To begin with, have each lamp labelled with its decimal value but as the students get better you should remove the labels. In school, I ask various children to take over transmitting a decimal number; the class has to speak up if a mistake is made.

Binary to decimal

Starting from the right, jot down the value of each column. Each column has

of course twice the value of the one to its right. If a 1 is present, add it in; if a 0, ignore it. The total value is the decimal count.

Decimal to binary

Divide the decimal number by 2. If there is a remainder, write 1 in the least-significant place of the binary equivalent (Figure 2). If there is no remainder

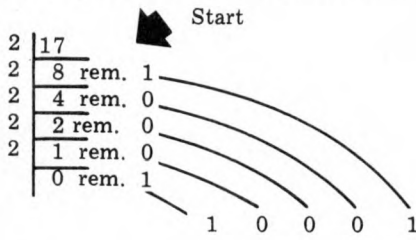

$$\therefore 17_{10} = 10001_2$$

Fig 2

write 0. Divide by 2 again, putting any remainder in the next least-significant place. Continue in this way until nothing is left to divide.

Simple binary arithmetic operations are best begun by adding or subtracting 1 (Figure 3). One way to show this would

$$\begin{array}{r} 1 \\ \hline 10 \\ \hline 1+ \end{array} \quad \begin{array}{r} 11 \\ \hline 100 \\ \hline 1+ \end{array} \quad \begin{array}{r} 111 \\ \hline 1010 \\ \hline 1+ \end{array} \quad \begin{array}{r} 1000 \\ \hline 111 \\ \hline 1- \end{array} \quad \begin{array}{r} 111111 \\ \hline 1000000 \\ \hline 1+ \end{array}$$

Fig 3

be to ask the students to add 1 to a decimal value transmitted through the binary lamps. What will happen is that they will translate the binary number to decimal and then add the 1 — a method which can be cross-checked by working in binary before translation into decimal. A useful little gadget to be introduced here is the binary counter (see Appendix). Several types are available; some work by means of a pawl that actuates the next column if a carry is generated, while others require that the carry is noted by the user. You can see that adding any two binary digits must result in one of only four possible conditions: (i) 0 and no carry, (ii) 1 and no carry, (iii) 0 and carry, (iv) 1 and carry. The last condition is generated only when there has been a carry from the previous column.

Surprisingly, simple binary addition helps people to understand decimal addition a little better. The reason for the carry is better understood, particularly in relation to the base of the arithmetic — ie, 10 or 2. Once this point is grasped, the student is beginning that transition from hard slog with numbers to looking for and utilising their underlying beauty and pattern. Obviously from a classroom point of view this transition is of vital importance if a student is ever to understand thoroughly, let alone enjoy, mathematics. I find one road into this enjoyment is to insist on working in binary and encourage the chortles of delight when carry after carry is generated.

Adding three or more numbers in binary format requires care and is not really recommended. For one thing, there's a tendency to err and for another it's not necessary. No computer or microprocessor adds three numbers at once — they work on a series of operations on two binary numbers at a time

and there is no reason why this should not be done by us as well.

Neither is there any special virtue in adding or subtracting enormously long binary numbers. It may be attempted of course and students frequently get pleasure from such strenuous (and useless) activity; in general it's best to confine efforts to six or eight digits. Nor do I advocate binary multiplication or division. Again, though quite possible, for the same reason they're not necessary. Computers complete these operations by multiple additions or subtractions — either of the mantissa or the exponent or both — points that can well be made to the students. It's a good exercise to set a problem such as 3×4 to be worked out by multiple addition in binary before final translation of the product into decimal.

I find few children under 12 to be very familiar or comfortable with the values of decimal digits above 1000. They start off very confidently — units, tens, hundreds, thousands, er — millions? (Million is a much-banded word — see later). When working in binary, the value of each column is easily calculated by doubling the previous (Table 3) and

Power of 2	Decimal Value	Power of 2	Decimal Value
2^0	1	2^{12}	4096
2^1	2	2^{13}	8192
2^2	4	2^{14}	16384
2^3	8	2^{15}	32768
2^4	16	2^{16}	65536
2^5	32	2^{17}	131072
2^6	64	2^{18}	262144
2^7	128	2^{19}	524288
2^8	256	2^{20}	1048576
2^9	512	2^{21}	2097152
2^{10}	1024	2^{22}	4194304
2^{11}	2048	2^{23}	8388608

Table 3

students do derive enormous pleasure from repeated doubling — both to see how far they can progress without error and to see how big the numbers get.

In this context, several stories are worth telling. The oldest concerns the mythical inventor of the game of chess. The story goes that the Emperor of China was so delighted with the game that he offered the wise old man a prize. "I am a modest man," wheezed the wily old devil, "Just give me one grain of rice for the first square, two for the second, four for the third, then eight for the fourth and so on until all the board has been dealt with." Since there are 64 squares on a chess board, had the Emperor been able to

comply with the request, he would have needed the entire world production of rice since the dawn of time!

Tear a sheet of newspaper across, thus doubling its thickness, then tear it again. Continue in this way as far as you can ... you'll be surprised how few 'doublings' you can make. If it were possible for you to carry out just a few more, the wad of paper would be so thick that you'd be able to stand on it and reach the moon.

Tower of Hanoi

Binary arithmetic crops up in the most unlikely places and this ancient game or puzzle is one of them. The equipment is easy — a few books of different sizes will do, or a child's set of nesting bricks; a de luxe model can be made from a set of plywood discs of increasing size and three nails in a block of wood (Figure 4).

The problem is simply stated. Moving one disc at a time, the object is to move the stack to one of the other pegs, with the sole proviso that at no time is a disc to be stacked above one smaller. Six or eight discs are enough.

The first few moves can be demonstrated — disc 1 to spike B, 2 to C, 1 to C, 3 to B, 1 to A, 2 to B, 1 to B, 4 to C. After that you're on your own! People can play this game for hours, especially if there's a prize going on for the one who does it in the least number of moves. I guarantee that unless the user is in on the secret, he or she will expend many unnecessary moves. It's reasonably easy to see what to do when dealing with the smallest discs (thinking in pictures again!), but when it comes to dealing with the larger discs, that's where the problems start.

The clue to the solution is to realise that it's binary in nature. As with the grocer and his weights, so it is with the discs. What is the pattern? Well, the grocer utilised his smallest weight every alternate weighing and in the current problem the smallest disc is moved every alternate go. Easy though it may be to spot this, it's not so obvious that the smallest disc has a pattern of movement, from spike A to B and C; A, B, C, A, B, C, ... it never varies. If these two simple rules are followed then the smallest number of moves will result; that's

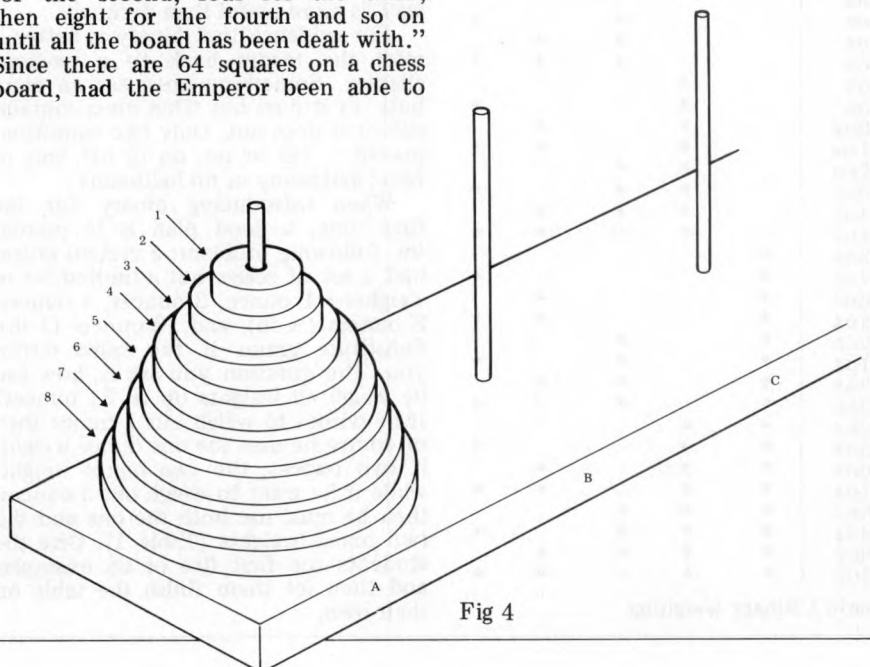

Fig 4

RED	Y'W	BLUE	SQ	RecT	CIRC	TRI	LGE	THK	
0	0	0	0	0	0	0	0	0	— no block applicable
0	0	1	0	0	0	1	0	0	Note that last three digits are used to count 0 — 3 in binary.
0	0	1	0	0	0	1	0	1	
0	0	1	0	0	0	1	1	0	
0	0	1	0	0	1	0	0	0	Repeated for circle
0	0	1	0	0	1	0	1	1	
0	0	1	0	0	1	0	0	1	
0	0	1	0	1	0	0	0	0	
0	0	1	0	1	0	0	1	0	
0	0	1	0	1	0	0	0	1	
0	0	1	1	0	0	0	0	0	
0	0	1	1	0	0	0	1	1	
0	0	1	1	0	0	0	1	0	
0	0	1	1	0	0	1	1	1	— completing the blues
0	1	0	0	0	0	1	0	0	
0	1	0	0	0	0	1	0	1	

— and so on for all the yellows and finally the reds.

Table 4

because, of the two spikes other than that occupied by the smallest disc, there is only one legal move. If the game is interrupted, it's only necessary to remember whether or not the smallest disc was moved last time.

To find the minimum number of moves necessary we work from the top down. If there was only one disc of course there would only be one move; two discs — three moves; three discs — seven moves; four discs — fifteen moves. Spot the connection? The number of moves needed is the binary series of Table 3, less 1. If you follow the table, you will see that 63 moves are needed for six discs, while for eight discs the figure rises to 255 moves. Masochists might like to make themselves a set of ten discs — and be happy in the knowledge that they will require a minimum of 1,023 moves.

The story, you might like to hear, is that in the ancient city of Hanoi there is a team of Buddhist monks dedicated night and day to the task of moving one disc a minute and that when they've finished the puzzle, the world will end. Since there are 32 discs in their set, should we worry? Not on your life! Apart from the fact that I secretly doubt a Communist regime tolerating such a useless pursuit, with that number of discs and at that steady speed of operation, the puzzle will take over 8000 years to complete! Incidentally, the fastest computer in operation, moving a million discs a second, would take over 3 days to complete the job.

Binary coding

The great advantage of binary coding — and the reason why computers are good at keeping track of things as well as crunching numbers — is that anything can be coded in binary form. Think back to those logic blocks. A piece is either thick, or it is not (and if, for instance, it is *not* thick, we have no need to enquire whether it is thin.) The possession of such an attribute can be assigned the binary number 1, while of course absence of the attribute is indicated by 0. This provides us with a very powerful tool for computer classification.

But of course you'll soon be asked the question, "If we have 1 for red, 0 can't be blue, since it could be yellow!" Quite right. In circumstances where one attribute does not necessarily exclude

another, there have to be separate binary bits for each attribute. In Table 4 I give one method of binary coding for a set of logic blocks. There are of course several acceptable methods, depending upon the order in which the attributes are considered.

Tear up a mail-order catalogue and distribute the pages. Each student takes one type of product — ladies' fashions, watches, bicycles — and devises a simple series of questions, answerable by yes or no that will differentiate one product from the next within the category in which he is dealing. The set of questions is then applied to each product in turn, yielding a multi-digit binary number that becomes the code for each product. If two products turn out to have the same code, then another question must be devised to differentiate them. In order to eliminate ambiguity absolutely, the choice of questions requires considerable thought; the number of questions asked has also to be kept to the very minimum. With minor variations, this is essentially the method used in mail-order houses, a point which should be made to the student. Ask questions like, "If Mrs Smith writes 7F on her order form instead of 7E, what product will she get?" The answer to this question will do much to explain the irritation of modern computerised shopping!

For display purposes, it's worth cutting out some attractive pictures and mounting them on card to illustrate binary coding. (See a previous chapter for a method of turning binary into hexadecimal.)

Exactly the same method will yield a pattern of 1s and 0s for use in a binary selection box. Both boxes and suitable cards are available commercially. When purchased, the cards are of course blank but with a series of holes punched along the top and bottom edges. A hole represents a binary 0 and to change it into a binary 1, the user simply turns the hole into a slot with two quick snips of the scissors (Figure 5). Cut-out pictures from the

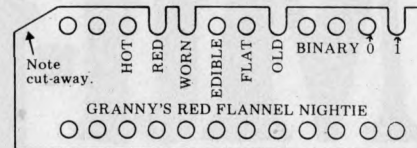

Fig 5

mail order catalogue are stuck onto the faces of the cards and of course the questions must be matched, hole for hole. I recommend that, to avoid confusion, the bottom row of holes be ignored for now; later it will be possible to use them with a different type of product, pictured on the back.

Having assembled a collection of pictures coded in this way, the student may then put the stack of cards in the box for easy selection with the aid of a knitting needle (Figure 6). For example, a range of dresses may be sorted to see which have a vee neckline; put the needle through the vee neck slot and shake. Since the box has no bottom, those cards bearing a yes answer — binary 1 — will not be held by the needle and will fall through.

Perhaps a more exciting method is to imagine a widely disparate selection of objects such as the Sahara Desert, the sea, a fire engine, a two-ton Xmas pudding, a Chinese penny and so on, including a few fun objects like granny's red flannel nightie, a bloodstained concrete slab or a pair of prehistoric knickers. This can be coded as before, posing such questions as, "Are you red?", "Are you near?", "Are you hot?" and so on. Note, by the way, that the cards all

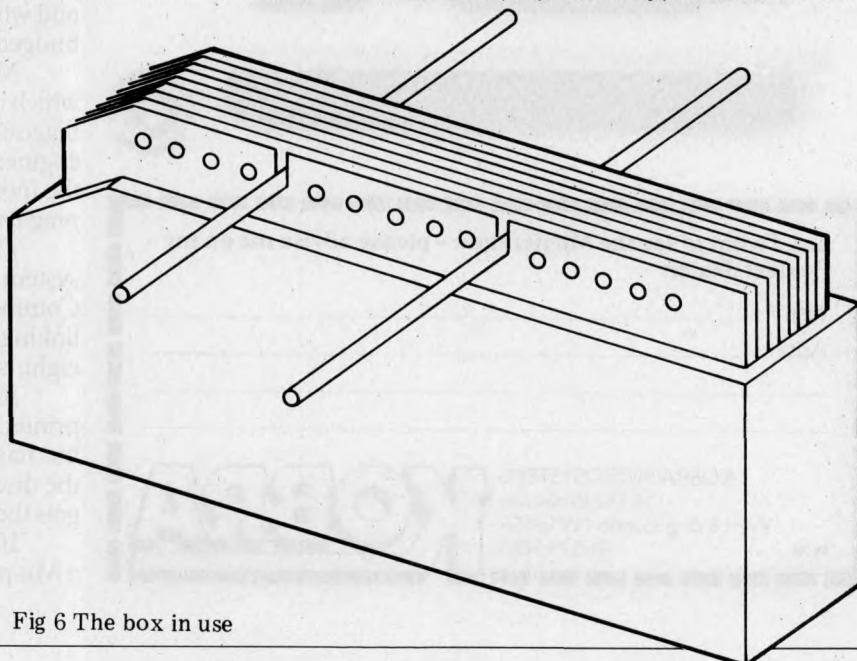

Fig 6 The box in use

It's The Mu-pet Show!



Multi-User PET (Mu-pet) links 3-8 PET computers to one Commodore disc drive and a printer.

Mu-pet is very good news indeed for those PET users wanting a multi-user computer system and who, up until now, have run up against a budgetary brick wall.

Mu-pet delivers the goods at very low cost... which is one of the reasons it's become the world's biggest selling multi-PET system. Precisely engineered in the U.S. and Canada, Mu-pet makes the most of PET computers - *without the need for program changes.*

£595 is all it costs for a standard Mu-pet system that links three PET computers to a single Commodore disc drive and a printer. The cost of linking more PET computers, up to a maximum of eight, is £125 for each addition.

All machines have access to the disc drive and printer. The hardware which all runs via the IEEE bus has been so well designed that each PET thinks the disc is its own, and priority depends on who gets there first.

If you've three or more PETS, then you need a Mu-pet to make the most of them.



Yes, I want to see the Mu-pet show - please advise me on my nearest dealer.

Name _____

Address _____

KOBRA MICROSYSTEMS
14 The Broadway
West Ealing London W13 0SR
01-579 5845

PCW

KOBRA

come with one corner snipped off; this is simply to ensure proper alignment within the box....all cut corners must line up.

The method of extracting all cards carrying an object with a given attribute has been described already — we put a needle through the hole and shake. Those cards with the attribute drop through and, conversely, those without it stay in the box, suspended by the needle. But operations may easily be combined. If for example we wish to find all objects that are RED AND OLD AND WORN, we put needles through RED, OLD and WORN simultaneously. The OR operation is slightly different. If we want objects that are RED OR OLD OR WORN, three operations are needed to shake out first those that are red, then those that are old and lastly those that are worn.

Combinations can get quite complicated. If, let us say, we're asked for objects that are RED AND OLD OR (RED AND WORN), or RED AND (OLD OR RED) AND WORN? Read that again — they really are different! Let's suppose that what is required is (RED AND OLD) OR (RED AND WORN). Two operations are needed; first a shake with needles through RED and OLD, then a shake with needles through RED and WORN.

The NOT attribute is useful too. Suppose we want articles that are OLD AND RED AND NOT WORN then again two operations are necessary. The first shakes out those that are OLD AND RED by means of needles through both at once. Now, discard those cards that remain in the box and put in their place the OLD AND RED. Insert the needle again, this time, through WORN. Those that fall out are of course WORN and therefore not wanted.

We may summarise the operations as follows:

- (i) Positive attributes drop through
- (ii) Negative attributes remain in the box
- (iii) AND operation — two or more needles at once
- (iv) OR operation — two or more needles in different operations

Sooner or later students will notice that the questions are ambiguous. This will happen when the result of the operation produces an unexpected result. "That's not near!" they will protest, and they'll be right. Just what do we mean by near, anyway? How hot is hot? We could perhaps stick to unequivocal questions and decisions when devising the cards — as for example the vee neck question — but it's better to deliberately allow ambiguity to creep in so that the teaching point is made a little more forcibly. Now is the time to start introducing the idea of standards and precision.

Make up a set of cards so that the binary numbers 0—11111 are represented (0—63). It's easy to select any particular number in one or more operations. At first it may seem possible for any number to be selected in one operation, but a little thought will show that this is not true. Suppose for example we wish to select binary 1. To do that we put a needle through the first position; half the cards will drop out and will require further operations

upon them. Several more operations are needed because the 1 required is (NOT 32) AND (NOT 16) AND.... etc. to (NOT 2). It follows therefore that we put needles through 32, 16, 8, 4 and 2 in turn. Each shake will drop out some cards that have that attribute, leaving behind the one that we want. This is a rather important concept and one I shall return to when dealing with computer gating.

Many of the computers that check batches of products are programmed to accept a range of tolerances and a good type of question to pose with binary selection cards is to ask students for a series of operations that will select all cards between, say, 8 and 12 — a question that will cause some considerable head scratching.

The old parlour game of Twenty Questions is a good lead up to binary coding of products, since of course acceptable questions must be answerable by yes or no.

A practical use of the binary selection box is a school filing system. Such systems were widely used commercially before the advent of the computer. One card could be made out for each pupil, with questions relating to birth date, colour of eyes and hair, games played, academic achievements, languages studied and anything else considered relevant. Immediately, a multiplicity of logistic questions are solvable in moments. "How many red-haired children have we got that ride bikes? Hang on a minute." A steel rod through the hundreds of cards at the spot marked RED HAIR, another through the spot marked BICYCLE, a shake, and the answer is there in the number of cards that drop out. Compare that with the time taken by the usual method of going to each class in turn and counting heads after explaining what is wanted.

I find that students will happily and easily apply the method to their own class grouping and will soon spot the weakness in the system, that of addressing. If the school sits in the middle of an estate for example, how do we set about dealing with the question, "How many children live in Farnsfield Road?" We could have a binary bit for Farnsfield Road, but that would also mean that we would need a binary bit for every other road, street, avenue, lane and close. Clearly, we would soon run out of available space on the cards. The system is inefficient and luckily it is also unnecessary.

Before I go on to consider the solution, however, I would recommend a simple game. One player announces, "I am thinking of a number between 0 and 9. What is the number? You have three guesses." To each guess the reply is given, "Too high," "Too low," or "correct."

How would you tackle the problem? One way would be to hop about wildly at random, hoping to hit on the answer. This is the most inefficient method, although it might result in a stroke of luck. Another way would be to start at 0, then 1, then 2 — by then you would have run out of guesses. This is like having one binary bit for every street on the estate. The best method — and one that results in the correct answer every time — is to *divide the margin of error*. At the start, one knows only that the number sought

lies between 0 and 9, so we divide the error and guess 5. Suppose that's low. We now know that the number lies between 6 and 9, so again we divide the margin of error, guessing 7. The next time we are certain to get the answer right, save solely in the extreme case of 9, which will require one more guess (Figure 7). This game,

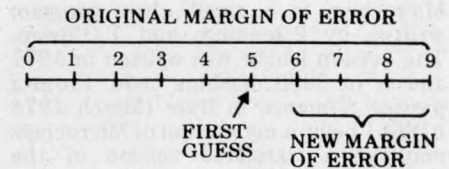

Fig 7

by the way, lends itself admirably to loading as a program in even the simplest computer.

And it gives us the clue we need to tackle the addressing problem; we must divide the margin of error. The first question to ask is if the chosen address is North or South of a line drawn through the school; then if it is East or West of a similar line at right angles to the first. Hence in two binary bits we are able to describe four areas. By now I expect you're beginning to see the start of a Carroll mapping.

We cannot move on from the binary selection box without mention of the sorting sequence. Shuffle the pack of coded number cards and place them in the box. Now the question is, what is the minimum number of moves needed to put them all back into correct order? Those who have studied the binary sequence will know that the number is surprisingly small; with 64 cards, only 6 moves are needed. Starting with the least-significant bit, insert one needle and shake. All the cards that drop out are retained in their original order, but placed carefully behind those that remained in the box. Repeat, using a needle in the next least-significant bit, and the next, and the next. With this done up to the sixth bit, all cards will be in the correct binary-coded order. I'll leave the reader to sort out why this is so. Children are of course very intrigued by the process — as they are by everything connected with the binary selection box.

The physical operations performed by pushing needles through the holes in cards has its close analogy in the way that the computer searches through data. As we'll see later, all data consists of binary digits, so that if the computer is searching for a bank account number, fingerprint match or what-have-you, deep in its electronic heart it carries an image in binary of whatever it is that it's looking for and it compares that image, bit by binary bit, with all relevant store contents. It's only the terrific speed of operation that tends to conceal from us the painstaking way in which it searches.

The binary selection box is therefore an excellent teaching aid at several levels, having much to offer for the teaching and understanding of binary arithmetic, the organisation of data and the understanding of logic; it's also a handy model of computer operation.

Suppliers

Invicta Plastics Ltd., Oadby, Leicester.
Supply Binary Counters

PARKINSON'S PEP-UP

Is your microcomputer sluggish? Do your programs stroll instead of RUN? Here's a tonic to get things moving more quickly, from David Parkinson.

Microchess is a small chess program written by P Jennings and T O'Brien. The version I have was written in 1977 and is in 8080 machine code. From a passing reference in *Byte* (March 1978 p166) I believe my version of Microchess may be a translated version of the program originally written for the KIM1 in 1976. The current versions for Apple, PET, TRS-80, etc may well differ in internal structure so all references to Microchess here refer to the early 8080 version.

The program offers three levels of play and runs in about 3.5k of RAM. I wanted to transfer the program to an 8080 system which had only 1k of RAM but sockets for 8k of ROM. Having reverse assembled it I altered and moved certain sections of the code in order to produce a 'ROMable' version. While doing this it became apparent that once the program had been written and debugged no real attempt had been made to tidy up the remaining code. Among other things I found a conditional jump around an unconditional call and several conditional jumps that terminated in an unconditional return. It seemed it might be possible to gain a noticeable decrease in the program's response time by removing redundant coding such as this.

Running at the 'normal' speed setting, Microchess takes about 90 seconds (Z80 at 2.5 MHz) to decide on its move. During this period it is going through a repetitive process of generating a move, saving the board position, moving a piece, evaluating the new position, exchanging sides, restoring the previous position and trying a new one. All the routines had at least one small (or not so small) possible modification but which were worthwhile? Saving a single 10-cycle instruction from a routine that was only executed 100 times would not be noticeable, but if it were repeated 1,000,000 or more times it would. The evaluation routine could well be one worth attention (cf David Levy, PCW May 1979).

The way to find the critical routines is by measurement rather than by inspired guesswork. By regularly sampling the microprocessor's program counter, a histogram or similar record can be built up showing the level of activity in various areas of the executing program, the areas of highest activity being the ones offering the possibility of the best return for any recoding effort.

Luckily we already possess the tool necessary to do this — the processor itself — so there's no need to beg borrow or steal expensive and complex analysers to connect to the address bus. The sampling can be done by the processor in response to a request through its interrupt system.

The interrupt system

The way to use this approach depends on your particular microprocessor and

its hardware configuration. In my system the interrupt system is unused and so it was a simple matter to connect the circuit shown in Figure 1 to the system. Those whose interrupt systems are already in use should be able to find a suitable way to connect a similar circuit to their system, or be able to generate a regular interrupt with existing hardware such as a counter-timer.

A full description of interrupts and interrupt systems will not be discussed here but for those unfamiliar with them here's an outline of the Z80's (mode 1) interrupt behaviour: at the end of each instruction cycle (if the interrupt system is enabled) the Z80 samples the state of the INT line. If the line is high the Z80 continues with the program it is executing. If the line is low the Z80 does not fetch the next instruction but outputs an acknowledge signal by taking MI and IORQ low simultaneously and then executes an 'RST 56' instruction. In other words, taking the INT pin low automatically causes a CALL to address 38H provided the interrupt system is enabled.

Why interrupt?

The interrupt effectively inserts a CALL instruction into the program flow. As a result of this CALL the current content of the program counter is pushed onto the stack; so, to discover which section of the program was executing, all the interrupt routine has to do is to

examine the return address on the stack. By arranging for the interrupts to occur on a regular basis the interrupt routine can build up a table which shows where it found the program executing. The more often a section of code is executed, the more likely it is to be 'caught' by an interrupt, and, if we take a large enough sample, we should have a representative picture of the activity within the program.

But beware! For this approach to be possible the interrupted program must use the stack pointer in a hygienic fashion. At any time, if an address is suddenly pushed onto the stack as a result of an interrupt it must not overwrite valid data. Also, on return from the interrupt routine, all internal CPU registers must contain the values they held at the time of the interrupt. (Microchess does switch the stack pointer back and forth between two areas, but these are two normal stacks; data is PUSHed on and POPped off, the stack pointer always pointing to the bottom of the current saved data/addresses and never into the middle.)

The software

In building up the table we are only interested in certain sections of the program. (There is no need to speed up the first section of Microchess because nearly all the time is spent waiting for the player to type in his move.) There are two possible approaches to ensure

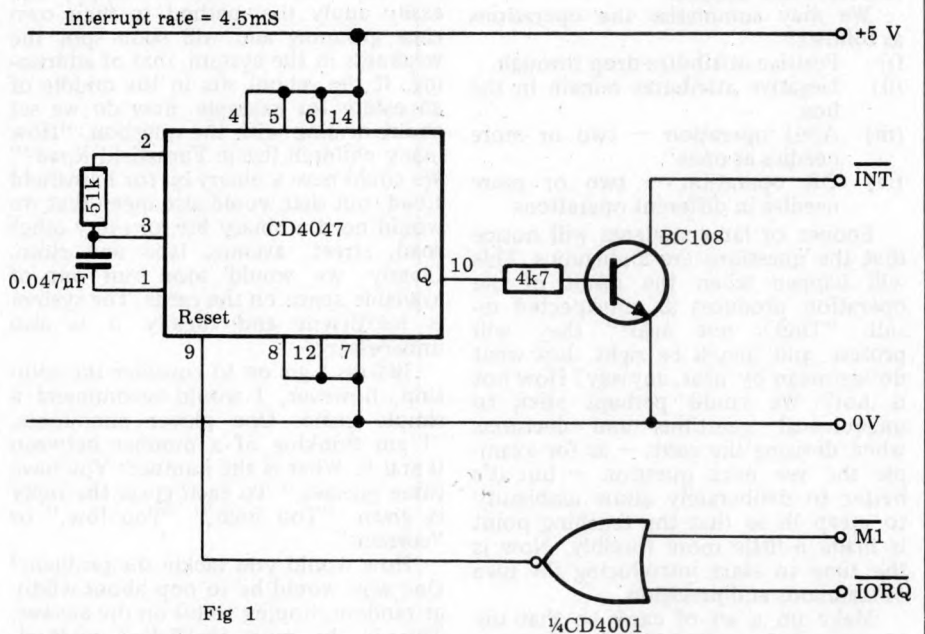

Fig 1

The CD4047 monostable is wired to run in its astable mode. When the Q output goes high it switches on the transistor (any small signal NPN transistors will do) which pulls the INT line low. The Z80 acknowledgement (if it occurs) is detected by the NOR gate and is used to clear the 4047. This removes the interrupt request and starts the 4047 timing period off again. If the Z80 interrupt system is not enabled the 4047 free runs and the INT line (which goes alternately high and low) is ignored by the Z80.

Alternatively the 4047 Q output, (or the output of a baud rate generator), could be connected to the strobe input of a parallel I/O port such as a Zilog PIO or Motorola PIA if such a device is already connected into the interrupt system.

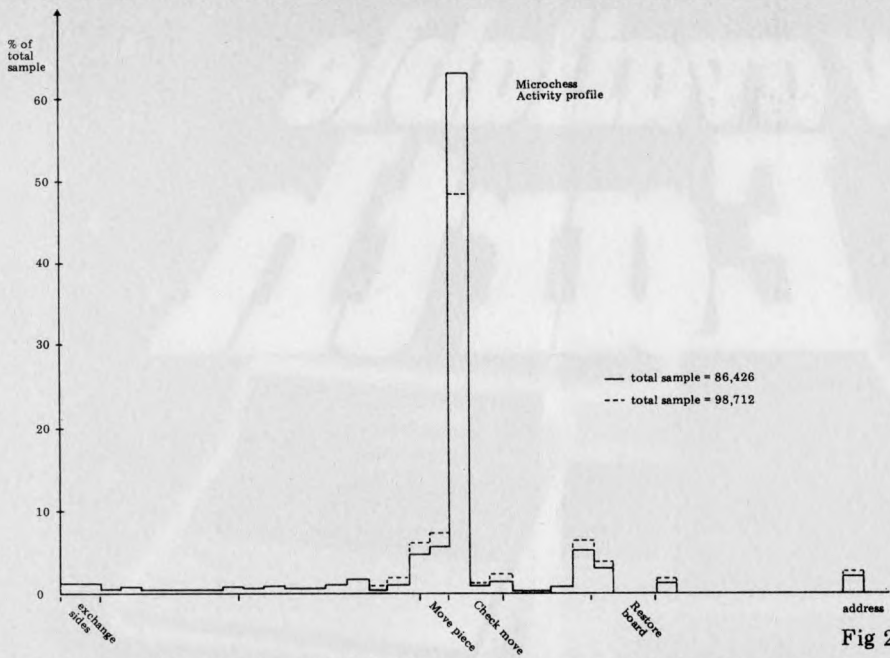

Fig 2

that only useful data is recorded: the first is to enable the interrupt system only while the program is within the area of interest; the second, applicable to those whose interrupt system cannot be inhibited, or where the analysis is more complex, is to make the routine ignore any addresses that lie outside the range of interest.

The interrupt routine used on Microchess is shown in the listing. The complexity of this routine will depend on several factors, the primary one being the amount of free memory left in the system after the program under investigation has been loaded. Ideally it should be a simple 'data collection' type of routine which leaves the basic data to be analysed by another program. This allows the analysis program to be run several times, the analysis criteria being changed between runs in order to amplify any interesting points revealed by the earlier runs. With too much preprocessing the interrupt routine would have to be changed and the whole sampling process repeated, but this cannot be avoided if there is only a small amount of free memory left after the program under analysis is loaded.

Application to Microchess

Within Microchess the main program flow is:

- Player makes move
- Call Display
- Call Microchessmove
- Print move
- Call Display

and so to control the range analysed by the interrupt routine 'enable interrupt' and 'disable interrupt' instructions were inserted before and after the call to Microchessmove. The interrupt routine (see listing) used one 16-bit counter per two addresses within Microchess.

The table area was cleared and Microchess started running. A game was then played against Microchess until the interrupt routine dropped back to the monitor (automatic when any 16-bit count reached 32,512).

Having generated the data table it was analysed by a simple Basic program. The USR function was used to access the table, although PEEK or DEEK could be used equally as well. Assembler language programs can of course be used, or even a manual examination of memory from the monitor, but a Basic program is the simplest approach, assuming there's still room to run it. The program summed the samples to

produce a total and then printed out the percentage occupancy (to two significant figures) per 16-byte block of code; with graphics facilities you could produce a more readable display. From these figures the activity profile of Figure 2 (solid line) was plotted. The program apparently spent 63% of its time in just 16 bytes of code!

After checking the hardware and software and repeating the measurement, I accepted this as fact and examined the code of those 16 bytes. This is also shown in the listing and related to Microchess's internal representation of the chess board. Microchess does not hold an image of the board, but instead has a 'piece table'. This table, which contains one byte per chess piece (ie 32 entries), holds the board position of each piece. If a piece has been captured its board position is greater than 77H, the board coordinates being 0,0 (00H) to 7,7 (77H). Thus the program, having generated a move to a particular square, has to search the piece table to see if anything is actually standing on that square. It was only after realising that the five lines of the loop are often repeated at least 32 times per move (5x32=160 lines of program) that I began to accept the figure of 63%. (If the routine finds the square is occupied it may already be well down the table. If the piece is of the same colour it immediately generates a new

GOTO page 123

```

Activity Profile for Microchess
0000          0002 ;
0000          0003 ; Mode 1 Interrupt Patch
0000          0004 ;
0000          0005      ORG 56          ;RST 56 address
0038 C3 10 50  0006      JP INTRTN      ;Transfer to Interrupt routine
003B          0007 ;*****
003B          0008 ; USR function for MITS BASIC V.4.0
003B          0009 ;*****
003B          0010      ORG $5000
5000 CD 38 07  0011 ACCESS: CALL DEINT      ;Get parameter in call
5003 21 00 50  0012 LD HL,$5000      ;Base of RAM table
5006 19        0013 ADD HL,DE      ;Index into it
5007 46        0014 LD B,(HL)      ;Get lo' byte
5008 23        0015 INC HL
5009 7E        0016 LD A,(HL)      ;Get hi' byte
500A C3 E5 0D  0017 JP RETV      ;Return value to Basic
0738          0018 DEINT: EQU $738
0DE5          0019 RETV: EQU $DE5
500D          0020 ;*****
500D          0021 ; Interrupt routine for Activity Profile
500D          0022 ;*****
500D          0023 ; One 16-bit count per two addresses
500D          0024 ; Expected range of addresses $442B to $493C
500D          0025      ORG $5010
5010 08        0026 INTRTN: EX AF,AF'      ;Save registers
5011 D9        0027 EXX
5012 E1        0028 POP HL      ;Copy return address....
5013 E5        0029 PUSH HL      ;.....to HL
5014 11 00 10  0030 LD DE,$1000      ;Offset to RAM table
5017 19        0031 ADD HL,DE      ;Address now $5XXX
5018 CB 85     0032 RES 0,L      ;Make $5XXY where Y is even
501A 34        0033 INC (HL)      ;Bump counter there
501B 20 08     0034 JR NZ,EXIT      ;Leave if no carry
501D 23        0035 INC HL      ;On to the high byte
501E 34        0036 INC (HL)      ;Add the carry in
501F 7E        0037 LD A,(HL)      ;Check it
5020 FE 7F     0038 CP $7F      ;Full?
5022 CA 39 F2  0039 JP Z,$F239      ;Yes, drop back to monitor
5025 08        0040 EXIT: EX AF,AF'      ;Restore registers
5026 D9        0041 EXX
5027 FB        0042 EI      ;Turn on interrupts again
5028 ED 4D     0043 RETI      ;Done, continue with M.chess
502A          0044 ;*****
502A          0045 ; Section of code from Microchess
502A          0046 ;*****
502A          0047      ORG $46A0
46A0 0E 1F     0048 LD C,31      ;No. pieces in table (0-31)
46A2 21 9C 49  0049 LD HL,PTABLE      ;Top of piece table
46A5 BE        0050 LOOP: CP (HL)      ;Do coordinates match?
46A6 CA B1 46  0051 JP Z,FOUND      ;Yes,skip
46A9 2B        0052 DEC HL      ;Next entry
46AA 0D        0053 DEC C      ;Next piece
46AB F2 A5 46  0054 JP P,LOOP      ;Loop if more in table
46AE C3 B9 4C  0055 JP EMPTY      ;Not in table
46B1          0056 ;
499C          0057 PTABLE: EQU $499C
4CB9          0058 EMPTY: EQU $4CB9
46B1          0059 FOUND: EQU *
0060          0060 END

```

Now available on Earth



THE SHARP MZ-80 COMPUTER SYSTEM

The Sharp MZ-80 System is a new approach to computer applications and their efficient use. Our aim is to make computers relatively simple and therefore better

understood and better used by those they are designed to serve. Take a look at the Sharp range - it will change the way you think about computers.

Business & Electronic Machines
7 Castle Street
Edinburgh
Scotland
Edinburgh (031-226) 5454

Central Calculators Ltd
86-90 Paul Street
London EC2
01-729 5588

Crystal Electronics Ltd
40 Magdalane Road
Torquay
Devon
Torquay (0803) 22699

Digital Design & Development
43 Grafton Way
London W1
01 387 7388

Electronic Business Systems Ltd
54 Clement Street
Birmingham 1
West Midlands
Birmingham (021-233) 3045

Fortronic Ltd
Holden Way
Donibristle Industrial Estate
Dunfermline
Fife
Dunfermline (0383) 823121

Gilbert Computers
Old Hall Lane
Lubenham
Leicestershire
Lubenham (0858) 65894

H B Computers Ltd
22 Newland Street
Kettering
Northants
Kettering (0536) 83922

Howes Elect
Microcomputer Centre
Newton St
Lincoln 0522 32379/791088

A & G Knight
108 Rosemount Place
Aberdeen
AB2 4YN
Aberdeen (0224) 630526

Kratos-Instem Ltd
Walton Industrial Estate
Stone
Staffordshire
Stone (0785) 812131

Lion Computer Shops Ltd
Lion House
227 Tottenham Court Road
London W1
01-637 1601

Newbear Computing
40 Bartholomew Street
Newbury
Berks
Berks (0635) 30505

Personal Computers Ltd
194/200 Bishopsgate
London EC2M 4NR
01-626 8121

Peter Scott (Exeter) Ltd
76 South Street
Exeter
Devon
Exeter (0392) 73309

Scope
Stone House
Houndsditch Entrance
128/140 Bishopsgate
London EC2M 4HX
01-247 8506

Sumlock Bondain Ltd
Sumlock Anita House
15 Clerkenwell Close
London EC1R 0AA
01-250 0505

Sumlock Bondain (East Anglia) Ltd.
32 Prince of Wales Road
Norwich
Norfolk
Norwich (0603) 26259

Tomorrows World Ltd
17 Harcourt Road
Dublin 2
Eire
Dublin (0001) 755885

This is a list of dealers participating in associated advertising and not a full list.

SHARP

COMPUTER
APPLICATIONS

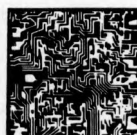

Business Systems, Audio, Video, Calculators, Cash Registers, Copiers, Microwave Ovens.



MICRODIGITAL
are
the Experts!

Wide Range

Competitive prices

All plugs and leads free

12 months guarantee

Access/Barclaycard/Stereo Club

Free Delivery

Specialisation

14 days credit

Fast friendly service

Freepost

A Laskys Company

All equipment tested before despatch

**Turn to the back page of this supplement
your chance to win**

£1000

exclusively to spend at Microdigital



LASKYS
COMPANY

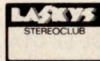

Office:
14 CASTLE STREET,
LIVERPOOL L2 0TA.
Registered in England No. 1375098

Retail Premises at:
25 BRUNSWICK STREET,
LIVERPOOL L2 0PJ.
Tel:- 051-227 2535/6/7



Sharp Pocket Computer

A genuine advance in technology.

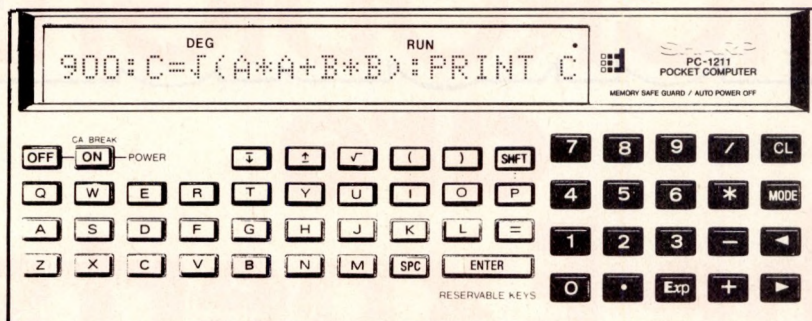

Adoption of Basic Language

For Programming, the PC-1211 employs the BASIC language, used widely from beginners to professionals. This simple programming method can easily be carried out by referring to the flow chart. Moreover, formulas can be entered as they are normally written. These innovative functions are designed with ease of operation in mind.

The PC-1211 also serves as an ideal "stepping stone" to professional computers.

Dot matrix display – up to 24 digits with rolling writer.

Characters as well as numerals are displayed with the dot matrix display enabling the operator, to communicate with the unit. The BASIC language can be used to its full potential. The display panel makes it possible to display portions of the program (line by line) visual instruction asking for data and showing calculation results.

Program capacity 1424 steps. 26 memories with memory safe guard.

The PC-1211 has a large memory capacity in spite of its slim, compact body. Due to the memory safe guard circuit, information in memory is maintained even after the power is turned off.

Programming is by an efficient "one-command, one-step" system. According to your needs, steps can also be used as a memory.

(8 steps is equivalent to 1 memory).

Reservable key and definable key systems.

* The reservable key system makes it possible to reserve a key

for a function or command which is used frequently. It can easily be recalled by the touch of a key when putting in a formula either during manual calculation or programming.

* The definable key system defines 18 programs for each key. Whenever you need a certain program, you can recall and run it with the touch of the proper key.

Programs and data can be saved in and loaded from a tape recorder.

The cassette tape recorder can be used as an external memory device. (Cassette interface CE-121 is optional)

By saving programs or data on a cassette tape, the information can be loaded whenever necessary. It is also possible to search the saved program data automatically by file name or load it for use during the program calculation.

Other features

- * Long-life operation, Auto power-off function.
- * Playback function enables correction by displaying the formula with a single touch of a key.
- * Effective tone function is designed to identify the program. (A beep sound can be input during programming.)

Price	Nett	Vat	Total
PC-1211 Pocket Computer	84.00	12.60	96.60
CE-121 Cassette Interface	12.00	1.80	13.80

Specifications SHARP POCKET COMPUTER

Model:	PC-1211	Editing functions:	and logical calculations. Cursor shifting (>, <) Insertion (INS) Deletion (DEL) Line up and down (↑, ↓)
Number of calculation digits:	10 digits (mantissa) + 2 digits (exponent)	External memory Function:	By using the optionally available cassette interface (CE-121), program, reserve program, and data memory can be saved or loaded to or from cassette tape recorder.
Calculation system:	According to mathematical formula (with priority judging function)	Memory protection: Display:	CMOS battery back-up 24-digit alphanumeric dot matrix liquid crystal display. CMOS LSI, ETC.
Program system:	Stored system	Component: Power supply:	● Alkaline manganese battery (LR-44) x 3 (built-in) Approx. 100 hours ● Silver oxide battery (G-13 or S15 type) x 3 Approx. 300 hours
Program language:	BASIC	Power consumption:	4.5V ... (DC): 0.009W 4.5V ... (DC): 0.011W (with CE-121)
Capacity:	Program memory; Max. 1424 steps Data memory; Fixed memory ... 26 pcs. Flexible memory (common) 178 pcs.	Operating temperature: Dimensions:	0°C 40°C (32°F 104°F) 175(W) x 70(D) x 15(H)mm 6-7/8"(D) x 19/32"(H)
Stack:	Reserve memory; Max. 48 steps (reserve PROGRAM: Max. 18 kinds) Input buffer; 80 characters	Weight: Accessories:	Approx. 170g (0.37 lbs.) Hard case, battery x 3 (built-in), applications manual, beginner's textbook for "BASIC", template x 2
	For data; 8 stacks For function; 16 stacks (in parentheses, 15 levels) For subroutine; 4 stacks For FOR-NEXT statement; 4 stacks		
Calculations:	Four arithmetic calculations, power calculation, trigonometric and inverse trigonometric functions, logarithmic and exponential functions, angular conversion, extraction of square root, sign function, absolutes, integers,		



Office:
14 CASTLE STREET,
LIVERPOOL L2 0TA.
Registered in England No. 1375098

Retail Premises at:
25 BRUNSWICK STREET,
LIVERPOOL L2 0PJ.
Tel:- 051-227 2535/6/7



Apple II

sets the standards.

Free with every Apple II

- ★ 32K bytes of extra RAM
- ★ Black and white Modulator.

Why Apple II

Apple Computer has built a reputation for advanced design with innovations like:

- Colour Graphics
- High Resolution Dot Graphics
- Sound Synthesis
- Analog Inputs

Apple understands product support: documentation, software, accessories, and the system capacity to take advantage of them. Additionally, more than 60 other companies produce hardware and software products for Apple II, making the system an industry standard.

The Apple II Computer features

Apple II is a state-of-the-art personal computer. It is not a toy or a video game, but a sophisticated system for the person who appreciates quality tools. It's worth more, because its unique features help you do more.

Colour Graphics

Apple's colour graphics permit applications ranging from business charting to architectural design. They make any presentation more effective.

Sound Synthesis

A built-in loudspeaker lets you explore audio applications from computer music to synthesized human speech.

Languages

Apple speaks BASIC, so you can use the programs already available in hundreds of publications. We offer a powerful scientific BASIC, with all the string and mathematical functions a programmer could want. We also offer assembly language and PASCAL for advanced users. More languages are under development.

Expansion Capacity

Apple II can handle complex applications, with up to 48K bytes of user memory space. And it can expand as your needs do, with a hefty power supply and eight connector slots for disks, printers, and other peripheral interfaces.

Apple is a system, not just a computer. It offers the peripherals and accessories the professional looks for. Whether you want printers, voice recognition, telecommunications, or high-density floppy disks. Apple can meet your needs.

The Apple system offers smart peripherals, so you can use them immediately without developing special control programs. They let you expand the capability of your system without adding boxes and power supplies.

Apple helps you learn, with the most complete documentation on the market. Whether you're an engineer designing computer interfaces or a beginner curious about programming, you'll find the information you need in our detailed manuals.

Floppy Discs.

Gives your system immediate access to large quantities of data. The subsystem consists of an intelligent interface card, a powerful Disk Operating System and one or two mini-floppy drives.

Features

- Storage capacity of 116K kilobytes/diskette. (140K with Pascal).
- Data transfer rate 156K Bits/second.
- Individual file write protection.
- Powered directly from Apple II.
- Full disk capability with systems as little as 16K bytes of RAM.



- Fast access time – 600 m sec (max) across 35 tracks.
- Powerful disk operating software.
- Load and store files by name.
- BASIC programs chaining.
- Random or sequential file access.

Prices	Nett	Vat	Total
Apple II 16k + free offer	695.00	104.25	799.25
Disk system	349.00	52.35	401.35
Second disk drive	299.00	44.85	343.85

Latest Apple II plus model with floating point BASIC and Autostart ROM.

Colour output optional – requires Eurocolour card.

Parallel Printer Interface

The Parallel Printer Interface Cards are available to allow the use of parallel printers with your APPLE computer.

Features

- Built-in Firmware Allows Printing With Simple BASIC Commands
- Prints up to 255 Char/Line for format flexibility
- High Speed—up to 5000 Char/Sec (3700 LPM @ 80 Char/Line)
- Easy to Use with Most Popular Printers (Axiom, Centronics, SWTP, Selectric conversions).

Specifications

PARAMETER	DESCRIPTION
Data and Control Signals:	7-8 Parallel Data Bits, STROBE and ACKNOWLEDGE
Print Line Width:	40-255 Char/Line. Automatic formatting of BASIC listings.

Price	Nett	Vat	Total
Parallel	104.00	15.60	119.60
Centronics	130.00	19.50	149.50

Communications Interface Card

The Communications Interface Card is available separately to allow you to connect your APPLE to modems, CRT terminals, and other devices employing a serial RS-232C interface. The card's built-in intelligence lets you control these devices easily, in BASIC.

Features

- Firmware Control Programs
- No Software to Write
- Easily Controlled from BASIC using simple commands
- Communicates at 110 or 300 Baud, Half- or Full-Duplex
- RS-232C-compatible Serial Interface



Office:
14 CASTLE STREET,
LIVERPOOL L2 0TA.
Registered in England No. 1375098

Retail Premises at:
25 BRUNSWICK STREET,
LIVERPOOL L2 0PJ.
Tel:- 051-227 2535/6/7



Sharp MZ-80K

The quality single unit computer.

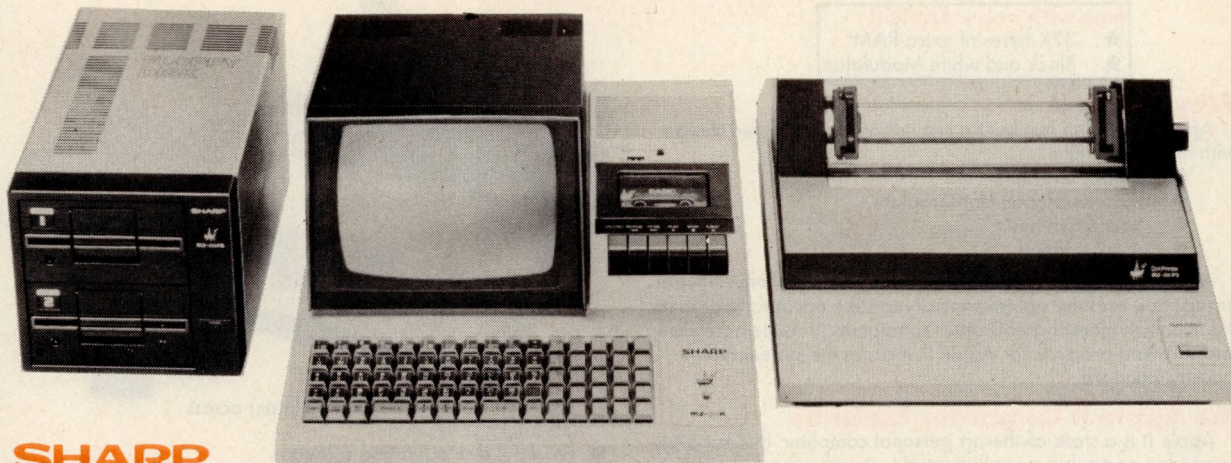

SHARP

New Low prices

	Net	Vat	Total
MZ-80K Computer 48K RAM	500.00	75.00	575.00
MZ-80FD dual disk drive	780.00	117.00	897.00
MZ-80P3 printer	500.00	75.00	575.00
MZ-80I/O interface unit	84.00	12.00	96.60
MZ-80FDK extra disk drives	680.00	102.00	782.00
MZ-80T20C machine language	18.00	2.70	20.00
MZ-80TU assembler	38.00	5.70	43.70

Not a Kit

Works the same day you buy it.

Japanese

The same quality they have put into cars and Hi-Fi.

Single Unit

No trailing leads and wires

Z80

More registers and instructions than other processors

Tape Basic

You don't get left with obsolete ROMS

Tape counter

Know where you are on the tape.

Sound

Built-in music synthesiser with 3 Octaves.

Fast loading

Cassette interface runs at 1200 bps.

Other features - 79 keyboard up to 48K RAM, on screen editing, real time clock 256 different characters, 10 inch video display 80 x 50 bit mapped graphics.

The Basis of System Expansion Interface Unit MZ-801/O

The MZ-801/O interface unit connects the central processing unit (CPU) with other terminal units and makes possible further expansion of the system.

The interface unit can hold up to five different interface cards and utilizes its own built-in power source.

Fast and Legible Printing of Characters and Graphics Dot Printer MZ-80P3

By parallel data input, the MZ-80P3 prints characters on ten-inch wide paper, 80 characters to the line, at a speed of approximately 1.2 lines per second. The "tractor feed" system prevents paper slipping and produces clear print at high speed. A variety of characters can be printed by the MZ-80P3, including both upper and lower case letters, numerals and graphics.

Large Memory Capability in a Compact Unit Floppy Disc MZ-80FD

Memory capacity up to 280K bytes can be accessed quickly and easily from dual driven standard 5.25 inch floppy discs.

Specifications

MZ-801/O

Interface system: Parallel interface
Signal: TTL level
Usable interface card: Up to 5 sheets
Printer interface card, Floppy Disk interface card, Colour display interface card, Universal interface card, etc.

Power consumption: 45W
Power Supply: Local voltage, 50Hz
Operating temperature: 0 to 35°C
Storage temperature: -15 to 60°C
Dimensions: 205(W) x 320(D) x 130(H)(mm)
Weight: 5kg

MZ-80FD

Memory capacity: 143K bytes/drive (286K bytes/unit)
No. of tracks: 70
No. of sectors: 16 (per track)
Working conditions: 4 to 25°C, 28 to 80% (relative humidity)
Rated voltage: Local Voltage, 50Hz
Power consumption: 40W
Outer dimensions: 205(W) x 320(D) x 200(H)(mm)
Weight: 7.9kg

Option:

Floppy interface card: MZ-80FI/O included in price
Disk BASIC: MZ-80FMD included in price
Flat cable for connection: MZ-80F15, included in price

MZ-80P3

Printing method: Serial dot matrix method
Feed method: Tractor feed method
Printing capacity: 80 characters/line
40 characters/line (Double size character display)

Kinds of printed characters: 226 kinds excluding the space code
Character make-up: 6 x 7 dots
12 x 7 dots (Double-size character display)

Size of character: Width: 2.2mm Height: 3.1mm
Printing speed: About 1.2 lines/sec (at 25°C)
Line-to-line space: 2.54mm (in normal mode)
Head sweep direction: Left Right
Operation switches: Power supply & paper feeding
Interface: Conforming to Bandminton interface

Print recording paper:
(1) Kind: Fanfold paper
(2) Size: (Width) 102 to 254mm (4 to 10 inches)
Note: In the case of printing 80 characters per line, use paper of 254mm width. Copy possible

Ink ribbon:
(1) Colour: Single (Black)
(2) Size: 13mm(W) x 11,000mm(L)
(3) Life: About 2 million letters

Power supply: Local voltage, 50Hz
Power consumption: 85W
Working temperature: 5 to 40°C
Working humidity: 10 to 80% (No dew-condensation)
Storage temperature: -20 to 50°C
Storage humidity: 5 to 85% (No dew-condensation)
Outer dimensions: 410(W) x 385(D) x 198(H)(mm)
Weight: 10.6kg

*Specifications and design subject to change without notice.



Office:
14 CASTLE STREET,
LIVERPOOL L2 0TA.
Registered in England No. 1375098

Retail Premises at:
25 BRUNSWICK STREET,
LIVERPOOL L2 0PJ.
Tel:- 051-227 2535/6/7



Apple II

sets the standards.

apple computer
Sales and Service



ROM Plus card

ROMPLUS + provides six sockets to accept individually addressable 2K ROM's or EPROM's. Keyboard Filter a 2K ROM program, comes installed on the ROMPLUS + board and adds many useful features to your Apple, including:

- Upper and lower case letters. The only system that offers keyboard input and standard shift key operation.
- Multiple user-defined character sets.
- Coloured or inverse-coloured letters.
- Keyboard macros – two key-stroke, automatic typing of multiple, user-defined words or phrases. Including BASIC and DOS commands.
- Mixed text and graphics.
- Improved cursor control.
- STOP LIST and END LIST.

	Nett	Vat	Total
Price	105.00	15.75	120.75

Hobby/ Prototyping Card

Create your own APPLE interface boards with this wire-wrap card. The 2 3/4" x 7", double-sided circuit board includes a hole pattern (on 100-mil centres) that accepts all conventional IC's and passive components. It plugs directly into any APPLE expansion connector, and fits entirely within the computer case. Supplied with complete bus documentation to aid the interface designer. (Order No. A2B0001).

	Nett	Vat	Total
Price	15.00	2.25	17.25

Apple Pilot

PILOT is a high level, easy-to-use language which was designed for educators and courseware developers. Since 1968 many teachers and trainers have been using PILOT to create Computer Aided Instruction (CAI) programs. In fact, PILOT is available on more computers than any other CAI language. This means, a large number of potential customers and a large number of existing PILOT programs, most of which will run on the Apple PILOT system.

Apple PILOT has been designed to take full advantage of the Apple's unique features and at the same time offer a superior easy to use CAI system. Through the use of graphics and sound, the instructor can prepare lessons utilizing the full capabilities of the Apple II. Apple PILOT offers the courseware designer a total support system.

System Requirements

- Apple II or II PLUS with 48K memory
- One disk drive for "LESSON" mode or two disk drives for both "AUTHOR" and "LESSON" modes.
- DOS 3.3 or The Apple Language System.

Price on application

DOS 3.3

Apple's new DOS, DOS 3.3, contains two significant improvements for the Apple owner. It creates a compatible environment so that the Apple owner can easily and efficiently use his Applesoft, Integer, and Pascal programmes on one set of hardware. The second benefit for the user is that the disk space available is increased 23%. Under the old operating system, approximately 103,000 bytes were available to the user. With the new DOS, 126,976 bytes will be available for user programs.

Included with the new DOS is a utility to convert programs from the old disk format to the DOS 3.3 format, a fast single or double disk drive file copying program, a diskette to allow you to run unconverted software from the old disk format, and a flexible new file utility program. Also included in the package is a new DOS manual, and, of course, the necessary PROMs to change your Apple to the new disk format.

	Nett	Vat	Total
Price	39.00	5.85	44.85

Other Prices

	Nett	Vat	Total
Applesoft Firmware Card – for integer Apples	116.00	17.40	133.40
Integer Card – For applesoft apples	116.00	17.40	133.40
IEEE 488 interface card	212.00	31.80	243.80
Vinyl carrying case	16.00	2.40	18.40
Speechlab – speech input	127.00	19.05	146.05
Supertalker – speech output	136.00	20.40	156.40
Sup 'R' Terminal – 80 column card	253.00	37.95	290.95
A.I.O., Serial and Parallel card	120.00	18.00	138.00
AppleSet 16 channel 8 bit A-D	166.00	24.90	190.90
CCS 3 1/4 digit BCD A-D	80.00	12.00	92.00
Templeman dual 8" disk system – 1M byte	1550.00	232.50	1782.50
Numeric keypad	125.00	18.75	143.75



LASKEYS COMPANY



Office:
14 CASTLE STREET,
LIVERPOOL L2 0TA.
Registered in England No. 1375098

Retail Premises at:
25 BRUNSWICK STREET,
LIVERPOOL L2 0PJ.
Tel:- 051-227 2535/6/7



Apple II

sets the standards.

Specifications	PARAMETER	DESCRIPTION
	Signal level:	EIA RS-232C
	Data Word Format:	1 start bit, 1 or 2 stop bits, 7 or 8 data bits; odd, even or no parity

	Nett	Vat	Total
Price	130.00	19.50	149.50

Serial Interface

The Serial Interface Card allows an APPLE computer to exchange data with computers, printers, and other devices in serial format (one bit at a time). It is intended for use (in place of the Communications Interface Card) in applications that:

- Use data rates other than 110 or 300 baud (10 or 30 char/sec)
- Involve serial printers that don't require "handshake".

Features

- Permits BASIC Control of High-Speed Printers and Plotters
- Quickly Transfers Large Blocks of Data by Telephone (through a modem), or Directly to Local Equipment
- Handles Half-Duplex Communication from 75-19.2K Baud
- Programs Easily with Switch-Selectable Preset Conditions for Speed, Line Length, Auto Line Feed and Carriage Return Delay

Specifications	PARAMETER	DESCRIPTION
	Signal Level:	EIA RS-232C or 20mA current loop
	Data Word Format:	1 start bit, 1 or 2 stop bits, 5-8 data bits; odd, even, or no parity. Checksum is optional.
	Character Handling Options:	Lower-case characters optionally converted to upper-case or passed through unmodified and displayed in inverse video.

	Nett	Vat	Total
Price	113.00	16.95	129.95

Eurocolour Card Produces PAL colour signals to drive colour video monitor or with a Black & White modulator drives a colour T.V.

	Nett	Vat	Total
Price	79.00	11.85	90.85

Language System

This package includes the Language Card, which allows APPLE users to take immediate advantage of the powerful PASCAL language as well as the Integer and Applesoft BASIC interpreters. The Language Card's 16K bytes of RAM memory electrically replace the ROM firmware built into each APPLE. Upon start-up, this RAM memory is automatically loaded from disk with the user's choice of languages, then electrically protected from change. The loading is controlled by the AUTO-START ROM, also contained on the card. The complete system also includes diskettes containing a language selection "Hello" program, PASCAL, Applesoft BASIC, and Integer BASIC. The reference manuals for all the above languages are also included.

	Nett	Vat	Total
Price	299.00	44.85	345.85

Apple Fortran

Apple FORTRAN is "ANSI Standard Subset FORTRAN 77." These latest computer industry standards provide significant additions and enhancements over previous 66 standards (FORTRAN IV). An example of this is the expanded "IF" statements that have been added to traditional FORTRAN statements.

Apple FORTRAN operates in the Apple Pascal Language system offering the same comprehensive software development environment provided to our Pascal programmers. The Editor, Linker, Filer and Assembler can all be used with the Apple FORTRAN compiler, which, like Pascal, produces 'P' code.

	Nett	Vat	Total
Price	120.00	18.00	138.00

Graphics Tablet

The Graphics Tablet is an image input device that allows the user to enter pictorial information directly (by sketching or tracing) from:

- maps and photographs
- logic diagrams and schematics
- histograms
- architectural drawings
- fine art

Tracing a shape on the tablet surface converts the image to digital values. This information is displayed on the video monitor and may be stored on disk for later processing by the Apple.

	Nett	Vat	Total
Price	462.00	69.30	531.30

Appletel

The Appletel package provides the means to bring the Apple II computer and the Prestel service together. The power of the Apple microcomputer makes the Appletel terminal much more than a simple Prestel receiver. You have the facility to store pages from Prestel in the computer and examine them later at leisure (saving telephone bills). You can automatically call up a sequence of pages of information you regularly need and/or store them. You can use the Appletel terminal to put your own information onto Prestel. Appletel has local editing facilities to help you do this. The fact that you have a full keyboard means that you can make good use of the Prestel facility for sending messages.

	Nett	Vat	Total
Price	595.00	89.25	684.25

Alf music synthesiser card

Three part harmony — plugs into domestic Hi-Fi up to three cards which gives nine parts harmony. Total controls of envelope shape.

	Nett	Vat	Total
Price	180.00	27.00	207.00

Clock/Calendar Card

This plug-in card provides a 388-day calendar and clock, with resolution to 1/1000 second. The clock is crystal controlled to yield .001% accuracy. A built-in rechargeable battery keeps the clock on time up to four days without system power, and external batteries may be used for longer periods. Optional interrupt capability simplifies control applications. Supplied with complete operating instructions and rechargeable battery.

	Nett	Vat	Total
Price	128.00	19.20	147.20

Office:
14 CASTLE STREET,
LIVERPOOL L2 0TA.
Registered in England No. 1375098

Retail Premises at:
25 BRUNSWICK STREET,
LIVERPOOL L2 0PJ.
Tel:- 051-227 2535/6/7





Apple III



- Size:** 17.5 inches wide (44.45 cm)
18.2 inches deep (46.22 cm)
4.8 inches tall (12.2 cm)
Cast aluminium base with moulded plastic cover.
- Weight:** 26 pounds (11.8 kilos)
- Processor:** Apple designed processor utilizes 6502A as one of its major components. Other circuitry provides extended addressing capability, re-locatable stack and zero page, and memory mapping.
- Emulation Mode:** Provides hardware emulation of 48K byte Apple II or Apple II Plus. Allows most Apple II programs to run without modification.
- Clock Speed:** 1.8 MHz with video off, 1.4MHz average 1.0 MHz in emulation mode.
- Main Memory:** 96K (98,304) eight-bit bytes minimum
128K (131,072) bytes maximum
Dynamic RAM memory
- Rom Memory:** 4K (4,096) bytes used for self-test diagnostics
- Power Supply:** High-Voltage switching type
+5, -5, +12, -12 volts
- Mass Storage:** One 5.25 inch floppy disk drive built-in
140K (143,360) bytes per diskette
Up to 3 additional drives can be connected by daisy-chain cable (572K bytes on-line storage)
- Keyboard:** 74 keys (61 on main keyboard, 13 on numeric pad). Full 128 character ASCII encoded. All keys have automatic repeat.

Three special keys: SHIFT, CONTROL, ALPHA LOCK. Two user-definable "Apple" keys. Four directional arrow keys with two-speed repeat. Four other special keys: TAB, ESCAPE, RETURN, ENTER.

Screen: Three upper/lower case text modes:-
80 column, 24 line black-and-white,
40 column, 24 line 16 colour foreground and background
40 column, 24 line black-and-white.

All text modes have a software-definable 128 character set (includes upper and lower case) with normal or inverse display

Three graphics modes:
280 x 192, 16 colours (with some limitations)
140 x 192, 16 colours
560 x 192, black-and-white plus Apple II Modes.

Video Output: RCA phono connector for NTSC black-and-white composite video. DB-15 type connector for:

NTSC black-and-white composite video
4 TTL outputs for generating RGB colour.
Composite sync signal. NTSC colour composite video. +5, -5, +12, -12 volt power supplies

Colour signals appear as 16-level grey scale on black-and-white video outputs.

Audio Output: Built-in 2 inch speaker. Miniature phone-tip jack on back of Apple. Driven by six-bit digital/analog converter or fixed-frequency "beep" generator

Serial I/O: RS-232C compatible, DB-25 female connector. Software selectable baud rate and duplex mode.

Joysticks: Two DB-9 connectors for two joysticks with pushbuttons.

Printer: One DB-9 connector (shared with second joystick) for Apple Silentyper printer.

Clock: Can be set and read from programs. Powered by long-life replaceable watch batteries. Keeps track of month, date, day of week, and exact time to 1/1,000th of a second.

Expansion: Four 50-pin expansion slots inside the cabinet

SOS: Sophisticated Operating System handles all system I/O. SOS can be configured to handle standard or custom I/O devices and peripherals by adding or deleting "device drivers"

All Languages and Application programs access data through the SOS file system.

Languages: Apple Business BASIC, PASCAL, FORTRAN

Phone for a price

 **apple computer**
Sales and Service



Office:
14 CASTLE STREET,
LIVERPOOL L2 0TA.
Registered in England No. 1375098

Retail Premises at:
25 BRUNSWICK STREET,
LIVERPOOL L2 0PJ.
Tel:- 051-227 2535/6/7



Apple Software

Payroll I
Weekly/Monthly. Up to 200 employees. Weekly/Tax, National Insurance and Pension. Up to 20 departments.

	Nett	Vat	Total
Payroll I	375.00	56.25	431.25

Payroll II
Weekly/Monthly. Up to 99 employees. Less detailed reports as in above. Excellent value.

Payroll II	200.00	30.00	230.00
------------	--------	-------	--------

LEDGERS

Sales

500 accounts, 1600 transactions, Credit limit check. 100 Analysis codes, aged debtors analysis.

Program	295.00	44.25	339.25
Manual	3.00		3.00

Purchase

500 accounts, 1600 transactions Turnover aggregated for each customer.

Program	295.00	44.25	339.25
Manual	3.00		3.00

General

Trial Balance/Accumulated profit/Loss on demand. 1000 named accounts, 1700 postings.

Program	295.00	44.25	339.25
Manual	3.00		3.00

Optional Applications Manual

Uses for incomplete records, group consolidation branch accounts, etc.

Optional Applications Manual	10.00		10.00
------------------------------	-------	--	-------

Inventory Control

Probably the most powerful package on the market. 1250 items/disk, 600 suppliers. Automatic re-order routine. Fully documented, easy to use, well proven in the field.

Program	225.00	33.75	258.75
Manual	3.00		3.00

Other Applications:

Point of sale stock control

Licensed trade stock control.

Visicalc

Visicalc and Apple do to the calculator what word processing has done to the typewriter. Plan budgets, rate of returns, financial statements, tax effects, sales forecasting, "What if?" Uses are endless and visicalc is limitless.

Visicalc	95.00	14.25	109.25
----------	-------	-------	--------

Mailing List

Company name/address/contact/ telephone no. 375 records/disk. Add, amend, delete. Print all/selected records. Print self adhesive labels.

Mailing List	27.00	4.05	31.05
--------------	-------	------	-------

Apple Desktop/Plan

A business planning and analysis system designed to aid development and analysis of business plans such as budgets, sales forecasts, cash flow planning, profit and loss predictions and many other similar types of analysis

Apple Desktop/Plan	64.00	9.60	73.60
--------------------	-------	------	-------

Appewriter

Most probably the best word processing system available on a microcomputer for the price. Features include: high speed versatile cursor control, moving blocks of text, delete by character, word and paragraph, left, right, centre justifications, upper and lower case, very easy to use, well documented.

Appewriter	42.00	6.30	48.30
------------	-------	------	-------

Credit Control

An ideal aid for the business who needs tight control on their debtors. Holds up to

Credit Control	75.00	11.25	86.25
----------------	-------	-------	-------

850 accounts. Informs you if any order exceeds the credit limit. Easy to use.

Sales Control

Gives breakdown of sales per client over the last 3 years and each month this year.

Shows number of unconverted enquiries, reports, on printer between user

development parameters on area product turnover to date, turnover this month.

Many other valuable reports.

FOR FURTHER DETAILS PLEASE RING



Programming Aids and Tutorials

	Nett	Vat	Total
Applepie (Integer)	30.00	4.50	34.50
Assembler Editor (Machine Code)	45.00	6.75	51.75
Data Base (Integer)	23.50	3.53	27.03
Disk magic (Integer)	16.00	2.40	18.40
Hi Resolution Character Generator (Applesoft)	16.50	2.48	18.98
Appleforth (Integer)	39.95	5.99	45.94
large Character (Integer)	16.00	2.40	18.40
Lisa (Integer)	28.50	4.28	32.78
Master Catalogue (Applesoft)	14.00	2.10	16.10
Shape Builder (Applesoft)	17.00	2.55	19.55
Step by Step (Applesoft)	37.50	5.63	43.13
Talking Disk (Integer)	14.95	2.24	17.19
Three D Animation (Integer)	12.95	1.94	14.89
Tiny Pascall (Integer)	40.00	6.00	46.00

Business Programs

Active Filter (Applesoft)	15.00	2.25	17.25
Audio Engineer (Applesoft)	15.00	2.25	17.25
Index File (Integer)	16.00	2.40	18.40
Statistics (Applesoft)	19.95	2.99	22.94

Games and Simulations

Games Pack 1 (Integer)	12.00	1.80	13.80
Games Pack 2 (Integer)	12.00	1.80	13.80
Games Pack 3 (Integer)	12.00	1.80	13.80
Games Pack 4 (Integer)	12.00	1.80	13.80
Games Pack 5 (Integer)	12.00	1.80	13.80
Games Pack 6 (Integer)	12.00	1.80	13.80
Games Pack 7 (Applesoft/Integer)	12.00	1.80	13.80
Alien Encounters (Applesoft)	8.00	1.20	9.20
Alien Invasion (Machine Code)	8.00	1.20	9.20
Apple Invaders (Integer)	12.00	1.80	13.80
Battlefield (Applesoft)	8.00	1.20	9.20
Biorhythm (Applesoft)	10.00	1.50	11.50
Breakthrough (Machine Code)	8.50	1.28	9.78
Bulls and Bears (Integer)	12.00	1.80	13.80
Datstones of Ryn (Applesoft)	12.95	1.94	14.89
Death Race (Integer/Machine Code)	10.95	1.64	12.59
Earth Quest (Integer)	11.50	1.73	13.23
Galactic Battle (Integer)	8.00	1.20	9.20
Guided Missiles (Machine Code/Integer)	10.95	1.64	12.59
Invasion Orion (Applesoft)	18.00	2.70	20.70
Laser Blast (Machine Code/Integer)	12.00	1.80	13.80
Lunarlander (Machine Code/Integer)	9.25	1.35	10.64
Phasor Zap (Integer)	10.00	1.50	11.50
Saucer War (Applesoft)	9.95	1.49	11.44
Space Traders (Applesoft)	12.95	1.94	14.89
Space Wars (Machine Code/Integer)	12.95	1.94	14.89
Speedway (Integer)	10.00	1.50	11.50
Star Voyager (Integer)	15.95	2.39	18.34
Strato Laser (Applesoft)	10.95	1.64	12.59
Stunt Cycle (Machine Code)	10.50	1.58	12.08
Super Dungeons (Integer)	12.95	1.94	14.89
Super Starwars (Machine Code/Integer)	11.25	1.69	12.94
Starfleet Orion (Integer)	18.00	2.70	20.70
Temples of Apsai (Applesoft)	22.95	3.44	26.39
U.F.O. (Machine Code/Integer)	8.50	1.28	9.78
War Lords (Integer)	12.00	1.80	13.80

Educational, Mathematical and Scientific Programs

Function Pilot (Applesoft)	18.50	2.78	21.28
Planets (Applesoft)	15.00	2.25	17.25
Sirus (Applesoft)	15.00	2.25	17.25



Office:
14 CASTLE STREET,
LIVERPOOL L2 0TA.
Registered in England No. 1375098

Retail Premises at:
25 BRUNSWICK STREET,
LIVERPOOL L2 0PJ.
Tel:- 051-227 2535/6/7



Video Genie

Value and TRS 80 compatibility

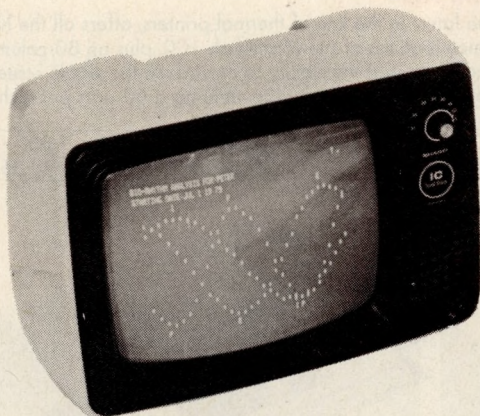

20 free Microdigital quality Cassettes with each Genie

The Video Genie is a complete computer system, requiring only connection to a domestic 625 line TV set to be fully operational; or if required a video monitor can be connected to provide the best quality display.

The system case contains the Central Processor Unit (CPU), 16,000 bytes RAM memory, the cassette system, a 12,000 byte operating system and BASIC interpreter in ROM, and a full size keyboard, in a stylish case, at a price that makes the Video Genie better value than some "kit" computers.

Keyboard

The Video Genie has a 51 key typewriter style keyboard, which features a 10 key rollover. This makes it very easy for experienced and inexperienced typists alike to enter programs and data into the machine.

Applications

The Video Genie System has many uses in all spheres of life, the easy to use BASIC language means that programs are easily written for specific applications, and pre-recorded program tapes are available in great variety.

The system has great scope in the home, sophisticated games programs can introduce the computer age to all the family, who can then progress to writing their own programs in BASIC or even machine code. Software is continuously being developed to aid home budgeting and education.

In a school or college the machine can be used with a large screen TV to allow a whole class to be taught at once.

The powerful Extended BASIC interpreter makes the solution of complex scientific problems simple, and the graphics allow pictorial displays of results.

Extended BASIC

- Single, double and integer - precision numeric variables, as well as string variables.
- multi-character variable, with the first two characters significant.
- program lines, logical lines and string variables up to 255 characters long.
- includes all scientific functions.
- numeric accuracy up to 16 significant digits, with intrinsic functions at 6-digit accuracy.

- formatted, printing, program editing (with extensive editing subcommands), error trapping, named files, program tracing, automatic line numbering, multi-statements per line, and keyboard rollover allowed.
- multi-dimension arrays, and complete string manipulation.
- direct memory inspection, and input/output commands provided.
- direct graphic commands.
- allows access to machine language subroutine.
- many other advanced features, all included in the detailed programming manuals.

Cassette Unit

The Video Genie has an integral cassette system which can save information on standard tape cassettes. An interface is also provided to connect an external audio cassette unit for greater storage flexibility.

Accessories

The Video Genie is supplied with the following accessories:-
BASIC demonstration tape.
Video lead
Second cassette manual

Manuals

Users manual
BASIC manual
Beginners programming manual

These manuals provide an excellent course of instruction for the beginners to computing. They take the user gently through the subject, explaining the concepts of computing with the Video Genie.

Software

The Video Genie utilises the same renowned extended BASIC interpreter as the TRS-80. Most software for the TRS-80 will run on the Video Genie so an enormous range of software is available.

	Nett	Vat	Total
Price	330.00	49.50	379.50

Price does not include T.V./monitor



Office:
14 CASTLE STREET,
LIVERPOOL L2 0TA.
Registered in England No. 1375098

Retail Premises at:
25 BRUNSWICK STREET,
LIVERPOOL L2 0PJ.
Tel:- 051-227 2535/6/7



Printers



Tally/Mannesmann M80/77/MC

A printer for the professional user. This new printer from T/M offers fast, dependable and cost effective hard copy data processing for the business man. Its high speed, 200 c.p.s., bi-directional print mechanism will ensure that your printer is not tied up all day. We are able to offer this printer at a price that includes a 1K character buffer and 132 column print option included in the price. Serial or parallel compatible.

We feel that this printer will fulfill the requirements of the most demanding user, whether it be Payroll, Ledgers or Stock-control, the M80 will handle the application with minimum fuss for the User.

Price	Nett	Vat	Total
Tally/Mannesmann M80/77/MC	1000.00	150.00	1150.00
Includes 1K Buffer, 132 Print Option			

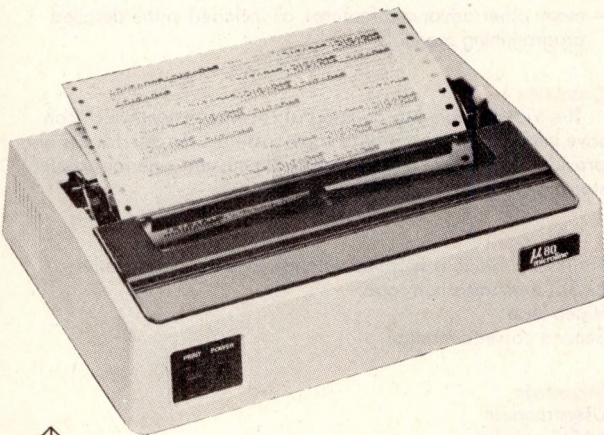

Oki Microline 80

Quality and reliability at a price that makes it available for business, educational and home-user applications. The features and specifications of this small lightweight printer are those of models costing many times more.

- 80 characters per second
- 80 and 132 columns program selectable
- Full 96 character set with graphics printing facility
- Long life 9 x 7 print head matrix parallel and serial compatible.
- Friction and Pin Feed as standard.

Price	Nett	Vat	Total
Microline 80	499.00	74.85	573.85
Tractor Feed Option	35.00	5.25	40.25

Microhush 200

This, the latest in the line of thermal printers, offers all the high performance features of the Microhush 100, plus an 80 column printing capacity and the ability to reproduce the whole screen of a 'Apple' high resolution image, utilising a 60 dots per inch definition.

Price	Nett	Vat	Total
Microhush 200	349.00	49.35	398.35

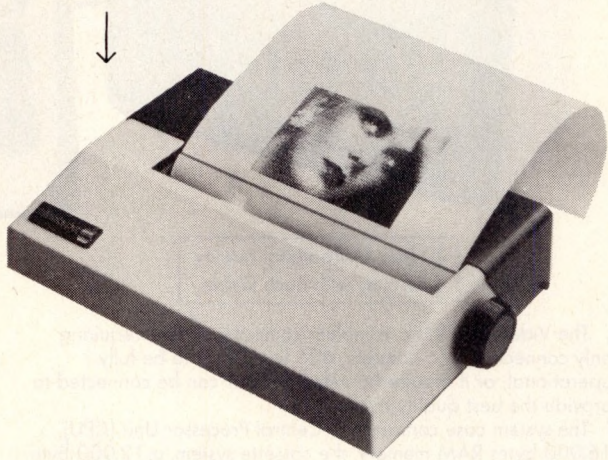

Microhush 100

A fast reliable thermal printer offering the user a high definition 96 character set created by a 5 x 7 print head. Its 40 characters per second, bidirectional look-ahead printing and extremely quiet operation, ensures a high performance at low cost.

Interfacable to most microprocessor systems including Apple, Sorcerer and RS 232.

Price	Nett	Vat	Total
Microhush 100 including 'Apple' interface	299.00	44.85	343.85

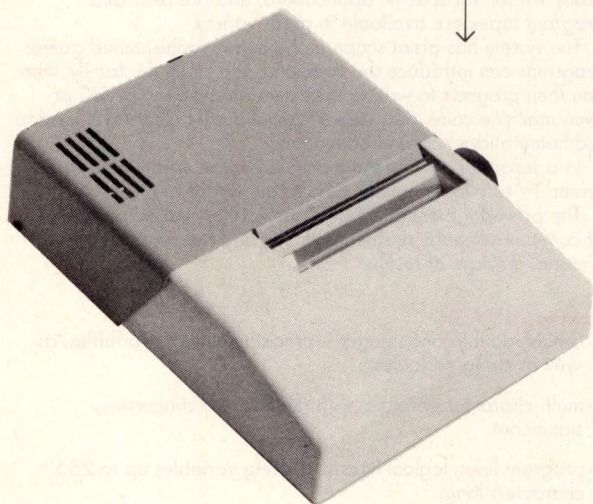

Office:
14 CASTLE STREET,
LIVERPOOL L2 0TA.
Registered in England No. 1375098

Retail Premises at:
25 BRUNSWICK STREET,
LIVERPOOL L2 0PJ.
Tel:- 051-227 2535/6/7



Atom

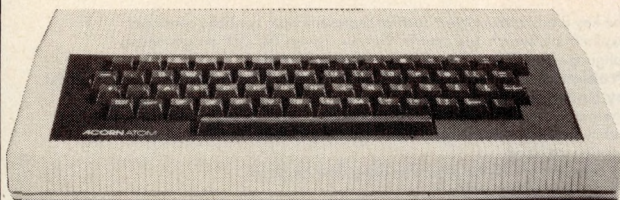

Prices	Nett	Vat	Total
Atom Kit 8K + 2K	120.00	18.00	138.00
Atom Ass 8K + 2K	150.00	22.50	172.50
Atom Kit 12K + 12k	220.00	33.00	253.00
Atom Ass 12k + 12K	250.00	37.50	287.50
1K RAM sets	9.50	1.43	10.93
4K Floating Point ROM	20.00	3.00	23.00
Printer driver	11.50	1.73	13.23
Mains Power Supply	8.00	1.20	9.20

The Basic Atom

Elegantly designed and injection moulded in heavy duty polystyrene, the Atom measures only 15" long x 9½" deep and 2½" high fitting snugly inside a normal briefcase.

And yet it still contains a full sized keyboard laid out in a conventional typewriter way. The full travel, light pressure keys give a positive reliable action, better for both the amateur and experienced typist.

To use the Atom immediately you just connect the power supply and a cable into the aerial socket of a television set. Any UHF colour or monochrome set will do – the Atom doesn't harm them at all.

The Atom has an initial 2K of RAM and 8K of ROM but of course this can be boosted enormously. The standard computer has Basic and Assembler (machine code) graphics and sound output, with direct cassette and TV interface. (See further for list of specifications.) Basic is the language used by Atom and is indeed the language used by most personal computers. The Basic used has all the normal functions you would expect plus many powerful extensions making it easier for you to operate and write your own programs. In personal computer terminology 'powerful' means the machine works harder cutting down the amount of information that you would otherwise have to type in.

How your Acorn Atom grows Internally

Both screen and program memory can be expanded in 1K blocks up to 12K total, and the fixed memory can be added to in two blocks of 4K. One is the 4K floating point arithmetic package. The printer interface requires the addition on board of a 6522 and buffers.

The PAL encoder module when fitted allows full colour output to a domestic colour TV although a simple modification allows direct connection to a colour monitor without a PAL encoder.

Externally

The most exciting addition however is the communication

module which fits inside the case and allows high speed communication to other systems which can be anything from an Acorn System One to an IBM 370 and what's more any number of other Atoms. Designed for classroom use where, for example, twenty Atoms may be linked both to each other and to the teacher's system. The teacher can take control of any keyboard and display for instruction purposes, and can link any pupil to a printer or disc storage facility. In the home or laboratory however, this module may be used to control substations such as System I with any of the Acorn interface modules.
nb. Existing owners of Acorn systems may use the tape interface as a simple communication line to and from the Atom.

Technical Description

Memory: From 2K to 12K RAM on board (in steps of 1K) up to 40K including external memory. From 8K to 16K ROM (two 4K additions).
Processor: 6502 with 1 Mc/s clock.
Video Display Generator: 6847 generates video signals for 8 different modes including: high resolution graphics (256 x 192). Red, green, and blue graphics up to resolution of 128 x 192, and mixed ASCII characters and semigraphics.
PIA: 8255 provides keyboard scan, cassette I/O port (one used for printer output) plus a wide range of serial I/O functions and dual timers.
Cassette Interface: CUTS 300 baud, involves minimum hardware (zero crossing detector input and output from timer) to allow user to redefine tape routine to virtually any speed or standard.
Loudspeaker: Driven from 8255 via buffer allowing software tone generation of any frequency.
B/W Video Output: To monitor.
UHF Modulator Output: Channel 36 domestic T.V.
Bus Output: Fully buffered address and data bus plus internal connections for one Acorn Eurocard.
Power Requirement: Minimum system: 8 volts @ 800mA (from Atom power unit feeding internal regulator). Maximum system: 5V @ 1.8A from external regulator supply.

Hardware

Technical Description

Atom basic: 32-bit arithmetic ($\pm 2,000,000,000$). High speed execution, 43 standard and extended BASIC commands, Variable length strings (up to 256 characters), String manipulation functions, 27 32-bit integer variables, 27 additional arrays, Random number function, PUT and GET bytes, words and strings to and from files, WAIT command for timing, DO-UNTIL construction, Commands may be abbreviated for economy, Multiple statements per line, Logical operators (AND, OR, EX-OR), LINK to machine code routines, Numbers can be input and printed in hexadecimal, Symbolic labels for fast branches and subroutine calls, Powerful indirection operators (8.1), Graphics facilities to draw points and lines, 16 PLOT commands, MOVE and DRAW.
Assembler: Mnemonic Assembler for machine code programming, Formatted listing, Assembler and BASIC may be combined. Standard 6502 mnemonics, Provides symbols, automatic resolution of forward references, Macro-facilities, Breakpoints may be inserted for debugging.
VDU: 32 characters x 16 lines, Inverted characters, Automatic scrolling, Paged/Non paged modes, All control codes can be generated, Screen editing. Operating System, CUTS cassette routines with checksum, Filenames up to 12 character, LOAD and SAVE BASIC and assembler programs or text files, Search (catalogue) routine, Software hook to optional disc drive and communication loop modules, Printer drive routines.
Optional Maths Software: Floating point maths functions to 9 digit accuracy including arithmetic, trigonometric and hyperbolic functions.
Optional Communication Software: Allows high speed bi-directional interface to other Atoms or peripherals, Allows transfer of control or data to other modules in loop.
Optional Utility ROM: Such as the ONLIBASIC extension for real time control of laboratory experiments.

Software

Cassettes/Disks

Disks

High Performance Mini Floppy disks

- Made by Kybe corporation
- Anti static envelopes
- soft sectored
- single sided, single density
- free library cases (with 10 or more disks)
- labels and write protect tabs supplied

Prices	Nett	Vat	Total
one disk	3.00	0.45	3.45
ten disks	22.00	3.30	25.30
fifty disks	100.00	15.00	115.00
one hundred disks	180.00	27.00	207.00

Cassettes

Quality Microcomputer Cassettes.

- C15 Agfa Tape
- Special Labels
- Cellophane wrapped
- Precision transport mechanism
- Leaderless
- Insert Cards
- Screw fixing case
- Proven performance

Prices	Nett	Vat	Total
one cassette	0.80	0.12	0.92
box of ten cassettes	5.20	0.78	5.98
fifty cassettes	25.00	3.75	28.75
one hundred cassettes	45.00	6.75	51.75

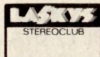

Office:
14 CASTLE STREET,
LIVERPOOL L2 0TA.
Registered in England No. 1375098

Retail Premises at:
25 BRUNSWICK STREET,
LIVERPOOL L2 0PJ.
Tel:- 051-227 2535/6/7

BOOKS

SYBEX BOOKS

Introduction to Personal and Business Computing by R. Zaks

A comprehensive yet simple introduction to the micro computer world for the potential user whether it be for home or business use.

Microprocessors - From Chips to Systems by R. Zaks

The basic text on micros for everyone with a technical or scientific background. This book teaches all the fundamentals of microprocessors step by step.

Microprocessor - Interfacing Techniques by R. Zaks

This comprehensive book introduces the basic interfacing concepts and techniques, then presents the implementation details from hardware to software.

Programming the 6502 by Rodney Zaks

This book is an educational text designed to teach programming, using the 6502. It does not require any prior programming knowledge, yet can be used to advantage by anyone wishing to familiarize himself with the 6502. An invaluable book for owners of the PET, Apple, Kim etc.

6502 Applications Book

This book presents practical applications techniques for the 6502 ranging from a complete home alarm system to an industrial control loop for temperature control. Also includes analog to digital conversion and simple peripherals from paper-tape reader to micro printer.

Programming the Z-80

Another in the highly successful Sybex Series by Rodney Zaks. This book combines the function of a teaching text, that Sybex do so well, with an extensive reference section. The book is much more than an introduction to the Assembly Language syntax of the Z-80.

SCELBI BOOKS

Understanding Micros by N. Wadsworth

If you are at all curious about small computers you must own this no-nonsense text which explains all the fundamental concepts behind the operation of virtually all microcomputers.

Calculating with BASIC

Here's a variety of programs in BASIC to help apply the language to practical problems. The book covers problems in finance, statistics, engineering, mathematics and electronics. Good descriptions and examples are provided with each program listing.

PIMS Personal Information Management System

This book is really a ready to use data base system in Microsoft BASIC with full instructions. An excellent starting point for your home applications.

OSBORNE BOOKS

Z-80 Assembly Language Programming

These books are assembly language primers in the "classical sense" - they treat assembly language as a means of programming a microcomputer system and are full of simple programming examples.

6502 Assembly Language Programming by Leventhal

Another fine manual in the Osborne Assembly Language series to join the best selling 8080, 6800 and Z-80 books.

PET and the IEEE 488 Bus (GPIB) by Fisher & Jenson

A book for instrument designers, scientists, programmers and hobbyists - which shows how you can have a low-cost versatile system that may be interfaced to any of hundreds of electronic instruments.

Introduction to Microcomputers by A. Osborne - Volume 0: The Beginners Book

If you know nothing about computers this is the book to begin with. It explains what computers are and describes their components.

Introduction to Microcomputers by A. Osborne - Volume 1: Basic Concepts

This book describes application techniques common to all microprocessors yet specific to none. All the basic hardware and software concepts are explained simply.

Introduction to Microcomputers - Osborne

(September 1978 Edition)

Volume 2 - Some Real Microprocessors

This 9" x 7" loose leaf format book covers every major microprocessor on the market. 4 bit to 16 bit in detail and analyses more than 20 CPUs. Includes new sections on the most recent entries into the microprocessor market. Describes support devices for use with only one microprocessor.

Volume 3 - Some Real Support Devices - loose leaf

A companion volume to volume 2. This describes the micro support devices which can be used with more than one microprocessor - including system buses.

Some Common BASIC Programs

Includes 76 short programs covering financial, mathematical, statistical and general interest subjects, all of which have been tested.

Z-80 Programming for Logic Design

These books describe the implementation of sequential and combinational logic using assembly language. They describe the meeting ground of the programmer and the logic designer and are written for readers in both fields.

ADDISON - WESLEY BOOKS

Artificial Intelligence by Winston

Artificial intelligence is concerned with extending the application of computers and gaining an understanding of the principles that make intelligence possible. This book designed for use in a course on artificial intelligence should prove invaluable to the newcomer to the topic as well as to the experienced as a reference text. Part one covers an introduction to

4.90

6.95

9.90

7.90

7.90

8.90

7.90

7.90

7.45

8.10

8.20

9.90

5.90

6.25

14.90

10.90

7.90

6.25

13.75

the key ideas in the subject such as representation, symbolic constraint exploitation, search and control. Part two covers the LISP programming language and its use. The book is profusely illustrated.

Problem Solving and Structured Programming in BASIC by Koffman and Friedman

The book reflects the view that good problem solving and programming habits should be introduced at an early stage. Three separate phases of the solution are used:-

- 1) Specification of the algorithm using flow diagrams.
- 2) Analysis of the problem.
- 3) Implementation of the problem solution.

The Little Book of BASIC Style by Nevison

Structure style and correctness and maintainability are the attributes of good programming - they are getting much attention as well they should. When one considers what we invest in programs their manageability and efficiency become very important. In this book these concepts are explained along with 19 rules and many examples in BASIC to help improve your programming style.

A Guide to BASIC Programming by Spencer

A first course in BASIC for Scientists, Business people and Engineers. The book illustrates the application of the language with numerous examples which will be useful later in your BASIC programming career.

Introducing System Design by Squire

This book assumes some knowledge of computers and from this builds a review of the techniques used in system design through data base, security of the system and top down design. An important book for the student of business use of computers.

Software Tools by Kernigan and Plauger

This text is designed to emphasise Structured Programming and Top Down Design. It deals with filters, formatting, files, sorting, text patterns, editing and macro-processing.

BASIC and the Personal Computer by Dwyer & Critchfield

The authors provide a detailed presentation of BASIC and extended BASIC. Included are many applications possible on any microcomputer. Readers are encouraged to think about personal computing in its widest sense, write programs and research new applications. A selection of projects appears at the end of each chapter. The book may be used as a self-study text or a course book.

Problem Solving and Structured Programming in FORTRAN by Friedman & Koffman

This book is designed for a short first course in computer programming. This book introduces the techniques of structured programming at a very early stage. The authors emphasize three distinct phases of problem solving: 1) the analysis of problem 2) the specification of an algorithm and 3) the language implementation of the algorithm.

A Course in APL with Application by Grey

This introductory text may be used by either the experienced computer user familiar with at least one general purpose language, or by the beginner with no previous programming experience. The presentation aims to show that APL is a refinement and enhancement of mathematics. Emphasis is placed on the use of APL as an ideal language for formulating and developing algorithms.

Programming in PASCAL by Grogono

This introductory language manual is an excellent start to one of the fastest growing programming languages today. The book is arranged as a tutorial containing both examples and exercises to increase reader proficiency with the language. Besides a chapter on procedures and files there are sections on dynamic data structures such as trees and linked lists. These concepts are put to use in an example of bus service simulation.

Programming a Microcomputer (6502) by Foster

This book will teach you how to program a microcomputer in machine language. Although designed specifically for the 6502 microprocessor used in the Kim 1, PET and the Apple. The basic principles involved apply to all computers.

The Computer - An Everyday Machine by Squire

This text puts the data processing computer in perspective, introduces it as a tool that can be used and understood by anyone. The approach is to take a simple problem, analyse it and then solve it using a hypothetical language and a computer consisting of the simplest possible units. The book is an excellent introduction to the computer as used by large scale businesses. The author is a systems engineer with IBM Canada and provides her own interesting perspective. The book is widely used by business management students as their first introduction to computers.

The Art of Computer Programming Volume 1 - Fundamental Algorithms by Knuth

This is the first book in this world wide best selling series and thought by many as the best books of their type available. Volume 1 begins with a thorough review of the mathematical techniques used, although it does not assume mathematics above high school level in the reader. It goes on to review assembly level programming and ends with a 200 page review of information structures. The book contains numerous exercises.

8.90

5.70

8.80

9.65

8.15

9.70

9.90

9.70

6.90

7.20

8.40

9.90



Office:
14 CASTLE STREET,
LIVERPOOL L2 0TA.
Registered in England No. 1375098

Retail Premises at:
25 BRUNSWICK STREET,
LIVERPOOL L2 0PJ.
Tel:- 051-227 2535/6/7



BOOKS

- The Art of Computer Programming Volume 2 – Semi-Numerical Algorithms** by Knuth 16.40
This book covers random numbers, random sequences, statistical tests, floating point arithmetic, multiple precision arithmetic, polynomials etc. This book offers a comprehensive interface between existing knowledge of computer programming and numerical analysis including a substantial amount of complexity and number theory statistics. It assumes 'A' level mathematics capability.
- The Art of Computer Programming Volume 3 – Searching and Sorting** by Knuth 20.40
This text is by far the most comprehensive survey of these computer techniques ever published. The material is presented such that the general principles are applicable to a wide range of problems. Some knowledge of computer techniques and elementary calculus is assumed.
- CREATIVE COMPUTING BOOKS**
- BASIC Computer Games** by David Ahl 5.45
The first collection of games all in BASIC. Contains both a complete listing and a sample run of each game along with a descriptive write up.
- More BASIC Computer Games** by David Ahl 5.45
This is the sequel to the best selling "BASIC Computer Games". 84 fascinating and entertaining games for solo or group play. All games are complete with a program listing in BASIC, a sample run and a description. Standard Microsoft BASIC is used throughout and the programs are simple to use with almost all microcomputers.
- WELLER BOOKS**
- Practical Microcomputer Programming with the Z-80** by Weller 19.50
18 chapters of solid accurate programming information. Debugging techniques, interrupt modes, array and table handling, number base conversation, floating point arithmetic, programmed input/output stackpointer usage. The book includes an editor assembler listing for Z-80 and 8080. If you return the coupon at the back of the book you receive either paper tape or TRS 80 cassette of the object code for the assembler.
- HOWARD SAMS BOOKS**
- Microcomputer Primer** by M. Waite and M. Pardee 6.30
Written for the beginner in the computer field. All the basic concepts and characteristics of microcomputers are explored and explained.
- Getting Acquainted with Micros** by L. Frenzel 6.90
Learn about microcomputers in an effective low cost manner. The essential information contained in this book has been compiled especially for Engineers, Technicians and Scientists but is equally invaluable to the layman.
- Computer and Programming Guide for Engineers** by D. Spencer 9.10
Written specifically for the Engineer or Scientist, this book explains what a computer is, how it works and how it can be used to the best advantage. Details FORTRAN and BASIC programming.
- TTL Cookbook** by D. Lancaster 7.10
Discover what transistor-transistor logic is, how it works and how to use it. Discusses practical digital applications and teaches you how to build TTL systems that entertain test and train.
- CMOS Cookbook** by D. Lancaster 7.45
Your complete guide to the understanding and use of Complementary Metal-Oxide-Silicon integrated circuits. Gives usage rules, power supply design examples, applications, bread boarding and coverage of logic.
- TV Typewriter Cookbook** by D. Lancaster 7.20
A comprehensive guide to low cost television display of alpha-numeric and graphics data for microprocessor systems word processing, TV titling and video games.
- Cheap Video Cookbook** by D. Lancaster 4.90
A complete guide to super low cost alphanumeric and graphic microprocessor based video displays – this book picks up where the TV Typewriter Cookbook ended.
- How to Program Micros** by W. Barden Jnr. 6.90
Explains assembly language programming of microcomputers based on the 8080, 6800 and 6502 microprocessors. Basic concepts, number systems and operations, computer operation and codes are examined.
- Z-80 Microcomputer Handbook** by W. Barden Jnr. 6.90
This book provides essential information on Z-80 technology and is organised into three sections: Hardware, software and microcomputers built around the Z-80.
- Microcomputers for Business Applications** by W. Barden Jnr. 7.10
This book will prove invaluable to a potential buyer of a business microcomputer system – helping him to select the best system for his particular needs. The micros discussed range from spin-offs of hobbyist computers to complete "turnkey" systems with customised software.
- The S-100 and Other Micro Buses** by Poe and Goodwin 5.10
This book is about buses and after acquainting the reader with bus basics moves on to detail the eleven most widely used bus systems.
- BASIC Primer** by Waite and Pardee 6.90
This book is exactly what it says it is – on top of this it also includes 7 appendices to help you optimise your code for speed or memory use. Finally at the back is a reference card which you will keep in your pocket during the rest of your BASIC programming career.
- Z-80 Microprocessor Programming and Interfacing Volume 1** by Nichols and Rony 7.70
This book is the first of a two volume series on the Z-80. It covers programming at the assembly and machine language level for the Z-80. Book 2 will cover interfacing. The books are laboratory oriented texts. The strong emphasis is on learning through experiment. This book requires no background in computers.
- Z-80 Programming and Interfacing Book 2** 8.45
by Nichols and Rony
Address interfacing digital circuits with the Z-80 CPU, PIA and CTC chip and progresses on from Book 1 (Interfacing) assuming the reader is familiar with the topics covered in Book 1.
- Industrial Process Control System** by Patrick and Fardo 8.90
Process control procedures, system concepts, components, industrial applications and study questions in a logical text book.
- TRS-80 Interfacing** by J. A. Titus 6.90
Requiring a good understanding of Level II BASIC, this book describes the signals available in the TRS-80 computer and their applications to the control of external devices. Experiments in the construction and use of some typical interfaces are included.
- The Howard W. Sams Crash Course in Microcomputers** by L. E. Frenzel 10.60
Written in a teach yourself format with study questions, this book provides a solid background in microcomputers quickly and effectively. All aspects from fundamentals and operating systems to programming and peripherals.
- Computer Graphics Primer** by M. Waite 8.90
Instruction in the methods of producing drawings, plans, maps and schematics on a CRT display. In 3 sections, 'Perspectives', 'Basic Concepts' and 'Graphics Programming'.
- 6502 Software Design** by L. Scanlon 7.90
Fundamentals of 6502 operation are explained and then extended to give a comprehensive coverage of 6502 use.
- Z-80 Microcomputer Design Projects** by W. Barden Jnr. 9.10
A solid introduction to the Z-80 microcomputer and the EZ-80 chip. Simple construction of the EZ-80 microcomputer and several applications.
- BUTTERWORTH BOOKS**
- Basic BASIC** by J. Coan 6.45
One of the most widely sold text books on BASIC. The book uses over 100 example problems to illustrate the essential techniques of the language.
- Advanced BASIC** by J. Coan 5.95
Develops the readers expertise with BASIC through strings and files to graphing and more important mathematical functions.
- FORTRAN Fundamentals – A Short Course** by Jack Steingraber 3.40
A fast and efficient guide to FORTRAN – providing an abbreviated means of learning the language. Sample problems and their solutions are included.
- Programming for Microprocessors** by Andrew Colin (hardback) 3.40
This book has been written for those converting from other disciplines to the use of microprocessors. It is designed to allow fast progress to a useful working understanding of the application of microprocessors and includes sections on number representation.
- Sargon: A Computer Chess Program** by Dan and Kathe Spracklen 9.45
Here is the computer chess program that won first place in the first chess tournament at the 1978 West Coast Computer Faire. It is written in Z-80 assembly language using the TDL macro assembler. It comes complete with block diagram and sample printouts.
- The Systems Analyst** by J. Attwood (Hardback) 7.45
From the initial decisions whether or not to use a computer for a specific problem, to the actual installation of the completed system, the book covers the strategies, skills and techniques needed. Written without complex maths it is a step by step guide for people developing systems for the business world.
- How to build a Computer-Controlled Robot** by Tod Loofbourrow 5.90
Every step of the construction of "Mike" is explained with photographs and diagrams to direct you through the construction. The complete control programs for a robot are clearly written out. You may use the directions exactly as they are set forth in the book or as a basis for developing your own design. "Mike" can be built within the budget of the average hobbyist and the only technical requirement for building him as the ability to read and understand a circuit diagram.
- How to Profit from your Personal Computer – Professional, Business and Home Applications** by T. G. Lewis 5.45
Written for business people and computer hobbyists contemplating business applications, it shows how to put your computer to work for you. It describes common business applications such as accounting, handling payroll, managing inventory, sorting mailing lists and many others.
- FORTRAN with Style** 4.70
A little book to allow you to write professional and well laid out FORTRAN programs.
- BASIC with Style** 3.90
This type of book is sorely needed by us all as we develop our understanding of BASIC, so that we may adopt some of the disciplines needed to make robust readable programs.
- Game Playing with BASIC** by D. Spencer 5.45
A non technical book which includes an appreciation of the rules, structure and output for each example discussed.
- Sixty Challenging Problems with BASIC Solution** 5.90
Contains 60 games, puzzles, mathematical, science and business problems for reinforcing computer programming skills in the BASIC language.



Office:
14 CASTLE STREET,
LIVERPOOL L2 0TA.
Registered in England No. 1375098

Retail Premises at:
25 BRUNSWICK STREET,
LIVERPOOL L2 0PJ.
Tel:- 051-227 2535/6/7



BOOKS

Problems for Computer Solution 5.10
821 problems are arranged by topic ranging from mathematical disciplines to science and business.

DILITHIUM BOOKS

Instant BASIC by G. Brown 7.15

Here for the microcomputer enthusiast is finally a book to teach you BASIC which slowly introduces new ideas in a non-mathematical context. Interspersed with amusing graphics this book is fun to use.

Beginning BASIC by P. Chirlan 7.45

An introduction to BASIC for beginners written in response to the author's children's needs for a really basic BASIC.

Starship Simulation by R. Garrett 5.40

Simulation is the name of the game and it can be done on a small computer.

32 BASIC Programs for the PET Computer by Rugg & Feldman 9.70

32 BASIC programs for the PET computer is precisely that. 32 fully documented programs that are ready-to-run on your Commodore PET 2001 computer. You also have the option of making a number of changes, as suggested, to these programs if you wish.

Introduction to TRS-80 Graphics by D. Inman 6.40

For some time now, graphic displays on microcomputers have been out of the reach of hobbyists because of their complexity and high cost. In this book the author will show you how, with a minimal knowledge of the BASIC computer language and your TRS-80 computer, you can create graphic displays that only a few years ago were the exclusive turf of the big computer owners. The book begins with the basics and works from line drawings through geometrics and right on up to moving figure animation and more advanced operations. A great handbook on computer graphics for microcomputer owners at all levels of experience.

How to make money with your Microcomputer by Townsend & Miller 5.70

The microcomputer system can be used as a "lever" to multiply your income and it is a tool of great power. It can do many jobs the individual cannot do at all also process routine jobs in much less time that you could do them by hand. The possibilities only limited by your own creativity. This book will give a start with dozens on money making ideas.

MICROSOFT (TM) BASIC by Knecht 6.70

A tell it all book for TRS 80 users. It presents an introduction and tutorial on programming in MICROSOFT BASIC. The concepts presented are illustrated with examples that actually run. By starting with the simplest and most commonly used commands and then progressing onto the more complex instructions. The author illustrates how the more powerful versions of the BASIC language can save time and effort. Only an understanding of Computer fundamentals is required for the users of this book and the language is applicable to most small systems including the Apple and the PET.

Peanut Butter and Jelly Guide to Computers by Jerry Willis 6.15

This book is a welcome relief from the jungle of jargon and technical terms which seem to thrive like twitch grass in the garden of personal computing. It is a book rich with details you need to know and written in a style which is easy to understand. It is an important book for the beginner to be read first. It also has a wealth of information for the expert.

COMPUSOFT BOOKS

Learning Level II BASIC by David Lien 11.00

This is the second excellent book by Compusoft Publishing in California. No TRS-80 owner can afford to miss this one.

The BASIC Handbook by David Lien 11.00

This is a machine independent reference text for the BASIC on most personal computers. It also shows the syntax for the new ANSI standard BASIC. It is the only book of its kind in print at present.

MISCELLANEOUS

Best of Micro - Volume 1 5.45

Micro is the best known and most widely read of the specialist journals dealing with the 6502 microprocessor as used in the PET, Apple, Aim, OSI, Computhink Minimax, etc. "Best of Micro" is a bound version of the first six issues.

Best of Micro - Volume 2 6.45

This is the bound version of the second six issues of Micro up to mid 1979.

The Mighty Micro by Chris Evans 5.75

This is the book written out of the well-known ITV series giving a more positive view perhaps than Adam Osborne's book.

SIGMA BOOKS

Computer Programs that Work by Lee, Beech and Lee 3.95

This book contains twenty four programs in BASIC in the areas of biology, mathematics, chemistry and physics and includes simulations of real-life situations and popular games.

Z-80 Instant Programs (Nascom) 7.50

These machine code routines can be entered in to a Z-80 system etc. and are applicable to even the smallest machines. The routines average 1000 instructions.

NEW TITLES

Programming and Interfacing the 6502 8.90

Pascal with Style 4.70

Robots on your doostep 5.70

A-Z of computer games 5.30

BASIC Cookbook 3.90

Basic Digital Electronics 3.90

Build your own working robot 4.60

Digital Interfacing with an Analog world 6.45

How to Build your own Self-Prog. Robot 5.30

How to Design and Bld. Your own working comp. System 5.70

How to Build your own working robot PET 4.90

How to Build your own 16-bit Micro 3.20

Illustrated Dictionary of Micro-Terminology 5.70

Introduction to VLSI Systems 10.90

Microprocessor Cookbook 4.60

Modern Digital Communications 5.90

Modern Guide to Digital Logic 5.70

Programs in BASIC for Elec. Eng. Tech. and Exp 4.30

57 Practical Progs. & Games in BASIC 5.70

Programming Microprocessors 4.90

24 Tested & Ready-to-run Games & Prog. 4.70

Artificial Intelligence 5.30

Complete Handbook of Robotics 5.70

6502 Cookbook 7.70

Z-80 Instruction set 3.10

6502 Games 8.90

Pascal for PET 8.95

Computer in Maths 10.90

TRS 80 Disk & Other Mysteries 11.90

Micros & the 3R's 5.90

Some Common BASIC Programs/Pet (Osborne) 8.90

PET Personal Computer Guide (Osbourne) 10.45

Practical BASIC Programs (Osbourne) 9.90

Introduction to T-Bug 6.20

The BASIC Workshop 4.90

Introduction to Structured FORTRAN 9.20

Microcomputer Systems Principles Featuring 6502/KIM 9.20

Microprocessor Systems Engineering 14.90

Fundamental Principles of Micro-Architecture 14.90



Office:
14 CASTLE STREET,
LIVERPOOL L2 0TA.
Registered in England No. 1375098

Retail Premises at:
25 BRUNSWICK STREET,
LIVERPOOL L2 0PJ.
Tel:- 051-227 2535/6/7



LIVERPOOL SOFTWARE GAZETTE

The Bi monthly Magazine for the computer user.
Only 75p a copy. Subscription £9.00 for 12 issues.



Issue 1
Sargon meets the Nascom
Pets Corner
Programming Practices and Technics
M5 system – and interpreter for the Nascom One
I'm Pilot fly me
Apple Pips
Acorn Mastermind
Pascal bytes the Apple
Random Rumours

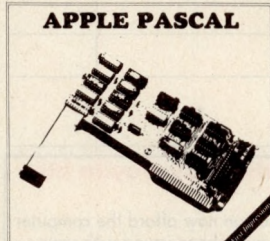

Issue 2.
Dungeons & Dragons revisited
Numerical Accuracy of Microcomputers
Cesil – an introduction
Acorn and the Kim
Z-80 Processor Profile
Revas & Zeap
Application software for Microcomputers
Pets Corner
Nybbles
Chess for the Acorn
Etcetera
Surround
Apple Pips
A hex on you
Programming Practices and Technics
Trekking by 'JTK'
Nascom Notes
Bytting more off your Disk
Stop Press

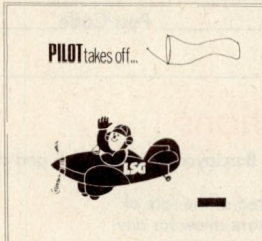

Issue 3
Pets Corner
Nascom Notes
Apple Pips
Aim 65 Assembler
Graphic shape scaling
Pilot takes off
Letter from America
Pascal – An introduction
Programming Practices and Techniques
Algol 68C on the Z80
Microcomputer and Bio-chemistry
Sharp machine language
Super sort
Software and Acorn
Numerical Accuracy
Etcetera



Issue 4
Star Gate
Sharp point
Letters to the Editor
Pets Corner
Apple Pips
Nascom Notes
Jet set
6800 Processor Profile
A forth Introduction
Pascal An Introduction
A Beginners Introduction to Pascal
A Useful Pascal Program
A Marvel called the MC6809
A Number Processor on the Acorn
Architectural Software on the Cheap
Commercial Micro Software Fundamentals
Graphics Shape Translation
Future Soft
Programming Practices
Etcetera

Please send me twelve issues of the Liverpool Software Gazette starting with the first/second/third/fourth/fifth/sixth * issue. Cheques and PO's should be made payable to Liverpool Software Gazette and sent to us at 14 Castle Street, Liverpool.

Name

Address

Postcode

*delete as applicable.

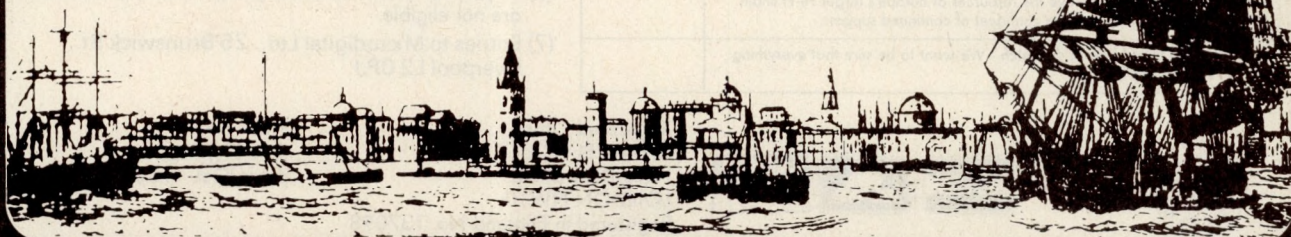



Microdigital Mail Order Form

Date:

Access: 5224

Barclaycard 4929

Expiry date:

Name _____

Address: _____

Post Code _____

Tel (day) _____

Goods required	Price
1	
2	
3	
4	
5	
6	
7	
8	
Total	

Terms and Conditions

In addition to cash we accept, Access, Barclaycard, Stereo Club and cheques covered by a bankers card.

VAT in this brochure has been calculated at the rate of 15% current at the time of writing. Please allow for any changes.

Postage and carriage is offered free of charge within the United Kingdom. All products are covered by our 1 year warranty against failure due to faulty materials or workmanship.

Official orders over £10 are welcome, with normal 14 days credit extended to bona-fide commercial Organisations.

All prices, specifications and terms are subject to change without notice at the discretion of the management.

The entire contents of this brochure are copyright Microdigital Limited 1980.

Laskys Stereoclub – the easy way to buy from Microdigital.

Laskys Stereoclub means you can now afford the computer you've always wanted. Once you've been issued with your Stereoclub card you get instant credit right up to your limit – 24 times your monthly payment. For just £5 a month, for instance, you would get credit up to £120. And you can add to your Stereoclub account all your accessories as and when you need them. Ask Microdigital for your application form.

Mail Orders to:
 MICRODIGITAL LIMITED
 FREEPOST (No stamp required)
 Liverpool L2 2AB

24 Hour – 7 Day
 ANSAPHONE SERVICE
 on 051-236 0707

Microdigital Free Competition

Place the following points in their order of importance. (Nos. 1 – 12) and then say in no more than 12 words "Why buy from Microdigital?"

Wide Range:- Microdigital sell machines selected for quality and value for money from the smallest computers to big commercial systems.	
Competitive Prices:- The advantages of our buying power and experience are passed on to our customers.	
All plugs & Leads free:- We sell a computer as a ready to run complete system with all connectors necessary.	
12 months guarantee:- Most microcomputers sold in this country come with a 90 day guarantee. We give a full parts and labour guarantee for a full year.	
Access/Barclaycard/Stereo Club:- Alternative ways to finance your computer. Laskys stereo club provides flexible easy credit.	
Free delivery:- Anywhere within Mainland U.K. There is no extra hidden charge when you buy from Microdigital.	
Specialisation:- All our resources are put into Microcomputers, nothing else. We know what we are best at.	
14 days credit:- On official orders from bona-fide commercial and government organisations (subject to credit clearance). Makes buying easier.	
Fast, Friendly Service:- Our expert staff look after our customers first and our large stocks ensure good availability of everything we sell.	
Freepost:- It costs nothing for you to write to us, an extra service to make life easier.	
A Lasky's Company:- We have the resources of Europe's largest Hi-Fi chain behind us. The customer can be confident of continued support.	
All equipment tested before despatch:- We want to be sure that everything we sell works when it should.	

Name _____

Address _____

In 12 words: Why buy from Microdigital?

Rules

- (1) Only one entry per person.
- (2) The competition will be judged on November 14.
- (3) All entries should be received by November 7th.
- (4) The decision of the judges is final.
- (5) In the event of a tie the winner will be decided by the best slogan.
- (6) Employees of the Ladbroke group and this publication are not eligible.
- (7) Entries to Microdigital Ltd., 25 Brunswick St., Liverpool L2 0PJ.



Registered Office:
 CHANCEL HOUSE,
 NEASDEN LANE,
 LONDON NW10.
 Registered in England No. 137098

Prices correct at
 time of going to
 press (Oct. 1980)

COMPUTER GAMES

David Levy continues his historical survey of the most important milestones in mainframe chess programming.

The first program of the modern generation was written at MIT by Richard Greenblatt, a student, and two colleagues. Work on the program began in November 1966 and by April the following year it had scored two wins, two draws and no losses in a tournament with human players. Based on statistics given in Greenblatt's paper, I would estimate that his program, at that time, was stronger than any commercially available chess machine currently on the market. The name of his program was MacHack VI.

MacHack employed a plausible move generator containing some 50 heuristics. The program was intelligent enough to know that certain heuristics were not always applicable, but depended on the nature of the position. In this way, moves selected by the plausible move generator were not always exactly the same set of moves as those which would have been chosen by a linear evaluation function. From this aspect of MacHack's decision process the micro-programmer can learn an important trick — it is often useful to use one evaluation mechanism (or set of heuristics) to select the plausible moves for the tree, and another one for performing the evaluation of terminal nodes.

The plausible move generator made its decisions by considering the moves themselves, rather than the positions arising after the moves were made. For example, if a move is bad because it blocks the line of attack of another of the player's pieces, the program would recognize the fact rather than look at the resulting position and say to itself "Hey! This position is bad because my bishop is blocked." By accepting or rejecting moves for the plausible move list in this way, the program saved a great amount of computation.

During the plausible move computation, each square of the chess board was assigned a measure of importance, corresponding roughly to the estimated value of having an extra piece attacking that square, or the cost of moving away a piece which currently attacked that square. The most important criteria used for assigning these values included

how near the square was to the centre of the board or to the enemy king, and whether or not the square was occupied by one of the program's pieces under serious threat.

The value of a piece in strategic terms (as opposed to its actual material value) was related to the number of squares it attacked ie its mobility, and to the number of enemy pieces that it attacked. These strategic values were computed for the piece in its old and new locations and a strategic gain was taken as an indication that the move should be on the plausible move list. In other words, if a move appears to put a piece on a better square, that move is worth further examination.

The program encouraged certain types of attack on squares that were considered possible weak points, for example weak pawns, pinned pieces, and pieces defending other pieces. Moves which fell into these categories were also added to the plausible move list.

MacHack performed an alpha-beta search, with forward pruning. The plausible move generator would select a number of moves at each level of lookahead, and add to this number any moves which satisfied certain conditions: all safe checks were examined; at the first and second plies all captures were investigated; the moves of a certain number of distinct pieces are examined, so that the program would not ignore most of the board if all of the moves of a single piece were highly plausible. The minimum number of moves selected by the plausible move generator was normally six at each level of lookahead, but in tournament mode, ie when playing at a rate of 2-3 minutes per move, the program would examine a minimum of 15 moves at the first two ply, nine moves at the next two ply, and seven moves at each subsequent level. Only when the minimum number did not exist (for example when one side was in check or had only its king on the board) would the search be narrower, though of course the alpha-beta algorithm would often prune away branches on which there were plausible moves.

One of the few advantages that mainframe programmers have over those writing for a micro, is the availability of enormous backing store. This enables a program to employ transposition tables, which are advantageous in preventing the program from evaluating the same position more than once. In chess, as in many other games, it is frequently possible to reach the same position by different routes, and we call this phenomenon transposition. As a simple example, if White makes move A, Black makes move B, and White then makes move C, we shall reach the same position as if White had made his moves A and C in the reverse order. MacHack produced a hash value for every position evaluated in the tree search, and together with this value the program stored the score for the position and a note of the depth of search at which the evaluation took place. If the position is created again during the search, the program would not recompute the score for the position but would take it from the value scored together with the hash for that position. Even though MacHack stored only 32,000 positions in hashed form, it was able to save considerable computation time and as a side benefit, it was quickly able to detect draws by repetition.

The MacHack program represents the first really significant milestone after Shannon's paper because it was the first program to make good use of the Shannon-B strategy. The strength of the program in 1967 was extremely impressive and created considerable publicity for computer chess among the computing and chess fraternities. This publicity served as the impetus for many of the groups which started programming around 1967 or 68, for example the Slate/Atkin/Gorlen group at Northwestern University and Newborn at Columbia University. In fact Greenblatt and his colleagues probably did as much for computer chess in 1967 as Shannon had done almost 20 years earlier.

I should like to offer you two examples of the playing strength of the Greenblatt program. The first is a position which was shown to several

strong American chess players, including Masters, and defeated a number of them.

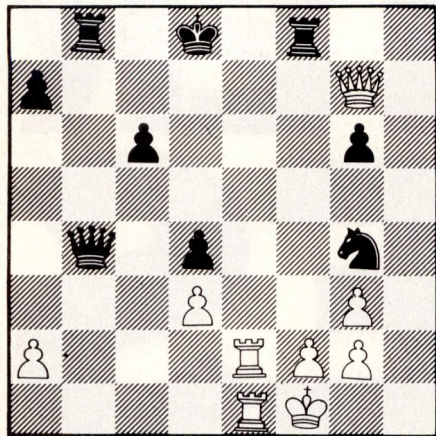

Black to play

This position is a win for Black, who has an extra knight for a pawn. But the task is to find a quick win. If White is allowed to survive he might conjure up counterplay based on the exposed position of the black king and the weakness of Black's pawns on g6 and a7. How can Black force a quick win?

MacHack discovered the correct continuation:

1 ... f8-f2+

For the program to play this move it must have been able to see 9-ply ahead, in the crucial variations.

2 f1-g1

The alternative was 2 e2-f2 g4-h2+ 3 f1-e2 (or 3 f1-g1 b4-e1+ 4 g1-h2 e1-f2, when Black is a rook ahead) 3 ... b4-b2+ 4 e2-d1 b2-b1+ 5 d1-e2 b8-b2 mate.

1 ... f2-e2

3 g7-h8+ d8-c7

4 h8-f6 e2-e1+

5 Resigns

To show that a computer program is a good chess player, it is not enough to give an example of its tactical prowess. The very best programs are extremely adept at tactical combinations but are often let down by their poor strategic understanding. So the proof of the whole pudding must lie in an examination of complete games. The following is the first game ever won by a computer program in a chess tournament. Its opponent was rated 1510 on the USA rating scale, equivalent to a weak club player. The game was played in the Massachusetts State Championship, 1967.

WHITE: MacHack VI

BLACK: Human

1 e2-e4 c7-c5

2 d2-d4 c5-d4

3 d1-d4

MacHack knew no openings at that time and plays very much as many of today's commercially available machines. This type of opening is bad for White because it allows Black to bring out his pieces 'free of charge', by using developing moves to harass the white queen.

3 ... b8-c6

4 d4-d3 g8-f6

5 b1-c3 g7-g6

6 g1-f3 d7-d6

7 c1-f4 e7-e5

A dubious decision. The human was obviously worried about the possible advance of the white pawn from e4 to e5, but Black should have continued 7 ... f8-g7, and if e4-e5, then f6-h5,

attacking White's bishop.

8 f4-g3 a7-a6

9 e1-c1 b7-b5

10 a2-a4 f8-h6+ ?

An ineffective move that weakens an important central pawn. One gets the impression that the human felt he could take risks against MacHack.

11 c1-b1 b5-b4

12 d3-d6

Black, when making his tenth move, almost certainly overlooked the fact that on the d6 square, White's queen or rook will fork the two black knights on f6 and c6, thereby rendering harmless Black's threat to the white knight on c3.

12 ... c8-d7

13 g3-h4 h6-g7

14 c3-d5 f6-e4

15 d5-c7+

Black may have overlooked this response, but in any event his position was hopeless.

15 ... d8-c7

16 d6-c7 e4-c5

17 c7-d6 g7-f8

18 d6-d5 a8-c8

19 f3-e5 d7-e6

20 d5-c6+

MacHack spots a simple queen sacrifice that forces mate.

20 ... c8-c6

21 d1-d8 mate

A benchmark chess program

It is perhaps worth mentioning in passing the work performed by Jim Gillogly during the early 1970s on a program designed as a benchmark for other chess programs. Gillogly's program, which he named TECH, had a very simple program structure which could easily be emulated by anyone using a micro. Rather than perform strategic evaluation on all terminal nodes in the tree, the TECH program only took a close look at the nodes at the first level of look-ahead. It evaluated all these positions, sorted them into order and only changed this order if a full-width search revealed the forced win or loss of material for a root move. Programs with such a structure can play perfectly recognisable chess and are tactically quite satisfactory but they are hindered in their overall playing performance by a lack of strategic depth.

Those of you wishing to start writing chess programs for your own machines could do a lot worse than employ Gillogly's approach. Because strategic evaluation is only carried out on the (say) 30-40 root moves, the program can perform quick full-width search, using the alpha-beta algorithm, to detect forcing variations that affect the material status of the board. Such a program is relatively easy to write and should perform at roughly the same level as a Chess Challenger, provided that your strategic evaluation function is well thought out.

Gillogly argued that to be of any real merit, a chess program must be able to play better than a TECH type program, given the same amount of time, because the TECH program did not do anything clever. A really good programmer could probably write a TECH type program in little more than 2k of code (assembler) and I would not be surprised to see a program of that size playing better chess

than some of the 8k and 16k cassette programs available to personal computer users today.

Deep or shallow search

Not entirely unconnected with the previous section is the question of how essential it is to search the game tree as deeply as possible. There are two distinct schools of thought on the subject: programmers usually prefer to search as deeply as possible, on the grounds that they are more likely to notice neat tactical possibilities; but a minority believe that shallow search, with more attention being devoted to each node, can lead to equally good play. Since human chess players look at a very small tree, this second approach is clearly endowed with some merit, but most chess programmers prefer the exhaustive search technique, possibly because of a lack of confidence in their own ability to create an advanced evaluation function that would be sufficiently sophisticated to perform drastic forward pruning.

Up to now almost all of the world's strongest programs have been the 'brute force' type — searching enormous trees but performing relatively little sophisticated evaluation at the terminal nodes. The TECH program is possibly the supreme example of this genre, performing only a material evaluation at the terminal nodes. We do not yet have sufficient experience with intelligent chess programs to be able to determine which approach is superior but I hope that the following game, despite exhibiting rather passive play by Black, will convince the reader that brute force is not the only possible route to a master strength chess program. For those programming chess on a micro, the intelligent approach offers much scope for original research and I would like to hear from readers who have any interesting or fresh ideas on this subject.

This game was played in a computer tournament in Dortmund in 1975.

WHITE: Schach MV 5.6

BLACK: Fischer/Schneider

1 b1-c3 d7-d5

2 d2-d4 c8-g4

3 f2-f3 g4-f5

4 e2-e4 d5-e4

5 f3-e4 f5-d7

6 g1-f3 b8-c6

7 e4-e5 e7-e6

8 c1-g5 f8-e7

9 d1-d2 g7-g6

10 f1-d3

So far Black has played rather passively, but White has developed its pieces on sensible squares. White's latest move is, in fact, a mistake, which should lose a pawn to 10 ... c6-d4 11 g5-e7 d4-f3+ 12 g2-f3 g8-e7, but Black was unable to see this far.

10 ... b7-b6

11 g5-e7 g8-e7

12 e1-c1 e8-g8

13 d2-h6!

Immediately beginning an attack against the black king. The threat is f3-g5, followed by h6-h7 mate.

13 ... e7-f5

14 d3-f5 g6-f5

15 f3-g5 d8-g5+

Giving up the queen was the only way to prevent mate. If 15 ... f8-e8

16 h6-h7+ g8-f8 17 h7-f7 mate.

16 h6-g5+ g8-h8

17 g2-g4

A fine move, opening up other lines of attack to the black king.

17... f5-g4

18 g5-g4 f7-f5

19 g4-h4 f5-f2

20 c3-e4

Here comes the other knight.

20... f4-f3

21 e4-g5 f8-f7

Again the only way to prevent mate on h7.

22 g5-f7+ h8-g8

23 h4-f6 f3-f2

24 f7-h6 mate

It would be reasonable to deduce, having played over this game, that the program playing the white pieces had a very good idea of what it was doing; that it planned a king-side attack from early on and then executed this attack in a well planned manner. In fact, White did not employ any look-ahead whatsoever. All of its moves were found as a result of a one-ply search. Its king attack feature was obviously well designed but there was no tree search — the planning was all implicit in the evaluation function. This should provide some idea of just how much can be achieved without a deep look-ahead and I hope it will encourage some of you to write intelligent programs rather than programs which perform brute force searches of large trees.

The northwestern program

To conclude this survey I shall give a brief description of the famous program, written at Northwestern University, by David Slate, Larry Atkin and (in the beginning) Keith Gorlen. This program has won most of the important computer chess tournaments of the 1970s, and the interested reader would do well to read a more detailed account of this program, which may be found in Peter Frey's outstanding book *Chess Skill in Man and Machine*.

The Northwestern University program, whose successive generations have been named CHESS 2.0, ... CHESS 3.0, ... CHESS 4.0, ... CHESS 4.9 (the first digit represents a working generation, the second digit is a version within that generation), was born in 1968. When the first computer chess tournament took place in 1970, the program proved itself to be the strongest and it maintained this reputation for most of the decade.

Occasionally another program would win an event ahead of the Northwestern program but such occurrences were the exception rather than the rule. At the time of writing, this program holds the title of World Computer Champion, which it took from the Russian KAISSA in 1977. The forthcoming World Championship contest in Linz, Austria (25-29 September 1980) will probably be the toughest event in which the program has participated and we may even see a new title holder.

Much of the program's power is due to its great speed. The programmers have devoted much effort to the speeding up of essential processes such as legal move generation and to this end

the program maintains a data base which includes, among other things, a list of every square attacked by each piece. This list is updated whenever a move is made in the game tree, and by updating it rather than recreating it, the programmers reduce the time taken to provide the attack and defence lists for the newly-created position. The program also uses a hash table for transpositions, as described in the section on Greenblatt's work.

For some time, the Northwestern program employed a plausible move generator to restrict the number of nodes in the game tree but various reasons prompted the programmers to change to a full width search. One of the prime reasons for doing so was the fact that they noticed certain moves, which appeared good when examined to a depth of (say) 5-ply, but which ranked too low at the root of the tree to be included in the first plausible move list. Chess masters are not faced with this problem because their plausible move generator is much more sophisticated and accurate and I suspect that the chess programs of the future may return to the plausibility approach, unless brute force searching produces an electronic chess master within the next 2-3 years.

The program's evaluation function contains a number of terms which quantify the best known chess heuristics. Material is measured in such a way as to encourage the side that is ahead in material to exchange where possible and to discourage the exchange of material if the program is losing. Another feature gives a bonus for attacking enemy pieces and this bonus is enhanced when an enemy piece is doubly threatened.

Pawnstructure is an important feature of the game of chess at higher levels of skill and any program which aspires to master strength must understand the finer points of pawnstructures. If your pawn formation is rotten your whole position is eventually liable to crack under pressure. This program considers doubled pawns (two or more pawns of the same colour on one file); isolated pawns (pawns that cannot be supported by pawns of their own colour); backward pawns (pawns which do have adjacent friendly pawns, but which are less far advanced than its neighbours); passed pawns (those which have no enemy pawn impeding their progress to the eighth rank); and advanced pawns.

Knights, bishops, rooks and queens are given bonuses according to the values of the squares they attack, particularly if the squares are near the enemy king or the centre of the board. Rooks are given bonuses for being situated on open files or on the seventh rank (a rook on the seventh rank usually poses a serious threat to enemy pawns which have not yet moved). The kings are discouraged from moving towards the centre of the board, except in the end-game, and there is a safety feature which determines whether or not a king is well sheltered by its own pieces.

The tree searching routines employ all of the techniques that we have encountered in previous articles: the alpha-beta algorithm, with a 'window', killer moves, etc. In fact the Northwestern program provides us with an

excellent illustration of the power of all these neat tree searching tricks — it plays better chess than more than 99.5% of the world's chess playing population and has even won some quick games against International Masters and Grandmasters. These outstanding results have been achieved more through the effects of a cleverly programmed brute force search than as a result of the program's chess knowledge, which is still primitive. The success of the program shows good programming is even more important than an advanced knowledge of the game, when producing a program of the strength currently being exhibited by microcomputers. Certainly it will be necessary for a human chess expert to be involved in the programming of an electronic Grandmaster but there is absolutely no reason why the readers of this column should not write a program that can play respectable chess.

To illustrate the prowess of the Northwestern program I shall offer you the following game, which was its first ever win over a human Grandmaster. The game was played at blitz speed, which requires each player to make all of his moves within five minutes. In fact the rules were slightly different for the two participants — Stean was playing in real time but the program was permitted a total of five minutes for CPU time and satellite transmission time, with no penalty for the time taken by its human operator to move the pieces.

WHITE: CHESS 4.6

BLACK: Stean

1 e2-e4 b7-b6

2 d2-d4 c8-b7

3 b1-c3 c7-c5

4 d4-c5 b6-c5

5 c1-e3 d7-d6

6 f1-b5+ b8-d7

7 g1-f3 e7-e6

8 e1-g1 a7-a6

9 b5-d7+ d8-d7

10 d1-d3 g8-e7

11 a1-d1 a8-d8

12 d3-c4 e7-g6

13 f1-e1 f8-e7

14 c4-b3 d7-c6

15 g1-h1

It is peculiar moves such as this one which make it possible to recognize the play of a computer. A strong human player would never move his king onto a diagonal occupied by his opponent's queen and bishop, unless it was forced.

15... e8-g8

16 e3-g5 b7-a8

17 g5-e7 g6-e7

18 a2-a4 d8-b8

19 b3-a2 b8-b4

20 b2-b3

If we sum up what has happened so far, it is clear that Black has a dominating position. His pawns control the centre while White's e4 pawn attacks only one central square. Black's pieces are active, White's are passive. But the program has one important advantage — its opponent thinks that to all intents and purposes the game is over and he tries to take the program's position by storm. This is exactly the opposite of the way one should play against a strong program — the tactical search will reveal tricks that the human misses, especially at this breakneck speed.

20... f7-f5?

GOTO page 123



COMPUTER ANSWERS

I need consultants to answer questions on the TRS-80 and CompuColor, with thorough experience of machine code programming, the disk operating systems and the hardware of these machines. Please write to me, Sheridan Williams, at 35 St. Julian's Road, St. Albans, Herts, stating your experience. A reminder to readers that personal replies can only be given to Computer Answers if an SAE is enclosed. Send your questions to me at the above address.

Lab system

We need a micro computer in our laboratory which could run any of 20 or so fairly simple (but not necessarily short) programs at short notice and frequent intervals during the day. At the same time we would like to use it to teach people to program in Basic in preparation for the time when we have a terminal running into our in-house mainframe. Ideally the microcomputer could then be used as a terminal. We could find £1000, or maybe up to £1200 for the complete micro-system (excluding printer). Have you any suggestions as to suitable equipment?

Name and address supplied.

It's a great pity that you can't afford another £1000, for the Hewlett Packard 85 is almost what you are looking for, except for the ability to use it as a terminal! And even that might come by next year. Short of the HP 85 I would think, from your need to change from one program to another frequently and at short notice, that cassette storage would not be very suitable. That's a pity, for faster means of loading are much more expensive, generally speaking. Providing even one 5¼" floppy disk drive and controller is probably going to use up the best part of half of your £1000. Which doesn't leave much for the computer itself, let alone a VDU, monitor or TV set. An Apple with a single drive would just about do it, but if you needed to buy a TV set or monitor you would be well into your upper figure of £1200. An Ohio Challenger C2 with disk would work out at about the same kind of figure. You could get a 16k TRS-80 model 1, level II, with expansion interface, single disk drive, and monitor at about the £1000 level. This would certainly be capable of later upgrading for use as a terminal, albeit at extra cost. Another approach would be to concentrate on the eventual situation and start off by getting a VDU terminal with keyboard and RS232 interface. This would again take

about half of your available funds. As you would still need both a computer and fast storage and retrieval facilities, how could it be done with disks access at £500? The answer could lie in the Stringy Floppy, made by Exatron in the USA, which has only just come to notice in the UK. By using a special cassette with an endless tape this device gives much faster, and apparently more reliable, program loading than ordinary cassettes, although it's not as fast as disks (see PCW Vol 3 No 6). A single drive and controller for a TRS-80 costs about £200 in this country and you might be able to get a 16k TRS-80 for the remaining £500 or so. Alternatively, you could think of an expanded Microtan 65 with the Tanex board to give the RS232 interface, or wait until September when the Newbrain is scheduled to be available — this will include the necessary RS232 port as standard, and, like the Microtan 65, should be able to interface the Stringy Floppy.

There are bound to be other permutations and combinations, and there is also the large field of second-hand equipment, not only micro-computers, but also possibly older types of mini-computers.
P McIlmoyle

USPET

I am going to the USA for a short trip and at the same time feel like getting either a 16k or 32k PET. I will be

staying in New York — could you advise on the possibility of getting a PET there and an alternative (if any). I am planning to take \$ 1500 for the PET — should this be enough?
Tunde O Osibubi, Chatham, and I Harwood, Welwyn Garden City

You should have no difficulty at all in getting a 16k or 32k PET in New York, but you may have difficulty in getting it back to the UK! Not only is it fairly heavy, due to the built-in screen and metal case but the box is an awkward shape to carry very far. \$ 1500 should adequately cover the price, bearing in mind the very much lower prices current for personal computers in the US and assuming that you just want the PET itself without expensive extras such as disk drives or a printer.

Alternatively, you could consider the Apple II, the Tandy TRS-80 Model 1, level 2, and the Exidy Sorcerer. The first and last of these don't include a screen or monitor as standard so would be easier to carry; the TRS-80 Model 1 usually includes a monitor screen. In this country it is also sometimes available as just the keyboard unit, without the screen. I'm not sure if it can be bought in the States in this form, but this could be worth looking out for.

Apart from the problems of actually carrying your computer home there are a number of other points to bear in mind. Equipment sold in the US is designed to oper-

ate on 110 volts, 60 Hz mains supply. The voltage is fairly readily taken care of by using a transformer to reduce the British 240 V to 110, but the frequency is another matter entirely. The difference is unlikely to stop your computer from running, but it often leads to a very unsteady display on the monitor screen. Talking of screens, it's worthwhile bearing in mind that the American colour TV system is very different to ours (they use NTSC, we use PAL), and an Apple II from the States will not give true colours when used with a British colour TV as monitor.

Don't forget that there will also be a number of other costs: there's the transformer, mentioned above, a TV set or other monitor, and probably a cassette recorder, unless you make use of existing equipment. But there will be more to pay before you ever get your computer home: there could well be an excess baggage charge from the airline, assuming that they will be prepared to carry the extra baggage, and, whatever model you have chosen, there will be not only VAT (at 15%) to pay before you can get the machine into the UK but also Customs duty at about seven percent. And please don't try to take a computer through the Green Channel; it's very likely to be spotted and you run the risk of not only a hefty fine but also of having your computer permanently confiscated!

If you end up having your purchase sent on to the UK rather than carrying it over

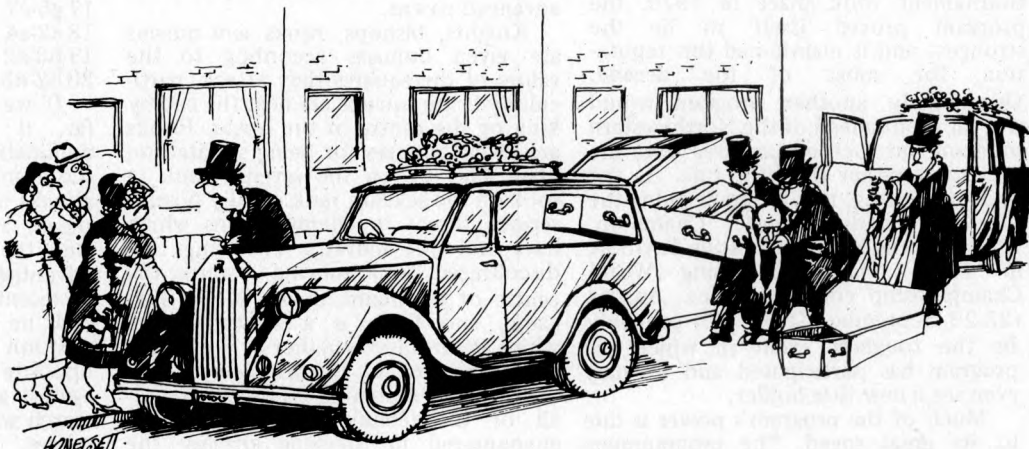

"I'm most terribly sorry about this, Mrs Kewbeer, we've had no end of trouble since we installed a computer in the office"

TEMPLEMAN SOFTWARE LIMITED
 25-26 Greenhill Street, Stratford Upon Avon
 Warwickshire CV37 8LR
 Telephone: Stratford Upon Avon (0789) 66237

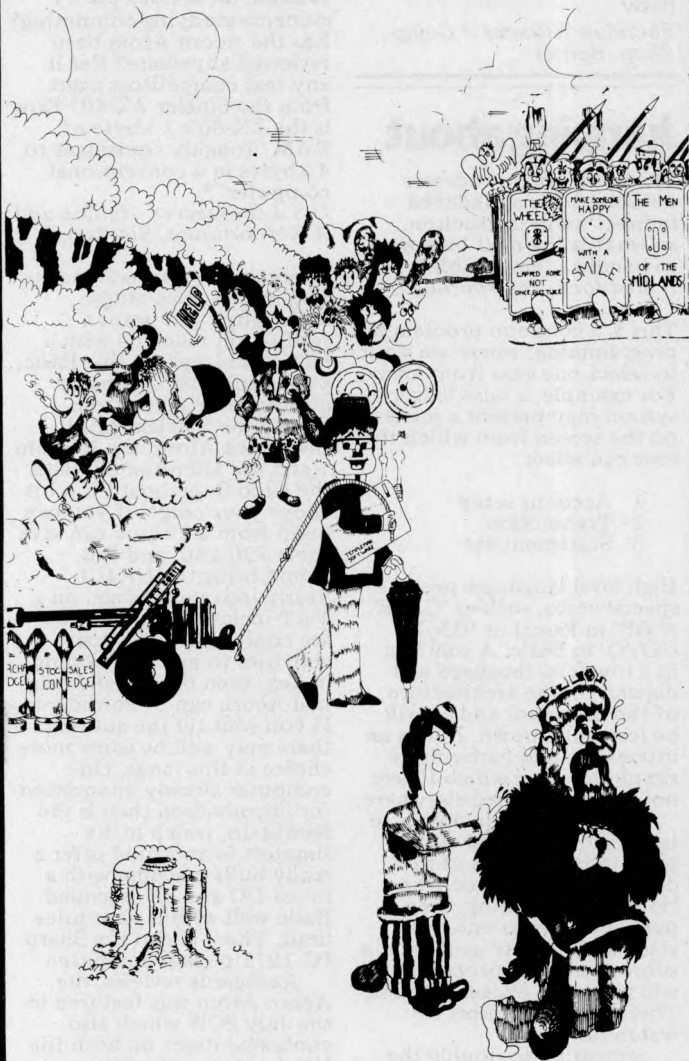

"DON'T BOTHER ME NOW, CAN'T
 YOU SEE I'M WORRIED!"

8" FLOPPY DISC DRIVES £1500
 (exc VAT)
 SALES LEDGER, STOCK
 CONTROL, INVOICING,
 PURCHASE LEDGER, NOMINAL
 LEDGER. ALL THESE PROGRAMS
 SHOULD BE AVAILABLE FROM
 YOUR LOCAL ITT/APPLE DEALER.

or visit us at the
 WHICH BIKE COMPUTER SHOW
 STAND 332. 25th-28th NOVEMBER
 NEC BIRMINGHAM
 Telephone for complimentary tickets

SOFTWARE IS OUR MIDDLE
 NAME

COMPUTER ANSWERS

yourself you will also have to pay for a freight agent to clear it through Customs for you.

If it were me, I would certainly look for something more portable than a PET, quite possibly an Apple. But, bearing in mind that you can buy a 32k PET in this country for under £680 (plus VAT), which is very close to \$1500 (plus VAT), I would be very inclined to buy my machine here. At least it would make servicing much easier and avoid the electricity supply problems. Of course, if you were to find that PETs were very much less than \$1500, that would be another matter.
P McIlmoyle.

Sorting references

Please will you give me references for further study of the 'Quicksort' that you mentioned several months ago? The whole area of sorting fascinates me.

I had dozens of letters asking this question so here goes:
 Knuth, D E: *The Art of Computer Programming Volume 3*, Addison-Wesley, 1973, pp 86-95, 289; Lorin, H: *A Guided Bibliography to Sorting*, IBM systems journal 10, No 3 (1971) pp 244-254; Van Emden, M H: *Increasing the Efficiency of the Quicksort*, Comm ACM 13, No 9 (1970) pp 563-566, 693; Wirth, N: *Algorithms + Data Structures = Programs*, Prentice Hall, Ch 2.

Probably the best starting point is the last book, which I used. Both this and Knuth are very expensive (over £14) ask your local library to get the books for you — use your library more as they are only too pleased to help.
Sheridan Williams

Unadventurous games

I'm bored stiff with computer games that involve killing Klingons, Robots, Piranhas, Space Invaders, Androids, and who knows what else. I'm also bored with computer versions of chess, Othello, draughts, pontoon etc. What's next, other than suicide?
J James, Slough

How about a game called 'Adventure'? There are dwarves, dragons, trolls, pirates, snakes and other nasties in this game and it's up to you whether you kill them or not. As you have this aversion to killing perhaps you could try 'stroking' them instead.

Adventure is a totally different type of computer

game, unlike any that you will have seen already. Before you get too excited, there might not be a version available for your machine, and even if there were it would not be worth getting unless you had disks. Still we can dream; let's assume that it is available for your machine. Here's an analogy: If you think of most computer games as 'films' then Adventure can be likened to a 'book'. In a film you are given very little chance of fantasising, but with a book you can conjure up your own mental pictures. Adventure is like that. It is an adventure story that you can control, the object being to find your way into a cave system and collect lots of hidden treasure. The more you collect the greater your score. Along your journey a great many things can happen and you must find the correct course of action to proceed. Before you think 'yawn' I must tell you that when I tried Adventure it totally ruined a whole weekend. I started playing at 10am on Saturday and apart from about six hours' sleep, I was still playing at 1130pm on Sunday night! And I still only scored 200 out of 380. In other words, I had only covered just over one half of the cave system and this was only a small version of the game. The versions I have used are on a PDP11 and an RML 380Z. If you can get a copy then jump at the chance.
Sheridan Williams

ZX80 chips

I have ordered a Sinclair ZX80 in kit form and I am slightly confused regarding RAM memory. I have found out that the ZX80 uses 2114s, which I have seen priced at under £5. Sinclair is quoting £16 for his RAM memories. I have seen 4027s (4k) and 4116s (16k) at more reasonable prices — could these ICs be used with any success in the ZX80?
G S Dawson, Glasgow

2114s of your own source are quite suitable provided they are of sufficiently fast speed. Don't forget that 'Uncle' Clive is quoting for two 2114s, and possibly even an extra decode chip.

4027s and 4116s are dynamic RAM chips, and so are non-compatible with the ZX80 because the Z80's refresh line is used to drive the video display; extra circuitry would be needed.

This information and a great deal more should be available to all those who join the National ZX80 Users club. Send an SAE to Tim Hartnell, 44-46 Earls Court Road, London W8 6EJ. They are publishing a newsletter (already in its third issue) and offering 10% off

PETE & PAM COMPUTERS

(PETE + PAM FISHER)
MAILORDER APPLEFARE
BY REPUTABLE COMPANIES
AT FAIR PRICES

MICROSOFT

Z-80 SOFTCARD - 175.00

At Last! A card that runs software written for Z-80 based systems, on APPLE, Inc. CP/M system. Compatible with Lang. Card and all peripherals.

TYPING TUTOR - 7.95

Now you can turn your APPLE into the Aristotle of Typing Tutors! Requires 16K + APPLESOFT, (Cassette)

ADVENTURE - 14.95

For the first time, the original uncut ADVENTURE fully implemented on a personal computer (32K disk)

M+R ENTERPRISES

SUP-R-TERM - 189.95

The best of the 80 Column Video Cards, Check out the rest and then try this. Inc. shift-lock mod. 80x24 lines. 128 U + L case 5x8 dot ASCII chr set.

HIGH TECHNOLOGY INC.

DATA BASE MANAGEMENT SYSTEM - 49.95

The one you've seen elsewhere in this mag. for between 100.00 and 205.00! We offer it at a FAIR price. Sort, search, print large amounts of data in the way you want. The best price you'll find.

INFORMATION MASTER - 69.95

Store information then let INFORMATION MASTER do the work: Organizing Sorting Searching Selecting Alphabetizing Scheduling Indexing Calculating Multiplication Division Addition Subtraction Exponentiation Summation Reporting Paging Labeling Cataloging Summarizing Totaling Subtotaling

CHARLES MANN & ASSOCIATES

MASTER TEXT PROCESSOR - 69.95

Includes Mailing List and Form letter elements. Floating text. One of the best. Sold 1,000 so far.

STATISTICS PAC - 45.95

Inc. data management system. Curve fitting Probability Gen. stats Distribution Maths Test stats. Uses High Res. graphics, Reg. 32K + disk.

TEACHER PLUS - TAPE 13.95 DISK 17.95

Applesoft teaching program. Supports all major programming capabilities. Reg. 16K tape 32K disk.

FLOATING POINT DICTIONARY - DISK 18.95

Ask the program for an explanation of any term in the language and it will respond with a definition working examples of the statement form you may use, and a test program you may run to see the results of the commands use. Inc. a HELP command.

PLUS TEACHING PAC - DISK 29.95

A combination of Teacher Plus and F.P. dictionary.

PERSONAL SECRETARY PACKAGE - TAPE 31.95 DISK 34.95

Keep track of phone numbers, filed records and appointments. Developed around a major bank concept to improve efficiency.

PROFESSIONAL SEC. PACKAGE - TAPE 43.95 DISK 46.95

Designed to service the professional who requires effective use of his/her billable time. Keep track of a years appointments, client phone numbers and case files. Has a unique time management element to keep track of billable time automatically as work is done and provides an end of day record by client and task.

**PLEASE ADD 15% VAT. FREE POSTAGE AND PACKING.
WE WANT TO BE YOUR MAILORDER SUPPLIER.
IF YOU KNOW WHAT YOU WANT - AND DON'T
WANT TO PAY AN INFLATED PRICE - GIVE
US A CALL. WE'LL TRY OUR BEST!**

**TEL 01 677 2052 (24HRS) SEVEN DAYS A WEEK
98 MOYSER ROAD LONDON SW16 6GH.**

COMPUTER ANSWERS

computer books, cheap RAM chips, low-priced software and a membership list. They have over 500 members to date.

Sheridan Williams + Comp Shop, Barnet

Jumping about

The 6502 microprocessor does not have an indexed indirect jump instruction, so what is the next best way to handle a 'jump table'?

L Meddock, Peterborough

This is a common problem in programming, where we want to select one case from many. For example, a sales ledger system may present a menu on the screen from which the user can select:

- 1 Account setup
- 2 Transaction
- 3 Statement etc

High level languages provide special verbs, such as 'CASE N OF' in Pascal or 'ON N GOTO' in Basic. A solution in a low level language will depend on the architecture of the processor and so will be less well-known. Here's an interesting and particularly simple solution which I have not seen mentioned elsewhere.

The general principle is to index along a 'jump table', pick up the address of the desired routine by conventional programming, then push the address onto the stack and 'return' as if from a subroutine. The processor will go to the chosen address. There are a few items to watch out for:

- remember to double the index (shift left one) to allow for the 16-bit addresses in the jump table
- beware of the order in which the low and high bytes of the address are pushed onto the stack
- study the 'return' instruction for your microprocessor; the 6502 for instance always adds 1 at the end of the RTS operation, so you could put a NOP as the first instruction of the selected routines. The idea can be extended in some interesting directions. Try these:
 - add a byte before each address in the jump table, then look for a match with the input byte. This permits a mnemonic code letter
 - use the address of an error routine in the jump table to simplify input validation
 - use the first (or last) address to point to a default routine
 - implement a computed 'GOSUB' by pushing the real return address before using the jump table.

R Ross-Langley, Mine of Information

Small micros

Could you advise on micro-computers in the £200 range, suitable for serious use by students studying computing? Has the Acorn Atom been reviewed anywhere? Has it any real competitors apart from the Sinclair ZX-80? How is the ZX-80's 1 kbyte of RAM "roughly equivalent to 4 kbytes in a conventional computer"?

D S J Hargreaves, Halifax and A J Moorhouse, Blackpool.

There are now several machines in this price range, although, if you want a ready-built machine with a high level language like Basic, your choice will probably at present be made from among the Sinclair ZX80, the Acorn Atom, the Nascom 1 and the Microtan 65, with the Ohio Superboard II a bit above your range. If you can build from a kit you can save some £20-£50, and this would bring the UK101 nearly into your range, on a VAT-inclusive basis. If you are content to limit your activities to machine coding in hex, then the Elf and original Acorn can be considered. If you wait till the autumn there may well be some more choice in this range. One computer already announced for introduction then is the Newbrain, which in its simplest form would offer a ready built machine with a lot of I/O and an extended Basic well within your price limit. There is also the Sharp PC-1211 pocket computer.

As regards reviews, the Acorn Atom was featured in the July PCW which also contained items on both the Newbrain and the Sharp PC-1211.

How does Sinclair do it? To start with, 1 kbyte of memory will hold 1 kbyte of binary code, regardless of whose it is. It's what can be packed into that binary code that's significant. For example, on some machines (such as the TRS-80), data can be stored as integers, single-precision floating point, or double precision fp. One kbyte will hold 512 integer numbers, 256 single-precision, or 128 double-precision numbers. The ZX-80 saves space by storing Basic keywords (such as GOTO, PRINT, etc) as single bytes and so gets more program lines into a given amount of memory. Perhaps it's not too surprising that the ZX-80 is not unique in doing this, but there are certainly a lot of computers which don't.

P L McIlmoyle

Apple Price List

Product Code	Description	Retail Price (£)		Retail Price (£)
HARDWARE				
A2S1016P	APPLE 16K VIDEO OUTPUT ONLY	695.00	A2L001A	APPLE II REFERENCE MANUAL
A2M0003	DISC DRIVE WITHOUT CONTROLLER	299.00	A2L0002	6502 HARDWARE MANUAL
A2M0004	DISC DRIVE WITH CONTROLLER	349.00	A2L0003	6502 SOFTWARE MANUAL
A2M0016	16K ADD ON RAM	69.00	A2L0005	APPLE II BASIC PROGRAM MANUAL
CARDS & ACCESSORIES				
A2B0001	PROTOTYPE/HOBBY CARD	15.00	A2L0006	APPLE II REFERENCE MANUAL
A2B0002	PARALLEL PRINTER INTERFACE CARD	104.00	A2L0012	DOS 3.2 MANUAL
A2B0003	COMMUNICATIONS CARD	130.00	A2L0018	APPLE II BASIC TUTORIAL MANUAL
A2B0005	HIGH SPEED SERIAL INTERFACE CARD	113.00	GENERAL ACCESSORIES	
A2B0006	PASCAL LANGUAGE SYSTEM	299.00	A2D0000	(10) BLANK APPLE DISCETTES
A2B0007	CENTRONICS CARD	130.00	A2M0009	VINYL CARRYING CASE
A2B0009	APPLESOFT FIRMWARE CARD	116.00	AD/LB	MINI DISC LIBRARY BOX
A2B0010	INTEGER CARD	116.00	MD5172	DISCOFLEX FILING CASE—MINI
MHP-X003	MOUNTAIN HARDWARE CLOCK/CALENDAR CARD	160.00	APP1	APPLE DESK TWO TIER
MHP-X006	MOUNTAIN HARDWARE SUPERTALKER	171.00	APP2	PRINTER TABLE
MHP-X007	MOUNTAIN HARDWARE ROM PLUS BOARD	116.00	APPLETEL	APPLETEL SYSTEM
MHP-X015	MOUNTAIN HARDWARE ROMWRITER	101.00	DUST/APP	DUSTCOVER FOR APPLE II
E2B100	EUROCOLOUR CARD	79.00	E2B013	APPLEJUICE RESERVE POWER SUPPLY
E2B101	APPLE BLACK & WHITE MODULATOR	14.00	PRINTERS & ACCESSORIES	
E2B102	A1-02 DATA ACQUISITION CARD	180.00	A2M0034	SILENTYPE 80 COLUMN GRAPHICS PRINTER
10-5-16	ALF MUSIC SYNTHESIZER CARD	142.00	A2C0001	10 ROLLS OF THERMAL PAPER FOR SILENTYPE PRINTER
10-5-17	ALF TIMING MODE INPUT BOARD	14.00	HUSH100/A	MICROHUSH 100 PRINTER C/W APPLE INTERFACE
13-3-2	ALF ALBUM MUSIC DISKETTE NUMBER ONE	12.00	HUSHPAP	16 ROLLS THERMAL PAPER 80FT LONG
13-3-4	ALF ALBUM MUSIC DISKETTE NUMBER TWO	12.00	HUSHPAP/E	2 ROLLS THERMAL PAPER 80FT LONG
13-5-5	ALF ALBUM MUSIC DISKETTE CHRISTMAS	12.00	TIGER/G	PAPER TIGER PRINTER WITH GRAPHICS OPTION
A2M0015	HEURISTICS SPEECH LAB	122.00	TIGER/C	CONNECTOR CABLE FOR TIGER PRINTER
A2M0019	PROGRAMMERS AID 1	27.00	TIGER/D	GRAPHICS SOFTWARE FOR TIGER PRINTER
A2M0027	AUTO START ROM PACK	38.00	TIGER/P	TIGER PAPER 2,000 SHEETS 11" x 9 1/2" S/PART
A2M0029	GRAPHICS TABLET	462.00	TI810	TEXAS OMNI 810 PRINTER
E2B104	HEURISTICS CONTROLLER 70	52.00	LP5	PAPER 2000 SHEETS 11" x 15" S/PART
E2B105	HEURISTICS SPEECHLINK 2000	160.00	LP9	PAPER 3000 SHEETS 8" x 12" S/PART
E2B107	IEEE INTERFACE	212.00	VIDEO MONITORS	
SOFTWARE				
A2D0005	CONTRIBUTED SOFTWARE VOL 3-5	60.00	VM129	12" BLACK AND WHITE VIDEO MONITOR
A2D0006	CONTRIBUTED SOFTWARE VOL 1-2	27.00	VM910	9" BLACK AND WHITE VIDEO MONITOR
A2D0009	MICROCHESS 2.0 CHESS DISK	15.00	VM906	9" HIGH RESOLUTION BLACK AND WHITE VIDEO MONITOR
A2D0010	DISC UTILITY PACK	15.00	VM/C	CABLE FOR VIDEO MONITOR
A2D0012	APPLE BUSINESS CONTROLLER PROGRAM	340.00		
A2D0013	APPLE POST PROGRAM	27.00		
A2D0018	APPLE BOWLING DISCETTE	9.00		
A2D0025	APPLE CASHIER PROGRAM	194.00		
A2D0026	APPLE WORD PROCESSING PROGRAM	42.00		
A2T0013	MICROCHESS 2.0 CHESS CASSETTE	15.00		
E2D001	VISICALC DISC & BOOK COMPLETE	95.00		

Prices exclusive of carriage and VAT and are correct at time of going to press. Available from Apple Dealers all over the UK—for your nearest please contact Microsense Computers. Dealer/OEM enquiries welcome.

microsense computers limited

Finway Road, Hemel Hempstead, Herts HP2 7PS
Tel (0442) 48151 and 41191
Telex: 825554 DATEFF G



SOLE UK DISTRIBUTOR

apple computer

®Apple is a trade mark of Apple Computer Inc., Cupertino, C.A., USA



APPLE COMPUTER SYSTEMS APPLE COMPUTER SYSTEMS APPLE COMPUTER SYSTEMS APPLE COMPUTER SYSTEMS APPLE COMPUTER SYSTEMS

HELPING THE HANDICAPPED

It's often said that microprocessors will play a major role in aiding the handicapped but few companies seem interested in actually doing much about it. One exception is Telesensory Systems Inc, which specialises in aids for the disabled. Julia Charles reports from California on TSI's activities.

Telesensory Systems Inc (TSI) is a small advanced electronics company based in Palo Alto, California. The company is located on a hillside surrounded by idyllic views of the San Francisco Bay and hills in an area where electronic companies are both numerous and flourishing.

TSI differs from the other companies, however, because of the specialised nature of its expertise for it concentrates on the application of sophisticated equipment for the handicapped, a field now entitled 'rehabilitation technology' in which a device may augment, substitute or enhance the physical or sensory limitations of an individual.

The company was formed in 1970 to produce and market the OPTACON (Optical to Tactile CONverter), a reading device for blind people which resulted from a research project led by Professor J G Linvill at the Department of Electrical Engineering, Stanford University.

Professor Linvill developed the OPTACON after he realised the size of the barrier that the blindness of his daughter, Candy, imposed upon her ability to read. During that period Candy was at school and the time required for translating materials from print to braille, as well as the sheer bulk

of braille material, were severe impediments to her studies.

The OPTACON is an optical to tactile converter that generates with an array of vibrating pins a tactile image which is a magnified facsimile of letters focused on its silicon retina. The OPTACON equipment comprises a hand-held camera and a box of electronics; as the user moves the camera across a line of print the optical impression from the camera is converted into electronic signals so that an enlarged, vibrating representation of the image the camera is receiving is displayed on a tactile array that the user feels beneath his index finger. The blind person is therefore able to read tactually in the same way that a sighted person reads visually — he feels the same shapes that the sighted see. The tactile array is a small rectangular pad about half an inch by one and a half inches, with 144 pins arranged in six columns.

The research project at Stanford began in 1963 and by 1970 such an improved and compact model of the OPTACON had been developed that it was decided to put it into quantity production. However, commercially, its potential was extremely dubious; it's an expensive and esoteric device whose usefulness is restricted to a small, select population. The gulf between the

university-based research product and the manufacturing and marketing capabilities required to bring that product to its intended market was so great that it was necessary to form a new company in an attempt to bridge the chasm. TSI was established for the purpose in 1970 with Dr J Bliss as President, and production of the OPTACON began in 1971.

The OPTACON Research Group at Stanford still continued with its aims of developing useful devices for blind people but as with any research organisation their findings were immediately available to TSI, as they were to any other interested party. The openness of this relationship was valuable, for it provided a safeguard to the blind population in ensuring that the only insurance TSI had against competition was its own effectiveness. TSI still maintains a close relationship with Stanford University and two Stanford faculty members are on its Board of Directors.

As a sophisticated device of use to a limited market, the OPTACON displays many of the features that necessarily characterise rehabilitation technology devices and which help to explain why this is an area where successful manufacture and marketing is so difficult to achieve: the research and development



The neonatal screening audiometer is designed to detect hearing deficiencies in newly-born babies.



The TSI Optacon, with its miniature camera to the right. The tactile 'reading' pad is visible inside the slot.

cost of equipment of this nature is high; a handicapped population is generally small and the usefulness of any particular device is limited according to the type and degree of disability of the user (not all blind people can use an OPTACON, for example); handicapped people are generally hard to locate and they often do not have a lot of money.

Bearing in mind these factors it's interesting to look at TSI's development over the past decade, to consider some of the reasons for its success and to review some of its products.

Firstly TSI has always received considerable financial support from government and non-profit based organisations, which has subsidised research and development costs. For instance, much of the work on the OPTACON was done at Stanford with government support, keeping the price of the OPTACON lower as it was not necessary to recoup these research and development costs. The government investment, however, has been adequately retrieved in that a blind person, with the increased capabilities that the OPTACON gives him, is able to be more productive in the economic society in which he is expected to participate.

Secondly, TSI has been able to transfer the technology developed for the OPTACON to a number of other products so that today it has several commercial products on the market which derive from two basic technologies: synthetic speech and bimorph transducers. To illustrate these transfers it is best to look at TSI's current range of products.

The second product TSI brought out utilised the first of these technologies, synthetic speech. The Speech + talking calculator was introduced in 1975 and was the first consumer product to provide voice output through micro-processor-generated speech. The calculator has a 24-word mathematical vocabulary and is available in English, French, German and Arabic speaking models.

The synthetic voice of the 'Speech +' is also the voice of TSI's Game Centre, a microprocessor-controlled collection of eight electronic games, similar to video games but using only synthetic speech output and other audible cues to provide game information to the players so it can be utilised by blind persons.

The same synthetic speech technology is also available as pre-assembled speech boards and so can be used for experimental purposes as well as in such products as the talking Chess Challenger.

Having moved into speech technology, the next development was obviously to make a talking OPTACON, as this would increase its utility both in education and vocational settings. Voice output and automatic scanner units are expected to be commercially available in 1982. The units have been under development for four years, stemming from work on speech synthesis originally based at the Massachusetts Institute of Technology. This autumn prototype units are to be evaluated in the field over the next year before final decisions are made concerning design features.

The second area in which TSI has employed technology transfer has been



TSI's Speech+ talking calculator for the blind.

in the area of bimorph transducers. These were originally utilised in the OPTACON and are now incorporated in both the Crib-O-Gram and the VersaBraille.

The Crib-O-Gram is a neonatal screening audiometer and was initially conceived and developed by Dr F Blair Simmons at Stanford University Medical Centre. The technology was transferred to TSI under licence from Stanford University. The Crib-O-Gram identifies serious hearing impairments in newborns, using a narrow band noise stimulus, a highly sensitive motion detector and a microprocessor-based decision analysis to assess neonatal motor activity in response to a series of 30 stimulus trials. Early identification of hearing impairment allows early treatment to facilitate the normal development of language and cognitive faculties that may otherwise be seriously impeded if the hearing deficit is not diagnosed until the child is two or three, which is an average age of detection by conventional means.

The VersaBraille is a portable micro-processor-based Braille information processing system which allows quiet and efficient writing, reading and note-taking as well as being a compact and economical way of storing Braille text. It's also an audio tape recorder which can record sound and Braille on the same tape and can provide an index and automatic retrieval system for both audio and Braille materials. Attachments for computers, typewriters and teletypewriters increase the system's usefulness in many vocational settings.

TSI has therefore utilised the spin-off of two particular technologies to produce seven successful products. The success of these products may be attributed to the clearly defined organisational objectives that provide TSI's goal when new products are being developed: that the product must fulfill a real customer need, that it provides lasting value and represents an unmatched contribution in the marketplace, and that it matches the marketing and manufacturing strengths possessed by TSI. Also, it should be a profitable concern.

An example of the application of these principles to a new product may be seen in the Autocom project, now nearing completion. The Autocom is a device which was originally developed at the TRACE Centre for the Severely Communicatively Handicapped at the University of Wisconsin. The rights to develop, manufacture and market the

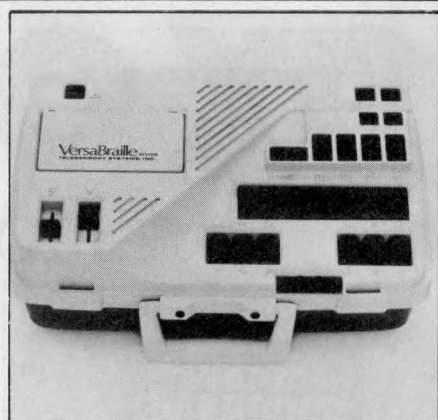

The VersaBraille is, in effect, almost a word processing system for the blind.

Autocom were awarded to TSI in 1978 and it is hoped that it will be in production later this year. The Autocom is a communication system for individuals who are both motorically and vocally impaired. It allows a user to select, store and display vocabulary items by moving a pointer to a chosen square on the board's grid surface. The board is housed in a wheelchair laptray, giving the user complete freedom of mobility. The vocabulary store is user-programmable and can be simple or complex in that vocabulary items can be symbols, pictures, letters, numbers, words or word parts, phrases or sentences. By using many 'levels' of electronic memory several thousand different items may be stored and the user programmability means that each individual may create and modify his own personal vocabulary. The variety of input and output modes available also helps to make the Autocom suitable for a wide range of users.

TSI came into being 10 years ago to research, develop and commercialise rehabilitation devices. It was entering a new and complex field in which the probability of success was low. However, during the 70s it not only established itself as a world leader in its specialised fields but is now in a position where it is able to broaden the range of these fields. The potential applications for products utilising high quality voice synthesisers are both numerous and obvious and will benefit areas both of disability and non-disability. The reputation TSI has gained for quality and reliability should ensure the continuing support of government and non-profit making organisations so allowing it to retain its heavy research bias, and although the company is expanding it is still sufficiently small to be involved in custom design development.

TSI came into existence because it wanted to introduce a new product in a new market, a risky venture for any commercial organisational framework is specifically designed for its particular needs and is fluid to allow for adaptations to changing environments. Its standards of research, development, production and maintenance and assessment and training of users are extremely high, as is the level of expertise demanded from its staff. TSI has been successful because it has been able to offset risk-taking against these high standards.

SIX OF THE BEST

Pet Programs from Petsoft



76 COMMON BASIC PROGRAMS
A collection of 76 useful programs on one cassette from Adam Osborne's best selling book. These include personal finance, maths, statistics and general interest topics. Excellent value for stand alone or incorporated use.

£15 on cassette.



STOCK CONTROL Powerful and flexible stock system with full facilities for recording and control of stock information. An audit listing is automatically printed which itemises all transactions including the entry amendment and deletion of master stock information, issues receipts, allocations, purchase orders. Printed reports include Full Stock Control, Stock Valuation, Reordering Report, Audit Listing, The system is highly flexible.

£50 on CompuThink or Commodore Disk.



WORDCRAFT A true Word Processor for the 32K PET. Wordcraft is a genuine word processing system, easy to understand and use, but containing all the facilities normally found only on more expensive dedicated Word Processors. Features include scrolling in both vertical and horizontal directions (to overcome small screen size), up to 117 characters wide and 98 lines deep for a full page of text. Written entirely in machine code for speed and compactness. Truly the Rolls-Royce of PET Word Processors.

£325 on CompuThink or Commodore Disk.



PAYROLL 200 Comprehensive, easy-to-use package for small businesses with up to 200 employees. Facilities provided include Holiday Pay, Sick Pay, Bonus Payments and two rates of overtime, as well as allowing a 'Standard week' to be specified for each employee. Weekly and monthly summaries are provided and amendments necessary because of a Budget are made very easy. Prints wage slip and coin/note analysis. Tax & NI are computed automatically from knowledge of employees codes. Update service available. Full manual provided.

£50 on Commodore or CompuThink Disk. Cassette system also available at £25



PETPLAN BUSINESS SIMULATION Petplan is a general management business simulation game which is exciting to play. Already it is widely used by colleges and Industrial Trainers to teach the skills needed to run a business. The program creates the model of a manufacturing company; you take the decisions. You will need to hire workers, invest in plant and premises, set advertising budgets and prices. At each stage screen reports (which may be printed out) show the results of decisions as they take effect. 50 page manual and voice guide on cassette. For 32K PETS.

£60 on Cassette.



PET BASIC TUTORIAL 2 A revised version of our best selling course on programming the PET in Basic. Let PET take you through its commands and functions at your own speed. Over 50K of lessons including working examples of the programming techniques that are described. Suitable for novices and those with some programming experience, from literacy age 10 on.

£15 on cassette.

PROGRAMMERS TOOLKIT £44

Plug-in ROM Chip adds nine useful commands to PET BASIC including RENUMBER, TRACE, DUMP, FIND and APPEND.

You will find Petsoft programs on sale in more than 200 computer shops throughout the country, and in many more all over the world. We invite you to try them.

If you can't find the program you need, contact us directly. We offer over 200 titles and can supply you directly. We will even take credit card orders over the telephone. Since we normally carry all programs in stock, you won't have long to wait.

PET is the trademark of Commodore.

Petsoft is backed by the resources of Applied Computer Techniques Ltd., Britain's leading computing group. With over fifteen years experience of developing business software, ACT has a reputation second to none in the industry. That is your guarantee.

If you would like more information on any of the programs mentioned on this page, clip out the coupon. We will see that a free copy of our complete PET software catalogue reaches you without delay.

Petsoft

part of the **ACT**
Computer Group



Radcliffe House, 66/68 Hagley Road, Birmingham B16 8PF

Telephone 021 455 8585

Telex 339396

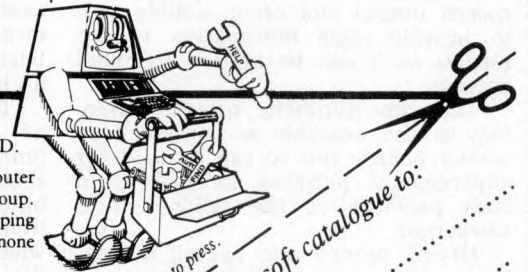

Prices exclude VAT and where correct at time of going to press.
Please rush a FREE copy of the latest Petsoft catalogue to:

Name:

Address:

Postcode:

I have an

- 8K PET
- 16K PET
- 32K PET
- No PET yet

This month our microchess expert Kevin O'Connell looks at two new chess-playing computers.

Once more - this time with feeling

Perhaps the title should say twice more since this month I am looking at the two new Chess Challengers, with sensory boards, which should take over from the Challenger 7 and the Voice Chess Challenger.

Sensory Voice Challenger

This is a new product and I had only a short time to test the one and only prototype in the UK at the time. That was sufficient to test all the features but not to form a reliable estimate of its playing strength, the program for which, in any case, was still being developed and improved. The ROM has been almost doubled and it should at least play rather better than the Voice Chess Challenger — that would be sufficient to put it in the top three commercially-available programs.

The unit's appearance is quite pleasant and the angled display overcomes the small but irritating problem associated with the earlier Challenger machines — it was necessary to crane over the machine if an E or F was displayed to see which of the two it was.

The sensory board is something that many major manufacturers have been working on but Fidelity is the first to make one available on a moderately-priced unit. The machine which I tested worked extremely well; the amount of pressure needing to be exerted on the sensory board was so slight that natural piece movement was usually adequate. However, that was a sample and first production units of the Sensory 8 are less satisfactory — I found it necessary to press down very firmly with the edge of a piece. It remains to be seen whether production units of the Sensory Voice, and later Sensory 8s, are more like the prototype I tested in their sensory action. If they are, then it is a great enhancement, for it makes playing against the computer both easier and more like playing a real game of chess.

When the computer chooses a move, it announces it both audibly through its voice chip, and by lighting up two of the 64 LEDs on the board. It lights up both the square on which the piece it wants to move currently stands and the square to which it wants to move that piece.

Something completely new is the Great Game feature: 64 complete games have been stored in ROM. The Game feature enables the user to try and predict the moves played by one of the chess masters represented. The idea of a test to establish 'How good is your chess' has long been a popular one in chess magazines and several books have been published using this theme. Those books and articles enjoy one great advantage — by assigning a certain number of points to each move, they enable you to rate your own play in certain types of game. The Sensory Voice's Game feature merely indicates

whether you have selected the same move that was actually played and gives no indication of whether that was the best move or not. On the whole an interesting innovation, although, as a chess player, I take exception to Fidelity calling the games 'The 64 Greatest Games by World Chess Champions' since six of the games do not involve anyone who ever held the title.

The Sensory Voice has quite a large openings book — the pre-programmed moves which are employed at the start of a game. There are 64 strings, ranging in depth from just one move to 18 (nine for each side). In all there are 377 moves stored in ROM. That doesn't compare with the thousands upon thousands of moves stored in a chess master's head but it is more than enough to ensure that the user meets a wide range of responses and should be in no danger of being bored by the opponent's repetitive play.

An important improvement over the Sensory Voice's unfeeling predecessor is that on the new model it is possible to turn down the volume of the synthetic voice. The user can also choose to restrict the machine's vocabulary, so that it will only warn of illegal moves and checks. The ordinary Voice Chess Challenger allows only the choice of full on or completely off; the problem with that is that the synthetic voice soon begins to grate on the ears, yet if you switch it off you have to keep looking at the machine to see if the computer has made a move, and you do not get any audible check of that move nor, indeed, your own moves. Giving the user more choice is very sensible.

Another innovation, made possible by the fact that the display is no longer required for displaying the computer's

moves, is the inclusion of a chess clock. This enables the user to see how much time each player takes for each move, as well as the total elapsed time for each player since the start of the game. It can also be used in Count Down mode, so that one can pre-set the total amount of time allowed for each player for the whole game (if one player runs out of time he automatically loses), thus duplicating a popular form of inter-human chess in which everyone knows the latest possible completion time for a game. This is obviously very useful if you know that you have only 50 minutes to devote to playing chess and wish to avoid the frustration of an unfinished game or the risk of missing an appointment because you cannot drag yourself away from an intriguing position which has developed on the board.

Fidelity has taken a leaf out of SciSys-W's book by deciding to make available an accessory printer but this had not been developed at the time of writing. When it does become available (it is scheduled for November and will cost about £170) it will plug into the back of the main unit and will provide a permanent record of any game you play against the computer.

Sensory 8

The Sensory 8 is basically the old, but ever-popular, Challenger 7 with a sensory board attached. It has none of the special features of the Sensory Voice. Fidelity claims that the program is an improvement on that in the 7 — I have no reason to disbelieve this, but my tests so far have not revealed any noticeable differences, so the improvement can only be slight.

Summary

The Sensory 8 Challenger is widely available at about £129. The Sensory Voice Challenger should also now be in most shops, priced at about £279. The machines they augment, the Challenger 7 and the Voice Challenger have been reduced in price to, respectively, less than £90 and about £219.

My thanks to Paul Balcombe, Nick Beddoe and David Morein of Computer Games Ltd, Fidelity's UK distributors, for their help and loan of the machines. Thanks also to Peter Nasca and Oscar Segal of Fidelity Electronics. It required some courage on the part of CGL to persuade Fidelity to let a designer of rival systems be the first to review its new products!

Next month

Another new chess computer, one with several major innovations which make it the first chess machine which genuinely is useful for anyone interested in chess — from someone who does not even know how the pieces move up to and including the world champion himself.

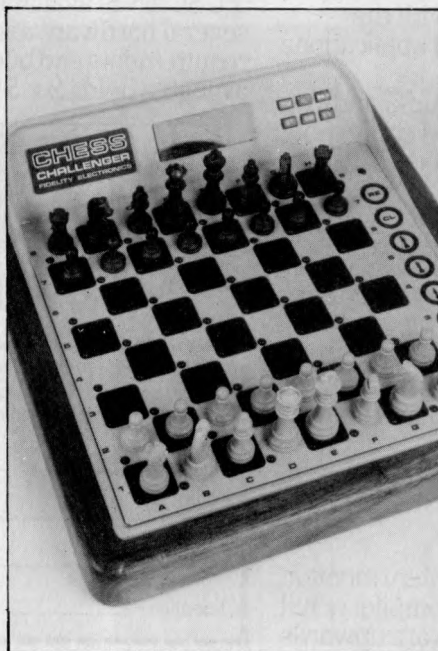

The Sensory Voice Challenger.

'TUSCAN' FROM TRANSAM



Take a step up to your next Computer!

THE CONCEPT

How many ways are there to build an S100 system? Not many, and all expensive. TUSCAN changes all that.

Five S100 boards on one single board—just for starters. Plus five extra slots for future expansion.

What a combination! Z80 and S100 with the TRANSAM total package of system and applications software.

How do we do it? Our prices start at £195 and you can build up in easy stages to a fully CP/M compatible disc based system. Something to think about!

THE HARDWARE

The first Z80 single board computer with integral S100 expansion. British designed to the new IEEE (8 BIT) S100 specification, the TUSCAN offers total system flexibility. A flexibility available now.

The board holds the equivalent of a Z80 cpu card, 8k ram, 8k rom video and I/O cards with 5 spare S100 expansion slots and offers a price/performance ratio which is hard to beat.

Just compare our price with a commercial S100 ten slot motherboard with this specification.

THE SOFTWARE

TUSCAN offers the user the choice of system monitor, editor, resident 8k basic, resident Pascal compiler or full CP/M disk operating system. All options are upwards

compatible and fully supported with applications software. Both 5¼" and 8" drives are supported in double density.

THE PACKAGE

TUSCAN is available in kit form or assembled. With several hardware and software options to suit your requirements and budget. Attractive desk top case also available holds 2 x 5¼" Drives.

TRANSAM

NOBODY DOES IT BETTER!

Send to Transam Components Ltd., 59/61 Theobald's Road, London WC1.

I am interested in the TUSCAN Z80 based single board computer with S100 expansion and enclose a S.A.E. for further details.

Name _____

Address _____

Telephone _____

TRANSAM COMPONENTS LTD., 59/61 THEOBALD'S ROAD, LONDON WC1. TEL: 01-405 5240/2113



YOUNG COMPUTER WORLD

Compiled and written by Derrick Daines

There's this old boy (not me) driving down the M1 at a steady 45mph. His car's only a year old but suddenly — bang! — there he is, stranded for hours on the soft shoulder. When he finally gets home, sitting on the doormat is a computerised bill dunning him for £99999999.99!

He ought to have stayed in bed! In one day the poor old chap has been the victim of two breakdowns — his car and some computer or other. Stand by for a stupid question: which of those two breakdowns will receive the greater publicity?

We know, don't we, that the computer breakdown will be headline news the following morning? Maybe questions will be asked in Parliament, with demands that the computer be scrapped. The broken-down car will be ignored.

A full discussion on the reasons why there is this difference in attitude towards the car and the computer would take up far more room than I have available here. It would certainly include the glee that we all feel — somewhat uncharitably — at the downfall of the mighty. In some ways the computer is the victim of its own success. That is to say, we have come to expect the computer to be so reliable that it is headline news when it fails.

A good example of this attitude at work was given by the recent missile scares in the US, caused by a faulty computer in the defence network. Critics immediately called for the scrapping of the system, although they did not suggest what should replace it. An Observer Corps with binoculars, perhaps?

I mention all this because I was recently in a computer store and saw the embarrassment on a boy's face as he struggled to convince his dad that computers don't break down. Dad wasn't convinced and wouldn't buy. I was intrigued; why did dad insist upon total infallibility? Why should the boy have felt the need to prove something that in his heart he knew to be false?

Wouldn't it be better for all of us to admit that yes, computers do sometimes break down? Anything that exists will fail sooner or later! And wouldn't it be better for manufacturers and others to admit it openly too and spend as much on a repair service as they do on the original product?

Perhaps all that the dad really wanted was a frank and open admission of the possibility of breakdown and the assurance of swift and reasonably cheap repair. There are as yet no corner garage that can get a faulty computer up and running. No doubt they will come in time — but that's another story.

A large postbag this month. A while ago we published a listing of Don Walton's game Cat and Mouse, designed to give youngsters familiarity with their keyboard. Don is deputy head of Houghton County Primary School, Houghton, Huntingdon, and he sent along a tape of eight games for the PET with an educational flavour. He is selling the tapes at £12 each, which is good value by anybody's standards. I tested all the games and found them entertaining as well as educational and most had novel features. I was particularly impressed by a word matching game and a spelling game for two players; both must make a great contribution to reading skills. On the debit side, I personally found the car rally game a little irritating in that it asked me for a current position that it knew but there's no doubt that it would teach geography in an interesting way. It was also possible for either play in Noughts and Crosses to overlay his opponent's position, but these are small niggles.

Verdict — a must for any primary school with a PET. Enquiries to Don at the above address; proceeds go to the school fund for another PET.

Anybody out there with a ZX-80 (which must be more than a few) should drop a line to Mark Wylie (16) of 24 Oakgrove, Hertford or ring him on Hertford 59081, because he has designed a buffered interface to allow the addition of more RAM, which can't be bad. Mark will let you have a photocopy of the circuit for only 20p and an SAE! I'm sure a lot of people will be interested.

A thick duplicated booklet called the CESI Newsletter (some letter — it ran to 56 pages!) arrived from the Computer Education Society of Ireland. I found it a good read, even the Gaelic bits. It's the journal of Eire teachers interested in computers and, as well as some domestic stuff, included a reprint of selected articles from around the world. My congratulations go to whoever made the selection, for they were without exception thought-provoking and forward-looking.

CESI was set up in 1973 and interested parties can write to Diarmuid McCarthy, 7 St. Kevin's Park, Kilmacud, Blackrock, Co. Dublin, Eire.

Diwyang Mistry (I hope I've got that right) who is 16 and lives in Middlesex, weighed in about the *Sunday Times* Young Computer Brain of the Year competition. (Regular readers will remember that the competition was criticised on this page because the ability to write an essay is not necessarily an indication of the best computer brain.) He makes two points: Good programs require good writing skills

and accompanying documentation; and insisting on a program or piece of hardware would preclude those without access to a computer.

I can see the force of the first argument but have my doubts about the second. If you have no access to a computer, what do you know about their limitations and possibilities? If you have *some* access, then it has been my experience that keen youngsters are pretty quick at turning out interesting programs. Anybody else with views on the matter?

Robert Schifreen (16) of 4 Edge-warebury Gardens, Edgware, wrote in with a plea for books or manuals about the Superboard 2 because he finds the manuals supplied are unhelpful. Anybody with ideas or suggestions drop a line to Robert. He also suggested that we publish a conversion table for screen locations between the UK101 and Superboard. We'd be glad to, if somebody would care to send one in!

Finally for this month, John Cowie of Fife wrote in extolling the virtues of the Aim computer. This was in response to the article we published by S. J Hemming on the mother/daughter computer arrangement they've got at Sandbach High School. He urges anyone contemplating a similar arrangement to consider the Aim as the daughter micro. I would like to quote more of John's letter, but do not have space. If you're interested, drop him a line at 2 St Colme Road, Dalgety Bay, Fife. It will be worth your while.

Programs received

Breakout with Sound — Mark Knowles (14) of Bolton.

Noughts and Crosses for ZX80 — J Grove (14) of Tokyo.

Car Race — Kim Mulji (13) of Calne, Wilts.

Mk14 Routines — Richard Osborne (16) of Gateshead.

Lunar Lander Improvements — Graham Kirby (14) of Pitlochry.

Laser Duel — by P A Jefferson (160) of Bradford.

— AND (tarahhhh!) another girl — German Noun Declension, by Rachael McGhee (16) of Welwyn Garden City.

I must add, by the way, that Rachael's printout and letter are far and away the most beautifully printed that I have ever seen. I don't know what printer she uses — perhaps she'll tell us — but it is of professional quality.

interface components



MICRO MART

ICs
EPROMs 2708 £6.50 each
EPROMs 2716 £15.00 each

MEMORIES
21L02 £0.80 each
4027 £1.99 each
4116 £4.50 each
2114 £3.00 each

Z80 DEVICES
MK3880 £9.50 each
MK3881 (P10) £6.25 each
MK3882 (CTC) £6.25 each

VOLTAGE REGULATORS
7805 80p each
7812 80p each
7815 80p each
7824 80p each
7905 105p each
7912 105p each
7915 105p each
7918 105p each
7924 105p each
Add VAT and 30p P&P to all orders

SHARP'S DESK-TOP BRAIN. MZ-80K FROM £480 Plus VAT

An amazing Z-80 controlled personal computer supplied with 78-key ASCII keyboard; 14K extended BASIC; VDU (40 characters x 25 lines); fast cassette facility; 4K monitor ROM; 80 x 50HR Graphics; and a choice of 20K, 32K or 48K of internal random access memory.

A 50-pin universal BUS connector allows the addition of printer, floppy discs, etc. There is also a built-in 3-octave music function.

20K System £480 + VAT
32K System £529 + VAT
48K System £599 + VAT
MZ80FD (twin floppies with 208K) £780 + VAT
MZ80P3 Printer £517 + VAT
MZ80 I/O Interface £99 + VAT

NASCOM-2

MEMORY ● 8K Microsoft BASIC ● 2K NAS-SYS 1 monitor ● 1K Video RAM ● 1K Workspace/User RAM ● On-board 8 sockets provided for memory expansion using standard 24-pin devices: 2708 EPROMS and MK4118 static RAM. MICROPROCESSOR ● Z80A which will run at 4MHz but is selectable between 2/4 MHz. HARDWARE ● Industrial standard 12" x 8" PCB, through hole plated, masked and screen printed. All bus lines are fully buffered on-board. INTERFACES ● Licon 57 key solid state keyboard (included) ● Monitor/domestic TV interface ● Kansas City cassette interface (300/1200 baud) or RS232/20mA teletype interface.

The Nascom 2 kit is supplied complete with construction article and extensive software manual for the monitor and BASIC.

EXPANSION OPTIONS

● MK4118 £10 + VAT each
16K RAM B Board £140 + VAT
32K RAM B Board £175 + VAT
48K RAM B Board £210 + VAT
16K RAM A Board £140 + VAT

£225 (Kit)
Plus VAT + P&P £2.00

£295 (Kit)
includes 16K RAM Board
Plus VAT + P&P £2.50

NASCOM IMP PLAIN PAPER PRINTER

The Nascom IMP (Impact Matrix Printer) features:

- 60 lines per minute ● 80 characters per line ● Bi-directional printing ● 10 line print buffer ● Automatic CR/LF ● 96 characters ASCII set (includes upper/lower case, \$, £) ● Accepts 8½" paper (pressure feed) ● Accepts 9½" paper (tractor feed) ● Tractor/pressure feed ● Baud rate from 110 to 9600 ● External signal for optional synchronisation of baud rate ● Serial RS232 interface ● Optional TRS80 interface ● Ribbon cartridge £9.90 + VAT ● 2000 sheets Fan Fold paper £18.00 + VAT.

Nascom Imp
£325
Plus VAT + P&P £2.99



WITH EVERY SHARP 48K A FREE PC-1211 WHILE STOCKS LAST

NEW POCKET COMPUTER FOR UNDER £100 + VAT. SHARP PC-1211

It's true! A real computer that employs the BASIC programming language and fits into a pocket!

The PC-1211 measures only 175mm wide by 70mm deep by 15mm high and weighs a mere 170g (less than 6 ounces) yet look at its features! Up to 1424 program steps, 80 character input line with full editing features, 18 user definable keys, 24 character alpha-numeric LCD display and built-in tone function are included.

An optional cassette interface is available for loading or dumping programs or data. The PC-1211 is battery operated, has an auto power off function, and maintains all programs and data in its memory even after the power has been turned off.

£91.26

Plus VAT + P&P £1.50
(cassette interface: £13.00 plus VAT + P&P 75p)

NASCOM-1

12" x 8" PCB carrying 5LSI MOS packages, 16 1K MOS memory packages and 33 TTL packages. There is on-board interface for UHF or unmodulated video and cassette or teletype. The 4K memory block is assigned to the operating system and video display leaving a 1K user RAM. The MPU is the standard Z80 which is capable of executing 158 instructions including all 8080 code. **Built price £140 + VAT.**

Nascom-1 Kit Price
£125 Plus
+ P&P £1.50

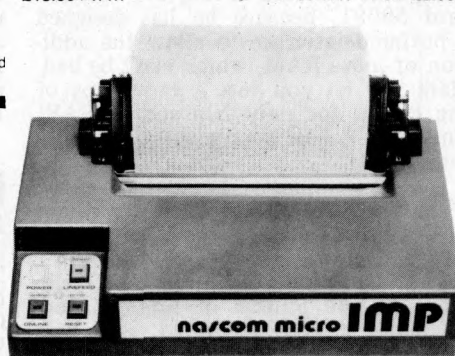

NASCOM FIRMWARE IN EPROM

NASPEN £30.00 + VAT + 30p P&P
ZEAP 2 £50.00 + VAT + 30p P&P
NAS-SYS 1 £25.00 + VAT + 30p P&P
NAS-DIS £37.50 + VAT + 30p P&P
NAS-DEBUG £15.00 + VAT + 30p P&P
NAS-SYS 3 £40.00 + VAT + 30p P&P

NASCOM SOFTWARE ON TAPE

8K BASIC £15.00 + VAT
ZEAP 2 £30.00 + VAT + 50p P&P

NASCOM HARDWARE

Motherboard £5.50 + VAT + 50p P&P
Mini Motherboard £2.90 + VAT + 50p P&P
3 amp PSU £29.50 + VAT + £1.50 P&P
VERO DIP board £12.50 + VAT + 50p P&P
FRAME £32.50 + VAT + £2.00 P&P
8 Amp PSU Built £105.00 + VAT + £2.75 P&P
Econographics £30.00 + VAT + 50p P&P
I/O Board £45.00 + VAT + 50p P&P
Buffer Board £32.50 + VAT + 50p P&P

NEW
NAS-BUS EPROM Board £55.00 + VAT + 50p P&P

VISIT OUR NEW SHOP

Just 200 yards approx. Amersham station. We stock PET at discount prices, Sharp MZ-80K, and extensive range of electronic components including ICs, discrete semiconductors, capacitors, resistors, VERO products, OK Tools and accessories for both professional and amateur constructors.

Prices correct at time of going to press.

**INTERFACE COMPONENTS LTD.
OAKFIELD CORNER, SYCAMORE ROAD, AMERSHAM, BUCKS HP6 6SU
TELEPHONE: 02403 22307. TELEX 837788**

BARE BONES OF ROBOTICS

STUART BRIERS

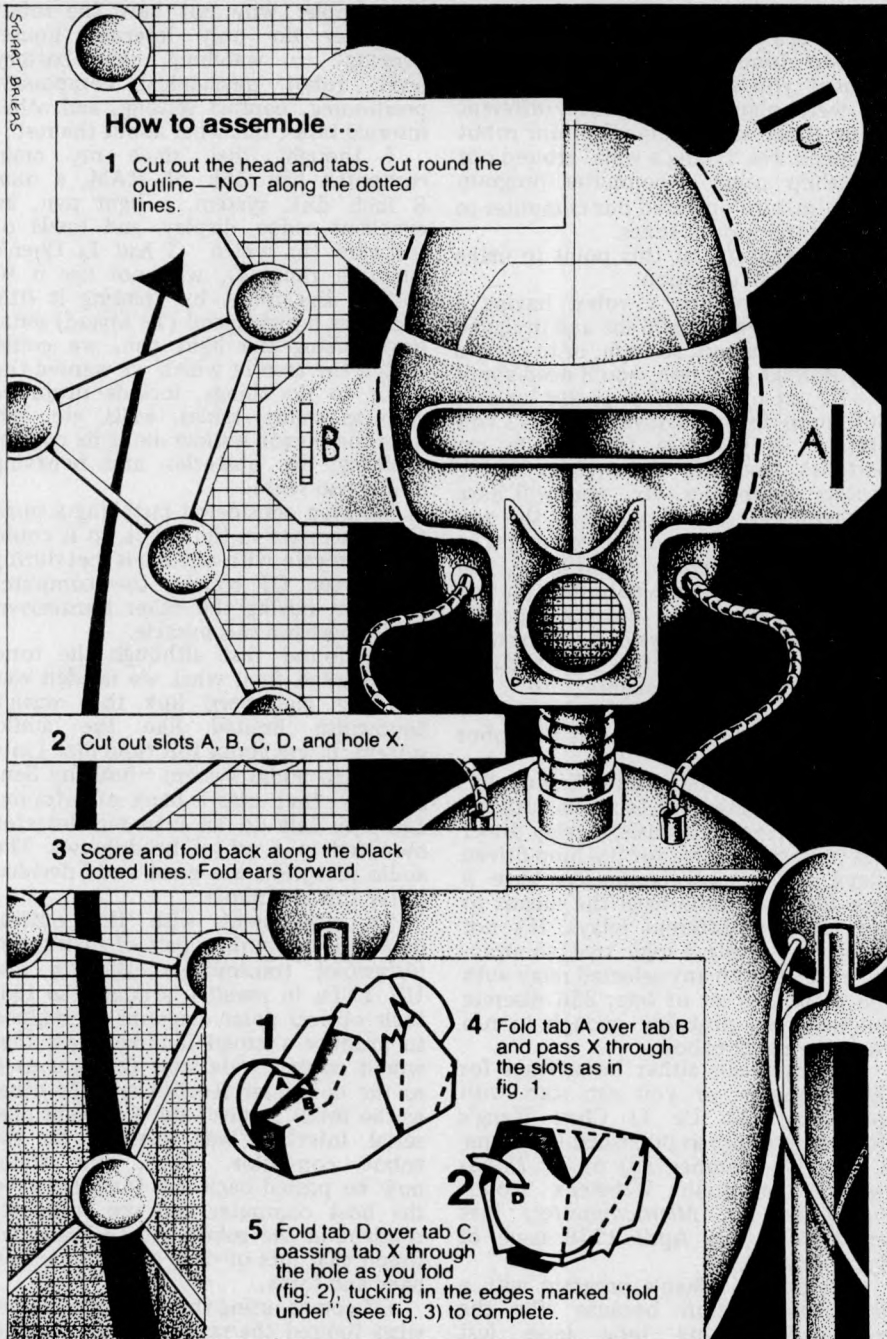

How to assemble...

1 Cut out the head and tabs. Cut round the outline—NOT along the dotted lines.

2 Cut out slots A, B, C, D, and hole X.

3 Score and fold back along the black dotted lines. Fold ears forward.

- 4 Fold tab A over tab B and pass X through the slots as in fig. 1.
- 5 Fold tab D over tab C, passing tab X through the hole as you fold (fig. 2), tucking in the edges marked "fold under" (see fig. 3) to complete.

One of the most fascinating projects for the hobbyist is a computer-controlled robot. Leslie Solomon, technical director of the US magazine Popular Electronics, passes on some tips and ideas.

I'll begin by telling you the story of the guy who went into the pizza parlour and ordered a large pizza. The man behind the counter asked him whether he should cut the pizza into six or eight slices. The customer said, "Cut it into six slices because I can't eat eight!"

The same is true of creating a robot — we have two large pieces, large enough so that we couldn't 'eat' them both. One half is the mechanics of robotics while the other half is computer. It's difficult enough to build

complex mechanics, rather than simultaneously having to sweat out a computer and its software.

There are two steps in creating a computerized robot: first it should be mechanically constructed and tested before installing the computer, then it should be mated with the computer, after the computer and its software have been tested.

Building the physical elements of a machine is just as difficult as constructing the computer interfaces and

writing the software. The question is like asking which came first — the chicken or the egg? Do we build the robot then the computer, or vice versa? Or do we build both together, and what do we do if the damn thing doesn't work? How do we decide where the problem is? I determined that we needed a separate electronic and mechanical approach and this is what we did.

Since we should be able to test the various physical elements of the robot as construction goes along, what's needed is a simple, low-cost, yet effective means to perform the tests, that also will emulate the future computer. In a real sense, we should first create our mechanical man analogue and have full control over it before we install the 'intelligence'. Let's first take a look at a simple remote control.

The most common and usually the first thing that comes to mind is radio control, using the same systems as model planes — provided you have enough channels. However, this involves RF transmissions, the need for a licence, and a possible visit from government-type people who usually have no sense of humour. There are a couple of other ways that don't involve RF and the need for a licence, and they remove the probability of external noise or signals causing unwanted problems.

The first approach is called Induction Transmission and can be built by anyone. Unless two experimenters work in the same building, there will be no cross interference, and you can have quite a number of signalling channels going at the same time.

The technique is simple. All you have to do is wind a turn or two of conventional insulated wire around the area where the robot experiments are to take place. In my case, I wound my turns along the junction of the walls and ceiling of my workshop. It makes no difference how small or large the area is as long as the total resistance of the wire is not excessive; you can wind the turn around an acre if you so desire. This turn forms the primary of what will wind up as a strange-looking transformer.

This turn of wire is connected to the output of a conventional audio amplifier — the power requirement depends on how large the loop is, but a 5 or 10 watt amplifier will usually suffice. The turn then simulates the speaker load. The secondary of the transformer is formed by using a lot of turns a few inches in diameter, with this coil connected to a small transistorized battery powered audio amplifier.

To test the basic system, feed a conventional music source to the loop amplifier and connect an earphone or even a speaker to the portable amplifier of the secondary. As long as you keep the portable secondary within the large primary turn and orient the secondary so that it is parallel with the primary, you should hear the music. The magnetic field is strongest within the turn, but it also extends outwards a little; if the turn is on an upper floor the music will be heard one or more floors above and below the loop.

Some of you will probably realise

that this magnetic induction technique can be used to listen to a silent radio (a boon for those of you that have teenage children who play their music at deafening volumes), or can even be used as a hearing aid for those who need it, without the constraints of having any interconnecting wires.

Now, suppose you build an array of audio tone generators, each operating at a different audio frequency and whose outputs can be connected to the input of the loop power amplifier. Each generator has a pushbutton switch that turns its associated tone on and off.

At the receiver there's a companion array of tone decoders following the audio amplifier — the 567 PLL is a good choice. The output of each tone decoder operates a simple transistor switch that opens or closes a relay. A look at the 567 specs will show several circuits that can be used.

Each relay controls the supply power to a particular motor; as each originating pushbutton switch is operated, the associated remote relay operates. Latching flip-flops can be arranged to maintain a tone for some period if desired.

That then is a simple yet powerful remote control system which can be used anywhere without causing any electronic problems. In fact, using this technique, it's possible to build and operate a complex robot without having a computer.

Now to the robot. Since it's always best to start at the beginning, the first consideration should be total robot movement. This usually requires consideration of how to obtain forward, backward, right/left rotation, sideways motion (if desired), and any other direction you see fit. Then you have to consider the degrees of freedom for each limb — these are the joints. You can have hinge, rotation and telescope and combinations of the above.

Two very important items we discovered at great cost — be sure to install limit stops on all mechanical motion and don't make the arms too long! It's amazing how much damage can come when cables and PC boards get ripped out by excessive rotational zeal, and how easily things get bent out of shape by heavy robots falling on them.

You, the builder, have to consider whether to use driven wheels, tracks or make articulated legs. Keep in mind that wheels and slender narrow tracks are good only in a billiard table type of environment — rough or soft surfaces may cause the machine to hang up, water can cause shorts, and mud is death.

After deciding on the means of motive power, it's best to start with the baseplate that mounts the drive motors, their battery, and the remote control receiver with one (or more) channel relays controlling motor power. Add sufficient weight to the baseplate to simulate the estimated final weight of the robot.

Using the master pushbutton switches on the tone system, you can now test the mechanism. Drive the baseplate around the area and thoroughly check its operation as to turns, forward and backward

operation, and stopping. The latter is very important!

By using the loop technique, you can now construct any types of limbs or other mechanical items and test them merely by connecting them to the receiver tone decoders. The testing does not have to take place on the robot itself. The cost of the small receivers is so low (just a loop, an OP amp and a tone decoder) that you can build a few of them, each with only one or two tone decoders, just for the element you are testing. At one time we were playing with three different items at the same time while our robot baseplate was 'taking a walk' around our workshop using a computer program which in turn operated our computer to turn on the various tones.

It'll be useful at this point to make another small diversion.

If you consider a robot having a planned weight of 100 lbs and designed to travel at about 20 mph, or to carry a 300 lb load at 5 mph, you'll need about 5½ HP, or some 5kW of power, or over 300 amps from a conventional 12 volt battery. If you use four 17 lb car batteries, and add the weight of the motors, mechanics, etc, you will have reached 100 lbs. If you cut the top speed to 10 mph, and the top weight to 200 lbs (100 machine + 100 load), you can cut down to two batteries. So you had better sharpen up your pencil, break out the old physics book, and do a lot of paper work before construction.

Give some thoughts to the installation of a small solid-state TV camera so you can 'see' what the robot is up to.

Now for the computer. Essentially, all the computer has to do is turn on (and Off) a simple transistor relay driver that now substitutes for the loop-driven relays. Since most computers have 8 data bits, you now have the means to turn on 256 different relays. It's not difficult to create a logic tree, so arranged as to turn on any selected relay with one particular set of bits; 256 discrete functions are probably enough to run even a complex robot.

Software can either be written for the computer, or you can start with something like Dr Li Chen Wang's 'Robot' language as published in volume 2, issue 8 (number 18) of *Dr Dobbs Journal*, or John Webster's *Robot Simulation On Microcomputers* that appeared in the April 1978 issue of *Byte* magazine.

We used Li Chen's program with a little modification because like the computer-emulating tone loop just described, you don't need a robot to use this software. The cursor on the video display substitutes for the actual robot and you can use the software to guide the cursor through its paces. The software enables the cursor to walk around obstacles. In real life, the signals driving the video cursor can be used to drive the robot.

So, now you are in an interesting position since it's possible to build and operate a robot without a computer, and you can design and test software without a robot. After all is cleaned up, you can combine the two.

Then there is the question of what the computer should do in the robot. Unfortunately, it's been found that

when you consider all the things that you would like the robot to do, you run out of computer — unless you install a disk system. With one thing leading to another, you suddenly realize that your computer will start to look like a tank and require submarine batteries.

There's no right answer as to what the robot computer should do; different people have different ideas. My answer was simple: why not have the robot computer do only internal 'house-keeping' — watching over battery level, robot mechanical component positioning, contact sensing, and other internal tasks. But what about the rest?

I thought that since my main computer had 56k of RAM, a dual 8 inch disk system, a light pen, an excellent video display and loads of software (in which I had Li Chen's language running), why not use it to control the robot by treating it (the robot) as a high-speed (19 kbaud) serial port? Using the light pen, we could sketch the area in which we wanted the robot to do things, include obstacles such as chairs, tables, walls, etc, and have the cursor wander along its course, avoiding the obstacles and behaving as if it had sense.

We even considered installing a small CB transceiver in the robot, so it could communicate with anyone it met during its travels. Of course, the computer operator, having the other transceiver, would perform this miracle.

We found that although the tone link worked fine, what we needed was a really high-speed link that wasn't bandwidth limited like the audio system. It was about this time that I saw a German audio system — built by Senheiser — that uses a bank of infra-red LEDs to talk to an infra-red detector mounted in a set of headphones. The audio reception was great and I decided to try this technique.

To experiment with this optical data link we built a pair of high-speed ultraviolet transmitters using a few UV LEDs in parallel, arranged so that their optical polar diagrams overlapped to produce a broad fan-like beam that would cover a wide area. One was used as the computer receiver and the other as the robot receiver and a conventional serial interface was installed on the robot computer. Thus, our robot now be passed back and forth between the host computer and the computer resident in the robot. At 19 kbaud we found that lots of data could be passed back and forth.

Of course, using this technique somewhat limited the range the robot could traverse even though we found out that the UV link could go around reasonable corners. The built-in TV camera, having its own RF link back to our TV receiver, enabled us to see what the robot was up to in its wanderings.

This approach may violate your concepts of what a robot is and how it should be controlled. But the robot, the induction loop and the optical system worked fine and we had a lot of fun. We've learned a lot — both from a mechanical and electronic viewpoint — and I guess that's what this computer stuff is all about.

Make your micro

WIGHTON



Get the most out of your microcomputer with Graham-Dorian Business software.

At any given time, your hardware is only as useful as the software you run in it. Our programs let you realise the full potential of your hardware

Graham-Dorian provides highly detailed and well documented programs. All pretested on the job. Each so comprehensive that it takes little time to learn to run a program — even for someone who's never operated a computer before.

Graham-Dorian programs are on-line now working for us and others around the world. They are ready to go to work immediately or to be tailored for your more specific needs. Each package contains a software program in BAS and INT film form plus a user's manual and hard copy SOURCE LISTING.

Programs are compatible with most major computers using CP/M disk operating systems, and come in standard 8" or on various mini-floppy disks.

Graham-Dorian stand behind dealers with technical advice.

Yes, there's a world of difference in business software. Graham-Dorian has more per-package capabilities and more packages (with new ones added every few months).

Distributors for Micropro:- Wordstar, Datastar & Mailmerge. CP/M for Tandy Model I & II

†GDS are appointing UK Dealers and European Distributors. Enquiries and applications invited.

*CBASIC-2 is a trade mark (copyright 1980) of Compiler Systems, Inc. GDS are the European Distributor for CBASIC-2.

The Graham-Dorian line now includes these packages:

- Nominal Ledger
- Purchase Ledger
- Sales Ledger
- Job Costing
- Order Entry & Invoicing
- Payroll
- Manufacturing Inventory
- Manufacturing Job Costing
- Wholesaler Inventory
- Retailer Inventory
- Cash Register
- Apartment
- Surveying
- Dental

CBASIC-2*

Ask your dealer for a demonstration soon.



Graham-Dorian Software Systems

A division of Graham-Dorian Enterprises & Terodec (Micro Systems) Ltd.

17 The Gallop, Yateley, Camberley, Surrey.
Tel: (0252) 874790/(0344) 51160

Britain's first com puter kit.

The Sinclair ZX80.

£79.95

Price breakdown

ZX80 and manual: £69.52

VAT: £10.43

Post and Packing FREE

Please note: many kit makers quote VAT-exclusive prices.

You've seen the reviews... you've heard the excitement... now make the kit!

This is the ZX80. 'Personal Computer World' gave it 5 stars for 'excellent value.' Benchmark tests say it's faster than all previous personal computers. And the response from kit enthusiasts has been tremendous.

To help you appreciate its value, the price is shown above with and without VAT. This is so you can compare the ZX80 with competitive kits that don't appear with inclusive prices.

'Excellent value' indeed!

For just £79.95 (including VAT and p&p) you get everything you need to build a personal computer at home... PCB, with IC sockets for all ICs; case; leads for direct connection to a cassette recorder and television (black and white or colour); *everything!*

Yet the ZX80 really is a complete, powerful, full-facility computer, matching or surpassing other personal computers at several times the price.

The ZX80 is programmed in BASIC, the world's most popular computer language for beginners and experts alike.

The ZX80 is pleasantly straightforward to assemble, using a fine-tipped soldering iron. It immediately proves what a good job you've done: connect it to your TV... link it to an appropriate power source... and you're ready to go.

Your ZX80 kit contains...

- Printed circuit board, with IC sockets for all ICs.
- Complete components set, including all ICs—all manufactured by selected world-leading suppliers.
- New rugged Sinclair keyboard, touch-sensitive, wipe-clean.
- Ready-moulded case.
- Leads and plugs for connection to domestic TV and cassette recorder. (Programs can be **SAVEd** and **LOADed** on to a portable cassette recorder.)
- FREE course in BASIC programming and user manual.

Optional extras

- Mains adaptor of 600 mA at 9 V DC nominal unregulated (available separately—see coupon).
- Additional memory expansion boards allowing up to 16K bytes RAM. (Extra RAM chips also available—see coupon).

*Use a 600 mA at 9 V DC nominal unregulated mains adaptor. Available from Sinclair if desired (see coupon).

The unique and valuable components of the Sinclair ZX80.

The Sinclair ZX80 is not just another personal computer. Quite apart from its exceptionally low price, the ZX80 has two uniquely advanced components: the Sinclair BASIC interpreter; and the Sinclair teach-yourself BASIC manual.

The unique Sinclair BASIC interpreter offers remarkable programming advantages:

- **Unique 'one-touch' key word entry: the ZX80 eliminates a great deal of tiresome typing. Key words (RUN, PRINT, LIST, etc.) have their own single-key entry.**
- Unique syntax check. Only lines with correct syntax are accepted into programs. A cursor identifies errors immediately. This prevents entry of long and complicated programs with faults only discovered when you try to run them.
- Excellent string-handling capability—takes up to 26 string variables of any length. All strings can undergo all relational tests (e.g. comparison). The ZX80 also has string input to request a line of text when necessary. Strings do *not* need to be dimensioned.
- Up to 26 single dimension arrays.
- FOR/NEXT loops nested up to 26.
- Variable names of any length.
- BASIC language also handles full Boolean arithmetic, conditional expressions, etc.
- Exceptionally powerful edit facilities, allows modification of existing program lines.
- Randomise function, useful for games and secret codes, as well as more serious applications.
- Timer under program control.
- PEEK and POKE enable entry of machine code instructions, USR causes jump to a user's machine language sub-routine.
- High-resolution graphics with 22 standard graphic symbols.
- All characters printable in reverse under program control.
- Lines of unlimited length.

Fewer chips, compact design, volume production—more power per pound!

The ZX80 owes its remarkable low price to its remarkable design: the whole system is packed on to fewer, newer, more powerful and advanced LSI chips. A single SUPER ROM, for instance, contains the BASIC interpreter, the character set, operating system, and monitor. And the ZX80's 1K byte RAM is roughly equivalent to 4K bytes in a conventional computer—typically storing 100 lines of BASIC. (Key words occupy only a single byte.)

The display shows 32 characters by 24 lines.

And Benchmark tests show that the ZX80 is faster than all other personal computers.

No other personal computer offers this unique combination of high capability and low price.

Z80 A microprocessor - new, faster version of the famous Z-80 microprocessor chip, widely recognised as the best ever made.

Sockets for TV, cassette recorder, power supply.

SUPER ROM.

Clock.

Rugged, flush, Sinclair keyboard.

UHF TV modulator.

RAM chips.

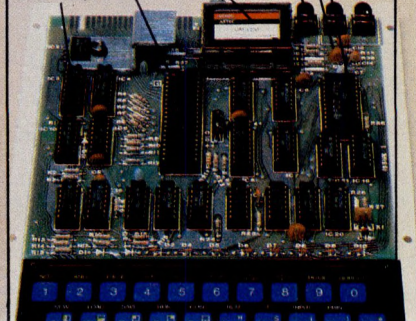

plete

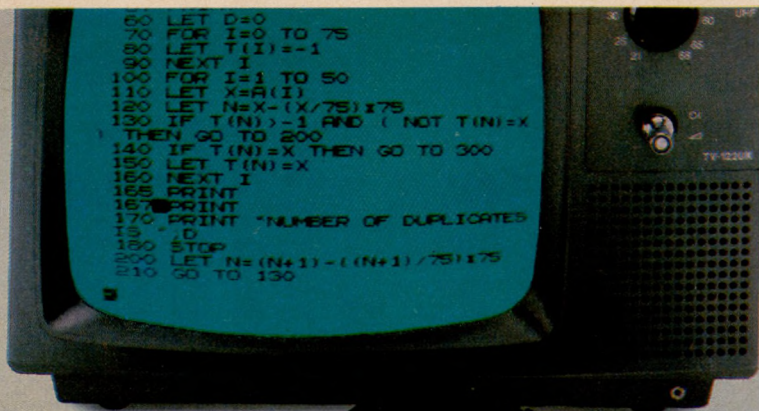

The Sinclair teach-yourself BASIC manual.

If the features of the Sinclair interpreter mean little to you – don't worry. They're all explained in the specially-written 128-page book *free* with every kit! The book makes learning easy, exciting and enjoyable, and represents a complete course in BASIC programming – from first principles to complex programs. (Available separately – purchase price refunded if you buy a ZX80 later.) A hardware manual is also included with every kit.

The Sinclair ZX80. Kit: £79.95. Assembled: £99.95. Complete!

The ZX80 kit costs a mere £79.95. Can't wait to have a ZX80 up and running? No problem! It's also available, ready assembled and complete with mains adaptor, for only £99.95.

Demand for the ZX80 is very high: use the coupon to order today for the earliest possible delivery. All orders will be despatched in strict rotation. We'll acknowledge each order by return, and tell you exactly when your ZX80 will be delivered. If you choose not to wait, you can cancel your order immediately, and your money will be refunded at once. Again, of course, you may return your ZX80 as received within 14 days for a full refund. We want you to be satisfied beyond all doubt – and we have no doubt that you will be.

sinclair
ZX80
Science of Cambridge Ltd

6 Kings Parade, Cambridge, Cambs., CB2 1SN
Tel: 0223 311488.

ORDER FORM

To: Science of Cambridge Ltd, 6 Kings Parade, Cambridge, Cambs., CB2 1SN.
Remember: all prices shown include VAT, postage and packing. No hidden extras.
Please send me:

Quantity	Item	Item price £	Total £
	Sinclair ZX80 Personal Computer kit(s). Price includes ZX80 BASIC manual, excludes mains adaptor.	£79.95	
	Ready-assembled Sinclair ZX80 Personal Computer(s). Price includes ZX80 BASIC manual and mains adaptor.	£99.95	
	Mains Adaptor(s) (600 mA at 9 V DC nominal unregulated).	8.95	
	Memory Expansion Board(s) (each one takes up to 3K bytes).	12.00	
	RAM Memory chips – standard 1K bytes capacity.	16.00	
	Sinclair ZX80 Manual(s) (manual free with every ZX80 kit or ready-made computer).	5.00	

NB. Your Sinclair ZX80 may qualify as a business expense.

TOTAL £

I enclose a cheque/postal order payable to Science of Cambridge Ltd for £ _____

Please print

Name: Mr/Mrs/Miss _____

Address _____

PCW 10/80

Can your business, research project or teaching laboratory be made more efficient? Yes. Today's users demand complete, high performance micro computer systems. Expandable to meet future needs and with software capable of immediate application.

The North Star Horizon is the answer. A cleverly balanced configuration: Z80A processor with 12 slot S100 chassis, one parallel and two serial interface ports. Now with double or quad capacity too.

The compact design gives you value for money and economy of space. The Horizon will not break your bank or your desk top.

Quick delivery and nationwide service are only part of the attraction. Add to this the wealth of software available, including the well known CP/M, and you can see why the Horizon has already sold in thousands.

The reason for its success is simple.

The North Star Horizon reflects your needs.



For technical specification and details of your nearest dealer contact Britain's leading North Star Supplier.



comart

PO Box 2, St. Neots, Cambridgeshire.
Tel: (0480) 215005. Telex: 32514.
COMART G.

**North Star Horizon
reflects a new age in computing**

CALCULATOR CORNER

This month Dick Pountain takes a breather from key-pressing to look at a fascinating and thought-provoking book

Gödel, Escher, Bach

Having regaled you for a couple of months with readers' programs, I now propose to shoot off at a tangent by reviewing a remarkable book which has nothing to do with programmable calculators. Nevertheless the contents of the book, *Gödel, Escher, Bach* by Douglas Hofstadter will certainly mesmerize many readers of this column, as they did me, especially if, as I suspect, you are more mathematically biased than the average computerer. Hofstadter is, incidentally, the assistant professor of Computer Science at Indiana University.

The book is so original in style and content that it is infuriatingly difficult to convey in a few words what it is about. It isn't about mathematics, music, painting, philosophy, molecular biology, computers, neuroscience or artificial intelligence. In fact it is about all these subjects but intertwined in such a unique way that no-one should be scared off by ignorance of any of them.

The principal theme running through the book is the notion of recursion, of recursive processes, recursive thought, recursive computer programs etc. This theme is extracted from the work of Hofstadter's three inspirers; the Incompleteness theorem of Kurt Gödel, the music of Johann Sebastian Bach, and the paradoxical paintings of M C Escher. If you think that sounds pretentious all I can do is assure you that it isn't; Hofstadter's light touch nimbly sidesteps the precious and the pseudo-intellectual and you will very quickly accept his demonstrations that the structures of a Bach Canon, of Gödel's *Proof* and Escher's *Waterfall* have in common a particular form of recursion (or self-reference) which he terms the "strange loop". And from there you will be effortlessly led through the theory of formal systems, logic, number theory, computer languages and up to some remarkable hypotheses about the mode of functioning of the human brain and the possibility (to Hofstadter a *certainty*) of artificial intelligence. You may surmise from this that it is not light reading and indeed it is a very demanding book which can on occasion make one's brain hurt. But it is rendered utterly absorbing and readable by the astonishing tour-de-force of style which Hofstadter has accomplished. Not so much the prose style, which though readable tends to the slightly whimsical American East Coast Academic, but the form.

The book is written in alternating chapters and dialogues. The dialogues, which are humorous but which illustrate points to be made in the following serious chapter, are between Achilles

and the Tortoise, characters borrowed from Zeno's Paradox.

Many of the dialogues are written with a structure which reflects their content, such as the one about the Crab Canon, a musical form where a theme is played forwards and backwards simultaneously in different voices. This dialogue imperceptibly stops in the middle and then repeats its words in reverse order while making perfect sense, in the manner of a verbal palindrome. It is impossible to list all the tricks and devices, puns on many levels, acrostics and such which are woven into this book; in fact the text itself is structured as an Endlessly Rising Canon, since the final words take you back to page one but on a higher level of abstraction!

The book abounds with problems for the reader, many of which will delight the calculator buff and which may be solved by a calculator program. One such example which had me grabbing for my Casio occurs in the section on number theory. A number is chosen; if it is odd, triple it and add 1; if it is even, halve it. Then repeat the process. If by enough repetitions you arrive at 1 the number is a Wondrous number; if not it is Unwondrous. With some starting numbers the journey down to one is very long indeed. I played for several hours with a Casio program for testing numbers for the property of "wondrousness". The fact is that no-one has ever discovered an unwondrous number, but it cannot be proved that they don't exist! This example was introduced to illustrate the idea of terminating and non-terminating searches, which then leads Hofstadter on to the theory of Turing machines, those primitive imaginary computers which can nevertheless in time perform any task which is possible on the largest mainframe. There follows a chapter in which Hofstadter invents three simple computer languages to illustrate Turing's theory. This chapter has some comfort for calculator fans, since he demonstrates that any language which allows loops and conditional tests to control looping is capable of solving any problem which is computable. This means that in a curious (and not very useful!) sense, a TI-59 or Casio 502 or HP-67 is as powerful as any computer which has ever been built or ever could be built. The fact that it may take several million years to compute some problems should not be allowed to spoil our new found pride!

Hofstadter goes on to discuss recursive functions and recursive programming in such a lucid way that I grasped the concept properly for the first time, along with pushing, popping and the

operation of stacks, which had previously filled me with a certain unease. In fact I was immediately moved to write some recursive programs for the Casio, which is quite easy due to the automatic subroutine return feature. A program can call itself as a sub-routine without becoming ensnared by left-over Return commands. Unfortunately recursive programming on the Casio is not very rewarding since the stack only has ten registers and so recursions can only nest to a depth of ten, which is quite useless for evaluating a series from a recursive function such as the Fibonacci series, $F(x) = F(x-1) + F(x-2)$, beyond ten terms.

If I tell you that not far from here Hofstadter has moved on to the genetic code considered as a formal system, and then onto the brain considered as a hierarchy of computer languages, you will begin to get an idea of the scope and density of this work.

Unlike many such works written in the last decade, *Gödel, Escher, Bach* has no trace of crankiness, nor any megalomaniac tendencies. Hofstadter is not preaching any soul-saving new revelation; indeed he is quite scornful of the guru culture and all its ramifications, as well as the craze for the 'paranormal'. His book is concerned with science, with certain threads in modern science which are of profound significance and which have never been pulled together in this way before. Rather than write another weighty textbook he has chosen to humanise his theme by his witty use of analogies drawn from art. As a result, any intelligent reader of PCW should have no trouble in following his path through these difficult regions. Anyone with any interest in computers must read it, if only for his wise and spirited defence of artificial intelligence. And anyone with a love of mathematics will, like myself, be very sad when the last/first page rolls around.

As a final tantaliser for programmers, I can reveal that in chapter 14, Hofstadter invents a simple alphabetic formal system which he calls "Typogenetics". By manipulating the symbols C, G, A and T according to a few simple rules, this system mimics very convincingly the way in which DNA replicates itself and codes for the synthesis of enzymes. The system looks to me a very suitable candidate for programming on a micro or even maybe an HP-41C. The result would be like a biochemical version of the 'Life' game. Anyone out there interested?

Gödel, Escher, Bach by Douglas R Hofstadter, Harvester Press 1979 £10.50.

FACE TO FACE

characters) that some areas of the screen, once set up by the program, are 'protected', ie cannot be modified from the keyboard. Other areas are 'unprotected' and can be used for data entry from the keyboard. The actual control characters used to implement this technique vary enormously from display to display, there being no provision in ASCII for this capability.

In the following example, I am using '[' (left square bracket) to indicate start input field and ']' right square bracket) to indicate end input field. The screen is initially displayed with the input fields blank and the cursor positioned at the beginning of the first item.

```
DATE: [  ]
A/C NUMBER: [  ]
AMOUNT: [  ]
TRANS. TYPE: [  ]
```

The underline indicates the position of the cursor. Seven characters are allowed for the date which is entered in the

DDMMYY format. When the last character is typed the cursor will automatically skip to the beginning of the next field (A/C NUMBER). This continues until the last item has been entered:

```
DATE: [24APR80]
A/C NUMBER: [4978465]
AMOUNT: [124.50]
TRANS. TYPE: [C]
```

In the case of items which do not fill the available space, the user will have to press a special key (usually TAB) to indicate that he has finished and to force the cursor to the next item.

When the transaction has been completed, a single command can be used from the program to clear the input items *only* and to return the cursor to the start. In the above example, even better use can be made of the screen by changing the format as follows:

TRANSACTION INPUT			
DATE	ACCOUNT NUMBER	AMOUNT	TRANS TYPE
[] [] [] []	[] [] [] []	[] [] [] []	[] [] [] []
[] [] [] []	[] [] [] []	[] [] [] []	[] [] [] []
[] [] [] []	[] [] [] []	[] [] [] []	[] [] [] []
[] [] [] []	[] [] [] []	[] [] [] []	[] [] [] []
[] [] [] []	[] [] [] []	[] [] [] []	[] [] [] []
[] [] [] []	[] [] [] []	[] [] [] []	[] [] [] []
[] [] [] []	[] [] [] []	[] [] [] []	[] [] [] []
[] [] [] []	[] [] [] []	[] [] [] []	[] [] [] []
[] [] [] []	[] [] [] []	[] [] [] []	[] [] [] []

... and so on for as many lines as you can fit on the screen. This technique is also possible on memory-mapped video systems such as the Apple and PET. In these cases the effect is achieved not by the use of control characters but through the judicious use of cursor control and the Basic GET command. More ideas on the 'forms mode' style of dialogue will be discussed next month.

BENCHMARKS

We have received a large number of requests for details of the Benchmark programs used in our Benchtests so we're reprinting them here. You'll also find the timings for machines Benchtested since May this year, including those in this issue.

The Benchmark programs, originally published in *Kilobaud*, are fairly self-explanatory and provide a rough rule-of-thumb guide to the efficiency of the machines' Basic interpreters and, to a lesser extent, to the efficiency of certain aspects of hardware design. They should be interpreted as such, and not used as absolute guides to which machine is 'better' than another; this is a decision which involves a great many factors and which can only be arrived at by studying the full Benchtests and by forming a clear idea of which machine is best suited to the purpose to which you intend to put it.

The disk Benchmark timings which were introduced earlier this year have not been listed, and neither have the disk timings been reproduced here as they do not apply to all machines. As different dialects of Basic have such widely different disk I/O formats, we cannot provide listings of a specific suite of programs which can run unaltered on any machine. Here, however, is a summary of what the disk tests do:

Test 1 OPEN a new file, then immediately CLOSE it.
 Test 2 Using a FOR . . . NEXT loop, fill two strings, A\$ and B\$ with 128 As each; OPEN an existing file; using a FOR . . . NEXT loop, fill each of the 100 records, each of which contains two fields of 128 characters, with A\$ and B\$ in ascending order; CLOSE the file.
 Test 3 Identical to Test 2 except that the records are written in reverse order.
 Test 4 OPEN the file; read records 1 to 100 into A\$ and B\$; CLOSE the file.
 Test 5 Identical to Test 4 except that the records are read in reverse order.

	BM1	BM2	BM3	BM4	BM5	BM6	BM7	BM8
Altos ACS 800-2	1.4	4.3	11.3	11.3	12.0	21.2	34.9	2.7
TRS-80 Model II (Int)	1.0	4.0	13.0	13.0	14.0	20.0	30.0	6.0
(S/prec)	1.0	5.0	13.0	13.0	14.0	23.0	35.0	6.0
(D/prec)	—	6.0	41.0	43.0	44.0	52.0	65.0	7.0
Periflex 630/48	4.5	10.5	27.5	28.5	31.5	59.0	79.5	60.0
Acorn Atom (Int)	0.8	5.5	10.0	11.5	14.5	20.0	31.5	—
(F/P)	—	—	30.5	27.0	30.0	—	—	26.0
DDE SPC/1	4.8	6.2	14.7	13.9	14.7	41.1	58.1	2.6
SuperBrain	1.6	5.2	14.0	13.9	14.8	26.3	43.2	5.6
BASF 7120	2.4	7.0	35.0	36.5	39.0	50.0	63.0	114.0
Atari 400/800	2.3	7.4	19.9	23.2	26.8	40.7	61.5	43.1
DAI	0.9	4.8	10.1	9.8	11.2	18.1	30.1	2.1
CBM 8032	1.7	10.0	18.4	20.3	21.9	32.4	51.0	11.9

Int = Integer Basic
 F/P = Floating point Basic

S/prec = Single precision
 D/prec = Double precision

All timings in seconds.

BM1	300 PRINT "S" 400 FOR K=1 TO 1000 500 NEXT K 700 PRINT "E" 800 END	BM6	300 PRINT "S" 400 K=0 430 DIM M(5) 500 K=K+1 510 A=K/2*3+4-5 520 GOSUB 820 530 FOR L=1 TO 5 540 NEXT L 600 IF K<1000 THEN 500 700 PRINT "E" 800 END 820 RETURN
BM2	300 PRINT "S" 400 K=0 500 K=K+1 600 IF K<1000 THEN 500 700 PRINT "E" 800 END	BM7	300 PRINT "S" 400 K=0 430 DIM M(5) 500 K=K+1 510 A=K/2*3+4-5 520 GOSUB 820 530 FOR L=1 TO 5 535 M(L)=A 540 NEXT L 600 IF K<1000 THEN 500 700 PRINT "E" 800 END 820 RETURN
BM3	300 PRINT "S" 400 K=0 500 K=K+1 510 A=K/K*K+K-K 600 IF K<1000 THEN 500 700 PRINT "E" 800 END	BM8	300 PRINT "S" 400 K=0 500 K=K+1 530 A=K↑2 540 B=LOG(K) 550 C=SIN(K) 600 IF K<1000 THEN 500 700 PRINT "E" 800 END
BM4	300 PRINT "S" 400 K=0 500 K=K+1 510 A=K/2*3+4-5 600 IF K<1000 THEN 500 700 PRINT "E" 800 END		
BM5	300 PRINT "S" 400 K=0 500 K=K+1 510 A=K/2*3+4-5 520 GOSUB 820 600 IF K<1000 THEN 500 700 PRINT "E" 800 END 820 RETURN		

PCW SUBSET

Continuing PCW's unique series aimed at the serious programmer working in assembler language, Alan Toothill brings more examples of work sent in by readers.

Relative calls

We said last month that we might use relative calls to produce position independent code. The Z80 does not have a relative call instruction, so we need some code to do it and this is the subject of our first Datasheet this month.

Location

A routine with such wide general use will need a location that does not change. What better place than one of the eight Z80 restart locations 00H, 08H, 10H, 18H, 20H, 28H, 30H, 38H, if you have one free? The routine can then be entered with a one-byte RST instead of a three-byte CALL, with the displacement now following the RST. Nascom does this in its NAS-SYS1 monitor.

The problem

The problem with this routine is in incrementing the return address to skip the displacement byte, after saving any registers used in doing this. Not having to save the DE register at this stage, NAS-SYS1 neatly uses the six bytes of:-

```
POP HL ; to add 2 to SP.
POP HL ; get return address
INC HL ; increment it and
PUSH HL ; save it.
DEC SP ; subtract 2
DEC SP ; from SP.
```

compared with the 12 bytes of our 3rd to 12th instructions.

But this will not make a PCW Class 1 routine because it is not interruptable. An interrupt when the address in SP is above the address of any values on the stack we want to save can corrupt those values. So our 12 bytes is the best we can do. Or is it?

1 Byte into 2

See how the single byte displacement in A, which might be positive or negative, is loaded into the double byte DE register:

```
LD E,A
RLCA
SBC A,A
LD D,A
```

Have you a better way?

RLTV in action

A reader has sent a routine which calls another routine it contains both from behind and ahead. Ideal for testing RLTV! You will also need a routine, called INPUT here, to wait for a character from the keyboard and return with it in A. The subroutine called by RLTV is labelled LSCN3. The routine enters characters from the keyboard, calculator fashion, into the least significant end of a RAM field. If you have a video RAM system, set the DE register to point to the end of a field in the video

Datasheet

```
= RLTV - Relative call
;/ "RLTV" - level 0; class 1
;/ TIME CRITICAL?: No
;/ Causes a call to the address formed by adding the displacement,
;/ given in the byte following the CALL RLTV instruction, to the
;/ address of the next instruction following the displacement byte
;/ ACTION: ( SP + 0/1 ) <- ( SP + 0/1 ) + 1
;          ( SP - 1/2 ) <- ( SP + 0/1 ) + displacement
;          PC low <- ( SP - 2 )
;          PC high <- ( SP - 1 )
;/ INPUT: The byte following the CALL RLTV instruction holds the
;          positive or negative displacement
;/ OUTPUT: The program counter is set to the address of the
;          displaced routine to be executed
;/ REGs USED: None
;/ STACK USE: 6
;/ LENGTH: 27
;/ SUBr DEPENDENCIES: None
;/ INTERFACES: None
;/ 8080 COMPATIBLE? Yes
```

```
RLTV: PUSH HL ; save E5
      PUSH DE ; registers. D5
      LD HL, +4 ; get in HL 21 04 00
      ADD HL, SP ; SP value on entry. 39
      LD E, (HL) ; get displacement 5E
      INC HL ; address 23
      LD D, (HL) ; in DE 56
      INC DE ; increment it 13
      LD (HL), D ; and 72
      DEC HL ; return it 2B
      LD (HL), E ; to the stack 73
      EX DE, HL ; and HL register. EB
      DEC HL ; point back to displacement 2B
      PUSH AF ; save AF. F5
      LD A, (HL) ; get displacement and 7E
      LD E, A ; store it in E. 5F
      RLCA ; put sign bit in carry 07
      SBC A, A ; propagate it through A 9F
      LD D, A ; and store in D. 57
      INC HL ; get next instruction addr. 23
      ADD HL, DE ; add displacement. 19
      POP AF ; restore F1
      POP DE ; AF and DE D1
      EX (SP), HL ; restore HL and put displaced E3
; address 2nd on stack.
      RET ; return to displaced routine. C9
```

Datasheet

```
= LSCN - Enter characters calculator fashion
;/ "LSCN" - level 1; class 1
;/ TIME CRITICAL?: No
;/ Loads RAM from the keyboard to the highest addressed byte
;/ of a field, shifting previous entries to adjacent lower locations.
;/ ACTION: A <- keyboard
;          ( DE - 1 ) <- ( DE )
;          ( DE - 2 ) <- ( DE - 1 ) etc
;          ( DE ) <- A
;          B <- B - 1
;          repeated until B = 0 or
;          return code entered
;/ INPUT: B contains maximum number of characters to be entered.
;          C contains a code to return before the maximum number
;          of characters has been entered.
```

(Continued on next page)

```

; DE contains the address of the end of the RAM field
; in which data is to be entered.
; The RAM field in which data is to be entered is
; space filled.
;/ OUTPUT: The RAM field, at and below the location pointed to
; on entry by the DE register, will contain input from
; the keyboard.
;/ REGs USED: BC DE
;/ STACK USE: 6 + 4 x (contents of B on entry)
;/ LENGTH: 31
;/ SUBr DEPENDENCIES: INPUT — to get a character from the keyboard in A.
; RLTV — Relative call.
;/ INTERFACES: Keyboard
;/ 8080 COMPATIBLE?: No
LSCN: PUSH AF ; save AF. F5
INC DE ; position RAM field pointer. 13
LSCN1: CALL INPUT ; get chr from keyboard CD XX XX
CP C ; and if "return" B9
JR Z, LSCN2; leave routine. 28 06
CALL RLTV ; relative call to LSCN3 CD XX XX
DEFB +4 ; to put input in RAM 04
DJNZ LSCN1 ; get next input 10 F4
LSCN2: POP AF ; else restore AF F1
RET ; and return from LSCN. C9
LSCN3: PUSH AF ; save previous entry F5
DEC DE ; point one chr down. 1B
LD A, (DE) ; get current chr 1A
CP 20H ; and if space jump to shift FE 20
JR Z, LSCN4; previous entries and load 28 04
input into RAM
CALL RLTV ; else relative call to LSCN3 CD XX XX
DEFB -11 ; to stack previous entries. F5
LSCN4: POP AF ; restore previous entry. F1
LD (DE), A ; put it in RAM. 12
INC DE ; increment RAM pointer 13
RET ; return either for next C9
previous entry or for next
input.

```

RAM, so that you will see on the screen the data as it is entered. The routine is in our second Datasheet.

Recursion

The second relative call comes within LSCN3 calling itself. If you have other examples of recursion like this, send them in and we will do a separate feature on them.

With its relative calls and recursion, LSCN is an interesting little routine. But is it the best way to enter characters calculators fashion? You tell us!

Join in

This piece on datasheets, and probably next month's, has to go to press before there has been time for any response to the September issue, in which the project was launched.

The idea is to build up a collection of machine-code routines, improved to a high standard by exposure and criticism. We will be trying to see that you who submit routines gain more from the exercise than readers who do not, perhaps by way of access to material there might not be space to print. You will in any case gain from putting your work into a shape fit for other people to see.

If you have any contributions for PCW Sub Set, send them to: PCW Sub Set, PCW, 14 Rathbone Place, London W1P 1DE.

15 good reasons for visiting Cambridge

1. TRS-80 Model I & II
2. Apple II & III
3. CBM (PET) 3000/8000
4. North-Star Horizon
5. Cromemco
6. Hewlett-Packard HP-85
7. Compukit
8. Sinclair ZX80
9. Acorn Atom
10. Infoton vdu
11. Houston
12. Qume
13. Centronics
14. WordStar

With a uniquely comprehensive selection like this — all generally on demonstration and available from stock with full support by our team of computer professionals — you'll have the ideal chance of finding precisely the right system for your application.

Looking for a microcomputer? — then visit us at:

Cambridge Computer Store

1 Emmanuel Street Cambridge CB1 1NE
Telephone: (0223) 65334/68155

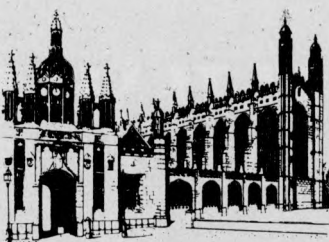

Da Vinci Computer Shop

65, High Street, Edgware, Middx HA8 7DD.

Open

Mon-Fri 9-5.30

Sat 9.30-5.30



Tel 01-952 0526

**SALES/PURCHASE -
LEDGER ACCOUNTING
INCOMPLETE RECORDS**

**WORD PROCESSING,
INVOICING - PAYROLL**

**STOCK CONTROL,
INFORMATION RETRIEVAL**

NEW PRICE PETS
CBM 32K £695.00
CBM 3040 FLOPPY £695.00
CBM 3022 PRINTER £425.00

**NEW 80 COLUMN
SCREEN PET**
£895.00

**NEW 1 MEG DISC
DRIVE £895.00**

**DUPE SPRINTS
DAISY PRINTER**
£2115.00

Da Vinci Computer Shop

OUR SYSTEMS ARE MASTERPIECES - COME AND SEE THEM!

DO YOU USE FLOPPIES?

IN YOUR MINI, MICRO COMPUTER
OR WORD PROCESSOR

Then we have a **cadle** floppy to suit
your equipment

- ★ Every Diskette individually certified Error Free
- ★ Direct from the USA, so we are cheaper
- ★ Colour-coded labels included
- ★ No delivery charge

Cash with order **10%** discount off our published price list

SPECIAL OFFER
Pack of 10 for PET
send cheque for
£21.50!
including VAT and delivery

CALL US
NOW FOR PRICE LIST

01-460 9586

cadle computer resources ltd
17 church road · bromley · kent · br2 0eg

BYTE SHOP COMPUTERLAND

your specialist Computerstore.

Commodore Business System



Well-proven systems for the serious user. Our computer stores are staffed by business experts, backed by first class maintenance support.

The Commodore is a complete computerized business system, ideal for first time users. Based on the world famous PET computer, it is easy to use and extremely cost-effective. The system includes large capacity disks

and an excellent quality printer thus bringing many applications within the reach of the small business.

Find out why the Commodore Business System is so popular – call in to any of our shops for advice and a demonstration of this and other systems.

London

48 Tottenham Court Road
London W185 4TD
Tel. 01-636 0647

Nottingham

92a Upper Parliament Street
Nottingham NG1 6LF
Tel. 0602 40576 Telex. 377389

Manchester

11 Gateway House
Piccadilly Station Approach
Manchester
Tel. 061-236 4737 Telex. 666168

Birmingham

94-96 Hurst Street
Birmingham B5 4TD
Tel. 021-622 7149 Telex. 336186

Glasgow

Magnet House
Waterloo Street
Glasgow Tel. 041-221 7409
Telex. 779263

BYTE SHOP
COMPUTERLAND
— your specialist Computerstore.

SECRETS OF SYSTEMS ANALYSIS

Lyn Antill continues this country's first serious attempt to enable prospective computer users and micro specialists to bridge the gulf of misunderstanding that undoubtedly exists between them. The aim of the series is to enable users to analyse their own problems so that both sides are able to work constructively together towards successful system implementations.

Most of the first article in this series was devoted to justifying the existence of systems analysis as a discipline distinct from computer programming. I finished with a few examples to illustrate the importance of defining in advance exactly what it is you want your micro to do for you and what can go wrong if you don't. I shall be referring again to the saga of Mr Bloggs' garage.

Definitions

I must stress the word *defining*; which is more than just *deciding*. Requirements have to be spelt out in detail for two reasons: the first is to encourage the user to follow through the implications of what he thinks he wants to do to see whether or not it is feasible and that nothing has been left out; the second is that the person writing the programs will know nothing about those requirements except what has been written down. He (or she) will not have years of accumulated knowledge of the business and the way it works, nor of any specialised vocabulary involved.

Even if you are going to write your own programs, don't kid yourself that you'll be able to get away without this definition of requirements. Programming is a complicated activity, concentrating the mind on the technicalities of the machine, and unless you have already defined what you need, you will be tempted to settle for the solution that is easiest to program, or one that although elegant, isn't relevant.

A definition does not have to be fixed and inflexible. You can modify it as you go along. (At least you can if it's only micro-sized.) But this does presuppose that there is something written down to modify. The main reason for this is that you might not otherwise see the implications of the change that you want to make. A common mistake is to change A, forgetting that it needed to be like that to fit in with B, and realising too late that the system doesn't work because you should have changed B as well. Don't forget, though, that if you change the requirements after the programs have been written, or even partly written, then you have paid for quite a few man-hours' work that will have been wasted writing programs to do things that aren't required.

Having now (hopefully) convinced anyone who might have doubted the importance of defining requirements, I can go on to discuss how this might

be done. Not, unfortunately, with 'the way to do it', because systems analysis is a field of human endeavour rather than an academic discipline and so there are never right or wrong methods or solutions, just ones which seem more or less appropriate.

Getting started on the problem

So you've got a problem and you think a microcomputer might provide the solution. *Wrong!* You might be able to use a microcomputer as a tool to implement a solution. It is the use you are able to make of it rather than the machine itself which will determine whether your life is any easier or your business any more efficient. Lesson number two — a microcomputer cannot solve your problems but a *system* based on a micro might.

So you've got a problem and you think a micro-based system might provide the solution. The first stage in finding out whether or not you need a micro is to define the problem; this is the analysis stage. But how do you set about doing that? Well, it's just like any other problem — you find an impartial and sympathetic listener and talk it through. If you go to someone with the same problem, you'll both finish up crying in your beer. If you go to someone like a micro shop, then they have a vested interest in providing you with a certain sort of 'solution' which might not actually make things any better. The salesman should be able to discuss impartially the strengths and weaknesses of the systems he stocks, and what each can do, but he cannot be impartial about your problem.

If you cannot find a listener then you are probably just as well off imagining one. Personally I find this very helpful, especially if I don't know where to start. I form a clear mental picture of someone who is intelligent, sympathetic, not conversant with the work, but totally interested and who will listen without interrupting, then ask perceptive questions about what I am explaining. You've probably written me off now as some sort of nut but thinking is a difficult process and one needs tools and techniques for doing it well. Almost invariably a genius is able to explain the techniques he uses for performing hefty intellectual tasks and most academic teaching is intended to train the student to think. Well, this is my thinking tool for analysing a pro-

blem — explain it to your 'analyst'.

This explaining isn't a simple one-off business. The more time and trouble you put into it, the more insight you will gain. Perhaps the best thing about this reflection is that it doesn't cost anything. It is the sort of thing you do automatically when you stand back from the problem and 'get things into perspective'. It is when you can't take time off that you have to discipline yourself to look objectively at what you are trying to do. This brings us to lesson number three: you can't solve the problem until you know what it is.

Knowing the problem

It is very important to remember that you are not sketching out a solution at this stage, merely trying to explain the problem. In part one, Mr Bloggs hadn't spelt out the problem, although I think I can guess what it was. As each item was sold, that sale should have been recorded so that the item could be re-ordered. Analysing the records to see what needed to be re-ordered obviously took time and was perhaps prone to careless mistakes, but the real problem arose when sales were not recorded; only laborious stock-checking could correct that. Every sale should have been recorded on the till roll, although the product code might not have been entered correctly and there would be no way of checking that. Also, there would be no way, other than checking through the whole roll again, of making sure that the tedious and lengthy job of keying all the data from the till roll had been performed without any mistakes. From my experience of boring key-punching jobs done at close of day, there would be lots of mistakes made and even more in trying to make corrections. So the suggested solution appears to be making even heavier going of the recording, which was causing the problem in the first place. Of course this is only a very superficial reading of the situation, based only on the published letter and I have used it solely to illustrate the general point that the first step in designing a new system is to put your finger on what is causing problems in the old one.

What features do you want to keep?

The next stage, having found out what we want to change, is to decide what we want to keep. We've defined the pro-

lems, now let's define the good features; don't replace Victorian terraces with tower blocks.

Before micros came along I used to work with visible record computers, particularly the Burroughs L range. The first complete system I was responsible for installing was remarkably successful. It handled twice as much work with half the number of staff and kept records which were significantly more accurate and up-to-date. When I studied the system a few years later I was disturbed to find that it only worked because the Burroughs ledger cards looked sufficiently like the old NCR ones that the accounts clerks could check the work in the same way they had before. If I had stored on a floppy disk the information that was on the magnetic stripe at the back of a ledger card, then I might have known that it held the same information but there was no way the accounts clerks could have proved it. I would have had to invent new clerical procedures for checking the accuracy of the accounts. In this case the good feature that I had under-valued was the ease with which the visual data on the ledgers could be checked and cross-checked.

It is a standard human failing to be more aware of what is wrong than of what is right. You take it for granted that if your new system puts right what is wrong with the old, you will be better off. If you don't spell out what is worth keeping, you might find you've lost it. When you're telling the programmer what needs to be done, try to remember all the things you take for granted — he might not be aware of them. It is an often repeated cry of programmers that, "the user never knows what he wants until he hasn't got it". Of course the user *knew* he wanted it, he just hadn't thought it needed spelling out to the programmer.

Errors

In any system some errors are picked up by deliberate checks, others are spotted by chance and some are written off as inevitable. If you are computerising an existing system, it is important to look at the sorts of checks that are being made and the errors that are being found as well as the ones that are getting through. You make different sorts of mistakes when you process things in different ways. In a manual system, mistakes are often made in the following ways:

- miscasting columns of figures
- posting items to the wrong account
- missing items or putting them through twice
- mis-keying or transposing characters.

We are accustomed to these sorts of errors and deliberately check for them. On the other hand, people are very good at picking up nonsense, such as a customer who appears to have ordered 1000 Rolls-Royces, or a string of numbers where a name should be. Unless you consciously realised that your computer couldn't spot these errors, you wouldn't think of checking for them yourself.

If you have a powerful mainframe you can write sophisticated error checking routines. You can even get the computer to build up profiles of the sort of entries you are accustomed to receiving

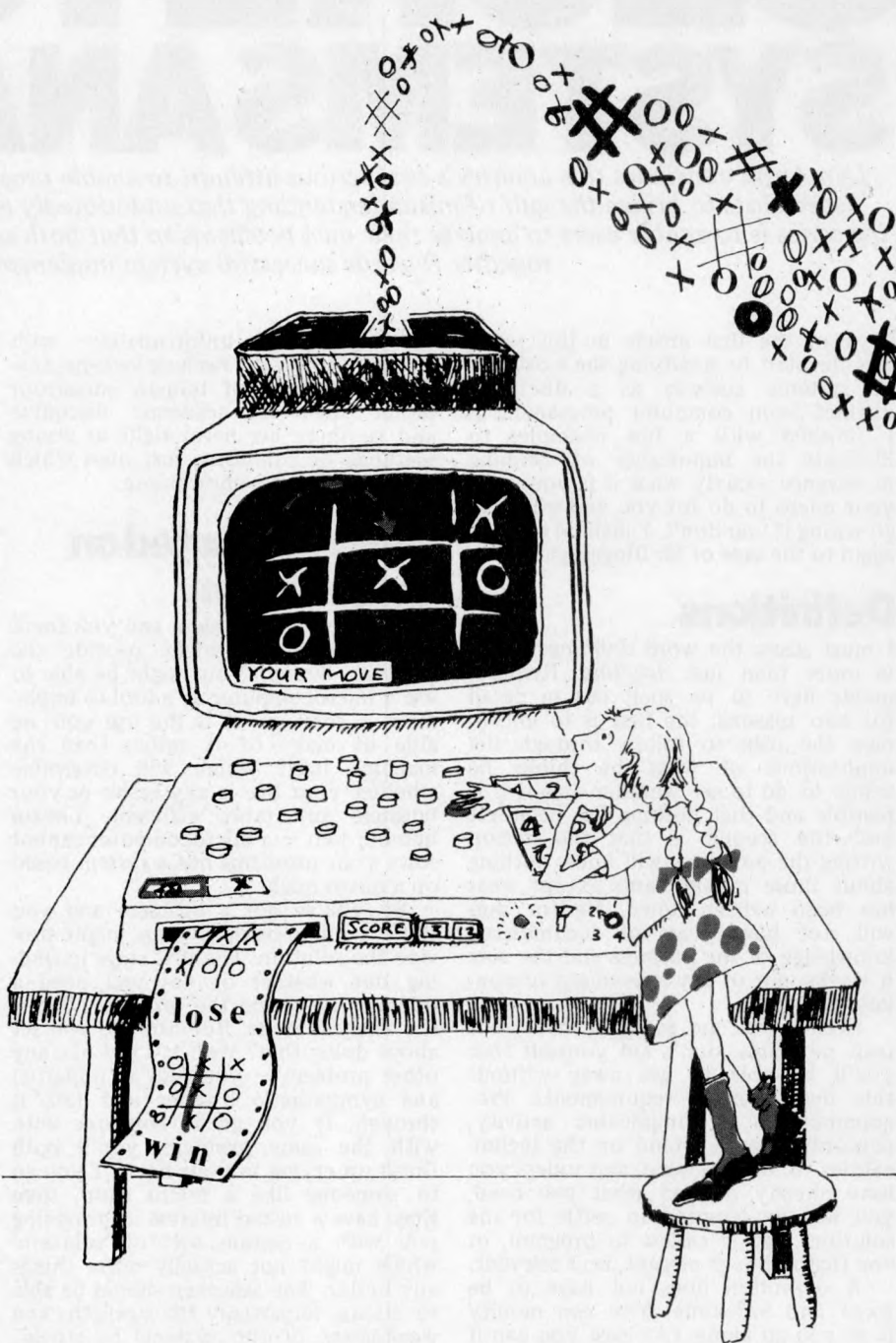

and query anything that doesn't seem to fit into the pattern. After all, you or your assistants have been storing that sort of information in your heads for years about the information you have been processing. You know when something 'just looks wrong'. Don't forget that the micro doesn't. In a later issue I will look at some of the checking that a good micro program should be able to do for you. At this stage, though, just note down the things that need to be checked. You'll be surprised how much data vetting you're doing. For my fourth lesson, I shall adapt Murphy's Law — if it can go wrong it will, so build a check for it.

Input, Processing, Storage, Output

These are the four main headings under which requirements would normally be listed and of these I always tackle the output first. After all, there is no point in creating a micro system unless you are going to be able to get something out of it. (Incidentally, this is where the serious user differs from the hobbyist. What the latter gets out of his computer is therapy.) In Mr Bloggs' case, one of the main outputs would have been a list of all the parts that had been sold and needed to be re-ordered.



- computer moves
 - instructions to the operator
- STORAGE:**
- moves made so far
 - whether computer is noughts or crosses
 - rules of the game
 - instruction messages

- PROCESSING:**
- calling for and accepting moves
 - finding out whether user wants to be noughts or crosses
 - deciding whether a move is valid and making or rejecting it
 - deciding where the computer should move
 - looking for three in a row
- INPUT:**
- choice of noughts or crosses
 - position of next move

- OPTIONAL EXTRAS:**
- visually pleasing display
 - amusing messages
 - random element so that the computer sometimes lets you win
 - there should be a working version of the program as soon as possible because daughter is clamouring to use it
 - it should fit into 8k because I can't afford any more memory yet.

These last two aren't part of the functional specification but they are important and must be included somewhere. The others have not been put in any order, just jotted down as I thought of them. Nor have any of the details been spelt out, eg how are the squares to be numbered? How are the moves to be selected? And it is certainly not for the analyst to suggest how the data should be stored or the programming be done. Only with file design (of which more later) is the analyst concerned with the 'how' of what goes on inside the computer.

What we have here is a sound base on which to build a full functional specification, along with a clear statement of two attributes of the system (ie the constraints on time and available memory). I leave it to you to decide, as an exercise, whether what I have put down so far hangs together and what further details would need to be filled in.

Human considerations

It's all very well doing all this thinking about the machine but what about the people who are going to use it? They may also have requirements and they will certainly have things to say about the functional requirements as well. Who is actually going to be pressing the keys, looking at the screen, reading the printout? It may well turn out that one of your requirements is that input should be done by a mechanic with greasy fingers or protective gloves on, or that the screen should be legible by someone at a distance, or to you without your reading glasses on (you can't look at a screen through the bottom half of your bifocals).

Some of these limitations are obvious or even predominant. Micros can be of great value to the handicapped. The touch-sensitive keyboard and the ability to correct mistakes on the screen can make typing much easier for those with limited hand movement. If such a person has a separate keyboard, this can be even better as it can be positioned

where it is most accessible. Such a requirement must be specified or it may be overlooked.

If a machine is going to be used by children it must be robust. A good set of graphics is immensely important, especially for juniors. They are captivated by cartoons and will cheerfully spend hours learning to use the machine as well as learning what the program was intended to teach. (And if there are sounds too, so much the better.) Also, any micro for infants or juniors must have lower case characters (many don't) because children learn to read in lower case and many don't take readily to capitals.

If you have specialised requirements like these, you probably don't need to be reminded to specify them. It is the person in a normal situation who is more likely to be scuppered because of some apparently trivial thing like one of his best employees who just can't type, or one who gets headaches looking at a flickering TV screen when you could have bought a high-quality monitor.

Another question you have to ask yourself is, 'how ready are you and your staff to change the details of your working life?'. Some people don't care how they go about doing a job just so long as they get it done as quickly and efficiently as they can. This is particularly true of the boss, whose only real concern is to keep the business viable. Others, particularly those who have been doing the same job in the same way for years, will be both mentally and emotionally slow to adapt. Their concern has always been with getting the details right and much of their self-image and way of life has been built around doing things a certain way; they would prefer not to change. You may decide, nevertheless, to start on a steady campaign to talk them round and you should certainly bring them in on the analysis stage. If you bear their detailed requirements in mind, you are more likely to come up with a system that they are able and willing to operate successfully.

Lesson number five: one of your requirements is that the user should be able and willing to use the machine.

Summary

You probably think I've been going on a bit about the preliminary stages and you're right. But I've only done so because the majority of computer systems that come to grief do so because this preliminary work has been neglected. This lesson was learnt the hard way by mainframe users a decade or so ago and now many micro users seem to be making the same mistakes all over again. So stand back from the problem and take a long cool look at it; talk it through with the people who will be involved and listen to what they say; split the functional requirements into Input, Processing, Storage and Output; think of all the things that can go wrong; list all the practical constraints (like cost); distinguish between essential and desirable features; and keep an open mind - don't try to impose a solution.

Now that you are clear in your own mind you are ready to start talking to salesmen and programmers. Next month - how to put your requirements in a form that the programmer can use.

Outputs may simply be the answer to an occasional query, the solution of an equation, letters to your customers or visual displays. In order to produce this output you have to put data in, store it and process it; this gives us the other three. When you design a system these are sketched out first in rather broad terms; later sufficient detail is filled in for the programmer to work from without having to know any more. Let me give a simple example:

My daughter wants to play noughts and crosses against the computer.

OUTPUT:

- visual representation of the square and the moves made

NEWCOMERS-START HERE

This is PCW's unique quick-reference guide for the microcomputing novice. While it's in no way totally comprehensive, it should help you pick your way through the most important pieces of (necessary) jargon which you'll find in PCW. We trust you'll find it useful. Happy microcomputing.

Welcome to the confusing world of the microcomputer. First of all, don't be fooled; there's nothing complicated about this business, it's just that we're surrounded by an immense amount of necessary jargon. Imagine if we had to continually say "numbering system with a radix of sixteen in which the letters A to F represent the values 10 to 15" when instead we can simply say "hex". No doubt soon many of the words and phrases we are about to explain will eventually fall into common English usage. Until that time, PCW will be publishing this guide — every month.

We'll start by considering a microcomputer's functions and then examine the physical components necessary to implement these functions.

The microcomputer is capable of receiving information, processing it, storing the results or sending them somewhere else. All this information is called data and it comprises numbers, letters and special symbols which can be read by humans. Although the data are (yes, it's plural) accepted and output by the computer in 'human' form, inside it's a different story — they must be held in the form of an electronic code. This code is called binary — a system of numbering which uses only 0s and 1s. Thus in most micros each character, number or symbol is represented by eight binary digits or bits as they are called, ranging from 00000000 to 11111111.

To simplify communication between computers, several standard coding systems exist, the most common being ASCII (American Standard Code for Information Interchange). As an example of this standard, the number five is represented as 00110101 — complicated for humans, but easy for the computer! This collection of eight bits is called a byte and computer freaks who spend a lot of time messing around with bits and bytes use a half-way human representation called hex. The hex equivalent of a byte is obtained by giving each half a single character code (0-9, A-F): 0=0000, 1=0001, 2=0010, 3=0011, 4=0100, 5=0101, E=1110 and F=1111. Our example of 5 is therefore 35 in hex. This makes it easier for humans to handle complicated collections of 0s and 1s. The machine detects these 0s and 1s by recognising different voltage levels.

The computer processes data by reshuffling, per-

forming arithmetic on, or by comparing them with other data. It's the latter function that gives a computer its apparent 'intelligence' — the ability to make decisions and to act upon them. It has to be given a set of rules in order to do this and, once again, these rules are stored in memory as bytes. The rules are called programs and while they can be input in binary or hex (machine code programming), the usual method is to have a special program which translates English or near-English into machine code. This speeds programming considerably; the nearer the programming language is to English, the faster the programming time. On the other hand, program execution speed tends to be slower.

The most common microcomputer language is Basic. Program instructions are typed in at the keyboard, to be coded and stored in the computer's memory. To run such a program the computer uses an interpreter which picks up each English-type instruction, translates it into machine code and then feeds it into the processor for execution. It has to do this each time the same instruction has to be executed.

Two strange words you will hear in connection with Basic are PEEK and POKE. They give the programmer access to the memory of the machine. It's possible to read (PEEK) the contents of a byte in the computer and to modify a byte (POKE).

Moving on to hardware, this means the physical components of a computer system as opposed to software — the programs needed to make the system work.

At the heart of a microcomputer system is the central processing unit (CPU), a single microprocessor chip with supporting devices such as buffers, which 'amplify' the CPU's signals for use by other components in the system. The packaged chips are either soldered directly to a printed circuit board (PCB) or are mounted in sockets.

In some microcomputers, the entire system is mounted on a single, large, PCB; in others a bus system is used, comprising a long PCB holding a number of interconnected sockets. Plugged into these are several smaller PCBs, each with a specific function — for instance, one card would hold the CPU and its support chips. The most widely-used bus system is called the S100.

The CPU needs memory in which to keep programs

and data. Microcomputers generally have two types of memory, RAM (Random Access Memory) and ROM (Read Only Memory). The CPU can read information stored in RAM — and also put information into RAM. Two types of RAM exist — static and dynamic; all you really need know is that dynamic RAM uses less power and is less expensive than static, but it requires additional, complex, circuitry to make it work. Both types of RAM lose their contents when power is switched off, whereas ROM retains its contents permanently. Not surprisingly, manufacturers often store interpreters and the like in ROM. The CPU can only read the ROM's contents and cannot alter them in any way. You can buy special ROMs called PROMs (Programmable ROMs) and EPROMs (Erasable PROMs) which can be programmed using a special device; EPROMs can be erased using ultra-violet light.

Because RAM loses its contents when power is switched off, cassettes and floppy disks are used to save programs and data for later use. Audio-type tape recorders are often used by converting data to a series of audio tones and recording them; later the computer can listen to these same tones and re-convert them into data. Various methods are used for this, so a cassette recorded by one make of computer won't necessarily work on another make. It takes a long time to record and play back information and it's difficult to locate one specific item among a whole mass of information on a cassette; therefore, to overcome these problems, floppy disks are used on more sophisticated systems.

A floppy disk is made of thin plastic, coated with a magnetic recording surface rather like that used on tape. The disk, in its protective envelope, is placed in a disk drive which rotates it and moves a read/write head across the disk's surface. The disk is divided into concentric rings called tracks, each of which is in turn subdivided into sectors. Using a program called a disk operating system, the computer keeps track of exactly where information is on the disk and it can get to any item of data by moving the head to the appropriate track and then waiting for the right sector to come round. Two methods are used to tell the computer where on a track each sector starts: soft sectoring

where special signals are recorded on the surface and hard sectoring where holes are punched through the disk around the central hole, one per sector.

Half-way between cassettes and disks is the stringy floppy — a miniature continuous loop tape cartridge, faster than a cassette but cheaper than a disk system. Hard disk systems are also available for microcomputers; they store more information than floppy disks, are more reliable and information can be transferred to and from them much more quickly.

You, the user, must be able to communicate with the computer and the generally accepted minimum for this is the visual display unit (VDU), which looks like a TV screen with a typewriter-style keyboard; sometimes these are built into the system, sometimes they're separate. If you want a written record (hard copy) of the computer's output, you'll need a printer.

The computer can send out and receive information in two forms — parallel and serial. Parallel input/output (I/O) requires a series of wires to connect the computer to another device, such as a printer, and it sends out data a byte at a time, with a separate wire carrying each bit. Serial I/O involves sending data one bit at a time along a single piece of wire, with extra bits added to tell the receiving device when a byte is about to start and when it has finished. The speed that data is transmitted is referred to as the baud rate and, very roughly, the baud rate divided by 10 equals the number of bytes being sent per second.

To ensure that both receiver and transmitter link up without any electrical horrors, standards exist for serial interfaces; the most common is RS232 (or V24) while, for parallel interfaces to printers, the Centronics standard is popular.

Finally, a modem connects a computer, via a serial interface, to the telephone system allowing two computers with modems to exchange information. A modem must be wired into the telephone system and you need British Telecom's permission; instead you could use an acoustic coupler, which has two obscene-looking rubber cups into which the handset fits, and which has no electrical connection with the phone system — British Telecom isn't so uppity about the use of these.

Dick Olney of Heuristics Consultants presents a revised 'In Store'; from now on this will appear bi-monthly, alternating with our 'Packages' software guide. Updates and revisions for In Store should be sent to Dick, c/o PCW, 14 Rathbone Place, London W1P 1DE.

Machine (Price from)	Main Distributor/s (No. of Dealers)	Hardware	Software	Miscellaneous (Documentation)
ABC 80 (£738)	Datormark Ltd: 09322 44896	16-40k RAM; Z80A; C; 12", 16x40 b&w VDU; 4680 bus; IEEE 488; RS232 port.	DOS; Basic (16k ROM); <i>Fortran; Pascal;</i> A; <i>Multi user Basic.</i>	Colour video graphics with UHF output. Viewdata compa- tible. Loudspeaker. Numeric keypad. Options: dual 5 1/4" F/D (160k) £895; dual 8" F/D (2 Mb).
ACT System 800 (£3950)	ACT: 021-455 9898 (50)	48k RAM; 6502; dual 5 1/4" F/D (800k); 12"; 30x64 VDU; 1 S/P; 1 P/P; Multi-screen int.	MDOS; Basic; A; <i>CBasic; PL/M; Forth;</i> <i>Fifth; Casil; Pilot;</i> <i>Fortran.</i>	IBM compatible K/B. High resolution graphics. Available with dual 8" F/D (2.4 Mb) £4950 — 4.8 Mb maximum. (E).
Alpha Micro (£5650)	Alpha Micro (UK) Ltd: 01-250 1616 (TBA)	64k — 1 Mb RAM; 16 bit; dual 8" F/D (2.4 Mb); 6 S/P.	Multi-user OS; Basic; M/A; Pascal; U.	Modular. Expands to 1200 Mb. 24 terminals or multiprocessor system. (E)
Altos ACS 8000 (£3398)	Logitek: 02572 66803 (33)	64k RAM; Z80; 1k EPROM; dual 8" F/D (1Mb); 2xRS232 ports; 1 P/P.	CP/M; <i>Basic; CBasic;</i> <i>Cobol; Pascal; Fortran.</i>	Expandable to 4-user system with 58Mb H/D. Maintenance contracts avail; (S&H).
Apple II (£695)	Microsense: 0442 41191 (190)	16-48k RAM; 6502; 8 I/O slots.	O/S; <i>Basic; Pascal;</i> <i>Fortran.</i>	280x192 high resolution graphics; Integer Basic in 6k ROM; Option: single 5 1/4" F/D (116k) £349.
Athena 8285 (£5694)	Butel-Comco Ltd: 0703 39890 (TBA)	64k RAM; 8085A; dual 5 1/4" F/D (644k); 12"; 25x80 VDU; 150 cps printer; RS232 port.	AMOS; T/E; Basic; <i>Cobol; Fortran;</i> <i>Pascal; APL; M/A.</i>	Extended ASCII K/B with numeric pad; graphics. Options: dual 8" F/D (2Mb); up to 1200 Mb H/D
Atom (£120)	Acorn: 0223 312772 (N/A)	2-11k RAM; 6502; Full K/B; C int; TV int; 20 I/O lines; 1 P/P.	Basic in 8k ROM; A; Cass O/S.	High resolution graphics on bigger model; colour monitor O/P. Loudspeaker. Note also systems based on Acorn SBC. (B).
Attache System II (£8000)	Friargrove Systems Ltd: 01-572 3784	64k RAM; 8080; dual 8" F/D (1.2Mb); 12"; 24x80 VDU; 180 cps printer.	Basic; <i>Fortran; Cobol.</i>	Upgradable to multiuser system with 20Mb H/D. (S).
Billings BC-12 FD: (£3995)	Mitech: 04862 23131 (TBA)	64k RAM; Z80A; dual 5 1/4" F/D (640k); 12"; 24x80 b&w (or b&g) VDU.	DOS; Basic; <i>Fortran;</i> <i>Cobol; A.</i>	With dual 8" F/D (2Mb) £5995. Additional dual 8" F/D £3000. (S).
C/09 (£3975)	SWTP Ltd: 01-491 7507 (16)	56k RAM; 6809; dual 8" F/D (2Mb); 8"; 16x80 VDU; 1 S/P.	TSC FLEX; <i>Basic;</i> <i>Pascal; A; Dis A;</i> T/E; U.	VDU is intelligent. Option: 15Mb H/D £3575; with dual 5 1/4" F/D (350k) instead of 8", £3000.
Challenger 1P & C4P (£220 & £395)	CTS: 0706 79332. Millbank Computing: 01-549 7262. Mutek: 0225 743289. U- Microcomputers: 0925 54117	4-32k RAM; 6502; C int; RS232 port.	O/S; Basic (8k ROM) <i>Ex Basic; A.</i>	D/A conv; colour capability. Options: dual 5 1/4" F/D (160k) £550; for C4P dual 8" F/D (1.15Mb) and 20Mb H/D. Runs OSI business software on 8" F/D (S).
Challenger 2 (£1500)	As above	48k RAM; 6502; dual 8" F/D (0.5Mb); RS232 port.	OS65U; Ex Basic; A.	Designed as low cost business system (S).
Challenger C3 (£2334)	As above	32-56k RAM; 6502; 6800; Z80; dual 8" F/D (1.15Mb); 2-16 S/P.	OS65U; Basic; <i>CP/M;</i> <i>Fortran; Cobol.</i>	Expandable to multi-user (8) system. Options: C3B & C3C H/D units, 74Mb for about £8500. (S&H).
Clenlo Conqueror System B (£1950)	Clenlo Computing Systems Ltd: 01- 670 4202	64k RAM; Z80; dual 8" F/D (1Mb); 3 S/P; 2 P/P.	CP/M; CBasic-2; Pearl 1; U.	With four 8" F/D £2850.
Clenlo Conqueror System D (£5150)	As above	64k RAM; single 8" F/D (500k); 10Mb H/D; 3 S/P; 2 P/P.	CP/M; CBasic-2; Pearl 11; U.	With 26Mb H/D and no F/D £5950.
Compucolor II (£995)	Dyad Developments: 08446 729	8-32k RAM; 8080; 13" 32x64 8-colour VDU; single 5 1/4" F/D (51k); RS232 port.	DOS (ROM); Ex-Basic (ROM); A.	16k version £1078, 32k £1198. High resolution graphics. 6- month subscription to user magazine inclusive (S).
Compucorp 625 (£6000)	Compucorp: 01-952 7860 (17)	60k RAM; dual 5 1/4" F/D (630k); 9"; 16x80 VDU; 40 col printer; RS232 port.	Basic; A; <i>Fortran;</i> <i>Pascal; U.</i>	Various systems available with 320k — 2.4Mb F/D and 9", 12" or 20" VDU.
Computermart 2000 DS (£1500)	Computermart: 0603 615089	32-256k RAM; 8085; dual 8" F/D (1-2Mb); S/P; P/P.	CP/M; <i>Cis Cobol; Basic;</i> <i>Fortran.</i>	Expandable to multi-user, multi-tasking, multi-processor 96Mb H/D system (around £15000).
Cromemco System 2, System 3, System Z2H. (£2100/ £3730/£5340)	Datron: 0742 585490. Comart: 0480 215005. MicroCentre: 031 556 7354	64k RAM; Z80; dual 5 1/4" F/D (346k) on System 2 & Z2H; dual 8" F/D (1.2Mb) on Sys 3; 10Mb H/D on Z2H; S/P; P/P.	CDOS; <i>Basic; Cobol;</i> <i>Fortran; RPG II;</i> <i>Lisp; A; W/P; Multi-</i> <i>user Basic.</i>	All systems expandable to multi-user (max 7) £6408 Sys 2, £8304 Sys 3. Options: dual 8" F/D (996k); 11-22Mb H/D. (E).
DAI (£998-48k)	Data Applications (UK): 0285 2588 (TBA)	12-48k RAM; 8080; C int; 24x 60 VDU int; RS232 port; over 20 industrial ints.	Basic (ROM); U.	Colour graphics up to 255x 335; 3 notes & noise generator; PAL O/P to TV; Paddle int; H maths option.
Diablo 3000 (£8950)	Business Computers Ltd: 01-207 3344 (TBA)	32k RAM; 8085; dual 8" F/D (1.2Mb); 12"; 24x80 b&w VDU; 45cps printer.	DOS; Basic; DACL; A; U.	Selection of business packages included (S).
Digital Micro- systems DSC-2 (£3525)	Modata: 0892 41555 (10)	64k RAM; Z80; dual 8" F/D (1.14Mb); 4xRS232 ports; EIA port.	CP/M; Basic-E; CBasic; <i>Cobol;</i> <i>Fortran; Pascal.</i>	14 or 28Mb H/D available or additional F/D units (H).
Digital Micro- systems DSC-4 (£6045)	As above	128k RAM; Z80A; single 8" F/D (500k); 11Mb H/D; 4x RS232 ports; 2 P/P.	CP/M; Basic-E; CBasic; <i>Cobol;</i> <i>Fortran; Pascal.</i>	Also DSC-3 with 64k RAM. Options: 128k RAM £1295; up to 4Mb F/D and 29Mb H/D. (H).

List of Abbreviations

A Assembler	F/D Floppy disk	M/A Macro assembler	S/P Serial port
B Basic	G/C Graphics card	N/A Not available	T/E Text editor
C Cassette	H Hardware	N/P Numeric pad	TBA To be announced
E Extensive	H/D Hard disk	O/S Operating system	U Utility
	I Introductory	P/P Parallel port	
	Int Interface	S Software	

Please note: Software items listed in *italics* are not included in the basic price of the equipment. All prices are *exclusive* of VAT.

Machine (Price from)	Main Distributor/s (No. of Dealers)	Hardware	Software	Miscellaneous (Documentation)
Durango F-85 (£7500)	Comp Ancillaries: 0784 36455 (12)	64k RAM; 8085; dual 5¼" F/D (1Mb); 9" 16x64 green VDU; 132 col 165 cps printer; N/P.	O/S; DBasic; CP/M; CBasic; Micro Cobol.	Up to 5 work stations; fully integrated system. Options: additional dual 5¼" F/D (1Mb); 12-24Mb H/D. (S).
Dynabyte DB8/1 (£1500)	Dynabyte UK/Europe Ltd: 0723 65559 (6)	32-64k RAM; Z80; S100 bus; 2xRS232 ports; 1 P/P.	CP/M; Basic; Cobol; Pascal.	Expands to multi-user system. Options: dual 8" F/D (1Mb) £2000; Also DB8/2 with dual 5¼" F/D (400k) £3000. (E).
Equinox 200 (£7500)	Equinox: 01-739 2387 (N/A)	64-256k RAM; Z80; 10Mb H/D; 1 S/P; 1 P/P.	CP/M; CBasic; Cobol; Fortran.	Multi-user MVT/FAMOS available in place of CP/M. (S&H).
Euroc (£7995)	Euroc: 01-729 4555 (TBA)	64k RAM; 8080A; dual 8" F/D (1Mb); 15" 25x80 b&w VDU; 132 col 140 cps printer.	CP/M; CBasic; A; U.	Financial software available. Supply of stationary included.
Executive Mini-computer (£378)	Binatone Int: 01-903 5211	16k RAM; Z80; 500 bps C; 32x64 TV int; extra C int; 1 P/P.	Basic (12k ROM); M/A; Fortran.	Graphics avail. F/D under development. Also 4k version called 'Oxford minicomputer'.
Exidy Sorcerer (£749)	Liveport Data Products: 0736 798157 (27)	16-48k RAM; Z80; RS232 port; 1 P/P; S100 connector; 30x64 VDU int.	O/S: Basic (ROM); T/E; A; CP/M; Algol; Fortran; Basic; 80.	High resolution graphics capability; user programmable character set. 32k version £799; 48k £849. Option: single 5¼" F/D (315k) £600.
HP 85 (£2240)	Hewlett Packard Ltd: 0734 784774 (16)	16-48k RAM; Z80; RS232; 1 P/P; S100 int; 30x64 VDU; Option: 2x5¼" F/D (630k), £1200.	O/S; ExBasic (ROM); Editor; A; CP/M; Algol; Fortran.	Hi-res graphics capability; 32k version, £799, 48k, £849; user programmable char set. (I).
IMS 5000 (£1935)	Equinox: 01-739 2387 (20)	32-64k RAM; Z80; dual 5¼" F/D (320k)	CP/M; CBasic; Cobol, Fortran.	3 drives option: (S&H).
IMS 8000 (£3515)	As above	64-256k RAM; Z80; dual 8" F/D (1Mb)	CP/M; CBasic; Cobol; Fortran; MicroCobol.	Multi-user MVT/FAMOS available in place of CP/M. (S&H).
ITT 2020 (£867)	ITT: 0268 3040 (15)	16-48k RAM; 6502	Monitor; A; ExBasic; Dis A.	360x192 high res graphics. Ex-Basic in 6k ROM; Options: single 5¼" F/D (116k), £425; 16k RAM, £110; RS232 port, £96; 32k system, £931; 48k system, £995. (B).
LX-500 (£3500)	Logabax Ltd: 01-965 0061 (13)	32k RAM; Z80; dual 5¼" F/D (180k); 12" 25x80 b&w VDU; 100cps printer.	DOS; Basic; A.	Other printers available. (S).
LSI M-One (£5995)	LSI Computers 04862 23411	8k RAM; 8080; dual 8" F/D (1.2Mb); 12" 24x80 b&w VDU.	FMOS; A.	Choice of standard business packages included in price. (S).
LSI M-One Model 5. (£9900)	As above	16k RAM; 8080; dual 8" F/D (2.4Mb); 2x12" 24x80 VDUs; 120 cps bidirectional printer.	FMOS; A.	One VDU is for inquiry only. (S).
Megamicro (£6080)	Bytronix: 0252 726814 (5)	56k RAM; Z80; dual 8" F/D (500k); 12" 20x80 green VDU; 180 cps printer; 2 S/P; 2 P/P.	CP/M; U; Basic; A; M/A.	(H&B).
Mikro 1000 (£3950)	Airamco: 0294 57755	64k RAM; Z80; dual 8" F/D (1Mb); 12" 24x80 VDU; S100; RS232; 1 P/P.	CP/M; Basic; Cobol; Fortran.	Also word processor with 44 special function keys & NEC Spinwriter printer £4450.
Microstar 45 Plus (£4800)	Data Efficiency Ltd: 0442 63561 (30)	64k RAM; 8085; dual 8" F/D (1.2Mb); 3 S/P; RS232 port.	Stardos; CP/M; Basic; Cobol; Fortran.	(E).
Microtan 65 (£69)	Tangerine: 0353 3633	1k RAM; 6502; TV int; Exp up to 277k RAM.	1k TANBUG monitor; 2k A. disassembler, cassette firmware; 10k Microsoft ExBasic.	Options: bulk I/O modules, hidef colour graphics, DOS, system racking, ASCII keyboard.
MS5001 (£8250)	BMG Ltd: 0793 37813 (N/A)	64k RAM; 8085; dual 8" F/D (1Mb); 12" 80x24 VDU; 160 cps printer; RS232.	CP/M; Basic; Cobol; Fortran; MP/M.	Price includes desk mounting and one computer. Hardware & software support. Leasing arrangements available.
MSI 6816 (£1200)	Strumech: 05433 4321 (5)	16-56k RAM; 6800; 9" 16x64 b&w VDU; C int; 1 S/P; 1 P/P.	Basic; A.	Graphics & PROM programmer available. (S&H).
MSI System 7 (£3500)	As above	56k RAM; 6800; dual 5¼" F/D (160k); 9" 16x64 VDU; 1 S/P; 1 P/P.	FDOS; Basic; A; U.	As above. Multi-user O/S avail. Options: 10Mb H/D.
MSI System 12 (£8000)	As above	56-184k RAM; 6800; 10Mb H/D; 9" 16x24 VDU; 1 S/P; 1 P/P.	SDOS; Basic; CBasic; U.	As above. Business packages avail. (H & S).
Nanocomputer NBZ80S (£420)	Midwich: 97 29310	4k RAM; 2k ROM; Z80; C int; 8 digit LED; Calc K/B; RS232 port; 2 P/P.	Machine language; Basic; A; T/E.	Designed for hardware education. Full training manuals included. Fully expandable. (E).
North Star Horizon (£2230)	Comart: 0480 215005. Comma: 0277 811131. Equinox: 01-739 2387 (20)	48-56k RAM; Z80A; dual 5¼" F/D (360k); 15" 24x80 VDU; 150cps printer; 2 S/P; 1 P/P.	DOS; Basic; CP/M; Cobol; Fortran; Pascal.	With 32k and single F/D £1495. Options: 18Mb H/D.
Panasonic JD 800U, JD 840U (£4275, £4950)	Panasonic Business Equipment: 01-262 3121	56k RAM; 8085A; 2-4k PROM; dual 8" F/D. JD800 U (500k), JD840U (2Mb); 12" 24x80 green VDU; 3xRS232 ports.	CP/M; Basic; Micro-Cobol.	Also available with 5¼" F/D; JD700U (140k) £3758; JD740U (570k) £4095.(S).
Pascal Microengine (£2295)	Pronto Electronic Systems Ltd: 01-554 6222	64k RAM; MCP 1600; 2x RS232 ports; 2 P/P.	Pascal.	CPU instruction set is P-code; no interpreter needed. Available with dual 8" F/D (2Mb) £3900.
Periflex 630/48 (£2500)	Sintrom: 0734 85464 (5)	48k RAM; Z80; dual 5¼" F/D (630k); 2xRS232 ports; 1 P/P.	CP/M; Basic; Fortran; Cobol; A.	One-day installation training on site included in price. Option: dual 5¼" F/D (630k) £859; dual 8¼" F/D (1Mb) £1025. (S&H).

List of Abbreviations

A Assembler	F/D Floppy disk	M/A Macro assembler	S/P Serial port
B Basic	G/C Graphics card	N/A Not available	T/E Text editor
C Cassette	H Hardware	N/P Numeric pad	TBA To be announced
E Extensive	H/D Hard disk	O/S Operating system	U Utility
	I Introductory	P/P Parallel port	
	Int Interface	S Software	

Please note: Software items listed in *italic* are not included in the basic price of the equipment. All prices are *exclusive* of VAT.

Machine (Price from)	Main Distributor/s (No. of Dealers)	Hardware	Software	Miscellaneous (Documentation)
Periflex 1024/64 (£3300)	As above	64k RAM; Z80; dual 8" F/D (1Mb); 2xRS232 ports; 1 P/P.	As above.	As above.
PET 8k, 16k, & 32k (£450, £550, £695)	Commodore: 01-388 5702 (150)	8-32k RAM; 6502; C; 9"; 25x40 VDU; IEEE-488 port; Options: dual 5 1/4" F/D (353k) £695; same but (950k) £895.	O/S; Basic (in 8k ROM); <i>Forth</i> ; <i>Pilot</i> ; <i>Pascal</i> .	Disk controller for 8k version £30. New 8032 with 80-col screen (32k) £895.(1).
Powerhouse 2 (£1125)	Powerhouse Micros: 0422 48422 (TBA)	32-64k RAM; Z80A; 5"; 29x96 VDU; RS232 port; external bus.	4k Monitor; <i>FDOS</i> ; <i>Basic</i> ; <i>ExBasic</i> (14k EPROM)	VDU has flexible screen logic. Options: <i>FDOS</i> & <i>Basic</i> £210; graphics card £200.
Powerhouse 3 (£2600)	As above	32-64k RAM; Z80A; dual 5 1/4" F/D (350k); 5"; 29x96 VDU; RS232 port; external bus.	As above.	VDU as above. With 1.2Mb F/D £3500. <i>ExBasic</i> & <i>FDOS</i> in 14k EPROMs £300.
Rair Black Box (£2250)	Rair: 01-836 4663 (N/A)	32-64k RAM; 8085; dual 5 1/4" F/D (260k); 2x RS232 ports.	CP/M; <i>Basic</i> ; <i>Cobol</i> ; <i>Fortran</i> ; M/A.	16k RAM expansion £250 10Mb H/D £2500.
Research Machines 380Z (£1123)	Research Machines 0865 49791 (N/A)	16-56k RAM; Z80A; 2xC; RS232 port.	<i>ExBasic</i> ; A; T/E; U; <i>CP/M</i> ; <i>Fortran</i> ; <i>Cobol</i> ; <i>Algol</i> ; <i>Cesil</i> .	Limited graphics. Many possible systems. With 48k RAM & dual 8" FD (1Mb) £3394.
S/09 (£5350)	SWTP Ltd: 01-491 7507 (16)	128k RAM; 6809; dual 8" F/D (2Mb); 8"; 21x92 VDU; 2xS/P; 1 P/P.	TSC <i>FLEX</i> ; <i>Basic</i> ; <i>Pascal</i> ; A; <i>Dis A</i> ; T/E; U.	VDU is intelligent. Expands to 60Mb H/D multi-user system. Option: 15Mb H/D £3575. Maintenance contracts.
SBS 8000 (£1449)	Manhattan Skyline Ltd: 08012 3442 (TBA)	64k RAM; Z80A; 12"; 16x64 VDU; 1 P/P; RS232 port (extra £133).	<i>ExBasic</i> (24k ROM); <i>DOS</i> .	Options: disk control card £237; dual 5 1/4" F/D (368k) £795; dual 8" F/D (2Mb) £1400.
SEED System 1 (£2000)	Strumech: 05433 4321 (4)	32-64k RAM; 6800; dual 5 1/4" F/D (160k); 9"; 16x24 VDU; RS232 port.	<i>DOS</i> ; <i>Basic</i> ; U; <i>Fortran</i> ; A; <i>Pilot</i> ; <i>Strubal</i> ; T/E.	Several F/D options. With 64k RAM & dual 8" F/D (1.2Mb) about £3000. (E).
Sharp MZ-80k (£480)	Sharp electronics (UK) Ltd: 061-205 2333	6-34k RAM; Z80; C; 10"; 24x40 VDU; Option: dual 5 1/4" F/D (280k) £780.	<i>Basic</i> (14k ROM); A.	Graphics; loudspeaker. 18k RAM version £529; 22k £549; 34k £599. (B).
Sinclair ZX80 (£100)	Science of Cambridge: 0223 311488 (N/A)	1-16k RAM; Z80A; C int; TV int; full K/B; 44-pin expansion port.	<i>Basic</i> (4k ROM).	Kit £80. Mains adaptor £9. (S).
Smoke Signal Chieftan (£1807)	Systems Implementa- tion Ltd: 06924 5666 (TBA)	32-64k RAM; 6800; dual 5 1/4" F/D (160k); 12"; 24x80 VDU; RS232 port.	<i>DOS</i> ; 68/ <i>FLEX</i> ; <i>Basic</i> ; <i>Fortran</i> ; <i>Cobol</i> ; U.	With dual 8" F/D (2Mb) £2712. Designed as development system for industrial control.
Solitaire WP & BS200 (£6750 & £8200)	Solitaire KPG: 01- 995 3573 (TBA)	64k RAM; 8085; 14" VDU (with own CPU); 45 cps printer; CPU port; dual 5 1/4" F/D (700k) 8" F/D (1.02Mb) with BS200.	<i>DOS</i> ; <i>Basic</i> ; dual	All solitaire systems are compatible; graphics on 11x13 dot matrix.(S).
Sord M100 (£795)	Midas Computer Services Ltd: 0903 814523	48k RAM; Z80; 8k ROM; 12"; 24x64 green VDU; RS232 port; S100 bus; N/P.	O/S; <i>Basic</i> ; A; <i>Fortran</i> ; <i>Pascal</i> .	M100 ACE with single 5 1/4" F/D (143k) £1850. Up to 3 drives possible. Colour graphics avail. (I).
Sord M223 Mk II-VI (£3950)	As above	64k RAM; Z80; 8k ROM; single 5 1/4" F/D (350k); 12"; 24x64 green VDU; RS232 ports; S100 bus; N/P.	O/S; <i>ExBasic</i> ; <i>CBasic</i> ; <i>Multi-User Basic</i> ; <i>Fortran</i> ; <i>Pascal</i> ; <i>Cobol</i> .	Expandable to 4Mb F/D, 32Mb, H/D, 5 screens, 2 printers. (I).
SPC/1 (£3770)	Digital Data: 01- 573 8854	64-1024k RAM; 8085A-2; dual 5 1/4" F/D (90k); 12"; 24x80 VDU; 2xRS232 ports; Option: single 8" F/D (1Mb) £1090; 20Mb H/D £7000.	Mikados; Comal; <i>Pascal</i> ; A.	With 32k RAM and single F/D (Comal only) £1995. Expandable to multi-user system (8 users). (S).
Superbrain (£1995)	Icarus: 0632 29593 (TBA)	64k RAM; 2xZ80; dual 5 1/4" F/D (320k); 12"; 25x80 VDU; S100 bus; RS232 port.	CP/M; A; <i>Basic</i> ; <i>Cobol</i> ; <i>Fortran</i> ; <i>APL</i> ; <i>Pascal</i> .	Limited graphics. Mainframe int avail. Options: dual 5 1/4" F/D (320k); dual 8" F/D (2.4 Mb); 8-120Mb H/D. (S&H).
System 80 (£1355-48k)	Nascom: 02405 75155 (32)	16-48k RAM; Z80A; dual 5 1/4" F/D (560k); TV int; RS232 port.	CP/M; <i>Basic</i> (8k ROM).	EPROM firmware avail. Colour graphics card £165. Many configurations possible. (S&H).
Tandberg EC10 (£4000)	Tandberg: 0532 35111 (N/A)	64k RAM; 8080A; single 8" F/D (250k); 12"; 25x80 VDU; 7x RS232 ports; printer int.	CP/M; <i>ExBasic</i> (24k <i>Multi-user Basic</i> ; <i>Pascal</i> ; <i>Cobol</i> ; A; U;	Up to 7 terminals. Includes V28 comms port. (S & H).
Tandy TRS80 Level I (£335)	Tandy: 021 556 6101 (200)	4-16k RAM; Z80; C; 12"; 16x64 VDU.	<i>Basic</i> (4k ROM); A.	Expandable to Level II. Many extras available. (I).
Tandy TRS80 Level II (£408)	As above	4-48k RAM; Z80; C; 12"; 16x64 VDU; RS232 port; 1 P/P.	<i>Basic</i> (4k ROM); M/A; <i>Fortran</i> .	16k machine includes N/P. 4-16k upgrade £87, 48k system £620; Option: single 5 1/4" F/D (78k) £295, (subsequent £277, up to 4. (I).
Tandy TRS80 Model 2 (£1999)	As above	32-64k RAM; Z80A; single 8" F/D (500k); 12"; 24x80 VDU; 2 S/P; 1 P/P; N/P.	<i>DOS</i> ; <i>Basic</i> .	64k version £2249. Expandable to four F/D drives, single drive expansion £799; three drive £1589.
TECS (£1200)	Technologies Compu- ting Ltd: 061-793 5293 (TBA)	4-56k RAM; 8k PROM; 6800/6809; 2xC; TV int; 2xRS232 ports; internal viewdata modem & printer port.	<i>FLEX</i> ; <i>Basic</i> ; <i>Pascal</i> ; <i>TDOS</i> ; A; T/E; <i>Pilot</i> ; <i>Fortran</i> ; <i>Cobol</i> .	Fully viewdata compatible. Options - dual 5 1/4" F/D (320k) £850; dual 8" F/D £120 £1200. (S&H).
Terodec DPS 64/1 (£3099)	Terodec (Micosystems) Ltd: 0252 874790	64k RAM; Z80; dual 8" F/D (1Mb); 12"; 24x80 VDU; 2 S/P; 3 P/P. Options: dual 8" F/D (1Mb) £1150; with 2Mb £1455.	CP/M; <i>Basic</i> ; <i>Cobol</i> ; <i>CBasic</i> ; <i>Fortran</i> ; <i>Algol</i> ; <i>Pascal</i> .	TMZ 80 enhanced model in integral workstation £5595 (with 4Mb F/D). DPS 64/2 with 2Mb F/D £3404. (S&H).
TI 99/4 (£750)	TI: 0234 67466 (TBA)	16k RAM; 26k ROM; 9900; 24x32 VDU; 2x C int; TV int; RS232 port.	OS; <i>Basic</i> .	Can run 16-colour TV screen. (S).
Triton L8.2 (£611)	Transam: 01-405 5240 (N/A)	32k RAM; 8080; C int; 16x64 VDU int; 1 S/P; 1 P/P.	4k monitor; <i>Pascal</i> (20k ROM); <i>CP/M</i> ; <i>Pascal</i> .	Graphics; 5 1/4" or 8" F/D are available; L7.2 with 2k monitor and <i>Basic</i> (no <i>Pascal</i>) £409. (S&H).

List of Abbreviations

A Assembler
B Basic
C Cassette
E Extensive

F/D Floppy disk
G/C Graphics card
H Hardware
H/D Hard disk
I Introductory
Int Interface

M/A Macro assembler
N/A Not available
N/P Numeric pad
O/S Operating system
P/P Parallel port
S Software

S/P Serial port
T/E Text editor
TBA To be announced
U Utility

Please note: Software items listed in *italic* are not included in the basic price of the equipment. All prices are *exclusive* of VAT.

Machine (Price from)	Main Distributor/s (No. of Dealers)	Hardware	Software/Firmware	Miscellaneous (Documentation)
Zilog MCZ 1/05 (portable); MCZ 1/20A (£3250)	Micropower: 0256 54121. Memec: 084421 5471 (N/A)	64k RAM; Z80; dual 8" F/D (600k); RS232 port; MCZ 1/20A only 1 P/P; Option: 10Mb H/D £7100	RIO; O/S; <i>Cobol; Basic; Fortran; Pascal; M/A; U.</i>	Available desk top or rack mounted. Debug in 3k PROM. 1/20A runs multi user Cobol, up to 5 terminals with 40Mb H/D. (S&H).
Z-Plus (£3950)	Rostronics Ltd: 01-874 1171 (16).	64k RAM; Z80; dual 8" F/D (1Mb); 4 S/P; 2 P/P.	CP/M; A; U; <i>Basic; Cobol; Fortran; Pascal; APL; PL/1; Algol.</i>	Available with 2Mb F/D. Option: 20Mb H/D £4000. (S&H).
Vector MZ (£2595)	Almarc: 0602 62503 (3)	56k RAM; Z80A; dual 5 1/4" F/D (630k); 3 S/P; 2 P/P.	CP/M; <i>Basic; Algol; Cobol; Pascal; Fortran; Coral; CBasic; A.</i>	High resolution graphics. Also system B with video board & terminal £3195. (E).
Vector System 2800 (£4195)	As above	56k RAM; Z80A; dual 8" F/D (2.4Mb); 3 S/P; 2 P/P.	As above.	High-res graphics. Also System 3030 with 32Mb H/D and single 5 1/4" F/D £7500.
Video Genie EG3003 (£330)	Lowe Electronics: 0629 2817	16k RAM; Z80; 500bps C; 32x64 TV int; extra C int; 1 P/P.	Basic (12k ROM); M/A; Fortran.	Graphics available.
Zentec (£4838)	Zygal Dynamics: 02405 75681 (TBA)	32-64k RAM; 2x8080; dual 5 1/4" F/D (256k); 15", 25x80 VDU; RS232 port.	O/S; A; U; <i>Basic; Cis Cobol.</i>	User programmable character set. Option: dual 8" F/D (1Mb). (S).
Zenith WH-11A (£4359)	Heath Ltd: 0452 29451 & 01-636 7349 (N/A)	LSI 11; 16-32k RAM; 25x80 VDU; S/P; P/P.	O/S; <i>Basic; Fortran; A; U.</i>	PDP 11-compatible. Option: 2x8" F/D (512k). (S&H).
Zenith Z89 (£1490)	As above	16-48k RAM; Z80; single 5 1/4" F/D (102k); 12" 25x80 b&g VDU; RS232.	<i>Basic; A; HDOS; CP/M; MBasic; CBasic; Fortran.</i>	3 drives option. (I).

SINGLE BOARDS

Machine (Price from)	Main Distributor/s (No. of Dealers)	Hardware	Software/Firmware	Miscellaneous (Documentation)
Acorn System 1 (£65)	Acorn: 0223 312772	11/8k RAM; 6502; EPROM socket; Hex K/B; C int; 8-digit LED display; up to 16 ports. Options: Eurocard 64-way connector; VDU card; full K/B card.	1/2k monitor; <i>Basic.</i>	Kit. Programmable address linking. On-board 5 V regulator. Available assembled £79. Can be expanded to disk-based system. (S&H).
Aim 65C (£285)	Pelco: 0273 722155 (7)	1-4k RAM; 6502; 4-20k ROM; Full K/B; 2xC; 20 char LED; 20 char thermal printer; RS232 port.	A. Dis A; T/E; 8k monitor; <i>Basic (8k ROM); PL65.</i>	Power supplies and two types of case avail. Can be expanded to disk system. (E).
Cromemco SC (£260)	Comart: 0480 215005 (17)	1k RAM; Z80A; 8k EPROM sockets; RS232 port; 3 P/P. Option: S100 bus.	Monitor; <i>Basic.</i>	5 program interval timers. Can put own Basic programs in EPROM. (E).
Elf II (£60)	Newtronics: 01-348 3325	1/4-64k RAM; RCA 1802; Hex K/B; 2-digit LED; TV int; C int; RS232. Options: Full K/B; VDU card.	1k monitor; A; Dis A; T/E; Elf-bug; <i>Tiny Basic; Basic.</i>	TTY, N-line decoders. Low resolution graphics (high res avail). Kits or built. (H).
Explorer (£82)	As above	4-64k RAM; 8085; Hex K/B; RS232 port; S100 bus; C int; 1k video RAM.	2k monitor; <i>Basic; CP/M.</i>	Supplied in kit or built. Full range of peripherals including F/D. (H).
Hewart 6800S (£299)	Hewart: 0625 22030 (N/A)	16k RAM; 6800; full K/B; VDU int; 2xC int; 1 S/P; 2 P/P; Option: 16k RAM £90.	1k monitor; A; T/E.	Can be upgraded with 6809. (H).
Hewart 6800 Mk III (£152)	As above	1k RAM; 6800; VDU board.	1k monitor.	Options: single 5 1/4" F/D (75k) £350; PROM programmer £32. (H).
Microtan 65 (£69)	Tangerine: 0353 3633	1k RAM; 6502; 16x32 TV int; Options: 64x64 Pixel graphics £6.50; 16k RAM £56.	1k monitor; <i>Basic.</i>	TANEX expansion kit with 7k RAM; 4k EPROM sockets; 10k Basic; 4 S/P; 32 P/P £145. (E).
Nascom 1 (£125)	Nascom: 02405 75155 (20)	4k RAM; Z80; Full K/B; TV int; 2 P/P; 1 S/P; Options: 16k RAM £140; single 5 1/4" F/D (250k) £240 (4 disk controller £127).	2k monitor; <i>BBasic; Tiny Basic; A; T/E; U.</i>	Kit. Built version £140. Also Nascom 2 with 8k Microsoft Basic in ROM £225 (no RAM). (S&H).
77/68 (£90)	Newbear: 0635 30505	4k RAM; 6800; LED; C int; VDU int.	1k monitor; <i>Basic.</i>	Expandable to 64k RAM with F/D. (B).
SBC 100 (£135)	Airamco: 0294 57755	1k RAM; Z80; 8k ROM; S100; 1 S/P; 1 P/P.	1k monitor; <i>DOS in ROM.</i>	Kit. Available assembled £196. (E).
Superboard (£188)	(as Challenger)	4-8k RAM; 6502; 10k ROM; full K/B; VDU int; C int.	Basic (8k ROM).	Options: RS232 port; single 5 1/4" F/D (100k) £316; 8k RAM £188. (S&H).
Smoke Signal SCB 68 (£174)	Systems Implementation Ltd: 06924 5666	1k RAM; 6800/6809; 10-20k EPROM; 1 S/P.	2k monitor.	Many expansion boards available including F/D.
SYM-1 (£160)	Newbear: 0635 30505	1-4k RAM; 6502; C int; VDU int; 2x6522 ports. Option: TV int.	4k monitor; <i>Basic; A.</i>	Expandable to 64k RAM with F/D. (B).
Triton L5.2 (£294)	Transam: 01-405 5240 (N/A).	1-3k RAM; 8080; 1k VDU RAM full K/B; 16x64 VDU or TV int; C int; 1 S/P.	1 1/2k monitor; 2 1/2k Basic.	64-char graphics. Disk int running CP/M about £200. (S&H).
Tuscan (£195)	As above	8k RAM; 8k ROM; Z80A; 5xS100 slots; RS232 port; TV int; C int; 1 P/P.	2k monitor; <i>8k Basic; CP/M; Pascal.</i>	High res graphics available. Can be expanded to F/D system. (S&H).

List of Abbreviations	C/P Commercial package E Extensive F/D Floppy disk G/C Graphics card H Hardware H/D Hard disk	I Introductory int Interface I/S Indexed sequential M/A Macro assembler N/P Numeric pad O/S Operating system	P/P Parallel port S Software S/P Serial port TBA To be announced T/E Text editor T/P Text processor U Utility	W/L Word length W/P Word processor
------------------------------	--	---	---	---------------------------------------

Please note: Software items listed in *italic* are not included in the basic price of the equipment. All prices are *exclusive* of VAT

DIRECT ACCESS

SINGLE BOARDS

UK101 (£179)	Comp Shop: 01-440 7033	4k RAM; 6502; full K/B; 16x48 VDU or TV int; C int; RS232 port, Options: 4k RAM £29.	1k monitor; 8k Basic; Dis A; U.	Graphics. Will run Superboard software. New monitor EPROM with enhanced U £22. (S&H).
ZCB (£260)	Almarc: 0602 625035	1k RAM; Z80A; 3 PROM sockets; RS232 port; 3 P/P.	Will take any 2708/16/32 software.	S100 bus compatible. Expandable to full system. (E).

DIARY DATA

Paris, France	SICOB. Contact French Trade Exhibitions, 01-439 3964	Sept 17 — Sept 26
Bristol, England	(Eurocrest Hotel) BIZTRONIC. Mini/Micro Computers, Word Processors and Business Machines Exhibition. Contact Groundrule Exhibition Co., 061-928 0406	Sept 23 — Sept 24
Plymouth, England	BEX. Business Equipment Exhibition. Contact Douglas Temple Studios Ltd, Tel: 0202 20533	Oct 1 — Oct 2
Melbourne, Australia	World Computer Exhibition. Contact Riddell Exhibition Promotions Pty. Ltd., 166 Albert Road, South Melbourne, Vic 3205.	Oct 14 — Oct 19
Edinburgh, Scotland	(Ingliston Showground) BEXIBITION. Business Equipment Exhibition. Contact Douglas Temple Studios, 0202 20533	Oct 15 — Oct 16
Doncaster, England	(Exhibition Centre) Business Efficiency and Office Equipment Exhibition. Contact Gwen Shillaber Designs, 0272 312850	Oct 15 — Oct 17
Bradford, England	(Norfolk Gardens Hotel) Business Efficiency Exhibition. Contact Gwen Shillaber Design, 0272 312850	Oct 21 — Oct 23
Manchester, England	(Forum) BIZTRONIC. Mini/Micro Computers, Word Processors and Business Machines Exhibition. Contact Groundrule Exhibition Co., 061-928 0406	Oct 21 — Oct 26
London, England	(Olympia) COMPEC. Computer Peripheral & Small Computer Systems Exhibition and Conference. Contact IPC Exhibitions Ltd., 01-837 3636.	Oct 28 — Oct 30
London, England	(West Centre Hotel) Professional Viewdata Exhibition. Contact IPC Exhibitions Ltd., 01-837 3636	Oct 28 — Oct 30
Cardiff, England	(Sophia Gardens) BEX. Business Equipment Exhibition. Contact Douglas Temple Studios Ltd., 0202 20533	Nov 5 — Nov 6
Birmingham, England	(NEC) Which Computer? Show. Contact Clapp & Poliak Europe Ltd., 01-995 4806	Nov 25 — Nov 28

USER GROUPS INDEX

Here are the details of additions and changes recently notified. If we have failed to include YOUR group (or have published incorrect information) either here or in the complete listing, then please address changes/additions to: PCW (User Groups Index), 14 Rathbone Place, London W1P 1DE. Finally, the next complete listing will appear in our November issue.

International Microcomputer Users Club: recently established for program writing and exchange, emphasis on 6502/Z80 users. Contact c/o Synthetronics Microcomputers, P.O. Box 151, 1322 Hoevik, Norway.	National TI58/59 Club: bi-monthly newsletter, program exchange etc. Annual sub £5.50 or, if you include a program with your cheque then it's £3.50. Contact: R M Murphy, Dept of Electronic Engineering, University College Swansea, S. Wales.	Isle of Wight IoW TRS-80 Users Club: Meets each Friday at 8 pm at 72 Union Street, Ryde. Contact: Mr M R Collins, 3 Altofts Gardens, Ventnor, IoW.	Computer Users Club takes place on 1 October at Mereway Upper School, Mereway, Northampton. Contact: J R Jackson at the school, Tel Mereway 63616.
National Sharp User Group: Sub £3 p.a., inc newsletter and free Space Invaders cassette for MZ-80K. Contact: Knights; TV & Computers, 108 Rosemount Place, Aberdeen. Tel 0224 630526.	South IPUG has changed its name to SUPA (Southern Users of PETs Association). Contact: 42 Compton Road, Brighton BN1 5AN.	Kent MACRO (Medway Amateur Computer & Robotics Organisation). Meets monthly, sub £3. Contact Mrs Christine Webster, 13 Ladywood Road, Cuxton, Rochester, Kent. Tel: 0634 78517.	Tyne and Wear Newcastle-upon-Tyne Personal Computer Society: meets first Tues each month in Room D103, Newcastle Polytechnic. Over 60 members, sub £5.00. Several sub-groups inc. PET, TRS-80 and S100 (last one meets weekly). Contact Pete 0632 573905 or John on 0632 579887.
Sorcerer Program Exchange Club: Contact Colin Morle, 32 Watchyard Lane, Formby, Nr. Liverpool L37 3JU, Tel 070 48 72137.	Cornwall Anyone interested in forming a computer club in Cornwall, catering mainly for PET, ZX80 and UK101 computers should contact: M F Grove, 35 Causeway Head, Penzance, Cornwall.	Lancs Merseyside Microcomputer Group: Alan Pope of the 380Z Users Group has changed his tel. no to 051-924 2470.	London South-East London Microcomputer Club: Chairman is now Roger Kreitman; club meets fortnightly at the Thames Polytechnic, Woolwich.
		Northants Inaugural meeting of the Northampton Personal	

TRANSACTION FILE

The classified service that's free to non-commercial readers. Advertisements (50 words max) to: PCW Transaction File, 14 Rathbone Place, London W1P 1DE.

For sale Casio FX502P... plus FA-1 cassette int & music adaptor, with manuals, leads, cases, program	library, demo cassette & some orig progs, owner moving to bigger fish, £90 ono. Tel 0702 713626 ITT 2020... 48k, new & never used in anger, Palsoft in ROM,	colour, UHF/video output, full doc, first over over £730. Also disk drive & controller with progs inc Space Invaders, £275. Tel 06284 73776	ZX80... 4k RAM, assembled with PSU, leads etc, list price £186, accept £120. Tel Chris Lawless, 01-903 1333 ext 393 office hours or 0442 40953 after 7
--	--	---	--

Introducing HP-41C

A powerful new calculator - with its own peripherals!

A new Hewlett-Packard calculator is always a special event. But the new HP-41C is especially special!

It's a fully programmable calculator - advanced, powerful and very versatile. Yet it's also remarkably easy to use, with a helpful alphanumeric display and a range of application modules.

Most important, it has its own dedicated peripherals - including printer, card reader and memory modules.

A unique machine

Program power. 400 lines of program memory (or 63 data storage registers) as standard, expandable up to 2000 lines (319 data storage registers). With RPN logic, for faster problem-solving.

Alphanumeric display. You can name and label programs, functions, variables and constants. The calculator uses words and sentences to prompt for data. The display shows calculator modes and status.

'Customise' feature. Assign any of 68 keyboard functions (or 130 library functions) - or any program you've written yourself - to any key on the HP-41C. To help you, the HP-41C comes with keyboard overlays. (Each assigned function or program name is displayed prior to execution.)

Continuous Memory. Maintains program and data when your HP-41C is switched off. Simply switch on, and continue with your calculation.

A unique system

Look at this impressive list of add-on peripherals!

HP-41C printer. Quietly gives numeric, upper and lower case alpha characters, in single and double width, as well as special characters. And performs high resolution plotting routines.

Application modules. For engineers,

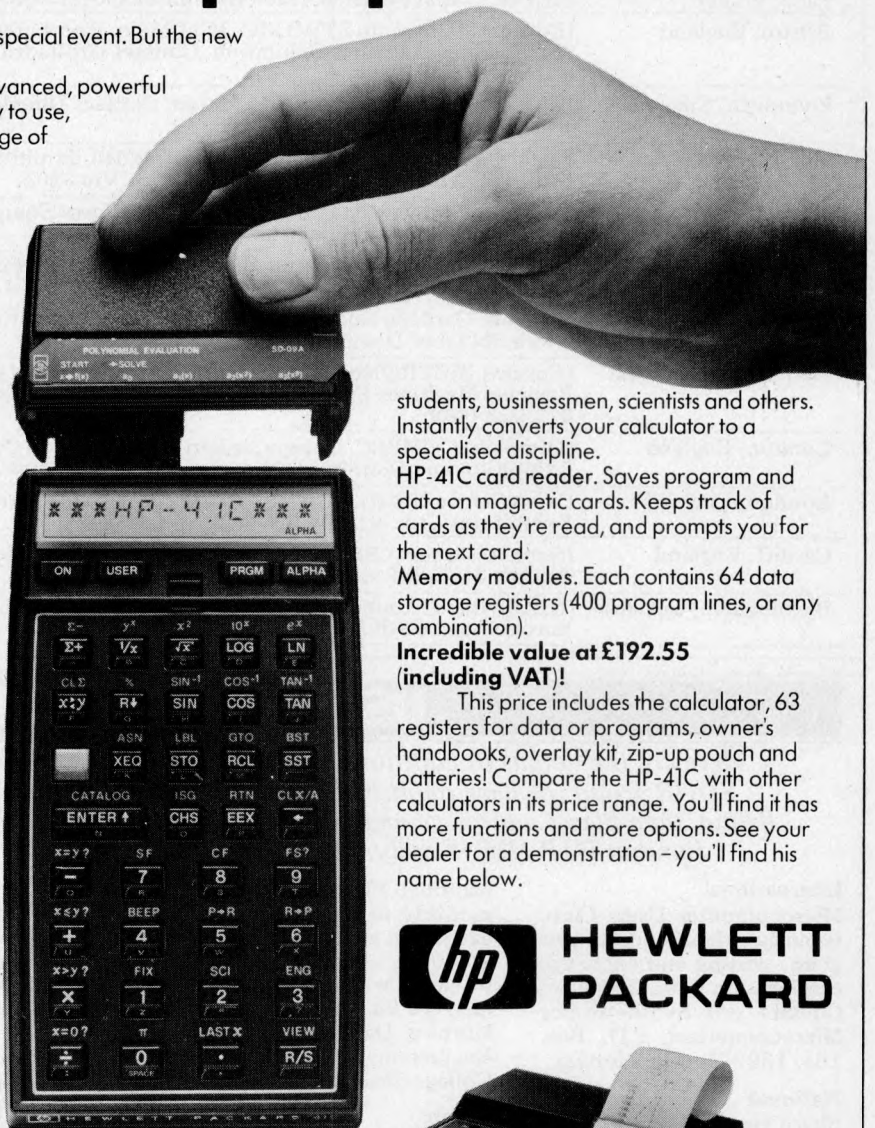

students, businessmen, scientists and others. Instantly converts your calculator to a specialised discipline.

HP-41C card reader. Saves program and data on magnetic cards. Keeps track of cards as they're read, and prompts you for the next card.

Memory modules. Each contains 64 data storage registers (400 program lines, or any combination).

Incredible value at £192.55 (including VAT)!

This price includes the calculator, 63 registers for data or programs, owner's handbooks, overlay kit, zip-up pouch and batteries! Compare the HP-41C with other calculators in its price range. You'll find it has more functions and more options. See your dealer for a demonstration - you'll find his name below.

 **HEWLETT
PACKARD**

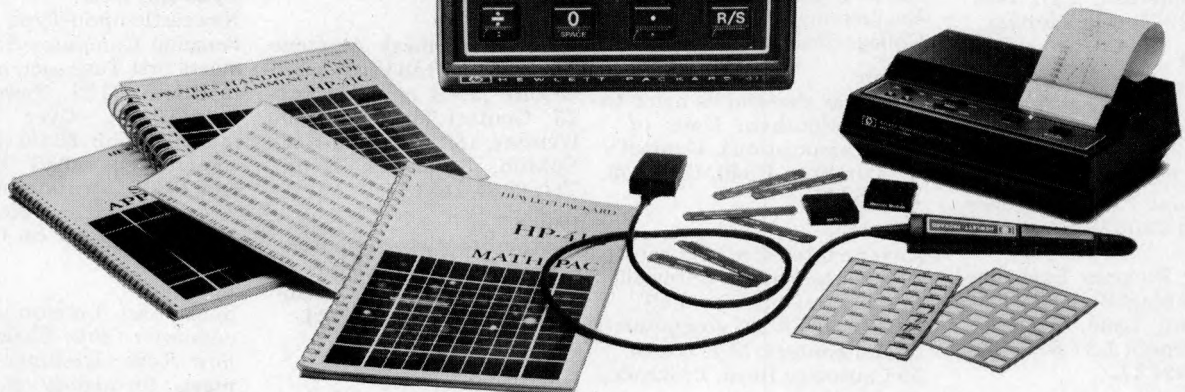

Aberdeen Tyseal Typewriter Services. **Belfast** Cardiac Services Company. **Birmingham** Anglo American Computing; John Mabon Associates; Taylor Wilson. **Bolton** T & R Office Equipment. **Bournemouth** South Coast Business Machines. **Brighton** Office Machinery Engineering Co. **Bristol** Decimal Business Machines; Wilding Office Equipment. **Bromley** Wilding Office Equipment. **Cambridge** W. Heffer & Sons. **Canterbury** R. E. Typewriters. **Cardiff** Sigma Systems (Calculators). **Carlisle** Thos. Hill Group. **Chelmsford** Automatic & Electronic Calculators. **Colchester** Wilding Office Equipment. **Croydon** Landau Calculators; Wilding Office Equipment. **Derby** Office Machines. **Dundee** Toyside Office Equipment. **Edinburgh** Business & Electronic Machines; Holdene. **Folkestone** R. E. Harding. **Glasgow** Robox. **Gloucester** Wilding Office Equipment. **Grimby** Teesdale Office Equipment. **High Wycombe** A. C. Barratt & Co. **Ilford** Wilding Office Equipment. **Ipswich** Anglia Business Machines; Wilding Office Equipment. **Kingston-upon-Thames** Wilding Office Equipment. **Leeds** Holdene; T & R Equipment. **Leicester** A. C. Barratt & Co.; Sumlock Services. **Liverpool** Rockliff Brothers. **London** Automated & Electronic Calculators; City Business Machines, 57 Houndsditch, Bethnal Green Road; Concept Business Machines; Dixons Photographic, 64 New Bond Street; Euro-Calc Limited, 128-132 Curtain Road, 224 Tottenham Court Road, 55 High Holborn; Landau Calculators, Bourne's, Oxford Street, 227 Tottenham Court Road; Logic Box; McDonald Stores; Metyclean, 137 The Strand, 92 Victoria Street; Mountandene; Reid's Office Equipment; Sumlock-Bondain, 15 Clerkenwell Close, Cannon Street Station; Wallace Heaton; Wilding Office Equipment, 7 The Arcade Hoe Street, 21 Thomas Street, 120 The Broadway, Wimbledon. **Luton** Wilding Office Equipment. **Maidstone** Wilding Office Equipment. **Manchester** Automated Business Equipment; Holdene; T & R Office Equipment. **Matlock** Derby Office Machines. **Middlesbrough** Thos. Hill Group. **Newcastle** Thos. Hill Group. **Northampton** A. C. Barratt & Co. **Norwich** Leamons Office Machines; Sumlock-Bondain. **Nottingham** Bennett's (Typewriter & Office Supplies); Trent Office Equipment. **Oxford** Reid's Office Equipment; Science Studio. **Plymouth** JAD Integrated Services. **Reading** Central Southern Calculators; Reid's Office Equipment. **Caversham**, 38 Market Place, Reading. **Romford** Wilding Office Equipment. **Royston, Herts.** Electroplan. **Sheffield** Butlers Office Equipment. **Slough** Wilding Office Equipment. **Southampton** South Coast Business Machines. **Southend** Wilding Office Equipment. **Sunderland** Thos. Hill Group. **Sutton** Landau Calculators. **Swindon** Wilding Office Equipment. **Waltham Cross** Wilding Office Equipment. **Watford** Automatic & Electronic Calculators; Wilding Office Equipment. **Worthing** Office Machinery Engineering Co. **All UK branches of Comet.** **CHANNEL ISLANDS:** Guernsey P.B.S. Jersey Professional Business Systems. **EIRE:** Dublin Abacus Systems.

Nascom 2... 16k RAM board, extra graphics ROM, PSU & manuals £410 ono; TI PC 100 C print cradle for T159/T158, £140 ono; T158, £45 ono. Tel Rochdale 524932

Computhink... 800k dual disk unit complete with DOS logic board for PET. Inc full operating and fitting instructions, technical help if required, only 6 months old, perfect order, bargain at £800 ono. CMC-ADA 1200 PET to RS232 interface for Teletype 43 and others, £50 ono. Tel Flitwick (05257) 2221.

PET... 16k, large keyboard, green anti-glare filter on screen, £450. Tel: Mr Trevena, 01-648 7090.

Cheap memory... 18-pin National full spec MM5270 4k x 1 dynamic RAM chips, 200 ns access, 400 ns cycle, TTL comp. (except CE), sold in lots of 8 plus 18-pin sockets for £1.50 each. Peter Bennell, 69 Rhyd-y-Defaid Drive, Sketty, Swansea SA2 8AN.

MK 14... revised ROM, improved keyboard, standard doc., £40 ono; Elf II static RAM and PSU, giant board, klug board, Elf Tiny Basic, Elfbug, users manual & other doc., £190 ono. Both delivered daytime N. London. Tel: 0438 54241 (Herts)

Acorn... 6502 CPU, hex keyboard, LED display, tape interface, built and working with doc. and PSU £80. Tel: North Weald (037 882) 2924

77-68... VDU board complete, £30; 77-68 4k RAM board, wired, TTL & sockets less memories, £12.50; all LS & buffers for MON 2, £5; alloy rack for 5 boards, £7.50. Tel: Aldridge 52639 after 6pm.

PET 2001... 8k, small keyboard, with 2nd cassette, £395 ono. Tel Cardiff 77195.

Nascom 1... cased, PSU, T2+2k Tiny Basic A; offers or px for TRS-80 16k, C2.4P, PET or sim. If no takers then wanted, Nascom upgrade bits: m/board, buffer memory boards, 8k Basic, Vero case, fast cassette int, etc. Tel: 0253 725979

UK101... prof, built & cased, 8k RAM, 8k Microsoft Basic, extra 2 x 8-bit PIO using 6522 VIA, ideal for beginner, with several working progs and m/c code textbook, etc, full working order, £270. Tel: Colchester 61193.

Texas T158... prog calc, as new, £45; MK 14, additional keyboard, PSU, sockets & software, £40; disco system inc MMAP360, Altec speakers, Citronic console, Solar 250 etc, will exch for Nascom 2, Tandy, Apple, PET with cas either way. Tel: Alan, 01-675 1483.

PET 2001-8k... green screen, sound box, books, 15 tapes, Microchess etc, 9 months old, £450; must sell, unemployed. Tel: Mick Jarvis, (0322) 60150.

PET 2001-8... 8k RAM, integral cassette, inc £100 of software, £30 of books plus lots of PET literature, as new, all for £450 (worth £680). Tel (0344) 27660.

4k SS50... memory boards, built, tested, burnt in, £50 each or £160 for all 4 inc. postage. Tel: Nigel (07048) 76566 after 7.

UK101... 4k RAM, 8k Microsoft Basic, cased with sep. PSU & expansion sockets, fully working, £250. Tel: (06924) 2130.

PET 2001... 8k, hardly used, still under guarantee, £420 for quick sale. Tel: Doncaster 851269 evenings.

Nascom 1... fully built & tested inc NASBUS ext board, 8k RAM, 8k Basic, NAS-SYS, mounted in Vero rack case, 5 months old, £320 ono. Mr Sturgess, 108 Cleveland Rd., Midanbury, Southampton. Tel: 0703 583514.

Acorn... system 1, assembled & complete with PSU & manual, full working order, save over £30 on list, £65. Tel: 0905 353768 business hours, ask for Steve.

Acorn... system 1, built & working with all doc plus several 6502 books, total value £100+, no reasonable offer refused or px against HP67/T159/WHY. Only selling because of lack of time for hobby. Tel: 03632 3157/ write Platler, 13 Beech Park, Crediton, Devon.

PET 16k... large keyboard, new ROMs, TIS workbooks, lots of programs, books & mags, £600 ono. Also spare set of new PET ROMs, £70 ono. Write J Bell, Flat 124, Summertown House, 369 Banbury Road, Oxford

TRS-80 L2... 16k, approx 4 months old, used for learning only, with manuals, Stock Control, Purchase Ledger, Mailing List plus a few games. Brand new CTR 41 inc, but no VDU, £360 ono. Tel: Graham, 04218 3347 or write 11 Glenlea Drive, West End, Southampton SO3 3GU

KIM 1... 6502, 2k ROM, 1k RAM, hex keyboard, 6-digit display, Teletype & cassette ints, plus KIM4 motherboard, 2 x KM-8B 8k RAM, Basic cassette tape, manuals & PSU, all £275. Tel: 072 275 640

Sharp MZ-80K... 20k RAM with integral VDU, cassette & LS, excellent graphics, only 4 months old, hardly used (in home), with manual, demagnetiser games, etc. Best offer over £440 secures. Tel: (77) 44935 evenings.

PET 32k... with Toolkit, ROM, Spacemaker, hardware repeat key, sound box, cassette, 3022 printer, 3040 disk, dust covers, disks, tapes, library disk capes, mains interf, unit, doc., software inc Wordcraft, absolutely perfect, £2350 ono for complete system (won't split). Tel: 061-969 7508.

UK101/Superboard... sound module, generates tunes etc under software control, ready built with software on cassette, £5.50 inc p&p. Mr A Lall, 22 Netley Dell, Letchworth, Herts, Tel: 74089.

ASR33... printer, inc PET int/ software, manual, stand, good working order throughout, £150 ono; ASR33 spares: motor, 20 mA int, perf etc available separately or with above, £15 ono. Tel: 0403 69835.

HP41C... plus 2 memory modules & full doc, only 3 months old, £230. Tel: 0329 280642 after 6.

UK101... 8k RAM, manual, games/demo tape, cased with all cables, powerful Basic, ideal for teaching, £275. Buyer collects. Mr Blatch, 2 Newbury St., Kintbury, Berks. Tel: Kintbury 353.

S100... 8k static RAM board, fully working, £80 ono. G R Cass, 4 Kingsley Place, Heaton, Newcastle-upon-Tyne NE6 5AN.

Superboard II... with PSU, modulator, cassette int, all cables to link to TV and cassette, fully built in Microcase with 4k extra RAM fitted for 8k total, hardly used, complete with all manuals & selection of games, some homegrown, £200. Tel: Pudsey 551015.

Cheap printer... Creed 7B teletypewriter £15, Motorola card reader with V25 (?) and teletypewriter int, £6, IBM-style qwerty keyboard £3, buyer collects or postage extra. Richard Barns, 97 Ringmer Road, Worthing, Sussex BN13 1DU.

Triton... Transam built, L5.1 Tiny Basic and good 8080 monitor in ROM. Full on-board memory, internally expandable, software on cassette, doc, newsletters plus file of personal notes on software and use of comp. Also Merantz C190 recorder & blank cassettes. All reasonable offers considered. Tel: Earldoms 319.

PET 2001-8... complete with system desk, software, manuals, cassettes, green screen, ideal for beginner. Tel: Chris Slade, 048 68 4152 (day), 0420 82838 (eve).

MK 14... revised monitor, cassette cassette int, extra RAM, single step facility, £40. ASCII keyboard KB756, never used, £30. Tel: A Robson, Hull 443316.

NM1... plus 3 amp PSU, £110. CC Soft Level A Basic for NM on two EPROMs, £10, W M Stuart colour graphics, built by Stuart, £30. Write D Climie, 397 Clarkston Rd., Glasgow G44 3JN or Tel: 637 6704.

T158... prog calc, manuals & software book, excellent cond, £45. Tel: 01-807 3249.

Due to upgrading... must sell TRS-80 16k L2, numeric keypad, manuals, books, tapes, plus software. Keyboard fully rebounded. Offers around £500. Tel: Cradley Heath 634798 after 6.

ZX80... works perfectly, complete with manual, TV and tape leads, little used, £70 inc p&p UK. Tel: Maidstone (Kent) 678782.

SYM1... sbc with extra 1k RAM, PIA, connectors, PSU, £130 ono. Boxed, unused components for S100 PSU, £20. Tel: Alan Calderwood, Duntocher 74451 evenings.

MK 14... SCIOS monitor, 1/2k RAM, audio int, cased with PSU, SC/MP tech manual & data sheets, £40 ono. Casio FX201P prog. calc, batt/mains, £20. N Rushton, 123 Roughwood Drive, Northwood, Kirkby, Merseyside.

HP41C... with 4 additional memory modules, as new £220 ono. Tel: Colchester 72772 evenings.

UK101... 8k, built & tested, £270. Various books inc in price. Tom Allaway, 15 Stewards Close, Sutton, Cambs, Tel: 0353 778122.

TRS-80... 16k L2 with library 100 & chess progs, £500 ono. Tel: Lincoln 53254 after 6.

HP-41C... brand new as bought, unwanted gift, still in same packaging, 3 manuals, overlays, wallet, case, extra progs, £180 ono. Tel: 01-959 7818.

Sorcerer... 32k plus development pac, £600 ono. Tel: Foulton-le-Fyde (0253) 885067.

Sixteen... 4027 (4k x 1) memory chips, suitable for Nascom 1, £1 each, all 16 for £15. Tel: Dave on 0702 218662.

Sorcerer... 32k with word proc and development pac, all as new, full doc & tech manual, £800 (cost £1100+). Sorcerer S100 exp box, working but with suspected fault, manual, £100 ono. Tel: Nigel Clark, Harlow 24416 (work), 414234 (home).

Nascom 2... 32k, Basic, graphics, prof metal VDU case, keyswitch on/off, fan, I/O on D type sockets at rear, toroidal trfm, full doc & tapes, £750. 2 high speed optical tape readers, need attention, with manual & spare boards, £50 the pair. Tel: 0234 43843 eve/weekend.

TRS-80... 48k, NEWDOS, printer int, 2 disk drives, dairy farming & accounts progs, as new, £950 complete. T R Worth, Truro, Tel: Mitchell 377.

ITT 2020... 48k, new cond, little used, with floppy disk drive & controller card, colour modulator, Centronics int, disks, brand new manuals, owner likely to work abroad so rig must go! First £1100 secures. Tel: 0385 61767.

Nascom... 16k DRAM board, built, tested, working on Nascom 1, full doc, memory tests & Basic on 300 baud cassette, £110 ono or £155 with 32k Robin Arak, LSVR, Southampton University. Tel: 0703 559122 ext 2196.

TRS-80... L2 16k, cassette deck, leads etc, 2 programming manuals, software, inc Mailfile, personal accounts, stat probability etc, all vgc, £350. Tel: Medway 271595 after 5.30.

UK101... 5k RAM, case, built by comp engineer, many games & routines on tapes, offers around £230. Tel: Mr Church 0245 869370 after 6.

Nascom 1... 8k static RAM (S100), 8k Basic ROM, NAS-SYS & B-BUG, Nascom graphics, 12" portable TV, joystick, sound unit, cassette rec, manuals, loads of software - m/c & Basic, Space Invaders, £270. Stuart colour graphics, £20. Tel: Rickmansworth 78335.

Superboard II... cased, good cond, little used, 2 months old (self-constructed PSU & monitor), expanded to 8k, fully working, £220 ono. Mr S Macnaughton, 66 Dannette Hey, Cantril Farm, Liverpool L28 6YF.

Philips MDCR... mini cassette drive with int. CBM & supporting software in EPROM, 6000 baud, 64 kbytes per side, 6 months, including assembler/debug software, all for £190. Milt Bathurst, 73 rue du Village, 4545 Feneur, Belgium, tel 041/87 40 16.

MK 14... I/O port, extra memory memory, cassette int, new keyboard, revised monitor, £45. Tel: 01-464 2147, ask for Steve.

TRS-80... L2 16k with printer driver, sound box, light pen, wall cabinet, lots of software inc. Electric Pencil, cost £1100+, accept £500 cash. May also sell printer. Tel: 099 387 241

UK101... 4k, fully working with all leads, cased, various cassettes inc extended monitor, disassembler, some games, £200, buyer collects. Whitchurch (Hants) 2602 after 6.

TRS-80... L2 16k, VDU, cassette rec, manuals & some software, £400. 32k expansion int, Teac 40 track dual disks, manuals & some software, £700. Both for £1050. Tel: 0732 356728 eves/weekends.

Elf II... with giant board, monitor, 8-bit I/O, RS232/20 mA & cassette ints, 2 x 86-pin edge connectors, RF modulator, cased, PSU & RCS manuals & short programming course, £100. A T Holt, 65 John Street, Nelson, Lancs.

ZX80... Sinclair-built, inc all leads, PSU, manual & tape with my own progs (Moon lander, master mind etc), excellent cond, £65 - I'm buying larger computer. Tel 0865 511956

UK101... 8k, cased, room for additional boards, RS232 printer int with cable, new editing monitor supplied, loads of prof. software inc chess & real time Startrek. Have upgraded to an Apple, therefore £275. Tel Nottingham 255935, eves.

TRS-80... 16k L2, 7 months old, new style keyboard & green screen VDU, plus £200 worth of software inc Pascal, offers invited. Tel 01-979 5717 (eves)

TRS-80... L2 16k, complete manual & various progs, 8 months old but hardly used, £425, no offers. Tel 0233 713198 after 6

T157... 50 fully-merged steps, subroutines, labels, trig, 8 fully arith mems, case, adaptor/charger, manual, £17. Upminster 23222, ask for Richard.

Triton... built & cased, self-contained monitor, tape rec, keyboard & numeric pad, motherboard with 3/4k RAM card, 7k scientific Basic on ROM card & PSU for expansion, £440 ono; Teletype ASR 33, good cond, working, with TRS-80 int, £200. Tel Byfleet 42348

Cheap... hard copy, Teletype ASR28, 240 V, 50 Hz, working but no data so only £50. Tel 0494 711014.

S100 boards... 2 off Econoram II 8k, both working, £70 each; Tarbell floppy disk PCB, FD1771 IC, bootstrap ROM & Tarbell manual, £55. Tel Camberley 0252 61543 after 6.

32k Apple . . . new, unused, must sell, double disks & controller, b/w monitor, price new £1780, will accept £1500 ono. Tel Burgess Hill 44268, eves.

Nascom 1/Creed . . . buffer board, 2k exp RAM, PSU, 20-slot case, keyboard, Creed 75 printer & int, Nascom/Creed software, 2 D/A converters with M5 software for CRT plotting, £225. Tektronix scope, 40 MHz single & 20 MHz double beam plug-ins, £170. Tel 01-387 5539 day or 0295 77 269 after 8

Telequipment . . . D31R dual trace scope plus 400 assorted comics, books, electronics & computer journals, £100. Tel Mr A Nicholls, Ingrebourne 75432

ZX89 . . . with reverse video switch, leads, PSU, manual, £80. Tel Hockley 9541

NS Horizon . . . dual disks, 40k RAM, 2 serial, + parallel ports, Volkler Craig VDU, built into workdesk with computer, Creed Envoy printer, 8-pin punch & reader, with stand, several text books & progs, little used (in home), sensible offers invited. Tel 042 784 372

MK14 . . . fully working, cased, PSU, all doc, good cond, £40 ono. S Khetepal, 8 Dunoon Close, Rise Park, Nottingham, Tel 0602 273688

TRS-80 . . . L2 16k, complete, boxed with progs, tapes, large selection of books & magazines, all mint, £525. Tel Jim Mitchell, Duntocher 72773 after 6.30

PET 2001 . . . 32k, unused for 9 months, with cover, electronic demagnetiser, cassettes, progs, etc, for quick sale at £420. bi-directional RS232 to parallel int complete for any RS232 printer, £50. Tel 01-267 9444 days or 01-387 6829 eves.

Triton . . . 8k, prof built, leather case, full doc, full on-board RAM, V5.1 monitor, L5.1 Basic, Hitachi tape, leads & tapes, £260. Tel 0299 403418

ZX80 . . . 3 months old, built & working, all leads & manual supplied, can be seen working, £80. Tel 0634 240053

MZ-80K . . . 24k RAM, brand new in makers box, inc Basic tape & manual, 55 progs (ham radio, maths, music, games, Space Invaders etc, Sharp User Club membership, full warranty, £500. S Fisher, 21 Balmoral, Adlington, Nr Chorley, Lancs PR7 4EL

Superboard II . . . 8k RAM, UHF modulator, PSU, cased, working, with progs, offers around £240. L J Stubbs, Tel Crewe 581657

TRS-80 . . . 16k L2, complete system inc Microchess, Backgammon, Blackjack tapes, £450 ono. Tel Horley 73209 after 7

Sorcerer . . . 16k, Basic & Assembler, terminal software (source), some tapes & games, £500. Modified TV to give monitor quality, £50; two good quality cassette units, £20 each. Tel 0628 20888

Acorn . . . system 1, assembled, tested, PSU, Zaks' *Programming the 6502*, all for £85. Write 1 Amberwood Drive, Camberley, Surrey.

Memory board . . . 32k for Nascom 1/2 with ZEAP 2 in EPROM, £190 or £75 less RAM; 4 x 4118 (4k), £35. Tel 01-458 8301

TRS-80 . . . 16k L2, practically unused, good cond, with selection of games & progs, demo given, offers around £400. Tel Ian, Plumtree 4181

ZX80 . . . 2 months old, built, leads, PSU, 4 C12 cassettes with 8 progs, £87 ono. Tel Coventry 415509 after 6

TRS-80 . . . L1 4k, new, game pack, manual & cassette, ideal beginner, complete, £250 ono. Tel 01-802 0777

TM990/189 . . . university module tutorial system, new, with PSU & doc, £250 ono. Tel 0703 557067 after 6

Printerm . . . high speed needle printer, full ASCII, 8½" paper, serial & parallel ints, list price £725, as new at £400 ono. Tel 023 062 200, eves or w/ends

Wordstar . . . w/processing software, unused disk cost £250 two months ago, offered at £165 inc manual. D Mortimer, 4 Royle Cres, London W13, Tel 01-840 1410 day, 01-997 1072 eves.

Apple II . . . 48k Europlus, disk drive, many disks & progs inc library index, w/proc, Space Invaders, chess, utilities, less than a year old, still guaranteed, £900. Tel Max, 01-743 1271 ext 6960 day, 01-354 1767 eves.

Apple . . . Europlus, 16k, Applesoft in ROM, 7 months old, as new, with Hitachi 9" monitor & tapes, £585. Tel 043 879 203

UV EPROM . . . cleaning tube unused, £12.50; ICL 7075 impact termiprinter with keyboard, upper & lower case, single & double spacing, 10, 20 or 30 cps, answerback, RS232, £320 ono. Tel 051-722 6692 eves & w/ends

Two oscilloscopes . . . Tektronix 545, £100; Solartron, £45. Tel Geoff Haydock, 04626 76422.

Modems . . . 4400 Racal/Milgo, 4800 baud, V24/RS232 2 & 4 wire, half/full duplex, sell as pair or single units, £25 each; Centronics 101 matrix printer, 132 col, record recently, working, used on PET, best offer over £75. Tel Horsham 69835

Practical . . . Computing magazine, all to date except Nov 78, Offers? (*I don't blame him for wanting to get rid of them - Ed*) Also wanted to buy/hire, Z80/8080 monitor in EPROM. Tel Basingstoke 22955, eves or w/ends.

PET 3016 . . . 16k, 2040 dual disk drive, ext cassette deck, box of disks, tapes, software inc Bridge challenger & all usual leads & things, hardly used, 3 months old, any sensible offers considered, Tel 0202 23350

Colour graphics. . . (Stuart) board for Nascom 1 with doc, £25; 5" TV, makes excellent monitor, as new, £30. Tel 0702 218662

T159/PC 100C . . . with stats module, RPN sim, maths/ utilities module, dust cover, doc, inc TI source book, mag cards, excellent cond, £300 ono. Tel Chris, 01-449 9864

Apple . . . 48k, 1 disk, 4 months old, as new £1250. Tel 082 581 3168

TRS-80 . . . L2 16k, keyboard, mod, with manuals inc Learning Level II, progs, £350. Tel Berkhamstead 71827

Acorn . . . Sys 1 with opt RAM/ IO chip, built Dec 79, good cond, all doc, £80; Tel 0302 62743

UK101 . . . 4k RAM, built & tested but uncased, cassette rec, games tape, £170 ono. Tel 0670 514536 after 5

UK101 . . . in Microcase, 8k RAM, new monitor ROM, working with manual, cassette software, all leads, recorder, £280 inc postage Tel 0969 23462 after 6.30

ZX80 . . . with manual & PSU, £90 ono. Tel Matthew, 01-340 6545

Full ASR terminal. . . made by ATS; ASCII, RS232 int, Logabax 132pp matrix printer, tractor feed, 60 ch/sec, 1 line buffer, full keyboard, excellent cond, complete, working, on stand with full maintenance doc & spares, originally £2500, asking £800, buyer collects. Tel: Leighton Buzzard 372286.

Dataplex word processor. . . typewriter printer, 2 mag card readers, utilities/word proc software, full set working drawings & doc, bought for hard copy but has developed small fault so £60 ono. Also approx 1 Mbyte spare mag cards, £15. Tel: 0924 271089 evenings.

ZX80. . . fully assembled with Sinclair PSU brand new inc cassette/TV connecting leads & comprehensive instruction & programming manual, £80. Tel: 0908 78884.

T159. . . calc plus print cradle, stats module, rechargeable batt pack, mag prog cards & all manuals, cost £345, accept £195. Tel: Redcar 474707.

Wanted

Nascom 2 . . . for part/total exch with Fischer 553-D metal detector (cost £274) with ground neutralising effect control, max depth penetration, exc. discrimination, 4-year guarantee, has paid for itself in 12 months. John Lewis, 16 Whittington Ave., Hayes, Middx.

80-col VDU . . . with lower case ASCII to swop for a printing terminal with integral cassette, 80-col, which can receive on cassette while transmitting from keyboard and printing, RS232 int for 10/15/20/30 cps. Tel: 01-658 3271.

Vol 1. . . issues 4,5,6,7,9 in good cond, will pay 70p per issue. A Postlewhite, 75 Granlagon, Rhoslanerchrugog, Wrexham LL14 2DP, Tel: Legacy 227.

MK 14 VDU . . . circuit diagram & components list for one week. J Alder, 20 Camperdown, West Denton, Newcastle, Tyne/Wear.

ITT 2020. . . 16k with Palsoft in ROM, must be in good cond, willing to pay about £570. Tel: Nottingham 843970 after 6.

Creative Computing. . . vol 4 no 3 May/June 1978 or a listing of Oregon from that issue. Steward, 19 Carham Close, Corbridge, Northumberland, tel: 043-471 2913.

BACK NUMBERS

Volume 1 No. 1 May 1978
Nascom 1/77-68: The Mighty Micromite/A charity system

Volume 1 No. 2 June 1978
Research Machines 380Z/ Computer in the classroom/ The Europa Bus.

Volume 1 No. 3 July 1978
Buzzwords - A to Z of computer terms/Pattern recognition/Micro music

Volume 1 No. 8 December 1978
Computers and Art/3-D Noughts and Crosses/Mickie - the interviewing micro.

Volume 2 No. 1 May 1979
Small computers for small organisations/Sorcerer graphics/Chess Programming Hints/ Parkinsons Revas.

Volume 2 No. 2 June 1979
MSI 6800/Witbit - disassemble your programs/The Multilingual Machine/Polytechnical Processing.

Volume 2 No. 3 July 1979
Vision link: Interfacing and Software for the Superscamp VDU/Pet Preening/Extended cursor graphics for the TRS-80.

Volume 2 No. 4 August 1979
The North Star Horizon/High Speed Cassette Interface for the SWTP 6800/Garage Accounting program/Apple Medical Application.

Volume 2 No. 7 November 1979
PCW Show issue/6800 Bug/Hard disc security/ Detecting literary forgeries/ Benchtest - the Challenger C3

PLEASE NOTE THAT THE FOLLOWING ISSUES ARE SOLD OUT

VOLUME 1 Nos. 4, 5, 6, 7, 9, 10, 11, 12

VOLUME 2 Nos. 5, 6, 8

VOLUME 3 Nos. 1, 2, 3, 4,

ALL OTHER ISSUES MAY BE ORDERED USING THIS FORM.

Any one issue 95p; Any two issues £1.75; Any three issues £2.50; Any four issues £3.00. All additional issues @ 50p each. Binders @ £2.95. All prices include post and packing. Cheque or P.O. payable to (PCW) SportsScene Publishers Ltd., 14 Rathbone Place, London W1P 1DE. Please allow up to 3 weeks for delivery and don't forget to state clearly your name and full address with your order. Please send me the following copies of PCW. I enclose a cheque/P.O. for £

Volume 1	Volume 2	Volume 3
1 2 3 8	1 2 3 4 7	5 6 7 8 9
<input type="checkbox"/> <input type="checkbox"/> <input type="checkbox"/> <input type="checkbox"/>	<input type="checkbox"/> <input type="checkbox"/> <input type="checkbox"/> <input type="checkbox"/> <input type="checkbox"/>	<input type="checkbox"/> <input type="checkbox"/> <input type="checkbox"/> <input type="checkbox"/> <input type="checkbox"/>

Name _____

Address _____

*Tick appropriate boxes

For this years back issues, see Feature Index on page 47.

PARKINSON'S PEP-UP

Continued from page 83
move and searches the table again.)

Optimisation

The loop takes 37 clock cycles to execute so, for every once round the loop, the program spends 22 cycles in the rest of itself $(37/(22+37)=63\%)$. If the Z80 instruction CPDR is used to search the table (21 cycles/loop) the ratio now becomes 21:22, approximately 49% of the total time now being spent in the loop. Changing the routine slightly to use CPDR gave the dotted activity profile in Figure 2, and Microchess's 'thinking time' was reduced by 27%.

8080-compatible optimisation is more complicated and involves ensuring that the piece table starts on a page boundary. As the program was completely dominated by this one small

section of code, no further optimisation was attempted.

Other applications

Although I have not tried this, it should be possible to extend the technique to Basic programs. However in this case the interrupt routine must ignore the return address, (unless you are interested in profiling the interpreter) and use the line number of the currently executing line, which all Basics hold somewhere. Remember to watch that stack pointer — SWTP Basic does weird things with it almost everywhere. Nas-Sys 1 briefly on the RCAL and SCAL entry points (fixed on NAS-Sys 3), but what does your system/program do? The example of Microchess demonstrates the usefulness of the technique. It does not take long to apply (less than half-an-hour if you already have the hardware) and can save many fruitless hours' work, as it did in this case.

Computer Games cont. from page 85

A mistaken attempt to open up the diagonal to the white king.

21 f3-g5 f5-e4
22 c3-e4 f8-f2

This move appears, at first glance, to be very strong. If now 23 e4-f2, Black's queen immediately gives mate on g2. But the program had seen further in the crucial variation than its opponent.

23 d1-d6!

When he saw this move Stean exclaimed, "Bloody iron monster". The point is that Black's queen is needed to prevent d6-d8 mate, and the queen is attacked. If the queen moves to a square that protects d8, White can then capture the rook on f2. So White must win material.

23 ... c6-d6

The best try.

24 e4-d6 f2-g2

Threatening to move the rook to g5, c2 or e2, with check from the bishop on b7. Any of these moves would win for Black, but ...

25 g5-e4

Blocking the crucial diagonal.

25 ... g2-g4

26 c2-c4

Blocking off another line of attack.

26 ... e7-f5

27 h2-h3

Stean had hoped for 27 d6-f5 e6-f5, when Black wins the other knight which is pinned against the white king. When the computer played h2-h3 Stean cried out, "This computer is a genius".

27 ... f5-g3+
28 h1-h2 g4-e4
29 a2-f2!

Yet another tactical blow. Black had only expected 29 d6-e4 g3-e4, when he has sufficient material to make the program's task quite difficult. But this latest move, threatening mate by f2-f7+ and then f7-f8 mate, forces an even greater material advantage.

29 ... h7-h6

30 d6-e4 g3-e4

31 f2-f3 b4-b8

32 e1-e4 b8-f8

33 f3-g4 a8-e4

34 g4-e6+ g8-h8

35 e6-e4 f8-f6

36 e4-e5 f6-b6

37 e5-c5 b6-b3

38 c5-c8+ h8-h7

39 c8-a6 Black Resigns

There was once a time when leading experts in computer science would say that "Computers can't play chess".

Bibliography

Frey, Peter W: *Chess Skill in Man and Machine*, Springer Verlag, 1977.

Gillogly, J J: *The Technology Chess Program*, Artificial Intelligence, vol 3 (1972), pp 145-163.

Greenblatt, Richard D, Eastlake, Donald E III, and Crocker, Stephen D: *The Greenblatt Chess Program*, Proc. Fall Joint Computer Conf. 1967, pp 801-810.

IMAGE Listing cont. from page 59

```
***** Read N Cartesian coordinates and construct matrix
OC of homogeneous coordinates *****
200 READ N
210 DIM OC(N,4),TC(N,4),T(4,4),IC(N,2)
220 FOR R=1 TO N: FOR C=1 TO 3: READ OC(R,C)
230 NEXT C: OC(R,4)=1: NEXT R: RETURN

***** Calculate the elements of the transformation
matrix RSTCP *****
300 F=3.141592/180
310 SA=SIN(ALPHA*F): CA=COS(ALPHA*F): SB=SIN(BETA*F)
320 CB=COS(BETA*F): SG=SIN(GAMMA*F): CG=COS(GAMMA*F)
330 T(1,1)=A*CB*CG
340 T(1,2)=B*CB*SG
350 T(1,4)=C*SB*RZ
```

MICROMART

UK101 AND SUPERBOARD
SOFTWARE FROM THE GUY WHO
WROTE "LE PASSE-TEMPS".

C1 Le Passe-Temps, Hangman, Dambusters, Battleships.
C2 Awari, Solitaire, Codebreaker, Armless Bandit.
C3 Blackjack, Nim, Hexapawn, Noughts and Crosses.
C4 Sweeper, Bomb Run, Piranha, Wall-Ball.
C5 Lunar Lander, King Albert (Patience), Roulette, Number games.
C6 Stockmarket, Steeplechase.
C7 Stud Poker, Galactic Hitchhiker Adventure
C8 Startrek (real time, super graphics)
C9 Basic tutor (1 to 4)
C10 Basic tutor (5 to 8)
Cassettes 1 to 4 available for UK101 or Superboard (please state), others UK101 only. "Breakout" can be substituted for any program you already have. C4 is an all-graphics pack. C6/7/8 comprise 8K programs.
Prices £5 each all incl. from Mr A Knight
28 Simonside Walk, Ormesby, Cleveland,
Tel (0642) 321266.

UK101 NASCOM 1 & 2

ADD-ON COLOUR SYSTEM

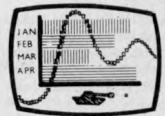

DAZZLING COLOUR GRAPHICS FOR UK101 & NASCOM

- Professional bit-addressable 'pixel' system
- 3072 colour cell definition
- 8 Colours foreground + 8 background
- FREE SOFTWARE: Plot, Line, Circle (Basic + Z80)
- Animated Demonstration Program
- Modulator included for use with normal TV

KIT: only £45 Built & Tested: only £60

Also available separately:

COLOUR MODULATOR

- R G B inputs, PAL/UFH output
- Unlimited colour combinations
- TTL etc interface details supplied
- 1000's already in use!

KIT: only £12 Built & Tested: only £18

— please add VAT at 15% to all prices
— Barclay/Access orders accepted by telephone

WILLIAM STUART SYSTEMS Ltd
Dower House, Billericay Road, Brentwood, Essex CM13 3SD
Telephone: Brentwood (0277) 810244

PET HIRE Southampton

Weekly charges:

8K large keyboard £23, 32K £30,

Tractor Printer, Floppy Disk £30, Manuals, Tutorials, Games included.

New low Commodore prices:
16K from £475, 32K from £565, Printer £425, Floppy Disk £695

All prices include VAT

Ex hire machines available

Official Commodore Dealer

SUPER-VISION

13, St. James Road, Shirley, Southampton.

Telephone (0703) 774023

After Hours (0703) 554488

Understanding Microprocessors with
the S.O.C.

Mk14

Full programming manual at last!

★ 216 pages for £5.95!

★ programming, number-crunching, DMA, memory expansion, all those missing Mk14 details!

★ limited edition, by Macmillan Press

At your local bookshop, or direct from Tony Watson,
Globe Book Services, Little Essex Street, London WC2.
(add 35p postage)

MICROMART

CASSETTE STORAGE

Keep your tapes tidy and easily accessible at all times.



— Holds up to 20 tapes in this neat white tray — made of high impact Polystyrene — 290mmx270mmx18mm (11½"x10¾"x¾") — ideal for desk drawers etc.
Price £1.95 inc. p&p.
Send cheques or postal orders payable to "Cassette Storage" To: Unit 121 Linney Road, Beaumont Leys, Leicester.



NASCOM 1&2

INVASION EARTH! (NS/G) — fast M/C code version of the popular arcade, pub game / 4 INVADER types/intelligent homing, exploding, angled, direct, multiple warhead & radio-jamming missiles/40 skill levels. Only £9.95!
SUPER STARTREK! (min 16k) — your mission, Cpt.Kirk, is to destroy the Klingon fleet & save the Federation. Phasers, photon tubes & computer operational! £9.95

(Super) LIFE (G)	£8.95	Renumber	£6.95
Alien Labyrinth (NS/G/16k)	£7.95	Submarine Chase (G)	£5.45
Space Fighter (NS/G)	£7.95	Driver (NS/G)	£6.95
Secret Agent (NS/G)	£5.95	Stock Market	£6.45
Sheepdog Trial (NS)	£5.95	Labyrinth (NS/G)	£5.45
		Death Run (NS/G)	£6.95
		Code-Breaker	£4.95

NASCOM 1 — Cottis Blandford cass. interface-load STAR-TREK in 2mins NOT 10! £14.90 or £11.90 with program.

WRITTEN ANY PROGRAMS? — WE PAY HANDSOME ROYALTIES!
(NB Coming shortly — Program Competition)

Send Chq/PO +45p/order p&p or SAE for catalogue
Telephone (0532) 683186
(G=graphics, NS=Nas-sys only
TRADE ENQUIRIES WELCOME

PROGRAM POWER
5 Wensley Road
Leeds LS7 2LX

NASCOM USERS

PROGRAMS THAT WORK

Book: £ 7.50 incl.
Tapes & Book: £20.00 incl.

- * Super BASIC programs
- * Charts
- * Interface Details
- * Tech. Tips & Improvements

Learn more about your NASCOM
SAE for more info:-

P. TOWN, 30 WOLSEY DRIVE,
WALTON-ON-THAMES. SURREY

ZX80

Large range of low-priced ZX80 software, games and education. For catalogue, write: ZX80 Users Club, C/- Tim Hartnell, 93 Coningham Road, London, W12

- 360 T(2,1)=A*(SA*SB*CG-CA*SG)
- 370 T(2,2)=B*(SA*SB*SG+CA*CG)
- 380 T(2,4)=-C*SA*CB*RZ
- 390 T(3,1)=A*(CA*SB*CG+SA*SG)
- 400 T(3,2)=B*(CA*SB*SG-SA*CG)
- 410 T(3,4)=-C*CA*CB*RZ
- 420 T(4,1)=U: T(4,2)=V: T(4,4)=1-W*RZ
- 430 FOR R=1 TO 4: T(R,3)=0: NEXT R
- 440 RETURN

***** Matrix multiplication [TC] = [OC] X [T] *****

- 500 MAT TC=OC*T :RETURN
- or
- 500 FOR R=1 TO N: FOR C=1 TO 4: S=0
- 510 FOR J=1 TO 4: S=S+OC(R,J)*T(J,C): NEXTJ
- 520 TC(R,C)=S: NEXT C: NEXT R: RETURN
- ***** Calculate and print image coordinates (x'',y'') corresponding to homogeneous coordinates in [TC]
- 600 FOR R=1 TO N
- 610 IC(R,1)=TC(R,1)/TC(R,4)
- 620 IC(R,2)=TC(R,2)/TC(R,4)
- 630 PRINT R;IC(R,1),IC(R,2):NEXT R:RETURN

***** e.g. The Cartesian coordinates for the points shown in Figure 1. *****

- 1000 DATA 8,-1,1,1,1,1,1,1,-1,1,-1,1,-1,1,-1
- 1010 DATA 1,1,-1,1,-1,-1,-1,-1,-1

ADDITIONAL SUBROUTINES.

- ***** Calculate screen coordinates (p q) corresponding to homogeneous coordinates in [TC] See VIDEO GRAPHICS section. *****
- 700 DIM SC(N,2)
- 710 P= : Q= : YD=
- 720 FOR R=1 TO N
- 730 SC(R,1)=INT(TC(R,1)*Q/YD/TC(R,4))+P/2)
- 740 SC(R,2)=INT(TC(R,2)*Q/YD/TC(R,4))+Q/2)
- 750 NEXT R:RETURN

NB. Insert suitable values in line 710.

- ***** Join the appropriate screen coordinates with straight lines; the example being the cube in Figure 1. See JOINING INFORMATION section *****
- 800 DATA 12,1,2,2,3,3,4,4,1,1,5,5,6
- 810 DATA 6,7,7,8,8,5,2,6,3,7,4,8
- 820 READ NL: FOR L=1 TO NL
- 830 READ P1,P2
- 840 JOIN (SC(P1,1),SC(P1,2),SC(P2,1),SC(P2,2))
- 850 NEXT L: RETURN

PROGRAMS

PET Racer

by Kim Mulji

An excellent two-player car race program from a YCW reader.

- ```

0 REM ** RACER BY KIM MULJI 19/6/80 **
1 FOR I=0 TO 10: GET A$: NEXT I: GOSUB 5010: PRINT "I"
2 PRINT "LAPS= 0 CAR RACE LAPS= 0": D=0: C=0: MA=0: ME=0: SE=0: SC=0
3 PRINT "
4 PRINT "
5 PRINT "
6 PRINT "
7 PRINT "
8 PRINT "
9 PRINT "
10 PRINT "
11 PRINT "
12 PRINT "
13 PRINT "

```

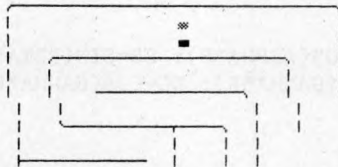

# PROGRAMS

```

14 PRINT"
15 PRINT"
16 PRINT"
17 PRINT"
18 PRINT"
19 PRINT"
20 PRINT"
30 PRINT"
40 PRINT"
50 PRINT"
86 P=32948:H=F
87 F=32908:J=F
88 A=500:Z=98:X=104
90 IF P=33509 THEN MA=1
91 IF F=33509 THEN ME=1
92 IF MA=1ANDME=1ANDP=HANDF=JTHEN700
93 IF MA=1ANDME=1ANDP=JANDF=HTHEN700
94 IF MA=1 AND P=J THEN 800
95 IF MA=1 AND P=H THEN 800
96 IF ME=1 AND F=J THEN 900
97 IF ME=1 AND F=H THEN 900
98 GETA$:IF A$=""THEN200
99 REM *GETS CHARACTERS FROM KEYBOARD*
100 IF A$="8"THENC=-40:N=0:GOTO200
101 IF A$="W"THEND=-40:GOTO200
102 IF A$="5"THENC=0:GOTO200
103 IF A$="S"THEND=0:GOTO200
110 IF A$="6"THENC=1:N=0:GOTO200
111 IF A$="D"THEND=1:GOTO200
120 IF A$="4"THENC=-1:N=0:GOTO200
121 IF A$="A"THEND=-1:GOTO200
132 IF A$="2"THENC=40:N=0:GOTO200
133 IF A$="X"THEND=40:GOTO200
200 FORV=0TO500-A:NEXT:A=A+20
201 IF PEEK(P+C)=104ORPEEK(P+C)=92 THEN 300
202 IF PEEK(F+D)=98ORPEEK(F+D)=97 THEN 300
205 IF PEEK(P+C)<>32 THEN C=0
206 IF PEEK(F+D)<>32 THEN D=0
207 IF C=40 OR C=-40 THEN Z=97
208 IF D=40 OR D=-40 THEN X=92
209 IF C=1 OR C=-1 THEN Z=98
210 IF D=1 OR D=-1 THEN X=104
211 P=P+C:POKEP-C,32:POKEP,Z
212 F=F+D:POKEF-D,32:POKEF,X
214 GOTO90
300 POKEP,214:POKEF,214
310 FORI=0TO300:NEXT
311 A=0
320 GOTO205
700 SC=SC+1:SE=SE+1
710 PRINT" ";TAB(9);SE:TAB(32);SC
720 IF SC=NN AND SE=NN THEN 780
730 IF SC=NN THEN 850
740 IF SE=NN THEN 950
750 GOTO 93
780 PRINT" A DRAW
781 PRINT" PRESS ANY KEY
782 GET A$:IF A$=""THEN782
783 GOTO 2
800 SC=SC+1
801 MA=0
810 PRINT" ";TAB(32);SC
820 IF SC=NN THEN 850
830 GOTO 93
850 ME=0:MA=0:SC=0:SE=0:PRINT" THE WINNER IS THE ' ' CAR
851 PRINT" PRESS ANY KEY
852 FORV=0TO1000:NEXT
853 FORN=0TO9:GETA$:NEXT
854 GET A$:IF A$=""THEN854
855 GOTO 2
882 FORV=0TO1000:NEXT
883 GOTO 853
900 SE=SE+1
901 ME=0
910 PRINT" ";TAB(9);SE
920 IF SE=NN THEN 950
930 GOTO 93
950 ME=0:MA=0:SC=0:SE=0:PRINT" THE WINNER IS THE ' ' CAR
951 PRINT" PRESS ANY KEY
952 FORV=0TO1000:NEXT
953 GOTO 853
5010 REM *** INSTRUCTIONS *** -
5015 PRINT" ";
5100 PRINTTAB(14)"CAR RACE"
5150 PRINTTAB(14)" "
5200 PRINT" THIS IS RACING GAME WHERE YOU HAVE TO"
5300 PRINT"DRIVE YOUR CAR AROUND THE TRACK FIVE"
5400 PRINT"TIMES."
5500 PRINT" THERE ARE TWO CARS ' ' AND ' ' THESE"
5600 PRINT"ARE CONTROLLED BY FOUR KEYS EACH"
5700 PRINT:PRINT" W S "
5800 PRINT" LEFT A S D RIGHT 4 5 6"
5900 PRINT" X 2 "
6000 PRINT:PRINT"TO MAKE THE ' ' CAR GO RIGHT YOU "
6100 PRINT"WOULD PRESS 'D' AND TO MAKE THE ' ' CAR"
6200 PRINT"GO UP YOU PRESS 'S'"
6210 PRINT"TO STOP PRESS THE CENTRE KEY '8' OR '5'"
6300 PRINT" YOU START OFF GOING LEFT AND CARRY ON"
6310 PRINT"GOING ROUND THE TRACK"
6400 PRINT" SOMETIMES IF YOU HIT THE OTHER CAR "
6500 PRINT"YOU CRASH WHEN YOU START AGAIN YOU MOVE"
6700 PRINT"SLOWLY AT FIRST AND GET FASTER AND "
6800 PRINT"FASTER UNTIL YOU RETURN TO NORMAL SPEED"
6850 PRINT
6900 PRINT" PRESS ANY KEY"
6910 GET A$:IF A$=""THEN6910
6920 PRINT" HOW MANY LAPS DO YOU WANT TO GO ROUND"
6930 PRINT" TO WIN":INPUT NN
7100 RETURN
READY.

```

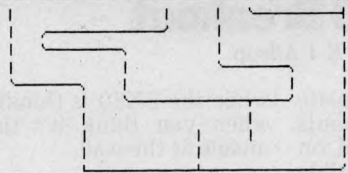

# MICROMART

## MICROTEK

SHARP - NASCOM  
NORTH STAR  
SEE SHARPS INCREDIBLE  
POCKET MICRO

Full software-hardware  
support-programs professional-  
ly written to your  
specification.

MICROTEK  
Ipswich (0473) 50152

**20% DISCOUNT ON**

**PET 3022 PRINTERS**

*We have a limited stock of brand  
new 3022 Printers to clear at an  
extremely competitive price of £340.00  
+ VAT*

*Also Compay @ £110.00 + VAT. and  
Wordpro II @ £55.00 + VAT*

*This is for a short period only, so hurry.  
Phone & Mail Orders accepted  
(Barclaycard & Access)*

To: DaVinci Computers Ltd.,  
65 High St., Edgware. Middx.  
HA8 7DD  
Telephone: 01-952 0526

## CARDIFF MICRO CENTRE

PETs  
+  
SHARP MZ-80s  
+  
HEWLETT PACKARD  
+  
COMPUTER BOOKS

## SIGMA SYSTEMS

54 Park Place  
Cardiff 21515/34869

DISC DRIVE AND BRILLIANT  
COLOUR

### COMPUCOLOR II

LIMITED OFFER AT SILLY PRICES  
AN 8K AVAILABLE AT £899!  
ANOTHER 32K FOR ONLY £999!!  
EACH WITH MANUAL, DISCS-READY  
TO GO.

FREE PERSONAL DELIVERY  
EXCELLENT FOR DISPLAY OR  
EDUCATIONAL USE - UNIQUE  
OPPORTUNITY FOR ENTHUSIAST,  
SCHOOL OR COLLEGE

PHONE 0858 - 65894  
FOR DETAILS

# MICROMART

## PET SOFTWARE SALE!

Fast machine code sort. . . £2.50  
 VAT system . . . . . £3.00  
 Linear equations . . . . . £3.00  
 All games only. . . . . £2.50

Just a few of our well tried, reliable programs!  
 All prices include VAT, but add 20p for post  
 and packing.  
 Programming and consultancy services  
 available  
 Send sae for full list of programs and prices.

**PI-LOK SYSTEMS LTD.**  
 313 Bury & Rochdale Old Road, Heywood,  
 LANCS. OL10 4BG

### PET A/D INTERFACE, SOUNDBOX

Put PET to good work measuring/recording/  
 displaying up to 8 analogue voltage inputs  
 simultaneously with INPORT 8, or one channel  
 with INPORT 1. Basic and machine code operating  
 programs free with either unit. All interfaces  
 are ready built and simple to use.

INPORT 1 single channel £65,  
 INPORT 8 eight channel £75

Let PET play or make noises in games with CB2  
 sound, ready built interface with free program.

PET SOUND £20  
 SOFTWARE on cassette

High resolution 1-8 channel bar graph display in  
 basic £6

High resolution 1-8 channel bar graph display in  
 machine code for very fast display of all channels  
 £12

Single channel chart recorder £6

Please add 15% VAT to total order and state  
 OLD or NEW ROM PET.

Alphur Electrics, 29 Holme Lane, Bradford  
 BD4 0QA. Tel: 0274-685926

### NOW YOUR PET CAN DO ALGEBRA and CALCULUS as well as Arithmetic with new interactive ALGULUS

Professionally developed by  
 University Lecturer and available  
 directly from him.

Example

$DIST = 4 - 3.5 X + X^2$

Differentiation:-

$VEL = d DIST / dX$

PRINT 0.5\*VEL\*VEL

$6.125 - 10.5 X^2 + 4.5 X^4$  (output)

Integration of VEL from 1 to X and

factorization:-

$FACT 3X^2 - 5X - 4VEL - 2S(1;X)$

VEL dX

$(9+2X)(1-X)(1+X)$  (output)

The polynomial based system features  
 addition subtraction, multiplication, dif-  
 ferentiation, integration (definite and  
 indefinite), substitution of numerical  
 values and factorization.

For further details send s.a.e.

For cassette send £15 cheque payable to  
 D. J. Wright to: Dr D J Wright,  
 Operational Research, Sussex University,  
 Brighton BN1 9RF, U.K.

## EPROM BOARD for NASCOMS

For Nascom 1 and 2 plugs straight into  
 Nasbus, and takes  
 8 X 2708 EPROMS  
 plus 8K BASIC ROM  
 £46 fully assembled, ex-stock  
 Price includes VAT & p&p, but  
 excludes 77 way connector socket.

Merseyside Nascom Users Group,  
 Samuel House, Taylor Street,  
 Liverpool L5 5AD.

# PROGRAMS

## ZX80 Breakout

by K I Allsop

The aim is to remove a complete column of five bricks in as few attempts as possible. Brick removal is based on time because the screen is invisible while the ZX80 is thinking. Hit 'return' when you think it's time to fire the missile at the wall.

```

10 LET F=0
20 LET G=0
30 DIM B(160)
40 FOR A=1 TO 160
50 LET B(A)=1
60 NEXT A
70 PRINT, "BREAKOUT"
80 PRINT
90 PRINT
100 FOR A=1 TO 160
110 IF A=F THEN PRINT "***";
120 IF A=F THEN GOTO 150
130 IF B(A)=1 THEN PRINT " ";
140 IF B(A)=0 THEN PRINT " ";
150 NEXT A
160 FOR A=1 TO 32
170 FOR D=0 TO 4
180 LET E=A+D*32
190 IF B(E)=1 THEN GOTO 220
200 NEXT D
210 GOTO 320
220 NEXT A
230 LET G=G+1
240 POKE 16415,0
250 POKE 16414,0
260 INPUT A$
270 LET F=PEEK(16414)+PEEK(16415)*256-4
280 CLS
290 IF F>160 THEN GOTO 350
300 LET B(F)=0
310 GOTO 70
320 PRINT " "
330 PRINT, "BREAKOUT",G;"GOES"
340 INPUT W
350 PRINT "TIMEOUT"

```

## Algebraic Expression Evaluation for the PET

by D Milnes

A super program which allows you to enter an expression followed by variable values which are then promptly evaluated.

```

100 GOSUB2000:PRINT" ";POKE59468,14:POKE59458,60:GOSUB7000
110 PRINT"TYPE ANY ALGEBRAIC EXPRESSION":PRINT"*****":GOSUB3000
120 X$=Z$:LZ=LEN(X$)
130 IFB%<A%THENPRINTS$:PRINT:PRINT"MISSING RIGHT PARENTHESES":GOTO500
140 IFB%>A%THENPRINTS$:PRINT:PRINT"MISSING LEFT PARENTHESES":GOTO500
150 DIMB$(LZ+2),A$(LZ+2)
160 FORIZ=1TOLZ+2:B$(IZ)="0":NEXT:FORIZ=1TOLZ:B$(IZ)=MID$(X$,IZ,1):NEXT
170 TZ=0:IZ=1:Z=ASC(B$(IZ)):IF(Z<65ORZC>90)AND(Z<48ORZC>57)THEN1000
180 FORIZ=1TOLZ:Z=ASC(B$(IZ)):IFZC<>65ANDZC<>67ANDZC<>83ANDZC<>76ANDZC<>73THEN
270
190 IFZC<65ORZC>90THEN340
200 IFASC(B$(IZ+1))<65ORASC(B$(IZ+1))>90THEN300
210 IF(ASC(B$(IZ+2))<65ORASC(B$(IZ+2))>90)ANDIZ<LZTHENLZ=LEN(X$):IZ=IZ+TZ+1:GOT
01000
220 B$(IZ)=B$(IZ)+B$(IZ+1)+B$(IZ+2):FORI=1TO9:IFB$(IZ)=C$(I)THEN240
230 NEXT:Z$="*****UNCTION INVALID":GOTO1000
240 IFB$(IZ+3)<>"THENIZ=IZ+1:GOTO1000
250 FORJZ=IZ+1TOLZ:B$(JZ)=B$(JZ+2):NEXT:IZ=IZ+1:LZ=LZ-1:TZ=TZ+1
260 GOTO340
270 IFZC<65ORZC>90THEN340
280 IFASC(B$(IZ+1))<65ORASC(B$(IZ+1))>90THEN300
290 IFB$(IZ)<>"THENLZ=LEN(X$):IZ=IZ+1:GOTO1000
300 FORJZ=IZ-1TO1STEP-1:IFB$(JZ)=B$(JZ)THEN340
310 NEXTJZ:IF(LEN(B$(IZ))=3ORASC(B$(IZ))<65ORASC(B$(IZ))>90)THEN340
320 KZ=KZ+1:PRINT" ";POKE216,10:PRINT"VALUE FOR ";B$(IZ); "="":GOSUB3000:GOSU
B4000
330 A$(KZ)=Z$:Z$=" "
340 NEXTIZ
350 PRINT"X=";X$:GOSUB5000
360 PRINT"THE ANSWER TO THE EQUATION AND VALUES ENTERED IS AS FOLLOWS --"
370 PRINT"*****":TAB(5);"OHEN X = ";X$:KZ=0
380 FORIZ=1TOLZ:IFASC(B$(IZ))<65ORASC(B$(IZ))>90ORLEN(B$(IZ))=3THEN420
390 FORJZ=IZ-1TO1STEP-1:IFB$(JZ)=B$(JZ)THEN420
400 NEXTJZ
410 KZ=KZ+1:PRINT:PRINTTAB(6);"AND ";B$(IZ); "="":A$(KZ)
420 NEXTIZ
430 PRINT"*****":TAB(8);"VALUE OF X = ";X
440 PRINT:PRINT"DORE ";GOSUB3000:R$=Z$:IFLEFT$(R$,1)="N"THEN500
450 IFLEFT$(R$,1)="Y"THENZ=0:GOTO470
460 PRINT" ";TAB(7+LEN(R$));FORIZ=1TOLEN(R$):PRINTCHR$(20);NEXT:PRINT" ";GO
T0440
470 PRINT:PRINT"NAME EQUATION AS ABOVE?":GOSUB3000:R$=Z$:IFLEFT$(R$,1)="Y"TH
EN180

```

# PROGRAMS

```

480 IF LEFT$(R$,1)="N" THEN CLR:GOSUB 2000:GOTO 110
490 PRINT "T";TAB(24+LEN(R$)):FOR I=1 TO LEN(R$):PRINT CHR$(R$(I)):NEXT:PRINT "T":GO
T0470
500 POKE 59458,30:END
1000 IF IZ=1 THEN Z$="NO, ILLEGAL FIRST CHARACTER"
1010 PRINTS$:" MARKED "
1020 PRINT "M":LEFT$(X$, IZ-1):" ";MID$(X$, IZ, 1):" ";RIGHT$(X$, LZ-IZ):PRINT Z$
1030 GOTO 500
2000 DIM C$(9):A%=0:B%=0:IZ=0:TZ=0:JZ=0:LZ=0:A=0:B=0:C=0:Y=0:X=0:LX=0:FL=0:KZ=0
2010 FOR I=1 TO 9:READ C$(I):NEXT
2020 IZ=PEEK(65000):IF IZ=254 THEN 2000
2030 IF IZ=192 THEN 2060
2040 PRINT "DORRY - YOUR _ IS NOT COMPATIBLE WITH THIS PROGRAMME."
2050 PRINT:PRINT" -// ABORTED":GOTO 500
2060 AA=527:AB=528:AC=529:AD=530:AE=531:AF=532:AG=533:AH=534:AI=535:AJ=536:AK=5
25
2070 GOTO 2090
2080 AA=623:AB=624:AC=625:AD=626:AE=627:AF=628:AG=629:AH=630:AI=631:AJ=632:AK=1
58
2090 Z$="MORE THAN SINGLE CHAR: VAR:":S$="0070 11 11 11 _ _ _ "
2100 RETURN
3000 AS$="":ZA$=""
3010 GETA$:IFA$<>"":THEN 3030
3020 PRINT Z$:FOR ZT=1 TO 200:NEXT:ZZ$="":PRINT ZZ$:FOR ZT=1 TO 200:NEXT:ZZ$=" "
3030 IFA$="X" THEN A$="":GOTO 3010
3040 IFA$="<" THEN A%=A%+1
3050 IFA$=">" THEN B%=B%+1
3060 IFA$="&" AND A$=CHR$(13) THEN 3010
3070 IFA$=CHR$(13) THEN PRINT A$:RETURN
3080 IFA$=CHR$(20) AND ZA$="" THEN 3010
3090 IFA$=CHR$(20) AND ZA$<>"":THEN PRINT A$:ZA$=LEFT$(ZA$,LEN(ZA$)-1):GOTO 3010
3100 ZA$=ZA$+A$
3110 PRINT A$:A$="":GOTO 3010
4000 PRINT "M":B$(IZ):" = ":ZA$:GOSUB 5000:RETURN
5000 POKERAA,19:POKERAB,13:POKERAC,145:POKERAD,145:POKERE,147:POKEAF,67
5010 POKERAG,79:POKERAH,78:POKERAI,84:POKERAJ,13:POKERAK,10:STOP:POKEAK,0
5020 PRINT "T":RETURN
7000 PRINT TAB(8)"PROGRAMME FOR EVALUATING":TZ=800
7010 PRINT "M":TAB(9)"ALGEBRAIC EXPRESSIONS":PRINT TAB(3)"-".ILNES="TAB(25)"-6
UNE 1980-
7020 PRINT TAB(13)"
7030 GOSUB 8000
7040 PRINT "M":INSTRUCTIONS ? ":GOSUB 3000:R$=LEFT$(ZA$,1)
7050 IFR$="N" THEN RETURN
7060 IFR$="Y" THEN 7080
7070 PRINT "T":TAB(15+LEN(ZA$)):FOR I=1 TO LEN(ZA$):PRINT CHR$(20):NEXT:PRINT "T":
GOTO 7040
7080 PRINT "M":THE PROGRAMME IN MEMORY WILL:M:PRINT EVALUATE :
7090 PRINT "M":ANY ALGEBRAIC EXPRESSION:PRINT M ENTERED INTO THE "T":
7100 PRINT "M":THE ONLY RESTRICTION IS SINGLE:PRINT "M": CHARACTER VARIABLES
7110 PRINT "M":TAB(10)"A1" IS ACCEPTABLE:PRINT "M":TAB(10)"A1" IS NOT ACCEPTABLE
7120 PRINT "M":TAB(10)"B1" IS NOT ACCEPTABLE
7130 PRINT "M": OTHERWISE THE NORMAL "T":PRINT SYNTAX APPLIES.
7140 TZ=7500:GOSUB 8000:PRINT "T":
7150 PRINT "M":THE "T" WILL PROMPT FOR AN:PRINT "M":ALGEBRAIC EXPRESSION AS
7160 PRINT "M": X = <BLINKING CURSOR>:TZ=3900:GOSUB 8000
7170 PRINT "M":DU TYPE IN ON ONE LINE (NO SPACES)
7180 PRINT "M":THE EXPRESSION YOU WANT TO EVALUATE.
7190 PRINT "M":TERMINATING WITH 'RETURN' - EG:M:PRINT TAB(10)"X = A12*SIN(B)/C+D
7200 TZ=5000:GOSUB 8000:PRINT "M":THE "T" WILL THEN PROMPT FOR THE VALUES
7210 PRINT "M":OF THE VARIABLES IN THE EXPRESSION:PRINT "M":IN THIS CASE 'A'/'B'/'C'
& 'D'.
7220 TZ=6000:GOSUB 8000:PRINT "T":
7230 PRINT "M":INITIALLY THE "T" WILL PRINT TO:PRINT "M":SCREEN THE EXPRESSION, VAL
UE OF
7240 PRINT "M":THE VARIABLES AND THE NUMERIC VALUE:M:PRINT "M":OF THE EXPRESSION ";
7250 PRINT "M":USING THESE VALUES.
7260 PRINT "M": TO CONTINUE WITH PROGRAMME:PRINT:PRINT TAB(15)"PRESS _T_
7270 GETA$:IFA$="" THEN 7270
7280 RETURN
8000 FOR IZ=1 TO TZ:NEXT:IF FL=3 THEN PRINT "T"
8010 RETURN
9000 DATA SIN,COS,ATN,INT,SQR,ABS,EXP,LOG,TAN

```

## UK 101 Gunfight

by John Popplewell

A two-player game with good graphics REM statements are left out, which will run in under 4k provided the

```

1 DIM M(23),MR(24)
2 FOR I=54670565:READ X:POKE Z,X:NEXT:POKE 11,34:POKE 12,2
4 DATA 169,32,160,255,153,0,208,153,0,209,153
5 DATA 0,210,153,0,211,136,208,241,76
6 REM ABOVE DATA IS FOR M.C. CLEAR SCREEN
7 X=USR(X):GOSUB 6090
8 SR=0:SL=0:A$="ARRGH!":HL=0:HR=0
10 X=USR(X):SF=0
11 POKE 53265,SL+48:POKE 53302,SR+48
13 FL=0:FR=0:PL=538:PR=538
20 POKE 530,1:KE=57088:POKE 54221,32
22 FOR Z=0 TO 960 STEP 64:REM DRAW BOARDERS
23 POKE 53257+Z,140:POKE 53309+Z,140:NEXT
24 REM DRAW CAULT
25 POKE 53399,203:POKE 53400,218:POKE 53464,216:POKE 53465,206
26 POKE 53860,203:POKE 53861,218:POKE 53925,216
27 POKE 53926,206
29 REM LEFT AND RIGHT GUN CHARACTERS
29 L(0)=195:L(1)=132:L(2)=198:L(3)=132
30 R(0)=197:R(1)=132:R(2)=196:R(3)=132
31 REM PLAYER MOVEMENT DISPLACEMENTS
32 ML(12)=-64:ML(19)=64:ML(22)=-1:ML(23)=1
34 MR(19)=-64:MR(22)=64:MR(23)=-1:MR(24)=1
44 REM CONSTANTS,ASSIGNED VARIABLES FOR SPEED
45 B1=64:B2=1:B3=63:B4=65:B5=128:A7=32
49 REM WRITE (PL)
50 POKE PL,161:POKE PL-B1,226:POKE PL-B2,195:POKE PL+B2,197:POKE PL+B3,143
55 POKE PL+B4,136:POKE PL+B1,A7:POKE PL-B5,143:POKE PL-B3,143
56 POKE PL-B4,145
60 REM WRITE (PR)
61 IFSF=1 THEN 88
62 POKE PR,161:POKE PR-B2,195:POKE PR+B2,197:POKE PR-B1,226:POKE PR+B3,143
63 POKE PR+B4,136:POKE PR+B1,A7:POKE PR-B5,158:POKE PR-B3,145

```

# MICROMART

## EPROM ERASER



- CLEARS UP TO 32 CHIPS IN 30 MINS ON 200-250V A.C.
- CONTINUOUS 253.7m BEAM, SAFE & SIMPLE, GUARANTEED
- £39 C.W.O. £40 NETT 30 DAYS: ALL INCLUSIVE!

TRADE ENQUIRIES INVITED FOR SUBSTANTIAL DISCOUNTS

ALL ORDERS AND ENQUIRIES TO:

**TEX MICROSYSTEMS LTD.**

ST. ALBANS 84077 / TRING 4797

50 HZ  
SUPER BOARD  
NOW FROM ONLY

**£159.95**

Plus P&P & VAT

Includes 8K BASIC, 4K RAM  
KEYBOARD etc  
FITTED MODULATOR EXTRA

CTS 1 Higher Calderbrook,  
Littleborough, Lancs, OL15 9NL  
Tel: Littleborough (0706) 79332  
anytime

Which Way?

• If you're lost in the Micro Maze and don't know which way to turn... turn to us

• For impartial advice from an independent consultant... consult us.

• For bespoke software designed to meet your needs... you need us.



37 Purbrook Gardens  
Purbrook, Portsmouth  
(Waterlooville 53775)

## µHex EPROM PROGRAMMERS

426 2508/2708/2758/2516/2716  
Dual and Single supply Eproms, £95

416 2704/2708/2716 Dual only, £65

480 2704/2708 Kit £35. Built £40.

All programmers require only standard power supplies.  
The 426 & 416 are cased and have push-button selection.  
Program any length block into the Eprom.  
Software included. Range covers Z80, 8080, 6800 and 6500. State machine.

**PIO, PIA INTERFACE MODULES**  
Available for Z80/8080 and 6800/6500.

Prices include carriage. Please add VAT  
SAE for further product information.

**MICROHEX COMPUTERS**  
UNION STREET, TROWBRIDGE, WILTS.



# PROGRAMS

```

9000 PRINT"FIRE"TAB(9)"/E"/TAB(30)"/P"/
9010 PRINT:INPUT"ARE YOU READY";A$
9020 IFLEFT$(A$,1)()="N"THENRETURN
9030 GO"08010

```

## UK 101 Graphics Development

by Mark A Fernandes

This program enables you to build, Very useful at the design stage of a modify and interpret a screen layout. program.

```

5 POKE11,0:POKE12,253
7 PRINT"DO YOU KNOW HOW TO USE THIS PROGRAM":X=USR(X)
8 IFPEEK(531)=78THEN280
10 INPUT"GRID DIMENSIONS(ROWS X COLUMNS)";R,C
20 IFR>90 OR C>90THEN10
30 DIMA(R,C)
35 FORX=1TOR:FORY=1TOC:A(X,Y)=32:NEXTY,X
36 PRINT
37 PRINT"1=WHOLE GRID INPUT MODE"
40 PRINT"2=SELECTIVE CO-ORD MODE"
45 PRINT"3=DISPLAY GRID"
47 PRINT"4=DISPLAY CODES IN GRID"
50 PRINT"5=CLEAR GRID"
53 PRINT"6=END PROGRAM"
55 PRINT"7=DISPLAY CHARACTER OF CODE INPUTED"
60 X=USR(X):U=PEEK(531)-48:IFU<1THEN60
70 ONU GOTO90,140,180,230,35,270
80 INPUT"GRAPHIC CODE";X:PRINTCHR$(X):GOTO37
90 FORX=1TOR
100 FORY=1TOC
110 PRINT"SQUARE ";X;Y;" OLD CONTENTS = ";A(X,Y)
120 INPUT"NEW CODE";A(X,Y)
130 NEXTY,X:GOTO37
140 INPUT"SQUARE CO-ORDS";X,Y
150 IFX<0ORX>RORY<0ORY>CTHENPRINT"INCORRECT, RE-ENTER!":GOTO140
160 PRINT"SQUARE ";X;Y;" OLD CONTENTS = ";A(X,Y)
170 INPUT"NEW CODE";A(X,Y):GOTO37
180 FORX=1TOR
190 FORY=1TOC
200 PRINTCHR$(A(X,Y));
210 NEXTY:PRINT:NEXTX
220 X=USR(X):GOTO37
230 FORX=1TOR
240 FORY=1TOC
250 PRINTX,Y;" = ";A(X,Y)
260 FORZ=1TO10000:NEXTZ,Y,X:GOTO37
270 END
280 PRINT"THE GRID DIMENSIONS CAN BE AS LARGE AS YOUR"
285 PRINT"VDU,IF YOU USE LESS YOU MAY NUMBER THE SQUARES"
290 PRINT"BY INSERTING THE CODES FOR NUMBERS (OR LETTERS)"
295 PRINT"INTO THE n+1 SQUARES WHERE n IS ONE GRID"
300 PRINT"DIMENSION,"
305 PRINT"'1' ENABLES YOU TO FILL UP THE GRID IN"
310 PRINT"NUMERICAL ORDER, '2' LETS YOU INPUT OR"
315 PRINT"CORRECT A PARTICULAR SQUARE, '3' DISPLAYS"
320 PRINT"THE PRESENT GRAPHICAL GRID CONTENTS, '4'"
325 PRINT"ENABLES YOU TO NOTE DOWN THE CODES FOR THE"
330 PRINT"PRESENT PICTURE, '5' RESETS THE GRID FOR"
340 PRINT"FRESH INPUT, '6' HALTS THE PROGRAM, '7'"
345 PRINT"ENABLES YOU TO KNOW WHAT GRAPHIC CODE"
350 PRINT"[X] IS, WHERE X IS A ASCII NO."
355 PRINT"PRESS ANY KEY TO START PROGRAM,":X=USR(X):GOTO10

```

## PET Fighter Pilot

by E G Kemplen

Full instructions are in the listing.

```

100 REM***FIGHTER PILOT***
110 GOSUB740
120 PRINT" "
130 T=TI:SC=0:S=0
140 FORI=1TO25:POKE32788+40*I,66:NEXT
150 FORI=1TO40:POKE33287+I,64:POKE32768+I,160:NEXT
160 C=33308
170 POKEC,87
180 A=32868
190 B1=PEEK(A-2):B2=PEEK(A-1):B3=PEEK(A):B4=PEEK(A+1):B5=PEEK(A+2):B6=PEEK(A-40)
)
200 REM *****CHECKS SCREEN*****
210 POKEA-2,70:POKEA-1,70:POKEA,90:POKEA+1,70:POKEA+2,70:POKEA-40,93
220 REM *****PUTS IN ENEMY PLANE*****
230 FORN=1TO50:NEXT
240 PRINT" FUEL";30-INT((TI-T)/60)/10;" ";TAB(17)"SCORE";SC:TAB(30)"SHOTS";S
250 PRINT" ";TAB(11);"GALS"
260 GET$:IFVAL(X$)C>0THEN410
270 REM*****CHECKS AIM*****
280 IFPEEK(516)=1THENB7=PEEK(C):POKEC,42:FORI=1TO10:NEXT:POKEC,B7:S=S+1
290 IFPEEK(516)=1ANDPEEK(C)C>87THENGOSUB520
300 IFS>249THENPRINT"OUT OF AMMUNITION RUN LIKE HELL FOR HOME":GOTO680
310 IF(TI-T)/60>300THENPRINT"YOU'RE OUT OF FUEL, BREAK OFF":GOTO680
320 REM*****CHECKS FOR FIRE*****
330 N=-41+INT(RND(1)*3)+INT(RND(1)*3)*40
340 REM*****ENEMY AVOIDING ACTION*****

```

# MICROMART

## UK 101 PROGRAMS ON CASSETTE:

*Startrek, Moon Lander, Maze, Robot, Chase, Cheesboard, Space Invaders, Golf, Nim, Graphics, Life, Gunfight, Space War, Docking a Space Ship, Hexapawn, O's and X's, Dogfight\*, Tower of Brahma, Biorhythm, Mastermind\*, Hangman, Fourier Series, Calculation of Pi\* (to 1024 places), Simultaneous Equation Solution, Best Fit Polynomial, Assembler\**

(\*These are partly or wholly in machine code).

Any 12 for only £6.00

All 25 for only £10.00

Send to: Mr M. Ward, 9 St Andrews Ave., Crewe, Cheshire, CW2 6JJ.

## CHEAP PETS

32K ..... £540.00

8K ..... £350.00

DISK DRIVE ..... £540.00

TRACTOR

PRINTER ..... £325.00

TEL: 09277 - 65056 (Herts)

## UK 101 GAMES

**SUPERTREK** 8K - In REAL time  
- great graphics  
starship recoils on  
firing. See the galaxy  
move about you. £5.

**DRAUGHTS** 8K - £4  
**OTHELLO** 4K - £3

**FAST ENTRY** Single key BASIC  
command entry  
machine code - £4

AVAILABLE ON CASSETTE  
EXPORT ORDERS £1 EXTRA.

DR J B SIMPSON,  
18 SOUTHDEAN DRIVE,  
HEMLINGTON,  
MIDDLESBROUGH, CLEVELAND

## 6250 BAUD for NASCOM 1

This ultra-fast cassette interface board will provide reliable data storage and recall at up to 6250 BAUD on most standard cassette recorders.

e.g. 1K of data loaded in less than 1½ seconds.

The modifications required are minor and full documentation is supplied with each board which comes built, tested and guaranteed.

For immediate delivery send £15.95 + 35p

P&P to:-

J. C Hunter  
65 Portland Street, TROON  
Ayrshire, Scotland  
or phone 0292 311513

Also a competitively priced EPROM programming service is provided where we can supply the EPROM's programmed to your listings or programme your own EPROM's on a 24 hour turn round basis. Please write or telephone for details.

## MICROTYPE



READY CUT CASE FOR SUPERBOARD,  
UK 101, NASCOM 2,  
(ALSO AVAILABLE WITH BLANK KEYBOARD  
FOR HOMEBREW, NASCOM 1, ETC.)

PRODUCED IN BLACK ABS PLASTIC, COMPLETE WITH SCREWS AND INSTRUCTIONS.  
SPACE FOR EXPANSION, FORCE FEED FAN, NUMERIC PAD AND ADDITIONAL KEYS.  
ONLY £24.50 + £1.50 P&P + VAT.  
SEND CHEQUES OR P.O.'S FOR £29.90 TO:  
MICROTYPE, P.O. BOX 104, HEMEL HEMPSTEAD, HERTS. HP2 7JZ  
SAE FOR DETAILS. DEALER & OEM ENQUIRIES WELCOME.

## CHECKERS/DRAUGHTS

8K Program for the PET on cassette. Written by a County Player and member of both the English and American National Associations. 6 levels of Play (Beginner to Expert). Plays to the standard rules of the E.D.A. including 'must take'.

Large clear graphics. Instructions and hints for playing included.

Only £9 including P and P

N. S. FLANN  
19 Bounds Oak Way, Tunbridge, Wells,  
Kent, TN4 0TX.

## TOPMARK Computers

dedicated to  
**APPLE II**



Simply the best!

Full details from Tom Piercy on  
Huntingdon (0480) 212563

## APPLE & ITT 2020 BUSINESS SOFTWARE

Professionally written packages now available with comprehensive manuals, built-in validity checks, interactive enquiry facilities, user options, satisfying accountancy, Inland Revenue and Customs & Excise requirements. On diskette under DOS 3.2 in Applesoft with SPACE utility. Not adaptations. Written for Apple System. Support all printer interfaces. Sales, Purchases and General Ledgers £295-00 each. Manual only £3. Payroll £375. Manual only £4. General Ledger supports Incomplete Records, Jobs Costing, Branch and Consolidated Accounts, etc. General Ledger Applications Manual £10. Prices exclusive of V.A.T. From our shop or your nearest stockist.

COMPUTECH SYSTEMS  
168, Finchley Road, London NW3,  
Tel: 01-794 0202

## MINE OF INFORMATION LTD

1 FRANCIS AVENUE,  
ST ALBANS AL3 6BL  
ENGLAND

Phone: 0727 52801  
Telex: 925 859

**MICROCOMPUTER  
CONSULTANCY &  
BOOK SELLERS**

## PROGRAMS

```

350 POKEA=2, B1:POKEA-1, B2:POKEA, B3:POKEA+1, B4:POKEA+2, B5:POKEA-40, B6
360 A=A+N*AIM
370 IFAC32811THENA=A+80
380 IFAC33724THENA=A-80
390 REM*CALCULATES NEW ENEMY POSITION*
400 GOTO190
410 IFVAL(X$)=1THENAIM=-39
420 IFVAL(X$)=2THENAIM=-40
430 IFVAL(X$)=3THENAIM=-41
440 IFVAL(X$)=4THENAIM=1
450 IFVAL(X$)=5THENAIM=0
460 IFVAL(X$)=6THENAIM=-1
470 IFVAL(X$)=7THENAIM=41
480 IFVAL(X$)=8THENAIM=40
490 IFVAL(X$)=9THENAIM=39
500 GOTO390
510 REM***AIM CORRECTION****
520 IFPEEK(C)=70ORPEEK(C)=93THENII=2
530 IFPEEK(C)=90THENII=5
540 SC=SC+II
550 FORI=1TOII
560 POKEC-39, 42:POKEC-41, 42:POKEC+41, 42:POKEC+39, 42
570 IFSC>49THEN640
580 FORJ=1TO25:NEXT
590 POKEC-39, 32:POKEC-41, 32:POKEC+41, 32:POKEC+39, 32
600 FORJ=1TO10:NEXT
610 NEXT
620 RETURN
630 REM***HIT SUBROUTINE****
640 TI=INT((TI-T)/60)
650 PRINT"MI";TAB(17)"SCORE":SC
660 PRINT"ENEMY PLANE DESTROYED IN":TI:"SECONDS"
670 PRINT"USING":S:"ROUNDS OF AMMUNITION"
680 PRINT"TO PLAY AGAIN PRESS A SPACE"
690 PRINT"TO STOP PRESS A 0"
700 GETY$:IFY$="0"THENSTOP
710 IFY$=" "THENI20
720 GOTO700
730 REM***FINAL DISPLAY***
740 PRINT"MI";TAB(7)"
750 PRINTTAB(7)"
760 PRINTTAB(7)"
770 PRINT:PRINT
780 PRINTTAB(11)"
790 PRINTTAB(11)"
800 PRINTTAB(11)"
810 PRINT:PRINT
820 XX$="YOU ARE THE PILOT OF A SPITFIRE":GOSUB1110
830 XX$="AHEAD OF YOU IS AN M.E.109":GOSUB1110
840 XX$="HE IS TAKING AVOIDING ACTION, AND YOU":GOSUB1110
850 XX$="MUST TRY TO SHOOT HIM DOWN":GOSUB1110
860 XX$="YOUR GUNS ARE FIRED BY PRESSING THE":GOSUB1110
870 XX$=" A SHIFT KEY":GOSUB1110
880 PRINT:XX$="YOU CAN CHANGE YOUR AIM USING THE":GOSUB1110
890 XX$="NUMERIC KEYPAD AS FOLLOWS":GOSUB1110
900 PRINT:PRINT:XX$=" PRESS A SPACE TO CONTINUE":GOSUB1110
910 GETY$:IFY$=" "THEN930
920 GOTO910
930 PRINT"MI":XX$="THE TOP ROW OF NUMBERS MAKE YOUR PLANE":GOSUB1110
940 XX$="CLIMB":GOSUB1110
950 XX$="THE BOTTOM ROW MAKE YOUR PLANE DIVE":GOSUB1110
960 XX$="THE LEFT ROW TURN YOU TO THE LEFT":GOSUB1110
970 XX$="THE RIGHT ROW TO THE RIGHT":GOSUB1110
980 XX$=" THE A 5 KEY CENTRALISES YOUR CONTROLS":GOSUB1110
990 PRINT:XX$="7 8 9":GOSUB1110
1000 PRINT:XX$="4 5 6":GOSUB1110
1010 PRINT:XX$="1 2 3":GOSUB1110
1020 PRINT:XX$="YOU CANNOT ALTER COURSE WHILST FIRING":GOSUB1110
1030 XX$="YOUR GUNS":GOSUB1110
1040 PRINT:XX$="THE OBJECT OF THE GAME IS TO SCORE":GOSUB1110
1050 XX$="50 POINTS":GOSUB1110
1060 PRINT:XX$="A HIT ON THE WING OR TAIL SCORES 2":GOSUB1110
1070 XX$="A FUSELAGE HIT SCORES 5":GOSUB1110
1080 PRINT:XX$=" PRESS A SPACE TO START THE GAME":GOSUB1110
1090 GETY$:IFY$=" "THENRETURN
1100 GOTO1090
1110 PRINTTAB((40-LEN(XX$))/2);XX$:RETURN

```

## Apple plotting

by J J Clessa

Here's a relatively simple routine which enables you to plot a variety of mathematical functions using the Apple II.

The function should be input in polar form but don't worry if you don't know what that means — you'll soon get the hang of it by trial and error. Enter the function in line 200 and set the size control parameter A in line 10. Increase A to make the graph bigger or decrease A to make it smaller.

By experimenting with different functions and different values of A, you'll be able to create a variety of interesting curves. You might like to try these for starters:

R = A\*(1-COS(T)) (A=50)  
R = SQR(A\*A\*COS(2\*T)) (A=100)  
R = A (A=50)  
R = A/T (A=150)

R = A\*(1+2\*COS(T)) (A=25)  
R = A\*SQR(TAN(2\*T)) (A=50)  
R = A\*LOG(T) (A=20)

and for the romantic,  
R = A\*(COS(T-1.57) ^ 9-2) (A=25)  
while for something different try,  
R = A\*LOG(T/A)

(I've forgotten the A value for this last one so you'll have to experiment with it.)

The program calculates and plots the function of a range of T from 1° to 360°. A FOR...NEXT loop isn't used because of the Apple's ONERR feature, which is necessary here for functions which produce negative square roots and the like.

I'd be pleased to hear of any interesting shapes you discover.

## PROGRAMS

```

● 1 ONERR GOTO 300
 10 A = 25
● 100 X9 = 135:X1 = - X9:Y9 = 75:Y1 = - Y9
● 110 T1 = 1 / 3.1415926:T9 = 360 * T1:T0 = T1
● 120 HGR : HOME : HCOLOR= 3: VTAB (24): LIST 200
● 130 HPLLOT X9,1 TO X9,2 * Y9: HPLLOT 1,Y9 TO 2 * X9,Y9
 190 T = T1
● 200 R = A * LOG (T / A)
● 210 X = INT (R * COS (T)):Y = INT (R * SIN (T))
 220 IF X < X1 THEN 270
● 230 IF X > X9 THEN 270
● 240 IF Y < Y1 THEN 270
● 250 IF Y > Y9 THEN 270
● 260 HPLLOT X + X9,Y + Y9
 270 T = T + T0
● 280 IF T < = T9 THEN 200
● 290 STOP
 300 E1 = PEEK (222)
● 310 E2 = PEEK (218) + PEEK (219) * 256
● 320 T = T + T0
 325 IF E1 < > 53 THEN 340
● 330 RESUME
● 340 PRINT "ERROR CODE ";E1;" AT LINE ";E2
● 350 STOP

```

## LEISURE LINES

by J J Clessa

Puzzle 11 must have been fairly easy — I received over 100 correct entries, although one or two people couldn't get it right. There was even a card from a regular Scottish reader, who normally sends abuse, saying that he needed eight months to solve the puzzle due to the slowness of both his computer and his algorithm. There was a particularly good entry from the MacSwapping family in Yorkshire — obviously the problem held some magnetic attraction for them. Anyway, the two required numbers are 4761 and 328509.

The winning entry, selected at random, was from C C Sharp of Leighton Buzzard. Congratulations, Mr (Mrs?) Sharp, 20 plugs are on their (eventual) way to you.

### Quickie

As usual, no answers, no prizes for this: Jack's famous beanstalk doubled its height every day. After 21 days it was as high as the Town Hall; after how many days was it half the height of the Town Hall?

### Prize puzzle

The other day, while trying to phone the PCW offices, I got a crossed line and found myself listening to the following conversation between two people whom

I'll call A and B. But unfortunately the line was a bit crackly so I missed parts of what was said.

A: "I've just spent exactly £2 on a mixture of 12p, 14p and 17p stamps."

B: "How many of each did you buy?"

A: "I'll not tell you that but I will tell you that altogether there were (CRACKLE) stamps."

B: "In that case I'll work it out . . . wait a minute, I still can't tell how many of each you got. Did you buy only one of one kind?"

A: "(CRACKLE)"

B: "In that case you bought . . ."

At that point the line went dead. Unfortunately at the two key points, a crackle on the line prevented me from hearing the full conversation but I'm sure you'll all be able to tell me, without any more information, just how many stamps of each value were bought.

Answers on a postcard please to Puzzle No 14, PCW, 14 Rathbone Place, London W1P 1DE, to arrive by 31 October.

### Prize of the month

Boring, I'm afraid, but from now on I'm giving away a book token each month.

## BLUDNERS

Just as we were patting ourselves on the back for a comparatively Bludner-free August issue, the September PCW arrived. In case you hadn't noticed, the last pages of the two Benchtests were somehow transposed — page 53 belongs

to the SuperPET review and page 87 is all about the BASF.

And we accidentally omitted a credit for the PET Demolition program — it was written by Peter Wright.

## MICROMART



### MICRO MAFIA?

An unnamed gentleman on the telephone has threatened to get our supplies cut off if we continue to sell our genuine

### PROGRAMMERS TOOLKITS FOR PET

below the 'official' price of £55 + VAT. So best buy now, before our supplier makes us a refusal we can't offer!

16/32K ROM ONLY  
£40 + VAT

MICROCASE "turns a board into a real computer"

NASCOM 1 & 2

COMPUKIT

SUPERBOARD

UNCUT FOR OEM USE

Direct from us or from your dealer — but make sure you see a GENUINE MICROCASE!

About £30

SIMPLE SOFTWARE LTD  
15 HAVELOCK ROAD  
BRIGHTON SUSSEX



### NEW MICROSHOP NOW OPEN

#### COMMODORE PET

Superpet, Printers, Wordpro, Compu-think, Mupet, Petsoft.

#### TRS80

Models I and II Harding + Tridata Software.

#### APPLE

See VISICALC and CASHIER demonstrated.

COMPUTER SUPPLIES  
82 GOWER RD, SKETTY  
TEL: SWANSEA 290047

## SALE Surplus to Industrial Distributor's requirements

CASH WITH ORDER - FIRST COME, FIRST SERVED.

Systems Equipment  
INTEL INTELEC 4/40 (New) £450  
CDB150 Cassette Interface Controllers (New) £30  
Shuggart Disk Drive SA400 (New) £100  
115V (230V) Teletype 33 (Reconditioned) £150

Components  
¼ watt Carbon Film Resistors £2.40  
various values per thousand  
0.33MF Polyester Caps (Siemens) £3.00  
per hundred

Contact Mrs. R. Stephens on Sunbury 89241.  
Cramer Components.

# MICROMART

## BIAS POWER SUPPLIES FOR SYSTEM EXPANSION TO 64K

**BIAS 1** for general micro use  
+5 @ 10 amps ±12v @ 2 amps  
-5 @ 1 amp **KIT £42.50**

**BIAS 3** for S100 systems  
+8v @ 10amps  
±18v @ 3.5amps **KIT £40.20**

**Over Voltage Protection**  
- optional B1 - £12;

**HEAVY ALLOY CASE**  
150 x 150 x 200  
includes switches, connectors,  
predrilled **£12**

**Assembled & Guaranteed add £15**

**Specialists in Multirail Supplies**

Mail order to:

## ONUSTECH ENG LTD

474 CHISWICK HIGH RD  
LONDON W4  
01-995 0160

p&p £3.50

Prices excluding VAT.

## APPLE & ITT SOFTWARE

Over 100 titles in our  
free catalogue.

Including:-

**Auto-Index (Sophisticated  
Master Catalog Data-Base  
Utility)** 17.95

**FS1 Flight Simulator**  
( Simulates Sopwith Camel  
3-D Hi-Res view from the  
cockpit. Most incredible  
graphics. ) 17.95

## SPIDER SOFTWARE

98 Avondale Road  
Croydon  
Surrey Tel. 01-680 0267

Write or telephone for  
our free catalogue.

## SOFTWARE FOR THE NEW ROM PETS

Send for free list of games and utilities.  
MYCROFT specialises in fast efficient  
machine-code programs at sensible prices eg.

### TRACE

Displays the BASIC line being executed along with  
the values of any variables or expressions you  
select, in three lines of reverse video anywhere on  
screen. One line a second or single step. **£4.50**

### COLONY 2

Now you can play Conway's absorbing game of  
Life on four times the playing area previously  
available. Use of double density graphics allows  
colonies up to 78 x 48, processing at over two  
generations a second. **£5.50**

### COMMAND KEY

Our most popular program. A 300 byte routine  
that gives auto-repeating keys and adds a command  
level shift to PET for single key entry of 62 BASIC  
words. A template is provided. **£3.50**

### RENUMBER

You can select the start number, the step size and  
where renumbering is to begin. It handles ALL  
references, including those to non-existent lines  
and occupies only 750 bytes. **£5.00**

Prices inclusive. Mail order only. Supplied on  
quality cassettes.

### MYCROFT

262 Francis Chichester Way, London SW11 5HY

# MICROMART

## ZX80 SPECIALS

### GRAPHICS:

Poke directly to memory mapped screen  
- example sketching program. **£1.00**

### MUSIC:

Tunes to your tape recorder - just like  
saving p. grams, no hardware modifica-  
tion whatsoever. **£1.00**

### ACTIVE DISPLAY:

Now you can write those games or use  
the ZX80 for 'hands off' continuous  
data monitoring. This routine lets you  
decide how long a display will hold  
before your program continues (1/50  
sec - approx. 10 mins). A Hexadecimal  
loader is included. **£5.00**

### HEX:

Loader/Display for machine code program-  
ming. **£1.00.**

Inclusive prices for example program list-  
ing and explanatory details. (Only 1K  
memory required)

K. Macdonald, 26 Spiers Close, Knowle,  
Soliuhull B93 9ES.

## GAMES FOR THE

### SUPERBOARD II

#### SPACE INVADERS

A more advanced version of the popular  
arcade game, with 8 levels of skill, and  
invisible invaders. 8K, only **£5.00**

#### GUN TURRET

Get the aliens before they get you. A  
very fast moving game. 4K. **£3.00**

#### BREAKOUT

A very addictive ball game, 12 levels  
of difficulty and 4 demonstration models.  
4K. **£4.00**

#### AIR ATTACK

Destroy the buildings to allow your plane  
to land. 4K. **£3.00**

C. J. Marshall, 8 St Vincent Drive,  
St Albans, Herts

All prices include p&p

## DEMACAN LIMITED

THE SOURCE FOR YOUR APPLE  
PLUS/ITT EXPANSION MEMORY

ONLY £45 per 16K

*Kit includes all new guaranteed ICS  
with full installation guide and K inser-  
tion tool.*

Two kits (32K) for **£80**

SSM AIO serial + parallel Apple/ITT  
Interface card only **£99**

Pet Machine language guide. Basic entry  
points etc. etc. for old + new pets **£6.75**

*Prices include P&P but exclude VAT.*

*Send cheque/PO to:  
Demacan Ltd., 2 West Priory Close,  
Westbury-on-Trym, Bristol B59 4DD.  
Tel: 0272 621920*

## Dola software

117 BLENHEIM ROAD, DEAL, KENT

Basic and machine code programs for UK101/  
Superboard, Acorn and RML 380Z.

Our library includes:-

### UK101/Superboard

1. Subroutine library for screen formatting
2. Full screen digital clock - with alarm. 1 sec/day
3. Auto line number
4. High Resolution Function plotting.
5. Simple interface to drive NASCOM printer

### Acorn

1. Digital frequency meter. Auto ranging between  
pulses/sec and secs/pulse
2. Baudot code teleprinter interface
3. Morse code
4. Monitor commentary

### 380Z

1. Single step in Basic, with automatic listing of  
variables at end of each line
2. Fast plotting (no loss of picture) and dynamic  
graphics
3. Get key while Basic is running
4. Battleships, and other games
5. All machine code subroutines loaded from Basic
6. General purpose subroutines

Send S.A.E. for full description of these, and many  
other, programs.

# MICROMART

To advertise in  
**MICROMART**  
Please ring **Jacque Hancock**  
on **01-631 1682**

*Would You Like To  
GAMBLE WITHOUT LOSS -  
DRAW - IMPROVE YOUR  
FINANCES - PIT YOUR WITS -  
DEFEND YOURSELF AGAINST  
ATTACK*

*all from your own armchair?*

*Of course you would!*

*All these things are possible with  
our current range of  
UK 101 SOFTWARE ON TAPE  
(£3.00 each or £2.50 each for two or  
more)*

1. Fruit Machine - 4K
  2. Drawing Machine - 4K
  3. Home Finance - 8K
  4. Snakes and Ladders - 4K
  5. The My-mY Game - 4K
  6. Alien Invaders - 4K
  7. Asteroid Runner - 8K
- And our latest game Space Defender  
- 5K \*Beware the Kamakaze Alien\**  
**SPECIAL OFFER All eight games  
only £17.50.**

*AND why not bring your programs  
to life with SOUND with our  
UK 101 PROGRAMMABLE SOUND  
GENERATOR (For only £9.50)*

*Using the superior sound chip the  
AY-3-8910, we supply the P.C.B.,  
list of parts, 15 page manual contain-  
ing hardware and software instruc-  
tions and software on tape.*

*All prices include P&P.  
Cheques or P.O.'s or S.A.E. for  
details to*

## MaricK

Dept 21, 1 Branksome Close,  
Paignton, S. Devon TQ3 1QE

# sinclair ZX80 SOFTWARE

Battleship  
NIM  
Simon  
Hurkle  
Lunar Land  
Water Bill  
Wordpuzzle  
Money Loan

Mastermind  
Dallas  
Hangman  
Bandit  
Maths Test  
Dice Throw  
Big Ben  
Tank

All the above programs are available for  
the 1K ZX80. Each program is supplied  
on its own C12 microprocessor cassette  
with full documentation and listing.  
£5.00 each, 3 for £12.00 or send £2.50  
for a sample program and catalogue.  
Cheques to:

CDS Micro Systems, 10 Estfield Close,  
Tickhill, Doncaster, DN11 9LA.  
Mail Order Only

## UK101 PROGRAMS

**Kelly's Heroes** - At last, the programme of the movie!  
Use grenades to reach the bullion.

**Hangman** - The old chesnut with some new graphic  
twists - large expandable vocabulary.

**Rear End Johnny** - Gun enemy aircraft out of the sky  
- dynamic action game.

**Breakout** - The arcade game, UK101-style. Can you  
knock out ALL the bricks?

**FREE WITH ALL ORDERS** - Extremely daft graphic  
programme. "Dogfish Derby". Will Ethel or Danny  
Dogfish win the race of the Decade?

Price £1 50 each, £5.00 for all four  
This price covers cassette, printed listing and P&P  
All programmes fit into 4K machines  
S.A.E. for further information

From Mark Leese Software  
56, Comeragh Road  
London W.14

**TRS-80 owners!!  
Double Disk Capacity  
with the Phantom  
Double-Density Module**

Provides double density modification to your current TRS-80 Expansion interface

Includes all hardware and software.

**£165**



**Load  
TRS-80 programmes  
& data  
Fast!  
with the Phantom  
Disk Drive system**

\*23% more storage capacity than TRS-80  
\*40 track patch at no Extra charge.  
Two drive system **£495**  
Four drive system **£935**  
Two drive cable **£20**  
Four drive cable **£30**



Single drive system

**£265**

**The only 16k complete  
computer  
for under £400**

Keyboard computer, power supply, UHF modulator and all cables to plug into your own TV set and cassette recorder and go!! 16K of user RAM for decent size programmes and data, sophisticated level II Microsoft BASIC. Complete with level I and level II programming manuals. What more could you ask?



**TRS-80  
£382**

Expansion interface **£199.09**  
4K level I computer **£251.30**

**Now!  
Numeric keypad included**

**This lot must be today's best buy!**



**Galaxy 2000  
by Compu/Think**

(.8 Megabyte Disks) **£2,950**  
(2.4 Megabyte Disks) **£3,960**

SPECIAL - GALAXY prices include Compu/Think Pagemate Database and Report Writer at no charge

**The most advanced complete microcomputer system available.** Includes CPU, 12" CRT, full keyboard, 2 quad-density disk drives, 2 megahertz 6502 hybrid processor (double speed), 108 K system memory, high resolution (512 x 240) graphics, programmable character fonts, microsoft extended BASIC, DOS with random access I/O, full complement of I/O ports, monitor with debug, trace and tiny assembler, fifth (PL/M and fourth combination) interpreter, complete editing and entry with split screen capability, 64 microprogrammable opcodes, business software (with Database) available.



**2001-8N**  
(8K RAM New large keyboard)

**£425**

**NEW 80-Col.  
32k £825**

**Super-Pets are here!  
40 & 80 COLUMN**

Now you can  
- list unlistable programmes using the 6502 non-maskable interrupt facility! - just hit the new 'abort' button to jump out of programme into command mode  
- recover from crashes without switching off - just hit the new 'reset' button.  
- add sound to your programmes!  
The hardware is built-in - just write sounds into your programme using our simple directions.

**2001 - 16N (16K RAM and new large keyboard) £550**  
**2001 - 32N (32K RAM and new large keyboard) £690**  
External cassette deck, suitable for all Pets **£53**  
CBM dual drive mini floppy **£695**  
Tractor feed printer with Pet graphics **£395**  
Pet high-res. graphics 200 x 320 **£259**

**Get into print this easy way!**



EX-STOCK

**Anadex DP 800  
dot-matrix printer**

\*Speedy 112 ch/s bidir.  
\*Fits A4 page-up to 80 cols.  
\*Up to 4 copies. \*Precision form-filling with sprocket feed.  
\*Special headings using double-width chars. \*Modern paper format to match A4 filing systems. \*Other paper sizes with adj. sprocket.  
\*Full punctuation, U/L case, E sign, 96-ch. set.  
\*Reliable - strongly built. 100 M.ch. head.

**Knock down price!**

**£499**

Interfaces and cables -  
Pet **£45** Ohios **£30**  
TRS-80 **£40** Sorcerer **£25**  
Apple **£69**



**IBM golfball printer  
ideal for  
word-processing**

\*Forget expensive Spin-Wheel printers - the Golfball produces equal quality at up to 15 ch. per sec. \*Match various typewriter styles with IBM interchangeable heads.  
\*Completely reliable - each machine rebuilt by IBM trained engineers and fully guaranteed. \*Precision form-filling possible with 15 in. pin-feed platen.

Non-keyboard version

**£595**

Keyboard version **£695** (illus)  
Interfaces and cables -  
Pet **£45** Ohios **£63**  
TRS-80 **£35** Sorcerer **£25**  
Apple **£69**

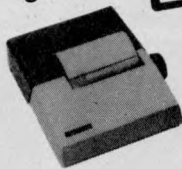

**Phantom 400/800  
Thermal Printer**

\*Stop disturbing others with noisy printout! \*Neat, clear, 96-ch. set, U/L case & symbols, in text mode.  
\*Fast, 48 ch/s bidir. \*Reliable - robust - only two driven parts.  
\*Plug in and go, built in PSU, detailed manual. Thermal paper in 80 ft rolls less expensive than electro-sensitive paper and now - dot hyphen addressable graphics too!!

For only **A snip!**

**£249** (40 col)

80 col model (800) **£359**  
Interfaces and cables -  
Pet **£45** Ohios **£63**  
TRS-80 **£40** Sorcerer **£25**  
Apple **£69**

**Up to 1.6Mb for PET!**

and 'on-line' with the Computhink Disc System

\*Allows powerful business programmes using 16 Extra BASIC commands. \*Easy to connect and use - plugs directly into 16/32K PETs, detailed manual supplied.  
\*Simple startup (no difficult procedures to remember) as Disc Op. System in ROM. \*Ready to run - useful programmes supplied free; full set of professionally written business packages available - Sales and Purchase Ledger, Stock Control, Payroll etc., \*Real-Time processing, Engineering and Commercial boundaries overcome with full language support - Business BASIC, Assembler, FORTRAN, COBOL, PASCAL, FORTH, FIFTH, PLM, PILOT & CESIL.

24K Memory expansion with dual disc for old ROM 8K PET **£275**  
for new ROM 8K PET **£320**



Basic 400K  
dual disc  
system

only **EX-STOCK**

**£840**

800K **£1,095**  
1.6 Mb **£2,190**

**You can afford to  
start computing now!**

Fully tested complete  
with 4K RAM.  
Extra 4K RAM **£35**

**£220**

\*Powerful programming possible - 6502 processor, fast 8K Microsoft floating-point BASIC (easy to learn). Superior utilities, 53 key key-board, giving upper and lower case, user-definable keys, gaming and graphics chs. Ultra-fast and powerful machine code from keyboard.

\*No intricate soldering or metal work. Computer supplied assembled in ready-made case. \*Reasonable sized programmes in 4K RAM. \*Expandable to 24K RAM in case, drives discs, printer, available items include Assembler/Editor and Extended Monitor. \*Programme interchangeability/reliability - Kansas City tape interface. \*Save programmes on own cassette recorder - all cables supplied.

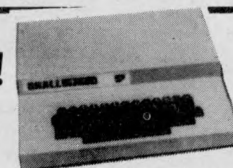

at a lower price  
than equivalent kits

**COMPUTERAMA LTD.**

your dealer for Bath, Bristol and S.W

**Tel: Bath (0225) 333232**

5 Cleveland Place East, London Road, Bath, BA1 5DJ.

Special terms available for educational and government establishments - dealer enquiries invited.

24 hr ordering service

Full after-sales  
service in our  
own workshops

One year guarantee  
on all new machines



Please  
add **£10**  
Securicor  
delivery on  
computers etc  
plus 15% VAT  
on all prices

# POWERFUL MICROS

## AT THE RIGHT PRICE

- Multi-User ● Multi-Tasking
- Multi-Language ● Hard Disc Storage ● Word Processing
- Priced from under £5000

Languages supported include – Basic, Cobol, Fortran.  
OEM, Educational and Dealer enquiries invited

### **EQUINOX**

COMPUTER SYSTEMS LIMITED  
Kleeman House, 16 Anning Street  
New Inn Yard, London EC2A 3HB  
Tel: 01-739 2387 & 01-729 4460

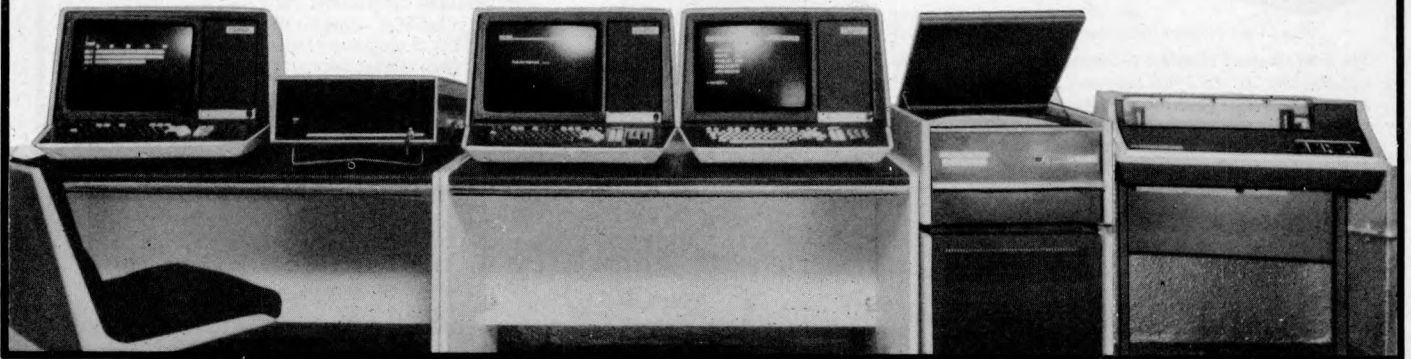

## *Trident*



£670.00



£2650.00

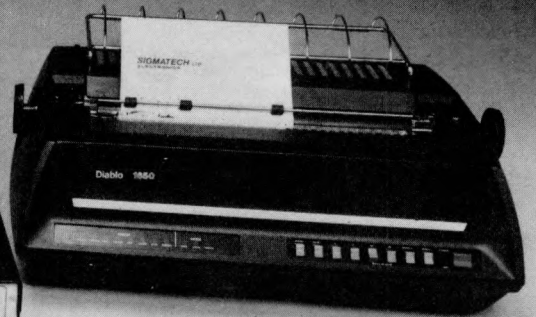

£2150.00

Configuration shown is for word processing including WORDSTAR £5450

- ★ Full Business Systems available
- ★ 64K 4MUZ Memory
- ★ Rack Mounting available
- ★ Interface to most VDUS and printers
- ★ Wide range of high level Languages available
- ★ Fastest CPM Machine
- ★ 6 slot S100 mother board
- ★ 2 or 4MBYTE Disc Storage

**SIGMATECH LTD.**  
ELECTRONICS

For further information:- Tel: (0734) 587000  
22, Portman Road, Battle Farm Estate, Reading, Berks.



# COMPUTER WAREHOUSE

**NOW OPEN**  
**MONDAY-SATURDAY**  
**9.30-5.30**

**SCOOP PRINTER PURCHASE**  
**PROFESSIONAL EQUIPMENT AT HOBBYIST PRICES**  
**SO LOW EVEN OUR COMPETITORS GASP!**

In stock now test equipment, microprocessors, teletypes, transformers, power supplies, scopes, sig. gen's, motors, peripheral equipment, I.C.'s, tools, components, variacs, keyboards, V.D.U.'s sub-assemblies + thousands of other stock lines. Just a mere fraction of our vast range, is displayed below. 100's of bargains for callers

## TELETYPE ASR33 I/O TERMINALS

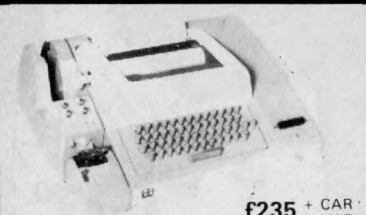

£235 + CAR + VAT

Fully fledged industry standard ASR33 data terminal. Many features including: ASCII keyboard and printer for data I/O, auto data detect circuitry, RS232 serial interface, 110 baud, 8 bit paper tape punch and ready for off line data preparation and ridiculously cheap and reliable data storage. Supplied in good condition and in working order. Options: Floor stand £12.50 + VAT  
Sound proof enclosure £25.00 + VAT

## ICL TERMIPRINTER 300 BAUD TERMINALS



£325 + CAR + VAT

Made under licence from the world famous GE Co. The ICL Termiprinter is a small attractive unit with so many features it is impossible to list them in the space available! Brief spec. as follows: RS232 serial interface, switchable baud rates 110, 150, 300, (30 cps), upper and lower case correspondence type face, standard paper, almost silent running, form feed, electronic tab settings, suited for word processor applications plus many more features. Supplied in good condition and in working order. Limited quantity.

## MAKE YOUR COMPUTER TALK!!!

### VIA OUR EX-GPO MODEM UNITS

Well, not exactly talk, but communicate over a standard dial-up G.P.O. line with any other modem. The modem unit 2A is housed in an attractive fibre glass case measuring only 15" w x 13" d x 5" h, inside are the electronics and mains power supply which enable serial duplex data communication between terminal/computer etc. at any speed up to and in excess of 250 baud (300 at a push). Made to the most stringent, exacting specification for the G.P.O. These units feature Modular plug in P.C.B.'s, internal test points, Standard tone frequencies, Configurable to terminal or computer end, Auto unattended answer, RS232/V24 interface on standard 25 way 'D' socket, etc. etc., supplied complete with diags., at a fraction of £55.00 + £4.50 their original cost at only £55.00 CARR.

NOTE: Units believed working, but untested, unguaranteed. Permission may be required for connection to G.P.O. lines.

## EX STOCK

# SOFTY

SOFTWARE DEVELOPMENT SYSTEM, INVALUABLE TOOL FOR DESIGNERS, HOBBYISTS ETC.

Enables "open heart surgery" on 2708, 2716, etc. Blows, Copies, Reads EPROMs or emulates EPROM/ROM IN-SITU whilst displaying contents off ROM/RAM on a domestic TV receiver. A host of other features.

Write or phone for more details.

£115 + VAT & CARR

You'll never regret buying a SOFTY!

## THE CHIPS ARE DOWN MOSTEK, INTEL, NEC, MOTOROLA I.C. PRICES SLASHED!

A massive purchase of brand new "state of the art" data processing equipment enables us to offer the following chips at never, and we mean never to be repeated prices.

|         |                                   |        |
|---------|-----------------------------------|--------|
| 8085A   | Central Processor                 | £11.99 |
| 8155C   | 256x8 Static Ram                  | £8.95  |
| 8253C   | Programmable Interval Timer       | £8.95  |
| 8255A   | Programmable Peripheral Interface | £9.95  |
| 8259A-8 | Programmable Interrupt Control    | £4.75  |
| 8755A   | 2Kx8 Eprom 16 1/0 Lines           | £34.50 |
| MC6850P | ACAI                              | £3.75  |
| 2652    | MPCC Comms. Controller            | £24.00 |
| 2102 1K | Static 650ns Rams 8 for           | £5.25  |
| 1702    | 256x8 Eprom                       | £3.75  |
| 5101L-1 | 256x4 Static Ram 450ns            | £4.95  |

And Remember All Chip Prices Include V.A.T.

All above I.C.s are brand new or removed from new unused socketed P.C.B.'s. Eproms supplied washed.

All full spec. and guaranteed

## SEMICONDUCTOR 'GRAB BAGS'

Amazing value mixed semiconductors, include transistors, digital, linear I.C.'s, triacs, diodes, bridge recs. etc. etc. All devices guaranteed brand new, full spec. with manufacturers markings, fully guaranteed. 50 + BAG £2.95 100 + BAGS £5.15

## MUFFIN FANS

Keep your equipment Cool and Reliable with our tested ex equipment "Muffin Fans" almost silent running and easily mounted. Available in two voltages. 110 V.A.C. £5.05 + pp 65p OR 240V A.C. £6.15 + pp 65p DIMENSIONS 4 1/2" x 4 1/2" x 1 1/2"

ELECTRONIC COMPONENTS & EQUIPMENT

**66%**  
DISCOUNT

Due to our massive bulk purchasing programme which enables us to bring you the best possible bargains, we have thousands of I.C.'s, Transistors, Relays, Cap's., P.C.B.'s, Sub-assemblies, Switches, etc. etc. surplus to our requirements. Because we don't have sufficient stocks of any one item to include in our ads., we are packing all these items into the "BARGAIN PARCEL OF A LIFETIME" Thousands of components at giveaway prices! Guaranteed to be worth at least 3 times what you pay plus we always include something from our ads. for unbeatable value!! Sold by weight

2.5kls £ 4.75 + pp £1.25 5kls £ 6.75 + pp £1.80

10kls £11.75 + pp £2.25 20 kls £19.99 + pp £4.75

## ★ SHUGART SA800 ★ 8" Floppy Disk Drives as new £225.00 + VAT

## ★ RAM AND EPROM STAR OFFERS ★

|                                |        |
|--------------------------------|--------|
| 2716 Single 5v rail EPROMS     | £10.25 |
| 2716 Three rail EPROMS         | £ 8.50 |
| 2708 EPROMS                    | £ 4.95 |
| 4116 16k x 1200 n s RAMS 8 for | £28.50 |

## 32K x 8 DYNAMIC/STATIC RAM CARDS

A masterpiece of electronic engineering and our own advantageous buying enables us to bring you a complete memory system at a giveaway price. Originally made for a large processor the RAM card has many features, including on board refresh, internal parity generation and checking. Standard TTL inputs/outputs, +5, +12, -15v supply rails and its effective STATIC capability make it useable with many CPU's. A fast cycle time of approximately 400ns make this a snip at only £90.00 + £3p & p. Supplied complete with circuits.

## DISPLAY I.C. AND TRANSISTOR BARGAINS, NEVER CHEAPER

All I.C.'s and Transistors by well known manufacturers and fully guaranteed. No fall outs. Comprehensive data on I.C.'s 15p per type.

2N4351 N channel MOS FET.

2N4352 P channel MOS FET.

60p each £1.00 per pair.

HIGH VOLTAGE NPN POWER SWITCHING transistors BVcbo 600v

BVceo 500v BVebo 15v Ic 5 amps

Pc 125 watts HFE 60 typ ft 2.5 mhz

ideal invertors, etc. T03 £1.60 each 4 for £5.40.

BF258 NPN 250v @ 200ma 45p each 3 for £1.08.

I.R. BSB01 2.5 amp 100v bridge rec.

P.C. mount long leads 35p each 4 for £1.08.

IN4998 4 amp 100v P.C. mount diodes

long leads 14p each 10 for £1.10.

LM309K + 5v 1.2 amp regulator £1.10

each 6 for £5.35.

AGFAC10 computer grade cassettes complete with library cases 68p each, 10 for £5.50

IN4004 SD4 1 amp 400v diodes 7p

each 18 for £1.00.

I.R. 12 amp BRIDGE RECS. 400 volt

£1.25 each.

## POWER DARLINGTON SCOPPI!

MJ1000 NPN 60v 90w 8 amps T03 95p each

2N6385 NPN 80v 100w 10 amps T03 £1.25 each

MJ4030 NPN 60v 150w 16 amps T03 £2.25 each

## S.C.R.'s

2N3001 30v 350 ma T018 22p each 6 for £1.00

2N5061 60v 800ma T018 27p each 4 for £1.00

2N4441 50v 8 amps T0220 45p each 10 for £4.00

1C06D1 400v 5 amps T0202 55p each 10 for £5.00

## TRIACS

G.E. 12 amp 600v T0220AB 95p each 10 for £8.75

A.E.I. 10 amp 400v ready mounted on 2 1/2" x 2 1/2" heatsink £1.00 each 4 for £3.75

## LOW PROFILE I.C. SOCKETS

8 D.I.L. 10p each 12 for £1.00

14 D.I.L. 14p each 8 for £1.00

16 D.I.L. Gold Plated mil. grade 22p each 6 for £1.00

22 D.I.L. 27p each 5 for £1.00

24 D.I.L. 35p each 3 for £1.00

40 D.I.L. 60p each 2 for £1.00

## OTHER GOODIES

2N3055 (R.C.A.) 65p each

2N5943 R.F. output. 40 volts. 1 watt up to 1000MHZ

T.0.5 55p each 10 for £5.00

2N4304 WN/720 F.E.T. transistor 37p each 3 for £1.00

LM380N/SL6051 14 D.I.L. 2 watt AF amp 80p each 8 for £6.00

CA3028B DC. 120 MHZ differential cascode amp

£1.00 each 3 for £3.00

CA3011 20 MHZ wideband amp T099 case 65p each 2 for £1.00

TMS3114 DUAL MOS 128 bit static shift reg. DC

2.5 MHZ £1.50 each 4 for £4.25

NE555 27p each. 10 for £2.50

GE424 zero voltage switch. triac SCR relay driver

T05 can £1.10 each 7 for £6.50

LM384 5 Watt audio I.C.'s £1.50 each 10 for £11.00

FPO3725 4 NPN 50v 500ma transistors in 14

D.I.L. pack 70p each 2 for £1.00

## SUPERVALUE P.C.B. SPECIAL

Another great buy. Board contents include 62 Digital I.C.'s all located in 14 pin D.I.L. sockets. Original cost over £90, our price only £4.95 + pp 65p

## 5v D.C. POWER SUPPLIES

Following the recent "SELL OUT" demand for our 5v 3 amp P.S.U. we have managed to secure a large quantity of ex-computer systems P.S.U.'s with the following spec.; 240 or 110v A.C. input. Outputs of 5v @ 3.4 amps, 7.2v @ 3 amps and 6.5v @ 1 amp. The 5v and 7.2v outputs are fully regulated and adjustable with variable current limiting on the 5v supply. Unit is self contained on a P.C.B. measuring only 12" x 5" x 3". The 7.2v output is ideal for feeding "on board" regulators or a further 3 amp LM323K regulator to give an effective 5v @ 7 amp supply. Supplied complete with circuit at only £10.95 + £1.75pp. Believed working but untested, unguaranteed.

# KEYBOARDS

## ★ LOW PRICE CHASSIS ★

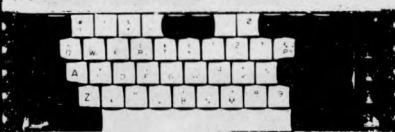

A special bulk purchase enables us to offer the above keyboard at a lowest ever price 49 coded keys encoded into a direct TTL compatible 7 bit output. Features such as delayed strobe, 5 volt D.C. single rail operation and rollover protection make this an absolute must for the MPU constructor! Supplied complete with connection diagram and edge connector, at a secondhand

"no time to test" price of only

£20.00 + P.P. £1.60

SUPER CASED VERSION Same as above spec. but housed in attractive two tone moulded, free standing case. Unit also includes an all TTL parallel to serial converter (no details) etc.

£27.50 + P.P. £1.85

## TOROIDAL TRANSFORMERS

PR 240v pri. sec. 15.0 15 @ 2 amps dimensions 3" x 2 1/2" £4.95 + p.p. 99p  
TM 240v 110v pri. sec. 15.0 15 8vA dimensions 2 1/2" x 1" £1.95 + p.p. 30p  
All voltages measured off load.

## Plugs, Sockets & Connectors Cannon 'D' Range

| Ways | Plug  | Socket |
|------|-------|--------|
| 9    | £1.03 | £1.26  |
| 15   | £1.17 | £2.01  |
| 25   | £1.72 | £2.58  |
| 37   | £2.35 | £4.14  |
| 50   | £2.90 | £5.46  |

25 way ex-equip. plug or socket £1.25

Edge connectors, gold plated.

|          |        |       |
|----------|--------|-------|
| 0.1" DS  | 40 way | £2.45 |
| 0.1" DS  | 85 way | £3.99 |
| 0.15" DS | 56 way | £3.25 |
| 0.156DS  | 36 way | £2.00 |

All connectors easily cut to size  
1000's of other connectors ex stock

## BARGAINS GALORE! In our walk round Warehouse NOW open Monday to Saturday 9.30-5.30



Dept. P.C.W. 64-66 Melfort Rd., Thornton Heath, Croydon, Surrey. Tel: 01-689 7702 or 01-689 6800

## MAIL ORDER INFORMATION

Unless otherwise stated all prices inclusive of VAT. Cash with order. Minimum order value £2.00. Prices and Postage quoted for UK only. Where post and packing not indicated please add 40p per order. Bona fide account orders minimum £10.00. Export and trade enquiries welcome. Orders despatched same day where possible. Access and Barclaycard Visa welcome.

# Does your microcomputer suffer from hiccups?

If so, quite often the cause of irregular performance or breakdown is very simple.

It's probably a high voltage spike in the electricity supply, called a transient, affecting the performance. Heavy electrical loads in the vicinity of your micro computer (from domestic electrical appliances to office photo-copiers) can often cause voltage transients, which in turn, play havoc with both hardware and software.

The Reguvolt 'P' Model Constant Voltage Transformer provides the answer to a very simple yet aggravating problem, offering the following benefits to safeguard your supply sensitive computer and equipment.

- Transient suppression — gives software and hardware protection.
- Brownout protection — prevents micro interruptions and system crashes.
- Isolated secondary circuitry — gives complete electrical isolation between mains and computer.
- Fast voltage stabilisation — prevents VDU screen drift and complete system failure.

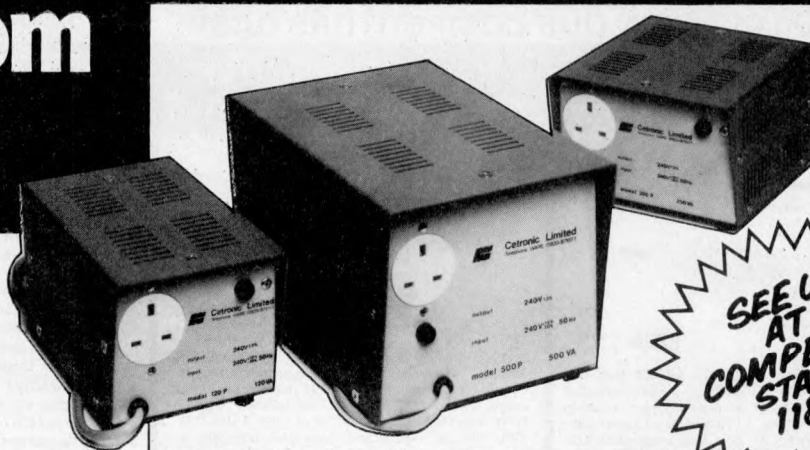

SEE US  
AT  
COMPEC '80  
STAND  
1180

- Automatic overload current limited — protects equipment against damage during a fault condition.

- Low frequency mains harmonics removed, preventing VDU flicker and circuit overload.

The complete range of Reguvolt 'P' models, from 1/2 to 2 amp ratings (ie. 120VA to 500VA) are available from stock.

Should you require further details, please fill in the coupon, or, if you prefer, give us a call.

Please send me further information on your range of Reguvolt 'P' Model Constant Voltage Transformers.

Name .....

Company .....

Address .....

Telephone .....



**Cetronic Limited**

Hoddesdon Road, Stanstead Abbots,  
Ware, Herts SG12 8EJ, England  
Tel: Ware (0920) 871077 Telex: 817293

# The video genie system only needs a plug



**£380 inc. VAT**

**MATRIX  
COMPUTER  
SYSTEMS LIMITED**

- 16K RAM + 12K Microsoft BASIC in ROM
- TRS-80 Level II compatible ● Ideal for Business, Education + Leisure ● Integral Cassette + TV Output
- Customized Business Packages available
- Expansion to Disks + Printer

325, Upper Elmers End Road, Beckenham, Kent. Telephone 01-658 7508/7551



# MICROCOMPUTERS ETC

For Hardware, Software, Peripherals, Consultancy and Competitive Prices.

Registered business name



**PET 2001**  
from **£425**



commodore  
authorised dealers

**TRS 80**  
from **£365**



From Radio Shack Corp.

**APPLE II**  
from **£695**



authorised dealers

**SORCEROR**  
from **£730**



authorised dealers

**ADVANCED SYSTEMS**



**BASIC SYSTEMS**

|                                                 |                                                               |
|-------------------------------------------------|---------------------------------------------------------------|
| PET 3016 (16K RAM and large keyboard) * £550.00 | PET 2001-8 (PET with 8K memory + integral cassette) * £425.00 |
| PET 3032 (32K RAM and large keyboard) * £695.00 | <b>PET 3008 (8K)</b> with large keyboard * £450.00            |
|                                                 | PET C2N External Cassette Deck £53.00                         |

**ACCESSORIES**

|                                                                                                           |                                                                                   |
|-----------------------------------------------------------------------------------------------------------|-----------------------------------------------------------------------------------|
| IEEE/RS232 Serial Interface 'A' Output only £106.00                                                       | IEEE-448/Centronics type parallel Interface £35.00                                |
| IEEE/RS232 Serial Interface 'B' Input/Output £186.00                                                      | IEEE to PET Cable £19.00                                                          |
| Programmers Toolkit - 10 powerful new commands for your Pet - plug in ROM chip 8K and 16/32K resp £75/£55 | IEEE to IEEE cable £24.00                                                         |
|                                                                                                           | <b>PETSET 1 16 Channel AD Converter</b> c.w. all interfacing requirements £166.00 |

**BASIC SYSTEMS**

|                                                                                                                         |                                                         |
|-------------------------------------------------------------------------------------------------------------------------|---------------------------------------------------------|
| TRS 80, 4K Level I consisting of Keyboard with 4K memory, Video Unit, Cassette Drive and 240v power supply unit £365.00 | TRS 80, 16K Level II (as above with 16K memory) £499.00 |
| TRS 80, 4K Level II (as above with Level II Basic) £425.00                                                              | TRS 80, Expansion Interface with 16K RAM £275.00        |
|                                                                                                                         | TRS 80, Expansion Interface with 32K RAM £360.00        |

**ACCESSORIES**

|                                                                   |                                                                                             |
|-------------------------------------------------------------------|---------------------------------------------------------------------------------------------|
| TVJ 232 serial interface £35.00                                   | Radio Shack Phone Modem £160.00                                                             |
| Centronics Parallel Printer Interface (direct to keyboard) £40.00 | UHF Modulators (encased with leads for 625 lines) £20.00                                    |
| TRS 80, Voice Synthesizer £345.00                                 | RAM upgrade (4-16K, 16-32K, 32-48K) supplied and fitted at our premises (Kit £80.00) £85.00 |
| TRS Voxbox - speech recognition system £135.00                    | S100 interface for TRS 80 (6 slots) and fitted £49.00                                       |
| TRS 80, Numeric Key Pad supplied £49.00                           | <b>TRS80 CPU 2 speed mod.</b> £26.00                                                        |

**BASIC SYSTEM**  
Apple II Plus computer - APPLIESOFT extended basic in ROM - (16K RAM) - video output £695

**ACCESSORIES**

|                                                                                                               |                                                                                                      |
|---------------------------------------------------------------------------------------------------------------|------------------------------------------------------------------------------------------------------|
| Apple black and white modulator for domestic TV £14.00                                                        | Real time clock/calendar card - 1/1000 sec to 388 days with interrupt, software controllable £128.00 |
| Eurocolor card - provides colour on domestic TV £79.00                                                        | Speechlab - provides voice control for the Apple £127.00                                             |
| Parallel Printer Interface Card £104.00                                                                       | Supertalker - adds human speech output! £136.00                                                      |
| High Speed Serial (RS232C) Interface Card £113.00                                                             | ALF Music Synthesizer Card £180.00                                                                   |
| Communications Card £130.00                                                                                   | A1-02 Data Acquisition Card £180.00                                                                  |
| Graphics Basic Firmware Card £116.00                                                                          | Graphics Tablet £462.00                                                                              |
| PASCAL language system - includes language card to provide user with PASCAL, PALSOFIT & INTEGER BASIC £299.00 | AC Line Controller £270.00                                                                           |
|                                                                                                               | RAM Upgrade (16-32K, 32-48K) £69.00                                                                  |
|                                                                                                               | Hobby Prototype Card £20.00                                                                          |
|                                                                                                               | Romplus - u./c. mixed text/graphics £105.00                                                          |

**BASIC SYSTEMS**

|                                               |                 |                 |
|-----------------------------------------------|-----------------|-----------------|
| Sorcerer (inc. UHF Modulator) 16K RAM £690.00 | 32K RAM £750.00 | 48K RAM £795.00 |
|-----------------------------------------------|-----------------|-----------------|

**ACCESSORIES**

|                                                                   |                             |
|-------------------------------------------------------------------|-----------------------------|
| Exidy Video Disk Unit £240.00                                     | Exidy S100 Unit £240.00     |
| (High Resolution monitor with Integral 630K Dual Drive) £1,690.00 | Exidy Video Monitor £240.00 |
|                                                                   | CP/M on Disk £145.00        |

**ADVANCED SYSTEMS**

TRS 80 Model II with integral B" floppy disk drive and up to 64K RAM. Expandable up to 3 Megabytes Disk Storage (Available for demonstration - by appointment only). P.O.A.

ACT 800 Systems providing 108K RAM, 46K User RAM, full size screen, high-res graphics, Ultra-fast data access and up to 4.8 MBytes on-line disk storage. P.O.A.

**Special Offers!** **PET BUSINESS SYSTEM** comprising CBM 3032 Micro computer, CBM 3040 Dual Disk Drive, CBM 3022 Tractor Feed Printer and all cables £1799.00

**NEW!** **LOWER PRICES FOR PET!** Up to £100 Reduction on some items (see above for details) **SUPER PETS ARE HERE!**

|                                                                       |
|-----------------------------------------------------------------------|
| CBM 8032 - COMPUTER with 80 column screen & business keyboard £895.00 |
| CBM 8050 - Dual Disk Drive giving 950K user storage £895.00           |

**Sorcerer Prices Down** - for limited period only. **ORDER NOW!**

**DISKS**

|                                                       |
|-------------------------------------------------------|
| PET CBM 3040 (dual drive) 343K User storage * £695.00 |
| Computhink (dual drive) 400K storage £895.00          |
| Computhink (dual drive) 800K storage £1145.00         |
| <b>TRS80</b>                                          |
| Shugart drive £299.00                                 |
| Micropolis drive £299.00                              |
| Percom FD200 drive 110v £289.00                       |
| Micropolis Dual Drive (394K storage) £995.00          |
| Corvus Hard Disk (11mb) £3500.00                      |
| <b>APPLE</b>                                          |
| Apple Drive - 116K storage 1st drive £349.00          |
| Apple Drive - 116K storage 2nd drive £299.00          |
| Corvus Hard Disk (11mb) £3500.00                      |
| <b>SORCEROR</b>                                       |
| Exidy - 143K storage £495.00                          |
| Exidy Dual drive (630K storage) £1195.00              |
| Corvus Hard Disk (11mb) £3500.00                      |

**PRINTERS**

PET CBM 3022 (80 col with PET graphics - tractor feed) \* £425.00

**TRS80**

|                                                        |
|--------------------------------------------------------|
| TRS 80 Screen Printer (text - graphics) (110v) £345.00 |
| New Radio Shack Micro Printer £245.00                  |

**GENERAL**

|                                                                                                                                                                       |
|-----------------------------------------------------------------------------------------------------------------------------------------------------------------------|
| Teletype 43 KSR Serial (pin or pinch feed, 132 cols) £825.00                                                                                                          |
| RACAL Binder Printers - truly professional printers for microcomputers - high speed (up to 280 cps), upper/lower case P.O.A.                                          |
| OKI - parallel/serial (pin or pinch feed, 40, 80, 132 cols selectable) £499.00                                                                                        |
| Centronics 779 parallel (tractor feed, 132 cols) £825.00                                                                                                              |
| DOLPHIN B808P tractor printer (125 cps bi-directional, 40, 80 columns - optional 132, u/c case & graphics). Available with Serial, parallel or IEEE interface £525.00 |
| Centronics Micro Printer (20, 40, 80 cols selectable) £395.00                                                                                                         |
| Heath WH 14 serial (80, 96, 132 cols selectable) £475.00                                                                                                              |
| QUIME daisy wheel printers P.O.A.                                                                                                                                     |
| TCM100/MICROHUSH Thermal Printer (40 cols) inc. interface for PET/APPLE £266.00                                                                                       |
| SILENT PRINTER for APPLE... allows printing of high res. graphics £349                                                                                                |

**ETC.**

Diskettes 5 1/4" (blank) boxed (min order 10) each from £3

C12 Cassettes (min order 10) each £0.35p

Ansaback 'phonemate' telephone answering machine, voice operated twin cassette £190.00

Pace EZ-PHONE - Cordless Telephone £225.00

Hitachi Video Monitors 9" / 12" resp. £127/£187

**BOOKS** - Large range of microcomputer related books and magazines

**TERMINALS**

Pentland V1, 80 char / 24 lines 2 page memory £580.00

**PROGRAMMABLE CALCULATORS, TEXAS INSTRUMENTS.** Business Programmable Calculators - complete range. Send for list + prices. (We are authorised TI dealers)

**IF YOU DON'T SEE IT - ASK IF WE HAVE IT**

**SOFTWARE**

**PET**

PETSOFT authorised dealers - over 160 programmes on cassette and disk. Send for catalogue

**STAGE ONE COMPUTERS** S/W dealers - PETAID, Stock Control, etc. Send for list.

|                                                                              |
|------------------------------------------------------------------------------|
| 74 Common BASIC Programs on one tape £15.00                                  |
| PETACT Business Software - Sales and Purchase Ledger, Invoicing, etc. P.O.A. |

**CBM DISK-BASED BUSINESS SOFTWARE**

|                                                                                                                 |
|-----------------------------------------------------------------------------------------------------------------|
| COMWORDPRO II/COMWORDPRO IV powerful word processor, low/high level resp. £75/150.00                            |
| COMSTOCK - STOCK CONTROL - gives complete stock report £150.00                                                  |
| COMBIS - BUSINESS INFORMATION SYSTEM - Storage & Retrieval of all types of company records £150.00              |
| COM ACCOUNTS - Full Financial Business Accounting System incl: Sales, Purchase, Nominal Ledgers £650.00         |
| COMPAY - Handles hourly, weekly or monthly paid employees £150.00                                               |
| COMPLANNER - Personal information tool for the busy executive £50.00                                            |
| (We are authorised CBM Business Software Dealers) Send for List.                                                |
| GD 1001 - Assembler Development System £50.00                                                                   |
| GD 010 - Lisp, Interpretive Language (Artificial intelligence) £75.00                                           |
| CAR INSURANCE QUOTATIONS - computerised car insurance quotation suitable for insurance brokers (TVJ S/W) £25.00 |
| MORTGAGE QUOTATIONS - suitable for agents/mortgage brokers (TVJ S/W) £25.00                                     |

**TRS 80**

|                                                                                                                                                                                         |
|-----------------------------------------------------------------------------------------------------------------------------------------------------------------------------------------|
| COMAC III SUITE - computerised accounting for TRS 80 (TVJ SOFTWARE) £75.00                                                                                                              |
| STOCK CONTROL - complete inventory control - recorder level - P/O's etc CP/M £95.00                                                                                                     |
| CBASIC £75.00                                                                                                                                                                           |
| FORTRAN includes compiler, relocatable assembler text editor and linking loader £95.00                                                                                                  |
| PASCAL - tomorrow's programming language today £195.00                                                                                                                                  |
| ELECTRIC PENCIL - powerful word processor allows full cursor movement, insert/delete, string search block movement, adjustable line length, justification on cassette £45.00            |
| ELECTRIC PENCIL as above - disk version £95.00                                                                                                                                          |
| LOWER CASE MOD KIT ONLY/FITTED for Electric Pencil £8.00/£28.00                                                                                                                         |
| DATA MANAGEMENT/REPORT GENERATOR - easily formats disk files, allows entry, edit, delete and list of records and retrieves data for display or calculation on screen or printer £150.00 |
| RSM-2D DISK MONITOR - powerful system manipulates disk data, has 2-80 break routine £25.00                                                                                              |
| ST80D communications software £60.00                                                                                                                                                    |
| NEWSDOS - TRSDOS with corrections and enhancements £25.00                                                                                                                               |
| NEWSDOS - as above but with further facilities:                                                                                                                                         |
| - KBFX, Renum, Screen to printer in one step, DOS commands from BASIC, Level I in II, Superzap, Disassemble, Load and save faster, list variables £49.00                                |
| LIBRARY 100 - an assortment of 100 programs £39.00                                                                                                                                      |
| SARGON CHESS - 16K Level II - the 1979 Champ Version I £14.00                                                                                                                           |

**APPLE**

|                                                                                                                         |
|-------------------------------------------------------------------------------------------------------------------------|
| Microchess 2-0 Chess Disk £15.00                                                                                        |
| U-DRAW II - High Resolution graphics editor. Create a figure then rotate, expand, contract etc and store on disk £27.00 |
| LISP - programming language suitable for research in artificial intelligence £52.00                                     |
| 3-MILE ISLAND - Complex disk based game simulating nuclear reactor £27.50                                               |
| VISCALC - Instant Visual Calculation - provides a powerful planning and forecasting tool £95.00                         |
| APPLE WORD PROCESSOR - Complete text editing, storage and retrieval of text (disk based) £42.00                         |
| LITTLE GENIUS - Comprehensive disk based Apple Soft Tutorial £35.00                                                     |
| ACT Appeware and MUSE authorised software dealers - Many programs on cassette and disk. Send for list.                  |
| <b>SORCEROR</b> many programs available - send for list. £120                                                           |
| Word Processor Rompac Development Pac £70.00                                                                            |

\* 5% DISCOUNT ALLOWED FOR EDUCATIONAL ESTABLISHMENTS

**TVJ T&V JOHNSON (MICROCOMPUTERS ETC) LTD** Hours of business Mon-Fri. 9.30 - 5.30 Sat. 9.00 - 12.30

Member of the TV Johnson Group of Companies

|                                                                                                                                           |                                                                         |                                                                             |
|-------------------------------------------------------------------------------------------------------------------------------------------|-------------------------------------------------------------------------|-----------------------------------------------------------------------------|
| <b>Camberley (Head Office)</b><br>Johnson House,<br>Park Street (At Pembroke Broadway),<br>Camberley, Surrey, GU15 3PN.<br>☎ (0276) 20446 | <b>Oxford</b><br>148 Cowley Road, Oxford<br>OX4 1JJ.<br>☎ (0865) 721461 | <b>Bristol</b><br>48 Gloucester Road, Bristol<br>BS7 8BH<br>☎ (0272) 422061 |
|-------------------------------------------------------------------------------------------------------------------------------------------|-------------------------------------------------------------------------|-----------------------------------------------------------------------------|

Directors: Dr. R.V. King BA, MEE  
S.G. Johnson, BSc (Hons)  
T.S. Johnson, ABIB, ACMB, FESC, MBIM  
A.S. Barton ACII, ABIBA, CdpAF

PRICES EXCLUDE VAT. FREIGHT & HANDLING SEND OR PHONE FOR PRICE LIST & BROCHURES (All prices correct at time of compilation)

+ Ansaback evens and w/ends. Telex 858893

**Dyad Developments** are pleased to  
announce that they have been appointed UK Distributors of  
**COMPUCOLOR II**

**COMPUCOLOR II**

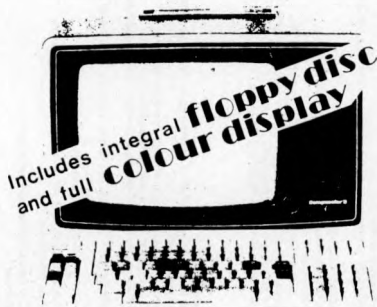

DEALER INQUIRIES WELCOMED

The CompuColor Corp. are now supplying them with their up to date systems and these have been found to be exceptional in performance and reliability. These second generation machines represent the most sophisticated and powerful small computers available today and at only half the cost of their counterparts.

- \* 13" COLOUR MONITOR for COLOUR GRAPHICS etc
- \* Built in MINIFLOPPY DRIVE 51.2K per side
- \* Impressive EXTENDED BASIC on 16K ROM
- \* HIGH RESOLUTION GRAPHICS 128x128
- \* RS232C port simplifies PRINTER or MODEM attach.

prices excl. VAT

|     |          |       |
|-----|----------|-------|
| 8K  | User RAM | £ 998 |
| 16K | " "      | 1078  |
| 32K | " "      | 1198  |

GAMES

- Formatted Twin Pack
- Sampler
- Othello
- Chess
- Star Trip
- Blackjack
- Cubic Tic Tac Toe
- Sharks
- Air Raid
- Star Trader
- Swarms
- Bounce
- Shoot
- Lunar Lander
- Solitaire
- Maze Master

SYSTEM/UTILITY

- Assembler
- Text Editor
- Data Base Systems
- Basic Utilities
- Monitor
- Screen Editor
- Formatter
- MDDP
- Fortran
- Macro Assembler
- Info-Link

EDUCATIONAL

- Hangman
- Math Tutor
- Basic Language 1-10
- Basic Language 11-15

MISCELLANEOUS HARDWARE

- ADD-ON DISK DRIVE
- RS232 ADAPTOR CABLE
- LOWER CASE CHARACTERS
- ADD-ON RAM, 16K
- ADD-ON PROM BOARD
- SOUNDWARE
- KEYBOARD UPGRADE 72-101
- KEYBOARD UPGRADE 72-117
- KEYBOARD UPGRADE 101-117
- MAINTENANCE MANUAL

ENGINEERING

- Statistics-I
- Statistics-II
- Statistics-III

BUSINESS

- Word Processor
- Trend Spotter

**Keyboard**

Separate keyboard with Standard ASCII 4 level coded with 192 codes. Includes 71 gold crossbar commercial key switches. CPU Reset and Automatic disk loading (AULTD) keys are included. Optional: 171 keys with color and numeric clusters or 117 keys with 16 additional function keys

**Microcomputer**

Central Processing Unit 8080A. 2 microsecond cycle time with total memory expandable to 64K bytes.  
Read Only Memory (ROM): 16K bytes of non-destructive read only Memory sockets included for 8K bytes of additional EPROM/MROM memory. Includes DISK, BASIC, File Control System, and Terminal Software.  
Random Access Memory (RAM): 4K bytes for screen refresh. 8K bytes for user workspace (Optional 16K and 32K - Models 4 and 5).  
Input/Output Ports: system is designed for 478 ports, with 51 ports implemented in standard unit. Including one RS-232C Serial Asynchronous Channel for a printer or modem.  
51 pin bus provides all addresses, data, clocks, etc. to allow the CompuColor II to be expanded with additional peripherals in the future.

CRT Terminal Commands Page/Roll Mode: Erase Line, Erase Page, Tab, Two Character Sizes, Blink, Cursor Home, Left, Right, Up and Down, Cursor XY Addressing, Caps Lock, CPU Reset, Foreground/Background Color Selection, 15 Plot Modes, Blind Cursor Mode, Local, Full and Half Duplex Modes, Write Vertical Mode, and Transmit Cursor and Page Modes.

Language: DISK BASIC 8001 interpreter in ROM memory includes: 39 statement types: CLEAR, DATA, DEF DIM, END, FILE, FOR, GET, GOSUB, GOTO, IF, INPUT, LOAD, NEXT, ON, OUT, PLOT, POKE, PRINT, PUT, READ, REM, RESTORE, RETURN, SAVE, STEP, THEN, TO and WAIT. 3 command types: CONT, LIST and RUN. 19 mathematical functions: ABS(x), ATN(x), CALL(x), COS(x), EXP(x), FN(x), FRE(x), INT(x), INP(x), LOG(x), PEEK(x), POS(x), RND(x), SIGN(x), SIN(x), SPC(x), SQRT(x), TAB(x), and TAN(x). 9 string functions: ASC(x), CHR\$(x), FRE\$(x), LEFT\$(x), LEN\$(x), MID\$(x), I\$, RIGHT\$(x), STR\$(x) and VAL\$(x). 12 Disk File commands: COPY, DELETE, DEVICE, DIRECTORY, DUPLICATE, INITIALIZE, LOAD, READ, RENAME, RUN, SAVE, and WRITE.

**CRT Display**

Eight color display with 32 lines of 64 characters (2048 characters). Two different character sizes. Plotting graphics of 128 x 128 including vector generating software. 64 standard ASCII characters and 64 additional special graphic characters. Includes a Standard RS232C Terminal Mode for time sharing use. Refresh: Usable screen area 9" wide x 6 1/2" high.

**Compewriter** - The Compewriter was designed specifically for the CompuColor II and the ISC 3621. This package includes the necessary keyboard conversions, documentation, and software to turn your computer into a powerful text editing machine. Compewriter incorporates the best features of the leading word-processing systems including single key command entry, full screen editing and print formatting on the screen.

**Trendspotter** - The Trendspotter software package is a "state-of-the-art" management information system which fully utilizes our products colorgraphic capabilities. Data is entered and stored on files created by the user. Trendspotter will automatically scale the data to fit within the graphic display. The display can be labeled according to the users needs and the various files plotted in any of the eight foreground or background colors for comparative analysis. Four graphic modes are available and data can be manipulated to account for lag and lead times, trend forecasting, exponential smoothing, simple linear regressions, moving averages, compound growth calculations, inflation and deflation compensation, detrending of data, and "trigger point" functions.



**FOR THE SINCLAIR ZX-80**

This unique book contains 30 programs, all designed to fit in the basic 1K version of the SINCLAIR ZX-80!!

Programs include **BLACKJACK**, **LUNAR LANDER**, (with spaceship display), **HANGMAN**, **NIM**, **LINE RENUMBER**, **MEMORY** (calculates how much memory is left using USR function), and **GOMOKU** (a Japanese board game on a 7 x 7 board).

Even more important than the programs themselves are the programming techniques these programs utilise, illustrating space compression, **PEEKs** and **POKEs**, **USR** function and use of the display section as memory!

available  
by mail  
order only

**£6.95** (plus 50P p&p)

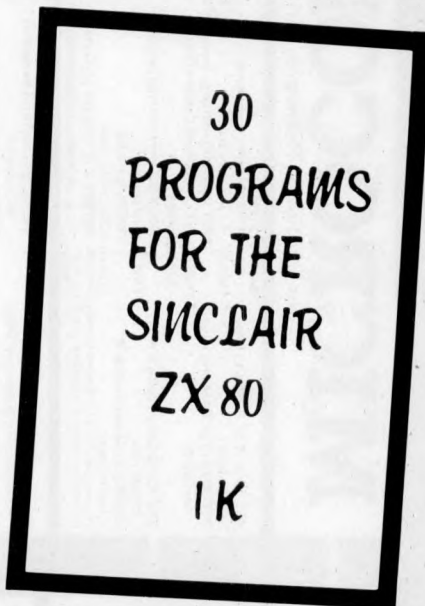

**COMING SOON:**

**ZX-80 MACHINE LANGUAGE PROGRAMMING**

**MELBOURNE HOUSE PUBLISHERS**

Orders to: 131 Trafalgar Road, London SE10  
Correspondence: Glebe Cottage, Glebe House, Station Road, Cheddington, Leighton Buzzard, Bedfordshire.

NAME .....

ADDRESS .....

Please enclose cheque or P.O. for £7.45 per copy.

# Sintrom Electronics

your specialists for business, scientific and educational  
microcomputer requirements

---

## PERIFLEX 630/48

Z-80 S100  
4 MZ  
48K RAM  
Dual Micropolis drives with  
630K storage  
3 parallel and 2 serial I/O ports  
2K PROM  
CP/M operating system

£1995

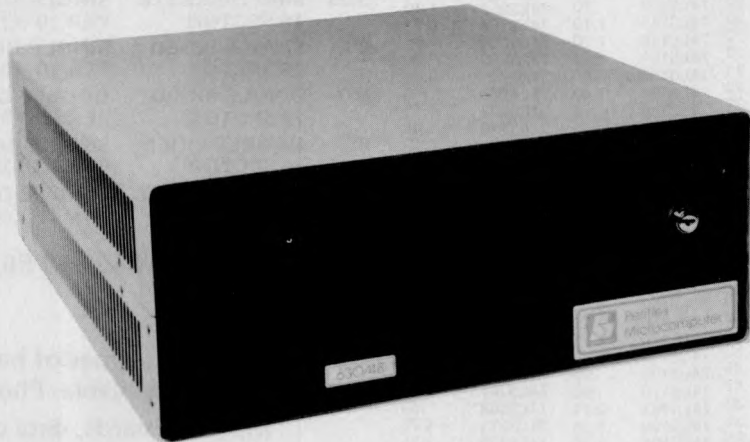

---

## MICROPOLIS FLOPPY DISKS

Wide range of drives available ex-stock  
143K to 315K formatted storage per drive  
Suitable for most S100 based micros  
Special units available for Tandy and Sorcerer  
OEM units with 143K to 315K storage

FROM £275



---

## MICROPOLIS 8" WINCHESTER HARD DISK

### OEM

7.13M byte to 35.68M byte storage  
Intelligent controller  
EPM coding  
Access time 23MS  
Same size mounting and power requirements  
as 8" floppies

FROM £2000

### S100

6.2M byte to 31.2M byte storage  
IDA intelligent disk adaptor  
OSM Multiuser operating system and Basic  
Enclosure and power supply  
Connecting cable  
Suitable for most 8080/8085/Z80 S100  
microcomputers

FROM £3000

\* CARTRIDGE BACK-UP ALSO AVAILABLE



**Sintrom  
Electronics**

Sintrom Electronics Ltd  
Arkwright Road, Reading, Berks RG2 0LS  
Tel: Reading (0734) 85464  
Telex: 847395

OEM & DEALER  
ENQUIRIES WELCOME

# MAGTRONICS

MAGTRONICS LTD  
3 GOLDHUST TERRACE  
LONDON  
N.W.6.  
TELE. 01-624-9847

## 74LS SERIES

|         |      |          |      |          |      |
|---------|------|----------|------|----------|------|
| 74LS00  | .18  |          |      |          |      |
| 74LS01  | .18  | 74LS112  | .35  | 74LS221  | 1.20 |
| 74LS02  | .18  | 74LS113  | .40  | 74LS240  | 2.10 |
| 74LS03  | .18  | 74LS114  | .35  | 74LS241  | 1.90 |
| 74LS04  | .22  | 74LS122  | .70  | 74LS242  | 1.90 |
| 74LS05  | .22  | 74LS123  | .75  | 74LS243  | 1.90 |
| 74LS08  | .20  | 74LS124  | 1.40 | 74LS244  | 2.10 |
| 74LS09  | .22  | 74LS125  | .40  | 74LS245  | 2.50 |
| 74LS10  | .18  | 74LS126  | .40  | 74LS247  | 1.20 |
| 74LS11  | .22  | 74LS132  | .65  | 74LS248  | 1.80 |
| 74LS12  | .22  | 74LS133  | .40  | 74LS249  | 1.25 |
| 74LS13  | .40  | 74LS136  | .40  | 74LS251  | 1.10 |
| 74LS14  | .70  | 74LS138  | .70  | 74LS253  | 1.10 |
| 74LS15  | .22  | 74LS139  | .70  | 74LS257  | 1.10 |
| 74LS20  | .20  | 74LS145  | 1.10 | 74LS258  | 0.95 |
| 74LS21  | .22  | 74LS148  | 1.70 | 74LS259  | 1.65 |
| 74LS22  | .22  | 74LS151  | .85  | 74LS260  | .30  |
| 74LS26  | .22  | 74LS153  | .55  | 74LS261  | 3.50 |
| 74LS27  | .22  | 74LS154  | 1.40 | 74LS266  | .40  |
| 74LS28  | .22  | 74LS155  | .75  | 74LS273  | 1.75 |
| 74LS30  | .20  | 74LS156  | .75  | 74LS279  | .65  |
| 74LS32  | .26  | 74LS157  | .60  | 74LS280  | 1.75 |
| 74LS33  | .28  | 74LS158  | .65  | 74LS283  | 1.00 |
| 74LS37  | .26  | 74LS160  | 1.10 | 74LS290  | 0.95 |
| 74LS38  | .26  | 74LS161  | .80  | 74LS293  | 0.95 |
| 74LS40  | .22  | 74LS162  | 1.10 | 74LS295A | 1.45 |
| 74LS42  | .65  | 74LS163  | .80  | 74LS298  | 1.40 |
| 74LS47  | .85  | 74LS164  | 1.10 | 74LS324  | 1.80 |
| 74LS48  | .85  | 74LS165  | .80  | 74LS325  | 2.55 |
| 74LS49  | 1.00 | 74LS166  | 1.70 | 74LS326  | 2.55 |
| 74LS54  | .20  | 74LS168  | 1.70 | 74LS327  | 2.55 |
| 74LS55  | .20  | 74LS169  | 1.70 | 74LS352  | 1.35 |
| 74LS63  | 1.50 | 74LS170  | 1.70 | 74LS353  | 1.35 |
| 74LS73  | .35  | 74LS173  | 1.10 | 74LS365  | .60  |
| 74LS74  | .35  | 74LS174  | .95  | 74LS366  | .60  |
| 74LS75  | .42  | 74LS175  | .95  | 74LS367  | .60  |
| 74LS76  | .35  | 74LS181  | 2.75 | 74LS368  | .60  |
| 74LS78  | .35  | 74LS190  | 1.20 | 74LS373  | 1.75 |
| 74LS83A | .85  | 74LS191  | 1.20 | 74LS374  | 1.75 |
| 74LS85  | 1.00 | 74LS192  | 1.10 | 74LS375  | .75  |
| 74LS86  | .35  | 74LS193  | 1.10 | 74LS377  | 1.75 |
| 74LS90  | .58  | 74LS194A | 1.00 | 74LS378  | 1.30 |
| 74LS91  | .99  | 74LS195A | .90  | 74LS379  | 1.40 |
| 74LS92  | .90  | 74LS196  | .95  | 74LS381  | 3.65 |
| 74LS93A | .65  | 74LS196  | .95  | 74LS386  | .60  |
| 74LS95A | 1.00 | 74LS197  | .95  | 74LS390  | 1.75 |
| 74LS96  | 1.25 | 74LS424  | 4.50 | 74LS393  | 1.50 |
| 74LS107 | .35  | 74LS445  | 1.25 | 74LS395  | 1.80 |
| 74LS109 | .35  | 74LS447  | 1.25 | 74LS396  | 1.70 |
| 74LS668 | 1.95 | 74LS490  | 1.95 | 74LS398  | 2.70 |
| 74LS670 | .95  | 74LS669  | .95  | 74LS399  | 1.60 |

## DISKETTES UNCONDITIONAL GUARANTEE

|       |                |                |
|-------|----------------|----------------|
| 5.25" | MINI-DISKETT S | SINGLE SIDED   |
|       | 1 SECTOR       | PER £10 £24.00 |
|       | (SOFT)         |                |
| 5.25" | MINI-DISKETTE  | SINGLE SIDED   |
|       | 10 SECTOR      | PER 10 £24.00  |
| 5.25" | MINI-DISKETTE  | SINGLE SIDED   |
|       | 16 SECTOR      | PER 10 £24.00  |
| 8"    | SINGLE SIDED   | SINGLE DENSITY |
|       | 26 SECTOR      | PER 10 £25.80  |
| 8"    | SINGLE SIDED   | DOUBLE DENSITY |
|       | 26 SECTOR      | PER 10 £32.00  |
| 8"    | DOUBLE SIDED   | SINGLE DENSITY |
|       | 26 SECTOR      | PER 10 £38.20  |
| 8"    | DOUBLE SIDED   | DOUBLE DENSITY |
|       | 26 SECTOR      | PER 10 £40.00  |

**MEMORIES**  
**C.P.U.s**  
**SUPPORT DEVICES**  
**C.M.O.s**  
**TRANSISTORS**  
**DIODES**  
**ALL STOCKED**  
**PHONE FOR**  
**QUOTATION**

All orders under £50 add 50 p P&P. Add 15% VAT to total.

Many other types of hard and soft sector diskettes available. Phone for quotation.

Magnetic cards, data cartridges, digital cassettes are also stocked.

Official orders from schools, colleges, universities and Govt. Bodies accepted.

# Karadawn Ltd.

## Micro Computer Systems & Software

2 Forrest Way, Gatewarth Industrial Estate, Warrington, Cheshire.

Tel: 0925-572668. Telex: 628269

### Business Systems

#### THE INCREDIBLE ROSTRONICS Z PLUS

- 2 MEGABYTE CAPACITY • Z80 CPU • 64K RAM
- ELBIT 1920-x TERMINAL WITH 15" SCREEN
- FULLY HOUSED IN CUSTOM BUILT WORKSTATION
- DELIVERED + INSTALLED AT ONLY **£4500.00**

Printers for the above from £925 -- £2,500 by Teletype, Diablo, Qume, Centronics, Texas Instruments.

10 Megabyte Hard Disk system £7,950.

### THE ULTIMATE PERSONAL/SMALL BUSINESS MICRO

#### Superbrain by Intertec

- 320K Dual Double Density Floppies • CP/m Op System
- 64K • TWIN Z80 A MICROPROCESSORS

DELIVERED + INSTALLED AT ONLY **£1,950.00**

### Word Processor Systems

- \* 2 MEG Z Plus system \* Diablo Heavy Duty Daisywheel
- \* "Wordstar" Word Processor Pack \*

DELIVERED + INSTALLED FROM **£6,950.00**

#### FOR THE PERSONAL COMPUTER

PRINTERS Centronics 730 C80/132 Character Mode,

Roll/Sheet/Sprocket £525.00. Paper Feed,

110 C.P.5, 6 International CHR sets,

TEAC Disc Drives. Smooth as Silk.

Single Drives £250 Inc Cable, Double Drives.

£450. Inc Cable.

Floppies FREE plastic library case with

every 10 disks 5¼" verbatim **£33.00**

8¼" Double sided, double density **£45.00**

ALL SYSTEMS CAN BE SUPPLIED WITH INDIVIDUALLY WRITTEN SOFTWARE  
TAILORED TO YOUR EXACT SPECIFICATIONS BY OUR OWN PROGRAMMERS.  
ALL OUR SOFTWARE IS FULLY SUPPORTED.

# NewBear

Computing Store Ltd



## MZ-80K

|                                                  |        |
|--------------------------------------------------|--------|
| NBMZ80K MONITOR LISTING .....                    | £15.00 |
| NBMZ80K BASIC LISTING .....                      | £30.00 |
| NBMZ80K ZEN EDITOR/ASSEMBLER TAPE & MANUAL ..... | £19.50 |
| MZ80K MACHINE CODE TAPE & MANUAL ...             | £22.50 |
| MZ80K ASSEMBLY LANGUAGE TAPE & MANUAL .....      | £45.00 |
| NBMZ80K V24/RS232 PRINTER INTERFACE ..           | £49.50 |

### DISKS & PRINTER NOW AVAILABLE

A COMPLETE BUSINESS SYSTEM FOR  
LESS THAN £2000.

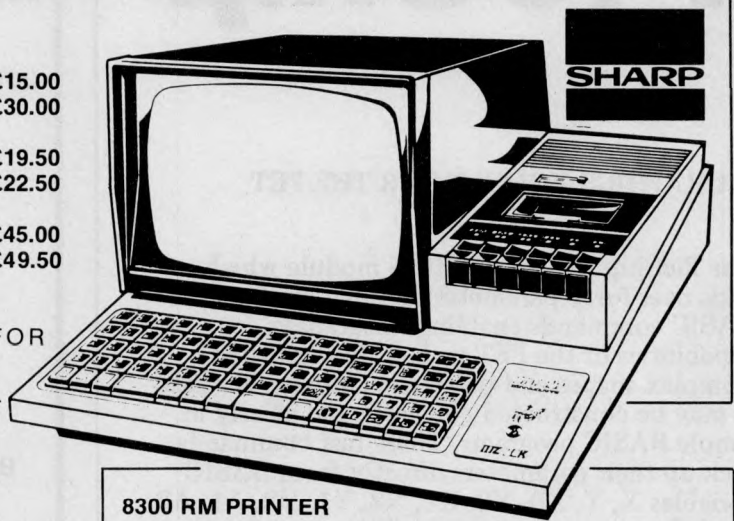

### MICROCOMPUTING I.C.'S

|                           |         |
|---------------------------|---------|
| MC6800 .....              | £6.75   |
| MC6802 .....              | £10.50  |
| MC6809 .....              | £17.75  |
| MC6810AP .....            | £3.61   |
| MC6821 .....              | £4.63   |
| MC6840 .....              | £10.50  |
| MC6850 .....              | £4.99   |
| MC6852 .....              | £4.75   |
| MC8062P .....             | 2.88    |
| MC14536P .....            | £2.50   |
| MC3459 .....              | £2.43   |
| Z8001 .....               | £142.50 |
| Z80 CPU 2.5 Mhz .....     | £8.99   |
| Z80 CTC 2.5 Mhz .....     | £7.99   |
| Z80 P10 2.5 Mhz .....     | £7.99   |
| Z80 S10 .....             | £25.57  |
| Z80A CPU 4 Mhz .....      | £10.50  |
| Z80A P10 4 Mhz .....      | £10.00  |
| Z80A CTC 4 Mhz .....      | £10.00  |
| SC/MP 11 (INS806ON) ..... | £11.30  |
| INS8154N .....            | £8.18   |
| 6502 .....                | £8.99   |
| 6522 VIA .....            | £8.14   |
| 6532 .....                | £9.75   |
| 6545 CRT CONTROLLER ..... | £18.50  |
| 6551 ACIA .....           | £9.99   |
| 8080A .....               | £5.50   |
| 8224 .....                | £2.95   |
| 8228 .....                | £3.00   |
| DM 8835N .....            | £1.35   |
| 8212 .....                | £2.25   |
| 8216 .....                | £2.50   |

## NEW LOW PRICES!



NORTH STAR ★ HORIZON

### 8300 RM PRINTER

80/132 CH PER LINE (SWITCHABLE); 125 C.P.S: 2K BUFFER; V24 RS 232/ CURRENT LOOP INTERFACE; SPEED SWITCHABLE BETWEEN 110.9600 BAUD; VARIABLE WIDTH CHAR AVAILABLE UNDER SOFTWARE CONTROL: SPROCKET FEED; 4 x 9 DOT MATRIC; PAPER WIDTH 4.5" TO 9.5"

PRICE £499.00

### SPECTRONICS U.V. EPROM — ERASING LAMPS

|                                                          |         |
|----------------------------------------------------------|---------|
| PE 14 ERASES UP TO 6 CHIPS, TAKES APPROX. 19 MINS.....   | £45.00  |
| PE 14T ERASES UP TO 6 CHIPS, TAKES APPROX. 19 MINS.....  | £59.95  |
| PE 24T ERASES UP TO 9 CHIPS, TAKES APPROX. 15 MINS.....  | £87.00  |
| PR 12ST ERASES UP TO 16 CHIPS, TAKES APPROX. 7 MINS..... | £186.24 |
| PR 320T ERASES UP TO 36 CHIPS, TAKES APPROX. 7 MINS..... | £302.00 |

### U.V. EPROM ERASING CABINET

|                                                           |          |
|-----------------------------------------------------------|----------|
| PC 1100 ERASES UP TO 72 CHIPS, TAKES APPROX. 7 MINS.....  | £693.00  |
| PC 2200 ERASES UP TO 144 CHIPS, TAKES APPROX. 7 MINS..... | £1142.00 |
| PC 3300 ERASES UP TO 216 CHIPS, TAKES APPROX. 7 MINS..... | £1595.00 |
| PC 4400 ERASES UP TO 288 CHIPS, TAKES APPROX. 7 MINS..... | £2047.00 |

## proper 816

PROFESSIONAL PROM PROGRAMMER

FOR 2708/2716/2532



PRICES FROM £565.00  
SEND FOR FULL SPECIFICATION.

## NewBear

for the widest selection of computing books  
**NEW BOOK LIST**

### MEMORIES

|                             |        |
|-----------------------------|--------|
| 4116 (16K DYNAMIC) .....    | £4.50  |
| 2716 (INTEL + 5V TYPE) - .. | £12.50 |
| 2708 .....                  | £4.50  |

NEWBEAR COMPUTING STORE LTD, (HEAD OFFICE) 40 BARTHOLOMEW STREET, NEWBURY, BERKS

TELEX 848507 NCS

(MAIL ORDER) TEL. (0635) 30505

FIRST FLOOR OFFICES, TIVOLI CENTRE, COVENTRY ROAD, BIRMINGHAM.

TEL. 021 707 7170

220-222 STOCKPORT ROAD, CHEADLE HEATH, STOCKPORT.

TEL. 061-4912290

PLEASE ADD V.A.T. TO ALL PRICES.

**GET A SHARP DEAL FROM NEWBEAR**  
SEND FOR OUR FREE CATALOGUE

Announcing . . . . .

# PicChip

## A GRAPHICS MODULE FOR THE PET

The PicChip is a plug-in ROM module which adds over forty parameterised high-level BASIC commands enabling the graphic capabilities of the PET to be fully exploited. Complex shapes and patterns — moving or static — may be constructed concisely and clearly in simple BASIC programs. These fast commands pick up their parameters directly from BASIC variables X, Y, X0, Y0, X1, X2, Y1, Y2, A1, A2, N, C. Besides such useful facilities as a repeat-key on/off command, the available functions include:

### Character Density (40x25)

- § Define rectangular window area
- § Area fill with character C
- § Area roll or shift N up, down, left, right
- § Set area in upper/lower/inverted case
- § Set area normal/reversed/inverted
- § Cursor position read/set to X, Y
- § Poke character C to X, Y
- § Copy screen to/from any RAM address

### Double Density (80x50)

- § Draw/erase point at X, Y
- § Draw/erase line from X1, Y1 to X2, Y2
- § Draw/erase perpendicular to X/Y axis
- § Draw/erase continuous line

### Fine density (40x200/25x320)

- § Plot X value with 320 resolution
- § Plot Y value with 200 resolution

Excellent for process-diagrams, maths, teaching-aids, games, moving graphs etc. Works with 'New ROMs' only. Plugs in to UD5 socket on 16/32K models. Earlier PETs need bus-adapter.

PicChip complete with comprehensive handbook: £57.59 inclusive  
Handbook separately: £5.00

Sterling cheque with order to:

Houghton-Insel Computer  
Arabellastrasse 58  
8000 Muenchen 81  
West Germany

UK Distributor enquiries invited.

## MICRO-SALES MICRO-LEASE MICRO-HIRE MICRO-BOUGHT MICRO FOR YOUR REQUIREMENT

We have the best in Micros, Apple, Intertec Superbrain (rapidly becoming industry standard). Horizon are just some. Low maintenance rate after 1 year guarantee, if you ever need it.

**MICROSALES: APPLE II + IN COLOR, WITH OTHER CARDS FOR HOBBYIST, EDUCATIONALIST, BUSINESS, PROFESSIONALS, 64K PASCAL, FORTRAN, APPLE-FORTH AND OTHER SOFTWARE.**

### INTERTEC SUPERBRAIN

32K/64K AND MORE WITH \$100 EXPANSION INDUSTRY STANDARD CP/M, SYSTEM, TWO Z80 OPERATIONS. TWO QUAD DENSITY OR DOUBLE DENSITY DRIVES NICELY PUT TOGETHER WITH A SCREEN

PCM PASCAL  
APL FORTRAN OEM, Educational, &  
ASM COBOL dealship enquiries welcome  
PLM 80

MICRO-CUSTOM DESIGN REQUIREMENTS: LET US IMPLEMENT YOUR IDEAS IN ALL AREAS ASPECT OF COMMUNICATIONS MAPCON REGISTERED CONSULTANTS.

**MICROLEASE: TAKE ADVANTAGE OF LEASING, THERE MAYBE PLENTY FOR YOU AND FOR HAVING A MICROSYSTEM.**

**MICROHIRE: APPLE, HORIZON, SORCERER, PET, TRS 80, SUPERBRAIN. SOME BELOW £12 PER WEEK. NO DELIV. COLLECT CHARGES IN LONDON.**

**BARGAIN CORNER: SLIGHTLY USED MICRO-COMPUTERS, APPLE, ITT2020, SORCERER, PETS, TRS80, FROM AROUND £300 - £600.**

### PROMGLOW LTD

Present address 12 Dene Road, N11.

Moving to a new shopping precinct comparable

to Westend.

North London Woodgreen, Piccadilly Line

Ring: 01-368 9002. Mon-Sun, Including Evenings

For communication aspects ring: 01-435 4493.

## ...British S100 BOARDS.....

(MANUFACTURED IN THE U.K. TO IEEE BY

### INTERACTIVE DATA SYSTEMS)

|              |                                                                                                                                                                                               |                        |
|--------------|-----------------------------------------------------------------------------------------------------------------------------------------------------------------------------------------------|------------------------|
| IDS SBMC     | Single Board Micro-computer, Z80A CPU, 4MHz operation (can be jumpered to operate at 2MHz if required), 1K RAM, sockets for up to 32K EPROM, TWO SERIAL PORTS.                                | KIT £178<br>A&T £235   |
| IDS 16K SRAM | 4MHz Static RAM using low power 2114 chips.                                                                                                                                                   | KIT £174<br>A&T £198   |
| IDS 8K SRAM  | 4MHz Static RAM using low power 2114 chips                                                                                                                                                    | KIT £ 98<br>A&T £114   |
| IDS DFDC     | Double/single density, double/single sided Floppy Disc Controller, up to 4 drives.                                                                                                            | KIT £177<br>A&T £198   |
| IDS SFDC     | As DFDC but single density only                                                                                                                                                               | KIT £109<br>A&T £140   |
| IDS PCI 10   | Parallel Control Interface with: 8 channels relay-isolated output, 8 channels opto-isolated input, four 8 bit D/A converters, Eight 8 bit analogue inputs, 8 bits input, 8 bits output at TTL | KIT £195<br>A&T £223   |
| IDS Z80 CPU  | Z80A CPU board, 4 MHz operation                                                                                                                                                               | KIT £ 84<br>A&T £105   |
| IDS TERM 40  | Active Termination Board                                                                                                                                                                      | KIT £ 25<br>A&T £32.50 |
| IDS 7M.BD    | 7 slot Mother Board, including power connector. (Excludes S100 connectors)                                                                                                                    | Each £16               |
| IDS 15M.BD   | As 7M.BD but 15 slot.                                                                                                                                                                         | Each £ 24              |
| S100 CONN    | S100 edge connectors                                                                                                                                                                          | Each £2.90             |
| DP 8000      | Anadex dot matrix printer, RS232 interface.                                                                                                                                                   | Each £495              |
| CATALOGUE    | More details of the above products and others.                                                                                                                                                | FREE                   |

Please add 15% VAT to all prices.

MAIL ORDER ONLY

.....Mendip Computers..

67 BATH ROAD, WELLS, SOMERSET, BA5 3HS. TEL: WELLS (0749) 75249

**INNOVATIVE**

# TRS-80 SOFTWARE

**FROM THE PROFESSIONALS**

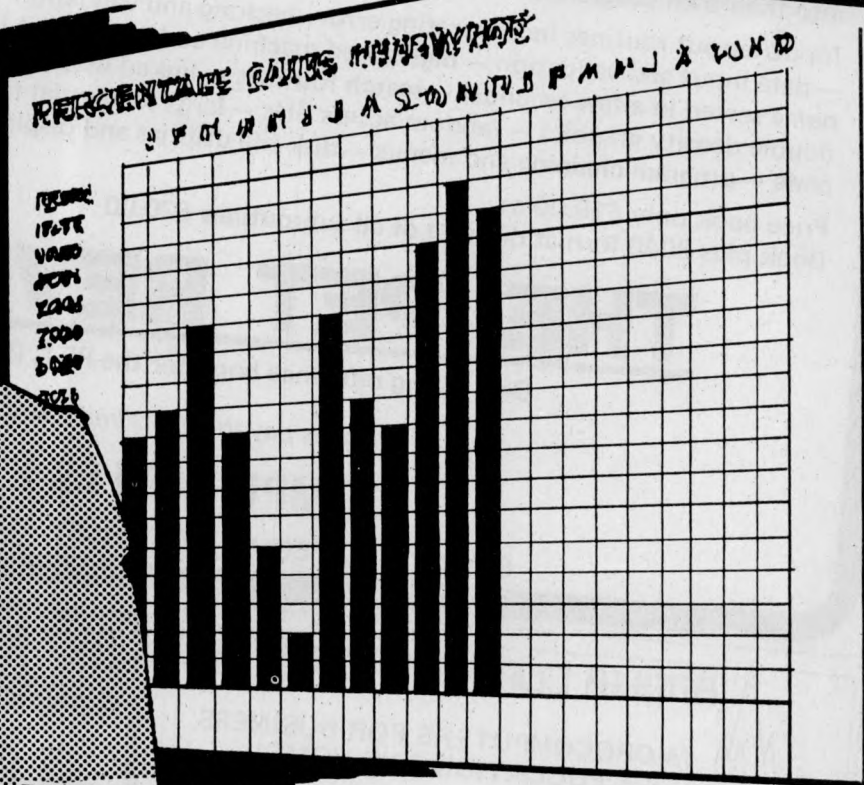

## COMPANY DIRECTOR

You are in charge of an Electronics Company able to produce digital watches, colour TVs and other products. You must cope with sales, production, research and development, industrial disputes with your labour force - you name it! If you make the right decisions then the company will flourish, make them wrong and you will be out of business. This is a game which may be played by one to three players. Each player has his own company to manipulate. You will have the option of bidding for export orders (with a big penalty for non-delivery) and every month you will be given a Profit & Loss Account, a Balance Sheet and 3 graphs to help you decide on the next month's decisions. A gripping game which allows you to make or lose a fortune without leaving your chair! TRS-80 Level II 16K or Disk and the Video Genie. Supplied on cassette.

SEE YOU AT STAND No. B17  
The 3rd Personal Computer Show  
SEPT. 4-6 CUNARD INTERNATIONAL HOTEL

# £14.95

Plus VAT @ 15% = £17.19.  
Postage & Packing 75p.

Send large SAE (38p) for our current Catalogue of TRS-80 software. Add £1.85 for a binder.



**A.J.HARDING (MOLIMERX)**  
**MOLIMERX LTD.**

28 COLLINGTON AVENUE, BEXHILL-ON-SEA, E. SUSSEX. TEL: (0424) 220391  
TELEX 86736 SOTEX G FOR A. J. HARDING



# Write better programs for your pet using **THE PET SUBROUTINE LIBRARY**



Containing a collection of useful subroutines, some in machine code, for readers to incorporate into their own programs.

Input/output routines incorporating error checking and validation – high density graphs and barplots – date input and validation – high speed machine code array sort (100 element array of any variable name sorted in a few seconds) – search routines – linked lists – utility programs – check digits – double density graphics – random access files – large sequential file sort – disk file access by machine code – program chaining and menus – disk file utilities and displays – plus many others.

Price book only £10.00 or  
Book plus 3040 format diskette of all subroutines £20.00

## **THE PET REVEALED**

Best selling reference book for the PET. Price £10.00

*Cheques payable to Computabits Ltd*

**COMPUTABITS LTD,**

P.O. BOX 13, YEOVIL, SOMERSET. Tel Yeovil 26522



**ANGLIA COMPUTER CENTRE**  
MICROCOMPUTERS FOR BUSINESS,  
EDUCATION AND HOME

No. 1 for all your business, education & leisure  
computer requirements!!!

APPLE,  
ACORN.  
NORTH STAR HORIZON.  
NASCOM.  
TANDY TRS-80.  
SHARP.  
U.K. 101.  
TANGERINE.  
SORCERER.  
+ PRINTERS &  
OTHER PERIPHERALS.  
+ ALL BUSINESS  
SOFTWARE.  
+ BUSINESS SEMINARS  
AND EVENING  
CLASSES.  
+ FREE  
CONSULTANCY.

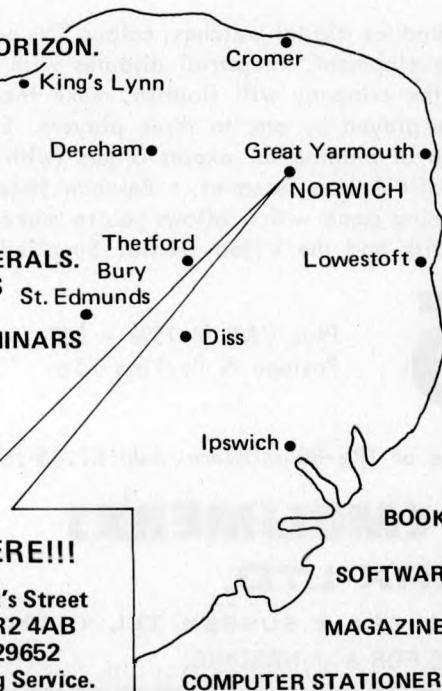

**WE ARE HERE!!!**

88 St. Benedict's Street  
NORWICH NR2 4AB  
Tel. (0603) 29652  
24hr. Answering Service.

BOOKS

SOFTWARE

MAGAZINES

COMPUTER STATIONERY

## **APPLE & PET SYSTEMS**

### **LOGIC BOX HAVE THE COMPLETE SOLUTION**

\* Full range of APPLE and PET Hardware

\* Application software

Accounting  
Stock Control  
Business Planning/Modelling  
Word Processing  
Database Handling

\* Professional advice and support

Programming  
Installation and Training  
Maintenance

Call, write or phone  
Logic Box Ltd.,  
31 Palmer Street,  
Victoria,  
London S.W.1.  
(near St. James's Park underground.)  
Tel: 01-222 1122/5492





# SORCERER

CP/M™  
S100  
Z80

For the serious user:  
**Business  
Education  
Amateur**

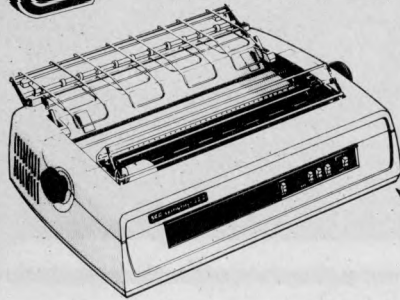

PIO + RS232/20ma serial O/P  
Dual 1200 baud cassette O/P

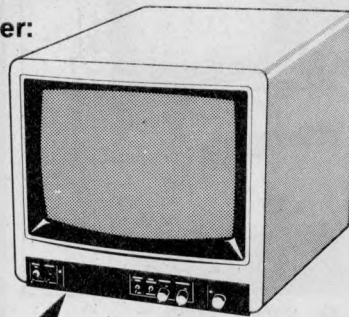

Memory mapped  
30 lines x 64 characters  
upper/lower case + 128  
programmable graphics



SORCERER  
16-48K internal RAM  
Z80 CPU, 4K monitor

Video or UHF

6 slot S100 expansion  
(not illustrated)

ROMPAC

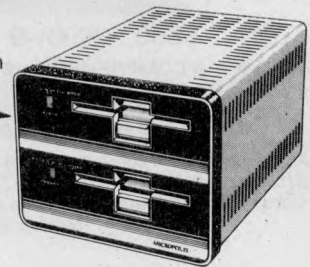

Micropolis 630K dual disk  
CP/M or Micropolis MDOS

## STANDARD SORCERER

- \* Displays 30 lines of 64 characters - more than any other personal computer. 79 key stepped typewriter-style keyboard with separate numeric pad for fast data entry.
- \* Plug in ROMPAC cartridges for programming languages, special applications (e.g. word processing) or creating a user's dedicated system. Sorcerer is supplied with 8K Microsoft BASIC ROMPAC
- \* Composite video output for video monitor or UHF output for use with an unmodified TV set at nominal extra charge.
- \* Z80 CPU with up to 48K RAM on-board.
- \* 4K power-on monitor in ROM allowing machine code programming, batch processing, memory transfers and copying, alteration of memory locations, use of cassette files.
- \* Dual 300 or 1200 baud cassette ports with motor control
- \* Parallel I/O port and serial RS232 port for direct connection to printers or use as a terminal to a larger computer - no expensive 'extra' communications interfaces
- \* Full upper/lower case ASCII characters plus 128 user programmable graphics (64 default to standard graphics symbols if undefined). Default graphics above ordinary characters on keytops.

16K £749.00    32K £799.00    48K £849.00

## Expansion Capabilities

- \* 6 slot S100 expansion for memory up to 56K RAM, disc drives (5 1/4" or 8") etc. Standard bus means that you are not dependent on equipment from a single manufacturer **£240.00**
- \* Micropolis double density 5 1/4" drives with MDOS and Disc BASIC:  
First drive (incl. controller card) single 315K **£690.00**  
Additional drives (max 4 drives/controller) 315K **£390.00**
- \* FDM 180 Disk Unit: Micropolis Disk Drive, plugs directly into Sorcerer, does not require S100 Unit:  
Single 315K Disk Drive (c/w CP/M and Microsoft BASIC) **£599.00**  
Single 315K Add-on Disk Drive. **£450.00**
- \* CP/M industry standard disk operating system **£75.00**
- \* Development ROMPAC - Z80 assembler, loader, editor, debugger **£70.00**
- \* EPROM PAC for loading dedicated software up to 16K **£35.00**
- \* Configuring programs allow Sorcerer to be used as a 'dumb' terminal or, with CP/M, as an intelligent terminal.

## Programming Languages

The following programming languages are available for CP/M:

Microsoft Disk BASIC interpreter (BASIC 80 - compatible compiler), CBASIC2 (compiled BASIC), FORTRAN 80 and COBOL-80, ALGOL 60 - A Z80 system with graphics, string handling and random-access filehandling.

All Exidy products are covered by 12 months warranty.  
CP/M™ is a trademark of Digital Research.  
All prices exclusive of VAT

## THE WORDPROCESSING WIZARD!

Sorcerer's upper/lower case typewriter keyboard and unusually large display (30 lines of text; approximately equivalent to one double-spaced typed page) makes it ideal for word processing applications. The Exidy word processor PAC is a sophisticated screen editor and text formatter with automatic text wrap-around, left and right justification, proportional letter spacing (on disk only with Spinwriter) and many other formatting facilities. It can also search for and replace strings, move and merge blocks of text and a macro facility allows specification of tasks such as mail-merge letter typing. Letters and texts can be stored on cassette or disks (one disk will store approximately 300,000 characters and costs less than five pounds. 32K or 48K RAM is recommended.

Word Processor PAC **£120.00**    Disk Version: **£118.75**

C.Itoh 8300 dot matrix printer -40, 80 and 120 characters per line on 9 1/2" wide paper, 125 characters/second, upper/lower case, tractor feed, forms positioning **£499.00**

NEC Spinwriter solid font printer -variable horizontal and vertical spacing, proportional spacing, interchangeable fonts, carbon or fabric ribbon, 55 characters/second, paper up to 16" wide **£1,900.00**

Example system: 32K Sorcerer, video monitor, FDM 180 Disk Unit with CP/M and Microsoft BASIC, C.Itoh 8300 printer, Word Processor on disk and CP/M. **£2,225.00**

## Business Software

Besides its word processing capabilities, Sorcerer can run a wide range of business software thanks to the widely used CP/M disk operating system available for the Micropolis disk drives. Programs available include:

Payroll: (requires CP/M and CBASIC2) **£250.00**  
General Ledger, Job Costing, Accounts Receivable, **£335.00 each**  
Accounts Payable: (all require CP/M and CBASIC2)

For further information and list of dealers,  
please contact the sole U.K. distributors.

GEOFF WILKINSON, Dept. PCW.1

# LIVEPORT

DATA PRODUCTS

The Ivory Works, St. Ives, Cornwall TR26 2HF  
Telephone: (0736) 798157

PLEASE SEND DETAILS OF THE EXIDY RANGE/WORD PROCESSOR

NAME \_\_\_\_\_

ADDRESS \_\_\_\_\_

PCW.1



### SS50 6800-9 SYSTEMS

WE HAVE A COMPREHENSIVE AND GROWING RANGE OF SS50 BOARDS AND BUILT SYSTEMS PARTICULARLY SUITED TO EDUCATION, CONTROL SYSTEMS AND SOFTWARE DEVELOPMENT.

AVAILABLE: Processor Card £80, Memory Mapped VDU with U/L Case and Graphics £80, 16-32K RAM Card £130, Interface Card with Timer and Real Time Clock, Disc Card, Extra Thick Mother Board.

As an example of a built system, the illustration shows Trainer 2, a single disc teaching unit with cassette, TV, keyboard and interface + switchbox to give a compact teaching station for machine control using basic or assemble. Price £1130.00

WE ARE OFFICIAL APPLE DEALERS.  
16K Apple now only £695 All prices exclude VAT

## HEWART MICROELECTRONICS

95 Blakelow Road, Macclesfield, Cheshire  
Tel: 0625 22030

### MONITORS

B & W - GREEN - COLOUR

|                            |      |
|----------------------------|------|
| 9" Green (Ideal Apple/ITT) | £155 |
| 9" B & W                   | £136 |
| 12" B & W                  | £175 |
| 14" B & W                  | £189 |
| 17" B & W                  | £225 |

Top quality, high resolution monitors guaranteed 12 months. Carriage/V.A.T. extra. Full range of B & W and colour receiver Monitors available, P.O.A.

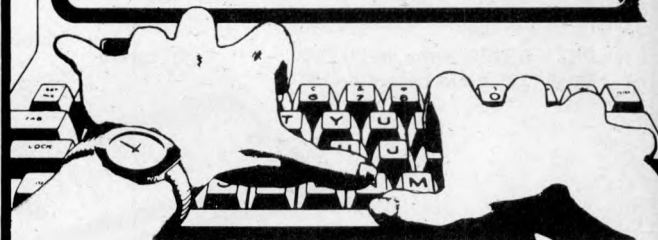

Dealer Enquiries Welcome

HAMM & GIBSON  
MONITOR & VIDEO SPECIALISTS  
43 MALDEN WAY, NEW MALDEN,  
SURREY KT3 6EA 01-942-9635

## FOR ALL YOUR MAIN REQUIREMENTS FROM ONE SUPPLIER JUST LIFT THE PHONE...

0252-518022/518717

Continuous Stationery - all types pre-printed including letterheads. Listing Paper - all sizes.  
Continuous labels - plain and printed.  
Printer ribbons, Pet etc., 3M Data Recording Products  
ACCO Continuous Stationery filing systems

### NOW AVAILABLE EX-STOCK

Plain listing paper in the following sizes:-  
11 x 8½, 11 x 9, 11 x 9½, 11 x 9¾, 12 x 9¾  
All best quality white bond, tear off sprockets

ONLY £14.00 per box of 2000 sheets

add carriage of £3.00 per box + VAT 5 or more carriage FREE.

### WE CAN ALSO PRINT CONTINUOUS FORMS

WITH YOUR NAME & ADDRESS ETC  
PLEASE RING FOR FREE QUOTE

3M Personal Digital Computing Cassettes. Individually boxed, minimum order 10 10 min 47p each, 30 min 53p each,  
5¼" Mini Diskettes, 100% error free

£2.25p each, minimum order 10

as above but in plastic library case

£2.46p each, minimum order 10

8" Diskettes, 100% error free, storage box,

From £2.60p each, minimum order 10

NEW LINE - Smart Diskette binder, anti static, holds 20.5"

£15.25 each

as above but for standard 8" Diskettes £17.25p each

\*ACCO paper binders, a must for all stationery filed or regularly used, from £1.86 each

Add VAT and 80p post & packing for each item ordered, all despatched within 24 hours.

## Clearsons Ltd.

Lynwood House 1 Camp Road Farnborough  
Hampshire GU14 6EN

## Explorer/85

NOW AVAILABLE WITH 8" FLOPPY DISC SYSTEM. AN INEXPENSIVE 8085S BASED S-100 FOR MAXIMUM

### FLEXIBILITY

EXPLORER/85 offers you real flexibility, you can build the exact system you require. EXPLORER/85 can be your Beginners system, OEM Controller or IBM formatted 8" disc Business system. You don't buy more than you need. Prices start from £91.75.

**HARDWARE:** Mother board (A'8085cpu, 8355 ROM with powerful 2K monitor system and I/O ports, 8155 RAM-I/O with 256 bytes of scratch pad. Two S100 pads, room for RAM, ROM, PROM, EPROM and S100 expansion plus prototyping space. Level 'B' allows address decoding for onboard RAM & EPROM, address & data bus drivers for onboard expansion. Wait state generator.  
**SOFTWARE:** Microsoft-90 in ROM or cassette, or CP/M disc operating system which will support four 8" drives.

**PACKAGE EXPLORER/85** is available in kit form or assembled complete or in separate levels to suit your requirements and pocket. Cabinets and other peripherals are available.

**VIDEO KEYBOARD TERMINAL:** Microprocessor controlled, 1K RAM character generator, processor controlled cursor control and parallel ASCII/Baudot to serial conversion plus serial to video processing all crystal controlled. Upper & lower case keyboard, choice of 32 or 64 characters by 16 lines with select' baud rate, RS232 or 20ma loop.

In kit form £114 or assembled £139.

**64K 'JAWS' DYNAMIC RAM S100 BD INTEL 8202 CONTROLLER,** hidden refresh, low power consumption, latched data outputs, 4116 RAMS. Onboard crystal, 8k bank select, fully socketed designed for 8080, 8085 and Z80.

16K kit £149: W&T £169: 32K kit £218: W&T £238: 48K kit £287: W&T £307: 64K Kit £346 W&T £376: 16K expansion kits £69.

**8" DISC DRIVE SPECIFICATIONS\*** Control Data Corp professional drive \*LSI Controller\* Write protect\* Single 6r double density\* Data capacity: 401, 016 bytes (SD) 802, 032 bytes (DD) unformatted\* Access time 25ns (one track)... £392.

**DISC CONTROLLER BOARD SPECIFICATIONS\*** Controls up to 4 8" drives\* 1771ALSI (SD) Floppy disc controller\* On board data separator (IBM compatible)\* 2 serial I/O ports\* Autoboot to disc system when system reset\* 2716 PROM socket for user custom applications\* Onboard crystal controlled\* Onboard I/O baud rate generators to 9600 baud\* Double-sided PC board (glass epoxy)... £156.

**DISC DRIVE CABINET/POWER SUPPLY UNIT\*** De Luxe steel cabinet for two 8" drives with individual power supply for maximum reliability and stability... £79.

SAVE 10% on complete floppy system 1 drive 8" \*Controller Board\* Cabinet\* Set of cables... £582.

**SOFTWARE** \* CP/M 1.4... £75. \*CP/M 2.0... £99.

\*Microsoft extended Basic... £195.

Complete Business Software Package\* Includes CP/M 2.0

\*Microsoft Basic\* General Ledger\* Accounts Receivable\*

Accounts Payable\* Payroll Package... £495.  
New! Newtronics TVM 9" monitor... £99.50.



# Newtronics



255 ARCHWAY ROAD, LONDON N6 5BS

TEL: 01-348 3325 (24 hrs)

Open Monday-Saturday 9-6pm

# CP/M COMPATIBLE SOFTWARE FROM SUPERSOFT

## SYSTEM MAINTENANCE

### CP/M COMPATIBLE SOFTWARE FROM SUPERSOFT.

#### System maintenance

Diagnosics 1 — easily the most comprehensive set of CP/M, compatible system check-out programs ever assembled. Finds hardware errors in your system, confirms suspicions or gives the green light.

Tests:

- \* MEMORY
- \* CPU (8080/8085/Z80)
- \* TERMINAL
- \* DISK
- \* PRINTER

The CPU test is the first of its kind to our knowledge. It pays to find problems before they become serious. Minimal requirements 24k CP/M. Supplied complete with User Manual £39.95, manual alone £9.95.

## SOFTWARE SECURITY

Encode/Decode is a complete software security system for CP/M, a sophisticated coding program package which transforms data stored on disk into completely unrecognisable coded text. Encode/Decode supports multiple security levels and passwords, and a user defined combination (from the billion possible) is used to code and decode a file. Uses are unlimited, and DATA BASES, PAYROLL FILES, PROGRAMS, GENERAL LEDGER, CORRESPONDENCE, TAX RECORDS, INVENTORY, ACCOUNTS PAY/REC and MAILING LISTS are just a few of the applications possible. Encode/Decode I provides a level of security for normal use. £39.95 complete with User Manual. Manual alone £9.95

Encode/Decode II provides enhanced security for the most demanding needs. £79.95 complete with User Manual. Manual alone £9.95. Both versions come supplied on discette.

## BOOKS

Please order books by reference no. and title, and add 50p post & packing for each book ordered.

|       |                                                                                                             |        |
|-------|-------------------------------------------------------------------------------------------------------------|--------|
| 21168 | Active Filter Cookbook                                                                                      | £10.95 |
| 21440 | Aviation Electronics 3rd Ed.                                                                                | £ 6.75 |
| 21558 | Audio IC Op Amp Applications 2nd Ed.                                                                        | £ 5.95 |
| 21586 | Basic Programming Primer                                                                                    | £ 6.50 |
| 21554 | Boolean Algebra for Computer Logic                                                                          | £ 4.50 |
| 21447 | The 8080A Bugbook-Microcomputer Interfacing & Programming                                                   | £ 7.75 |
| 21465 | Building & Installing Electronic Intrusion Alarms                                                           | £ 3.95 |
| 21524 | The Cheap Video Cookbook                                                                                    | £ 4.50 |
| 21398 | CMOS Cookbook                                                                                               | £ 7.75 |
| 21652 | Computer Dictionary 3rd Ed.                                                                                 | £ 8.95 |
| 21650 | Computer Graphics Primer                                                                                    | £ 7.50 |
| 21693 | Computers & Programming Guides for Scientists & Engineers 3rd Ed.                                           | £11.95 |
| 21697 | 8085A Cookbook                                                                                              | £ 7.50 |
| 21539 | Design of Active Filters with Experiments                                                                   | £ 5.95 |
| 21536 | DEBUG: An 8080 Interpretive Debugger                                                                        | £ 3.75 |
| 21537 | Design of Op Amp Circuits with Experiments                                                                  | £ 5.95 |
| 21545 | The Design of Phased-Locked Loop Circuits with Experiments                                                  | £ 6.75 |
| 21686 | Design of VMOS Circuits with Experiments                                                                    | £ 5.95 |
| 21618 | Electronic Telephone Projects                                                                               | £ 4.95 |
| 21351 | How to Buy and Use Minicomputers and Microcomputers                                                         | £ 7.50 |
| 21684 | How to Program and Interface the 6800                                                                       | £10.50 |
| 21459 | How to Program Microcomputers                                                                               | £ 6.75 |
| 21127 | How to Read Schematic Diagrams 3rd Ed.                                                                      | £ 4.25 |
| 21613 | How to Use Integrated Circuits Logic Elements 3rd Ed.                                                       | £ 4.50 |
| 21634 | HWS Crash Course in Microcomputers                                                                          | £13.25 |
| 21527 | IC Converter Cookbook                                                                                       | £10.50 |
| 21695 | IC Op Amp Cookbook 2nd Ed.                                                                                  | £11.25 |
| 21416 | IC Timer Cookbook                                                                                           | £ 8.50 |
| 21546 | Interfacing & Scientific Data Communications and Experiments                                                | £ 4.50 |
| 21550 | Introductory Experiments in Digital Electronics and 8080A Microcomputer Programming and Interfacing, Book 1 | £ 9.95 |
| 21551 | Introductory Experiments in Digital Electronics and 8080A Microcomputer Programming and Interfacing, Book 2 | £ 8.25 |
| 21601 | Instrumentation: Transducers and Applications                                                               | £ 8.95 |
| 21452 | Learn Electronics Thru Troubleshooting 2nd Ed.                                                              | £ 8.25 |
| 21694 | LC Circuits                                                                                                 | £ 4.46 |
| 21542 | Logic and Memory Experiments Using TTL Integrated Circuits — Book 1                                         | £ 7.50 |

|       |                                                                     |        |
|-------|---------------------------------------------------------------------|--------|
| 21543 | Logic and Memory Experiments Using TTL Integrated Circuits — Book 2 | £ 7.50 |
| 21568 | Linear IC Principles, Experiments and Projects 2nd Ed.              | £ 7.50 |
| 21540 | Microcomputer — Analog Converter Software and Hardware Interfacing  | £ 7.25 |
| 21583 | Microcomputer for Business Applications                             | £ 6.75 |
| 21614 | Microcomputer Interfacing with the 8255 PPI Chip                    | £ 6.75 |
| 21653 | Microcomputer Primer 2nd Ed.                                        | £ 8.95 |
| 21612 | Oscilloscope. Applications & Experiments                            | £ 6.75 |
| 21635 | 99 Practical Electronics Projects 2nd Ed.                           | £ 3.75 |
| 21599 | Practical Low-Cost IC Projects 2nd Ed.                              | £ 3.50 |
| 21557 | Practical RF Communication Data for Engineers and Technicians       | £ 6.75 |
| 21651 | Programming and Interfacing the 6502                                | £10.50 |
| 21482 | Regulated Power Supplies 2nd Ed.                                    | £ 7.50 |
| 21419 | Security Electronics 2nd Ed.                                        | £ 4.50 |
| 21541 | 8080/8085 Software Design                                           | £ 7.25 |
| 21615 | 8080/8085 Software Design — Book 2                                  | £ 7.50 |
| 21656 | 6502 Software Design                                                | £ 7.50 |
| 21621 | Solar Heating                                                       | £ 5.25 |
| 21587 | The S-100 and Other Microbuses                                      | £ 4.50 |
| 21628 | TEA: An 8080/8085 Co-Resident Editor/Assembler                      | £ 6.75 |
| 21538 | The 555 Timer Applications Source-Book with Experiments             | £ 4.50 |
| 21633 | TRS-80 Interfacing                                                  | £ 6.75 |
| 21035 | TTL Cookbook                                                        | £ 7.25 |
| 21103 | Troubleshooting with the Oscilloscope 3rd Ed.                       | £ 4.50 |
| 21313 | TV Typewriter Cookbook                                              | £ 7.50 |
| 21339 | Video Security Systems                                              | £ 5.25 |
| 21521 | Video Tape Recorders                                                | £ 7.50 |
| 21682 | Z80 Microcomputer Design Projects                                   | £ 9.75 |
| 21609 | Z80 Microprocessor Programming and Interfacing — Book 1             | £ 8.25 |
| 21610 | Z80 Microprocessor Programming and Interfacing — Book 2             | £ 9.75 |

## MICROCHIPS AT MICRO PRICES

| DIL SWITCHES |      | LOW PROFILE SOCKETS BY TEXAS |     |        |     | SALE   |     |
|--------------|------|------------------------------|-----|--------|-----|--------|-----|
| 4 pole       | 99p  | 8 pin                        | 7p  | 18 pin | 15p | 24 pin | 22p |
| 6 pole       | 115p | 14 pin                       | 9p  | 20 pin | 18p | 28 pin | 25p |
| 8 pole       | 140p | 16 pin                       | 10p | 22 pin | 22p | 40 pin | 28p |
| 10 pole      | 175p |                              |     |        |     |        |     |

|        |     |         |     |         |      |         |      |
|--------|-----|---------|-----|---------|------|---------|------|
| 74LS00 | 18p | 74LS42  | 56p | 74LS138 | 69p  | 74LS245 | 325p |
| 74LS01 | 12p | 74LS47  | 78p | 75LS151 | 75p  | 74LS251 | 120p |
| 74LS04 | 15p | 74LS48  | 85p | 74LS153 | 75p  | 74LS257 | 110p |
| 74LS08 | 20p | 74LS49  | 99p | 74LS155 | 65p  | 74LS290 | 95p  |
| 74LS10 | 19p | 74LS73  | 30p | 74LS161 | 78p  | 74LS293 | 120p |
| 74LS11 | 30p | 74LS74  | 30p | 74LS163 | 90p  | 74LS366 | 57p  |
| 74LS12 | 30p | 74LS75  | 39p | 74LS164 | 90p  | 74LS373 | 170p |
| 74LS14 | 60p | 74LS86  | 39p | 74LS168 | 190p | 74LS374 | 170p |
| 74LS15 | 38p | 74LS90  | 40p | 74LS174 | 99p  | 74LS375 | 140p |
| 74LS20 | 19p | 74LS107 | 40p | 74LS175 | 99p  | 74LS377 | 188p |
| 74LS30 | 19p | 74LS123 | 69p | 74LS195 | 87p  | 74LS393 | 135p |
| 74LS32 | 25p | 74LS125 | 50p | 74LS221 | 110p | 74LS490 | 140p |
| 74LS40 | 26p | 74LS132 | 79p | 74LS244 | 175p | 74LS670 | 260p |

| SUPPORT DEVICES | KEYBOARD ENCODER | DEVELOPMENT MODULE |
|-----------------|------------------|--------------------|
| 6920            | AY-5-2376        | Z800 DM            |
| 6522            | 795p             | £1099              |
| 6522            |                  |                    |
| 6551            |                  |                    |
| 6810            |                  |                    |
| 6820            |                  |                    |
| 6821            |                  |                    |
| 6850            |                  |                    |
| 6852            |                  |                    |
| 8212            |                  |                    |
| 8214            |                  |                    |
| 8216            |                  |                    |
| 8224            |                  |                    |
| 8228            |                  |                    |
| 8251            |                  |                    |
| 8253            |                  |                    |
| 8255            |                  |                    |
| 8257            |                  |                    |
| 8259            |                  |                    |
| MC 144 12VL     |                  |                    |
| Z80 P10         |                  |                    |
| Z80 CTC         |                  |                    |
| Z80A P10        |                  |                    |
| Z80A CTC        |                  |                    |
| Z80 DMA         |                  |                    |
| Z80A DMA        |                  |                    |
| Z80 S10/1       |                  |                    |
| Z80A S10/1      |                  |                    |
| Z80 S10/1       |                  |                    |
| Z80A S10/1      |                  |                    |
| Z80 S10/2       |                  |                    |
| Z80A S10/2      |                  |                    |

## STEREO!

### S100 SOUND COMPUTER BOARD!

At last, an S-100 Board that unleashes the full power of two unbelievable General Instruments AY-3-8910 NMOS Computer sound IC's. Allows you under total computer control to generate an infinite number of special sound effects for games or any other program. Sounds can be called in BASIC, ASSEMBLY LANGUAGE etc.

### KIT FEATURES

- \* Two GI Sound computer IC's (AY-3-8910)
- \* Four parallel I/O ports on Board
- \* Uses on Board audio Amps or your STERO
- \* On Board proto typing area
- \* All sockets, parts and hardware are included
- \* PC Board is soldermasked, silk screened with gold contacts
- \* Easy, quick and fun to build, with full instructions
- \* Uses programmed I/O for maximum system flexibility
- \* Both BASIC and ASSEMBLY language programming examples are included

COMPLETE KIT . . . ONLY £59.95 includes 60 page data Manual

BARE BOARD . . . ONLY £25.00 includes 60 page data Manual

AY-3-8910 chip special price with purchase of BARE BOARD (2 chips) £15.

### SOFTWARE

SCL is now available! Our Sound Command Language makes writing Sound Effects programs a SNAP! SCL also includes routines for Register-Examine-Modify, Memory-Examine-Modify and Play-Memory. SCL is available on CP/M compatible diskette or 2708/2716. Diskette — £19.95, 2708 — £14.95 2716 — £24.95. Diskette includes the source. EPROM'S are ORG at E000H.

### INTERFACE LINEAR

|           |      |
|-----------|------|
| MC1488    | 90p  |
| MC1489    | 90p  |
| DM8123    | 125p |
| 75150     | 125p |
| 75154     | 125p |
| 75182     | 195p |
| 75322250p | 250p |
| 75324     | 325p |
| 75325     | 325p |
| 75361     | 350p |
| 75365     | 295p |
| 75451     | 50p  |
| 75491/2   | 75p  |
| 8726      | 175p |
| 8728175p  | 175p |
| 8795      | 175p |
| 8797      | 175p |

### UARTS

|            |      |
|------------|------|
| AY-5-1013A | 325p |
| AY-3-1015D | 398p |
| IM6402 IPL | 425p |

### MEMORIES

|      |          |          |
|------|----------|----------|
| 2114 | 300 NS   | 275p     |
| 4116 | 900 NS   | 300p     |
| 4116 | 150 NS   | 395p     |
| 4315 | (4k x 1) | 450 NS   |
|      |          | 995p     |
| 6514 | (1k x 4) | CMOS RAM |
|      | 450 NS   | 795p     |

### CHARACTER GENERATOR

|              |      |
|--------------|------|
| RO-3-2513 UC | 450p |
|--------------|------|

### BIPOLAR PROMS

|       |         |       |        |
|-------|---------|-------|--------|
| 93448 | 512 x 8 | 40 NS | p.o.a. |
| 93453 | 1k x 4  | 40 NS | p.o.a. |
| 93451 | 1k x 8  | 45 NS | p.o.a. |
| 93511 | 2k x 8  | 50 NS | p.o.a. |

### EPROMS

|       |            |
|-------|------------|
| 1702A | 450p       |
| 2708  | 450 NS     |
| 2716  | 5V 450 NS  |
| 2532  | 32k 450 NS |
|       | 2995p      |

# MICRO BYTE

Dept. PCW2 Unit 9-10, 1st Floor, E Block, 36 Mount Pleasant, London WC1X 0AP. Telephone: 01-278 7369/01-837 1165 Telex: 895 3084

Ordering information. Unless otherwise stated, for orders under £50 add 50p p&hp. Add 15% VAT to total (no VAT on books). All devices are brand new, factory prime and full spec and subject to prior sales and availability. Prices subject to change without notice. Minimum telephone order using ACCESS is £10. If ordering by post with ACCESS, include name, address and card no. written clearly. Please allow 4/6 weeks delivery on books.



# Everything for OSI...

The superior Superboard...

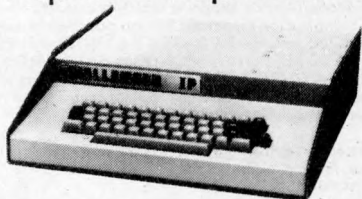

Ohio Scientific's Superboard has been around for some time now — a superb introduction to small computing. Mutek now offer the superior Superboard — the same superb BASIC, the same keyboard, utterly reliable cassette interface and other features, but modified to run at double the standard speed and with more than double the standard display: 32 lines of 48 characters. More than twice the execution speed for BASIC than Commodore's Pet®; twice the display area of the UK101. The superior Superboard — a superbly practical small computer.

**Enhanced C1 (C1E) ..... £255**  
Complete with power supply, metal case and 4K user memory.

**Superboard E ..... £195**  
Uncased version of C1E.

Upgrade service or kit to convert existing Superboard, C1 or UK101 systems to Mutek's enhanced specification (ask for details) .. **£40**

All prices quoted exclude VAT.

a superior monitor...

CEGMON, 'the best thing for OSI systems since OSI itself', is now available! CEGMON is a new monitor PROM for all Ohio Scientific BASIC-in-ROM systems (Superboard/C1, C2 and C4 series) and UK101, written by the organisers of the OSI UK User Group. It gives these systems the kind of features that only appear on machines at least twice the price — a full screen editor, an incredibly versatile screen-handling system, a built-in expanded machine-code monitor, and much more.

□ **Full screen editing** — more flexible than simple line editing, the built-in twin-cursor screen editor allows you to edit, combine, copy or renumber program lines or text, copying from anywhere on the screen.

□ **Advanced display features** — all output to the screen display can be directed through 'windows' whose position, height and width are all user-definable, and can be changed within programs quickly and easily. The 'window' format allows free mixing of text and graphics; protected non-scrolling areas; and sophisticated use of multiple scrolling and non-scrolling zones. 'Window' - and screen-clear routines and cursor-positioning controls; text is printed from the top of the current 'window'. Probably the most flexible screen-handling system available today, it offers a whole new world in small-computer display.

□ **Machine-code support** — memory 'modify' allows entry of text or graphics as well as hex instructions; tabular hex display of memory contents; breakpoint handler; complete load and save routines.

□ **and more!** — revised keyboard routine for word-processing use; user-definable input/output; OSI-compatible floppy-disc bootstrap on Superboard/C1, C1E and UK101 versions.

All this packed into a single replacement PROM! Versions available for standard Superboard/C1; Mutek's enhanced Superboard/C1; OSI C2 and C4 series (cassette only); and UK101. Further details available on request; please specify version required when ordering.

**Price: £29.50** includes full documentation and reference card.

**Mutek** — improving personal computing...for less than you expect

Mutek — the independent Ohio Scientific specialists — Quarry Hill, Box, Wilts. Tel: Bath (0225) 743289



## AS RECOMMENDED BY COMPUTING TODAY — THE CENTRONICS 'MICRO-PRINTER'

Ask most people what they would like as their first peripheral and the chances are they will say "Printer". Here is an attractive electrostatic printer from the famous firm of Centronics. Capable of printing in three sizes of typeface it is easily attached to your machine by way of the parallel interface. The logic is fully TTL compatible and STROBE, Acknowledge and Busy lines are provided to make life easy. "Cost of this wonderful peripheral is a mere **£195.00 + VAT** The printer comes complete with documentation, connector and cleaning paper as well as a roll of the printing paper." (extract from COMPUTING TODAY).

**Ex-STOCK from HENRY'S**  
Ideal for PETS-TANDY-NASCOM's

### Specification

- 150 lines per minute
- Selectable 20 40 80 columns
- 120 m/m aluminium — Finish paper unaffected by Heat, Light or Humidity.
- Full character ASC II set.
- Paper Feed, 220-240AC mains.
- On-Off Print Select.
- Paper Advance — Empty Controls.
- Size 10½ x 13½ x 4½" Weight 10lbs

Ideal for Home or Small Business use.

**LIMITED QUANTITY DON'T DELAY**

Brand new boxed fully guaranteed list price of this machine. **£459.95 inc. VAT.**

OUR PRICE

**£195.<sup>00</sup> plus VAT**

POST PAID



**CENTRONICS**  
QUICK PRINTER

Complete with Full documentation connector & Printing Paper —

**HALF PRICE OFFER**

Just Plug in and it's ready to go!

AS RECOMMENDED BY "COMPUTING TODAY" MARCH/MAY 1980

Your London & National Nascom Distributor.  
Export Orders deduct VAT, but add 5% carriage  
Official Export & Educational Orders welcome  
Our Telex 262284 Mono Ref. 1400 Transonics

**COMPUTER SEND**  
**BROCHURE 15p**  
**FREE STAMP**



**Henry's**

Computer Kit Division  
404 Edgware Road, London, W2, England  
01-402 6822



# PRINTER SUPERMARKET

# COMPLETE SYSTEMS

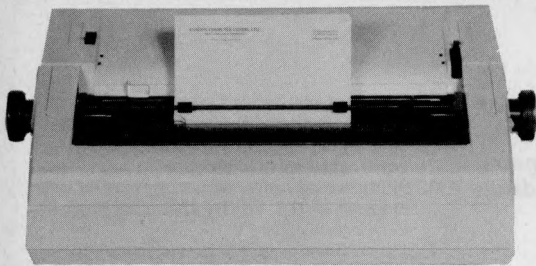

## 60 CHARACTERS PER SECOND RICOH RP-1600 THE FASTEST DAISY WHEEL PRINTER. £1320

FAST, heavy duty commercial DAISY WHEEL printer, with high quality printout, coupled with low noise necessary for office environment. Nationwide service by NEXOS. 90 day warranty provided at your premises.

124 char: upper/lower case, \* 10/12 chars: per inch giving 126 or 163 columns. \* 15 inch wide frintion platen. \* /reverse Top of the form, BOLDING, underline, and host of other features. \* Centronics type parallel interface as standard. options: serial interface 60 \* PET interface 65 \* APPLE interface 75.

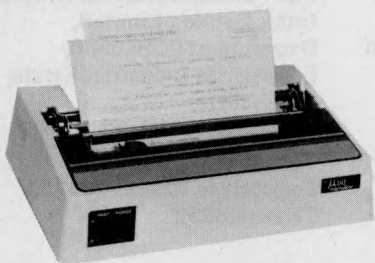

## OKI MICROLINE 80/132. THE QUIET PRINTER YOU CAN LIVE WITH £495

THE QUIETEST DOT MATRIX AVAILABLE. 40, 80, OR 132 COLS PER LINE \* EXCELLENT PRINT QUALITY \* 3 WAY PAPER HANDLING: LETTERHEADS, FANFOLD, OR PAPER ROLLS \* GRAPHICS \* IDEAL FOR SOFTWARE WRITTEN FOR LARGE 132 COL PRINTERS \* CONTINUOUS RATING PRINTING DAY IN AND DAY OUT \* CENTRONICS PARALLEL STANDARD. OPTIONS: RS-232, PET, APPLE. DEALER ENQUIRIES INVITED

## NEW MAXI ANADEX WITH GRAPHICS £895

Takes up to 13.5 inch wide paper \* Upper/lower case with decenders \* £ sign \* 132 or 175 chrs/line with double width printing \* Fast 150 CPS bi-directional logic seeking printing \* Heavy duty print head giving 650 million chrs print life \* serial, Parallel and Current Loop interfaces built in \* Host of other features found on printers costing twice as much.

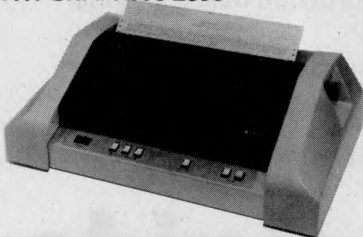

## EPSON TX-80 £395

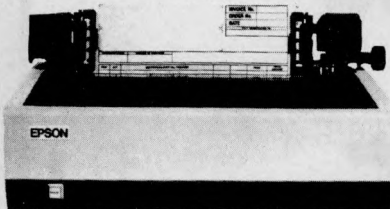

DOT-MATRIX PRINTER PET GRAPHICS. PRINTS 80 COLUMNS ON PLAIN RAPER AT 90 CHARACTERS/SECOND. ADJUSTABLE TRACTOR \* UPPER/LOWER CASE \* DOUBLE WIDTH PRINTING \* MICRO CONTROLLED \* SELF TEST \* HEAVY DUTY PRINT HEAD USING JEWELL BEARINGS FOR LONG LIFE \* MADE BY SHINSHU SEIKI AN AFFILIATE OF SEIKO WATCH CO OF JAPAN. INTERFACE: CENTRONICS PARALLEL, OPTIONS: PET, APPLE, AND SERIAL.

## ANADIX DP-8000 NEW LOW PRICE £475

FAST 112 CHARACTERS PER SECOND \* BOTH RS-232, AND CENTRONICS PARALLEL INTERFACES BUILT IN \* UPPER/LOWER CASE WITH £ SIGN

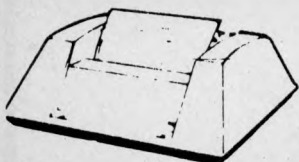

## NEW TRS-80 MODEL 1 48K SYSTEM WITH DUAL DISC DRIVES. £1250

NEW GREENSCREEN VDU, WITH ROCK STEADY DISPLAY, REDESIGNED 32K EXPANSION INTRFACE WITH TROUBLE FREE DISC OPERATION, TWO 40 TRACK TEAC DISC DRIVES, COMPLETE WITH CABLES. TRIDATA SALES, PURCHASE, INVOICING, PAYROLL PACKAGES AVAILABLE.

WITH DESK AND EPSON PRINTER £1750

## NEW SUPER BRAIN DUEL DENSITY £1875/QUAD DENSITY £2250



NOW WITH CP/M 2.2, & INCREASED DISC STORAGE. TWIN Z80-A 1MHZ \* 2 DISC DRIVES, DUAL DENSITY 320 K QUAD DENSITY 700 K STORAGE \* 64 K RAM \* HIGH RESOLUTION 12 INCH CRT. 80 x 24 LINES UPPER/LOWER CASE \* 2 RS-232 PRINTER PORTS \* CPM 2.2 OPERATING SYSTEM \* MBASIC, COBOL, FORTRAN, PASCAL, WORD PROCESSING & ACCOUNTS PACKAGES AVAILABLE. DEALER ENQUIRIES INVITED

## TRS-80 MODEL £1999



STATE OF THE ART SECOND GENERATION COMPUTER. OVER 10,000 ALREADY SOLD IN USA, 8 SLOT BUS ENSURES EXPANSION OF HARD DISCS & OTHER PERIPHERALS., 76 Key professional keyboard, self test on POWER UP. TRSDOS & LEVEL III BASIC STANDARD. CP/M AVAILABLE AS OPTION, making a wide range of accounting, educational, scientific & word processing packages instantly usable. NATIONWIDE SERVICE THROUGH 180 TANDY STORES & COMPUTER CENTRES.

## LOW COST WORD PROCESSOR I

BASED ON TRS-80 LEVEL 2 16K, CASSETTE RECORDER, ELECTRIC PENCIL SOFTWARE, UPPER/LOWER CASE MOD, PRINTER INTERFACE AND OKI DOT MATRIX PRINTER. COMPLETE READY TO GO £1095. FREE MAILING LIST PROGRAM. WORD PROCESSOR II SAME AS ABOVE BUT WITH 48K, 2 DISC DRIVES AND RICOH DAISY WHEEL PRINTER £2575

## WORD PROCESSOR III

BASED ON SUPERBRAIN COMPUTER SHOWN ABOVE. WITH RICOH PRINTER & "MAGIC WAND" THE ULTIMATE IN WORD PROCESSING. LETTERS AUTOMATICALLY FORMATTED WITH ADDRESSES FETCHED FROM SEPARATE FILE. COMPLETE SYSTEM £3395 INVOICING, STOCKCONTROL, SALES LEDGER, PURCHASE LEDGER, PAYROLL AVAILABLE FOR ABOVE COMPUTERS. FROM £250 PER PACKAGE.

PRICES QUOTED ABOVE DO NOT INCLUDE VAT. PHONE OR CALL FOR FURTHER DETAILS OR DEMONSTRATIONS.

**LONDON COMPUTER CENTRE LIMITED**  
43, GRAFTON WAY, OFF TOTTENHAM COURT ROAD, LONDON W1  
TEL: 01-388 5721 OPENING HRS: 11-7 MON-FRI, 12-4 SATS.

MICRO SYS LTD  
58 HIGH STREET  
PRESCOTT  
MERSEYSIDE

TEL: 051 426 7271

NOTHERN DEALERS

HORIZON SOFTWARE LTD  
REGENT HOUSE  
16 WEST WALK  
LEICESTER LE1 7NG TEL 0533 556550

# Intex DATALOG LTD COMPUTERS

**LATEST!**  
**MICROPAY-200**  
*the complete  
Payroll System  
for  
PET*

**Micropay-200 is a complete payroll System designed to run on a COM-MODORE 32K PET microcomputer, interfaced to dual floppy disk drives and a printer.**

The System provides:

1. Weekly/monthly payslips
2. Summary page of all payments and deductions that month
3. Summary page of all payments and deductions for the tax year to date
4. Weekly/monthly cash analysis slip for all cash payments made
5. Monthly summary of all payments and deductions
6. Year end summary of all payments and deductions

The System copes with:

1. Up to 200 current employees, plus end of the year details of up to a further 400 ex-employees who have left during the year
2. Suffix L,H,P,V and T cumulative and Week 1 Codes
3. Prefix D and prefix F, BR and NT codes
4. All necessary alterations concerned with changes in income tax rates, band widths and personal allowances

5. National Insurance Contributions at rates A, B and C for contracted out employees and at rates D and E for non-contracted out employees
6. All necessary alterations concerned with changes in N.I. contribution rates and earnings limits
7. Up to 5 user-definable wage rates for each employee, plus the normal hourly rate
8. Holiday pay — including a check on the amount of holiday taken in the year
9. Up to a total of 5 user-definable additions/additions/deductions to the before/after tax pay
10. Changing an employee from one N.I. rate to another and backdating such a change
11. Job costing and analysis

**For Full Specification write to:—  
Intex Datalog Limited,  
Department PCW-0980,  
Eaglescliffe Industrial Estate,  
Eaglescliffe,  
Cleveland, TS16 0PN.**

**Telephone  
Eaglescliffe (0642) 781193  
Telex: 58252**

# Intex

Tired of trying to figure out how to make North Star BASIC do what you want?

Waiting to see if you can learn to program before buying a computer?

Need someone to "translate" the user's manuals for you?  
Totally confused and frustrated?

The solution is—

## **The User's Guide to North Star BASIC**

**£10.00**

The essential book for anyone working with North Star BASIC.



L.P. ENTERPRISES  
8 Cambridge House, Cambridge Road  
Barking, Essex 1G11 8NT, England  
Tel: 01-591 6511 Telex: 892395

Mail order, credit card orders welcome. Trade enquiries welcome.

# CHROMASONIC electronics

56 FORTIS GREEN ROAD MUSWELL HILL LONDON N10 3HN  
 TELEPHONE 01-883 3705 01-883 2289

*your soundest connection in the world of components*

## PETS

2001-8N (8K RAM)  
**£399**

2001-16N (16K RAM) **£499**  
 2001-32N (32K RAM) **£599**

**ALL WITH NEW KEYBOARD AND GREEN SCREEN.**

### PERIPHERALS

Service & Assistance available  
 Interfaces available are:  
 X-Y plotters, analogue to digital converter, 16 channel interfaces, bi-directional interfaces, etc.

EXTERNAL CASSETTE DECK SUITABLE FOR ALL PETS **£55**



## MEMORY

| D. RAMS       | £ p.  |
|---------------|-------|
| 4027          | 2.75  |
| 4050 (350NS)  | 2.35  |
| 4060 (300NS)  | 2.39  |
| 4116          | 4.35  |
| S. RAMS       |       |
| 2102A         | 1.09  |
| 2102A-2       | 1.09  |
| 2112A         | 2.25  |
| 21L02         | 98    |
| 2114-4045     | 2.95  |
| 4035          | 1.07  |
| 4044-5257     | 6.93  |
| BULK PURCHASE |       |
| 8 2114        | 22.50 |
| 8 4116        | 29.95 |
| 8 21L02       | 7.00  |
| BULK PURCHASE |       |
| 16 2114       | 39.95 |
| 16 21L02      | 13.00 |
| 32 21L02      | 25.00 |
| 64 21L02      | 45.00 |

## UK101

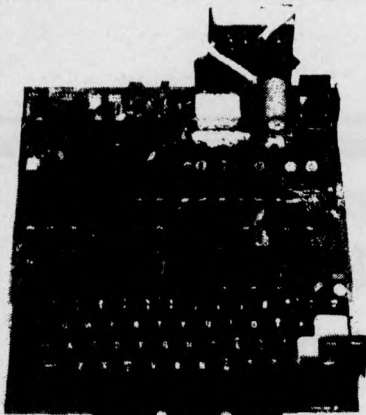

**£179** in kit form  
**£229** ready built & tested  
**£249** complete in case

NO EXTRAS REQUIRED  
 \* FREE SAMPLER TAPE  
 \* FULL QWERTY KEYBOARD  
 \* 8K BASIC  
 \* RAM EXPANDABLE TO 8K ON BOARD (4K INC)  
 \* KANSAS CITY TAPE INTERFACE

\* New monitor allows full editing & cursor control.

**£22**

INVADER  
 TAPE  
**£5.00**

ASSEMBLER  
 EDITOR  
 TAPE  
**£14.95**

## EPRON'S

|           |       |
|-----------|-------|
| 2708      | 4.95  |
| 2716 (5v) | 13.95 |
| 2532      | 39.95 |

## ROM'S

|          |      |
|----------|------|
| 2513(UC) | 5.95 |
| 2513(LC) | 5.95 |

## CPU'S

|      |       |
|------|-------|
| 6502 | 9.50  |
| 8080 | 4.75  |
| 9900 | 25.95 |
| 6800 | 5.90  |
| Z80  | 8.95  |

## BUFFERS

|         |      |
|---------|------|
| 81LS95  | 1.25 |
| 81LS96  | 1.25 |
| 81LS97  | 1.25 |
| 81LS98  | 1.25 |
| SN74365 | 52   |
| SN74366 | 52   |
| SN74367 | 52   |
| SN74368 | 52   |
| 8T26    | 1.75 |
| 8T28    | 1.75 |
| 8T95    | 1.57 |
| 8T96    | 1.57 |
| 8T97    | 1.50 |
| 8T98    | 1.57 |

## LATEST STOP PRESS AND PRICE LIST

SEND SAE OR PHONE FOR UP TO DATE **PRICES** OF ALL OUR RANGE OF ITEMS STOCKED

### CASES

Available for UK101, Superboard, NASCOM.  
 Approx. dim. 17" x 15"  
 435mm x 384mm  
**Price £24.50**  
 Post and packing £1.50

### TAPES

Unique stackable tape storage unit. Interlocking drawers. 5 drawers each containing 2 C12 tapes.  
 10 drawers **£9.50**  
 5 drawers **£5.25**  
 Single drawer **£1.10**

### MEMORY EXPANSION KIT

Suitable for UK101, Superboard expansion using 2114's. Each board has 16K RAM capacity.

Kit contains:

- \* On board power supply
- \* 4K EPRON expansion
- \* Fully buffered for easy expansion via 40 pin socket

**\* 8K KIT £99.95**

**\* 16K KIT £139.90**

### BAUD RATE GENS

|         |      |
|---------|------|
| MC14411 | 8.75 |
| MM5307  | 8.75 |

### UARTS

|           |      |
|-----------|------|
| AY-5-1013 | 3.45 |
| AY-5-1015 | 3.98 |
| MM5503    | 4.75 |
| 6011      | 3.55 |

## PRINTERS

**TX-80 £395**

**EPSON TX-80 £395**

Dot-matrix printer with Pet graphics Interface:  
 Centronics parallel,  
 options: PET, Apple and serial.

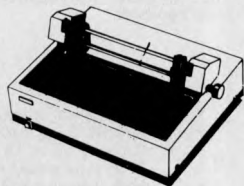

**PLEASE ADD VAT 15% TO ALL PRICES. POSTAGE ON COMPUTERS, PRINTERS & CASSETTE DECKS CHARGED AT COST. ALL OTHER ITEMS P&P 30p. PLACE YOUR ORDER USING YOUR ACCESS OR BARCLAYCARD (Min. Tel. order £5.00). TRADE & EXPORT ENQUIRIES WELCOME, CREDIT FACILITIES ARRANGED.**



\*AS REVIEWED IN JULY PERSONAL COMPUTER WORLD AND JULY PRACTICAL COMPUTING\*

# A Microcomputer in your pocket?



- \* Basic programming language
- \* Cassette interface
- \* 24 character LCD display
- \* Non volatile programme memory
- \* 300 hour battery life
- \* 3 manuals
- 100 page instruction manual,
- 50 page beginners basic manual.
- 300 page application manual.
- \* £139.95 complete with cassette interface including VAT, postage packing and insurance.

PC-1211  
FROM



## CENTRAL CALCULATORS LTD

86/90 Paul Street London  
EC2A 4NE  
01-729 5588

Make cheques payable to Central Calculators Ltd.

Please send me PC-1211 complete with CE-121

More details

Name .....

Address .....

.....

## THE ZX80 COMPANION Second edition

ISBN 0 907211 00 3 Price £10.00

This best-selling book on the Sinclair ZX80 has now been extended to include extra sections on the ZX80 monitor with entry addresses, new programs, and an amplified coverage of ZX80 BASIC. Send a £10.00 cheque (including P & P) to LINSAC.

## Sinclair ZX80 Software

The new Autumn catalogue of Sinclair-tested educational and games programs is now available. Send SAE for your copy.

### LINSAC

68 Barker Road, Middlesbrough  
TS5 5ES

## Erase Eproms in 8 minutes for under £100

£97 delivered in U.K.  
+ V.A.T.

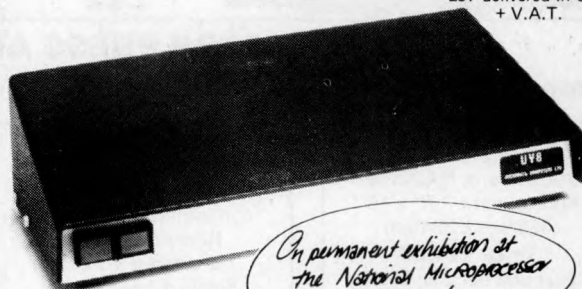

The high speed, high capacity model UV8 sets new performance and price standards.

- Cuts typical erasure times by a factor of 5
- 8 MINUTE SOLID STATE TIMER
- Capacity up to 14 EPROMS
- 2708 type erased in 4 to 7 minutes
- High intensity 254 NM UV source
- Safety interlock automatically starts timing sequence
- Audio tone signals erasure cycle complete
- Internal switch to extend erase time.

MICRODATA Computers Ltd, Belvedere Works, Bilton Way, Pump Lane Industrial Estate, Hayes Middlesex.

Telephone (01) 848 9871 (6 lines)

Telex 934110

# SUPERBRAIN™



## System Specification

- \* Dual 4MHz Z-80 C.P.U.s
- \* Dual double-density mini-floppies (320K bytes)
- \* Dynamically focused 12 inch CRT
- \* 25 lines by 80 characters  
8 x 8 in 8 x 12 field

**£1495**

**COMPLETE (+ VAT)**

**\* OUR PRICE IS THE R.R.P.**

- \* Full ASCII keyboard
- \* S-100 Bus via direct connection
- \* Dual synchronous/asynchronous RS 232 ports
- \* CP/M<sup>(tm)</sup> operating system
- \* Single desk top unit

### SOFTWARE SUPPORT

- Wide range of standard software (FORTRAN, COBOL, BASIC, APL, Pascal). Sales Order processing, invoicing, sales ledger, purchase ledger, nominal ledger, payroll, Word Star (word processing).
- 90 day warranty
- One year maintenance **£155.00**
- Full client support

**K.G.B. MICROS LTD.  
88 HIGH STREET  
SLOUGH, BERKSHIRE  
TEL. SLOUGH 38581**

**SUPERBRAIN™** is the registered trademark of Intertec Data Systems.

# PROGRAMMER SW1

**Commercial experience unnecessary.  
Sound knowledge of BASIC essential.**

**Do you gain satisfaction from writing elegant, reliable programs which utilise system resources efficiently?**

**Do you want to become a member of a small growing team developing application programs within a progressive professional firm?**

We have Hewlett Packard 3000 Series III and HP2000 Access systems, running on BASIC in interpretive and compiled forms, with 180 megabytes of online storage and 20 user terminals. We can offer challenging programming fare, principally evolving new applications and extensions for our real-time database.

Please apply in writing to C. W. Jonas FRICS

# DRIVERS JONAS

Chartered Surveyors  
16 Suffolk Street  
London SW1Y 4HQ  
01-930 9731

Personal demonstrations available at all times in our new showrooms at 30 Lake Street. Also a large range of personal computers, books and magazines. Barclaycard and leasing available.



## CompUTOPIA LIMITED

30 Lake Street, Leighton Buzzard, Bedfordshire  
Tel: (0525) 376600 24 hour Answering Service.

### apple



|                                            |         |
|--------------------------------------------|---------|
| <b>SOFTWARE</b>                            |         |
| Computech Purchase Ledger                  | 295.00  |
| Computech Sales Ledger                     | 295.00  |
| Computech General Ledger                   | 295.00  |
| Computech Payroll                          | 375.00  |
| Computech Utilities                        | 20.00   |
| Plus Software from Databank and many more. |         |
| <b>HARDWARE</b>                            |         |
| Apple 16K Video Output                     | £695.00 |
| Disc Drive with Controller                 | 349.00  |
| Disc Drive w/o Controller                  | 299.00  |
| Pascal Language system                     | 299.00  |
| Integer Card                               | 116.00  |
| Eurocolour Card                            | 79.00   |

#### PERIPHERALS

|                                                    |          |
|----------------------------------------------------|----------|
| <b>PRINTERS</b>                                    |          |
| Texas Instruments Omni 8 810 Printer               | £1450.00 |
| Paper Tiger Printer with Graphics                  | 598.00   |
| <b>MONITORS</b>                                    |          |
| VM129 Hitachi 12" B&W Video Monitor                | 187.00   |
| VM910 Hitachi 9" B&W Video Monitor                 | 127.00   |
| <b>ACCESSORIES</b>                                 |          |
| Floppy Disk 5 1/4" Hard & Soft sectored pack of 10 | 30.00    |
| Floppy Disk 8" Hard & Soft sectored pack of 10     | 35.00    |
| C12 Computer cassettes pack of 10                  | 4.00     |
| Computer Stationery on request                     |          |

### ACORN

A complete range of single boards and accessories available.

|                               |        |
|-------------------------------|--------|
| System 1 Kit                  | £65.00 |
| System 1 Assembled and tested | 79.00  |
| System 2 Kit                  | 285.00 |
| System 2 Assembled and tested | 320.00 |
| System 3 Kit                  | 670.00 |
| System 3 Assembled and tested | 735.00 |

### EPSON PRINTERS



The TX-80 offers:

- 96 Ascii char. set and Pet
- 80 col 150/125 char/sec
- Condensed line, Enhanced print
- 5x7 dot matrix, 6x7 dot matrix for graphics

Prices starting from £395 including delivery

Interface boards and cables available for Pet, Apple, TRS 80. 1EEE488 and serial etc.

DEM Prices available.

### THE VIDEO GENIE SYSTEM EG 3003



At last, value for money in microcomputers.

**£425 incl VAT**

- \*16k User RAM plus 12k Microsoft BASIC in ROM
- \*Fully TRS 80 level II software compatible
- \*Huge range of software already available
- \*Self contained, cassette, PSU & UHF modulator
- \*Simply plugs into video monitor or UHF TV
- \*Full expansion capability for disks & printer

#### L.S. CHIP PRICES

|         |      |
|---------|------|
| 74LS02  | 0.22 |
| 74LS08  | 0.22 |
| 74LS10  | 0.22 |
| 74LS32  | 0.30 |
| 74LS74  | 0.50 |
| 74LS86  | 0.45 |
| 74LS93  | 0.85 |
| 74LS100 | 0.20 |
| 74LS132 | 1.15 |
| 74LS138 | 1.05 |
| 74LS175 | 1.00 |
| 74LS191 | 1.30 |
| 74LS244 | 2.65 |
| 1488P   | 0.95 |
| 1489P   | 0.95 |

#### MEMORY CHIPS

|      |       |       |
|------|-------|-------|
| 5116 | each  | 6.40  |
|      | for 8 | 48.00 |

# Keenstar

## Now the sky's the limit!



Keenstar. A great new range of exciting products that will enable you to exploit your micro to the maximum. Our reputation as one of the country's leading microcomputer consultants and supplier of leading brands is enhanced still further by this latest addition to our extensive range of micros, peripherals, software and services.

Micros such as Apple, Pet, North Star Horizon and Sharp. Fast and reliable printers from Annadex and Quom. Bespoke and packaged software. And a level of service second to none. From single applications to expandable systems. From full system design through installation, commissioning and staff training to outstanding after-sales-service.

Send off for the new Keenstar catalogue and you will see over 200 interface boards, special applications software and associated products. All designed to let you take the lid off computing. Why go elsewhere when you'll find all you need to build your microsystem under one roof. It's a roof to us, but with the advent of Keenstar there's no ceiling to your system! While you're waiting for your catalogue just browse through the tiny fraction of what is available listed below. Now that Keenstar's arrived you can really let your imagination loose.

### SI100 HARDWARE

|           |                                |        |
|-----------|--------------------------------|--------|
| K 20001 N | 450ns static RAM Board         | 241.13 |
| K 20002 N | 300ns static RAM Board         | 269.50 |
| K 20003 N | 200ns static RAM Board         | 275.00 |
| K 20004 N | 2200 Mainframe                 | 295.00 |
| K 20005 N | Wire Wrap Board                | 30.00  |
| K 20006 N | Solder Tail Board              | 30.00  |
| K 20007 N | Extender Board                 | 30.00  |
| K 20008 N | 8080 CPU Assembled             | 180.00 |
| K 20009 N | Z-80 CPU Assembled             | 220.00 |
| K 20010 N | Memory Mapped Video Interface  | 160.00 |
| K 20011 N | I/O Mapped Video Interface     | 180.00 |
| K 20012 N | 80 x 24 Video Interface (2MHz) | 295.00 |
| K 20013 N | 80 x 24 Video Interface (4MHz) | 330.00 |
| K 20014 N | 80 x 51 Upgrade (2MHz)         | 70.00  |
| K 20015 N | 80 x 51 Upgrade (2MHz)         | 70.00  |
| K 20016 N | Parallel I/O Interface         | 110.00 |
| K 20017 N | 2P + 2S I/O Interface          | 175.00 |
| K 20018 N | Music Synthesiser (4)          | 220.00 |
| K 20019 N | Prototyping Board              | 65.00  |
| K 20023 N | 2708/2716 EPROM Programmer     | 180.00 |
| K 20024 N | 4K 1702 EPROM Board            | 110.00 |
| K 20025 N | 16K 2708 EPROM Board           | 130.00 |
| K 20026 N | Active Terminator              | 55.00  |
| K 20027 N | 15 Slot Motherboard            | 140.00 |
| K 20028 N | Extender Board                 | 30.00  |

### APPLE HARDWARE

|           |                          |        |
|-----------|--------------------------|--------|
| K 11502 A | Sony Colour TV. S/colour | 349.00 |
| K 21001 A | ROM/PROM Board           | 65.00  |
| K 21002 A | Programmable Timer       | 130.00 |
| K 21003 A | BCD Analogue to Digital  | 120.00 |
| K 21005 A | Wire Wrap                | 20.00  |
| K 21006 A | Solder Tail Board        | 20.00  |

|           |                                 |        |
|-----------|---------------------------------|--------|
| K 21007 A | Extender                        | 20.00  |
| K 21008 A | Etch Board                      | 20.00  |
| K 21009 A | Asynchronous serial card        | 130.00 |
| K 21010 A | Synchronous serial card         | 130.00 |
| K 21011 A | Pl.a                            | 110.00 |
| K 21012 A | Arithmetic Processor            | 280.00 |
| K 21013 A | Lower Case Adaptor              | 55.00  |
| K 21014 A | Apple Serial/Parallel Interface | 130.00 |

### NORTH STAR SOFTWARE

|           |                    |        |
|-----------|--------------------|--------|
| K 02001 O | Word Star          | 255.00 |
| K 02002 O | Wordmaster         | 75.00  |
| K 02003 O | Supersort I        | 125.00 |
| K 02004 O | Supersort II       | 105.00 |
| K 02005 O | Supersort III      | 75.00  |
| K 02006 O | Whatsit? (N. Star) | 95.00  |
| K 02007 O | Whatsit? (CP/M)    | 125.00 |
| K 02008 O | CP/M               | 95.00  |

### PET SOFTWARE

|           |                         |       |
|-----------|-------------------------|-------|
| K 03001 O | 6502 Assembler          | 20.00 |
| K 03002 O | Microchess              | 15.00 |
| K 03004 O | Gammon Gambler          | 15.00 |
| K 03005 O | Time Trek               | 15.00 |
| K 03006 O | Graphics Pak            | 15.00 |
| K 03007 O | Stimulating Simulations | 15.00 |
| K 03008 O | Bridge Partner          | 15.00 |

### PRINTERS

|           |                |         |
|-----------|----------------|---------|
| K 01030 P | Anadex DP 8000 | 575.00  |
| K 1083 P  | Quome 45 RO    | 2280.00 |

### APPLE BUSINESS SOFTWARE

|           |                     |       |
|-----------|---------------------|-------|
| K 01137 B | Visi Calc           | 95.00 |
| K 01176 B | Desktop Plan        | 95.00 |
| K 01182 B | CCA Data Management | 95.00 |

|           |                        |        |
|-----------|------------------------|--------|
| K 01183 B | Whatsit?               | 99.00  |
| K 01186 B | Easy Writer - Original | 95.00  |
| K 01885 B | Easy Writer Pro        | 180.00 |

### TERMINALS

|           |                           |         |
|-----------|---------------------------|---------|
| K 11711 T | Cifer (Wordstar terminal) | 1150.00 |
|-----------|---------------------------|---------|

### APPLE SOFTWARE

|           |                               |       |
|-----------|-------------------------------|-------|
| K 01136 S | Apple-Pip (disc Doctor-Apple) | 95.00 |
| K 01138 S | Microchess                    | 15.00 |
| K 01138 S | Warlords (tape)               | 7.00  |
| K 01139 S | Bridge Challenger             | 15.00 |
| K 01178 S | Checker King                  | 15.00 |
| K 01179 S | Gammon Gambler                | 15.00 |
| K 01180 S | Bridge Partner                | 15.00 |
| K 01181 S | Stimulating Simulations       | 10.00 |
| K 01184 S | Apple-Doc                     | 20.00 |

5b the Poultry, Nottingham NG1 2HW  
tel: 0602 583254  
telex: 37297 (keenco)

28 Lower Addiscombe Road  
Croydon CRO 6AA  
tel: 01-680 4646



**Keen Computers**

Please rush me the new Keenstar catalogue.

Name \_\_\_\_\_

Position \_\_\_\_\_

Organisation \_\_\_\_\_

Address \_\_\_\_\_

PCW SEPT.

# KNIGHT'S T.V. & COMPUTERS

108 Rosemount Place, Aberdeen.  
Tel: (0224) 630526. Telex: 739169.

## Free Toolkit from Sharp's big dealer

Dear Microfans,

Since our letter in August we have created the 'SHARP TOOLKIT' which adds eight new commands *within* the Sharp 14K Basic. These include auto line numbering, auto block delete, append - to join Basic programs together, PRING/S which outputs all the screen contents to the printer, auto renumbering, and trace which displays the line number being executed while the program runs (trace includes a single step feature).

Our 'Sharp Toolkit' will be supplied free with all orders for Sharp MZ-80K micros.

Our prices (now £439 for the 24K model and £499 for the 48K model) include free Red Star - next day-delivery, one year's full guarantee including all transportation, our famous 50 free programs, membership of the Sharp User Group and our new Sharp Toolkit'.

The latest International Sharp User Group Newsletter (£3 if you bought your MZ-80K elsewhere) has all the latest news on the i/O board, the Disk system, the colour board, etc etc.

We use the Sharp every day in our own business and will in association with PYE be doing a one day seminar at Leeds demonstrating our diagnostic servicing techniques to TV dealers. We will also be doing a personal users presentation at Leeds on the evening of 19th. November, write if you would like to attend.

Happy computing,  
Graham Knight

P.S. We have sold a number of machines to France, Holland Belgium. Export customers do not add VAT to the above prices but those of you in the UK remember to smile as you calculate Maggie's extra.



## Every TRS 80 & Video Genie owner should have a copy...

LEVEL IV BASIC  
LEVEL III UPGRADE  
EDITOR, ASSEMBLER AND DEBUGGER  
SYSTEM MASTER MONITOR  
SYSTEM CREATE  
ASCERTAIN  
COPY  
WORD PROCESSOR  
DATA FILE  
MICRO TEST  
PLUS SOUND

PROGRAMS FOR BASIC PROGRAMMERS:  
RESCUE : DOUBLE-UP : BYTE SAVER  
MERGER : DELAY : RE-NUMBER

FOR USE WITH PRINTERS:  
SCREEN PRINT : LPRINT : TYPEWRITER  
REPEAT : DE-SLASH

PLUS LOADS OF GAMES WITH FULL GRAPHICS  
ALL AT TWO FOR THE PRICE FOR ONE

PLUS EXTRA SPECIAL OFFERS



And don't forget we operate a first class return of post service and every program recorded to suit both low to medium and medium to high output cassette systems!

# Kansas

Kansas City Systems, Unit 3, Sutton Springs Wood, Chesterfield, Derby Tel 0246 850357

# creative computing

## Basic Computer Games

Edited by David Ahl, this book contains 101 imaginative and challenging games for one, two, or more players — Basketball, Craps, Gomoko, Blackjack, Even Wins, Super Star Trek, Bombs Away, Horserace. Simulate lunar landings. Play the stock market. Write poetry. Draw pictures.

All programs are complete with listing in Microsoft Basic, sample run and description. Basic conversion table included. 125,000 copies in print. 192 pages softbound. [6C] £ 4.25



## More Basic Computer Games

Contains 84 fascinating and entertaining games for solo and group play — evade a man-eating rabbit, crack a safe, tame a wild horse, become a millionaire, race your Ferrari, joust with a knight, trek across the desert on your camel, navigate in deep space.

All games come complete with program listing in Microsoft Basic, sample run and description. 192 pages softbound. [6C2] £ 4.25



## The Best of Creative Computing

The first three years of Creative Computing magazine have been edited into three huge 324-page books full of programs, tutorials, programming techniques, reviews of books and equipment, articles, fiction, games, puzzles and problems and much more. The material in these volumes has been carefully selected to be useful for years to come. Volumes 1, 2 and 3—each volume £ 4.95.



## Creative Computing Magazine

Creative Computing has long been Number 1 in applications and software for micros, minis, and time-sharing systems for homes, schools and small businesses. Loads of applications every issue: text editing, graphics, communications, artificial intelligence, simulations, data base and file systems, music synthesis, analog control. Complete programs with sample runs. Programming techniques: sort algorithms, file structures, shuffling, etc. Coverage of electronic and video games and other related consumer electronics products, too.

Just getting started? Then turn to our technology tutorials, learning activities, short programs, and problem solving pages. No-nonsense book reviews, too. Even some fiction and foolishness.

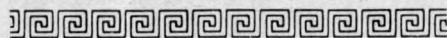

## Computer Coin Games

Computer Coin Games by Joe Weisbecker aids newcomers to the field of computers by simplifying the concepts of computer circuitry through games which can be played with a few pennies and full sized playing boards in the book. Enhanced by outrageous cartoons, teachers, students and self-learners of all ages will enjoy this 96 page softbound book. [10R] £ 1.95

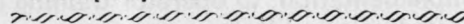

**creative computing**

## The Best of Byte

This is a blockbuster of a book containing the majority of material from the first 12 issues of Byte magazine. The 146 pages devoted to hardware are crammed full of how-to articles on everything from TV displays to joysticks to cassette interfaces and computer kits. But hardware without software might as well be a boat anchor, so there are 125 pages of software and applications ranging from on-line debuggers to games to a complete small business accounting system. A section on theory examines the how and why behind the circuits and programs, and "opinion" looks at where this explosive new hobby is heading. 386 pp softbound. £ 5.95 [6F]



## Computer Music Record

A recording was made of the First Philadelphia Music Festival which is now available on a 12" LP record. It features eight different computer music synthesizers programmed to play the music of J.S. Bach, J. Pachelbel, Rimsky-Korsakov, Scott Joplin, Neil Diamond, Lennon & McCartney and seven others. The music ranges from baroque to rock, traditional to rag and even includes an historic 1963 computerized singing demonstration by Bell Labs. £ 3.50 [CR101].



## To Order

Many, but not all, of these items are stocked by Creative Computing in Britain. Those in stock will be sent immediately; other items will be acknowledged and then shipped directly from the U.S.A.

To make payment send cash, postal order or cheque (in sterling drawn against a U.K. bank) plus £2.00 per order shipping and handling on books and records to Creative Computing, 27 Andrew Close, Stoke Golding, Nuneaton CV13 6EL.

**STCS**

ST Commercial Systems Ltd

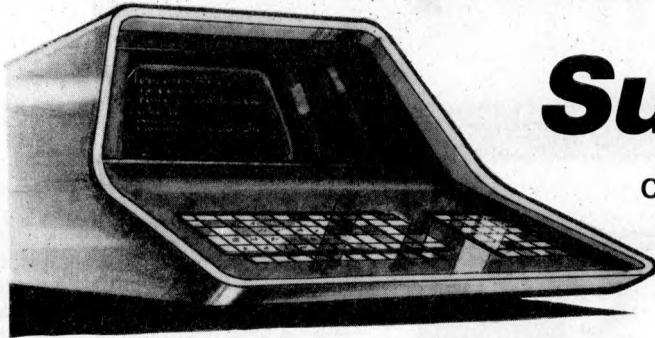
24 Ranelagh Road, London W5 5RJ  
England

# SuperBrain

**COMPLETE twin Z80 CP/M computer system with 64K RAM twin double density disk drives, printer, 2 RS232 ports, integral VDU and BASIC or FORTRAN. Plus a full year's guarantee . . . £2,800+VAT**

**Printer**

MICROLINE-80 by OKIdata, the quietest, most reliable little printer available – 40, 80, or 132 characters per line with graphics.

**Software**

Microsoft BASIC or FORTRAN for no extra charge.

**Guarantee**

All hardware fully guaranteed for a year. If anything goes wrong we'll have an engineer on your premises within 24 hours – wherever you are in Britain.

**SPECIAL** Educational and quantity discounts – Dealer enquiries invited:

**We also stock CP/M software:-**

Wordstar, Selector, all Microsoft languages, CBASIC . . . and lots more.

**AND . . .**

**TELEVIDEO** terminals – call for prices. Very special dealer deals.

**NEC Spinwriters** – all models.

**CALL Maria or Gerry: 01-840 1926 anytime 01-992 2909 after hours.**

# GATE MICROSYSTEMS LIMITED



## Scotland's Complete Microcomputer Service

now supply and support:

**HARDWARE:**

Apple II Systems and Peripherals  
Commodore Business Systems  
A wide range of VDUs, printers, etc.

**SOFTWARE:**

Incomplete Records Accounting  
Sales Ledger  
Purchase Ledger  
Nominal Ledger  
Stock Control  
Payroll  
Word Processing  
Database

Software can be tailored to your requirements or written completely to your specifications.

Our service is comprehensive, ranging from advice on system selection through installation and implementation, to operator training and comprehensive Hardware and Software maintenance.

You don't have to take our word for it.

Call us and arrange a demonstration.

GATE MICROSYSTEMS LTD.,  
THE NETHERGATE CENTRE,  
66 NETHERGATE,  
DUNDEE.  
TEL: (0382) 28194.

# The AIRAMCO Mikro 1000

## -The Scottish Solution.



The Mikro 1000 is a Scottish built micro-computer which combines State of Art technology with simplicity and durability to give a powerful small business system at a very competitive price.

Driven by a 2.5 MHz or 4 MHz Z80 processing unit constructed around Industry Standard S100 Bus, the Mikro 1000 is designed to provide the ease of expansion necessary in a modern growing business or industry - memory is expandable from 32K to 256K, with up to 4 Megabytes of on-line disk storage.

The integral VDU has an 80 cols. x 24 lines screen, and incorporates a green phosphor CRT, while the 117 key keyboard can be used remotely from the main body of the machine, and may be programmed for user functions such as word processing commands.

As well as supporting all CP/M based languages, the Mikro 1000 has a full range of business software, including Sales, Purchase and Nominal Ledger, Inventory Control, and Payroll, as well as Word Processing (which is available at even lower cost as a separate system on the Mikro 1000 WP).

For further information on either Mikro 1000 system, please contact:

**airamco**  
AIRAMCO LIMITED

Unit A2, Longford Avenue, Kilwinning Ind. Est.,  
Kilwinning, Ayrshire, KA22 8NP.

Tel: 0294 57755

Telex: 779808

## INTEGRATED SMALL BUSINESS SOFTWARE ISBS

**GRAFFCOM  
SYSTEMS GROUP**

## ISBS MODULES

- **PAYROLL** Standard PAYE/HMI Taxes routines, 250 employees, weekly or monthly, cash, cheque or bank giro, cumulative YTD figures, employee lists, payroll logs, pay slips and giro slips.
- **COMPANY SALES** Complete sales accounting, invoice control & analysis, sales ledger, aged debtors reports, statements, VAT control, variable accounting periods, credit control and customer maintenance.
- **COMPANY PURCHASES** Complete purchase accounting, invoice control analysis, purchase ledger, aged creditors reports, payment advices, Vat control, variable accounting periods.
- **STOCK CONTROL** Maintains stock records, monitors stock levels for optimisation. Stock descriptions, codes, unit prices, selling prices quantity on hand/min/on order/re-order/allocated/unsatisfied, analysis reports, price lists, parts explosion.
- **ORDER ENTRY & INVOICING** Invoices for services and consumable items, part orders or part quantities, sales analysis reports showing movements and trends over user defined periods.
- **GENERAL ACCOUNTING** Nominal ledger, trial balance, profit & loss, balance sheet, user defined cost coding system and accounting periods.
- **NAME & ADDRESS** Complete control of names & addresses, user defined coding system, report generator produces selective reports, prints anything from mailing labels to directories.

Designed for most of the popular 8080/Z80 Microcomputer disk systems running under CP/M\*. Requires 48K memory, dual floppy disks (or large fixed disk system), VDU and 132 col printer. GRAFFCOM SYSTEMS LTD, 52 SHAFTESBURY AVENUE, LONDON W1. 01-734 8862.

\*CP/M is a trademark of Digital Research.

# Mini-Digital Cassette Recorder

## An alternative to disc for program & data storage

### FEATURES

- \* The Philips MDCR 220 mechanism of proven reliability
- \* Holds up to 120k Bytes/Cassette with fast data transfer
- \* Extra memory board with RAM and ROM to hold operating software
- \* Will read & write (in blocks from 256 bytes to 60k Bytes), backspace & search for end of data on tape
- \* Compatible with 6502 based systems ie PET, AIM65, OHIO, KIM, COMPUKIT ETC.

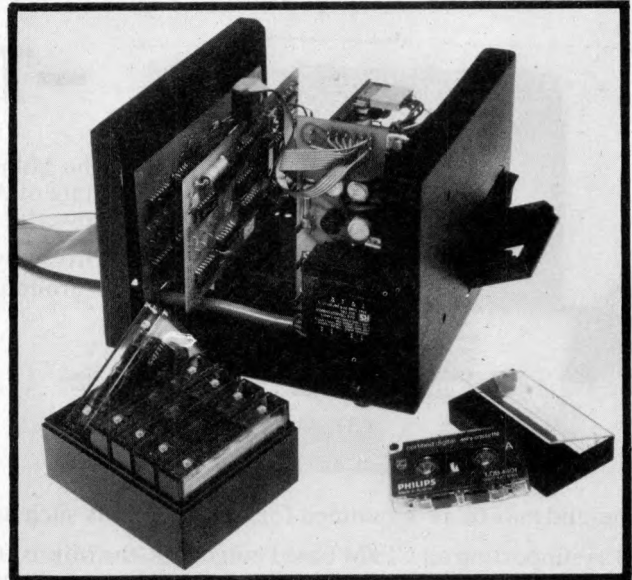

**CURRAH**  
COMPUTER COMPONENTS

Unit 7 Hartlepool Workshops, Sandgate Industrial Est.  
Hartlepool, Cleveland

|                                   |        |
|-----------------------------------|--------|
| PRICES (INCLUDING MANUAL)         |        |
| MINI RECORDER MECHANISM           | £95.00 |
| INTERFACING BOARD (TYPEA)         | £42.50 |
| MEMORY BOARD (WITH ROMS FOR 6502) | £55.00 |
| CASSETTES (BOX OF 6)              | £15.90 |
| MANUALS (SEPARATE)                | £10.00 |
| CARRIAGE                          | £2.25  |
| PRICES EXCLUSIVE OF VAT @ 15%     |        |

# Buying Computers?

Commodore PET 32K  
£675.75 plus VAT

Sharp MZ-80K  
£480.00 plus VAT

ITT 20/20 16K  
£607.00 plus VAT

ACT 808 inc dual disk drive  
£3950.00 plus VAT

## We'll give you more than a good deal

Under one roof in London's West End you can find:

### HARDWARE:

A comprehensive range of hardware to meet most applications - and budgets, with terms to suit you.

### SOFTWARE:

Probably the widest range of off-the-shelf software in the UK. Try out the packages and choose the one that suits you.

### CONSULTANCY SERVICES:

To apply micro computer systems to business, education or the home, make an appointment with our trained professionals for friendly advice based on extensive experience of discussing problems with many others like you.

### MAINTENANCE AND REPAIR CLUB:

that guarantees microcomputer users minimum downtime at very attractive premiums.

### REFERENCE MATERIAL:

A library of publications covering all aspects of the microcomputer world, including back issues of this and other important periodicals.

### DEMONSTRATIONS:

Regular, free demonstrations of business software - phone for details, times etc.

### LION MICROCOMPUTER CENTRE

is the single source to meet all your requirements.

The above prices do not apply to account sales.



### LION MICRO-COMPUTERS

Small Computers - to make your business bigger

Lion Computer Shops Ltd., Lion House, 227 Tottenham Court Road

London W1 (First Floor) Telephone 01-637 1601

Telex 28394 Lion G.

Open 9 to 6, Monday to Saturday (Thursday to 7)





# The Software Solution

We all know that a computer system is only as good as the software and that much of the applications software hitherto available has proved to be the weak link. Written in Microsoft basic for use with CP/M based hardware, Interface Software is probably the most comprehensive and robust application software currently available, which really will transform your micro-computer into an effective problem solving tool.

### Applications Software

- Nominal Ledger
- Sales Ledger
- Purchase Ledger
- Payroll
- Incomplete Records
- Word Processing (Wordstar)
- Mailing Address
- Etc.,

### Systems Software

- CP/M
- MP/M
- MBasic 5.0 (CP/M) Interpreter/Compiler
- CBasic (II) Interpreter/Compiler
- Fortron 80 Compiler
- Cobol 80 Interpreter/Compiler
- Pascal 8 (UCDS) Interpreter
- Z80 Macro Assembler

Recommended by Logitek for the ALTOS microcomputer and Rostronics for the Micromation but of course suitable for any CP/M based machine.

For more details contact Jim Reid or Sue Archer at:-

**DEALER ENQUIRIES WELCOME.**



**INTERFACE SOFTWARE LIMITED,**  
100, PARK STREET,  
CAMBERLEY,  
SURREY.  
Telephone (0276) 27982.

## DISCOUNT COMPUTERS

### PET

16K £480 32K £580 DUAL FLOPPY DISK  
£650 CABLES FROM £15 SUPERPET  
8032 £800 DISK £600 C2N £50  
PROGRAMMERS TOOLKIT £40

### PRINTERS

BASE 2 800B INC 2K BUFFER £375  
FRICTION + TRACTOR, 3 INTERFACES,  
FULLY PROGRAMMABLE 3 CHARACTER  
SETS. EPSON TX80B TRACTOR FEED  
£375

### TEXAS TI 99/4

CONSOLE AND 14" SKANTIC TV £860

### SUPERBRAIN

WITH INTEGRAL DISK + VDU  
CP/M 22 X80 4 MH2  
32KRAM 320K DISK £1500  
64KRAM 320K DISK £1750

All prices exclude VAT  
Full technical backup from Mapcon Engineers  
Replacement if unrepairable quickly



Cambridge Road, Orwell, Royston, Herts.  
Telephone: Arrington 689



## TI 99/4 Computer

### HOME COMPUTER £569 + VAT

Programmable colour graphics, sound generator,  
TI Basic with full file handling, TRACE, Auto-line  
etc. Ideal tool for both learning BASIC and  
programming power.

### AMAZING ROMPAK PROGRAMS £p.o.a.

Much of it CAL suitable down to 3 years old.

### Modified SKANTIC 14" colour TV £299 + VAT

NTSC from computer on channel 7. Serves also as  
second colour TV.

### SPEECH SYNTHESISER £100 + VAT

Clear male speech from the famous chip set, necessary  
software £25 extra + VAT callable from BASIC.

### THERMAL PRINTER £288 + VAT

Fast, with built in and user-defined graphics.

### DISC DRIVE £400 + VAT

All items plug together and share the matching smart  
appearance. ALL in stock. DISCOUNT 5% this month  
only.



Cambridge Road, Orwell, Royston, Herts.  
Telephone: Arrington 689

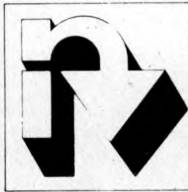
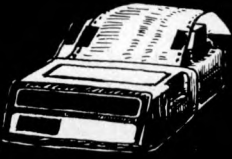

# centralex

A comprehensive range of Microcomputers Equipment, Peripherals, Software and Services for those who value Professional Standards, Guidance and Continuing Support for Hardware and Software.

APPLE  
TEXAS  
MICROPOLIS  
DIABLO  
MICROLINE

PET  
OHIO SCIENTIFIC  
CENTRONICS  
QUME  
HITACHI

ITT 2020  
CROMEMCO  
ANADIX  
DEC  
LEXICON

EXIDY  
MICROSTAR  
INTEGRAL  
DATA GENERAL  
ETC. ETC.

HORIZON  
SHUGART  
TELETYPE  
EPSON

## INFORMEX-80 Printer

£399+VAT

Special offer - for a limited period

For PET, APPLE, EXIDY, TRS80, ETC  
A high quality, high speed printer  
(125 cps) Upper and lower case letters  
plus graphics as standard  
Interface and cable for TRS80, PET,  
APPLE or RS 232 £69 + VAT  
Tractor feed option only £39

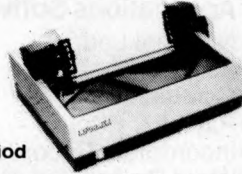

ALSO Training, Consultancy, Systems Design,  
Programming and Software

PAYROLL - INVOICING - STOCK CONTROL -  
SALES/PURCHASE LEDGER - VAT - MEDICAL  
RECORDS - EDUCATIONAL & ENGINEERING  
PROGRAMMES - HOTEL RESERVATION - ESTATE  
AGENTS - BUILDING MAINTENANCE - COBOL -  
FORTRAN - ETC.

Maintenance Contracts including stand-by equipment during repair  
periods - Free Delivery Nationwide - Terms arranged - Credit Cards and  
official orders accepted.

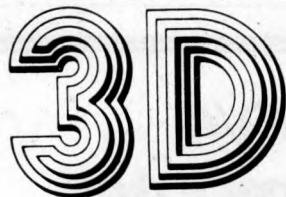

## Digital Design & Development

## THE INTERFACE SPECIALISTS

43 Grafton Way, London W1P 5LA

Tel: 01-387-7388

### PET INTERFACES

- \* 16-CHANNEL 8-BIT A-D CONVERTOR UNIT  
IEEE-488 Compatible. PRICE: £300
- \* 8-CHANNEL 8-BIT D-A CONVERTOR UNIT  
IEEE-488 Compatible. PRICE: £350
- \* 16-CHANNEL RELAY UNIT  
IEEE-488 Compatible. PRICE: £350
- \* USER PORT CONVERTOR (A-D & D-A)  
Single channels IN & OUT. PRICE: £200
- \* X-Y ANALOG PLOTTER INTERFACE  
IEEE-488 Compatible. PRICE: £200
- \* 8-CHANNEL 12-BIT A-D CONVERTOR UNIT  
IEEE-488 Compatible. PRICE: £600
- \* 8-CHANNEL DIGITAL DATA INPUT UNIT  
IEEE-488 - 64 bits IN. PRICE: £400
- \* 8-CHANNEL DIGITAL DATA OUTPUT UNIT  
IEEE-488 - 64 bits OUT. PRICE: £350
- \* FAST DATA ACQUISITION SYSTEM  
40,000 readings per sec. 4 A/D + 4 D/A  
PRICE ON APPLICATION

All units boxed complete with IEEE-488 address interna  
internally selectable, with integral power supply, cables,  
switch, fuse, indicators and illustrate BASIC software.

### SHARP MZ-80K INTERFACES

- \* PARALLEL PRINTER INTERFACE. PRICE: £110
- \* SERIAL PRINTER INTERFACE. PRICE: £150
- \* BIDIRECTIONAL SERIAL INTERFACE. PRICE: £  
£210
- \* 16-CHANNEL A-D CONVERTOR UNIT.  
PRICE: £280
- \* FAST DATA ACQUISITION SYSTEM - 40,000  
readings/sec. 4 analog channels IN & 4 channels OUT.  
PRICE ON APPLICATION

### SHARP MZ-80K SOFTWARE

- \* AIR ATTACK - Bomb the buildings to land  
successfully - £5
- \* ANIMAL - Learning program distinguishes between  
different creatures - £5
- \* CARD TRICK + ONE ARM BANDIT + LISSAJOU  
Ingenious mixed bag - £5
- \* MACHINE LANGUAGE HANDLER (T20C) - £22.5  
- £22.50
- \* EDITOR-ASSEMBLER + LOADER + DEBUGGER  
- £45.00

'Phone or write for further information.

TERMS All prices EX-VAT P&P extra Cheques should  
be made payable to 3D Digital Design & Development.  
All goods supplied under 90 days warranty.

**CUSTOM DESIGN UNDERTAKEN**

## BUBBLE MEMORY and REAL TIME CLOCK for NASCOM

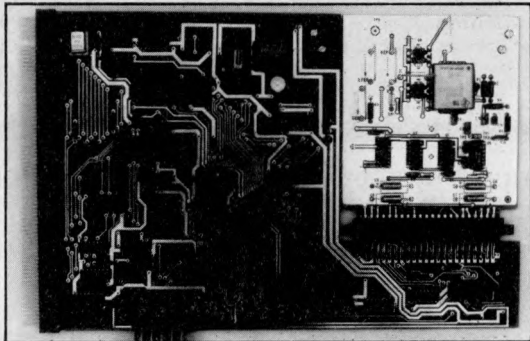

THE 8423 IS FULLY ASSEMBLED, BURNT IN AND PLUGS INTO THE 77 WAY NASBUS.

- \* ADD A NON-VOLATILE MEMORY TO YOUR NASCOM I or II
- \* MONITOR TRANSPARENT - USE IT WITH NAS-SYS, T2, T4 or B-BUG
- \* UNAFFECTED BY DUST OR VIBRATION
- \* 92,304 BIT CAPACITY ORGANISED AS 144 MINOR LOOPS OF 641 BITS
- \* BATTERY SUPPORTED CHOS CLOCK GENERATES PERPETUAL DAY, DATE, TIME
- \* DEALERS ENQUIRIES WELCOMED

## Microdata Computers Ltd

BELVEDERE WORKS, BILTON WAY,  
PUMP LANE INDUSTRIAL ESTATE, HAYES,  
MIDDLESEX. UB3 3ND.

TELEPHONE (01) 848 9871 (6 LINES) TELEX 934110

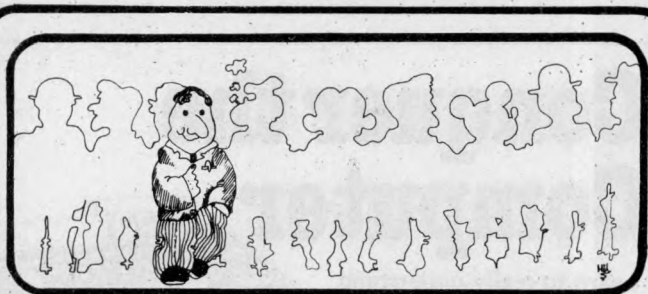

## You stand out in a crowd

Your business is not exactly the same as any other and neither are its problems. Any solutions are probably unique and must be tailored exactly for you.

You know your business better than anyone else and any system designed should use your knowledge. The micro-computer specialist should show you how to use the computer to meet your business requirements.

You should be able to get the micro-computer which best suits your business. It should be chosen after your requirements are specified.

You and your staff have a right to know all about YOUR system, including helping to program it if you want to. Training is your right - not an additional service.

If microcomputers cannot satisfy your business needs, you want to know - you don't want false promises.

67 Nova Road, Croydon, Surrey CR0 2TN.  
Telephone: 01-688 6013

**M I K E R O S E M I C R O S**

# TOMORROW TODAY at Birmingham Computer Centre

Commodore official distributors

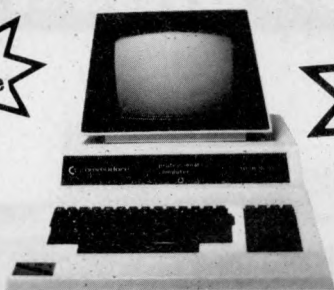

3016, 3032, 3008 PETS

The reliable value for money system with after sales support, instruction and training facilities and a wide range of programmes.

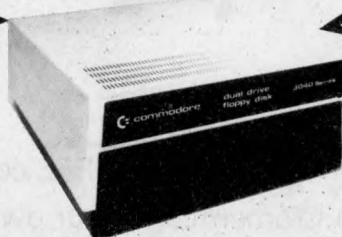

3040 DUAL DRIVE FLOPPY DISC

The latest in disc technology. Low cost with reliable data transfer.

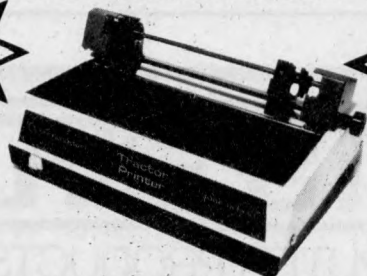

3022 PROFESSIONAL PRINTER

The high specification printer. Prints all PET characters onto paper and accepts labels, printed forms, cheques etc.



48K  
Disc  
drive with  
controller  
£1,044  
+ VAT

Apple authorised distributors  
The sophisticated quality system with a reputation for advanced design and innovation.

**Camden Electronics, First Floor,  
462 Coventry Road, Small Heath,  
Birmingham B10 0UG.  
Telephone 021 773 8240**

**Open Mon.-Sat. 9.30-6.00 p.m.**

A MEMBER OF THE COMPUTER RETAILERS ASSOCIATION

# DATRON of SHEFFIELD

for **Cromemco** the ultimate name in micros



DATRON import direct from Cromemco, California.  
 DATRON can supply Nationwide.  
 DATRON can provide maintenance nationally  
 DATRON can give you the realistic prices.  
 DATRON have in stock:-

**SYSTEM 2 64 K £ 2095**

**SYSTEM 3 64 K £ 3746**

**Z-2H HARD DISC 10M £ 5373**

DATRON can supply Systems 2 and 3 with Multi-Tasking facilities.

DATRON easily accessible - in the centre of the country.

Write or telephone for FREE colour brochure on System 3 or Z-2H.

We use Cromemco for our own business, why not call in for a demonstration.

**Demonstrations. 9am-5pm Monday-Saturday.**



## BITS & P.C.S.

COMPUTER PRODUCTS LTD

4 Westgate, Wetherby, West Yorks. LS22 4LL  
 Telephone (0937) 63744

### Nascom specialists PROGRAMMERS AID

SUPPLIER IN EPROMS FOR NASCOM ROM BASIC

PCW SHOW  
 OFFER

**£32.00**

Including V.A.T.

KEY BOARD REPEAT

PRINTER HANDSHAKE

|      |       |
|------|-------|
| AUTO | APND  |
| RENU | HEX   |
| DELE | DUMP  |
| FIND | OFF   |
| HELP | INKEY |
| STEP |       |

**Only £42.00**  
 INCLUDING V.A.T.

## Conquer the Computer

Learn to really understand the Computer. How it works and operates. Its 'language'.

How to program it and make full use of its capabilities.



- No previous knowledge necessary.
- Special educational Mini-Computer supplied ready for use.
- Complete home study library.
- Self-test program exercises.
- Complete programming instructions using computer.
- Services of skilled tutor available.

Please send details without obligation to:-

Name .....

Address .....

PCW/10/814 BLOCK CAPS PLEASE  
**BRITISH NATIONAL RADIO & ELECTRONICS SCHOOL**  
 4 Cleveland Road, St. Helier, Jersey, Channel Islands.

# IF

..... you want the best service  
you need professional advice  
years of experience impress you  
you are trying to find the best computer equipment  
as well as the finest software .....

# MICROSOLVE

is the Company to contact

MICROSOLVE COMPUTER SERVICES LTD

3rd Floor (rear),  
MIDDLESEX HOUSE,  
29-45 High Street,  
EDGWARE,  
Middlesex.  
(exit 4 M1/20 mins. West End).  
(prices ex. VAT)

01-951 0218/9/0

We cover a full range of equipment including  
the APPLE II (from £695/16K); the  
MICROSTAR multi-user system (from £4,950)  
and the powerful ALPHA MICRO which will  
run 1 to 22 terminals — the most cost  
effective system available today.

WE OFFER A COMPLETE SERVICE which  
encompasses advice, systems design, sale  
and installation of computer and peripherals, as  
well as tailor-made software, where necessary.  
There are fully documented ACCOUNTING  
and WORD PROCESSING PACKAGES etc., for  
Accountants, Solicitors, Manufacturers,  
Retailers, Medical Practitioners in fact all  
business applications.

ALSO in stock are PRINTERS, VDUs,  
CONTINUOUS STATIONERY, DISKETTES,  
DISK BOXES, all from the best names  
in the computer world — TEXAS, LEAR  
SEIGLER, TALLY, QUME, PAPER TIGER etc.

So if you either wish to buy a computer to  
program yourself or take advantage of our service  
TELEPHONE NOW FOR AN APPOINTMENT.

# MICROSOLVE MICRO SOLVE

**INTERACTIVE  
Data Systems**

**Interactive Data Systems**

14 Buckman Close · Greenleys · Milton Keynes · MK12 6AB  
Telephone (0908) 313997

DATA PROCESSING SYSTEMS — INDUSTRIAL CONTROL SYSTEMS  
Sales — Design — Manufacture

## THE BRITISH S100.

At last you can buy a range of S100 boards manufactured  
to the highest standards in the U.K., compatible with the  
new I.E.E.E. S100 specification and competitive in price  
with anything the Americans can throw at us.

- Z80 CPU.** A basic 4MHz CPU board with all the logic  
and buffers required to drive the S100 bus.  
Kit £84 A & T £105
- SBMC** A 4MHz Z80 single board microcomputer  
featuring 2 RS232 ports (or 20mA) with  
full handshaking, 1K of scratchpad  
memory, up to 16K of EPROM and a 4  
channel counter/timer/vector interrupt.  
Kit £178 A & T £235
- 8KS RAM** This is an 8K static memory board utilising  
the industry standard 2114 memory chip.  
Kit £98 A & T £114
- 16K SRAM** This is a 16K static memory board utilising  
the industry standard 2114 memory chip.  
Kit £174 A & T £198
- FDC** Any combination of 8" and 5", single or  
double sided floppy disk drives can be  
handled in single or double density with  
this board.  
Kit £177 A & T £198
- TERM 40** Active termination board for reduction of  
crosstalk and ringing in the bus.  
A & T £32-50
- PCI** Process Control Interface, 8 channels relay  
isolated output, 8 channels opto-isolated  
input, 8 bit TTL I/O, 4 x 8 bit D/A, 8 x 8  
bit A/D.  
Kit £195 A & T £223

Details from the Distributors:—  
**MENDIP COMPUTERS**  
57 Bath Road, Wells, Somerset, BA5 3HS.  
Telephone: (0749) 75249

**INTERTRONIX**  
83 West Street, Farnham, Surrey GU9 7EN.  
Telephone: (0252) 722011

FIRST NAME IN

# MICROHIRE

## C.C.S. MICROHIRE

NEW MONTHLY RATES \* (1 MONTH PLUS)

- 8K PET ..... £79./Month
- 16K PETS/APPLES/ETC. Each
- DOUBLE DISK DRIVE Item
- PRINTER ..... £89./Month
- 32K and 48K COMPUTERS ..... £99./Month

These are C.W.O. rates on our Standard Terms.  
If you want something different to these  
terms, please call Letchworth (04626) 73301

**PET — WHY PAY MORE?  
SAVE £200 +**

3032N PET — 3040 Disc — 3022 Tractor Printer  
—c2N Cassette — 2 Cables — Pet Revealed  
our price £1722 (ex. VAT)  
Save £50 on most units

Full Range of Commodore Programs  
available plus programming and extended  
maintenance

## C.C.S. MICROHIRE

7 The Arcade, Letchworth, Herts SG6 3ET

# SOFTWARE by the PROFESSIONALS



ARE YOU FED UP WITH WADING THROUGH THE SOFTWARE JUNGLE???  
CAN'T YOU FIND ANY REAL BUSINESS SOFTWARE???

**STOP LOOKING!!! WE'VE GOT IT**

If you're looking for a £50 business package or games DON'T call us.

We are one of the foremost micro-computer applications 'Software Houses' in the country and our packages developed for the UK, offer facilities normally found only on larger and more sophisticated computer systems.

The packages are simple to use, robust, secure against crashing, extremely flexible and cover most of the normal requirements of a small business.

We provide a 12 month warranty, with all our software products, plus advice, support and backup.

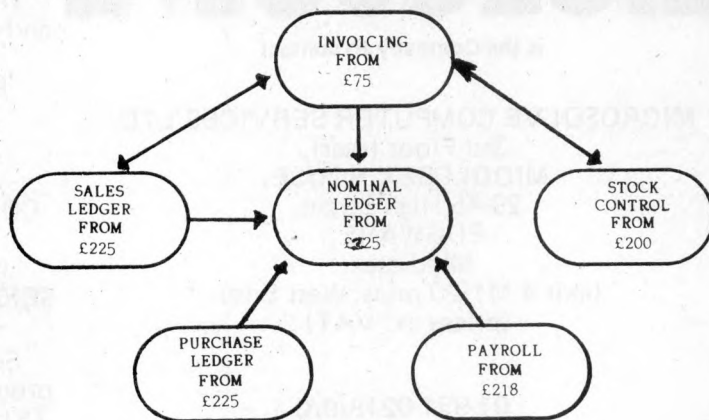

TRIDATA MICROS LTD.,

SMITHFIELD HOUSE, DIGBETH, BIRMINGHAM B5 6BS TEL. 021 622 6085

**Tridata**

## Happy Memories

|      |       |       |      |       |       |
|------|-------|-------|------|-------|-------|
| 4116 | 200ns | £3.75 | 4116 | 150ns | £4.95 |
| 2114 | 450ns | £2.95 | 2114 | 200ns | £3.95 |
| 2708 | 450ns | £4.95 | 2716 | 5V    | £9.95 |

Memorex soft-sectored mini-discs with free plastic library case £19.95 per 10.

Low profile I.C. sockets:

Pins: 8 14 16 18 20 22 24 28 40  
Pence: 10 11 12 16 17 19 21 27 37

Euroconnectors:

64/96 Male (right angled) £2.39 64/96 Female £3.52

RS232 connectors (solder):

Male 25 way: £1.86 Female 25 way: £2.13

Hoods: 66p

**ALL PRICES VAT INCLUSIVE**

Please add 30p postage to orders under £10.  
Government + Educational orders welcome  
£10 minimum



**Happy Memories**  
Gladestry  
Kington  
Herefordshire  
HR5 3NY  
Tel: (054 422) 618

BARCLAYCARD



## Master Your Micro FAST with...

Little Genius floppy diskette based courses will teach you, how to use your system and how to realise the full potential of the "Mighty Micro". These fully interactive computer lessons will guide you quickly to a high level of understanding and confidence in your ability to make the most of your microcomputer system.

Courses now available:

- Applesoft BASIC
- Advanced Applesoft BASIC
- Using your Apple
- Palsoft BASIC
- Advanced Palsoft BASIC
- Using your 2020
- PET BASIC
- Advanced PET BASIC



## Little Genius

Each course, comprising a floppy diskette, and starting instructions, costs only £40.00 plus VAT.

SPECIAL "3 in one" OFFER for 3 courses covering the same system only £99.00 plus VAT.

Little Genius courses are available from most computer retail outlets, or direct mail order from:

**LITTLE GENIUS**  
Suite 504, Albany House, 324 Regent Street, London W1R 5AA.  
Telephone: 01-580 6361

# ADVERTISERS INDEX

|                          |         |                              |          |                            |           |                       |         |
|--------------------------|---------|------------------------------|----------|----------------------------|-----------|-----------------------|---------|
| AJD Direct Supplies      | 21      | Dator Mark                   | 24       | Karadawn                   | 140       | Personal Computer's   | OBC     |
| Acorn Computers          | 67      | Datron Microcentre           | 164      | Keen                       | 155       | Petsoft               | 94      |
| Aculab                   | 20      | Davinci Comp                 | 110      | Kingston Computers         | 2         | Philidor Software     | 8       |
| Audiogenic               | 31      | Digital Design & Development | 162      | Knights                    | 156       | Premier Publications  | 50      |
| Adda                     | 22      | Display Electronics          | 135      | Kobra                      | 80        | Promglow              | 142     |
| Airamco                  | 159     | Drivers Jonas                | 154      | L & J Computers            | 74        | Research Machines     | 23      |
| Anglia Comp Centre       | 144     | Dyad                         | 138      | L.P. Enterprises           | 10/11 150 | Rostronics            | 24      |
| Almarc Data Systems      | 32      | Equinox                      | 134      | Leicester Comp Centre      | 28        | Roxburgh Electronics  | 27      |
| Andrews Computing        | 136     | Ferguson Computers           | 26       | Linsac                     | 152       | Science of Cambridge  | 102/103 |
| BNR & ES                 | 164     | Galatrek                     | 30       | Lion House                 | 160       | Scope                 | 136     |
| Basf                     | 41      | Gate Microsystems            | 158      | Little Genius              | 166       | Sharp                 | 7       |
| Beaver Systems           | 35      | Graffcom                     | 159      | Liverport Data Products    | 145       | Sharp Co-op           | 120     |
| Bits & Pcs               | 164     | Graham Dorian                | 101      | Logic Box                  | 144       | Sigmatek              | 134     |
| Bristol Software Factory | 13      | Grama Winter (G.W.)          | 18/19    | Logitek                    | 68/161    | Sintrom               | 139     |
| Business & Leisure       | 28      | H.B. Computers               | 3        | London Computer Store      | 149       | Sirton                | 14      |
| Byte Shop                | 110     | Ham & Gibson                 | 146      | Lowe Electronics           | 9         | Stack                 | 17      |
| CCS Microhire            | 165     | Happy Memories               | 166      | Magtronics                 | 40        | Stage One             | 33      |
| Cadle                    | 110     | A.J. Harding (Molimerx)      | 143      | Manhattan Skyline          | 20        | St Commercial Systems | 158     |
| Cambridge Comp Store     | 109     | Heath                        | 31/33/35 | Melbourne House Publishers | 138       | Sumlock Bondain       | 16      |
| Camden Electronics       | 163     | Henry's                      | 148      | Mendip Computers           | 142       | Sun Computing         | 66      |
| Central Calculators      | 152     | Hewart Micro electrics       | 146      | Microbusiness Centre       | 26        | Super Soft            | 5       |
| Centralex                | 162     | Hewlett Packard              | 84       | Microbyte                  | 147       | Swanley Electronics   | 33      |
| Cetronics                | 136     | Hewlett Packard Co-op        | 29       | Microcentre                | 1FC       | T.V.J. Microcomputers | 137     |
| Chromasonic              | 151     | Hitech Electronics           | 66       | Microdata Comp's           | 152/163   | Templeman Software    | 89      |
| Clearsons                | 146     | Houghton-Insel               | 142      | Micro Management           | 8         | Terodec               | 34      |
| Comart                   | 104     | Intelligent Artefacts        | 161      | Micro Sense                | 91        | Transam               | 96      |
| Commodore                | 39      | Interactive Data Systems     | 165      | Microsolve                 | 165       | Tri-Data              | 166     |
| Comp Shop                | 168/1BC | Interam Computer Systems     | 54       | Mighty Micro               | 56        | Tor Business          | 35      |
| Computech                | 44      | Interface                    | 98       | Mike Rose Micros           | 163       | Video Vector          | 166     |
| Computerama              | 133     | Intex Datalog                | 150      | Mutek                      | 148       | Dynamics              | 3       |
| Computerbits             | 144     | KGM Micros                   | 153      | Newbear Computing          | 141       | Weyfringe             | 6       |
| Computopia               | 154     | Kansas City                  | 156      | Newbury                    | 15        | Xitan Systems         | 52      |
| Cream Microcomputer Shop | 25      |                              |          | Newtronics                 | 146       |                       |         |
| Creative Computing       | 157     |                              |          | NIC                        | 8         |                       |         |
| Cumana                   | 12      |                              |          | Pete & Pam                 | 90        |                       |         |
| Currah                   | 160     |                              |          |                            |           |                       |         |

## CHIP CHAT

A rivalry is now developing in London between Tottenham Court Road — location of Byte Shop, Lion House and others — and the Edgware Road to see which will become Britain's Silicon Strip. The position of the latter has been 'improved' by a recent extension of Chris 'Spangles' Cary's empire — yes, Comp Shop of Barnet, Dublin and Santa Ana (California) has opened a new outlet at 311 Edgware Road . . . Now that we Brits are allowed to buy shares in foreign companies, who'll be the first to head the rush on this side of the Pond for Apple shares? Yes, Big A is going public and US investment analysts are waxing ultra-lyrical about the company's prospects on Wall Street. It seems that founders Steve Wozniak and Steve Jobs didn't originally plan a share-out but a federal securities regulation virtually compels any company with more than 500 shareholders and \$1,000,000 in assets to go public. That Apple has those assets is no big surprise but all those shareholders? They're the result of an employee incentive scheme . . . Coming soon, another

new British machine, whose backers say their avowed aim is to underprice the Transam Tuscan and promise a Z80-based, CP/M twin disk set-up with 64k RAM; as yet a name has not been devised but it won't, apparently, be called Nascom 3. . . And delayed, the eagerly-awaited British launch of the Maleca IV. It seems the Brazilian backers suddenly heard about 16-bit processors and insisted on a re-design, despite the IV's outstanding spec, so we'll have to wait until next spring for the new Maleca V. . . That's about the time the Apple III will now appear, according to informed rumour. As yet we've not found out why the delay but it surely couldn't be connected with Apple going public — could it? . . . Rumours abound of secret organisations, called Apple Rings, wherein certain dealers get together to import Apples directly from the States, circumventing the Eurapple/Microsense set-up. Microsense has recently taken to issuing press releases warning all of the danger of buying from these 'rogues' who undercut their prices. . . Adda has confused the world

by snaking its way to new premises, from The Broadway, Ealing, to Broadway, West Ealing. . . Watch out for Personal Computers PPS software which adds software between the graphics tablet and the screen — makes plotting a joy and lets you key in text as well. . . 'Squire' Allason, ever keen to appear in these columns, just sent the Editor a green eyeshade. A pity the Editor hasn't got green eyes. . . Last month we promised news of a jolly to California and this month it's a reality — see page 55 if you haven't done so already for details of a trip to the 6th West Coast Computer Faire as part of a luxury holiday . . . As is normal in the run-up to our own show, we began to receive enquiries about the Show from members of the public. Among those interested in the PCW Show were others, also asking about the Show but sounding utterly confused when we told them it was at the Cunard Hotel, etc etc. Turned out that these were enquiring about the first London Computer Fair, organised by Robin

'Bogey' Bradbeer. These poor souls had telephoned the North London Polytechnic (where 'Bogey' works) for further information and had met with the telephonic equivalent of a very blank look. . . When the Fair did eventually take place, a highlight was the sound of Bogey himself advertising his new book (reviewed in this month's 'Bookfare') over the PA and announcing that he would be on his own stand in person to autograph copies. The announcement sent a tumult of apathy sweeping across the show. . . As this column was written just before the PCW Show, gossip arising from that event will have to wait until next month. 'Bumper' Harris was, however, threatening to cause an uproar by streaking through the Chess Championship. . . Finally, congratulations to our lovely Art Editor, Julia, who finally got her man to the altar. Our sincere condolences to the bridegroom.

## BITS & BYTES

|                                       |              |
|---------------------------------------|--------------|
| 8MHz Super Quality Modulators         | £4.90        |
| 6MHz Standard Modulators              | £2.90        |
| C12 Computer Grade Cassettes          | 10 for £4.00 |
| Anadex Printer Paper — 2000 sheets    | £25.00       |
| Floppy Discs 5¼" Hard and Soft Sector | £3.50        |
| Floppy Disc Library Case 5¼"          | £3.50        |
| Verocases for Nascom 1 & 2 etc.       | £24.90       |
| Keyboard Cases                        | £9.90        |

**MEMORY UPGRADES**  
**16K (8 x 4116) £29.90 + VAT**  
**4K Compukit (8 x 2114)**  
**£29.90 + VAT**

**EPROM 2716 £12.50 + VAT**

**LARGE SELECTION OF BOOKS, PET AND TRS80 SOFTWARE STOCKED**

**APPLE DISK DRIVES WITH CONTROLLER £299 WITHOUT £249**

**APPLE MUSIC MACHINE 9 CHANNEL AUTO PLAY AND COMPOSE £99.90**

**PAL/NTSC COLOUR MONITOR & TV FOR APPLE T/I & ATARI COMPUTERS**

**NASCOM GAMES TAPE "BATTLESHIPS £7 RE NO. 3D OXO SPACE INVADERS NIMBOY**

## NEC SPINWRITER

only  
**£1490**  
 + VAT



NEC's high quality printer uses a print "thimble" that has less diameter and inertia than a daisy wheel, giving a quieter, faster, more reliable printer that can cope with plotting and printing (128 ASCII characters) with up to five copies, friction or tractor fed. The ribbon and thimble can be changed in seconds. 55 characters per second bidirectional printing — with red/black, bold, subscript, superscript, proportional spacing, tabbing, and much, much more.

EXTENDED WARRANTY BY COMPCARE



## HITACHI PROFESSIONAL MONITORS

9" — **£129**  
 12" — **£199**

- **Reliability** Solid state circuitry using an IC and silicon transistors ensures high reliability.
- **500 lines horizontal resolution** Horizontal resolution in excess of 500 lines is achieved in picture center.
- **Stable picture** Even played back pictures of VTR can be displayed without jittering.
- **Looping video input** Video input can be looped through with built-in termination switch.
- **External sync operation** (available as option for U and C types)
- **Compact construction** Two monitors are mountable side by side in a standard 19-inch rack.

RRP £540



only  
**£399**  
 + VAT  
**ANADEX DP8000**

Super Quality — Low cost printer. Tractor Feed with full 96 ASCII character set. Accepts RS232C at baud rates between 100 and 9600 and Parallel Bit data.

Attaches either directly or through interfaces to Pet, Apple, TRS80, Sorcerer, Nascom, Compukit etc.

EXTENDED WARRANTY BY COMPCARE

## THE NEW ANADEX DP9501 A PROFESSIONAL PRINTER



- Bi-directional printing
- Up to 220 chars/line with 4 print densities
- 500 char buffer
- RS232C and Centronics Parallel interface built in
- Full software control of matrix needles allowing graphics capability
- 200 chars/sec ● Adjustable width tractor feed.

All this for only **£895 + VAT.**

## COMPUPHONES

**YOU NEED NEVER MISS AN IMPORTANT CALL AGAIN TWO CORDLESS TELEPHONE SYSTEMS — DIRECT FROM USA**



**THE ALCOM** only **£147 + VAT**

Base station connects to your telephone line. Remote handset clips to your belt and gives you push-button dialling — Bleeps when call arriving — Nicad rechargeable batteries. Charger in base unit.

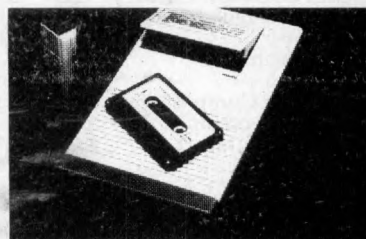

**LOW COST TELEPHONE ANSWERING MACHINE** only **£99.95 + VAT**

Microprocessor controlled answering machine. Plug into your phone line. Records any phone call messages. Remote bleeper enables you to listen to your messages from anywhere in the world. Uses standard cassettes. Comes complete with mains adaptor, microphone, remote bleeper, base unit, cassette with 30 sample pre-recorded messages.

**TEAC DISK DRIVES FOR TRS 80 USERS**  
 40TRACK SINGLE **£219**  
 40TRACK DUAL **£399**  
 2 DRIVE CABLE **£19**  
 PERCOM SEPARATOR **£20**

**DISK SOFTWARE AVAILABLE FROM STOCK**  
 C9 NEWDOS 40 **£49**



COMING SOON

26 megabyte  
 Hard Disc  
 multi-user  
 DOS

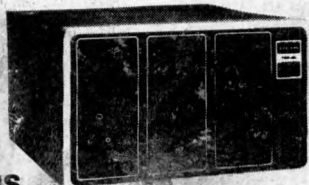

**WE USE THIS MACHINE IN OUR BUSINESS**

## COMMERCIAL ● EXPANDABLE ● COMPLETE TRS 80 · MODEL II

EXTENDED WARRANTY BY COMPCARE

This new unit from the world's most successful micro company is now available immediately with software.

The basic unit comes complete with 64 thousand characters (bytes) of Memory. The built in 8" Floppy disc adds another ½ million extra characters including the disc operating system. More disc expansion is now available.

The Model II is a complete unit with a full keyboard including a numeric pad and 12" screen which gives 24 lines of 80 characters. The computer is supplied with both the disc operating system and the Level III Basic.

A full self test routine is written into the power up procedure to eliminate incorrect operation. Both serial and parallel expansion sockets are standard. A printer is a plug-in operation.

Both hardware and software necessary to talk to a mainframe are included. Terminal usage is very possible. With the addition of CPM2 you can operate with COBOL, FORTRAN, MBASIC, CBASIC in which languages are many other applications packages i.e. accounting, payroll stock etc.

64K 1-Disk Model II **£1995.00 + VAT**  
 RRP £2250.00

## 1 DISK EXPANSION Room for 3

500K per Drive gives total of 1.5M Byte — 1 Drive plus Cabinet **£799 + VAT**

CP/M2 **£95.00**  
 CIS COBOL **£400.00**  
 C BASIC **£75.00**  
 M BASIC **£155.00**  
 FORTRAN **£220.00**  
 WORDSTAR **£255.00**



## EUROPE'S FASTEST SELLING ONE BOARD COMPUTER

# COMPUKIT UK101

★ 6502 based system — best value for money on the market. ★ Powerful 8K Basic — Fastest around ★ Full Qwerty Keyboard ★ 4K RAM Expandable to 8K on board. ★ Power supply and RF Modulator on board. ★ No Extras needed — Plug-in and go. ★ Kansas City Tape Interface on board. ★ Free Sampler Tape including powerful Disassembler and Monitor with each Kit. ★ If you want to learn about Micros, but didn't know which machine to buy then **this is the machine for you.**

40 pin Expansion Jumper Cable for CompuKit expansion **£3.50 + VAT**

Build, Understand and Program your own Computer for only a small outlay.

**KIT ONLY £179 + VAT**  
**NO EXTRAS NEEDED**

Available ready assembled, tested & ready to go **£229 + VAT**

### NEW MONITOR FOR COMPUKIT UK101

● In 2K Eprom 2716 ● Allows screen editing ● Saves data on tape ● Flashing cursor ● Text scrolls down **£22.00 + VAT**

### FOR THE COMPUKIT

|                    |               |
|--------------------|---------------|
| Assembler/Editor   | <b>£14.90</b> |
| Screen Editor Tape | <b>£5.90</b>  |

All Prices exclusive VAT

### Game Packs

|                        |              |
|------------------------|--------------|
| 1. Four Games          | <b>£5.00</b> |
| 2. Four Games          | <b>£5.90</b> |
| 3. Three Games 8K only | <b>£5.00</b> |

|                   |               |
|-------------------|---------------|
| Space Invaders    | <b>£5.00</b>  |
| Chequers          | <b>£3.00</b>  |
| Real Time Clock   | <b>£3.00</b>  |
| Case for CompuKit | <b>£29.50</b> |

## VISTA V200 SORCERER OVAL DISK DRIVE

INCLUDES TWO 40 TRACK DRIVES POWER SUPPLY AND CP/M DOS INCLUDING BASIC-E COMPILER

**£850 + VAT**

### SPECIAL—ONCE IN A LIFETIME OFFER!

16K **£399**

32K **£449**

48K **£499**

+ VAT

## EXIDY SORCERER

For Personal or Business Use.

32K or 48K memory. 8K Microsoft Basic in ROM. Dual Cassette I/O, RS232 I/O. Parallel I/O (Centronics). Expansion available through optional extra S100 Motherboard. 69 Key keyboard including 16 key numeric pad.

### NEW TV GAME BREAK OUT

Has got to be one of the world's greatest TV games. You really get hooked. As featured in ETI. Has also 4 other pinball games and lots of options. Good kit for up-grading old amusement games.

**MINI KIT** — PCB, sound & vision modulator, memory chip, and de-code chip. Very simple to construct. **£14.90 + VAT**  
**OR PCB** **£2.90** **MAIN LSI** **£8.50** Both plus VAT



## WE ARE NOW STOCKING THE APPLE II EUROPLUS AT REDUCED PRICES

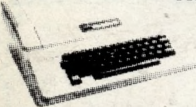

16K **£599**

32K **£649**

48K **£690**

+ VAT

**Getting Started** APPLE II is faster, smaller, and more powerful than its predecessors. And it's more fun to use too because of built-in features like:

● **BASIC** — The Language that Makes Programming Fun.  
● **High-Resolution Graphics** (in a 54,000-Point Array) for Finely-Detailed Displays.  
● **Sound Capability** that Brings Programs to Life.  
● **Hand Controls** for Games and Other Human-Input Applications.  
● **Internal Memory Capacity** of 48K Bytes of RAM, 12K Bytes of ROM; for Big-System Performance in a Small Package.  
● **Eight Accessory Expansion Slots** to let the System Grow With Your Needs.

You don't need to be an expert to enjoy APPLE II. It is a complete, ready-to-run computer. Just connect it to a video display and start using programs (or writing your own) the first day. You'll find that its tutorial manuals help you make it your own personal problem solver.



We give a full one year's warranty on all our products.

We now have in stock demonstration models of the Atari 800 and Texas 99/4. **Come and see them**

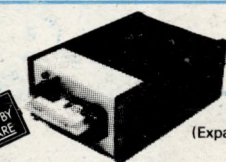

## EXATRON STRINGY FLOPPY FOR TRS80

(Expansion interface not needed)

only **£169 + VAT**

High Speed storage medium that is cheap and reliable. Includes 20 wafers - M/C monitor - BUS EXPN cable. **£169**

## SUPER PET 32K 40-80 COLUMN Ex/Stock

**£825 + VAT**

## NASCOM 2 DISC DRIVES

Add a powerful, double density, mini floppy disc to your Nascom system.

- Disc Controller Card (includes Nasbus 6 S100 interface)
- Will control 4 Drives.
- CPM operating system.
- Extended Disc Basic Compiler.
- Power supply included

One Disc System — **£499 + VAT**  
Additional Disc Unit — **£299 + VAT**

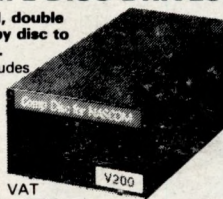

only **£349 + VAT**



## TRS80 LEVEL 2 16K

Fully converted to UK T.V. Standard. Comes complete with easy to follow manuals. UK Power Supply — Cassette Leads — Sample tapes. Special box to enable you to plug into your own TV. Recommended for first time-buyers. Just plug in and go. Full Range of Software Available

Interface to Centronics Parallel for TRS80 **£5.00 + VAT**

only **£295 + VAT**

Expand your TRS80 by 32K.

32K Memory on board. Centronics parallel port. Disk controller card. Real time clock. Requires Level II Basic. Interface for 2 cassette decks. complete with power supply.

## TRS80 EXPANSION INTERFACE



## video 100

12" BLACK & WHITE  
LOW COST VIDEO  
MONITOR

only  
**£79 + VAT**

- Ideal for home, personal and business computer systems
- 12" diagonal video monitor
- Composite video input
- Composite video input
- Compatible with many computer systems
- Solid-state circuitry for a stable & sharp picture
- Video bandwidth - 12MHz + 3DB
- Input impedance - 75 Ohms
- Resolution - 650 lines Minimum In Central 80% of CRT; 550 Lines Minimum beyond central 80%.

### SPECIAL OFFER

We will part exchange your Sinclair ZX80 for any of our products.

Refurbished ZX80's—fully guaranteed **£69.90**  
(Supply dependant upon stocks). **+ VAT**



We have one of the largest collections of Computer Books under one roof, along with racks of software for the PET and TRS80. **Come and see for yourself.**

## NEW REDUCED PRICES

8K **£399**

16K **£499**

32K **£599**

+ VAT

RRP £795 for 32K



## The PEDIGREE PETS

Very popular for home & business use. 8K Microsoft Basic in ROM. 8K Pet 32K & 16K with new improved keyboard. All with green screen.

Cassette Deck **£55** extra Full range of software available

Interface PET IEEE — Centronics Parallel  
Not decoded **£49.00 + VAT** Decoded **£77.00 + VAT**

## SPECIAL SCOOP GET YOURSELF A PRINTER FOR YOUR PET AND SAVE A FORTUNE

only **£349 + VAT**

Full Pet Graphics including cables. Ready to go.

**EX-STOCK.**

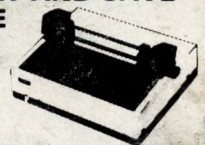

"Europe's Largest Discount Personal Computer Store"

Please add VAT to all prices — including delivery. Please make cheques and postal orders payable to **COMP SHOP LTD.**, or phone your order quoting **BARCLAYCARD, ACCESS, DINERS CLUB** or **AMERICAN EXPRESS** number. **CREDIT FACILITIES ARRANGED** — send S.A.E. for application form.

14 Station Road, New Barnet, Hertfordshire, EN5 1QW Telex: 298755 TELCOM G

Telephone: 01-441-2922 (Sales) 01-449 6596

OPEN - 10 am - 7 pm — Monday to Saturday

Close to New Barnet BR Station — Moorgate Line.

★ **NOW IN IRELAND** at: 80 Marlborough St., Dublin 1. Tel: Dublin 749933

★ **COMP SHOP USA**, 1348 East Edinger, Santa Ana, California, Zip Code 92705.

Telephone: 0101 714 5472526



**NEW SALES SHOP**  
311 Edgeware Rd. W2



We are now entering our fourth financial year of dealing solely in the personal computer market — in fact, we started it! Over this period, Personal Computers Limited have formed a group of graduate specialists who will help you in the fields of word processing, financial planning, statistics, economic modelling, forecasting, accounting systems, foreign exchange, banking and oil exploration.

We also do rather well with computer graphics and highly recommend the graphics tablets and our plotter for Apple.

We can also offer two excellent items of software — **Format 40** and **Visicalc** — at a combined price of **ONLY £189**, and the **Super Sound Generator** for only **£90!** (excl. V.A.T.)



**8" Disk Drive (above left)**

Our 8" disks are still as popular as ever — 2 drives give you 1.2MB with all the reliable security of Shugart Technology. Easily interfaced to Apple, uses the same D.O.S.



**A.I.O. Serial and Parallel Card (above centre)**

Three handshake lines (R.T.S., C.T.S. and D.C.D.). Firmware for serial interfaces on board, software for parallel printer available, 2 bi-directional 8 bit parallel ports, plus 4 additional interrupt and hand-shaking lines.



**Light Pen (above right)**

A much sought after product which we introduced to the U.K.

**80 Character Card (below left)**

... opens up the real commercial world for all Apple owners.

**Paper Tiger (Below centre)**

132 character line, plus graphics, 8 character sizes, ordinary paper, multiple copy, upper and lower case 96 character, parallel/serial, form control.

**Centronics 730 (Below right)**

A substantial, robust printer from a major manufacturer. 300 dpi handling system, 100 character per second. Special low cost interface. 96 characters.



**Items pictured**

**Sharp MZ — 80K**

A new generation of personal computer, self contained, versatile and starting at only £570 (excl. VAT). Explore the Zilog Z80 now the easy way. Disks and printer available shortly.

**Numeric Keypad**

... with 8 function keys is a must in all financial applications.

**TCM 100 & TCM 200**

... both now have graphics as well as their own power supply, essential with this type of printer.

**Qume Sprint 5**

The quality word processing printer. Clean, clear executive reports the way you want them. Can print up to 5760 points per square inch — or even print in 2 colours.

# This is what we do...

## and we do it rather well!



Personal Computers Limited

194-200 Bishopsgate, London EC2M 4NR Tel. 01 526 8121

For further information, please complete this coupon and post to:  
 Personal Computers Limited, 194-200 Bishopsgate, London EC2M 4NR

NAME \_\_\_\_\_

ADDRESS \_\_\_\_\_

\* Now here, details for  
**APPLE**