

Practical Computing

80p March 1983

Volume 6 Issue 3

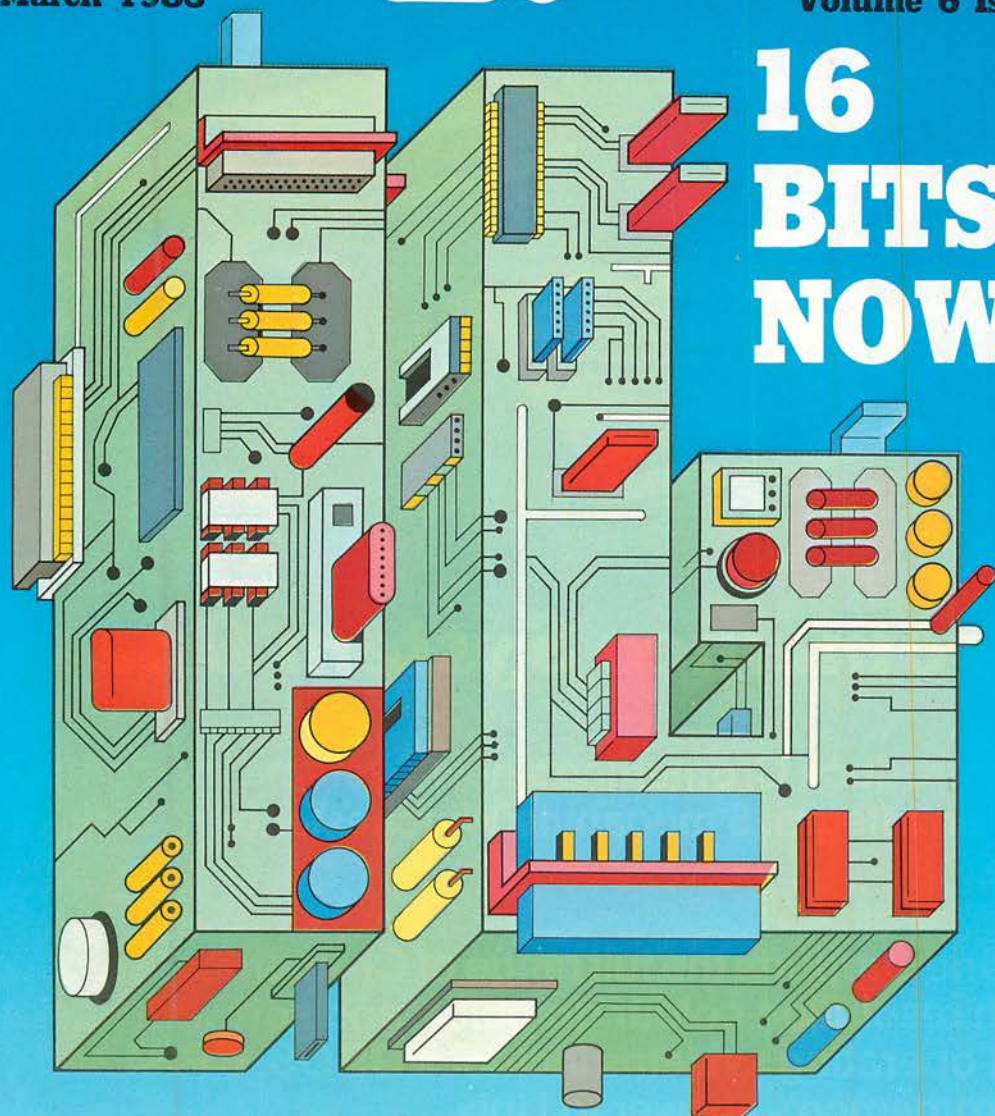

**16
BITS
NOW**

Lisa — Apple's revolutionary micro
BBC/Atom DIY graphics digitiser
Computing on the train

**The Lynx on test
— it's no toy**

**NEW
MODEL**

**LOWER
COST**



Cromemco System One

MicroCentre introduce Cromemco's new System One computer, available with an integral 5 megabyte Winchester hard disk, at a new low price.

The System One supports the full range of Cromemco interface cards including high resolution colour graphics, and software packages. The choice of operating systems includes CDOS, CP/M and CROMIX—Cromemco's answer to Unix.

Call MicroCentre for  Cromemco

MicroCentre Ltd
(Complete Micro Systems)

• Circle No. 101

**Britain's independent
Cromemco importer**

**30 Dundas Street
Edinburgh EH3 6JF
Tel: 031-556 7354**

LIST

PRACTICAL COMPUTING MARCH 1983

>NEWS

15 NEW COMPUTERS
Within a few days of one another, IBM, DEC, Apple and Wang launched new 16-bit micros on to the market. The battle has started in earnest.

35 IBM PC NEWS
The new IBM Personal Computer has already generated a mass of ancillary products. They are now starting to appear on the U.K. market.

>REVIEWS

77 APPLE'S LISA — A REVOLUTIONARY MICRO
The long-awaited 16-bit Apple IV has been officially announced. Ian Stobie previews the integrated software/hardware architecture.

84 THE LYNX — FOR HOME AND BUSINESS USE
Bill Bennett tests the £225 Lynx from Computers, which starts as a home colour computer but promises CP/M for the future.

87 FUJITSU DAISYWHEEL
Chris Bidmead tries out a fast Japanese letter-quality printer.

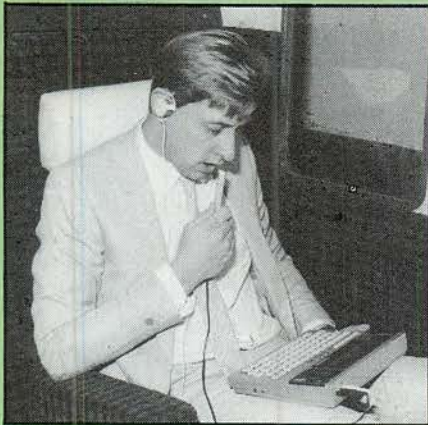

93 COMPUTING ON THE TRAIN
Portable micros in action — Ian Stobie investigates word processing on the Sony Typecorder and Epson HX-20.

130 SPECTRUM GAMES
Jack Schofield play-tests a handful of low-priced cassette games, including the new Penetrator for the Sinclair Spectrum.

171 BOOKS
Michael Trott looks at recent books about the popular Apple II computer.

>FEATURES

***100 HOW TO MAKE AN X,Y DIGITISER**
Can't afford a digitiser? Why not build your own. J C Flower supplies details of software and circuits for the Acorn micros.

107 MONDAY MORNING COMPUTING
Start the week with Chris Naylor's humorous guide to micro jargon.

110 PROGRAMMING CONFUSE-AN-APPLE
... into thinking it's a Pet. It simplifies the conversion of Pet programs.



112 COMPUTERS IN, WORKERS OUT?
John Dawson looks at the problems of industrial relations when companies try to computerise.

116 SIMULATION KSIM FORECASTING
Predict future behaviour — Adrian Hill provides a program which uses Julius Kane's forecasting method.

***120 PROGRAMMING KNOW YOUR SORT**
Part 1 of a comprehensive guide to sorting from Andrew Featherstone, with examples in Sinclair Basic.

124 MONKEYNUT MYSTERY
A P L Byteswap tracks down the murderer in Peter van der Linden's amusing story.

***126 ENVELOPED IN BBC SOUND**
David Peckett presents a program for displaying the sound envelope on the BBC Microcomputer.

132 PROGRAMMING FOR DISABLED USERS
Robin Nixon pleads for software that can be tailored to individuals' needs.

>REGULARS

5 EDITORIAL
The recently-announced Data Protection Bill does not offer enough protection against the misuse of data.

7 FEEDBACK YOUR LETTERS *DISDAW'S FIX*
How can you avoid "cowboys" when buying a computer? Plus an assortment of comments, corrections and enhancements.

***39 RANDOM ACCESS LET'S GET LOGICAL**
Boris Allan discusses axioms, assumptions, and different approaches to the logical process of argument.

139 OPEN FILE — 16 PAGES OF FREE SOFTWARE
More programs and programming tips for the Apple, Commodore, Tandy, BBC, Atari, Sinclair and other microcomputers.

175 PUZZLE PRINTER'S ERROR
Douglas Tate's printer is playing up. Can you decipher the message?

179 PETER LAURIE'S "LAST WORD"
Could the whole 16-bit world be a bit far-fetched?

>SUPPLEMENT

In the 48-page supplement free with this issue:
CHOOSING A 16-BIT MICRO
CHOOSING A 16-BIT OPERATING SYSTEM

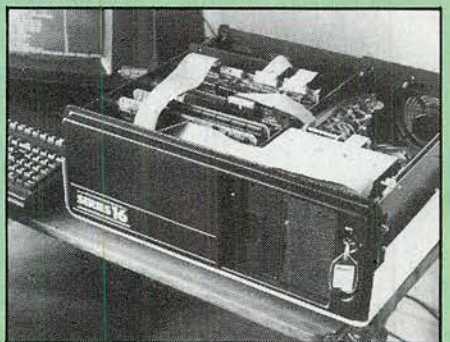

ALMARC SERIES 16 — REVIEW
COLUMBIA PC — REVIEW
THREE NOMINAL LEDGERS COMPARED
COMPLETE GUIDE TO 16-BIT MICROS
CHUCK PEDDLE INTERVIEW

upgrade to an ORIC-1



**16 colour
professional
keyboard
full graphics
real sound**

- Superb styling
- Choice of 16K or 48K RAM
- Ergonomic keyboard with 57 moving keys
- 28 rows x 40 characters high resolution
- Teletext/viewdata compatible graphics
- 6 octaves of real sound plus Hi-Fi output
- Centronics printer interface and cassette port
- Comprehensive user manual

FOR HOME, EDUCATION, BUSINESS & ENTHUSIASTS.

OPTIONAL MODEM OFFERS COMPUTER PHONE LINK FOR: ELECTRONIC MAIL ● TELESOFTWARE ● PRESTEL
COMING SOON, TO COMPLETE YOUR SYSTEM: ORIC MICRO-DRIVE DISCS & SPEED PRINTER

ORIC is no toy! Its professional keyboard, Basic language and extensive specification, will do all you expected of your home computer, plus a whole lot more. For home, educational, business and games use.

If you're buying for the first time beware! Only ORIC computers offer full colour capability for under £100 and the most powerful and comprehensive micros in their price brackets.

So whether you're just starting out, or upgrading existing equipment, make the professional decision and choose ORIC. Send for our comprehensive brochure NOW, or better still, order your ORIC today.

Delivery is around 28 days with a money back guarantee if you're not delighted.

Clip the coupon below, or call our telesales number ASCOT (0990) 27641.

FROM
£ **99**
incl VAT

ORIC-1

The Real Computer System

ORIC PRODUCTS INTERNATIONAL LTD Coworth Park Mansion, Coworth Park, London Road, Sunninghill, Ascot, Berks SL5 7SE.

Prices	ORIC-1 16K RAM	£ 99.95	
Include	ORIC-1 48K RAM	£169.95	
VAT	ORIC Communications Modem	£ 79.95	
	Postage and Packing	£ 5.95	
	TOTAL	£	

Please charge my Access, Barclaycard
Amex, Diners Club account no.

*Please delete/complete as applicable.
*I enclose a cheque/
P.O. payable to:
ORIC PRODUCTS INTERNATIONAL LIMITED
for £

Name _____
Address _____

If you require a brochure please tick

DISC DRIVE & PRINTER available

Safeguarding whose data?

Practical Computing

EDITORIAL 01-661 3609
 Editor
Jack Schofield
 Deputy Editor
Bill Bennett
 Assistant Editor
Ian Stobie
 Art Editor
Steve Miller
 Production Editor
John Liebmann
 Sub-editor
Sally Nicholls
 Editorial Secretary
Julie Milligan
 Consultants
Chris Bidmead
Peter Laurie
 ADVERTISING 01-661 3612
 Advertisement Manager
Ian Carter 01-661 3021
 Assistant Advertisement Manager
Kenneth Walford 01-661 3139
 Advertisement Executives
Fiona Howell 01-661 3468
Robert Payne 01-661 8425
 Advertisement Secretary
Janet Thorpe
 Midlands office:
David Harvett 021-356 4838
 Northern office:
Geoff Aikin 061-872 8861
 PUBLISHING DIRECTOR
Chris Hipwell

Published by IPC Electrical Electronic Press Ltd, Quadrant House, The Quadrant, Sutton, Surrey SM2 5AS. Tel: 01-661 3500. Telex/grams 892084 BIP-RESG.

Typeset by Centrepoint Typesetters London EC1 and printed by Eden Fisher (Southend) Ltd, Southend-on-Sea.

Distributed by IPC Business Press (Sales and Distribution) Ltd, Quadrant House, The Quadrant, Sutton, Surrey SM2 5AS.

Subscriptions: U.K. £12 per annum. Overseas £18 per annum; selling price in Eire subject to currency exchange fluctuations and VAT; airmail rates available on application to Subscription Manager, IPC Business Press (S&D) Ltd, Oakfield House, Perry-mouth Road, Haywards Heath, Sussex RH16 3DH. Tel: 0444 459188.

©IPC Business Press Ltd 1983
 ISSN 0141-5433

Would-be authors are welcome to send articles to the Editor but PC cannot undertake to return them. Payment is at £30 per published page. Submissions should be typed or computer-printed across a 40-character width, and include a tape or disc of the program. Handwritten material is liable to delay and error.

Every effort is made to check articles and listings but PC cannot guarantee that programs will run and can accept no responsibility for any errors.

GOVERNMENTS have a habit of trying to "manage" the news, and the timing of controversial bills is one way to do so. It was no surprise, then, that the Home Office's Guidance Note on the Data Protection Bill arrived on the editorial desk on Christmas Eve.

British governments have a bad record when it comes to secrecy. Vast mountains of innocuous and often irrelevant "secrets" are expensively kept secret from the Great British Public — though not, apparently, from any foreigners who want to know, as the recent spate of "spy scandals" amply testifies. Now you might think this would make them keen on having a comprehensive data-protection bill. Not a bit of it. It looks as though the government has been pushed into tabling the current bill only for commercial reasons.

What interested parties such as the British Medical Association want is a fully-fledged data-protection authority, as was recommended by the Lindop Report in 1978. This DPA would naturally want to guard against the misuse of all data, including written records, as medical records are by and large still not computerised. The government certainly does not want a powerful Lindop-type DPA. A cynic might suggest this is because the government's own agencies are among the main misusers of such data. In any event, the data-protection bill now scheduled for Parliament only applies to data held on computers.

The commercial reason for this is that the bill represents the minimum that will enable the U.K. to ratify the European Convention for the Protection of Individuals with regard to Automatic Processing of Data, which we have already signed. Without this ratification, British companies stand to lose millions of pounds

worth of business processing data for other EEC countries.

There is another way in which the bill will benefit the British computer industry: hardware and software will have to be modified to meet its conditions. According to the financial memorandum which accompanies the bill, the government will have to spend £5½ million on this in the first two years. Local authorities and other public bodies will probably have to spend around four times this amount. The cost to private companies could be enormous.

The bill says, "appropriate security measures shall be taken against unauthorised access to, or alteration, disclosure or destruction of, data and against accidental loss or destruction of data." The computer expert who can guarantee that kind of security stands to make a fortune.

The subject of data items is allowed access "at reasonable intervals and without undue delay or expense", and to have data corrected or erased. However, Part IV includes a large number of exceptions including that catch-all of "national security purposes". Specific exceptions include data used for crime detection, the assessment of any tax or duty and immigration control. In addition, the Secretary of State is empowered to prevent a subject having access to health and social work data.

Home-computer users will be relieved to learn that they will not have to register their personal databases. As with home tape recording, the individual is beyond the reach of the law. And in any case, such data is not likely to prove damaging in the long run. But there is no reason why, for example, tax records or the Police National Computer should be similarly beyond the law. If they are, 1984 threatens to arrive right on cue.

5 Years ago ...

1 2 3 4 5 6 7 8 9 10 11 12 13 14 15 16 17 18 19 20 21 22 23 24 25 26 27 28 29 30 31 32 33 34 35 36 37 38 39 40 41 42 43 44 45 46 47 48 49 50 51 52

This year's Intel Fair proved to be more than just the formal announcement of the Intel 8086 microprocessor.

There were some important announcements on new software available for the now-established 8080 microprocessor and some impressive exhibits.

The 8086 is the highest-performance Intel computer to date, and, claims Intel, "capable of providing a performance equivalent to today's top-of-the-range mini-computers".

The 8086 is source-code compatible with the 8086A and with 8085 via a translator package which will convert most of the 8080/8085 source code into code for the 8086.

The 8086 provides all the features of the 8086A plus

16-bit arithmetic, signed eight- and 16-bit arithmetic (including multiply and divide), interruptible byte string operations and improved word manipulation.

Also included are such minicomputer-type features as re-entrant code, position-independent code and dynamically relocatable programs.

For commercial applications the 8086 is capable of addressing just over one megabyte of memory, by means of a bank of registers designated the segment register file which is used to augment the 8080-like 16-bit (64K) addressing capability. Basically four bits are added to the addressing signals which allow for the selection of 16 64K segments.

33 34 35 36 37 38 39 40 41 42 43 44 45 46 47 48 49 50 51 52

Avoiding the cowboys

LAST YEAR I began to consider the purchase of a microcomputer. Bearing in mind what I wanted to do and how much I could afford, the Sharp MZ-80B with a P6 printer and twin floppies emerged as the system I should buy. I read all I could about the equipment, and not a bad word was written: flexible, very reliable, a winner if ever there was one. "This sounds like the one for me", I thought.

Because I was unsure from where to buy the equipment — I was looking for a reputable supplier who could, if things didn't do quite as they should, provide the necessary service to put things right — I wrote to Sharp who subsequently advised I consult a particular dealer. I visited the dealer, and being satisfied to that point placed an order.

The equipment was delivered a little late — but never mind, it's my new toy. Within six days the printer packed up: the printer head moved across the roller, but the pins wouldn't fire. I returned the printer and within two days got it back. Hurray! Within ten minutes the printer failed again. This time the dealer collected it. After seven days I got it back again. On each occasion the printer was returned to Sharp at Manchester for repair. The dealer didn't seem to know how to repair it, even though it was alleged only to be a fuse on the first occasion.

Surprise, surprise, another seven days — you guessed it, the printer failed again. To add insult to injury, the dealer suggested that the processor was at fault and was causing the printer to fail. This from someone who couldn't even mend a fuse.

At this I wrote to the dealer and to Sharp, sent the lot back and

placed the matter in the hands of my solicitors. That was the beginning of June. They're still trying to sort out the mess.

However, upon making further enquiries I still receive noises that MZ-80Bs are reliable, fantastic and all that. Since the MZ-80B had the spec I was seeking I thought: "Well, the one I had might just have been one of the last they made on a Friday afternoon — even if it was made in Japan." So I sent out 10 enquiries to all parts — from Aberdeen to Newton Abbott — to all those who I could find who advertised they supply MZ-80Bs. Only five bothered to reply even though a replied-paid envelope was included.

I thought it would be a good idea to see a system up and running — ideally one of those many satisfied user I keep hearing so much about. Of the first three dealers I approached the idea of giving away customers' telephone numbers is definitely against policy. Although I still continued to hear fantastic noises praising Sharp systems, no one was able to produce one.

What do you have to do in this world to buy a micro without running the risk of being taken for a ride? All I want is a micro that will do the things people keep on saying it will do.

**J W. Russell,
Cannock,
Staffordshire.**

● Mr Russell finally purchased an MZ-80B from a local camera shop for £886 including VAT, but it is unable or unwilling to supply discs and a printer. He is still looking for them.

Commercial software

THE PATENT LACK of understanding of British industry in *Practical Computing's* January editorial goes a long way to explain why computers have not generally been used industrially at anything other than the essentially trivial order-processing or accounting level.

Contrary to your assertion — or more accurately the NCC's, which you endorse — most middle managers, at least in the engineering industry, are only too keen to use computers. The problem is that the computing industry has not delivered. There are two approaches to, for example, computerising production — the in-house and the package. Developing in-house software is prohibitively expensive. DP people might be paid an average £18,500, middle managers are most certainly not. The package approach is equally fraught: the vast majority of packages require company systems to adapt to computer industry-designed concepts

rather than the reverse. A case of tail wagging dog?

The first company to produce a flexible materials-management system — or, more strictly, a meta system — can be assured of a large market. What is needed is a structure capable of assimilating existing, proven heuristics and running the result on a variety of mainframes and minis. Then watch things happen.

In the meantime, stick to your last. Micros are great toys but of little relevance to the mainstream industrial scene.

**S. Zetie,
Maidenhead,
Berkshire.**

Pub stocktaking

WE READ with interest the article, Stock Answers from a Husky in the January issue. We "trainers" do quite a lot of work with tenant and free-house publicans in the South-West, and we know several publicans who run their own stock-control programs using microcomputer

equipment costing under £600 including printer and floppy disc.

Our personal experiences with the few publicans installing their own microcomputers — out of the 300-plus we have met in the last two years — are that it is the computer-enforced change of approach, from the slap-happy, leave it to next week, my accountant will do it approach, to the methodical routines required by the computer that brings about the real saving. The computer ensures stock is counted, checked and watched, and that theoretical takings coming from stock consumed, valued at bar-sale price-list value are regularly compared with actual takings.

God bless this black box, the computer. We have tried all ways to persuade publicans that stock control is probably more important than money control. The black box converts them in two minutes.

One point: why does the stock-taking profession still deal with dozens and tenths of dozens? Surely it is history, harking back to the time when valuations had to be carried out by ready-reckoners, etc. Our home-grown micro program converts dozens to units — it's only a two-line input. After all,

in the pub trade a bottle is a bottle is a bottle, not a 1.2 bottle.

**K Mayman and G Tarling,
Bristol Polytechnic.**

BBC disassembler

ON ENTERING the disassembler program for the BBC Micro printed on pages 136 to 138 of the January 1983 issue of *Practical Computing* I found two mistakes, one obvious and one not so obvious, that readers may be interested in noting before getting too exasperated.

The first one occurs on line 260, where a portion of the line appears to be missing. The line should read:

```
260 DATA "A", " "
      "&...", " "&...
      "&...X", " "&...Y", " "&...
      "&...X", " "&...Y",
      " "&... " "&...X",
      "("&...Y", "("&...)"
```

Each data string should contain seven characters including spaces.

The other mistake is on line 800 where the last number on the line should be 77E not 67E. This corrects op code 7E to

ROR nnn, X

not ROR nnnn as it would be if line 800 was left unaltered.

However, once corrected, the

(continued on next page)

Our Feedback columns offer readers the opportunity of bringing their computing experience and problems to the attention of others, as well as to seek our advice or to make suggestions, which we are always happy to receive. Make sure you use Feedback — it is your chance to keep in touch.

(continued from previous page)

program runs beautifully, and very quickly. I find it very useful indeed.

**Martin Cresswell,
Sutton Coldfield,
West Midlands.**

● We apologise for the fact that part of line 260 went mysteriously missing. It was on the listing we sent for reproduction.

JOHN LEACH'S excellent disassembler for the BBC Micro published in the January issue can be made still more informative using these additions and amendments — see panel.

Operating-system calls are identified and labelled in the right-hand ASCII character column. Reducing the Tab settings in lines 1250, 1380 and 1500 by two or three positions will centralise the display on the screen.

**Elvin Ibbotson,
Iddridgehay,
Derbyshire.**

Chalk and talk

IT IS UNFORTUNATE that in the editing of my article on Prolog for historical simulation published in the December 1982 issue under your title Revolution in Education you imputed to me views that I do not hold. You added an introduction: "Gone are the days of blackboards and textbooks if Richard Ennals' ideas catch on", implying that the use of microcomputers was intended to replace such conventional means of teaching.

The point of using logic in the classroom and logic as a computer language is to extend the student's learning capacity, providing a more powerful context for the use of blackboards and textbooks, which will have a role as long as children are taught in schools.

**Richard Ennals,
Hampton,
Middlesex.**

Humble pi

THE WRITER who described the Sharp PC-1500 in the survey of portables — January issue, page 101 — states that "divide 22 by 7 and π is approximated to 10 significant digits".

It is not. It is approximated to less than four significant digits. You can write as many or, indeed, whatever decimal digits after the first three as you or the computer pleases, but the approximation is no closer.

If you really want a rational fraction that approximates π to 10 digits, use $3,235,853 \div 1,030,004$. Most people use the familiar and easily remembered $355/113$, which is correct to six decimal digits.

**R A Fairthorne,
Farnborough,
Hampshire.**

"Primitive" misleading

THANK YOU for including details of our Addressbook mailing list package in the January issue of *Practical Computing*. While the facts quoted are accurate, I am rather concerned that your description of this software as "unashamedly primitive" may convey a somewhat misleading impression.

Addressbook is undoubtedly simple to use, but the capability has not been sacrificed to achieve this. In fact, the range of facilities provided rivals that available in the "middle range" products to which you refer. Sophisticated selection, including "soundlike" comparison, sorting, updating and reporting facilities are all supplied as part of the standard product.

Addressbook owes its simplicity and power to the fact that it was produced using our Fronrunner application-generation package. Anyone looking for user-friendly data-management software for an application

other than mailing-list management is advised to look at Fronrunner, which at £190 may well be the answer to their problems. They will certainly find that definition of data-entry forms, data-checking rules, etc. can be easy and straightforward.

**Jenny Philips,
Decision Technology,
East Molesey,
Surrey.**

United we stand

AS THE OWNER of a ZX Spectrum I am fed up with the running argument between Spectrum owners and BBC owners as to which is the best buy. It is obvious to anyone with half a brain that the BBC is a better-quality machine than the Spectrum, but I can show that the Spectrum can be expanded to equal the BBC for less than the difference in price but at greater trouble.

The point is that both machines are British and as such it should be obvious to the owners of British machines that there are many imported machines on the market. The machines are claimed by their manufacturers to be, for example, "the finest home computer that money can buy" or "the Oric 1 is the professional alternative for home computing".

So let's stop stabbing each other in the back, or these other computers are going to attract sales from potential Sinclair or BBC buyers because the buyers don't want to get mixed up with the argument. This means that software and hardware will not have such a big market and will therefore cost more.

One final note. It has been suggested by many that the forthcoming Acorn Electron is intended to be a Spectrum beater. This is not the case. The Electron is primarily intended to do for Acorn what the Spectrum or ZX-81 does for Sinclair. It is supposed to make money.

**L Dundon,
Tidworth,
Hampshire.**

Bad taste

I FIND your editorial in the January issue in somewhat bad taste. Like many others, you make assumption that information technology begins and ends with an underpowered

microcomputer with no practical software.

There are a large variety of products on the market, and a recent promising trend for systems to be actually made in the United Kingdom rather than imported at inflated prices. Unfortunately a large amount hardware is totally unsuitable for use in a business environment, and the number of good program packages available is very small. Perhaps 1982 should have been named "the year of the computer cowboy".

Undoubtedly management would be willing to accept systems when they can see them working reliably, and will buy them from a supplier who will be in business in the future, can service the equipment when it breaks down, and employs staff who understand the requirements of an end user.

On another aspect of IT, if you wonder what has become of Prestel you might be interested to know why we are not selling it; British Telecom wants to charge us £275 to be registered, 15p per minute connect time, plus 70p per minute for the call on top of the charge per frame.

Finally I might add that I do sell microsystems, I am pleased to be a member of a professional body, the BCS, but am not married, have no children, and certainly do not live in Surrey.

**Jim Watt,
Future Systems,
Gibraltar.**

Spectrum security

FOR SOME MONTHS I have been using a code routine for the ZX Spectrum which incorporates the Line command. It occupies 245 bytes as it stands, but by reducing on-screen comments to a minimum it can be fitted into 117 bytes if memory is short. It has the advantage that any combination of characters can be used for the code, Z\$, and it can be of any length.

It is also easy to change, so could be altered every day or every week if required. The number of attempts permitted can be varied by changing line 9994.

The main program starts at line 10, but must end with a Stop statement to prevent it running into the code routine. It should be Saved in autostart mode:

SAVE "name" LINE9990

It goes without saying that the

(continued on page 13)

BBC disassembler.

```
225 FOR I=1 TO 13: READ OS$(I), OS(I): NEXT
265 DATA OSFIND, & FFCE, OSGPB, & FFD1, OSBPUT, & FFD4,
OSBGET, & FFD7, OSARGS, & FFDA, OSFILE, & FFD5,
OSRDCH, & FFE0, OSASCI, & FFE3, OSNEWL, & FFE7,
OSWRCH, & FFEE, OSWORD, & FFF1, OSBYTE, & FFF4, OSCLI,
& FFF7
1510 IF NBYTE% < 3 THEN 1540
1520 MOS$ = " " : FOR I% = 1 TO 13: IF
LEFT$(SMOSHOW%,5) = OS(I%) MOS$ = OS(I%)
1530 NEXT : IF MOS$ <> " " PRINT MOS$ : GOTO 1560
1540 FOR I% = 1 TO NBYTE% : Q% = PCGET%(I%) :
IF Q% > = & 20 AND Q% < & 7F PRINT CHR$(Q%) : ELSE PRINT "
"
1550 NEXT
1560 PRINT " " : ENDPROC
```

NEC PC-8000 Personal Computer.



NEC turns 28 years of computer experience to your personal advantage.

It takes a great computer company to make a great personal computer. And from the start, NEC has been a pioneer in computer technology. In fact, we invented the all-semiconductor computer in 1959. Now, hundreds of innovations later, we've made it personal.

We present the PC-8000, a powerful and friendly business tool that can help you get more done in a day than you ever could before. It combines some of the most reliable hardware on the market with application packages designed to make the most of its unique features. In addition, the PC-8000 accepts popular CP/M® business software, making its possibilities virtually limitless.

The entire PC-8000 system is now available through better computer dealers across the country. And that means more than hardware. It means effective software, the finest documentation and extensive training to help you get the most from your personal computer. So why not turn our system to your personal advantage now.

(CP/M is a registered trademark of Digital Research Inc.)

NEC
Nippon Electric Co. Ltd.
Tokyo, Japan

NEC BUSINESS SYSTEMS (EUROPE) LTD.
NEC House, 164/166 Drummond Street,
London N.W.1 3HP UK
Telephone: 01-388-6100 Telex: 261914.

Write for more information
about the NEC PC-8000.

NAME _____
COMPANY _____
ADDRESS _____

Attach this coupon to your letterhead and mail it to NEC BUSINESS SYSTEMS (EUROPE) LTD., NEC House, 164/166 Drummond Street, London N.W.1 3HP, U.K.

● Circle No. 104

Let Commodore expand your horizons.

VIC 20 is the finest home computer that money can buy.

And the better you get to know it, the more confident, adventurous and ambitious you'll become.

You'll want to take advantage of the vast range of VIC software: a superb and constantly-growing selection of programs, embracing business systems, entertainment, education and many applications in the home.

Every program in the series has been designed by experts, and chosen for its quality and value for money.

VIC business software covers a wide range of applications, including spread-sheet analysis, stock control, information handling and word-processing.

A mind-blowing range of games including Scott Adams' world-famous 'Adventure' series.

Advanced space games, including the sophisticated 'Omega Race'.

Learn subjects as diverse as English Language, programming, and biology.

And 'home' software ranges from IQ tests to Robert Carrier menus.

In addition, there is a range of VIC software, like programmers' aids and graphics packages—



to add to your understanding and enjoyment of computers and computing.

There's even a special 'VicSoft Club' for VIC 20 enthusiasts, with many advantages including special offers to club members.



VIC software will expand your horizons. And your mind.

PRICES RANGE FROM £4.99 to £24.95 INC. VAT.

commodore
VIC 20

● Circle No. 105

For more information, a catalogue of VIC software and details of your local retailers or dealers please phone or complete the coupon and send to:
The Commodore Information Centre,
675 Ajax Avenue, Slough, Berkshire SL1 4BG.
Telephone: Slough (0753) 79292.

Name _____

(MR/MRS/MISS) _____

Address _____

Postcode _____

VCPCO 03/83

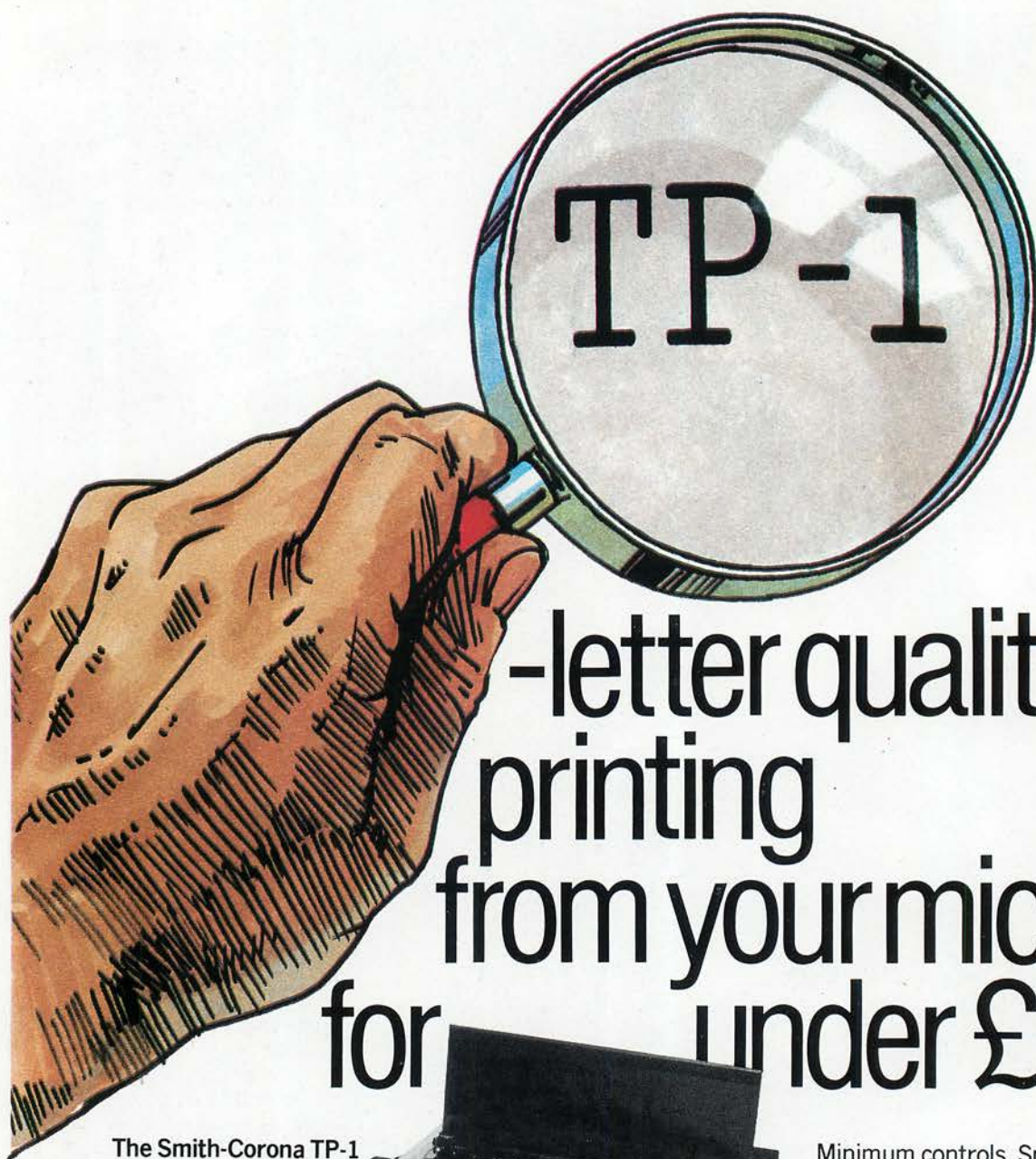

-letter quality printing from your micro for under £500

**The Smith-Corona TP-1
Daisywheel Text Printer.**

Fully formed executive quality printout. Letters of real character. For the price of a matrix printer.

The TP-1 costs just £485, plus VAT. Interfaces with all popular microcomputers (Serial, Parallel and IEEE).

Can be used with word processors or small business systems.



Minimum controls. Snap-on daisywheels. Drop-in ribbon cassettes. The TP-1 is as easy to use as it is readily affordable.

Now letters, documents, forms, reports, price lists and data sheets — all can be printed with the image you deserve.

For instant information, complete and mail the coupon.

Butel-Comco Limited
Garrick Industrial Centre,
Garrick Road,
London NW9 6AQ.
Telephone: 01-202 0262/2277
Telex: 47523

BUTEL
Technology for business

To: Butel-Comco Ltd., Garrick Industrial Centre,
Garrick Road, London NW9 6AQ.

Yes, send details of the TP-1.

Name _____

Company/Occupation _____

Address _____

_____ Tel. _____

Computer details:

Make _____ Model _____ Interface _____

Software application _____

Code routine.

```

9990 LET c = 0 : LET Z$ = "12345"
9991 PRINT "Enter code:."
9992 INPUT LINE Y$: CLS
9993 IF Y$ = Z$ THEN GOTO 10
9994 LET c = c + 1 : IF c > 1 THEN NEW
9995 PRINT "Not correct. Enter again!": PRINT ""
9996 PRINT FLASH 1 : "If not not correct this time program will be
deleted."
9997 GOTO 9992
    
```

(continued from page 8)

code should be easy to remember. Using the first act of *Macbeth* will ensure that programs are very secure, but is a little prone to typing errors and lapses of memory.

W H Roberts,
Pencoed,
Mid-Glamorgan.

Knigh's square route

I BELIEVE that the answer given to the November puzzle is not the best. The sequence:
2 + 3 × 5 × 7 × 8 × 9 × 4 - 1
gives the result of 50,399

Andrew Burton.
Tarpoley,
Cheshire.

Spectrum supporter

AFTER READING Bill Nichols' letter in January's *Practical Computing* I decided to inform you of my experience with Sinclair. Mr Nichols' letter is completely truthful, in fact I received my Spectrum in 24 days.

In answer to Simon Clark's letter, I should like to say I am delighted with my Spectrum. I have used a BBC Micro often at school and find it very good, but I prefer the ZX Spectrum. Although, on paper, the BBC is the better computer, I find the Spectrum's Basic beautifully easy to use.

As for the criticisms of the keyboard and Basic entry, complaints are unjustified. The keys were a pleasant surprise and are nice to use. The Basic word entry is easy and very versatile, in fact more so than the ZX-81.

Robert Marsh,
Chesterfield,
Derbyshire.

Apple formatter

I EXPECT that by now Philip Colmer — Feedback, January 1983 — will have found a way round the two quirks that he describes in M J Parrott's Apple text editor. If not, he may like to try my solution.

To prevent Ctrl-L from incorrectly causing the program to rerun, change the JSR at line

45 from \$FDED to \$FDF0. This bypasses DOS so that the print instruction at line 45 cannot be misinterpreted as a DOS command.

If the program is to accept Ctrl-L, Cursor Return, as the last item of a line of text, it seems to me that it is first necessary for the program to be able to find out whether a CR read from the buffer is just that. If it is, then the program should treat it as simply another character in the line instead of forcing a reset. Changes to the source file will effect this. After line 136, insert:
137 INY
138 CPY TEXT
139 BEQ PATCH
140 DEY

After old line 151, now line 155, insert:
156 PATCH DEY
157 JMP PUTIT

W Anderton,
Hampton,
Middlesex.

Football crazy

ON PAGE 21 of January's *Practical Computing* you say that "pools prediction programs require data to work on, the more the better". While this is true of some programs it is certainly not true of all.

The former type operate on the principle that, if a given sequence of results occurred at some in the past then that same sequence is likely to be repeated this week.

A much more reliable method is based on current form, obtained easily from league tables and published sequences of recent results. Mayday Software currently offers such a program. It is called Predict and runs on the BBC Micro, models A and B and costs only £4.99.

Users can easily tune it themselves without any reprogramming by simply changing the weightings given to each prediction, thus constantly improving the predictions.

A G Ashley,
Mayday Software,
Stanmore,
Middlesex. ☐

Kuma Computers Limited

11 York Road, Maidenhead, Berks. SL6 1SQ
Tel: (0628) 71778/9 Telex: 849462 TELFAC KUM



PROFESSIONALS IN SOFTWARE APPLICATIONS:INTERFACING

Sirius - 1.

The best price/performance you've ever seen on a personal computer: £2395 + VAT For 128K, 1.2 Mbyte, 16 bit, available software includes:- CP/M86, MSDO, Mbasic, COBOL, PASCAL, FORTRAN. etc.



Osborne - 1: You can take it anywhere. CP/M + 64K RAM, Dual discs interfaces and Wordstar, Super Calc, Mbasic. All for £1250.00 + VAT. Ask us about additional software.



ANNOUNCING THE NEW HX20



Newbrain:

The only professional micro of this size: Phone us for immediate FREE delivery + SOFTWARE CATALOGUE Newbrain AD with onboard display £229. + VAT.

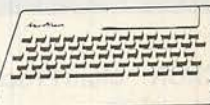

SHARP A + B; Computers and systems with a Wealth of software applications programs.

"WDPRO" Wordprocessing, Database, Accounts, Mail Lists etc. Phone Now for our new Autumn 170 Program Catalogue.



SHARP = KUMA = SOFTWARE

Printers:

Matrix - from £380.00 + VAT.
Epson Mx 80F/T3 NEC (C.itoh)
Daisywheel - from £476.50 + VAT.
Brother 8300 Tec Star Writer

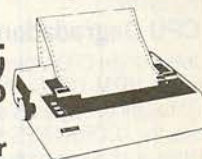

Applications:

Direct experience of office applications, phone us for advice on ledgers, stock control, payroll and word processing.

Software: the established leader for Sharp Computers.

MAIDENHEAD (0628) 71778

Kuma Computers Ltd., 11 York Road,
Maidenhead, Berks. SL6 1SQ.

Tel: (0628) 71778/9 Telex: 849462 TELFAC KUM



PLEASE SEND ME MORE DETAILS ON: Software Hardware

Sharp Osborne Name
Newbrain Sirius-1 Address
PC

● Circle No. 107

What can sixteen CP/M* users have in common?

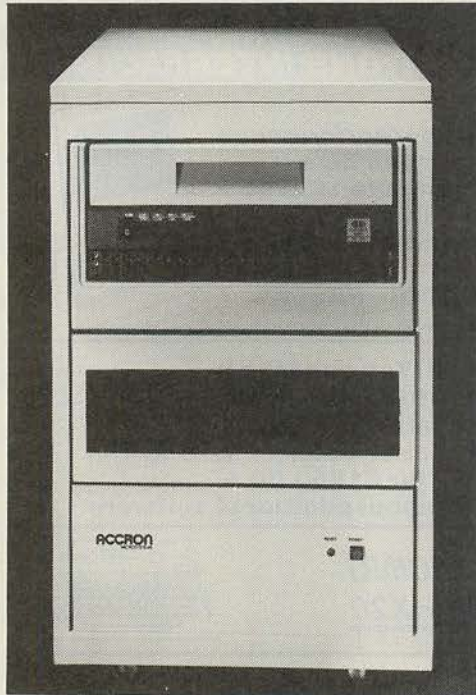

- 17 Z80s running at 4 Megahertz
- 1 Megabyte of 200 Nsec RAM
- 18 Serial Input/Output Ports
- 1 Centronics-type Parallel Port
- 90 Megabyte Shared Cartridge Disks
- 2 Megabyte Shared Floppy Disks
- 4 Shared (Spooled) Printers
- Optional Private Printers
- Running under Standard CP/M 2.2

All in one box!

ACCRON—Multi Processor Series—Microsystem

The ACCRON—Multi Processor Series—microsystem is a breakthrough in low cost high performance multi-user S100 micro computers. Based on the Service/User Processor principle, a single ACCRON—MPS system supports up to 16 users, where each user has its own Z80A, 64KB RAM and an RS 232 I/O Port on a single S100 board. Each User Processor runs under its own dedicated copy of the CP/M operating system. All users share the common resources such as disks, magnetic tapes and system printers. These shared resources are controlled by the Service Processor with its own dedicated Z80A and 64KB RAM running under DPC/OS, a proprietary Distributed Processing Operating System.

Zero CPU Degradation!

Unlike single-CPU timesharing multi-user systems (e.g. MPM, OASIS, MVT-FAMOS etc.) where system throughput degrades as additional users are added, the ACCRON-MPS system has no CPU degradation at all. Since each user has its own self-contained processor and memory you can now have minicomputer performance at micro computer prices.

It's Expandable

You can start with a single-user floppy disk system and (field) upgrade it to multi-user by simply adding a Service Processor running DPC/OS and more User Processor boards as and when required. Large capacity hard disks, magnetic tapes and more printers may be added at any time without any hardware or software redundancy.

CP/M Compatible

Use of the industry standard CP/M operating system means that a wealth of readily available, reasonably priced, system and application software will run on your ACCRON microsystem without any modification. Upgrade to multi-user, where simultaneous access of shared data files is required, is easily supported by the inclusion of simple file or record locking routines.

User Friendly DPC/OS

The Service Processor and DPC/OS provide an easy to understand and user friendly interface for common access to shared resources such as disks, magnetic tapes, up to four spooled system printers or any other peripheral that may be attached to your system (such as a telex-tape punch). Simple routines handle record and/or file locking and prevent "interleaved" or "fatal embrace" file update sequences. DPC/OS allows for both private and shared disk space. Interprocessor message communications, scheduling and batch-submit facilities are also provided.

Complete Range of Peripherals

NEWTONS Laboratories prides itself in offering you the largest choice of microsystems presently made or distributed in Britain. Three distinctive ranges, based on 5-inch, 8-inch or 14-inch magnetic media, utilizing both sealed (winchester) or removable cartridge disk techniques are supported and available NOW! In addition, the ACCRON offers a full blown, industry standard, 9-track reel-to-reel magnetic tape subsystem. So you can store, retrieve and process vast amounts of data using standard 800 or 1600 BPI magnetic tapes that can also be used to interface with most major mainframe computers.

Maintenance

Any system is only as good as its individual components. The likelihood of downtime is minimised through high quality control and testing standards at our UK manufacturing base. Each individual part goes through a rigorous testing procedure during every stage of assembly, and before shipping and installation, the completed machine will have run continuously for 72 hours or more, at temperatures much higher than the average office. However, like all good things in life, sometime or the other your machine will stop working. Our own nationwide maintenance service can, for a fixed charge provide you with a comprehensive maintenance and 24-hour repair service which includes all parts and labour, and,

since we manufacture ACCRON ourselves here in Britain, there is never a delay over waiting for a replacement part.

Stability

NEWTONS Laboratories has been trading (profitably) for more than 7 years. We supply copies of our accounts on request. The computer division specialises in multi-user micro systems, developed and supported by UK based professionals. Its customers include British Telecom, the DHSS, Local Councils, small businesses and large businesses such as BTR and Plessey. NEWTONS Laboratories is involved in continuous research and development.

Dealers and OEM's, Get The Facts

Fill in this coupon now and send it to: NEWTONS Laboratories, 111-113 Wandsworth High Street, London SW18 4JB. Tel: 01-874 6511 (5-lines). Telex: 21768 (NEWTON G).

Name _____

Address _____

NEWTONS
LABORATORIES

*CP/M is a trademark of Digital Research Inc. DPC/OS is a trademark of ACT Inc. ACCRON is a trademark of NEWTONS Laboratories.

● Circle No. 108

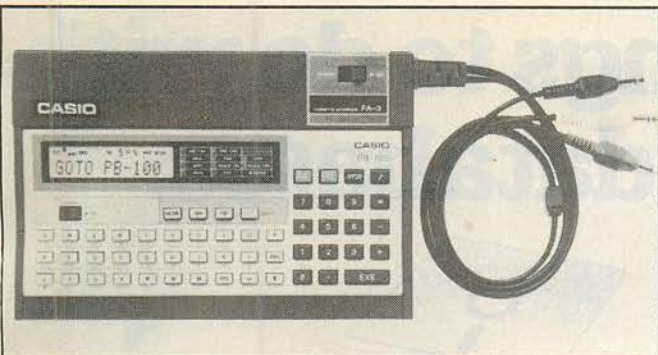

This is the PB-100 pocket computer from Casio. It is designed for the non-specialist in computing. Styled on the existing Casio pocket computers, the PB-100 is aimed at business users, providing them with a number of functions; 10 programs can be stored, with a total of up to 544 program steps. There are 26 memories. Expansion can take the form of extra RAM, allowing 1,568 program steps, or a cassette interface. There will soon be a special printer available as well. The PB-100 comes complete with programming manual and costs £79.95. The RAM option is £13.95, the cassette interface £25.95. Contact Casio Electronics Co Ltd, Unit 6, 1,000 North Circular Road, London NW12 7JD. Telephone: 01-450 9131. □

Speedy Basic from Pet compiler

THE PETSPEED Basic compiler is now available for the Commodore 64. It is a special version, optimised for the new micro, from CBM and can transform a relatively slow Basic program into a fast machine-code one. Petspeed comes complete with documentation and is simple to use.

Petspeed costs £125 plus VAT. For details contact Oxford Computer Systems Ltd, Woodstock, Oxford OX7 1JR. Telephone: (0993) 812700. Petspeed is also available from the Commodore dealer network. □

New lease of life for Apple II

THE REVAMPED Apple II and products to enhance the Apple III, as well as two new printers, are available now. The Apple IIe takes over from the existing Apple II Europlus and is designed to be software and hardware compatible with it. The main unit, now with 64K RAM as standard and a revised ISO-standard keyboard costs £845.

The Apple II main board has been entirely redesigned with a drastically reduced component count, and weaknesses of the original design have been tidied up. PAL video generation is now on-board and a metal punch-out back is provided to take



standard connection sockets to replace the rather insecure old systems of ribbon cables emerging from slots in the back of the machine.

Documentation has been rewritten to make the system as approachable as possible, and has been supplemented by tutorials on disc. Apple is

providing two cards to upgrade the display to 80 columns, the simpler one costing £80, the other £180, but this also provides 64K of additional RAM. A complete starter system, with 64K Apple IIe, and single 116K floppy-disc drive, 80-column card and monochrome monitor costs £1,199. □

Selling boom pleases retailers

MICROCOMPUTERS are now on sale in every High Street. They sold in their thousands in the period leading up to Christmas and look like becoming the most popular electronic consumer item of 1983. For weeks preceding the holiday, tills were bleeping away merrily as proud fathers "invested in their children's futures". Credit cards were flashed and grubby notes exchanged, and the message from the traders is that the home micro made Christmas 82 the most profitable since 1979.

It appears that it took the high-pressure retailing of the large multiple outlets to bring about the microcomputer boom which the industry predicted for a much earlier date. What is now clear is that most retailers did not have the stocks to meet the totally unexpected pre-Christmas demand.

One company to suffer from this problem was Dragon Data, manufacturer of the popular Dragon 32 micro. This is an

ironic twist, because the Dragon 32 was the micro in good supply earlier this year when rival machines were scarce. The problem with Dragon grew to such proportions that in the final run-up to Christmas the company had to close its order book.

Tony Clark, managing director of Dragon Data said: "Repeat orders for the Dragon and enquiries from new customers meant that we were in the enviable situation where demand far exceeded supply. Our production capacity was at full stretch and in some cases we would not fulfil orders or guarantee delivery by Christmas."

Although having a full order book has been wonderful news for Dragon Data it has caused its own peculiar problems, according to marketing director, Richard Wadman. Part of the plan to relieve these problems involves moving to a new and larger factory. The other part is a

rationalisation of the number of outlets carrying the Dragon.

One of the large chains that carried the Dragon 32 is Currys, the electrical retailer. Currys sells both business systems and its software and home computers and software through a network of 10 specialist Micro-C shops and 37 High Street branches of the Currys chain. This network will eventually extend to the majority of Currys stores as staff are trained. It is what the marketing services manager Linda Burrow calls "uncontrolled expansion".

Currys is firmly committed to providing customers with a high level of support, and for this reason only stocks a limited range of machines. The current list of micros for the home user includes the Commodore Vic-20 and Commodore 64 machines, the Dragon 32, the TI 99/4 and both the Atari machines.

Also in the Currys range but only available at the specialist

shops are the Epson HX-20 and the NewBrain computer. Currys looks on them as part of the home-micro range, as opposed to office or small-business machines. The office category starts with the Apple II, which is sold both as a business machine and a games computer. Higher still are the ACT Sirius, the Commodore 8000 range and the Panasonic.

Currys places a lot of emphasis on software. Linda Burrow believes that most people buying a computer buy at least one software package at the same time. More important, most people return to the shop where they bought the machine, to buy the software.

And the future? "The Commodore 64 is going to be a big seller, and we are talking to a couple of other manufacturers right now," says Linda Burrow. "On top of that we have another 15 stores opening computer counters this month." □

More news on page 21

Now that Superfile is here: some good things to do with yesterday's databases.

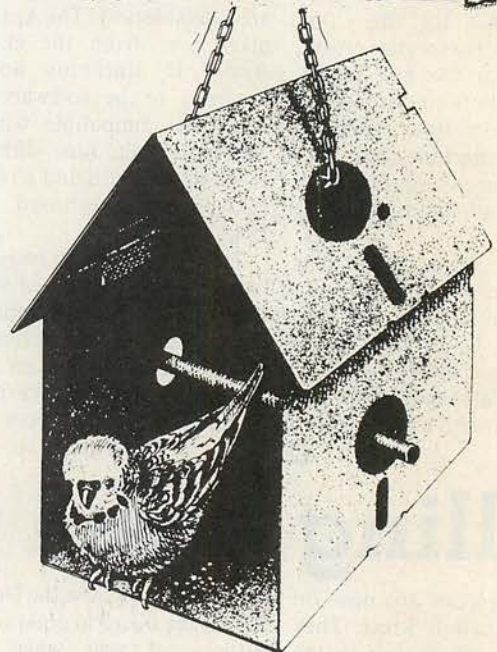
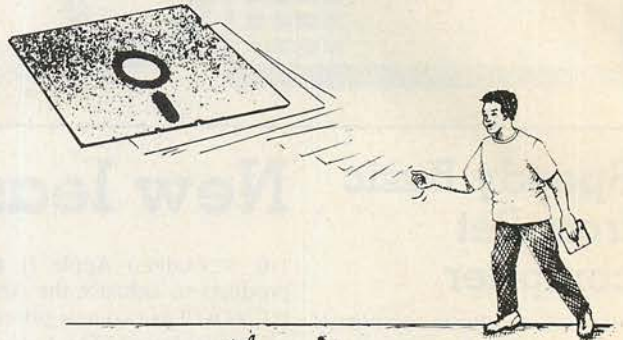
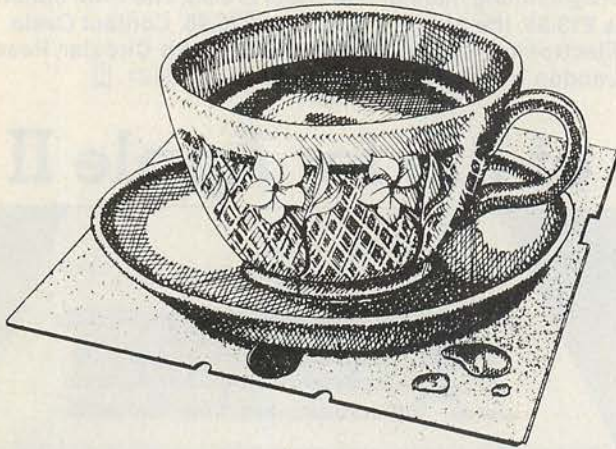

Don't throw those old disks away! An obsolete database could make some budgie very happy. Superfile, the advanced new British database manager, could make you even happier. Just look at the advantages:

- Variable length items – store the data you type in without padding – double your disk capacity.
- Search on all items in the database.
- Flexible records – add new Fields at any time.
- Logically a multi-file database: relational searches easily done via high level language.

- Superfile tacks itself onto CP/M and makes the database accessible to programs in any high level language.
- Simple-to-use Screen Forms and Report generator packages.
- Multi-user – on MP/M, CP/Net, Turbodos, Shelton SIG-NET.
- Made in England and widely used by the Government, Hospitals, schools and Universities.
- Prices: Superfile £225, Superforms £130, Supertab £130, Mailing List £75.

Central Micro Systems (Xerox)
Walsall, Staffs. Tel 0922 26066

KGB Micros Ltd (Superbrain)
Slough, Berks. Tel 0753 38581

Leicester Computer Consultants Ltd (General)
Leicester. Tel 0537 533224 and 0509 37281

Micro Technology (Sharp)
Tunbridge Wells, Kent. Tel 0892 45433

Nastar Computer Systems Ltd (Superbrain)
Chesterfield. Tel 0246 207048

SUPERFILE

THE FREE-FORM DATABASE

Ranmor Computing Ltd (Apple)
Southend-on-Sea. Tel 0702 339262

Sun Micro Services (Shelton)
Brandon, Suffolk. Tel 0842 813476

Tamsys (DSC3)
Windsor, Berks. Tel 95 56747

Transam Micros (The Tuscan)
London WC1. Tel 01-405 5240

8" IBM Format available from Southdata Ltd

Southdata Ltd.

10 Barley Mow Passage, London W4 4PH 01-994 6477 Please quote ref. PC on all enquiries.

● Circle No. 109

GOODBYE TO FLOPPIES C/WP INTRODUCES A HARD DISC FOR £995.

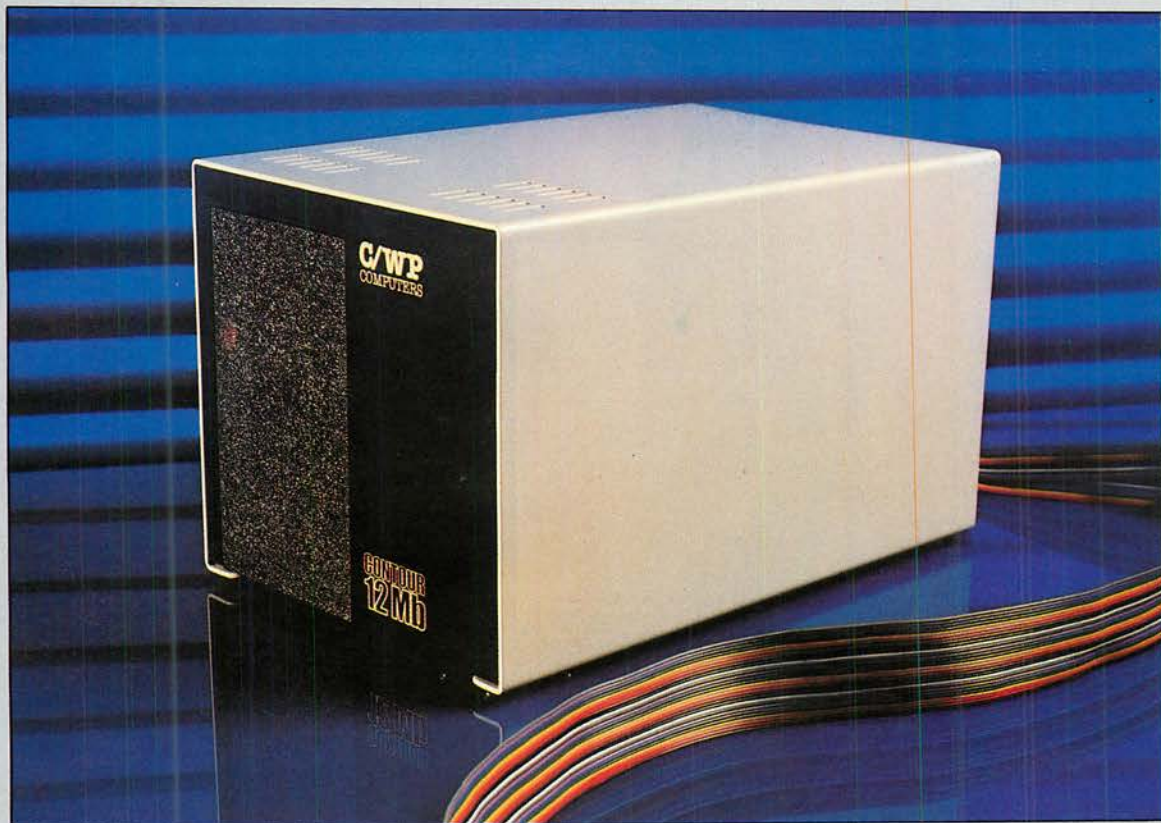

C/WP have done it again. We proudly announce the C/WP CONTOUR, a range of British-made high technology 5-inch Winchester discs at prices starting below £1000.

Suddenly your micro-computer has come of age. One little box, not much larger than a floppy disc drive, stores up to 21 million characters. That size costs £1995 and stores the equivalent of more than 160 floppy discs, or 35 full-length books. And in a maximum of around a fifth of a second the C/WP CONTOUR finds any piece of information your computer asks for.

C/WP CONTOUR is available now for your APPLE II, IBM Personal, Sirius, Superbrain and many other CP/M and S100 machines. On APPLE the C/WP CONTOUR supports DOS 3.3, Pascal and CP/M operating systems.

Write or telephone for full details of this great price breakthrough. Now you can afford the luxury of a Winchester.

C/WP CONTOUR PRICE LIST

3Mb (formatted)	£995
6Mb (formatted)	£1195
12Mb (formatted)	£1595
21Mb (formatted)	£1995
Tape streamer back-up (21Mb 4min)	£1495

All prices exclude VAT

C/WP FOR BIG VALUE IN HARD DISCS

C/WP

C/WP Computers
108 Rochester Row, London SW1 1JP
Telephone 01-828 9000

OUR PROFESSIONAL SERIES INTEGRATED

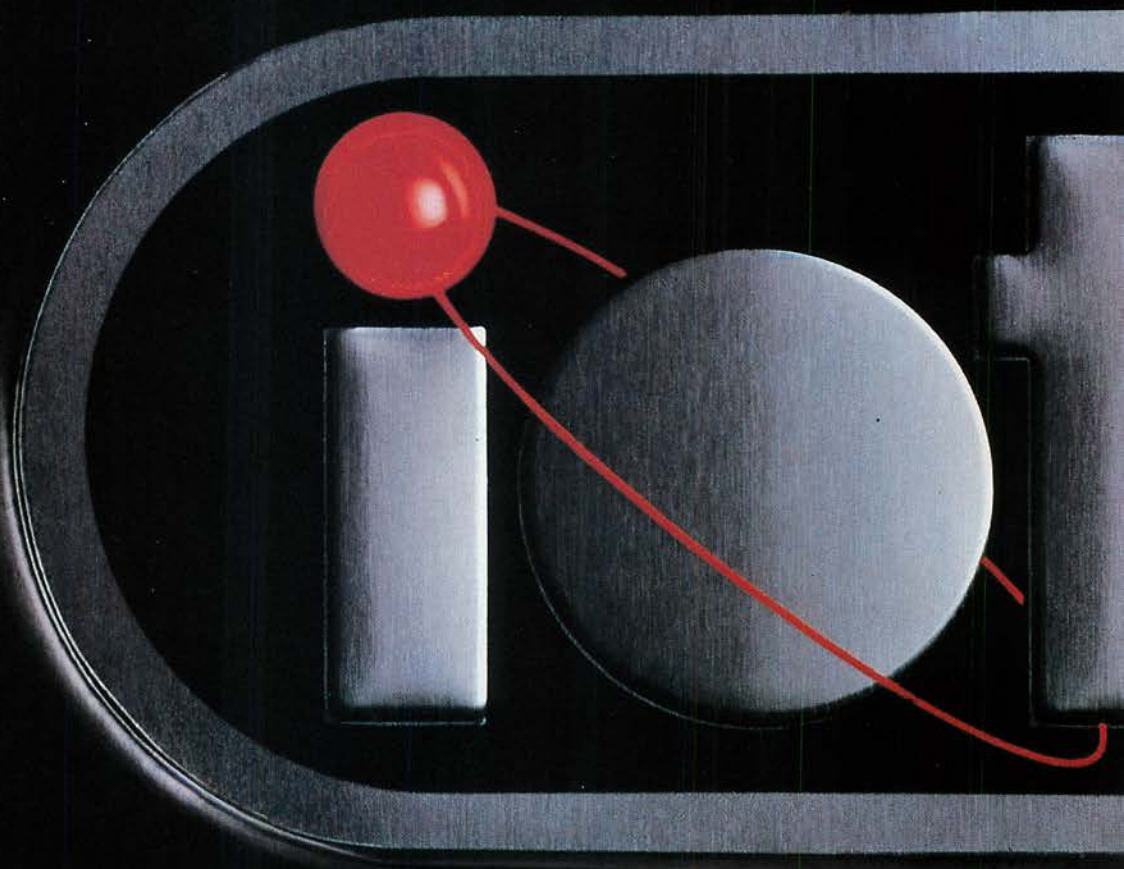

The Hardware

Iona Computer (75K)
Two 5¼" Disk Drives (400K each formatted)
14" Colour Monitor
4 Way Disk Controller
Centronics Printer Controller
Colour CP/M* 2.2 Disk Operating System
CBASIC*

The Professional Series Software

Name and Address System
Stock Control System
Order Entry and Invoicing System
General Accounting System
Company Sales System
Company Purchases System

Other Hardware Products

14" Colour Monitor (Medium Resolution)
14" Colour Monitor (High Resolution)
7 Colour Matrix Printer
*(All Iotec Hardware Products are assembled
in the U.K.)*

Other Languages

Basic 80* 5.2.1

BUSINESS SYSTEMS SOFTWARE IS FREE.

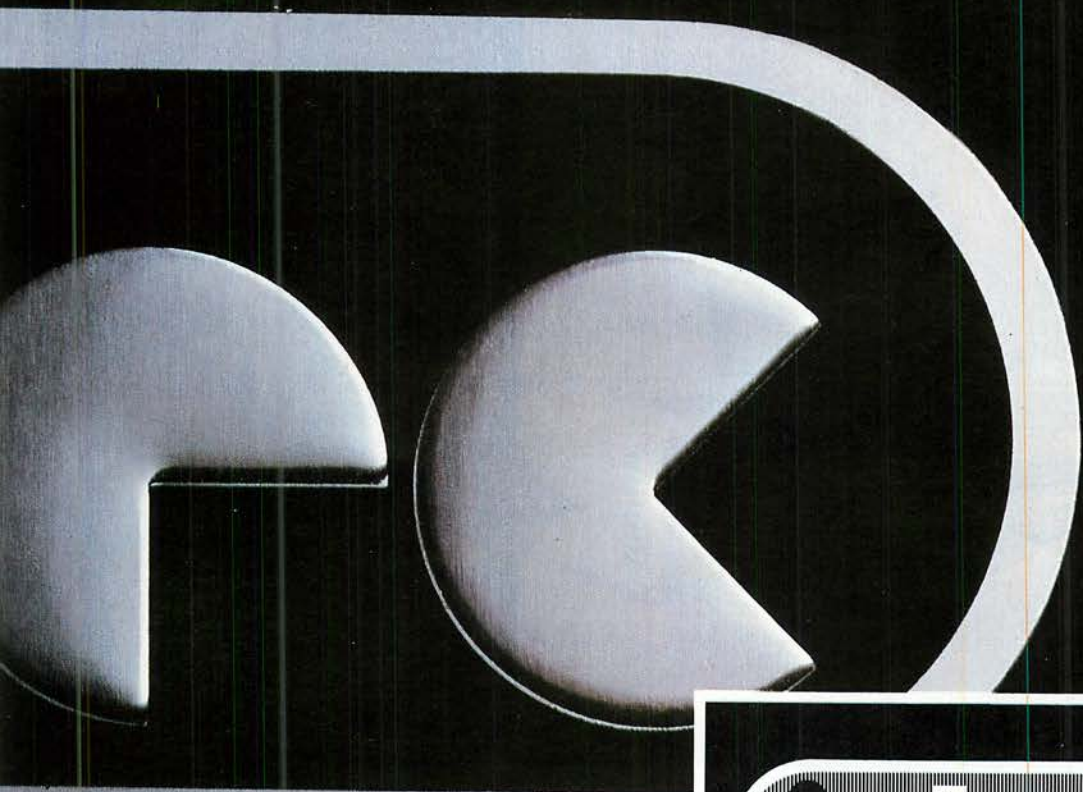

**ASK YOUR LOCAL DEALER
ABOUT THE SPECIAL
FREE SOFTWARE
OFFER**

Other Professional Series Software
Word Processing
Financial Planning
Control System
Lease/Rental and Hire Purchase System
Time Recording System

MS-DOS and CBASIC are registered trade marks of Digital Research
Microsoft is a registered trade mark of Microsoft Inc.
IOTEC is the trade mark of IoTechnology plc

For further details including the name and the address of your nearest IOTEC Business Centre, complete this coupon and send it to the address shown below.

Name (PRINT) _____ Type of Business _____

Address _____

Postal Code _____

IoTechnology plc 4 Playhouse Yard Blackfriars Lane London EC4V 5EX

PC

GALAXY COMPUTER SYSTEM

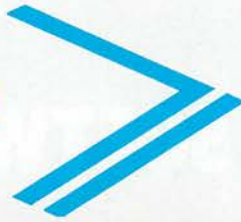

WHATEVER REQUIREMENTS YOU HAVE



GM813 - CPU/ 64K RAM Board

- * 4 MHz Z80A CPU
- * 64K Dynamic RAM
- * RS232 Serial Interface
- * Two 8-Bit I/O Ports
- * 1200 Baud Cassette Interface
- * Extended and Page Addressing Modes

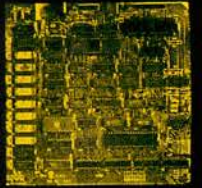

GM812 - IVC Board

- * 80x25 Display Format
- * On-board Z80A Microprocessor
- * Buffered Keyboard Input
- * Programmable Character Generator
- * 160x75 Pixel Graphics
- * Light Pen Input



GM 829 - FDC/ SASI Board

- * Single/Double density operation
- * Single/Double sided drive operation
- * Up to 3 mixed 3.5", 5.25" and 8" drives
- * Industry Standard SASI hard-disk interface



**TWO
SPARE
SLOTS**

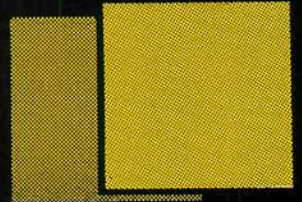

The cost-effective solution to your computer needs for only **£1,495***

For just £1,495 the Galaxy 2 provides the basic requirements for a small business system:

- **Central Processor Unit with 64K of RAM**
- **Twin disk drives (400K storage per drive)**
- **Keyboard and 12" monitor**

But unlike many other small-business systems the Galaxy System is specially designed for expansion and flexibility to meet changing requirements. It uses the world's best selling micro processor, the Z80A, and is based on industry-standard 80-Bus boards. The business system uses only 3 boards in the 5 spaces available, so extra cards can be "plugged-in" to expand the system; for example to expand the memory, or to give a colour facility, or to develop the Galaxy for the particular requirements of education, research, software development etc.

It has a CP/M operating system which gives access to the largest range of software available for any machine. In particular, Gemini can offer QUIBS; a small-business package developed especially for the Galaxy.

The Galaxy has industry-standard interfaces (parallel and serial), and Gemini Microcomputers can supply a full range of compatible hardware including a Winchester sub-system and printer.

The Galaxy offers the most cost-effective way of obtaining a basic unit which is capable of developing to meet your particular requirements; now and tomorrow.

Features include:

- Twin Z80 Processors
- 64K Dynamic RAM
- 800K Disc Based Storage
- 80 x 25 Screen Format
- Dual Printer Interfaces
- Modular Design
- Extra Disc Drives Easily Added
- Winchester Expansion Available
- Net Working System Available
- Additional Slots for 2 Cards
- 12" Green or Amber Monitor



*Price is exclusive of VAT



 Gemini Microcomputers

Oakfield Corner Sycamore Road Amersham Bucks HP6 5EQ

● Circle No. 112

Provincial shows pull in crowds

WITH AN ATTENDANCE of 23,073 visitors in only three days the Northern Computer Fair was an unqualified success. Held at Belle Vue, Manchester, the exhibition attracted not only a large number of home-computing enthusiasts but also a substantial body of professional and business people with a strong practical interest in personal computers.

This interest was particularly evident on the stands featuring the ACT Sirius 16-bit micro-computer which included those of Raven Computers, MCP Microsystems and The Micro House — all specialists in small business systems based in the north of England.

Other stands which attracted the crowds included Dragon Data, whose Dragon 32 must have been one of the best-selling home computers at the show; and Computers, which was introducing the 48K Lynx at a price of only £225.

Following the success of the Northern Computer Fair, the third in this nationwide series of exhibitions will be held in Birmingham from April 28-30. This event, the Midland Computer Fair, will take place at Bingley Hall in the centre of Birmingham and it is expected that it will attract visitors in similar numbers to the Manchester show. Companies wishing to obtain further information about this exhibition should contact the Exhibition Manager, The Midland Computer Fair, IPC Exhibitions Ltd, Surrey House, Throley Way, Sutton, Surrey SM1 4QQ or telephone Roy Bratt on 01-643 4859.

Perfect Writer

ON PAGE 103 of the February issue we reviewed Perfect Writer from Perfect Software. If you would like further details the address is Perfect Software, 1,400 Chattuck Avenue, Berkeley, California, Ca 94709. Perfect's products are distributed by Micro Marketing International, 598 Taft Ave, Oakland, Ca 94618. Please mention *Practical Computing* if you are contacting them.

Apple, DEC and IBM set to compete for executive market

FOR THE FIRST time the giants of the computer field are to meet head-on — in the professional personal-computer market. The significance of the plans revealed by IBM, DEC and Apple are that each at present holds the dominant share in respectively the mainframe, minicomputer and microcomputer fields. And each is adopting a different strategy in an attempt to take the personal computer prize.

The IBM PC is to be available immediately in the U.K. through official IBM channels. Full details on the micro itself and associated new products appear on page 35 of this issue. Support is to be available on a standard 24-hour turn-round basis to clients who bring the problem machine in to IBM service centres, four of which are being set up immediately.

DEC has announced dealers, software and support arrangements for the Rainbow 100, Decmate II and Professional range of computers. Volume sales commence in March, although a few machines might have come in earlier. The support arrangements are considerably in advance of those usually provided by hardware manufacturers at the personal computer end of the market.

Free for the first 12 months and probably for around seven percent of the system price per annum subsequently is on-site hardware maintenance. During

The IBM PC should sell on the IBM name, despite its price.



DEC offers the Rainbow 100, Decmate II and Professional.

the working week an eight-hour turn-out is guaranteed. To fix less serious faults and software problems more quickly DEC has set up a 35-person unit to give 24-hour telephone cover. Details of the hardware and software configuration sold to all DEC users will be held on a multi-terminal DEC computer system at the Basingstoke location of the unit.

Prices, with on-site service for 12 months included, are £2,360 for the Rainbow 100, £2,528 for the word-processing oriented Decmate II, and £3,348 for the Professional 350. The Rainbow 100 is the most direct challenge to established microcomputer vendors, and for the price quoted comes with twin 400K floppy-disc drives, 64K of RAM, keyboard and monochrome display. With two processors — a Z-80 and an 8088 — it can run either eight-bit CP/M or 16-bit CP/M-86 software under its CP/M-86/80 operating system. MS-DOS is available as an option.

DEC has produced the first addition of its quarterly Classified Software Catalogue. It includes all the well-known names of the microcomputer software world such as Peachtree, Graffcom, Visicorp, Micropro, Compsoft and Microfocus. Some less well-known DEC specialists also appear, including Intelligence

(Ireland) Ltd., which specialises in communications and terminal emulation software.

The catalogue is particularly strong on the system software side, with languages like C, Mumps, RTL/2 and several versions of Cobol available. The more unusual offerings in microcomputer terms are generally for the PDP-11 compatible Professional 325 and 350 machines.

The DEC software scheme is very tightly controlled. Once software is accepted for sale through the DEC distribution chain, DEC takes over the actual process of copying it on to disc, and print the paper documentation to ensure consistency of quality. DEC supports the package via its telephone support service, free of charge for the first year.

Apple is defending its stronghold in the personal-computer market with extensions to the existing Apple



Apple is banking on novel integrated software for its Lisa.

II and Apple III product ranges, and by the introduction of the Apple Lisa. The Lisa was announced in January and will be available in the U.K. and Europe in the summer. It is previewed on page 77 of this issue.

There is no operating system visible to the user in the conventional way, and no operating-system commands to remember and type in. Instead the mouse, a hand-held pointing device, is used to select options and control events on a detailed graphic representation of a desk top.

(continued on page 23)

From Apple, The Inventors Of The Personal Computer.



EVOLUTION.

Since Apple brought the power of computing to the desk tops of ordinary people with the Apple II, the world hasn't been the same.

Neither has Apple.

We've been refining and improving the way our machines work, to improve the way you do.

So if an Apple was always designed to make you a better businessman, today it will make you an even better one. And faster too.

At last, a machine to beat the Apple II.

The new IIe has an extended memory of 64k (easily expandable, too).

So you can create fatter files and juggle larger numbers.

It has a new, refined keyboard with user-programable function keys, full cursor controls and auto-repeat on every key.

The IIe also features improved peripheral ports, 16-colour graphics and access to the biggest library of software in the world.

Apple III. Pound for pound the most powerful you can buy.

The Apple III now has a standard memory of 256k.

Apple III also has its own personal mass storage system called Profile and a vast selection of business software that takes advantage of the extensive capacity Profile offers.

Apple LISA: Give it 20 minutes and it will change your life.

With LISA, Apple comes full circle to yet another computer revolution. LISA is a personal office system that works by representing the visual symbols of your desk on its screen.

Files look like files. A calculator looks like a calculator. You simply point to what you need with a desk-top device called a "mouse."

If you want to print something, you just point to the printer.

LISA is so simple and easy to use that people with no experience of computers will be happily using one in 20 minutes.

There are already 600,000 Apples making people and their businesses more efficient and profitable around the world. With the IIe, III and LISA, there are going to be a lot more.

Because now there's an Apple for everybody. And everybody should have a friend like Apple.

The personal computer.  apple



Please send me further information on Apple Personal Systems. Tick appropriate box below. Apple Computer (UK) Limited, Eastman Way, Hemel Hempstead, Herts. HP2 4BR. FREEPOST. Tel: 0442 60244

IIe. The Personal Professional Computer.

III. The Personal Business System.

LISA. The Personal Office System.

Name _____

Company/Address _____

Tel. No. _____ PC1

Apple is a trade mark of Apple Computer Inc., USA.

REVOLUTION.

• Circle No. 11:

(continued from page 21)

The same approach has been used successfully on the up-market Xerox Star executive work station and the ICL Perq CAD work station. The Lisa is aimed firmly at the office sector, where Apple is looking for substantial fleet sales, and is the top of the Apple range. It costs \$12,000, which might translate to around £8,000.

To enhance the existing Apple III business-oriented micro there are two new disc units: the 820K Unifile costs £650, and the 1.7K Duofile is priced at £1,100. Both are based around the new Apple-manufactured Twiggie 5.25in. floppy drive, also used in the Lisa.

The new drive uses slightly non-standard floppy discs, with two read-write holes cut in the plastic outer envelope on each side of the disc instead of the usual one. Apple says this dramatically improves the reliability of the double-sided floppy, as the read-write heads are not pressing against each other from opposite sides of the disc, which can distort the flexible recording surface as it rotates between them. Media costs are around \$10 a disc at the moment, higher than conventional discs, but with Verbatim and 3M manufacturing Twiggie-style floppy discs prices may reasonably be expected to fall as volume builds up.

Apple is also now selling printers, which allows the firm to offer customers a complete system with the Apple name on every component for the first time. The dot-matrix printer costs £450, has a 10in.-wide platen, a 3K print buffer, six different character sets loaded up in ROM, and prints at 120cps using a nine-by-seven dot matrix.

The daisywheel printer costs £1,200, has a 15in. platen and prints bidirectionally with letter quality at 40cps. Both printers use industry-standard interfaces and so can be used with non-Apple equipment.

Personal computers are the most rapidly growing sector of the whole computer market. According to DEC U.K. managing director Darryl Barbe, in excess of \$1 billion has been spent so far on the DEC personal computer project.

Apple, a smaller and newer company, with turnover now just reaching \$1,000,000,000 a

year, has made a proportionately greater investment with the Lisa, putting all its chips on the table, according to Apple Chairman Steven Jobs. Software development alone for Lisa absorbed two person centuries of effort. "We are willing to bank the company on this," comments Jobs.

With this full commitment by such heavyweight companies it must be obvious to the most cautious potential user that personal computers are no longer untested things suitable only for the intrepid. In consequence, fleet sales to large companies are expected to account for a growing proportion of sales.

IBM has many of the top Times 100 and Fortune 500 companies on its books already as mainframe customers. DEC is probably in there somewhere too, supplying minicomputers or board-level products to some part of the organisation. Apple is, relatively speaking, the outsider. Plenty of Apple IIs are in use in large companies, it is true, but since the unit cost is so much lower it may not have been forced to develop such good contacts at the higher levels of the decision-making hierarchy.

The greatest strength in this type of selling lies with IBM, which does not really have to do much more than add a credible personal computer product to its range to sell heavily to its existing customer base. DEC is offering very good support arrangements, which are likely to make its personal computers appeal to people who have not used computers before and who really want as many sources of worry removed as possible. Apple is putting its faith in innovation, sinking a heavy investment into making the Lisa office system as easy to use as the state of the art allows.

Apple Computer U.K. Ltd., Eastman Way, Hemel Hempstead, Hertfordshire HP2 7HQ. Telephone: (0442) 60244; DEC, Marketing Communications Dept. P.O. Box 110, Reading, Berkshire RG2 0TR; or telephone the new DEC Customer Information Centre on Basingstoke (0256) 59200; IBM United Kingdom Product Sales Ltd, P.O. Box 32, Alencon Link, Basingstoke, Hampshire RG21 1EJ; telephone (0256) 56144. 

More news on page 24

SOFTWARE Try before you Buy

If you need software on a trial or short-term basis — you need ATLANTA RENTALS.

Famous names in our huge library of software include all Visicorp products Micromodeller, Desktop/Plan, Microfinesse, Microplanning, TABS, Padmede, Wordstar, Cardbox, Format-80, dBase II etc. etc.

We also provide the hardware — Apple II and Apple III, Sirius 1 and now the IBM, plus top quality printers, monitors, hard and floppy disk drives, sheet feeders, line plotters and all peripherals to complete the rental picture.

No capital expenditure, no membership nonsense, and no waiting. Fixed charges, full support and friendly people.

Rental hotline 01-729 1411

Atlanta Data Systems

350/356 Old Street, London, EC1V 9DT. 01-739 5889



FULL DETAILS AVAILABLE FROM

The Educational Company
Longlands Avenue
Newtown Abbey
Co Antrim
Tel No: 0231-52333

NORTHERN IRELAND

● Circle No. 115

STEMMOS

the

dBASE II

experts

STEMMOS are one of Britain's leading software houses and specialists in dBase II

STEMMOS offer a helpline for dBase II users

STEMMOS wrote Autocode I, the only intelligent program generator for dBase II

STEMMOS hold monthly seminars in the heart of London on dBase II

- An opportunity for anyone from engineer to businessman to write their own microcomputer program.
- And for the programmer the chance to write programs in a fraction of the time.

Seminars:

7, 8, 9, Feb. 7, 8, 9, Mar. 4, 5, 6, Apr. 2, 3, 4, May. 6, 7, 8, Jun. 4, 5, 6, July. 1, 2, 3, Aug. 5, 6, 7, Sept. 3, 4, 5, Oct. 7, 8, 9, Nov. 5, 6, 7, Dec.

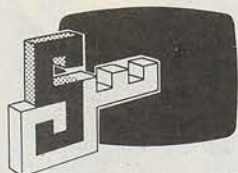

STEMMOS
The Key to successful software

Please send me more information on:

dBase II

Autocode I

dBase II User seminars

Name: _____

Company: _____

Address: _____



STEMMOS LTD

344 Kensington High Street
London W14 8NS

Tel: 01-602 6242 Telex: 893003 STEMOS G

dBase II™ Ashton Tate. Autocode I™ Stemmox Ltd.

STEMMOS dBASE II AUTOCODE I

BBC Micro becomes a two-channel 'scope

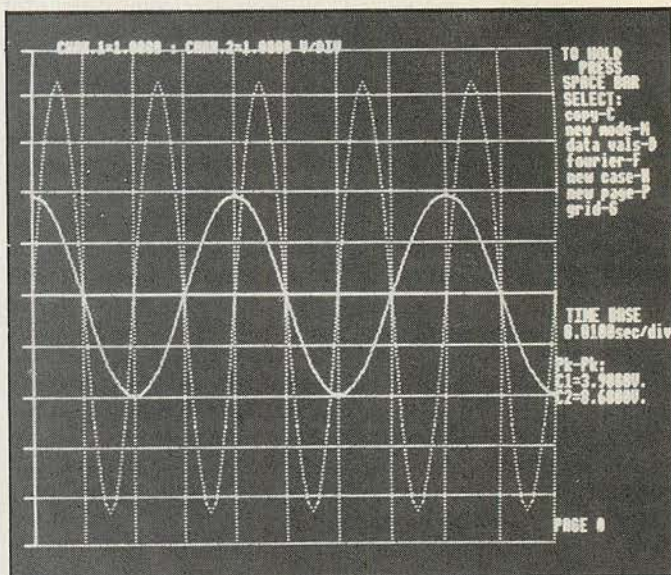

THE GSL ANALOGUE SIGNAL display and analysis system will turn a BBC model B computer into a large-screen storage oscilloscope. It has a two-channel input and can accept frequencies up to the high audio range. It also has a printer.

A fixed number of screens can be stored in memory and can be recalled for subsequent comparison. The two input channels can be triggered automatically

or externally. Sampling time can be varied from 0.002 to 25 seconds. The system uses the computer's high-resolution graphics with 250 by 500 pixels.

The system costs £1,206.35 for a monochrome system and £1,407.60 for the colour system, both prices including VAT. For further details contact GSL, 2 North Way, Andover, Hampshire SP10 5AZ. Telephone (0264) 58744.

Midwich games joysticks

THE MIDWICH JOYSTICKS have a life expectancy of more than 200,000 operations. Made of injection-moulded plastic and designed to sit comfortably in the hand they are available for the Dragon 32, BBC Micro, ZX-81 and ZX-Spectrum.

A push-button switch is incorporated in the handle, which may be used as a fire-button. Each joystick or pair of sticks comes supplied with the

appropriate connector for the machine in question, and in the case of the ZX-81 and Spectrum there is a four-channel joystick port. Prices are: Dragon 32, £15.98; BBC, £13.00; ZX-81/Spectrum, £15.98. The controller board costs £22.95.

Midwich Computer Company, Rickinghall House, Hilderclay Road, Rickinghall, Suffolk IP22 1HH. Telephone: (0379) 898751.

Electrical modeller

AC/MP IS AN ELECTRICAL circuit-modelling CAD package which will run on a CP/M system. Capable of modelling any AC circuit with up to 24 nodes, the package solves the simultaneous linear equations that are usually associated with electrical circuit design.

There are file, file-editing and plotting capabilities. Functions include Gain, both linear and in

dB, Phase, ZIn and ZOut for input and output impedences, and Bandwidth. A normal printer can be employed to print frequency-response curves, which are log-log scaled.

AC/MP is available from Harcourt systems, 9a Keswick Road, Orpington, Kent BR6 0EU. Telephone: Orpington 26469.

More news on page 29



ZX Spectrum

BLUE EDIT	RED CAPS LOCK	MAGENTA TRUE VIDEO	GREEN INV. VIDEO	CYAN	YELLOW	WHITE	BLACK DELETE
1	2	3	4	5	6	7	8
DEF FN	FN	LINE	OPEN #	CLOSE #	MOVE	ERASE	POINT
SIN	COS	TAN	INT	RND	STR\$	CHRS	CODE
Q	W	E	R	T	Y	U	I
ASN	ACS	ATN	VERIFY	MERGE	ABS	OR	POKE
READ	RESTORE	DATA	SGN	GOTOJ	SQR	IN	OUT
A	S	D	F	G	H	J	O
STOP NEW	NOT SAVE	STEP DIM	TO FOR	THEN GOTOJ	CIRCLE	LOAD	POKE
LN	EXP	LPRINT	LLIST	BIN	VAL	LIST	USR
ENTER	X	C	V	B	VAL \$	+	=
BEEP	INK	PAPER	FLASH	BORDER	SCREEN \$	LET	ATTR
Z	£	?	/	*	\$	LET	SPACE
COPY	CLEAR	CONT	CLS	BRIGHT	IN KEYS	PAUSE	BREAK
SHIFT	SHIFT	SHIFT	SHIFT	OVER	PI	INVERSE	SPACE



Sinclair ZX Spect

**16K or 48K RAM...
full-size moving-
key keyboard...
colour and sound...
high-resolution
graphics...**

**From only
£125!**

First, there was the world-beating Sinclair ZX80. The first personal computer for under £100.

Then, the ZX81. With up to 16K RAM available, and the ZX Printer. Giving more power and more flexibility. Together, they've sold over 500,000 so far, to make Sinclair world leaders in personal computing. And the ZX81 remains the ideal low-cost introduction to computing.

Now there's the ZX Spectrum! With up to 48K of RAM. A full-size moving-key keyboard. Vivid colour and sound. High-resolution graphics. And a low price that's unrivalled.

Professional power— personal computer price!

The ZX Spectrum incorporates all the proven features of the ZX81. But its new 16K BASIC ROM dramatically increases your computing power.

You have access to a range of 8 colours for foreground, background and border, together with a sound generator and high-resolution graphics.

You have the facility to support separate data files.

You have a choice of storage capacities (governed by the amount of RAM). 16K of RAM (which you can update later to 48K of RAM) or a massive 48K of RAM.

Yet the price of the Spectrum 16K is an amazing £125! Even the popular 48K version costs only £175!

You may decide to begin with the 16K version. If so, you can still return it later for an upgrade. The cost? Around £60.

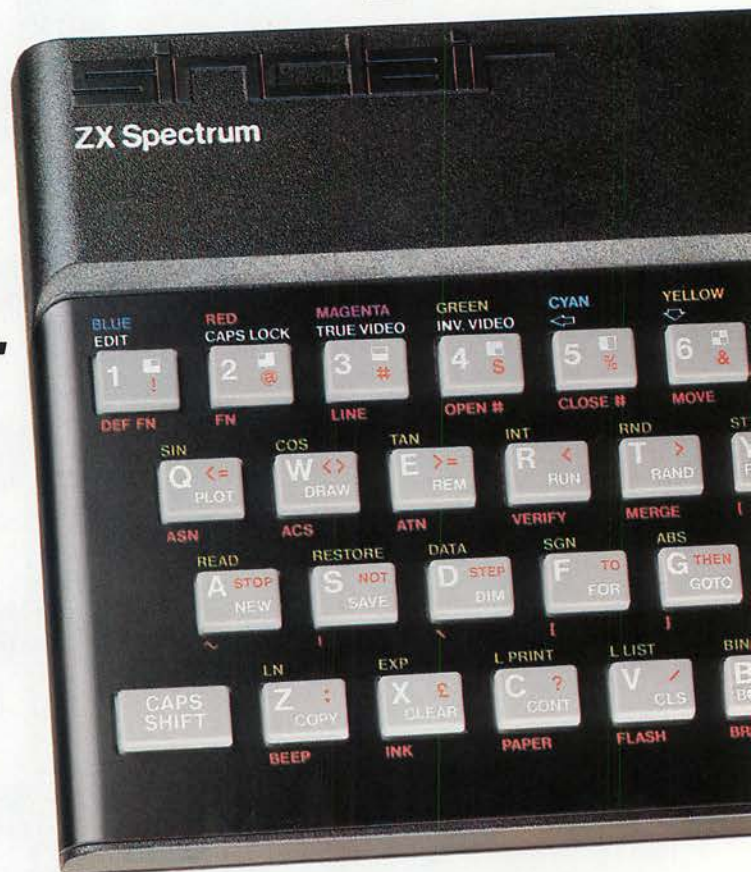

Ready to use today, easy to expand tomorrow

Your ZX Spectrum comes with a mains adaptor and all the necessary leads to connect to most cassette recorders and TVs (colour or black and white).

Employing Sinclair BASIC (now used in over 500,000 computers worldwide) the ZX Spectrum comes complete with two manuals which together represent a detailed course in BASIC programming. Whether you're a beginner or a competent programmer, you'll find them both of immense help. Depending on your computer experience, you'll quickly be moving into the colourful world of ZX Spectrum professional-level computing.

There's no need to stop there. The ZX Printer—available now—is fully compatible with the ZX Spectrum. And later this year there will be Microdrives for massive amounts of extra on-line storage, plus an RS232 / network interface board.



Key features of the Sinclair ZX Spectrum

- Full colour—8 colours each for foreground, background and border, plus flashing and brightness-intensity control.
- Sound—BEEP command with variable pitch and duration.
- Massive RAM—16K or 48K.
- Full-size moving-key keyboard—all keys at normal typewriter pitch, with repeat facility on each key.
- High-resolution—256 dots horizontally x 192 vertically, each individually addressable for true high-resolution graphics.
- ASCII character set—with upper- and lower-case characters.
- Teletext-compatible—user software can generate 40 characters per line or other settings.
- High speed LOAD & SAVE—16K in seconds via cassette, with VERIFY, MERGE for programs and separate data files.
- Sinclair 16K extended BASIC—incorporating unique 'one-touch' keyword entry, syntax check, and report codes.

im



The ZX Printer – available now

Designed exclusively for use with the Sinclair ZX range of computers, the printer offers ZX Spectrum owners the full ASCII character set – including lower-case characters and high-resolution graphics.

A special feature is COPY which prints out exactly what is on the whole TV screen without the need for further instructions. Printing speed is 50 characters per second, with 32 characters per line and 9 lines per vertical inch.

The ZX Printer connects to the rear of your ZX Spectrum. A roll of paper (65ft long and 4in wide) is supplied, along with full instructions. Further supplies of paper are available in packs of five rolls.



The ZX Microdrive – coming soon

The new Microdrives, designed especially for the ZX Spectrum, are set to change the face of personal computing by providing mass on-line storage.

Each Microdrive can hold up to 100K bytes using a single interchangeable storage medium.

The transfer rate is 16K bytes per second, with an average access time of 3.5 seconds. And you'll be able to connect up to 8 Microdrives to your Spectrum via the ZX Expansion Module.

A remarkable breakthrough at a remarkable price. The Microdrives will be available in the early part of 1983 for around £50.



Spectrum software on cassettes – available now

The Spectrum software library is growing every day. Subjects include education, and business/hold management. Flight simulation... Chess... Planetoids... ...Inventions... VU-CALC... VU-3D Record Controller... there is something for everyone. And they all make full use of the Spectrum's colour, sound and graphics capabilities. You'll find a detailed catalogue with your Sinclair Spectrum.

Expansion Module

This module incorporates the three essential functions of Microdrive controller, local network, and RS232 interface. Connect it to your Spectrum and you can connect up to eight Microdrives, communicate with other computers, and use a wide range of printers. The potential is enormous, and the price will be available in the early part of 1983 for around £30.

How to order your ZX Spectrum

BY PHONE – Access, Barclaycard or Trustcard holders can call 01-200 0200 for personal attention 24 hours a day, every day. **BY FREEPOST** – use the no-stamp needed coupon below. You can pay by cheque, postal order, Barclaycard,

Access or Trustcard.

EITHER WAY – please allow up to 28 days for delivery. And there's a 14-day money-back option, of course. We want you to be satisfied beyond doubt – and we have no doubt that you will be.

To: Sinclair Research, FREEPOST, Camberley, Surrey, GU15 3BR.				Order
Qty	Item	Code	Item Price £	Total £
	Sinclair ZX Spectrum – 16K RAM version	100	125.00	
	Sinclair ZX Spectrum – 48K RAM version	101	175.00	
	Sinclair ZX Printer	27	59.95	
	Printer paper (pack of 5 rolls)	16	11.95	
	Postage and packing: orders under £100	28	2.95	
	orders over £100	29	4.95	
				Total £ _____

Please tick if you require a VAT receipt

*I enclose a cheque/postal order payable to Sinclair Research Ltd for £ _____

*Please charge to my Access/Barclaycard/Trustcard account no. _____

*Please delete/complete as applicable _____

Signature _____

PLEASE PRINT

Name: Mr/Mrs/Miss _____

Address _____

PRC 903

FREEPOST – no stamp needed. Prices apply to UK only. Export prices on application.

Sinclair
Research Ltd, Stanhope Road,
Camberley, Surrey GU15 3PS.
Camberley (0276) 685311.

Sinclair ZX Spectrum—technical data.

Dimensions

Width 233 mm
Depth 144 mm
Height 30 mm

CPU/memory

Z80A microprocessor running at 3.5 MHz.
16K-byte ROM containing BASIC interpreter and operating system.

16K-byte RAM (plus optional 32K-byte RAM on internal expansion board) or 48K-byte RAM.

Keyboard

40-moving-key keyboard with full upper and lower case with capitals lock feature. All BASIC words obtained by single keys, plus 16 graphics characters, 22 colour control codes, and 21 user-definable graphics characters. All keys have auto repeat.

Display

Memory-mapped display of 256 pixels x 192 pixels; plus one attributes byte per character square, defining one of eight foreground colours, one of eight background colours, normal or extra brightness and flashing or steady. Screen border colour also settable to one of eight colours. Will drive a PAL UHF colour TV set, or black and white set (which will give a scale of grey), on channel 36.

Sound

Internal loudspeaker can be operated over more than 10 octaves (actually 130 semitones) via basic BEEP command. Jack sockets at the rear of computer allow connections to external amplifier/speaker.

Graphics

Point, line, circle and arc drawing commands in high-resolution graphics.
16 pre-defined graphics characters plus 21 user-definable graphics characters. Also functions to yield character at a given position, attribute at a given position (colours, brightness and flash) and whether a given pixel is set. Text may be written on the screen on 24 lines of 32 characters. Text and graphics may be freely mixed.

Colours

Foreground and background colours, brightness and flashing are set by BASIC INK, PAPER, BRIGHT and FLASH commands. OVER may also be set, which performs an exclusive-or operation to overwrite any printing or plotting that is already on the screen. INVERSE will give inverse video printing. These six commands may be set globally to cover all further PRINT, PLOT, DRAW or CIRCLE commands, or locally within these commands to cover only the results of that command. They may also be set locally to cover text printed by an INPUT statement. Colour-control codes, which may be accessed from the keyboard, may be inserted into text or program listing, and when displayed will override the globally set colours until another control code is encountered. Brightness and flashing codes may be inserted into program or text, similarly. Colour-control codes in a program listing have no effect on its execution. Border colour is set by a BORDER command. The eight colours available are black, blue, red,

magenta, green, cyan, yellow and white. All eight colours may be present on the screen at once, with some areas flashing and others steady, and any area may be highlighted extra bright.

Screen

The screen is divided into two sections. The top section – normally the first 22 lines – displays the program listing or the results of program or command execution. The bottom section – normally the last 2 lines – shows the command or program line currently being entered, or the program line currently being edited. It also shows the report messages. Full editing facilities of cursor left, cursor right, insert and delete (with auto-repeat facility) are available over this line. The bottom section will expand to accept a current line of up to 22 lines.

Mathematical operations and functions

Arithmetic operations of +, -, ×, ÷, and raise to a power. Mathematical functions of sine, cosine, tangent and their inverses; natural logs and exponentials; sign function, absolute value function, and integer function; square root function, random number generator, and pi.

Numbers are stored as five bytes of floating point binary – giving a range of $+3 \times 10^{-39}$ to $+7 \times 10^{38}$ accurate to $9\frac{1}{2}$ decimal digits.

Binary numbers may be entered directly with the BIN function. =, >, <, >=, <= and <> may be used to compare string or arithmetic values or variables to yield 0 (false) or 1 (true). Logical operators AND, OR and NOT yield boolean results but will accept 0 (false) and any number (true).

User-definable functions are defined using DEF FN, and called using FN. They may take up to 26 numeric and 26 string arguments, and may yield string or numeric results.

There is a full DATA mechanism, using the commands READ, DATA and RESTORE.

A real-time clock is obtainable.

String operations and functions

Strings can be concatenated with +. String variables or values may be compared with =, >, <, >=, <=, <> to give boolean results. String functions are VAL, VAL\$, STR\$ and LEN. CHR\$ and CODE convert numbers to characters and vice versa, using the ASCII code.

A very powerful string slicing mechanism exists, using the form a\$(x TO y).

Variable names

Numeric – any string starting with a letter (upper and lower case are not distinguished between, and spaces are ignored).

String – A\$ to Z\$.

FOR-NEXT loops – A-Z.

Numeric arrays – A-Z.

String arrays – A\$ to Z\$.

Simple variables and arrays with the same name are allowed and distinguished between.

Arrays

Arrays may be multi-dimensional, with subscripts starting at 1. String arrays, technically character arrays, may have their last subscript omitted, yielding a string.

Expression evaluator

A full expression evaluator is called during program execution whenever an expression, constant or variable is encountered. This allows the use of expressions as arguments to GOTO, GOSUB, etc.

It also operates on commands allowing the ZX Spectrum to operate as a calculator.

Cassette interface

The ZX Spectrum incorporates an advanced cassette interface. A tone leader is recorded before the information to overcome the automatic recording level fluctuations of some tape recorders, and a Schmitt trigger is used to remove noise on playback.

All saved information is started with a header containing information as to its type, title, length and address information. Program, screens, blocks of memory, string and character arrays may all be saved separately.

Programs, blocks of memory and arrays may be verified after saving to confirm successful saving.

Programs and arrays may be merged from tape to combine them with the existing contents of memory. Where two line numbers or variables names coincide, the old one is overwritten.

Programs may be saved with a line number, where execution will start immediately on loading.

The cassette interface runs at 1500 baud, through two 3.5 mm jack plugs.

Expansion port

This has the full data, address and control busses from the Z80A, and is used to interface to the ZX Printer, the RS232 and NET interfaces and the ZX Microdrives.

IN and OUT commands give the I/O port equivalents of PEEK and POKE.

ZX81 compatibility

ZX81 BASIC is essentially a subset of ZX Spectrum BASIC. The differences are as follows.

FAST and SLOW: the ZX Spectrum operates at the speed of the ZX81 in FAST mode with the steady display of SLOW mode, and does not include these commands.

SCROLL: the ZX Spectrum scrolls automatically, asking the operator "scroll?" every time a screen is filled.

UNPLOT: the ZX Spectrum can unplot a pixel using PLOT OVER, and thus achieves unplot.

Character set: the ZX Spectrum uses the ASCII character set, as opposed to the ZX81 non-standard set.

ZX81 programs may be typed into the ZX Spectrum with very little change, but may of course now be considerably improved. The ZX Spectrum is fully compatible with the ZX Printer, which can now print out a full upper and lower case character set, and the high resolution graphics; using LLIST, LPRINT and COPY. ZX81 software cassettes and the ZX 16K RAM pack will not operate with the ZX Spectrum.

sinclair ZX Spectrum

Portable Forth

HAVE YOU EVER spent a lonely evening in a hotel room wishing you could get on with that relational database you were writing in Forth? No, we haven't either, but if you do miss programming in Forth as you travel the world, Kuma Computers has developed a version of Forth for the Osborne portable micro.

Kuma Fig Forth runs under CP/M and conforms to the Fig Forth international standard. It includes a number of features

such as a screen editor and a full Z-80 assembler, which should make life easy for the Forth programmer. The most interesting feature is that it uses CP/M files for all operations.

There is a comprehensive manual, with a tutorial for newcomers to the language, as well as some demonstration listings. Kuma Fig Forth costs £85 and is available from Kuma Computers Ltd, 11 York Road, Maidenhead, Berkshire. Telephone: (0628) 71778.

Camera-to-computer graphics interface



MICROSIGHT will give a microcomputer eyes for less than £500. The system comprises a standard CCTV camera, a camera-computer interface and vision software. The Microeye camera-computer interface sends images to the computer as eight-bit digital video.

System software includes a set of processor and disc-handling routines, plus six machine-code

routines to read the incoming data and process it for high-resolution display. Images can be stored in RAM, while analysis can be carried out to determine features such as length, width, perimeter and centre of gravity.

Microsight comes with full documentation and costs £495 plus VAT. For information contact Digithurst Ltd. Telephone: (0223) 208926.

Tandy's 16-bit micro

TANDY IS TO OPT FOR the Zenix multi-user operating system on the new TRS-80 model 16 microcomputer. The micro is based on the Motorola 68000 processor, which lends itself readily to Zenix, a Unix-like operating system. The micro also has a second Z80-A processor to handle house-keeping tasks.

The new micro is upgradable from the Tandy model II via a special kit. It can handle up to three terminals simultaneously

running different applications. The memory capacity is expandable from the initial 128K to 512K.

The single-user model 16 is able to run model II software on a more powerful machine and costs £3,599 including VAT for a single-drive machine. The minimum multi-user system requires an additional 128K RAM and a hard-disc unit. The machines will be available through the nationwide Tandy dealer network.



FULL DETAILS AVAILABLE FROM

Gem Systems Ltd
2 Crawford Road
Hatfield
Tel No: 30-64137/66148

HERTFORDSHIRE

● Circle No. 118

MicroSight

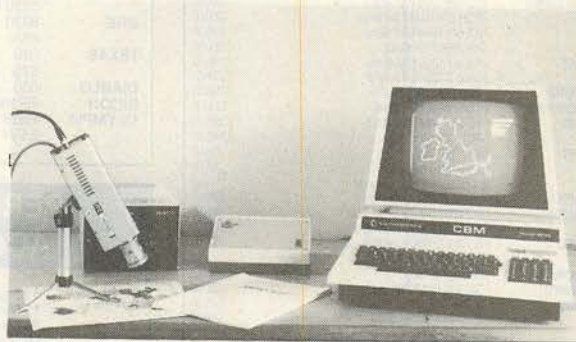

MicroSight 2 (CID)	£2990+Vat
MicroSight 1 (CCTV)	£499+Vat
Vision Interfaces from	£99+Vat

For details contact:-

DIGITHURST

Digithurst Ltd.
 Leaden Hill, Orwell, Royston,
 Herts. SG8 5QH
 Tel: (0223) 208926

● Circle No. 119

*******THE NEW DBMS III (series III of the world's first 'task-robot-programs')*****
*****FEATURES*******

Mbasic & word-star compatible.....	32000 records per filename.....	12 online file architectures.....
1400 character record sizes.....	20 main/200 sub fields per record.....	240 fields using cross-referencing.....
mathematical scratchpad.....	field and record related formulae.....	cross-record calculations.....
record relational indexes.....	'Jump-to' any of 32000 records per file.....	'Jump-to' any record in 12 files.....
translate into any language.....	random/binary/key/multiple field search.....	User-defineable files/field words/sizes.....
User-defineable reporting.....	'if-then' questioning.....	endless 'either-or' matching.....
field protection/classification.....	file protection/password entry.....	formulate/recall on selection criteria.....
sorts 'alpha or numeric' any window.....	speed of 500 records per 20 seconds.....	12 interrogation question types.....
either-or. same as. greater. smaller.....	range match. not match. integer match.....	short filing output/audit trails.....

ONE OF THOUSANDS OF DIFFERENT TASKS ON WHICH THIS PROGRAM MIGHT BE EMPLOYED

DBMS'S MACROS WORK FROM THE MOMENT YOU INSERT THE 'TASK DISK' IN THE COMPUTER DRIVE. Simply design your file, give its fields your words, setup your report mask, and then enter your records. Switch to 'automatic drive' and formulate any task you wish the program to fulfill, the task is stored as a macro. Take a copy of the program on another 'task disk' and from then on, the task disk will function without a single key-stroke. Think of a number of such 'task disks' such as "stock-re-order reports"; "stock-valuation reports"; "sale-mail-shots"; "production-process-analysis"; "patient history analysis"; "research-analysis"; "budgetting" "purchase/sales-analysis"; "personel-file-analysis"; "vehicle-location control"; "librarian analysis"; "plus more?"

Previous issues showed examples of 'employees-short-list', 'garage stock re-order', 'sales analysis', 'librarian's list', 'hospital's patient list' here is an example of a 'rental recording file' and some reports it might generate.

The record may look like this:
 1-record number (413)
 2-client (Radio cars ltd)
 3-date of contract (01.04.81)
 4-date last pmt (12.02.82)
 5-period/frequency (36 / monthly)
 7-amount of pmt (22.50)
 8-item type (Taxi-phones)
 9-repairs made (faulty microphone — item replaced)
 10 cross reference (3.4221C details of full system spec and supplier)

One report might be: select ?? all records where the amount of payments are less than 50 pounds, that were taxi-phones and faults were detected. When found, pick up the cross reference code and look up that record to identify the supplier.

Another report might be: select ?? all records in the file where the commencing date of rental was 04.81 and the term was greater than 12 months. Print a list of all those records where the date last payment was prior to (ie smaller than) 03.82 and prepare a short address file for 'reminders'.

DBMS II (WITHOUT MACROS) AND DBMS III ARE FULLY IMPLEMENTED UNDER CPM-86 (tm) and MS-DOS (tm) ie: (SIRIUS/VICTOR/IBM) DBMS II IS 395.00 (or 250.00 by mail order ex. training), DBMS III is 575.00 (or 295.00 by mail order ex. training)

TELEPHONES: 01-636 8210 : 01-631 4818 : TLX: 892031 TWCG (BOSTON 94-0890)

MICRO-COMPUTERS

G.W.L.	G80 64K/Interface ports/k'board	795.00
	G80 V.D.U.	150.00
	G80 Dual/imes enclosed	550.00
INTERTEC	Superbrain 64K RAM/320K disks	1695.00
	Superbrain 64K RAM/700K disks	2195.00
	Superbrain 64K RAM/1.5M disks	2595.00
	Superbrain 64K RAM/10M disks	call
	Compustar 64K RAM/OK disks	1495.00
	Compustar 64K RAM/320K disks	1995.00
	Compustar 64K RAM/700K disks	2495.00
	Compustar 64K RAM/1.5M disks	2895.00
NORTHSTAR	Advantage 64K RAM/700K disks	£2095.00
	Advantage 64K RAM/5.3M disks	£2995.00
	Horizon 64K RAM/6.3M disks	3595.00
TELEVIDEO	802H 64K RAM/700K disks	1995.00
	802H 64K RAM/7.3M disks	3250.00
	806 64K RAM/10M disks	4595.00
	816 256K/750K disks	£2950.00
ACT	Sirius 1 128K/1.2M disks	£2395.00
	Sirius 2 128K/2.4M disks	£2895.00
VICTOR	9000 128K/1.2M disks	£2395.00
OSBORNE	PC 64K RAM/200K disks	1250.00
IBM	PC 64K RAM/640K disks	£2695.00
	PC1 330K/640K disks	£2995.00
PET	8032 32K RAM	795.00
	8050 1 Meg disks	795.00
	64 CBM personal computer	call
APPLE	II 64K/CPM/2 disk/Monitor	2395.00
ALOTOS	ACS800-2 64K RAM/1M disks	1995.00
	ACS800-10 208K/10.5Meg disks	5495.00
NEC	PC800/112 64K RAM/350K disks	1695.00
	APC 128K RAM/2M disks	call
CORVUS	Concept 16 bit pc	call
SANYO	G80 64K RAM/320K disks	1350.00
ABC	24 64K RAM/700K disks	2195.00
	26 64K RAM/2.2M disks	3250.00

All computer prices include mbasic as standard. All prices marked £ are 8/16 bit machines.

SYSTEM DEAL SAVES YOU 1500.00+

Choose any computer, any printer and 30 diskettes add 65.00 for cables and testing. add 10% warranty for 1 year (optional) add 110.00 for delivery & installation (optional) training optional extra 100.00

and get completely *****FREE*****

cpm handbook	50 basic exercises	2000 sheets paper
DBMS II	magic wand w/proc	magic calc
mbasic 80	diagnostics	msort/dsort
recover	autoload	instant basic
cbasic	disk/games	library case

*****total value 1525.00*****
 If the system value exceeds 4000.00 then you get the G80/86 software packages value 690.00 also
THAT'S OVER 2000.00 POUNDS WORTH OF SOFTWARE FREE

PRINTERS

OKI	-Microline 80	295.00
	-Microline 82A	395.00
	-Microline 83	695.00
	-Microline 84	895.00
EPSON	-MX80/FT-3	395.00
	-MX100/FT-3	525.00
ANADEx	-DP 9000	895.00
	-DP 9501	1045.00
	-DP 9501 (A)	1145.00
QUME	-9/45 R/O	1695.00
	-9/55 R/O	1795.00
	-9/35 R/O	1495.00
NEC	-3510 R/O	1395.00
	-7710 R/O	1795.00
	-5520 KSR	2250.00
DRE	-8820	1295.00
	-8830	1695.00
TEXAS	-810	1195.00
	-825	1095.00
	-630	1695.00
DIABLO	-RP1600	1495.00
RICOH	-ESW 103 14 CPS	975.00
OLYMPIA	-ESW ??? 55 CPS	1025.00

PERIPHERALS & ACCESSORIES

CORVUS	-6 Meg hard disk	1750.00
	-11 Meg hard disk	2750.00
	-20 Meg hard disk	3750.00
	-Multiplexer 7 station	695.00
	-Mirror backup card	695.00
INTERTEC	-Compustar 10 Meg hard disk	2750.00
	-CDC 96 Meg hard disk	7950.00
N'STAR	-16 Bit w/grade	325.00
	-18 Meg hard disk	2995.00
RODIME	-6 Meg hard disk	1495.00
	-12 Meg hard disk	1950.00
MORROW	-26 Meg hard disk	3295.00
GENIE	-5MG fixed/5MG removeable disk	3295.00
	-s/sided floppy drives	150.00
	-d/sided floppy drives	225.00
	-d/sided d/track drives	375.00
MEMOREX	-soft/hard s/sided diskettes (10)	30.00
SCOTCH	-104/2D double sided (10)	50.00
S.S.E.	-Softbox PET to CPM (tm)	495.00
	-Sirius 8/16 bit 5MHz card	365.00
QUADRAM	-64K print spooler/copier	250.00
BIZCOMP	-RS232/auto-modem 1200 baud	450.00
AST	-Port expanders (4 tmnlis to 1 prtr)	395.00
GIX	-Port expander (switches)	95.00
GIX	-Port expander (switcher)	95.00

NOTE: Corvus drives with multiplexer may network sirius .. Superbrain .. Concept .. PET .. Victor .. IBM

SOFTWARE

G.W.L.	-BUS V8.00 (Accounts)	275.00
	-DBMS II (Database)	£395.00
	-DBMS II (by mail order only)	£250.00
	-DBMS III (database)	£575.00
	-DBMS III (by mail order only)	£295.00
	-DSORT & MSORT (MBasic Files)	£75.00
	-Sales Ledger	£95.00
	-Purchase Ledger	£95.00
	-Nominal Ledger	£95.00
	-Stock-Control	£95.00
	-Address-Mailer	£95.00
	-QASort/QNSort (500 Recs/14secs)	£95.00
	-Autoload & Recover	25.00
MICROSOFT	-Mbasic 80	1495.00
	-Fortran 80	295.00
	-Cobol 80	395.00
	-Basic Compiler	225.00
	-MU lisp/mu star	125.00
MICROPRO	-Word-star	£275.00
	-Mail-merge	1195.00
	-Spelstar	125.00
	-Dastar	195.00
	-Super-sort	125.00
	-W-star/M-merge/Sp-Star	420.00
BYROM	-BStm (communications)	100.00
	-BStms (tele-comms)	100.00
DIGITAL	-Despool	30.00
	-CBasic	75.00
	-Pascal MT	225.00
F. GELLER	-Quickscreen	95.00
LEXISOFT	-Spellfinder	195.00
LIFEBOAT	-TIMaker	155.00
M'FOCUS	-CIS Cobol	420.00
	-Forms II	100.00
	-Super Calc	195.00
SORCIM	-Pascal M	250.00
	-Quic-N-Easy	195.00
STANDARD	-Magic Wand	190.00
PEACHTREE	-Magic Calc	175.00
	-Diagnostics	50.00
S'Soft	-Statpak	250.00
N'West	-The Word	35.00
OASIS	-Pascal Z	100.00
ITHACA	-Cross-talk (Tele-comms)	95.00
MICROSTUFF	-Move-it (Micro to Micro)	45.00
WOOLFE		

Software formats on all micros in our hardware list. All prices marked £ are available 8/16 bit formats.

TERMS & ETC

G. W. Computers Ltd (Grama (Winton) Ltd)
 35 Bedford Court Mansions
 Bedford Avenue
 London W.C.1, England.
 Tel: 01-636 8210; 01-631 4818; tlx 892031 twc
 Boston office tlx 94-0890
 24 hour answerphone-leave address for 'intropacks'
 We do not operate a reader's reply card service.
 Terms: G.W.U. or G.O.U. Prices include V.A.T. No dealers.
 The above lists are not exhaustive. Please call in only by prior appointment.

G80/86 SOFTWARE

Fully implemented on MS-DOS, CPM 2.2 and CPM 86 (tm)

Works on IBM, Sirius and Victor 9000 and all micro-computers in our price list

Sale ledger (95 pounds)
Purchase ledger (95 pounds)
Nominal ledger (95 pounds)
Aged analysis (25 pounds)
Stock control-valuation/re-order (95 pounds)
The invoicer (95 pounds)**
The address mailer (95 pounds)
Qasort/Qnsort (500 records/15 seconds) (95 pounds)

Each module is a set of 'fast disks' designed for minimal learning curve. This software derives from modules of 'DBMS III' and runs reports without your secretary having to touch a single key.

Consider the advantages in these features. The user manual is contained in FIVE pages. All reports are generated by robot functions. Reliability tested (benchtest PCW June). Works in a network multi-user environment. Fast easy data entry.

Files are re-organised and sorted automatically.

Produced by the same people that originated 'BUSINESS', 'DBMS II', 'DB-CALC', 'AUTOLOAD AND RECOVER' 'ETC' and sold successfully over the past five years.

Also see our advertisement next page, the software above comes free with a system purchase (excluding items marked ** and DBMS III).

The G80/86 networks

Based upon one hard disk and multiplexor module the G80/86 networks feature full network sharing of data resources by adding different stations that may be as various as Sirius/Victor 9000/IBMSuperbrain/Pet/N' star/Sanyo. The low-cost start-up of a network could be simply

1 hard-disk of 5 mbytes
1750.00

1 multiplexor
695.00

1-2 stations
from 795.00

We also have a special 'spooler module' as well as software controllable port expanders and modems for output to telephones, printers, and screens so that a number of terminals may share the resources of one printer, as well as be able to send files over the telephone at any time (day/night) to both store on the hard disk and print out as well.

Imagine a terminal at a remote site, being able to send/receive its files to/from the main network's hard disk/printer overnight to be examined and processed the next day.

The commands are literal English. Like: (send file 'ledger' to port 'B' (the modem) at 11.30)

only from **G. W. Computers** (the leaders in database)

Call us on 01-636 8210 or 01-631 4818

and leave your address for our standard 'infopacks'

IMAGINE EVENTUALLY BEING ABLE . . .

With an IBM PC, Modem, dot matrix and daisy printer, to start your day with our robot task disks working under CONCURRENT CPM 86 (tm).

Enter virtual console 0 and telephone your head-office to call all yesterday's ledger files and store them locally on your hard disk.

Now switch to virtual console 1 and while console 0 runs concurrently for about an hour, get a 1000 mail-shot running to the daisy printer.

Now switch to virtual console 2 and while consoles 0/1 run concurrently, get the 'robot task' of producing a stock-re-order report out to the fast dot matrix.

Now switch to virtual console 3 and while consoles 0/1/2 run concurrently, do some programming, or file-reorganising, or any other task you might require.

Four virtual computers all running concurrently on one computer, batch processing to various devices or else queue-spooling their output through print buffers of up to 500K storage and spreading the load through time on fewer printers.

Advance notice

introducing forward developments of
DBMS III 'TURN-KEY' software

Three enhancements will be available for DBMS II towards late Spring/Summer 83

1) a new 'FORMS DBMS III' will enable you to design your business forms with embedded formulae (ie; quantity * price for invoices) to suit your own particular stationery

2) a new 'EQUATION PARSING DBMS III' will enable you to set up field formulae (as in calc-programs) so that DBMS III will overlap areas of all the 'word-processing type' programs currently available in a rudimentary manner.

That means a DATABASE program, totally resident in the RAM of your machine, leaving you with all the disk space for data, capable of 'calc' and 'text' processing as well as the already unsurpassed features incorporated in DBMS III

PROBABLY THE MOST POWERFUL INDIVIDUAL PIECE OF SOFTWARE AVAILABLE TODAY

● Circle No. 120

HOW MUCH?

**Includes
£1000 worth
of software.**

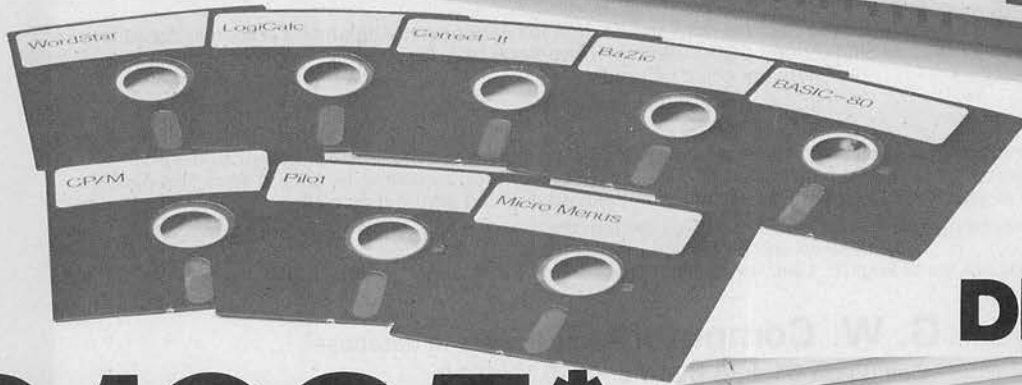
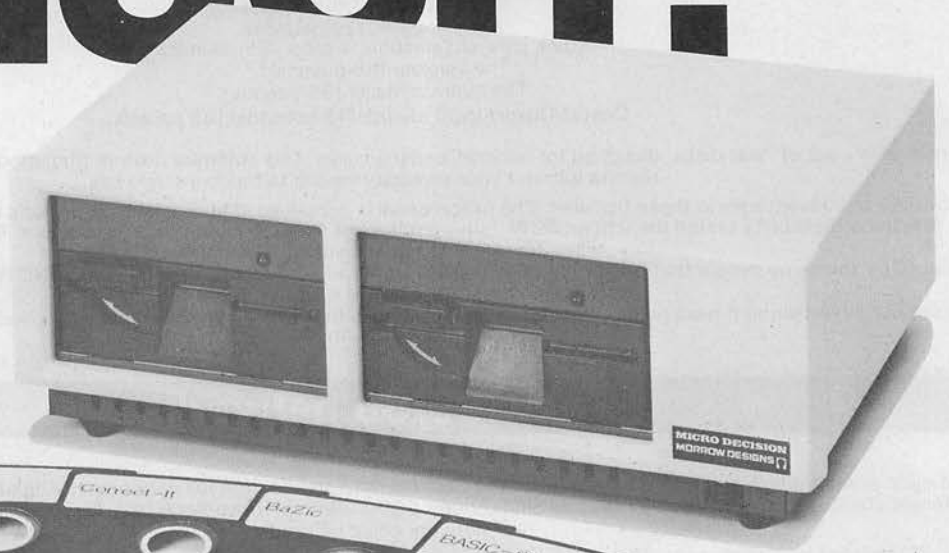

THE MICRO DECISION

£1095*

Yes! Only £1095 (or only £895 with one disk drive) will buy you the Morrow Designs Micro Decision. As advanced and sophisticated as those costing several times the price, the Micro Decision comes packaged with a comprehensive variety of software.

Micro Decision features:—

- * 64K bytes of RAM
- * Z80A processor at 4Mhz
- * Two RS232C serial ports
- * Floppy disc controller for up to 4 drives
- * 200K bytes formatted per drive
- * Format compatible with Osborne, Xerox, IBM PC
- * Compact; 16.7" wide, 5.3" high, 11.3" deep

Software supplied as standard:—

- * WORDSTAR: *Word Processing System*
- * CORRECT-IT: *Checks and corrects spelling*
- * LOGICALC: *Financial modelling and forecasting*
- * CP/M 2.2: *Disk Operating System*
- * BASIC-80: *MicroSoft BASIC language*
- * BAZIC: *North Star compatible BASIC*
- * PILOT: *Programming learning language*
- * MICRO MENUS: *Operators CP/M roadmap*



Add a suitable VDU and printer, and you have all the hardware and software you need. Example shown — complete business system with VDU, Printer and the Exact Accounting System, guaranteed for one year — £2295.

* Prices exclusive of VAT and carriage. Prices subject to change. Dealer enquiries welcome.

Return this coupon for further details of The Micro Decision.

Name

Position

Address

Tel. No.

PC

INTEDAM

Microcomputer Specialists

46 Balham High Road London SW12 9AQ Tel: 01-675 5325/6/7

• Circle No. 121

We take all the guessing out of terminal buying



Micropute is a fast developing distributor with the sole aim of guiding you through the systems jungle. We carefully test, evaluate and then select the best product from its own marketplace. We then add our own extensive product knowledge and all the necessary ancillaries related to the main product. All this fully backed and protected by fast, comprehensive nationwide servicing and maintenance coverage.

K9 Terminal

Main features:

- 80 x 25 (including status line)
- Green display
- Seperate keyboard
- Function keys
- Self test
- Reverse video
- Underlining
- Half intensity
- Protected mode
- Line and block graphics
- Televideo compatible
- Baudrates to 9600

The K9 Terminal is undoubtedly one of the most competitively priced terminals available on the market today which can offer so many outstanding features.

The K9 Terminal is supplied to us by I.C.L. and includes the type of back-ups and product development that you would expect from a major manufacturer.

Delivery is ex-stock and this amazing terminal is now available at the incredible price of only: **£525.00** + V.A.T.

Insight Terminal

Main features:

- As the K9 Terminal plus,
- Deeper contrast on screen
- Black screen surround (eliminates reflections)
- Deeper recessed screen
- Customised for Wordstar
- Optional 15" screen
- Optional graphic display
- Alternative emulations. VT52, Beehive

The Insight Terminal is again, extremely competitively priced offering an even greater amount of features than the K9.

The latest addition to the already impressive list of this terminals features is the option of full graphic display, which is now available as an ex-stock item.

Delivery on all Insight Terminals is ex-stock and prices start from as little as **£595.00** + V.A.T.

All Micropute products are backed by a nationwide service and maintenance team.

For further technical data and the name of your nearest dealer send the coupon now!

MICROPUTE Catherine Street, Macclesfield, Cheshire SK11 6QY.
Tel: (0625) 612759

Name _____ Position _____

Company Name _____

Company Address _____

Tel. No. _____



MICROPUTE

Catherine Street, Macclesfield, Cheshire SK11 6QY. Tel: (0625) 612759

● Circle No. 122

The right software for your application from

COMPUTECH



COMPUTECH FINANCIAL ACCOUNTING PACKAGES

Payroll
Invoicing and Stock Recording
Sales, Purchases and General Ledgers
Also costing and group consolidation

each \$

COMPUTECH UTILITIES DISK

for reliable error checking copying, diskette scan, interpret and patch, etc
VisiCalc, Applewriter and other Apple software (Prices on request)

COMPUTECH CHAIN MAIL

A mailing merging document processor which may be used with text files, including random files and Applewriter 1.1 binary files

COMPUTECH GRAPHICS DISK

for printing Apple pictures and graphs on Epson and Microline (free with printers purchased from Computech)

COMPUTECH TERMINAL UTILITIES

Apple to Apple and Apple to mainframe

from \$

COMPUTECH hardware...just plug it in and go!

switches and jumpers provide hardware options without soldering



DIPLOMAT VIDEO DIGITISER

store a frame from video camera in a fiftieth of a second, process and print

DIPLOMAT PARALLEL Interface

DIPLOMAT SERIAL COMMUNICATIONS Interface

DIPLOMAT RAM 16 Memory Expansion

DIPLOMAT CLOCK/CALENDAR

LOWER CASE Character Generator with Applewriter 1.1 enhancements

MICROMUX Data Exchange (Max 16 Ports)

from \$

MATRIX PRINTERS, Microline and Epson with graphics and up to 200 cps

from \$

MICROLINE Optional Character Generator

DAISY WHEEL PRINTERS, Olympia, Qume, Ricoh

from under \$

Prices exclude VAT, Carriage and Packing

For full details phone for data sheets and a FREE demonstration

COMPUTECH SYSTEM

168 Finchley Road, London NW3 6HP. Tel: 01-794 0202

ON JANUARY 18 IBM finally launched its Personal Computer in the U.K. nearly 18 months after its American introduction. Of course the IBM PC had been available in the U.K. for some time but only as a "grey" import, not with the blessing of the company itself.

The new machine does not show any remarkable advances over its American cousins. The keyboard has been specified for the U.K. The drives are now 320K. The minimum RAM is now 64K instead of 16K — IBM provided a cassette-based 16K model for the home-market in America. The PC no longer needs a mains transformer to be added. All these were expected and delivered: anything more radical, such as replacing the 8088 chip with an 8086, has not.

Possibly the most original part of the launch is that IBM has formed a new subsidiary, IBM United Kingdom Product Sales Ltd, to market the new machine. Outlets will be authorised dealers and IBM Retail Centres, with bulk purchases or "fleet sales" being handled direct.

Many people had wondered how IBM was going to sell what, by IBM standards, a low-priced computer. The new sales company indicates that it will be looking for high turnover.

However, in U.K. terms the IBM PC is not exactly cheap. The retail price of the minimum self-sufficient system, with 64K of RAM and only one 160K floppy disc, is £2,080 plus VAT. A proper business system with

The PC launched in Britain — official



Already here in numbers as a "grey" import, the IBM PC is now available with official back-up.

128K of RAM and two 320K drives, plus printer, is priced at £3,442 plus VAT. As the printer is only an Epson MX-80 wearing an IBM badge, not a letter-quality printer, this is not going to give too many rival suppliers sleepless nights.

The IBM PC broke new ground when it was launched in the U.S., just as the Sirius 1 did in the U.K. A year or so later, however, there are many micros on offer with superior performance at a similar, or even a lower price.

Most of the major computer manufacturers have now entered the micro market. DEC and Wang have produced

excellent micros, and Data General has virtually halved the price of its Enterprise 16-bit machine. The Sirius is by now well established.

IBM will undoubtedly do well with the PC, but is unlikely to sweep the market in quite the way achieved in the U.S.

Initially, however, there will be many major companies who want the IBM machine. They will be buying in bulk, and able to negotiate a discount. Anyway, they may have IBM mainframes or minis and not be too bothered about the price. These buyers will probably absorb all the spare machines IBM can supply until the

company starts manufacturing at Greenock in Scotland later this year. When you have people clamouring to buy micros and they are in short supply, why reduce the price?

At least this will give the "plug compatible" manufacturers — of which there are now many — a chance to build their market share. For whether the IBM PC is a huge success, or just a success, it is certainly going to set a standard. It will generate massive amounts of software and, as continuing sales of the Apple II demonstrate, software sells hardware. If it does not sell IBM hardware, then the plug-compatible rivals will benefit. □

Digital Research's offering

DIGITAL RESEARCH may not have written PC-DOS, but it has produced a range of products to run on the IBM PC. First is Digital's own DOS, CP/M-86, to rival Micro-Soft's. To encourage people to use it, Digital has priced it at only £42 — about one-quarter of the cost of the IBM version.

In addition, CP/M-86 incorporates some enhancements. They include a print spooler, to allow background printing while the micro is used for something else, GSX extensions for use with graphics packages and a library of device drivers for use with various popular printers.

A multi-tasking version of the famous operating system, called

Concurrent CP/M-86, will also be available, plus a range of programming languages such as CBasic, CBasic Compiler, Pascal MT+, Cis Cobol, and PL/1.

Concurrent CP/M-86 can be bought separately or as part of the PC Power Pack. This includes a Percom Data 5.25in. Winchester hard disc, a 256K RAM board and controller.

Finally, Digital Research has announced Logo for the IBM PC. It will be able to use the whole of RAM, giving up to 100,000 workspace nodes.

Contact Digital Research (U.K.) Ltd, Oxford House, Oxford Street, Newbury, Berkshire RG13 1JB. Telephone: (0635) 35304. □



Microsoft's Multiplan spreadsheet is proving to be one of the most popular of its type. It is already available for the Apple II, Wang PC, Olivetti MS-20 and Victor 9000 micros, among others. Now it has been produced for the IBM PC and customised for the IBM keyboard. An excellent extra feature is the ability to "paint" in colour to produce blocks or windows of information. Contact Microsoft Europe Ltd. Telephone: (04427) 75091. □

Now the VIC 20 and 64 can communicate with PET peripherals



VIC and 64 users

Would you like to be able to access **any** of these peripherals from your computer?

- 1/3 megabyte disks (Commodore 4040 drive)
- 1 megabyte disks (Commodore 8050 drive)
- 10 megabyte disks (Commodore 9090 hard disk)
- Printers including a wide range of inexpensive IEEE and RS232 matrix and quality printers
- IEEE instruments such as volt meters, plotters etc.

Now you are no longer limited by the VIC or the 64's serial bus. Simply by attaching INTERPOD you can vastly increase the power of your VIC 20 and when used with the new 64, INTERPOD turns the computer into a really powerful system.

With INTERPOD the VIC and 64 become capable of running really professional quality software such as Word-processing, Accounting, Instrument control and many more.

INTERPOD will work with any software. No extra commands are required and INTERPOD does not affect your computer in any way.

Using INTERPOD is as easy as this:

Simply plug INTERPOD into the serial port of your computer, power-up and you are ready to communicate with any number of parallel and serial IEEE devices and any RS232 printer.

INTERPOD costs £125.00 plus VAT

INTERPOD

THE PROFESSIONAL'S CHOICE

Act Sirius 1

16 Bit Stand Alone Micro with superb features. 128K, 1.2MB Floppies CPM86 as standard - £2395



Altos

Up to 4 terminals and 40MB of Winchester Disk. One of the biggest selling small business systems starting at £2200. 16 Bit system with 8 terminals available.



IBM Personal Computer

The world's most popular 16 Bit Stand Alone Micro. 64K-512K RAM, 700K Floppies. 5-12MB of Winchester Disk available. MSDOS standard. From £2515



Videcom Apollo

15 inch green screen, Full tilting and swivelling VDU, Detachable keyboard, Optional 132 column screen, 25 function keys dedicated to Wordstar Two models: 750K or 1.5MB disk drives, CP/M based. From under £1800



Superbrain II

Still a leader in 8 bit price performance, KGB having sold over 600 Superbrains has unbeatable experience on them. From £1485.



Word Processing - Wordstar £250, Mailmerge £75.

Full on-screen facilities enabling the printing of standard letters and preparation of mail shots.



Accounting - From £300 per module.

Integrated accounting systems with Invoicing, Sales, Purchase and Nominal Ledgers.



Financial Modelling - Micromodeller £645.

Budgets, forecasts and accounting data become easy to prepare. Allows "what if" projections.



Calculation - Supercalc £175.

Electronic worksheet for preparation of budgets and tables of data.



Record Keeping - DMS £400, D Base II £395.

Personnel, stock or any other records with quick retrieval, sorting and reporting.



Sales Office Management - Sales Desk £300.

For the busy sales office to manage sales leads and marketing lists.



Accounts - IRIS £950

Incomplete records and time recording systems.



Payroll - From £350.

Up to 500 employees both weekly and monthly paid. Automatic deduction for items like company pensions.



Graphics - Price depends on application.

Full on-screen graphics both colour and black and white.



Engineering - SPERT £450

Suite of programmes for PERT analysis and civil engineering applications.



Communications - Liberator £250.

Enables a micro-computer to act like a mainframe terminal and transfer data from Floppy disc to another computer.



Languages - From £150.

Most major computer languages are available: Basic, Cobol, Fortran, Pascal and Assembler.



Solicitors - Solare £1600.

Solicitors accounting, client accounting and time recording.



Multi-terminals - MP/M and Oasis from £350.

Multi-user systems available.



KGB

MICROS LIMITED

14 Windsor Road, Slough SL1 2EJ. Tel: Slough (0753) 38581/38319. Telex: 23152 K Micro.

and in Scotland: Micro Change Ltd, Telfer House, 74/80 Miller Street, Glasgow Tel: 041 204 1929

● Circle No. 125

You're just one step away from one-step accounting



Anagram Systems' Integrated Accounts is, simply, the most comprehensive, easiest to understand integrated accounting package available to Commodore users. It is the best reason yet for choosing Commodore.

And now there is Anagram Integrated Accounts with integrated Stock Control – on top of superb Anagram standalone Stock Control and ledger packages. Just look at these features and options.

Full integration: Anagram Integrated Accounts consists of Sales, Purchase and Nominal Ledgers, Cash Book, and functions which permit journal entries, file maintenance and report printing in remarkable detail. All these are automatically updated when you make an entry. In the version with Stock Control, creating an invoice updates the stock as well as the other modules.

Single- or multi-user: Anagram Integrated Accounts, with or without the integrated Stock Control, can be supplied either single-user, or multi-user for up to five machines for only £300 extra per machine. The same goes for Anagram Stock Control.

Hard disk or floppies: Integrated Accounts is on just one floppy disk – compare that to competitive packages – and runs successfully with the Commodore twin disk units. Integrated Accounts with Stock Control and Sales Order Processing ideally requires a hard disk.

Open Item or Balance Forward: Choose which system you want for each account – you can even mix the two.

Extensive analysis: Each sales invoice can be analysed across ten nominal headings; each purchase invoice across eight. You can set up budgets within each nominal heading to get comparisons of 'budget to actual' at any time.

Easy to understand, learn and use: Anagram Accounting and Stock Control packages are designed for busy people who don't want to mess about with computers. They use ordinary book-keeping terms without jargon.

Your Commodore dealer should have these packages ready for demonstration. If not, phone Anagram and we will fix a demonstration for you. Or send the coupon.

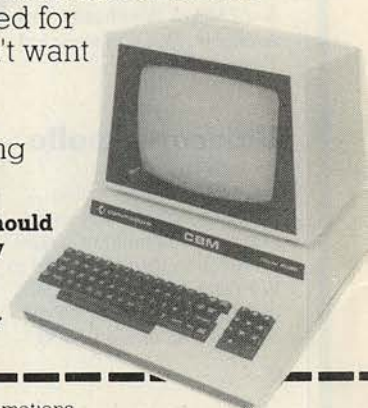

To: Commodore Special Promotions
Department, 675 Ajax Avenue, Trading Estate,
Slough, Berkshire SL1 4BG.
Telephone: Slough (0753) 79292.

Send me brochures on the Anagram packages I have ticked and tell me where to see them running.

- Integrated Accounts with Stock Control
 Integrated Accounts Standalone Stock Control
 Standalone Ledgers

Name _____
 Position _____
 Company _____
 Nature of business _____
 Address _____

 County _____ Postcode _____
 Telephone No. _____
 Any existing CBM computer _____

 **ANAGRAM SYSTEMS**
 60A, Queen Street, Horsham, West Sussex
 RH13 5AD. Tel. (0403) 50854 58153

 **commodore**
COMPUTER

CBM is a trademark of
 Commodore Business Machines
 (UK) Ltd

AN/PCO/03

● Circle No. 126

Axioms and assumptions

Boris Allan discusses different approaches to the logical processes of argument.

WHEN EXAMINING any argument for its validity Aristotle suggested that there are two key aspects to be studied. The first aspect is what we now call deductive logic — the process by which we move from our assumptions to our conclusions. Aristotle was concerned to find valid processes of argument by what he termed apodeictic logic.

The other aspect is what we might now call inductive logic — the nature and status of our assumptions. He was concerned to find valid bases for argument by discerning the essences of things.

Aristotle realised that each initial condition is itself a result of earlier conditions. Why is the initial condition an initial condition? On page 175 of *Aristotle*, H B Veatch explains: "at each stage of the explanation the why-question recurs, and apparently so as never to receive a final answer."

Aristotle's method

In mathematics and those subjects considered to be mathematically inclined the Aristotelean distinction between induction and deduction has been codified into what is termed the axiomatic method. In mathematics an assumption is called an axiom, defined in the *Oxford Dictionary* as "a self-evident proposition, requiring no formal demonstration to prove its truth but received and assented to as soon as mentioned." The axiomatic method derives its power from the possibility of deriving many results from a few assumptions, the axioms. The classic example is that of Euclidean geometry — see *Mathematics in western culture*, chapter 4.

In contemporary mathematics a proof consists of showing how a conclusion follows from the assumptions. If a conclusion does follow from the axioms then it is often termed a theorem of the system. Suppose you had the assertion that

$$(A + B)^2 = A^2 + 2AB + B^2$$

To prove it is true one has to make certain assertions and by use of accepted rules of derivation produce the above result. *Concepts of modern mathematics*, pages 76 and 77 makes eight assertions. You prove one assertion, the theorem, by use of other assertions, the axioms. The first axiom to be listed by *Concepts of modern mathematics*

is

$$(A + B) + C = A + (B + C)$$

This is not a self-evident truth, it is the associative law of addition and has to be shown to be true — that is, it is treated not as an axiom but as a theorem.

The associative law might seem to be self-evidently true since

$$(3 + 4) + 5 = 3 + (4 + 5) = 12$$

But why should it be true for numbers other than 3, 4 and 5? And even if it were true for all numbers why is it true for A, B and C? We are back to Aristotle's distinction: ultimately you cannot justify your axioms unless you "know" that something is true.

How would you define the meaning of 1? It is impossible to define 1 in terms which do not presuppose other numbers, yet everyone knows what is meant by 1. We all know that $1 + 1 = 2$, but how do you prove that the first 1 is the same as the second 1?

Does 1 man + 1 woman = 2 children? Our knowledge of numbers is intuitive. By some means or other as we grow up we come to know that $1 + 1 = 2$ — though not in some cases. Our knowledge of numbers is a clear example of what Aristotle calls inductive logic.

In *A mathematician's apology*, pages 140 and 141, G H Hardy, a mathematician of note, has written: "a real mathematician has his conscience clear; there is nothing to be set against any value his work may have; mathematics is, as I said at Oxford, a 'harmless and innocent' occupation." Hardy suggests that the keynote of mathematics is the ability of the mathematician to create, to transcend

reality. He distinguishes between real mathematics and trivial mathematics, where real mathematics is distinguished by the quality of thought.

Take the assertion $1 + 1 = 2$ as perhaps being the most primitive of all axioms in mathematics, assumed by all subsequent proofs. In what can the assertion be justified, as it cannot be proven by more primitive axioms. The only possible justification is that it has always been the case.

The justification must be in terms of our experience, of taking one thing and then another and finding there are two things — though at the subatomic level funny things may happen. The process by which we come to our conclusion that $1 + 1 = 2$ is inductive, and is similar in form to an assertion that the sun will rise tomorrow.

The axiomatic method in mathematics is built upon inductions which are totally reasonable but nevertheless are still inductions. Is it any more reasonable to accept the reasoning in *Principia Mathematica* by Russell and Whitehead than to accept the sun rising?

Induction distinction

A distinction is claimed between what is termed scientific induction and ordinary induction. If we can predict that the sun will rise tomorrow by use of laws of relativity, then it is held to be more convincing than just hoping, because the laws of relativity applied to the solar system depend upon a wider range of inductions. Yet all applied laws are generalisations based on past experience.

Ever since Aristotle, philosophers and scientists have been aware of the key problem of induction. In this century Popper presented a means by which one could evaluate scientific and ordinary arguments. As you can never prove that an argument will be true for all time, he suggests we should investigate ways of establishing the falsity, or incorrectness, of assertions. "There will be a revolution" is an example of an assertion which is inherently untestable because we have not decided when, if ever, the revolution will come. "By 1984 there will be a revolution" is testable, because by 1985 we will know

(continued on next page)

References

- A mathematician's apology* by G H Hardy. Cambridge University Press (1967)
- Mathematics in western culture* by M Kline. Penguin Books (1972)
- Gödel's proof* by E Nagel and J R Newman. Routledge & Kegan Paul (1958)
- The logic of scientific discovery* by K R Popper. Hutchinson (1968)
- Concepts of modern mathematics* by I Stewart. Penguin Books (1975)
- Aristotle* by H B Veatch. Indiana University Press (1974)
- Wittgenstein's lectures on foundations of mathematics* by L Wittgenstein. Harvester (1976)

(continued from previous page)

whether it has happened or not happened.

Popper split arguments into two classes: scientific, that is testable, arguments and metaphysical or not testable arguments. The test always has to be against reality. One could fault arguments by examination of the deductive processes used to relate the initial assertions to conclusions, that is the deductive aspects. In testing against reality you are actually testing the original assertions. If the deductive aspect is correct, then any conclusion is only a product of the original assumptions.

A mathematical argument is, in one sense, an example of metaphysics: there are no testable conclusions, and mathematical induction is simply a variant of axiomatic systems. The case for the initial assumption is based ultimately on inductions such as $1 + 1 = 2$. It is then assumed to be true for a later version, and the successor to the later version is then worked out. If the difference between the two versions is according to the formula, then the formula has been correct.

By pure induction it is then possible to generalise that it is true for all cases. This appears to be justified by a rule which allows you to follow on from successive happenings and so, it is claimed, it is in some way different from using laws of relativity to predict the sun will rise tomorrow. The logic involved in moving from the assertion that if it is true for 1 and true for N it is true for $N + 1$ and for $1 + 1 = 2$ is simply inductive. We know that we can replace N by 1 to give

$N + 1 = 2$, but can it be justified by a totally deductive argument?

Commentators who have followed on from Popper, especially Lakatos, have noted that when faced with the collapse of an argument yet with the deductive part of the argument appearing to be correct, it is usual to add extra assumptions to accommodate the new results. The Bohr theory of atomic structure is a good example. Mathematical arguments can be faulted on their initial assumptions, as well as on their process of argument — see *Wittgenstein's lectures on foundations of mathematics*. But when one comes to examine correctness proofs for actual programs, the addition of extra axioms becomes very popular.

Take the trivial program

$$10 A = 1$$

put forward as perfectly correct, and therefore a refutation of the argument that there is no thing as a correct program. One only needs to note that there is no Let and no End for the program to be shown to be incorrect, and thus to refute the assertion that the program is correct. When faced with such refutations the automatic reaction of some is to change the grounds for argument.

One obvious way of adding extra axioms is to restrict the type of language and the type of machine. To prove programs correct in a vacuum is pointless — they must run on a specific machine.

It is not possible to leave this topic with-

out mentioning a powerful argument concerning the inadequacy of deductive processes of argument in mathematics. When I called the program trivial I was thinking of Gödel's Theorem, the simplest exposition of which is in Nagel and Newman's *Gödel's proof*.

Gödel showed that in any system which is sufficiently non-trivial to refer to itself, there are assertions whose truth or falsehood cannot be established by derivation from other assumptions. A complex computer language may produce programs which are untestable by mathematical means, if one accepts the truth of Gödel's proof.

Popper wrote in *The logic of scientific discovery* that he did not believe that there was such a thing as a valid inductive argument, because being inductive it could never be established as correct. Popper also wrote that he was not considering mathematical induction, because mathematics was part of metaphysics, that is mathematical arguments had no relation to reality. On page 72 he considered mathematical axioms, in this case those of Euclid, as purely conventions with no relation to reality, or as hypotheses with relation to reality.

My assertion is that though correctness proofs can be useful in establishing consistency in programs they cannot establish correctness in the real world. What is more, the effort involved would seem rather fruitless.

REGISTERED REFERRAL CENTRE FOR THE BBC PROJECT BEEBUG FOR THE BBC MICRO

INDEPENDENT NATIONAL USER
GROUP FOR THE BBC MICRO

MEMBERSHIP NOW EXCEEDS 12,000

12,000 MEMBERS CAN'T BE WRONG — BEEBUG PROVIDES THE BEST SUPPORT FOR THE BBC MICRO. BEEBUG MAGAZINE — NOW 36 PAGES — DEVOTED EXCLUSIVELY TO THE BBC MICRO.

Programs — Hints & Tips — Major Articles — News — Reviews — Commentary. PLUS members discount scheme with National Retailers. PLUS members Software Library — a growing range of software from around £3.50 per cassette. 10 Magazines a year. First issue April 1982. Reprints of all issues available to members.

June Issue. Program Features: Mazetrap, Mini Text Editor, Polygon. Plus articles on upgrading The User Port, TV set and Monitor review, Graphics part II. More Assembler Hints, Structuring in BBC Basic, Plus BBC Bugs.

July/August Issue. Program Features: Beeb Invaders Patchwork Programming Screen Dump, Plus Teletext articles using the mode, BBC Cassette, Bugs Fix, Software Review, using the User Port, more on Structuring in Basic, Using User Defined Keys, Input Function and many Hints & Tips.

September Issue. Games Programs: Higher/Lower and Hangman, plus String Search Program, Articles on Debugging Programs, a safe verify, new user guide, Er-rata, Creating and Moving Multicoloured Characters, Logic on the Beeb, Ideas on Colouring and Shading, Acorns ROM replacement charge, plus much more.

October Issue. Program Features: Alien Attack, Calender Generator, Union Jack, and Memory Display Utility. Plus articles on Debugging, Improving Key Detection, Acorn Press Release on O.S. 1.2 and Issue II Basic, The Tube and Second Processor Options, a New Series for Less Experienced Users and Software Reviews.

Dec/Jan Issue. Program Features: Space City (Invader type game), Breakout, Artist (Joystick painting program), Rescue (Miraculously retrieves programs after Bad Loading or "Bad Program Message") and Pack — a program to compact basic programs and disc system review, Software reviews — including Wordwise, Book reviews, adding Joysticks interface to Model A; How to access the video controller chips and ideas for the newcomer; plus a new crop of hints and tips.

MEMBERS SOFTWARE LIBRARY+

GAMES 1. STARFIRE (32k), GAMES 2. MOONLANDER (16k), 3D NOUGHTS AND CROSSES. GAMES 3. SHAPE MATCH (16k), MINDENDER (16k), GAMES 4. MAGIC EEL (32k). 13% discount to members on the excellent wordwise word processing package — this represents a saving of over £5.00.

Send £1.00 & SAE for Sample.
Membership: UK £5.40 for six months
£9.90 for one year
Overseas one year only:
Europe £16.00 Middle East £19.00
Americas & Africa £21.00
Other Countries £23.00

Make cheques to BEEBUG and
send to:
BEEBUG Dept 5, 374 Wandsworth Rd
London SW3 4TE

Editorial Material to PO Box 50,
St Albans, Herts, AL1 1AR



FULL DETAILS AVAILABLE FROM

MSS Computer & Business

Consultants

54 Chapel Road

Worthing

Tel No: 0903-34755

SUSSEX

WINCHESTER KILLER - £750

The incredible Scorpio 6.2 Mbyte hard disk alternative from HAL Computers annihilates small capacity Winchester.

DISTINGUISHING CHARACTERISTICS

Hard disk capacity and speed with the capability of interchangeable media. Scorpio 8 eliminates the worries of head crashes, drive alignments, lost data or backup, with a new application of field proven floppy technology.

Fully Apple II compatible - DOS 3.3, Pascal 1.1 and CP/M. Uses all standard Apple DOS commands - appears to Apple as a massive 8 inch floppy.

HOW SCORPIO 8 IS KILLING THE SMALL WINCHESTER

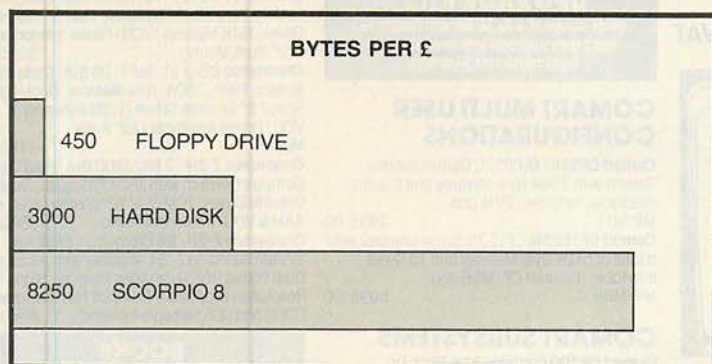
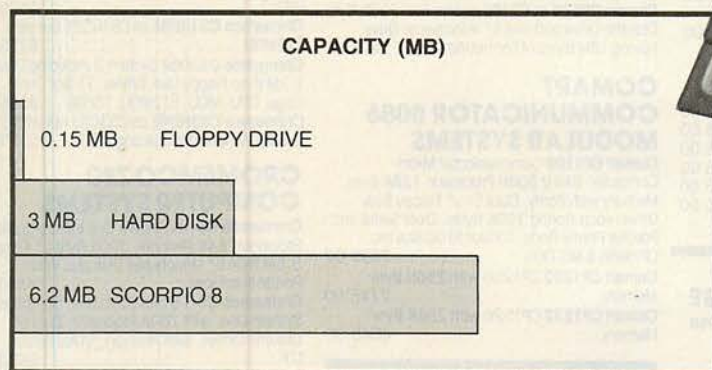

REWARDS

- Winchester capacities on floppy disks.
- Removeable media - a cartridge pack of five 5.25 inch diskettes each of 1.2 Mb capacity.
- High speed DMA data transfer.
- Cost effective and software compatible disk memory expansion.
- Removeable media means separate packs can be kept for different applications.
- All this for £750, complete with power supply, interface, cables and software.

To claim your rewards contact us at the address shown below.

HAL Computers Limited
Invincible Road, Farnborough
Hants. GU14 7QU
Telephone (0252) 517175
Telesales (0252) 517171

THE MOST DIFFICULT THING ABOUT GETTING A COMPUTER IS GETTING THE RIGHT ONE.

BBC MICROCOMPUTER

BBC Micro Model B	419.00
Games Paddles	11.30
14" Colour Monitor	250.00
12" Monochrome Monitor	90.00
Single Disk Drive	230.00
Selection of business, educational, graphics & games software available from	3.50



EPSON HX-20 PORTABLE COMPUTER

Diminutive fully featured business computer that is small and light enough to slip into a briefcase. Specification includes integrated LCD screen, printer and microcassette; 16K RAM expandable to 32K and its own rechargeable power supply. Ideal for people on the move - data can be subsequently 'down loaded' on to a larger machine when you return to base.

402.00 ex. VAT



CROMEMCO C-10 PERSONAL COMPUTER

A full feature personal business computer system including software - for the price of a VDU. Also the entry point into the renowned Cromemco range. **1195.00 ex. VAT**

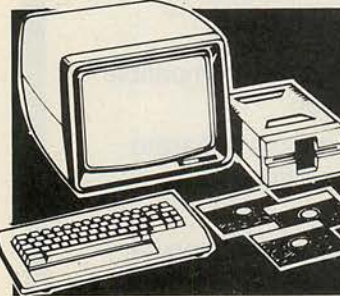

C-10 SP Personal Computer Superpak inc. Z80A Processor, 64K Memory, Single 5 1/4" 390K Byte Floppy Disk, 24 x 80 Screen, CKBA Keyboard, CP/M Compatible Operating System, plus Word Processing, Financial Planning & 32K BASIC Software 1195.00
Additional 5 1/4" Floppy Disk Drive 450.00
120 Word / Min Daisy Wheel Printer 675.00

OSBORNE

Osborne Portable Computer inc. Standard Software - Wordstar, Mailmerge, Supercalc, MBASIC, CBASIC, CP/M 1250.00
Osborne Double Density Version inc. USDC-P System 1375.00
Osborne Starter Kit inc. Daisy Wheel Typewriter Printer 1699.00



OSBORNE

Truly portable personal small computer system housed in a 'snap together' case complete with business programs, so you can start work almost anywhere.

1250.00 ex. VAT

PRINTERS - IMPACT

Anadex DP9500A 132 Cols., 150CPS Matrix Printer with Graphics. 10, 12.5, 13.3, 16.4 Char/In, Low Noise 1150.00
Anadex DP9501A 132 Cols., 150CPS Matrix Printer 10, 12, 15, 16.4 Char/In, Low Noise 1150.00
Anadex DP9620A 200CPS Printer, Low Noise, 10, 12, 15, 16.4 Char/In 100 CPS in Double Pass Enhanced Mode 1250.00
Anadex WP6000 Dual Mode Printer 132 Cols, 150/180CPS Correspondence Quality, 300/330CPS Draft and Graphics Mode, Diablo 630 Protocol Emulation 1950.00
Epson MX80T/3 Tractor only 80CPS 349.00
Epson MX80FT/3 Friction and Tractor 389.00
Epson MX100FT/3 Friction and Tractor 100CPS 499.00

PRINTERS - DAISY WHEEL

Brother HR1 650.00
Brother 8300 458.00
Crown Ranier - Brother 19CPS 795.00
Diablo 620RO 25CPS 995.00
Diablo 630RO 1575.00
Smith Corona TP1 475.00

NORTH STAR ADVANTAGE

Two versatile desk top options to choose from featuring high quality business graphics with either 720Kb floppy or 5Mb hard disk storage.

From 2195.00 ex. VAT



NORTH STAR ADVANTAGE

Advantage Desk-Top System inc. Keyboard, Graphics, Screen (Green), 64K Byte RAM, Z80A Processor, Serial Interface, Dual 350R Byte Diskette Drives and Business Graphics Software 2195.00
Advantage H/D Desk-Top System, as above except single 350K Diskette Drive + 5M Byte 5" Winchester Hard Disk Inc. Business Graphics Software 2995.00
Advantage upgrade to Intel 8088 Processor with 64KB Memory@ 320.00

COMART COMMUNICATOR

PRICES EXCL. VAT

Clearly the most price competitive modular computer system on the market with built-in expandability - inside and out.

Inc. CP/M **From 1895.00 ex. VAT**

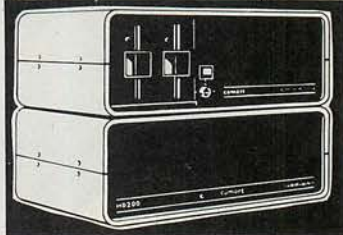

COMART COMMUNICATOR Z80A MODULAR SYSTEMS

Comart CP100 'Communicator' Micro Computer: Z80A Processor, 64K Byte Memory, Dual 5 1/4" Floppy Diskette Drives each storing 390K Bytes of Data, Dual Serial and Parallel Ports, 10 Slot S100 Bus. CP/M Version 2 included 1895.00
Comart CP200 as CP100 except Dual 790K Byte Diskette Drives 2195.00
Comart CP500 as CP100 except one 790K Byte Diskette Drive and one 5" Winchester Drive having 4.8M Bytes of Formatted Data 2995.00
Comart CP520 as CP100 except one 790K Byte Diskette Drive and one 5" Winchester Drive having 19M Bytes of Formatted Data 3995.00

COMART COMMUNICATOR 8086 MODULAR SYSTEMS

Comart CP1100 Communicator Micro Computer: 6MHz 8086 Processor, 128K Byte Memory with Parity, Dual 5 1/4" Floppy Disk Drives each storing 390K Bytes, Dual Serial and Parallel Printer Ports, 10 Slot S100 Bus inc. CP/M86 & MS-DOS 2295.00
Comart CP1202 CP1200 with 256K Byte Memory 2745.00
Comart CP1522 CP1520 with 256K Byte Memory 4545.00

UPGRADE KITS

Wide range of 8 to 16 Bit and floppy to hard disk upgrade kits available for Communicator Systems

COMART MULTI USER CONFIGURATIONS

Comart CP520 / M CP520 Communicator System with 256K Byte Memory and 6 Serial Interfaces. Includes CP/M and MP/M11 4995.00
Comart CP1525M CP1520 Communicator with a total of 512K Byte Memory and 10 Serial Interfaces. Includes CP/M86 and MP/M86 5995.00

COMART SUBSYSTEMS

Comart CB200 Cartridge Tape Back-Up Subsystem for Hard Disk 2495.00
Comart HD520 5" x 20M Byte Hard Disk Subsystem (requires HDCONT or can be added to a CP520 or CP 1520) 2395.00
Comart HDCONT Winchester Disk Controller for 2, 20M Byte Drives 195.00
Comart FD800 8" Floppy Single Disk Drive Subsystem; Single Sided, Single Density IBM 3740 Compatible (requires C-IFDC) 995.00
Comart MP / MSUB Hardware & Software to Upgrade Communicator to MP/M. Includes MP/M, two 48K Byte CRAM 48 Memory and 4SIO Serial Interface Card 1150.00

S100 BOARDS PRICES EXCL. VAT

Comart CRAM64 64K Byte Dynamic RAM with Bank Select 200.00
Comart CRAM48 48K Byte Dynamic RAM with Bank Select 180.00
Comart CRAM256 256K Byte Dynamic RAM with Parity, 8 and 16 Bit Data. IEEE696 Compatible. Also supports 8 Bit Bank Switching 550.00
Comart C-CPU86 8086 Processor Card, with Dual Serial and Parallel Ports, Monitor in 8K EPROM and 4K RAM 300.00
Comart C-IFDC Intelligent Diskette Drive Controller with Z80A Processor 295.00
Comart C-CPU Z80A system Processor Board incl. 2 Serial / 1 Parallel Port 200.00
Comart 4SIO 4 Channel Synch / Asynch Interface Board 250.00
Dual Systems CLK24 Battery Supported Real Time Calendar Disk 295.00
Dual Systems CMEM32 32K CMOS Battery Supported Memory 1195.00
Dual Systems CMEM16 16K CMOS Battery Supported Memory 895.00

CROMEMCO 68000/Z80A SUPER MICRO SYSTEMS

Cromemco CS1D2E System 1 including Dual 390K 5" Floppy Disks, DPU, MCU, 256MSU and 16 FDC Cards in 8 Slot S100 Card, Table Top Enclosure 3620.00
Cromemco CS1D5E as CS1D2E but with 512 MSU 4280.00
Cromemco CS1HD2E System 1 including Single 390K 5" Floppy Disk, 5.5M Byte 5" Winchester Disk, DPU, MCU, 256MSU, 16FDC, WD12 5595.00
Cromemco CS1HD5E as CS1HD2E but with 512MSU 6255.00
Cromemco CS3D5E System 3 including Dual 1.2M Byte Floppy Disk Drives, 21 Slot Card Cage, DPU, MCU, 512MSU, 16FDC 6585.00
Cromemco CS3HD5E as CS3D5E but with 5" 5.5MB Winchester Disk and WD1 8230.00

CROMEMCO Z80 COMPUTER SYSTEMS

Cromemco CS-1H System One including Z80A Processor, 64K Memory, 390K Byte 5" Floppy, 5.5M Byte 5" Winchester Disk and VDU / Printer Interfaces 4595.00
Cromemco CS-18 Slot S100 Bus. Computer System One, with Z80A Processor, Dual 5" Diskette Drives, 64K Memory, VDU/Printer I/F 2630.00
Cromemco CS-2 21 Slot S100 Bus. Computer System Two, Z80A Processor, Dual 5" Diskette Drives, 64K Memory, VDU/Printer Interfaces (19" Rack Mount) 3095.00
Cromemco CS-3 21 Slot S100 Bus. Computer System Three: Z80A, 64K Memory, Dual High Speed 8" Diskette Drives (1.2M Byte each), VDU/Printer Interfaces (19" Rack Mount) 4495.00
Cromemco Z-2H 12 Slot S100 Bus. Hard Disk Computer System with Z80A Processor, Dual 5" Diskette Drives, 10M Byte Winchester Drive, 64K RAM & VDU / Printer Interfaces 6585.00
Cromemco Z-2H / GS Cromemco Graphics System based on Z-2H, together with additional Dual Ported 96K Byte Video Memory, High Resolution Graphics I/F and Bit Pad Interfaces CDOS and SGS Software Included 8560.00

BOOKS

Very wide range of computer books stocked at all shops.

BUG - BYTE SOFTWARE

All Tapes Available For Acorn, VIC, BBC, ZX81, Spectrum. Call for availability.

CROMEMCO SOFTWARE FOR 68000/Z80A SERIES

Cromemco CRO-D Cromix (Multi-User / Multi Tasking) Unix Based Operating System 395.00
Cromemco FOR-D Fortran '77 395.00
Cromemco PAS-D ISO Pascal 395.00

Cromemco ASM-D 68000 Macro Assembler 395.00
 Cromemco STB-D 32K Structured BASIC @ 395.00
 Cromemco CCC-D C-Compiler @ 395.00
 Cromemco COB-D Cobol Compiler @ 395.00
 Note: All 68000 Languages (Suffix D) require Cromix (CRO-D). All Software is available on 5" or 8" Floppy Disks - Please Specify.
 @ = Availability early '83

CROMEMCO LANGUAGES (Z80A)

Cromemco FDB 16K BASIC Interpreter 130.00
 Cromemco FDF Fortran IV Compiler 195.00
 Cromemco FDC Cobol Compiler 395.00
 Cromemco STB 32K Structured BASIC (includes KSAM) 130.00
 Cromemco FDR RATFOR- Rational Fortran IV Compiler & Pre-Processor 260.00
 Cromemco FDA Z80 Macro Assembler 195.00
 Cromemco CCC C Compiler (Requires Cromix) 395.00
 Cromemco RPB RPGII Report Generator 395.00
 Cromemco LSP LISP List Processor 260.00
 Cromemco COL Overlay Link Editor 260.00
 Cromemco IDS I.O.P. Development Software 395.00
 Cromemco CDS Diagnostic Systems Software 130.00
 All software is available on 5" or 8" Diskettes - please specify.

VDU'S & MONITORS

Comart WY100 Visual Display Terminal, Green Display, 24 x 80 and Status Lines. Detached 105 Key Keyboard with Numeric Pad, Function, Cursor and Editing Controls. Swivel and Tilt Display 675.00
 Volkercraig 4404 595.00
 Volkercraig 4404WS 695.00
 Cromemco RGB14LP. High Resolution Colour Monitor 1395.00
 12" Green Screen Monitor 99.00

DISKETTES

Byteshop 5 1/4" Single Sided, Single Density 1.70ea
 Byteshop 5 1/4" Single Sided, Double Density 2.13ea
 Dysan 5 1/4" Double Sided, Double Density 3.90ea
 Dysan 8" Double Sided, Double Density 4.40ea
 Full range of 5 1/4" & 8" Diskettes in stock

CPM SOFTWARE

BASCOM Microsoft Basic Compiler 227.46
 BASIC-80 Microsoft Basic Interpreter 205.27
 BAZIC Micromikes Basic Language 120.00
 BSTAM BYROM Software Communications Package* 115.00
 BSTMS BYROM Software Communications Package 115.00
 CALSTAR Micropro Financial Planning Electronic Spread Sheet Package 90.00
 CARDBOX Caxton Store / Search System 155.00
 CB80 Digital Research Basic Compiler 314.00
 CBASIC Digital Research Basic Language 94.00
 CBASIC / 86 D / R Basic Language 204.00
 CIS COBOL Microfocus COBOL Language* 425.00
 COBOL-80 Microsoft COBOL Compiler 421.63
 CP / M for SBC Digital Research Operating System 126.00
 CP / M-86 DISPWR Digital Research Operating System 204.00
 CP / M-86 + CB86 DW Digital Research Operating System + Language 380.00
 DATASTAR Micropro Database Package 175.00
 DBASE II Ashton-Tate Relational Database + ZIP 435.00

SYSTEM SPOTLIGHT IBM PERSONAL COMPUTER

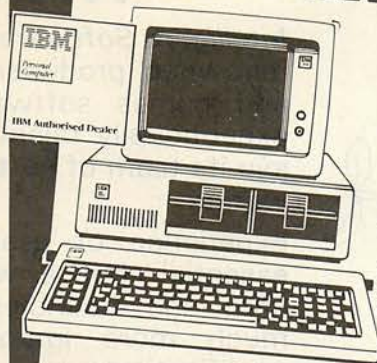

We're delighted to announce that The Byteshops have been appointed IBM Authorised Dealers in the UK for the fantastic new IBM Personal Computer. The most significant microcomputer introduction for years, the IBM PC can be employed by, for example, the small businessman as a stand alone desk top system, or the large corporate user as an intelligent terminal for a main frame. Our 'star' configuration is the 320K Byte Disk model with 128K RAM, UK specified keyboard and screen. At the Byteshop you'll also find that we've given a lot of thought to supporting the IBM PC. Our IBM trained staff can offer you a comprehensive portfolio of IBM PC software and programmes plus add on's and add in's and specialist interfaces for just about every kind of commercial, industrial and laboratory application. Come and talk to us about an inspired machine. The IBM PC.

IBM PC Single 160K Byte Disk Drive 64K Byte RAM UK Keyboard and Screen 2080.00
 IBM PC Dual 320K Byte Disk Drives 64K Byte RAM UK Keyboard and Screen 2630.00
 IBM PC Dual 320K Byte Disk Drives 128K Byte RAM UK Keyboard and Screen 2973.00
 IBM Printer inc. Stand and Cable 469.00
 Microvitec Colour Monitor 575.00

SOFTWARE FOR THE IBM PC

BSTAM Byrom Communications Package 115.00
 CBASIC / 86 Digital Research Language Package 204.00
 CCP / M-86 Digital Research Concurrent CP / M Operating system 220.00
 DBASE II Ashton-Tate Database Package 435.00
 EASYFILER IUS Database Package 229.00
 EASYPLANNER IUS Financial Planning Package 143.00
 EASYSPELLER II, IUS Word Processing Package 71.00
 EASYWRITER II, IUS Word Processing Package 200.00
 MAILMERGE Micro Pro Word Processing Enhancement 145.00
 MICROSTAT Ecosoft Statistics Package 195.00
 PASCAL MT + 86 Digital Research Language 377.00
 SPELLSTAR Micro Pro Word Processing Enhancement 145.00
 SUPERCALC Sorcim Financial Planning Package 190.00
 WORDSTAR Micro Pro Word Processing Package 295.00
 WS + MAILMERGE Micro Pro Word Processing Package 390.00
 WS + SPELLSTAR Micro Pro Word Processing Package 415.00
 WS + MM + SP / S Micro Pro Word Processing Package 510.00

TECMAR PC MATE ADD ON'S AND ADD IN'S FOR THE IBM PC

TECMAR Winchester Share / 5 Expansion 5M. Byte, H/D with shared system adapter for up to 4 x IBM PC's inc. expansion unit 1995.00
 TECMAR Five in one W / 64K Bytes; 64K Byte dynamic memory card c / w serial and parallel ports, clock and calendar 380.00
 TECMAR Five in one W256K Bytes; 256K Byte dynamic memory card c / w serial and parallel ports, clock and calendar 655.00
 TECMAR Dynamic Memory 64K Bytes 260.00
 TECMAR Dynamic Memory 256K Bytes 530.00

The above is just a small selection from the 60 plus Tecmar IBM PC compatible add in's and add on's and specialist interfaces that we offer. There are data storage expansion cards; industrial, scientific and laboratory interfaces; extended input/output expansion cards; general support; communications and software utilities. Please contact us for a full listing.

FILESTAR Microsec's Disk Reformatter CP / M to IBM, DEC, Motorola and Intel Formats 110.00
 FMS-80 DJR Assoc. Database / FM 650.00
 FMS-81 / 82 from 350.00
 FORMS 2 Microfocus Table Maker 110.00
 FORTRAN-80 Microsoft FORTRAN Compiler 288.48
 GBS Bytesoft General Business System 810.00
 INFOSTAR Micropro Database / Reporter 295.00
 ISL Bytesoft Accounting Package 1110.00
 KSAM80 EMS Database 350.00
 MACRO-80 Microsoft Macro Assembler 116.50
 MAILMERGE Micropro Wordprocessing Enhancement to link with WORDSTAR* 145.00
 MARS Sapphire Business System* 295.00
 MICROSTAT Ecosoft Statistics Package* 195.00
 MILESTONE Organic Software Critical* Path Package 225.00
 PASCAL MT + &SPDP / R Pascal Language with Speed Programming Tool 314.00
 PASCAL / MT + D / R Pascal Language 220.00
 PASCAL / MT + 86 Digital Research Pascal Language for 16 Bit Systems 377.00
 PEACHTREE Basic Accounting System per module 325.00
 PEACHTREE Business Management System per module 600.00
 PERSONAL PEARL Pearl Data Base / FM 185.00
 PLANNERCALC Comshare Financial Planning Package 39.00

PL / I-80 Digital Research Language 314.00
 REPORTSTAR Micropro Reporter 210.00
 SPELLSTAR Micropro Proofreading Utility to link with WORDSTAR 145.00
 SUPERCALC Sorcim Financial Planning / Budgeting Spread Sheet Package* 190.00
 SUPERSORT Micropro Sort Utility 145.00
 SUPERVYZ Epic Application Control 86.00
 T / MAKER II Lifeboat Associates Financial Planning / Spread Sheet Package 195.00
 WORDSTAR Micropro Wordprocessing Package* Also available with Mailmerge and Spellstar 295.00
 WP WORKSHOP MAC Ltd Training Guide for WORDSTAR or MAILMERGE 75.00
 X BASIC Xitan Language 185.00
 X CP / M Xitan / DR Operating System 118.00

Many Utilities, Programming Tools and Training Packages available. Also extensive range of diskette formats. Prices include configuration on machines supplied by ourselves. We are totally committed to after sales service and future support.

* These software packages are available for both CP / M And CP / M86.

ALL PRICES EXCLUSIVE OF VAT

* Barclaycard Visa & Access cards taken in payment.



* Shop opening hours 9 - 5.30, check individual shops for details of Saturday opening times.

* Phone Mail Orders accepted. Please contact nearest shop for P.P. & Delivery Rates. Regret no C.O.D.

* Some items may be subject to a dollar surcharge if the dollar exchange rate changes more than 5 cents. Prices will be adjusted in line with the rate prevailing at the time of purchase.
 * Prices subject to change without notice
 E. & O.E. and are valid for the cover date life of this magazine. (March 83)

* Whilst we carry a vast range of stock, we cannot guarantee that every advertised item will be available in each shop.

* All goods are new and include factory warranties.

* No refunds on opened software.

* Orders from Government Depts. & Colleges etc. welcome.

* Leasing & HP facilities available - apply for written details.
 * Detailed prices available on request.



● Circle No. 130

THE BYTESHOP

Your Specialist Computer Centre

LONDON
 The Byteshop
 324 Euston Road NW1
 Tel: 01-387 0505

BIRMINGHAM
 The Byteshop
 94-96 Hurst Street
 Tel: 021-622 7149

GLASGOW
 The Byteshop, Magnet House
 61 Waterloo Street
 Tel: 041-221 7409

MANCHESTER
 The Byteshop
 11 Gateway House, Piccadilly,
 Station Approach Tel: 061-236 4737

NOTTINGHAM
 The Byteshop
 92A Upper Parliament Street
 Tel: 0602 40576

SOUTHAMPTON
 Also at XITAN Systems
 23 Cumberland Place
 Tel: 0703 334711

Members of the Comart Group of Companies

There are so many micro computers on the market that choosing the right one is far from easy. And it isn't made any easier when you find them cheek by jowl with cameras, hi-fi and a host of other electrical equipment. What you need is someone that is single minded. And that means us. Byteshops are totally dedicated to micro computers. So not surprisingly, we can offer you a wider range because we sell nothing else. Our prices are keener too. So are our staff. Each one is an expert who can make sure you get the computer that's exactly right for you - whether it's a home micro or a £20,000 business system. What's more we'll freely advise you on expanding or upgrading your system as your knowledge grows or your requirements change. While our Microserve Centres offer service and maintenance on site and at our shops. After all, we are the UK's longest established microcomputer specialists. Come and see us soon.



IS

INTELLIGENT SOFTWARE LTD

WANTED

Intelligent Software Ltd., internationally renowned producer of microcomputer and games software, is looking for exceptionally talented programmers to join its team of software designers and writers.

Experience of assembly language is essential, but a willingness to work hard and boundless enthusiasm are much more important than formal qualifications.

Intelligent Software is particularly interested in programmers who have proven abilities in the design and programming of video games.

We believe in outstanding pay for outstanding programmers.

Please write to:

David Levy,
Intelligent Software Ltd., Dept. PC,
21, Store Street,
London WC1E 7DH.

● Circle No. 131



FULL DETAILS AVAILABLE FROM

Tenhill Computer Systems
5th Floor Empire House
Wakefield Road
Dewsbury
Tel No: 0924-452626

YORKSHIRE

● Circle No. 132

TEXT

**TEXT PROCESSING FOR
COMMODORE**

INCLUDING:

**ADVANCED EDITING FACILITIES
MULTI-COLUMN PROCESSING
BUILT-IN CALCULATOR**

**MORE THAN JUST A
WORD PROCESSOR!**

SM SOFTWARE (UK)

(0453) 46065

RAGLAN HOUSE, 56 LONG STREET, DURSLEY, GLOS.

● Circle No. 133

PRACTICAL COMPUTING March 1983

What do the . . .

BBC
HONEYWELL
POST OFFICE
NATIONAL COAL BOARD
NORWEST HOLST BRITISH GAS
MINISTRY OF DEFENCE BALFOUR BEATTY
BRITISH AEROSPACE INSTITUTE OF ARCHAEOLOGY
MARCONI RESEARCH CENTRE FERRANTI
GEC TELECOMMUNICATIONS
TAYLOR WOODROW
RANK XEROX
RACAL
ESSO
. . . have in common

They all rely on the quality and versatility of **SIRTON'S British Made MIDAS Microcomputers** . . . as do hundreds of other Universities, Polytechnics, Research and Government Departments, Hospitals, Councils, and Businesses throughout the country and Europe.

sirton
computer systems

See our advertisement on page 54

Unit 14, 29 Willow Lane, Mitcham,
Surrey, CR4 4NA.
Telephone: 01-640 6931/2/3

● Circle No. 134

WORDSCAN

FOR ALL BBC MICRO OWNERS — A WORD PROCESSOR ON CASSETTE. Even for those owners who do NOT own a printer.

So far, you have used your machine to play games. Now you can get some REAL benefit, using it for WORD PROCESSING.

An extremely fast and easy to use program, professionally written to cater for any amount of TEXT from a simple letter on the Model A to an extensive essay on the Model B.

Designed to interface with the EPSON MX80 FT3, but will operate on any 'machine compatible' printer. A Bureau Service is available for PRINTING if you need it. 'Edit' your text on your TV monitor. 'Save' it on a fresh cassette when you have checked it out. Send it to me for a fast confidential PRINT service.

Your local BBC Micro Dealer has all the details. He can show you the program and documentation in operation.

Otherwise write to Dial Software, 72 Downend Road, Downend, Bristol BS16 5UE, for full details of the Package and the Bureau Service.

The price of the Package is £18+VAT.

The Printer Service is charged at min £2 per 1000 words.



FULL DETAILS AVAILABLE FROM

Crystal Research Ltd
40 Magdalene Road
Torquay T21 4AF.
Tel No: 0803-22699

DEVON

● Circle No. 178

**INTEREST
FREE
CREDIT
NOW! ON:-**

Atari, VIC 20 and Dragon

If your order contains over £120 worth of computer hardware apply now for interest free credit by telephoning: Mail-order: (0702) 552911. London Shop: 01-748 0926. Birmingham Shop: 021-356 7292. Southend Shop: 0702 554000 or write to P.O. Box 3, Rayleigh, Essex SS6 8LR.

You pay 10% down, then 10% per month for a further nine months (to nearest penny). Example: Atari 400 48K. Cash price £299. Credit terms: £29.90 down, then £29.90 per month for nine months. Total £299. Credit quotations on request. This offer subject to approval which can take up to 48 hours (APR = 0%).

THE NEW COMMODORE 64

The incredible new computer from Commodore comes with 64K RAM fitted! Plus 16 colours, hi-res graphics 320 x 200 pixels, 40 columns by 25 lines, Z80 microprocessor can be added — that means you can run CP/M software, 8 independently movable Sprites with collision detection, and a sound generator with 3 voices, 4 wave forms, envelope and filter to rival some dedicated music synthesisers. And all this at the most incredible price ever (AF56L) Only £339.00

DRAGON 32



The amazing new British computer with a full-travel standard keyboard, a 16-bit microprocessor, 32K RAM fitted (expandable to 64K and later to 256K!!), 9 colours, hi-res graphics and Microsoft extended colour BASIC (the very best BASIC to learn with). It can be used with virtually any ordinary cassette recorder, it has a printer interface (Centronics-type), joysticks are available and it's incredible value for money.

(AF57M) Only £199.50.
Lots of new Dragon software available.

THE AMAZING ATARI COMPUTERS

4 Consoles Available:

Atari 400, 16K RAM (AF36P) £249.95
Atari 400, 48K RAM (AF37S) £299.00
Atari 800, 16K RAM (AF02C) £399.00
Atari 800, 48K RAM (AF55K) £440.00

***All above with BASIC & handbooks**
Carriage free, delivery next day
by Datapost

Other hardware:

Cassette Recorder	(AF28F)	£50.00
Disk Drive	(AF06G)	£299.95
Thermal Printer	(AF04E)	£265.00
Epson MX80T Mk III	(AF38R)	£399.95
Epson MX80F/T Mk III	(AF40T)	£447.35
Printer Interface for 400	(AF41U)	£59.95
Printer Interface for 800	(AF42V)	£59.95
Interface Module	(AF29G)	£135.00
Versawriter	(AF43W)	£199.95
16K RAM Module	(AF08J)	£55.00
48K RAM Module for 400	(AF44X)	£99.95
48K Upgrade for 400	(AF45Y)	£75.00
Floppy Disk	(YX87U)	£2.50
Le Stick	(AC45Y)	£24.95
Joystick Controllers (Pair)	(AC37S)	£13.95
Paddle Controllers (Pair)	(AC30H)	£13.95

For full details ask for our hardware leaflet (XH54J) SAE appreciated

JOIN THE U.K. ATARI COMPUTER OWNERS' CLUB

An independent users' group. Four issues of the club magazine for only £3.00! Address your subscription to Ron. Issue 1 of the club magazine featured a tutorial on character set redefinition and contained a collection of demonstration games programs and lots more. Issue 2 featured a tutorial on player/missile graphics, an article about graphics on computer selection of members' contributions to the program library and much more.



THE FINEST SELECTION OF ATARI SOFTWARE

Teach Yourself Programs

Conversational French	-5C-16K-YG44X	£39.95
Conversational German	-5C-16K-YG45Y	£39.95
Conversational Spanish	-5C-16K-YG46A	£39.95
Conversational Italian	-5C-16K-YG47B	£39.95
Touch Typing	-2C-16K-YG49D	£19.95
States & Capitals	-1C-16K-YG56L	£14.95
Euro Countries & Capitals	-1C-16K-YG57M	£14.95
Kids 1 (3 Programs)	-1C-16K-BG00A	£11.75
Kids 2 (3 Programs)	-1C-16K-BG00A	£11.75
My First Alphabet	-1D-32K-KB23A	£29.95

Learn Programming

Invitation To Programming 1	-1C-8K-YG43W	£19.95
Invitation To Programming 2	-2C-8K-BG067X	£22.95
Invitation To Programming 3	-2C-8K-BG068Y	£22.95
Basics of Animation	-1C-16K-BQ57M	£14.50
Player Missile Graphics	-1C-32K-BQ59P	£21.25
Display Lists	-1C-16K-BQ51F	£14.50
Horz/Vertical Scrolling	-1C-16K-BQ53H	£14.50
Page Flipping	-1C-16K-BQ55K	£14.50
Sounds & Music	-1C-16K-BG04E	£14.50
Tricky Tutorials First 6	-3C-32K-BG06G	£69.95
Page 6	-1D-24K-KB24B	£27.50

Business Programs

Visicalc	-1D-32K-VL39N	£119.95
----------	---------------	---------

Atari Word Processor

Text Wizard	-1D-32K-BQ99H	£75.00
Mini Word Processor	-1C-32K-BG08J	£14.50
File-It 2	-1D-48K-BG10L	£33.87
Filemanager 800	-1D-40K-BG59P	£75.00
Graph-It	-2C-16K-YG51F	£14.95
Statistics	-1C-16K-YG52G	£14.95
Mortgage & Loan Analysis	-1C-16K-BQ66W	£14.95
Bob's Business	-1C-32K-BG11M	£10.59

Adventure Games

Galactic Empire	-1C-32K-BQ14Q	£14.50
Galactic Trader	-1C-32K-KB25C	£14.50
Galaxy	-1C-16K-BG75S	£14.95
Rescue At Rigel	-1C-32K-BQ21X	£20.75
Datstones of Ryn	-1C-32K-BQ22Y	£13.80
Star Warrior	-1C-32K-BQ24B	£27.45
Voyager I	-1C-32K-BQ95D	£14.95
Invasion Orion	-1C-24K-BQ23A	£17.25
GFS Sorceress	-1C-48K-KB26D	£21.95
Planet Miners	-1C-24K-BG89W	£11.95
Star Flight	-1D-40K-BG26D	£14.95
Journey To The Planets	-1C-32K-KB28F	£20.45
Crush, Crumble & Chomp	-1C-32K-BQ83E	£20.75
Mission Asteroid	-1D-40K-BQ91Y	£17.19
Wizard & The Princess	-1D-40K-BQ25C	£21.79
Ulysses & Golden Fleece	-2D-40K-BQ92A	£20.64

Dr Goodcode's Cavern

Escape From Vulcan's Isle	-1D-48K-KB04E	£21.95
Zork I	-1D-40K-KB30H	£20.75
Zork II	-1D-32K-BQ94C	£29.95
Zork III	-1D-32K-BQ95D	£29.95
Zork III	-1D-32K-KB31J	£29.95
Ali Baba & The 40 Thieves	-1D-32K-BQ78K	£25.93
Temple Of Apshei (Part 1)	-1C-32K-BQ85G	£27.45
Upper Reaches (Part 2)	-1C-32K-BQ87U	£13.80
Curse Of Ra (Part 3)	-1C-32K-BQ89W	£13.80
Dragon's Eye	-1D-40K-KB32K	£20.75
Crypt Of The Undead	-1D-40K-KB33L	£20.75
Empire Of The Overmind	-1C-40K-BQ73Q	£21.95
King Arthur's Heir	-1D-40K-KB34M	£20.75
Lords Of Karma	-1D-40K-BG79L	£14.95
Nightmare	-1D-40K-KB35Q	£20.75
Analog Adventure	-1D-32K-BQ33L	£16.95
Adventure Land	-1C-24K-BQ00A	£17.95
Pirate Adventure	-1C-24K-BQ01B	£17.95
Mission Impossible	-1C-24K-BQ02C	£17.95
Voodoo Castle	-1C-24K-BQ03D	£17.95
The Count	-1C-24K-BQ04E	£17.95
Strange Odyssey	-1C-24K-BQ05F	£17.95
Mystery Fun House	-1C-24K-BQ06G	£17.95
Pyramid Of Doom	-1C-24K-BQ07H	£17.95
Ghost Town	-1C-24K-BQ08J	£17.95
Savage Island I	-1C-24K-BQ09K	£17.95
Savage Island II	-1C-24K-BQ10L	£17.95

Golden Voyage

Treasure Quest	-1C-16K-KB36P	£10
Softporn Adventure	-1D-40K-KB36T	£20
Deadline	-2D-32K-BQ96E	£37
Starcross	-1D-32K-KB37S	£29
Energy Czar	-1C-16K-YG53H	£14
Kingdom	-1C-8K-YG55K	£14
Space Shuttle Module I	-1D-32K-BG65V	£18

War Games

The Shattered Alliance	-1D-48K-BQ98G	£28
Legionnaire	-1C-16K-KB00A	£25
The Battle Of Shiloh	-1C-40K-BG63T	£28
Dnieper River Line	-1C-48K-BG71N	£18
Tanktics	-1C-24K-BQ93B	£17
With Atlantic Convoy Raider	-1C-16K-BG83E	£11
Midway Campaign	-1C-32K-BG81C	£11
Battle For Normandy	-1C-32K-KB38R	£28
Tigers In The Snow	-1C-40K-KB01B	£28
War	-1D-32K-KB40T	£17
B1 Nuclear Bomber	-1C-16K-BG68Y	£11
Nukewar	-1C-16K-BG87U	£11
Conflict 2500	-1C-32K-BG85G	£11
Cytron Masters	-1C-32K-KB41U	£28

Arcade Games

Star Raiders	-1E-8K-YG66W	£29
Choplifter	-1D-48K-KB12N	£27

SOFTWARE FOR CP/M COMPUTERS

Retailer and OEM terms available

Software & Manual	Manual Only	Software & Manual	Manual Only	Software & Manual	Manual Only
ANTHONY ASHPITEL TYPING MASTERS					
BASIC VERSION	50				
BUSINESS VERSION	125	25			
BYROM SOFTWARE					
BSTAM—Utility to link one micro-computer to another also using BSTAM	112	7			
BSTMS—Utility to link a micro to a mini or mainframe	112	13			
CP/M USER LIBRARY					
51 Volumes—Price per volume	5				
8" disc (one volume per disc)	10				
5" disc (one volume per 2 discs)			2		
Index					
DIGITAL RESEARCH					
BT-80	165	24			
CBASIC v 2.08	76	16			
CB-80 1.3	312	21			
CP/M86	171	32			
CP/M 2.2	103	24			
CP/NET	126	16			
DESPOOL	31	7			
MAC	62	16			
MP/M 1.1	138	21			
MP/M 2.0	288	35			
PASCAL MT	206	24			
PASCAL MT WITH SPP	297	35			
PASCAL MT LIB SOURCES	129				
PASCAL MT SPP ONLY	147	12			
PL/1-80	315	32			
SID 1.4	50	16			
TEX3.0	65	16			
XLT86	94	8			
ZSID 1.4	65	16			
ELECTRONIC ACCOUNTING SERVICES					
LINEAR & GOAL PROGRAMMING	200	10			
FOX & GELLER					
QUICKSCREEN FOR DBASE-II	103	14			
QUICKSCREEN FOR CBASIC/CB-80	103	14			
QUICKSCREEN FOR MBASIC	103	14			
QUICKCODE FOR DBASE-II	182	21			
GRAM BUSINESS SYSTEMS LTD.					
DISKREV	65	13			
DISKLENE	40	6			
DISKORG	50	6			
DISKED-2	65	8			
DISKTOOLS-1 (DISKREV & DISKORG)	90	15			
DISKTOOLS-2 (DISKTOOLS-1 & DISKED-2)	145	19			
INFORMATION UNLIMITED					
WHATSIT (Database Management System)	80				
KLH SYSTEMS					
Spooler for CPM systems v3.0	82	7			
MAGIC CIRCLE SOFTWARE					
CPM SIM	141				
MICRO-AP					
SELECTOR-V 1.6	324	29			
MPI LTD.					
FORTH	85	23			
PAYROLL	500	15			
SALES LEDGER	200	15			
PURCHASE LEDGER	200	15			
NOMINAL LEDGER	200	15			
INCOMPLETE RECORDS	1200	20			
MATHSPACK	120				
STATSPACK	120				
MICROFOCUS					
CIS COBOL v 4.5	425	25			
FORMS 2	110	10			
ANIMATOR	225	25			
FILESHARE	250	20			
MICROLOGY					
FTNUMB (FORTRAN-80 RENUMBER & REFORMATTER)	50				
MICROPRO INC.					
WORDSTAR 3.0	294	45			
MAIL MERGE 3.0 (requires Wordstar)	88	12			
SPELLSTAR 1.2 (requires Wordstar)	147				
WORDSTAR TRAINING MANUAL		21			
WORDSTAR CUSTOMIZATION NOTES	59				
WORD-MASTER 1.7A	88	26			
TEX-WRITER 2.6	44	20			
SUPER-SORT 1.6	147	26			
DATASORT 1.101	206	29			
DATASORT CUSTOMIZATION NOTES	59				
CALCSTAR 1.2	176	29			
APPLE VERSIONS					
WORDSTAR 3.0	221	44			
MAILMERGE 3.0 (requires Wordstar)	74	12			
SPELLSTAR 1.2 (requires Wordstar)	115				
DATASORT 1.101	174	29			
SUPER-SORT 1.6	118	26			
CALCSTAR 1.2	115	29			
MICROTECH EXPORTS					
REFORMATTER CPM→IBM	147	20			
REFORMATTER CPM→DEC	147	20			
MICROSOFT INC.					
BASIC-80 5.21	218				
BASIC Compiler 5.3	241				
FORTAN-80 3.44	306				
COBOL-80 4.60	447				
M/SORT 1.012	88				
EDIT-80 2.02	76				
MACRO-80 3.43	124				
MULISP 2.12	124				
MUMATH 2.12	153				
OSBORNE & ASSOCIATES					
ACCOUNTS PAYABLE & ACCOUNTS RECEIVABLE	50	15			
GENERAL LEDGER	50	15			
PHOENIX SOFTWARE ASSOCIATES					
PLINK—Disc to disc link loader	85	18			
PASM—Macro Assembler	85	18			
PEDIT—Line editor with Macros	85	18			
BUG—Very powerful debug	85	18			
DEVELOP Package with all the above	227	39			
PLINK—2 Overlay Link Loader	218	18			
SAPPHIRE SYSTEMS LTD.					
MARS	295	25			
STRUCTURED SYSTEMS (All converted to UK Standard)					
SALES LEDGER	350	20			
PURCHASE LEDGER	350	20			
NOMINAL LEDGER	350	20			
STOCK CONTROL	350	20			
LETTERRIGHT	112	13			
ANALYST (File management Reporting System)	147	13			
NAD (Name and Address selection system)	65	13			
QSORT	65	13			
SUPERSOFT INC.					
DIAGNOSTICS 1	53	11			
TERM	85	8			
SYNTAX SOFTWARE LTD.					
CP/M TUTOR	55				
TDL SOFTWARE (Technical Design Labs)					
BUSINESS BASIC	80				
ZTEL (Text Editing Lang.)	35				
LINKER	35				

Full descriptive Catalogue available

ORDER INFORMATION

When ordering CP/M software please specify the format you require. All software items are subject to VAT. Manuals, when purchased separately, are not subject to VAT. Please add £3.75 (plus VAT) for postage and packing for the first item purchased, and then £1.00 for each extra item. For overseas please add £6.50 per item and then £1.50 for each extra item required. Most software in this advertisement is available from stock and a 72 hour return service is thereby offered on most prepaid orders. These details and prices are all current as of November 1982. Our prices reflect an exchange rate of U.S. \$1.7 to £1.00. (Telephone at time of purchase to confirm latest prices.) All payments must be in Sterling and drawn against a U.K. bank.

MAIL ORDER - TELEPHONE ORDER - VISIT - Send Cash, Cheque, Postal Order, I.M.O. Access or Barclaycard/Visa number to Microcomputer Products International Ltd., Room PC, 11 Cambridge House, Cambridge Road, Barking, Essex IG11 8NT.

*** ATTENTION ALL TORCH USERS! ALL OUR SOFTWARE IS AVAILABLE IN TORCH FORMAT ***



The Disk Edit 11 (DISKEDIT 11)

This is a powerful tool, allowing modification of any byte in any sector on the disk surface. It has many uses ranging from being able to examine and restore erased files to edit corrupted files or directory entries.

Disktools are a family of sophisticated programs designed to support CP/M based systems. The family consists of the Disk Reviver (DISKREV) - A simple to use program for recovering erased or corrupted files from disk - anyone who has had files erased or made unrecoverable by system failures will know how useful DISKREV can be.

The Disk Organiser (DISKORG)

This reorganises the files on a disk to present the most efficient usage of disk space. A detailed manual is supplied with this.

The DISKLENE

This examines all of the disk surface and assigns the bad areas to a special file. Any user who has had to discard potentially usable disk because of media surface faults will appreciate the savings this can make.

MEDIA AND FORMATS

Altos	Cromemco System 2 DD/SS	RX	IMSAI VDP-80	A1	Nascom/Lucas	N1	SD Systems 5.25in	R3
APPLE CP/M-80 13 Sector	CSSN Backup	T1	Industrial Microsystems 5000	RA	NCR 8140/9010	A1	SD Systems 8in	A1
APPLE CP/M-80 16 Sector	Cyber 8"	A1	Industrial Microsystems 8000	A1	NNC-80	A1	Sharp MZ-80B	R9
Blackhawk Micropolis Mod II	Datapoint 1550/2150	A1	Intel MDS SD	A1	NNC-80W	A1	Sharp PC-3201	R8
British Microm Mimi	Dec VT 180 SSDD	RV	Intertec Superbrain SSDD	RK	North Star Advantage	P2	Shelton Signet	RK
California Computer Sys 8 in	RG Delta Systems	A1	Intertec Superbrain QD	RS	North Star Horizon SSSD	P1	Spacebyte	A1
CDS Versatile 4	RR Dynabyte DB8/4	A1	ISC Intercoler 8063/8360/8963	A1	North Star Horizon SSDD	P2	Tarbelle 8in	A1
Columbia Data Products 8 in	Q2 Exidy Sorcerer - CP/M-80	Q2	ITT 3030 DSDD	R1	North Star Horizon QD (MPI CP/M)	P3	TEI 8in	A1
Comart Communicator CP50	RK Exidy Sorcerer - Exidy CP/M-80 8"	A1	Micromation	A1	North Star Horizon QD	QD	Televideo DSDD	S5
Comart Communicator CP100	A1 EXO	A1	Micropolis Mod II	Q2	(Other CP/M)	P2	Torch	N2
Comart Communicator CP200	Q2 Gemini Galaxy I	N1	Morrow Discus	A1	Nylac Micropolis Mod II	Q2	Toshiba T200 DSDD	SF
Comart Communicator CP500	A1 H4th H8 - H47	A1	Mostek	A1	Osborne-I	RP	TRS-80 Modell - Shuffle-board 8in	A1
Compal-80	P2 Hewlett-Packard 125.8in	A1	Multi-Tech 1	Q2	Pertec PCC 2000	A1	TRS-80 Modell II	A1
CPT 8000	P2 IBM PC-DOS SSDD	C1	Multi-Tech 2	Q2	Rade 1000 SSDD	RL	Vector MZ	Q2
Cromemco System 3	P2 IBM PC-DOS DSDD	C2	Micromation	A1	Rade 1000 DSDD	RM	Vector Systems 2800	A1
Cromemco System 2 SD/SS	P2 IBM CP/M-86 SSDD	C3	Micropolis Mod II	Q2	Rair Black Box	RE	Vector Systems B	Q2
	Q2 IBM CP/M-86 DSDD	C4	Morrow Discus	A1	Research Machines 5.25in	RN	Vector Systems B	Q2
	A1 ICL-PC	RE	Mostek	A1	Research Machines 8in	A1	Vector VIP	Q2
	A1 ICL DRX Series	A1	Nascom (Gemini Drives SSDD)	R3	Robotron 5"	N3	Xerox 820 5.25in	S6
	R6 ICOM 3712	A1	Nascom (Gemini Drives DSDD)	R7	Robotron 8"	A1	Xerox 820 8in	A1

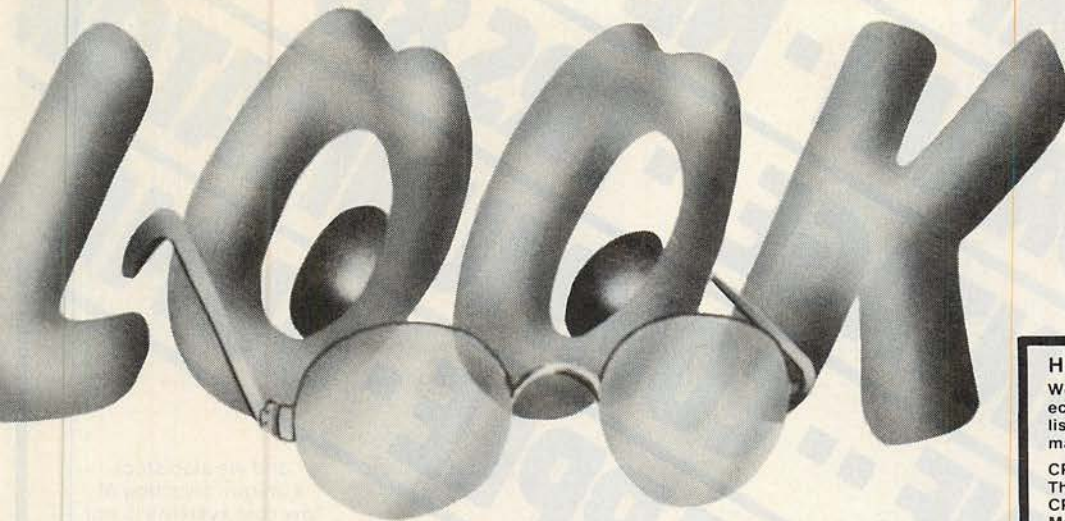

HELPFUL BOOKS:

We have a wide range of books, selected to support our comprehensive list of software. Four books which may interest you are:

- CP/M User Guide £11.10
- The CP/M Handbook with MP/M £12.10
- CP/M Primer £10.95
- Mastering CP/M £12.95

IT'S NEW!

We are constantly adding to the wide range of packages, and are pleased to advise you of these ones below. Please don't hesitate to give us a ring for any further information. Flysheets and current prices are available on request.

- | | |
|---|---|
| <p>ADDRESS BOOK - Mailing list management. Flexible and powerful sorting on up to 10,000 addresses in each datafile</p> <p>ALL-STAR DATA PACK - Comprises of DATASTAR, Supersort and Calcstar, at a 20% discount when purchased as this special pack</p> <p>ALL-STAR WORD PACK - Comprises of WORDSTAR, Mailmerge and Spellstar at a 20% discount when purchased as this special pack</p> <p>BISYNC/80 - Protocol emulation packages for HASP, 2780, 3270 and Async protocols. CP/M</p> <p>LEVEL 2 COBAL - Microfocus Level 2 ANSI '74 Cobol. This Cobol has been certified by the American GSA to the Federal High Level. CP/M, CP/M-86 and MP/M-86</p> <p>LEVEL 2 FORMS 2 - A screen layout generator and indexed file generator, for running with CIS COBOL LEVEL 2 (CP/M-86 and CP/M-80).</p> <p>LEVEL 2 ANIMATOR - A COBOL Visual Debugging tool for running with CIS COBOL LEVEL 2. (CP/M-86 and CP/M-80).</p> <p>CORAL 66 - Microfocus Coral 66 Compiler. CP/M</p> <p>COSTING/STOCK CONTROL - Job cost estimation with stock control</p> <p>CP/M TUTOR - Menu driven tutorial course on CP/M</p> <p>DBASE II - Database generator. Powerful English like language for designing and implementing relational databases. CP/M, MS-DOS and Cromix</p> <p>AUTOCODE - Automatic code generator for DBASE II</p> <p>ENGINEERING SOFTWARE - A variety of Engineering applications including:-</p> <ul style="list-style-type: none"> - Calculation of Earthwork Quantities - Design of Highways - Surveying - Stability of Slopes - Finite Elements - Plastic Analysis of Portal Frame - Design of Sheet Pile Walls - Design of Standard | <p>MICROPERT - Very powerful critical path and project management package</p> <p>MILESTONE - Pert and Critical Path Analysis package. CP/M and CP/M-86</p> <p>PARAGRAB - Grabs paragraphs from a standard library for insertion in documents. Works with all well known CP/M Word processing packages including Wordstar</p> <p>PERSONAL PEARL - Database generator. CP/M</p> <p>PEARL-3 - CBASIC code generator. Application generator for CBASIC. Menu led generation of business applications. CP/M</p> <p>PMATE - Word processing package with text buffers and a 'garbage' stack</p> <p>POLICY MASTER - Insurance Broker package. Covers client accounts and policy renewals</p> <p>PRINT ESTIMATING - All aspects of estimating the cost of printing a specific job. Menu lead</p> <p>PROPERTY MANAGEMENT - Comprehensive system covering all aspects of property management</p> <p>PROPERTY MATCHING - Estate Agents system matching property against demand. Commercial and Domestic versions available</p> <p>RESCUE - Database, menu lead. Very powerful Wordstar interface</p> <p>TYPING MASTER - BASIC version and BUSINESS version, can now run under CP/M-86</p> <p>WORDSTAR - A version is now available for running on the IBM PC-DOS. Mailmerge and Spellstar have also been developed for this</p> |
|---|---|

MAIL ORDER
TELEPHONE
CREDIT CARD ORDER
* VISIT *

Trade Enquiries Welcome

**- HP - HP -
 NEWBRAIN - NEWBRAIN -
 ADVANTAGE - TRS80 -
 OSBORNE - COMMUNICATOR
 SIRIUS - APPLE - QUME**

and we also stock
 a unique selection of
 low cost systems in our
 'budget micro' department



Cambridge Computer Store

1 Emmanuel Street
 Cambridge CB1 1NE
 Telephone (0223) 65334/5
 (closed 12.30 - 1.15 except Saturday)

● Circle No. 137



FULL DETAILS AVAILABLE FROM

EWL Computers Ltd
8 Royal Crescent
Glasgow G3
Tel No: 041-332 7642

LANARKSHIRE

● Circle No. 138

KNIGHTS GUARANTEE LOWEST PRICES ON SHARP AND ATARI

Deal S1 — SHARP 54K MZ-80A with BASIC + 24 programs including Geography, Arithmetic, Basic Tutorials, Startrek, Invaders, Breakout etc. **£419**

DEAL S2 — MZ-80A, BASIC, PASCAL language and 36 programs including all those in deal S1 + 12 PASCAL programs. **£429**

DEAL S4 — MZ-80A with BASIC, PASCAL, FORTH and MACHINE CODE languages + 40 programs. **£449**

DEAL A1 — MZ-80A with BASIC, PASCAL, FORTH, MACHINE CODE and 120 programs to get you off to a flying start. **£475**

DEAL B1 — MZ-80B, the 76K powerhouse with 64,000 point graphics, with BASIC, MACHINE CODE. **£747**

Deal B11 — MZ-80B system, printer, floppy disk, expansion unit, all cables, cards and manuals. **£1899**

DEAL 400 — ATARI 400 with BASIC, manuals etc — choose from 16 colours and eight brightness levels, 300x192 definition. + 63 Programs. **£199**

DEAL 800 — ATARI 800 with BASIC cartridge, four voice sound, superb ultra fast moving graphics with ATARI's dual processor system. + 63 programs. **£429**

DEAL AT3 — ATARI DISK UNIT — plugs straight into the 400 or 800 — great value at KNIGHTS GUARANTEED LOWEST PRICES. **£257**

All our prices exclude VAT but include UK delivery by Securicor. No surcharge on ACCESS or VISA orders.

108 ROSEMOUNT PLACE, ABERDEEN AB24YW
TELEPHONE: 0224 630526

Knights T.V. & COMPUTERS

● Circle No. 139

TTL'S		74LS SERIES		74ALS SERIES	
74LS85	40p	74LS197	45p	74LS645	100p
74LS86	16p	74LS221	16p	74LS668	100p
74LS89	18p	74LS240	22p	74LS669	100p
74LS92	22p	74LS241	55p	74LS670	120p
74LS93	18p	74LS242	55p	74LS682	300p
74LS94	22p	74LS243	55p	74LS684	400p
74LS96	50p	74LS244	55p		
74LS97	50p	74LS245	70p	74LS SERIES	
74LS107	20p	74LS246	70p	74LS00	30p
74LS109	27p	74LS251	70p	74LS01	30p
74LS112	20p	74LS253	30p	74LS02	30p
74LS113	20p	74LS257	30p	74LS03	30p
74LS114	20p	74LS258	55p	74LS04	30p
74LS123	22p	74LS259	55p	74LS05	30p
74LS124	22p	74LS260	22p	74LS06	30p
74LS125	24p	74LS266	20p	74LS07	30p
74LS126	24p	74LS273	55p	74LS08	60p
74LS127	24p	74LS279	30p	74LS09	60p
74LS132	24p	74LS280	100p	74LS10	60p
74LS133	24p	74LS281	70p	74LS11	60p
74LS136	27p	74LS293	90p	74LS12	60p
74LS138	27p	74LS295	90p	74LS13	60p
74LS139	27p	74LS298	90p	74LS14	60p
74LS145	100p	74LS299	180p	74LS15	60p
74LS147	100p	74LS324	180p	74LS16	60p
74LS151	133p	74LS325	60p	74LS17	60p
74LS152	133p	74LS353	60p	74LS18	60p
74LS154	80p	74LS355	60p	74LS19	60p
74LS155	80p	74LS356	250p	74LS20	60p
74LS156	36p	74LS357	110p	74LS21	60p
74LS157	25p	74LS363	140p	74LS22	60p
74LS160	36p	74LS365	30p	74LS23	60p
74LS162	36p	74LS368	30p	74LS24	60p
74LS163	36p	74LS373	55p	74LS25	60p
74LS164	40p	74LS374	55p	74LS26	60p
74LS165	40p	74LS375	70p	74LS27	60p
74LS166	60p	74LS377	70p	74LS28	60p
74LS170	70p	74LS378	70p	74LS29	60p
74LS173	55p	74LS379	45p	74LS30	60p
74LS174	40p	74LS395	90p	74LS31	60p
74LS175	40p	74LS399	100p	74LS32	60p
74LS181	90p	74LS424	100p	74LS33	60p
74LS182	120p	74LS440	80p	74LS34	60p
74LS183	36p	74LS441	80p	74LS35	60p
74LS184	36p	74LS442	100p	74LS36	60p
74LS192	36p	74LS443	100p	74LS37	60p
74LS193	36p	74LS444	100p	74LS38	60p
74LS194	36p	74LS445	100p	74LS39	60p
74LS195	36p	74LS446	100p	74LS40	60p
74LS196	45p	74LS447	100p	74LS41	60p
74LS197	45p	74LS448	100p	74LS42	60p

VOLTAGE REGULATORS		OTHER REGULATORS	
FIXED PLASTIC			
1A	+ve	LM309K	140p
1V	-ve	LM317K	325p
2V	7805	LM371K	450p
5V	7812	79GUIC	225p
15V	7815	79HGUIC	225p
18V	7818	79HGKC	700p
24V	7824	LM723N	300p
5V 100mA	78L05	ICL7660	200p
12V 100mA	78L12	TL494	300p
15V 100mA	78L15	TL497	300p
78L12	30p	LM305AH	250p
78L15	30p	78HGKC	600p
78L12	50p		
78L15	50p		

BBC

MICRO COMPUTER

OFFICIAL DEALER

BBC Model B £399incl VAT Carr £8
 Model A to Model B upgrade kit £50
 Fitting charge £15
 Partial Upgrades also available

BBC FLOPPY DISC DRIVES

Installation: £20
 5 1/4" 100K £235 + £6 carr
 5 1/4" 800K £799 + £6 carr

BBC COMPATIBLE DRIVES

These are drives with TEAC FD50 mechanism and are complete with power supply.

SINGLE: 100K £190 200K £260 400K £340
 DUAL: 200K £360 400K £490 800K £610
 ACORN WORD PROCESSOR 'VIEW' £52
 SECOND PROCESSOR 6502 £170
 SECOND PROCESSOR Z80 £170
 TELETEXT ADAPTOR £195
 PRESTEL ADAPTOR £90

Full Range of Connectors in Stock

SOFTY II INTELLIGENT PROGRAMMER

The system micro processor development system for Engineers and Hobbyists. You can develop programs, debug, verify and commit to EPROMS or use in host computer by using softy as a romulator. Powerful editing facilities permit bytes, blocks of bytes changed, deleted or inserted and memory contents can be observed on ordinary TV. Accepts most +5v Eproms. Softy II complete with PSU, TV Lead and Romulator lead £169.

TECHNOMATIC LTD

MAIL ORDERS TO: 17 BURNLEY ROAD, LONDON NW10 1H-D
 SHOPS AT: 17 BURNLEY ROAD, LONDON NW10
 (Tel: 01-452 1500, 01-450 6597, Telex: 92280M)
 305 FIDGWARE ROAD, LONDON W2

COMPUTER COMPONENTS

MEMORIES		KEYBOARDS		ENCODER		CHARACTER GENERATOR		DISC CONTROL		TELETEXT		DECODER IC'S		TEXT TOOL		ZIF SOCKETS	
COM816	£8	2101A	400p	DS8831	140p	FC14411	£5	FD1771	£20	AY 8276	700p	SAAS020	600p	24 pin	600p	1 8432MHz	210p
DAC801	£28	2101L	120p	DS8832	225p	FC14418	£4	FD1791	£22	AY 8277	800p	SAAS030	£9	28 pin	800p	2.0MHz	£25p
DR304	275p	2101H	300p	DS8833	225p	FC14419	£5	FD1795	£28	AY 8278	800p	SAAS041	£9	40 pin	800p		
DS8831	140p	2101Z	100p	DS8834	225p	FC14420	£5	FD1797	£28	AY 8279	800p	SAAS050	£9	40 pin	800p		
DS8832	225p	2101L2	100p	DS8835	225p	FC14421	£5	FD1799	£28	AY 8280	800p						
DS8833	225p	2101Z2	100p	DS8836	225p	FC14422	£5	FD1799	£28	AY 8281	800p						
DS8834	225p	2101ZL	100p	DS8837	225p	FC14423	£5	FD1799	£28	AY 8282	800p						
DS8835	225p	2101ZL2	100p	DS8838	225p	FC14424	£5	FD1799	£28	AY 8283	800p						
DS8836	225p	4017	450p	DS8839	225p	FC14425	£5	FD1799	£28	AY 8284	800p						
DS8837	225p	4017.1	450p	DS8840	225p	FC14426	£5	FD1799	£28	AY 8285	800p						
DS8838	225p	4017.2	450p	DS8841	225p	FC14427	£5	FD1799	£28	AY 8286	800p						
DS8839	225p	4017.3	450p	DS8842	225p	FC14428	£5	FD1799	£28	AY 8287	800p						
DS8840	225p	4017.4	450p	DS8843	225p	FC14429	£5	FD1799	£28	AY 8288	800p						
DS8841	225p	4017.5	450p	DS8844	225p	FC14430	£5	FD1799	£28	AY 8289	800p						
DS8842	225p	4017.6	450p	DS8845	225p	FC14431	£5	FD1799	£28	AY 8290	800p						
DS8843	225p	4017.7	450p	DS8846	225p	FC14432	£5	FD1799	£28	AY 8291	800p						
DS8844	225p	4017.8	450p	DS8847	225p	FC14433	£5	FD1799	£28	AY 8292	800p						
DS8845	225p	4017.9	450p	DS8848	225p	FC14434	£5	FD1799	£28	AY 8293	800p						
DS8846	225p	4017.10	450p	DS8849	225p	FC14435	£5	FD1799	£28	AY 8294	800p						
DS8847	225p	4017.11	450p	DS8850	225p	FC14436	£5	FD1799	£28	AY 8295	800p						
DS8848	225p	4017.12	450p	DS8851	225p	FC14437	£5	FD1799	£28	AY 8296	800p						
DS8849	225p	4017.13	450p	DS8852	225p	FC14438	£5	FD1799	£28	AY 8297	800p						
DS8850	225p	4017.14	450p	DS8853	225p	FC14439	£5	FD1799	£28	AY 8298	800p						
DS8851	225p	4017.15	450p	DS8854	225p	FC14440	£5	FD1799	£28	AY 8299	800p						
DS8852	225p	4017.16	450p	DS8855	225p	FC14441	£5	FD1799	£28	AY 8300	800p						
DS8853	225p	4017.17	450p	DS8856	225p	FC14442	£5	FD1799	£28	AY 8301	800p						
DS8854	225p	4017.18	450p	DS8857	225p	FC14443	£5	FD1799	£28	AY 8302	800p						
DS8855	225p	4017.19	450p	DS8858	225p	FC14444	£5	FD1799	£28	AY 8303	800p						
DS8856	225p	4017.20	450p	DS8859	225p	FC14445	£5	FD1799	£28	AY 8304	800p						
DS8857	225p	4017.21	450p	DS8860	225p	FC14446	£5	FD1799	£28	AY 8305	800p						
DS8858	225p	4017.22	450p	DS8861	225p	FC14447	£5	FD1799	£28	AY 8306	800p						
DS8859	225p	4017.23	450p	DS8862	225p	FC14448	£5	FD1799	£28	AY 8307	800p						
DS8860	225p	4017.24	450p	DS8863	225p	FC14449	£5	FD1799	£28	AY 8308	800p						
DS8861	225p	4017.25	450p	DS8864	225p	FC14450	£5	FD1799	£28	AY 8309	800p						
DS8862	225p	4017.26	450p	DS8865	225p	FC14451	£5	FD1799	£28	AY 8310	800p						
DS8863	225p	4017.27	450p	DS8866	225p	FC14452	£5	FD1799	£28	AY 8311	800p						
DS8864	225p	4017.28	450p	DS8867	225p	FC14453	£5	FD1799	£28	AY 8312	800p						
DS8865	225p	4017.29	450p	DS8868	225p	FC14454	£5	FD1799	£28	AY 8313	800p						
DS8866	225p	4017.30	450p	DS8869	225p	FC14455	£5	FD1799	£28	AY 8314	800p						
DS8867	225p	4017.31	450p	DS8870	225p	FC14456	£5	FD1799	£28	AY 8315	800p						
DS8868	225p	4017.32	450p	DS8871	225p	FC14457	£5	FD1799	£28	AY 8316	800p						
DS8869	225p	4017.33	450p	DS8872	225p	FC14458	£5	FD1799	£28	AY 8317	800p						
DS8870	225p	4017.34	450p	DS8873	225p	FC14459	£5	FD1799	£28	AY 8318	800p						
DS8871	225p	4017.35	450p	DS8874	225p	FC14460	£5	FD1799	£28	AY 8319	800p						
DS8872	225p	4017.36	450p	DS8875	225p	FC14461	£5	FD1799	£28	AY 8320	800p						
DS8873	225p	4017.37	450p	DS8876	225p	FC14462	£5	FD1799	£28	AY 8321	800p						
DS8874	225p	4017.38	450p	DS8877	225p	FC14463	£5	FD1799	£28	AY 8322	800p						
DS8875	225p	4017.39	450p	DS8878	225p	FC14464	£5	FD1799	£28	AY 8323	800p						
DS8876	225p	4017.40	450p	DS8879	225p	FC14465	£5	FD1799	£28	AY 8324	800p						
DS8877	225p	4017.41	450p	DS8880	225p	FC14466	£5	FD1799	£28	AY 8325	800p						
DS8878	225p	4017.42	450p	DS8881	225p	FC14467	£5	FD1799	£28	AY 8326	800p						
DS8879	225p	4017.43	450p	DS8882	225p												

Our spreadsheet system But let's start with

There was a time when you could run a business by the seat of your pants.

But the days of trusting to luck and following hunches are gone.

Today, computers, micros and more importantly business planning systems are no longer considered luxuries.

They allow you to keep one step ahead of your business, and one step ahead of the competition.

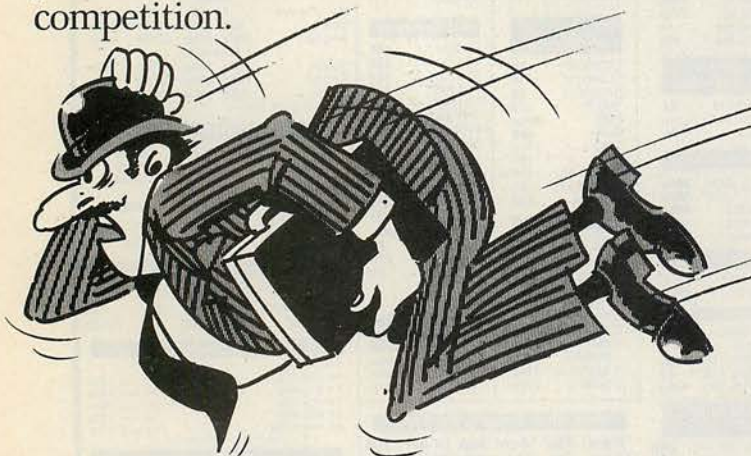

So it seems odd that most software companies still expect to solve all the problems with one system.

A "jack-of-all-trades" if you like.

Fortunately Comshare are not like most companies. We saw the need for different systems to suit different people.

NEW USERS START HERE

PlannerCalc at £39.00* is now accepted as the first choice for people new to financial planning.

Designed for 8-bit micros, it boasts the kind of features that you'd expect to pay three times as much for. (Buy PlannerCalc's nearest rival and you'll have to.)

Unlike all other 'calc' products it allows you to enter calculation in a language you understand. Plain English.

So it's much easier to use.

It uses the popular "spreadsheet" approach with a window that can be rolled in all directions.

Which means you can enter new figures and rules and immediately see their effect on everything else in the model.

It comes with the best manual on the market and it's suitable for most a TMCP/M 2.2 operating system, 64K of memory, giving at least 900 cells, minimum screen width of 80 characters and floppy disc drives.

MUCH MORE POWER, NOT MUCH MORE MONEY

MasterPlanner is the most powerful spreadsheet system currently available with its increased matrix size, 2000-3000



micros with a TMCP/M 2.2 operating system, 64K of memory, giving at least 900 cells, minimum screen width of 80 characters and floppy disc drives.

COMSHARE DEALERS

Aberdeen
Abtext Ltd
(0224) 647074

Aldershot
EMS (UK) Ltd
(0252) 313551

Alltrincham
Mercator Tech
Services Ltd
(061) 941 4225

Aylesbury
Helistar Systems Ltd
(0296) 630364

Barnsley
Brook Office Supplies Ltd
(0228) 88916

Bedford
MSC Hiland Ltd
(0234) 50260

Blackburn
BEC Systems
Services Ltd
(0254) 677215

TDS Bus Systems Ltd
(0254) 676915

Bradford
Copyright Ltd
(0274) 668890
Raven Computers Ltd
(0274) 306966

Bristol
Avon Microcentre
Systems Ltd
(0272) 277774

**Mercator Computer
Systems Ltd**
(0272) 731079
Transtec Ltd
(0272) 277462

Bury St. Edmunds
S.I.R.C.S. Ltd
(0284) 62022

Canterbury
Kent Micro Systems
(0227) 50200

Cardiff
Bowstrings Computer
Services Ltd
(0222) 36825

Clevedon
Burd Computer
Systems Ltd
(0272) 878 157

Cranbrook (UK) Ltd
The Soft Option
(058080) 310

Doncaster
Briars Computer
Centre
(0302) 67135

Dublin
Transtec Ltd
(0001) 718521

Glasgow
The Prospectus
Partnership
(0236) 211294

Gosport
Vaunberry Ltd
(0329) 235846

Harpenden
Irradon Ltd
(05827) 62421

Haslinges
BMS Computer
Services Ltd
(0424) 439190

Hereford
Honeysett Computers Ltd
(0432) 279404

Ipswich
Anglia Microsystems
(0449) 740046

Leamington Spa
Words Ltd
(0926) 30209

Leicester
Leicester Micro Centre
(0533) 551869

Lisburn
MKM Electronic Ltd
(08462) 3184, 3665

Liverpool
BEC (Liverpool) Ltd
(051) 263 5738

London
BD Computer Systems
01-435 4442

**Business Information
Systems**
01-373 3408

**Denko Computer
Systems Ltd**
01-670 4202

**Computer Aided
Systems Ltd**
01-487 3869

**Computer Aided
Systems Ltd**
01-518 1414

**DIR Computer
Systems Ltd**
01-439 4354

Equinox Computers Ltd
01-739 2387

Ferrari Software Ltd
01-751 5791

Jarrogate Ltd
01-671 6321

Ludhouse Computing Ltd
01-679 4321

**Mayfair Business
Systems Ltd**
01-688 3836

MGE Systems Ltd
01-439 9617

Micronics Telesystems Ltd
01-263 6926

P.W. Hare & Associates
01-551 1988

Salmon Electronics
01-223 1688

Software Ltd
(06074) 69117

Whispix Ltd
01-556 9151

Louth
Comput-A-Crop
(0507) 604271

Meiksham
Cider Systems Ltd
(0225) 706361

ICEN Ltd
(0225) 702133

Midhurst
Worsfold Automation Ltd
(073081) 6641

Milton Keynes
Pericom Data
Systems Ltd
(0908) 614242

Nayan
S. Triple S Ltd
(046) 28472

Nottingham
Micropeople Ltd
(06074) 69117

Oxford
Choice Business
Systems
(049161) 2697

Redcar
Applestop
(0642) 474707

Richmond
Tritech Computer Services
01-948 4213

Rutland
Microspecific Ltd
(0572) 2528

Slough
KGB Micros Ltd
(75) 38581

Southampton
Xitan Systems Ltd
(0703) 38740

St Albans
St Albans Computer
Services Ltd
(0727) 77700

St Helier
The Processor Centre
(0534) 77070

Thomas & Compas
(0534) 77700

West Byfleet
Ferguson Computer
Ltd
(91) 41810

Weston-Super-
Eastern Ltd
(0934) 418346

Winchester
Modular Office
Systems Ltd
(0962) 55759

Yeovil
Dale Computer
Systems Ltd
(0935) 72000



Plans start at £39.00. Why you need one.

cells on most 64K micros. (But at £245* it certainly isn't the most expensive.)

Consolidation of models, allows you to create separate plans for each department and then combine them into an overall company plan. Data transfer to word processing and other systems lets you incorporate figures in reports and output to a data base. It also has extensive formatting facilities which means you can produce reports that wouldn't look out of place in the board room.

It can store up to 25 standard reports to print when you need them. It's got full WHAT IF analysis and direct editing of both spreadsheet and logic display.

JUST AS EASY TO USE

All this increased power doesn't mean you'll need a degree in advanced computing to understand MasterPlanner.

It works on exactly the same system as PlannerCalc and models written on PlannerCalc run without modification on MasterPlanner.

16 BIT VERSION

A new version of MasterPlanner has been specifically designed for 16 bit micros like the Plus 1 under TMCP/M-86 or the IBM personal using either CP/M-86 or TMMS DOS 1.1. With a vast matrix size of over 100 cells on 128K and even more with larger memory, you'll at last be able to make the most of your micro.

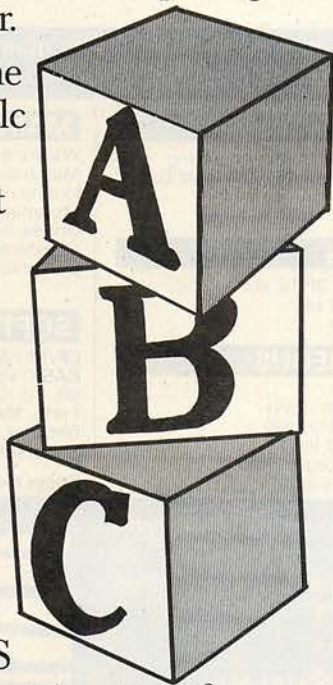

OVER 10 YEARS EXPERIENCE

When you invest in MasterPlanner or PlannerCalc you're not just getting the best software money can buy.



You're also getting the kind of back up and after-sales service that only a company of Comshare's track-record can guarantee.

If you'd like to know more about either product call in at your local dealer or fill in the coupon and send it to us.

*Plus VAT and post & package.

COMSHARE

Making the computer make sense.

CP/M and TMCP/M-86 are the registered trade marks of Digital Research Inc. Comshare Ltd., 32-34 Great Peter Street, London SW1P 2DB. Telephone: 01-222 5665.



To: Department PC3, Comshare Ltd., 32-34 Gt. Peter Street, London SW1P 2DB.

Please send me:

Qty	Product	Micro	Op System	Disc Size	K	Amount £ p.
	PlannerCalc @ £46.05 (8 bit only)		CPM 2.2	8"/5¼"		
	MasterPlanner @ £282.95		CPM 2.2	8"/5¼"		
	MasterPlanner	IBM PC	MS DOS 1.1	8"/5¼"		
	MasterPlanner		CPM/86	8"/5¼"		
All prices include VAT and postage & packing						TOTAL

I enclose a cheque/postal order for £_____ made payable to Comshare Ltd.

Please debit my Access Card No. _____ for £_____

  Barclaycard No. _____ for £_____

Signature _____

Name _____

Address _____

Tel. No. _____

Please allow 28 days for delivery. VAT No. 238418649. Registered No. 980406.

MIDAS S100 SYSTEMS

MIDAS 1: From £895

MIDAS 2: From £1,890

MIDAS 3D: From £3100

MIDAS 3HD: From £5,495

MIDAS 86 — 16 Bit: From £3520

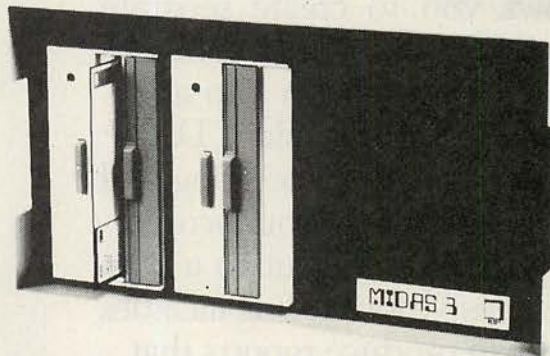

- Our versatile **Z80** Microcomputers are available as standard units or custom configured to your exact specification from a comprehensive range of stocked **S100** boards.
- Disc storage capacity of the **MIDAS 3** can be 2M Bytes, expandable to over 80M Bytes with a Winchester Hard Disc Unit in our **MIDAS 3HD** range.
- **MIDAS** runs **CP/M** and **MP/M**. Other Software includes **M-BASIC**, **C-BASIC**, **FORTRAN**, **COBOL**, **CIS-COBOL**, **PASCAL** and Word Processing.
- A **MIDAS 3D** with 64K RAM and 2M Bytes storage on two 8" drives with two Serial I/O Ports and **CP/M** only **£3,100**.
- Printers, VDUs and other peripherals stocked to give complete package system at keen prices.

BOARDS We stock over 50 different S100 Boards all from quality manufacturers: Advanced Micro Digital, Godbout, SSM, Micromation, Dual, CCS, S.D. Systems, Morrow, Pickles & Trout, etc.

PROCESSOR

Z80 Starter Kit
Single Board Computers
8085/8088 CPU
Z80A CPU 4MHz (4 types)
8086

EPROM

2716 EPROM (2x16K)
2708/2716/2732 Programmer

VIDEO BOARDS

24x80 I/O Drive
24x80 Memory Mapped

DISK CONTROLLERS

Single Density 5" or 8"
Double Density DMA
Floppy or hard Controllers

RAM

Static RAM 16-64K 24 Bit addressing
Static RAM 8x64K or 16x32K RAM/Battery
Back-up
Memory Manager

I/O BOARDS

2S/2P or 4S/2P or 3P/1S etc
A/D & D/A 8 or 12 bit
IEEE 488 Interface

MISCELLANEOUS

Real Time Clocks
Graphics 512 x256 (B/W)
Colour Graphics 312x290
Maths Board AMD 9511
Extender Boards/Logic Probe
Motherboards 7-20 slot

MAINFRAMES

We are the sole UK Distributor for Integrand Mainframes and Disc Enclosures, available in nine models including Desk Top and Rack Mounting, with or without provision for Disc Drives. All units totally enclosed, painted on all external surfaces and complete with power supply etc.

SOFTWARE

CP/M 1 & 2, MP/M, PL/1, C-BASIC 2, M-BASIC V5, XYBASIC, FORTRAN 80, COBOL 80, CIS-COBOL, PRO-PASCAL, Forth, MAC, ZSID, Disassembler, Wordstar, Datastar, Supercalc, Wordmaster, Supersoft etc etc.

Prices exclusive of VAT

We are pleased to discuss your requirements and will advise you as to whether your needs can be met with one of our computers.

All of our systems are specials as they are configured to suit your specification, thus ensuring that you get what you want rather than what happens to be available.

Write or phone for a catalogue.

Unit 14, 29 Willow Lane, Mitcham, Surrey
Telephone: 01-640 6931/2/3

PRINTER BONANZA!

EPSON PRINTERS AT UNBEATABLE PRICES



MX80 FT III £305 + VAT
 MX82 FT III £315 + VAT
 MX100 FT III £415 + VAT

Interfaces to any machine supplied—please ask for price



All printers carry a 1 Year Guarantee and come with paper. Shipment is by Securicor to your door—Please add £7 + VAT carriage.

Payment by Cheque, Access, Visa etc.

IMMEDIATE DELIVERY.

Shipments throughout UK by Securicor. We can export to most countries in the world.

Micro-Spares

We cannot and will not be beaten on Price!

104/106 Hanover St, Edinburgh EH2 1DR. 031-226 3345

● Circle No. 130

A dream of a computer—

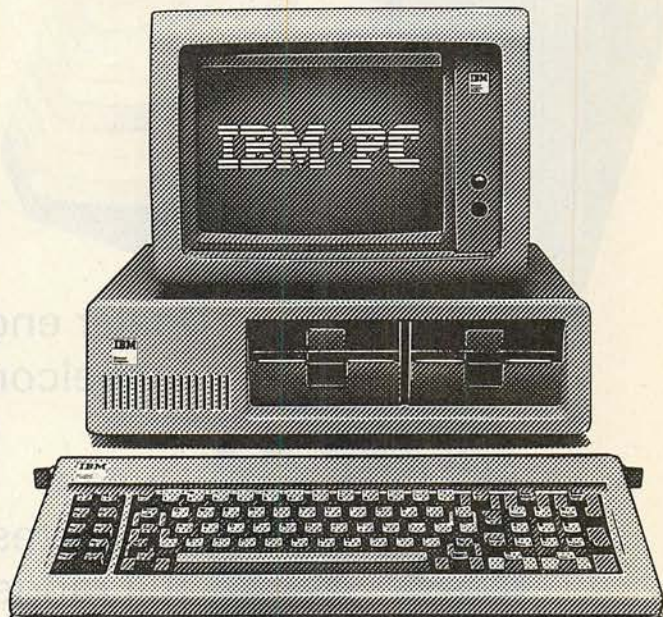

with a service to match.

One day, even your IBM Personal Computer will need servicing.

That's when you'll be glad you've talked to **microserve**, one of the UK's most experienced micro maintenance and service networks. We offer a complete range of servicing plans for both the IBM-PC and add-ons – and what's more we're nationwide.

So, before your dream turns into a nightmare, return the coupon or call us now on 0480-215005.

To: **microserve**, Freepost, Little End Road, Eaton Socon, St Neots, Huntingdon, Cambridgeshire PE19 3BR.

Name _____

Company _____

Position _____

Address _____

Tel. no. _____

P.C. 3/83.

microserveTM

A service of the Comart group of companies.
 London, Manchester, Birmingham, Glasgow, Nottingham, Southampton, Cambridge.

IBM is a registered trademark of the International Business Machines Corporation



FULL DETAILS AVAILABLE FROM

Peterson Electronics
Academy Street
Forfar
DD8 2HA
Tel No: 0307-62591

ANGUS

● Circle No. 270

● Circle No. 143

BOARDS FOR THE IBM PC

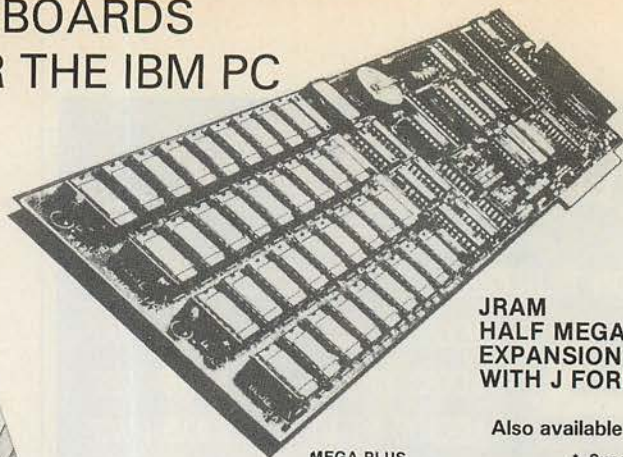

JRAM
HALF MEGABYTE MEM
EXPANSION BOARD CO
WITH J FORMAT £695.00

Also available

- | | |
|---|--|
| <p>MEGA PLUS</p> <ul style="list-style-type: none"> • 64K — 512K Parity Memory • Clock Calendar (Std) • IBM Compatible Async Port 1 (Std) • IBM Compatible Async Port 2 (Opt) • IBM Compatible Printer Port (Opt) • 512K with Mega Pak Option • Super drive included (disc emulator Prog) | <ul style="list-style-type: none"> • Super spool included (spooler prog) • Split memory address <p>COMBO PLUS</p> <ul style="list-style-type: none"> • 64K — 256K Parity M • Clock Calendar (Std) • IBM Compatible Asyn <p>(Opt)</p> <ul style="list-style-type: none"> • IBM Compatible Print • Super Drive included • Super Spool |
|---|--|

Dealer enquiries
welcome



Dysan
Diskettes
full range of
disks available

Software

Full range of C/PM and MSDOS S
ware available for IBM PC Sirius a
most other Micros.

- | | | | |
|--------------|------|--------------|---|
| • WordStar | £195 | • Mail Merge | £ |
| • Spell Star | £130 | • Super Calc | £ |
| • CON/CPM | £250 | • DBase II | £ |
| • Auto Code | £120 | • Milestone | £ |

Call for Full Price List.



DISK DRIVES
250K-1MB

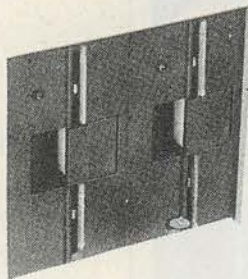

Full range of CDC drives
from 250K to 1MByte
sub systems/Bare drives
Winchester available.
BBC, NASCOM,
GEMINI, TANDY, VIDEO
GENIE AND MANY
MORE.

Printer switches
RS 232 cont-para
multiple printer switches

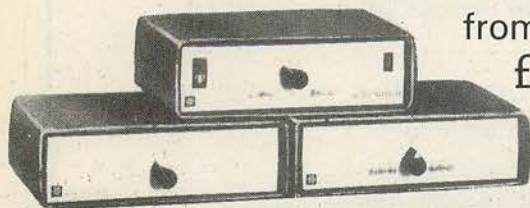

from
£79



EPSON HX-20



MICROWARE
LONDON LTD.

01-272 6237
01-272 6398

WE
EXPORT
WORLD WIDE!

We can upgrade
your IBM PC to Dual
Disk Drive, 640K or 1.2MB
Hard Disks also available.

NEW COLOUR MONITOR for the IBM PC

- * Styled for IBM PC
- * 80 x 26 Display
- * 690 Horizontal Resolution
- * NEC 0.31 mm dot Pitch CRT

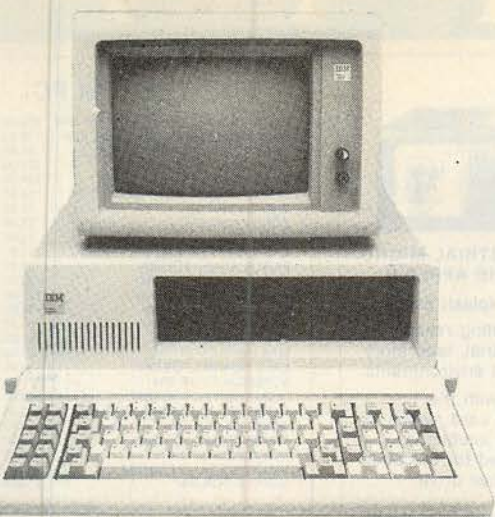

OSBORNE 1

FREE WITH EVERY MACHINE
Monitor, 10 Discs, CPM, Super Calc,
WordStar and Mail Merge.

ACT SIRIUS 1



Z80 Card and full
range of software available



SUPERBRAIN™

From 320K to 15MByte available

CALL FOR
CASH AND
CARRY
PRICES



MICROWARE

LONDON LTD.

01-272 6237
01-272 6398

VisiCalc was a good idea for then. Multiplan is a great idea for now.

The first generation electronic worksheets were a good idea. They were early software management tools that could eliminate a lot of hours with a spreadsheet, calculator, pencil and eraser. Enter Multiplan, the next generation electronic worksheet that's as easy to use as it is useful. Compare Multiplan's powerful user-oriented features to any electronic worksheet on the market. If you've been using VisiCalc, Multiplan's ability to directly utilize your VisiCalc files lets you easily upgrade to Multiplan.

MULTIPLAN - THE ELECTRONIC WORKSHEET FOR NOW £ 179.00

TRIPLE YOUR DISK ACCESS SPEED

No hardware modification required

FastDOS

Fast Disk operating system for Apple II computers

Completely compatible with DOS disks

Loads and saves standard DOS files

Completely compatible with all DOS/APPLESOFT programs that access DOS through standard hooks, including FID and MUFFIN

Executes all standard DOS commands

Comparative timings:	DOS	FDOS
Blooding integer basic	13 sec	3 sec
Cataloging a 12 file disk	2 sec	1 sec
Saving a 10 sector program	6 sec	2 sec
Saving a 100 sector program	34 sec	7 sec
Loading a 100 sector program	24 sec	7 sec

Requires 48K

£19.95

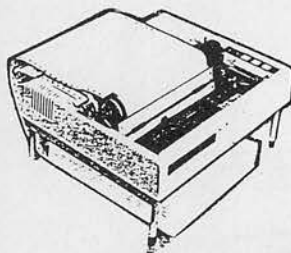

IT'S OFTEN BEEN SAID THAT THE SIMPLEST IDEAS ARE THE BEST - AND JUST LOOK AT THIS ONE FOR PAPER STORAGE.

Pete & Pam Computer's Stilts are four legs which can be installed on to your Epson MX80 in seconds - giving you room for 3 inches of paper.

stilts

£5.95

APPLE CARE MACHINE COVERS

APPLE II	5.95
APPLE & 2 DISKS	7.95
APPLE & 12" MONITOR	7.95
APPLE, 2 DK & 12" MON.	9.50
APPLE, 2 DK & 9" MON.	8.95
SINGLE DISK	3.45
2 STACKED DISK	4.45
9" MONITOR	4.95
EPSON MX80/70	5.45
PAPER TIGER 445/60	7.95
APPLE III/INC. MON	12.95
MX100	8.95
QUME 5 W/TRACTOR	10.95
NEC 12" MONITOR	7.50
HITACHI 12" MON.	7.50
DECCA RGB MONITOR	8.95
SIRIUS KEYBOARD	4.45
SIRIUS PROC & MON	12.95

HEAD CLEANING

Clean read/write heads the way leading manufacturers recommend 5 1/4" disk head cleaning kit.

DISKS & DISK BOXES
BASF single sided, single density disks.
10 for £17.90 100 for £159 50 for £84.50

Kass-ette storage boxes £2.45

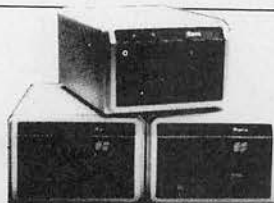

RANA SYSTEMS DISC DRIVES

Elite I - £259
Elite II - £339
Elite III - £399



WIZARD BPO

16K and 32K BUFFERED PARALLEL OUTPUT PRINTER INTERFACE CARD FOR APPLE II and APPLE II PLUS COMPUTERS FOR OKI, EPSON & ANADEX

WIZARD BPO 16K £149.00
WIZARD BPO 32K £169.00

DESKTOP/PLAN II

from Personal Software
A programming language for financial analysis

★ £79 ★

NEW

MICROSOFT FLIGHT SIMULATOR FOR IBM PC £30.95

The Bufferboard™



£99.00

THE NEW CENTRONICS COMPATIBLE PARALLEL BUFFER FROM ORANGE MICRO



SPECIAL OFFER PRICE



ALS Supercalc £59.00

FCL 6000

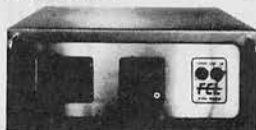

THE NEW INDUSTRIAL MICRO BASED ON THE APPLE II

Dust, dirt and splash proof.
Capable of operating reliably in aggressive industrial, laboratory and process plant environments.

Supplied with the FCL AUTOPROM card, which in many control situations, eliminates the need for the often unreliable disc drive.

FCL Industrial Apple Processor £1850

FCL Autoprom £180

FCL Industrial Apple Keyboard £180

UTILITY PROGRAMS

DOS TOOL KIT	41.00
SCRIPT III	64.29
MENU GENERATOR	25.95
MACRO SCREEN EDITOR	32.95
PROGRAMMING AIDS 3.3	49.95
MCAT 2.0	15.95
CRAE 2.0	15.95
ALD SYSTEM II	49.95
ALD SYSTEM FOR APPLE III	49.95
EDIT 6502	69.95
TASC (Applesoft Compiler)	109.00
LISA ASSEM. LANG. DEVEL. SYSTEM	59.00
SPEED-ASM	25.95
EXT. PROG. FACILITY IV	52.95
EXPEDITER II+	75.00
BAG OF TRICKS	25.95
MON+	25.95
SUPER DISK COPY III	19.95
DISK RECOVERY	18.95
DISK ORGANISER II	18.95
MULTI-DISK CATALOG III	15.95
APPLESOFT + STRUCTURED BASIC	15.95
DOS PLUS	15.95
QUICKLOADER	15.95
APPLESOFT PROGRAM OPTIMISER	12.95
APPLE SPELLER	44.95
IMAGE PRINTER	25.95
THE BUG	32.95
BUILD USING	19.95
EDIT SOFT	19.95
ACE (Applesoft Command Editor)	25.95
APPLE DOC	25.95
ASCHI EXPRESS	44.95
PROGRAMMERS UTILITIES	13.95
LIST MASTER	70.00
DISK DOCTOR (CP/M D. RECOVERY)	70.00
HIGHER FONTS	11.95
DIRECTORY MANAGER	21.95
PROGRAM LINE EDITOR	25.95
SOFT SEVENTY	32.95
INTEGER BASIC COMPILER	99.95
GLOBAL PROGRAM LINE EDITOR	42.95
PROGRAM LINE EDITOR IN ROM	39.95
KRAM	59.95
SUPER KRAM	89.95
THE MANAGER (Memory MGT. SWRE)	19.95
APPLE EXTENDED EDITOR	44.95
FASTDOS (INC. DOS ACCESS SPEED)	19.95



THE SWEET-P

Graphic Plotter, for graph processing, chart processing, engineering graphics and overhead transparencies.

£595

FOR THE IBM PC

PARA/RS232/CLOCK CARD FOR IBM	239.00
CLOCK CALENDAR CARD FOR IBM	119.00
PROTOTYPING CARD FOR IBM	25.95
PROM BLASTER FOR IBM	129.00
DBASE II FOR IBM	399.00
CHAMPIONSHIP BLACKJACK (IBM)	24.95
ZORK I FOR IBM	25.95
ZORK II FOR IBM	25.95
DEADLINE	32.95
EASYFILER FOR IBM	249.00
EASYPLANNER FOR IBM	125.00
EASYSPELLER FOR IBM	125.00
EASYWRITER II FOR IBM	225.00
MATHEMAGIC FOR IBM	59.95
GRAPHMAGIC FOR IBM	59.95
WORDSTAR FOR IBM	195.00
MAILMERGE FOR IBM	65.00
CALL TO ARMS FOR IBM	15.95
SUPERCALC FOR IBM	225.00
SUPERWRITER FOR IBM	249.00
I/O IBM INT. (2 SER. PARA. & GM)	195.00
JOYSTICK FOR IBM	39.95
VISICALC 256K FOR IBM	160.00
VISIDEX FOR IBM	160.00
VISITREND/PLOT FOR IBM	210.00
VISIFILE FOR IBM	210.00

FUNCTION STRIP and . . .



ENHANCER II

The Videx Function Strip adds a whole new dimension to your Enhancer II Apple II Function Keys. Now you can have dedicated keys for your macro definitions. Program often used word processor commands, words or phrases into your Function Strip. Programmers will find it a significant aid to be able to define often used commands and statements. VisiCalc users can define often used commands and file names for single keystroke ease of use.

The Videx Function Strip is a low cost, versatile strip of pressure sensitive switches. The Function Strip adheres to the Apple II's lid - just above the keyboard and connects to the Enhancer II's keypad connector port. The Function Strip is completely compatible with keypads connecting to the Apple II motherboard.

Function Strip £54.95
Enhancer II £99.00
OR . . . BOTH FOR A SPECIAL PRICE OF £149.00

BOOKS

APPLE MACHINE LANGUAGE	£11.85
PASCAL PROGRAMMING FOR APPLE	£10.45
APPLESOFT LANGUAGE	£7.85
INTIMATE INST. IN INTEGER BSC.	£5.55
APPLE BASIC FOR BUSINESS	£11.20
APPLE PASCAL GAMES	£9.70
PROGRAMMING THE 8502	£9.70
8502 APPLICATION BOOK	£10.25
8502 GAMES	£10.25
8502 SOFTWARE DESIGN	£5.50
8502 APPLICATIONS	£9.70
CP/M USER'S GUIDE	£4.95
APPLE INTERFACING	7.85
CIRCUIT DES. PROGS FOR APPLE	£11.15
APPLE II USERS GUIDE	£10.95
VISICALC HOME & OFFICE COMPN.	£11.50
THE POWER OF VISICALC VOL. 1	£6.95
THE POWER OF VISICALC VOL. 2	£6.95
KIDS AND THE APPLE	£13.95
GUIDE TO PROGRAMMING IN ASOFT	£11.50
SCIENCE & ENG. PROGRAMS (AII)	£11.50
A'SOFT BASIC DATA FILE PROG.	£8.95
ASSEMBLY LANG PROGRAMMING	£9.50
OSBORNE CP/M USERS GUIDE	£3.95



THE WILDCARD

SOFTWARE COPYING SYSTEM £99.00

Products available from dealers throughout the UK.

● Circle No. 146

Pete & Pam Computers

Head Office:
New Hall Hey Road,
Rossendale, Lancs., BB4 6JG
Phone: (0706) 227011
Tele: 635740 Petpam G

Norwegian Agent:
The Norwegian Software House
Address Oskerveien 145
Oslo 5

Telephone 47 2 64 55 77

Prices do not include VAT please add 15% to your remittance Postage and Packing FREE



debatapple

London Office:
103.5 Biegborough Road,
London, SW16 6DL
Phones: 01-769 1022/3/4
Telex: 932070 PFCOMP G

Cumana drives BBC Micro best!



**CUMANA DRIVES +
OWN POWER SUPPLY
=BIG PLUS FOR
BBC MICRO USERS
... JUST FOR
STARTERS**

The 'ice on the cake' is that because the Cumana Drive has its own power supply, it can be used with many other Micros when connected via the appropriate cable. Cumana supply a Drive connecting cable which has a standard 34 way edge connector plus 34 way BBC connector in the same cable length. This allows the Cumana Drive to be connected to numerous makes of micro without the need to change connecting cable. And the Japanese manufactured disk drives are quiet and utterly dependable.

- | | |
|--|-------------|
| CS50A Single 40 track drive 100K | £199 |
| CD50F 2 double sided 80 Track TEAC Drives
with cabinet and power supply 800K | £619 |
| Disk formatter and instructional manual | £15 |
| Model A-B upgrade kits | £65 |

*Many other Disk Models available for BBC.
Call or write for Data Sheet.*

CUMANA LTD

Unit 1, The Pines Trading Estate, Broad Street,
GUILDFORD, Surrey GU3 3BH (0483) 503121
Telex: 859380 CUMANA

**12 MONTH
FULL WARRANTY**

**£199
100K**

**£619
800K**

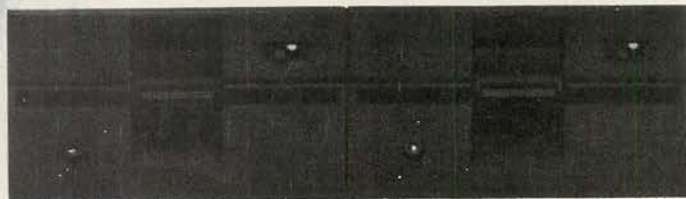
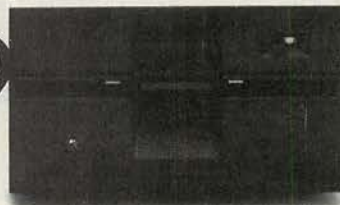

Please add VAT to all prices

**DEALER & EDUCATIONAL ENQUIRIES WELCOME -
GENEROUS DISCOUNTS AVAILABLE**

● Circle No. 150

Eltec HOME & BUSINESS TECHNOLOGY computers

Probably the widest selection of software available by mail order.

All the top manufacturers including Acorn Soft, IJK (Sinclair), Superior Software, Bug Byte, Program Power, Hessel, Procyon.

HERE IS A SELECTION

Peeko Computer	9.95
Junior Maths Pack	6.84
Philosopher's Quest	9.95
Planetoid	9.95
Meteors	9.95
Arcadians	9.95
Swoop	7.99
Chess Model B	7.99
Space Invaders Model B The best	6.95
Atlantis — Superb fast Action 32K	6.95
Hyperdrive 32K	5.95
Stratobomber	6.95

Send SAE for full list.

HARDWARE EXPANSION

Sound pick-off module (simple to fit)	6.95
Amplifier and loudspeaker suitable for above	37.50
Light pen	34.50
X-Y digitiser	80.00

SUPER ACCESSORIES

Cover Polyester Cotton	3.97
Cover Soft PVC	4.45
Carrying Case for Computer, Cables, Cassette/ Disc Drive	55.20
Carrying Case a soft supported nylon version of above	23.00

BBC models A & B in stock: A - £299 B - £399

DISK DRIVES FOR BBC

BBC 100K Single drive (Requires discs (a))	265.00
TORCH Z80 800K Disc pack includes Z80 proc'r + 64K (b)	897.00
BBC/LVL 200K Twin Drive (a)	397.00
TEAC 200K Single Drive (a)	304.75
TEAC 400K Twin Drive (a)	569.25
TEAC 400K Single Drive (b)	396.75
TEAC 800K Twin Drive (b)	711.85
Connecting cable for TEAC drives	17.25
(a) SCOTCH Single sided discs Box of 10	28.75
(b) SCOTCH Double sided discs Box of 10	39.80

BBC UPGRADES

Full upgrade kit (fitting £31.00)	69.00
Discinterface (fitting £15.00)	109.25

The above prices are VAT inclusive. Add £1.00 p&p for orders below £100.00 and £10.00 (Securicor delivery) for orders above £100.00. Access and Barclaycard accepted on all items except BBC computers.

ELTEC COMPUTERS

217 Manningham Lane, Bradford, BD8 7HH.
Tel (0274) 722512.

● Circle No. 151



FULL DETAILS AVAILABLE FROM
System and Programming Ltd
9 Ainsdale Close
Bletchley
Milton Keynes MK3 7PT
Tel No: 0908-78413

BUCKINGHAMSHIRE

● Circle No. 152

WORDSTAR TRAINING COURSES

- A) Two day course on using WORDSTAR. Assuming little or no experience of word processing £150 per person
- B) One day course on using WORDSTAR with Mailmerge Assuming course (A) experience £75.00 per person

All courses are given on our premises with individual attention during hands on use of our systems.

All prices include appropriate documentation but are exclusive of V.A.T.

Training can be given on your own premises using your own equipment

Please Telephone or Write for further details

SLOGGER SOFTWARE

215 Beacon Road
Chatham, Kent ME5 7BU

Tel: MEDWAY (0634) 811634

● Circle No. 153

CHROMASONIC business systems



EPSON
MX-100
MX-80
MATRIX PRINTERS

commodore



COMMODORE 700 SERIES



01-263 9493/5
48 JUNCTION RD, ARCHWAY, LONDON N19 5RD Telex 22568

SYSTEMS SUPPLIED NATIONWIDE

APPOINTED DEALER FOR

ALL THESE MANUFACTURERS

FULL SUPPORT ON ALL
PRODUCTS!

ACT
SIRIUS 1

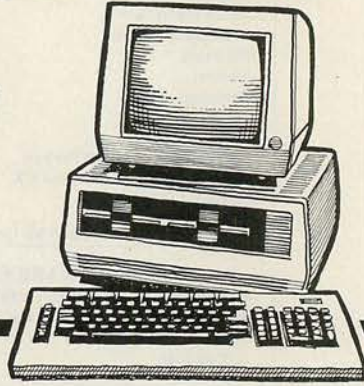

TEC
DAISY WHEEL
PRINTERS

SCM
SMITH-CORONA



SOFTWARE:

PEGASUS

ACCOUNTS
SALES, PURCHASE &
NOMINAL LEDGERS
INVOICING &
STOCK CONTROL

WORD PROCESSING

SUPERSCRIPT (CBM)
WORDSTAR (TRANSTEC)
SELECT (SIRIUS 1)

VISICALC

FINANCIAL PLANNING

D.M.S.

DATA MANAGEMENT
PACKAGE

Leeds Office

'PHONE
FOR ADVICE, PRICE
& DEMONSTRATION

Northern Address: 6 WIGTON GROVE,
LEEDS LS17 7D2 Tel: (0532) 688397

**SOFTWARE
HOTLINE:**
01-263 7341

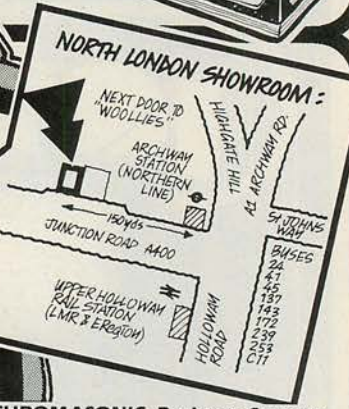

Post to **CHROMASONIC Business Systems**,
48 Junction Road, Archway, LONDON N19 5RD

Please send me further details about your
business systems. I am particularly interested in:

NAME:

POSITION:

COMPANY:

ADDRESS:

TELEPHONE:

commodore

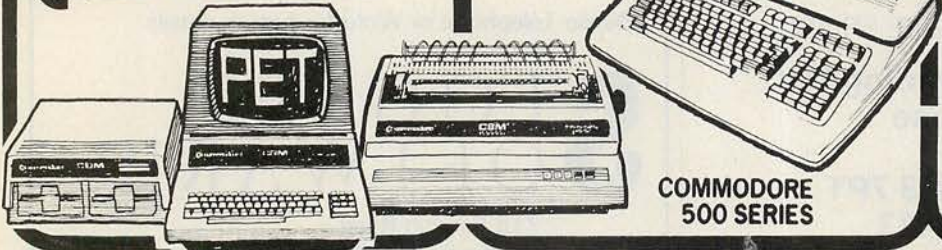

COMMODORE
500 SERIES

TERMS OF BUSINESS: Please add 15% VAT to all prices. Delivery charged at Cost.
Prices valid for cover date of this magazine. Access and Barclaycard orders welcome.

POST YOUR
COUPON NOW!



Circle No. 154

Get with it!



COBOL, FORTRAN, PASCAL & other complexities of the past
... forget them!

Design and write your own systems in ENGLISH with

DYNATECH'S PROGRAM GENERATORS

Professionals can increase their output tenfold and novices can learn how to write professional programs in minutes using Codewriter* or Techwriter* - now selling worldwide.

What are the benefits?

- Save time...up to 90%
- Improves efficiency
- Provides information, faster
- Any member of staff can operate them
- User modifiable programs can be compiled for high speed operation

Seminars are held in London and other major cities throughout the year.

We have Program Generators available now for Apple II, III*, CP/M*, CBM Pet*, Sirius* and Osborne* - with more to come.

DYNATECH MICROSOFTWARE LTD

Summerfield House, Vale, Guernsey, Channel Islands
Telephone: 0481 45934 Telex: 4191130

*Registered Trademarks

Please send me details on Dynatech's Program Generators.
What type of micro-computer do you have or are considering purchasing?

Name _____
Address _____
Tel _____ PC3 _____

● Circle No. 155

LET YOUR MICRO TAKE OFF WITH GEMINI

USING GEMINI FUNCTIONAL CASSETTE SOFTWARE FOR JUST £19.95

Fully compatible with
 TI-99/4A SHARP MZ-80K/A/B
 VIC 16K BBC Micro
 Oric Sinclair Spectrum
 Dragon 32 ATARI 400/800

Here's the software to run your budgeting, your business, your stamp collection, your car costs . . . even to plan your next meal and help you choose a wife. Tested programs that come with all the documentation back-up you need from

Gemini who are experts in practical software. So mail us the coupon - and put your micro to work . . . fast.

SPECIAL LIMITED OFFER
 Any 3 programs at £19.95 for the price of two with all orders received before 31st March 1983.



1 DATABASE The Program that everyone needs. Facilities include sort, search, list, delete, change, totals, save file, line print if required, etc. etc. Can be used in place of any card index application. **£19.95**



STOCK CONTROL All the necessary for keeping a control of stock. Routines include stock set up, user reference no., minimum stock level, financial summary, line print records, quick stock summary, add stock, delete/change record and more. **£19.95**



MAILING LIST A superb dedicated database to allow for manipulation of names & addresses & other data, with selective printing to line printer. Features include the facility to find a name or detail when only part of that detail is known. Will print labels in a variety of user-specified formats. **£19.95**



INVOICES AND STATEMENTS Ideal for the small business. A complete suite of programs together with generated customer file for producing crisp and efficient business invoices and monthly statements on your line printer. All calculations including VAT automatic and provision for your own messages on the form produced. *Not Spectrum **£19.95**



COMMERCIAL ACCOUNTS A gem of a program, all for cassette, with the following features:-

Daily Journal • Credit Sales • Cash Sales • Credit Purchases • Purchases - other • Sales Ledger • Purchase Ledger • Bank Account • Year to Date Summary

A fully interactive program suitable for all businesses. Files can be saved and loaded and totals from one file carried forward to another on cassette. Particularly useful from a cash flow point of view, with an immediate accessibility to totals for debtors and creditors. Bank totally supported with entries for cheque numbers, credits and, of course, running balance. **£19.95**



HOME ACCOUNTS Runs a complete home finance package for you with every facility necessary for keeping a track of regular and other expenses, bank account, mortgage, H.P. etc. etc! You'll wonder how you ever managed without it. **£19.95**

Gemini Marketing Limited.
Functional Software Specialists
 9, Salterton Road Exmouth, Devon.
 Telephone orders welcome. (03952) 5832
 Please quote Access/Diners Card Number

For Functional Software
 Dealer Enquiries Welcome

ZX81 16K - Database available - Only £7.50 including FREE Decision Maker Programme.

Tick the box for Program you require. Prices include V.A.T and Package and Postage. Please supply the following cassette software.

Database	£19.95	<input type="checkbox"/>
Stock Control	£19.95	<input type="checkbox"/>
Mailing List	£19.95	<input type="checkbox"/>
Invoices and Statements	£19.95	<input type="checkbox"/>
Commercial Accounts	£19.95	<input type="checkbox"/>
Home Accounts	£19.95	<input type="checkbox"/>
ZX81 16K Database	£7.50	<input type="checkbox"/>

Name _____

Address _____

Machine Type _____

Memory Size _____

I enclose _____

Make cheques and postal orders payable to Gemini Marketing Ltd.

Diners Card Number _____

Access Number _____



Signature: _____

Gemini. Functional Software Specialists 9, Salterton Road, Exmouth, Devon. (03952) 5832
 Telephone orders welcome. Please quote Access/Diners Card Number

PC3

"FUTURE-PROOF" MULTI-USER CP/M SYSTEM

WITH A CHOICE OF 8 BIT OR 16 BIT
MULTI-PROCESSORS INTERMIXED
PRICE from £4,927 (excluding VAT)
for 2 user 10MByte System

SuperStar is a revolutionary concept which brings the price of a full multi-user system down to incredibly low figures WITHOUT LOSING the features you would expect from a MINICOMPUTER — performance, capacity and capability. On the contrary, besides substantial savings there are a lot of other benefits in the SuperStar approach — the widest selection of low-cost package programs, shorter time scales and cheaper implementation of bespoke programs. Compact size, preventive-maintenance-free and latest technology are all bonuses.

SuperStar employs world standard components both in hardware and software to guarantee you a "FUTURE-PROOF" system which is readily upgradeable.

SuperStar

- ★ MINICOMPUTER performance, capacity and capability and YET aggressive Micro-technology prices.
- ★ CP/M (8-bit or 16-bit) based world of low-cost programs and YET full multi-user capability (e.g. record/file lock, spooling etc)
- ★ S100 (IEEE 696) modularity for "FUTURE-PROOF" hardware and wide selection of "add-ons" from numerous manufacturers.
- ★ "PRIVATE-PROCESSOR" architecture ensures ZERO CPU DEGRADATION and provides full hardware isolation and protection between users.

BROMCOM

Bromley Computer Consultancy Ltd.

417-421 Bromley Road, Bromley, Kent BR1 4PJ
Tel: 01-697 8933 Telex 896691 TLX1RG

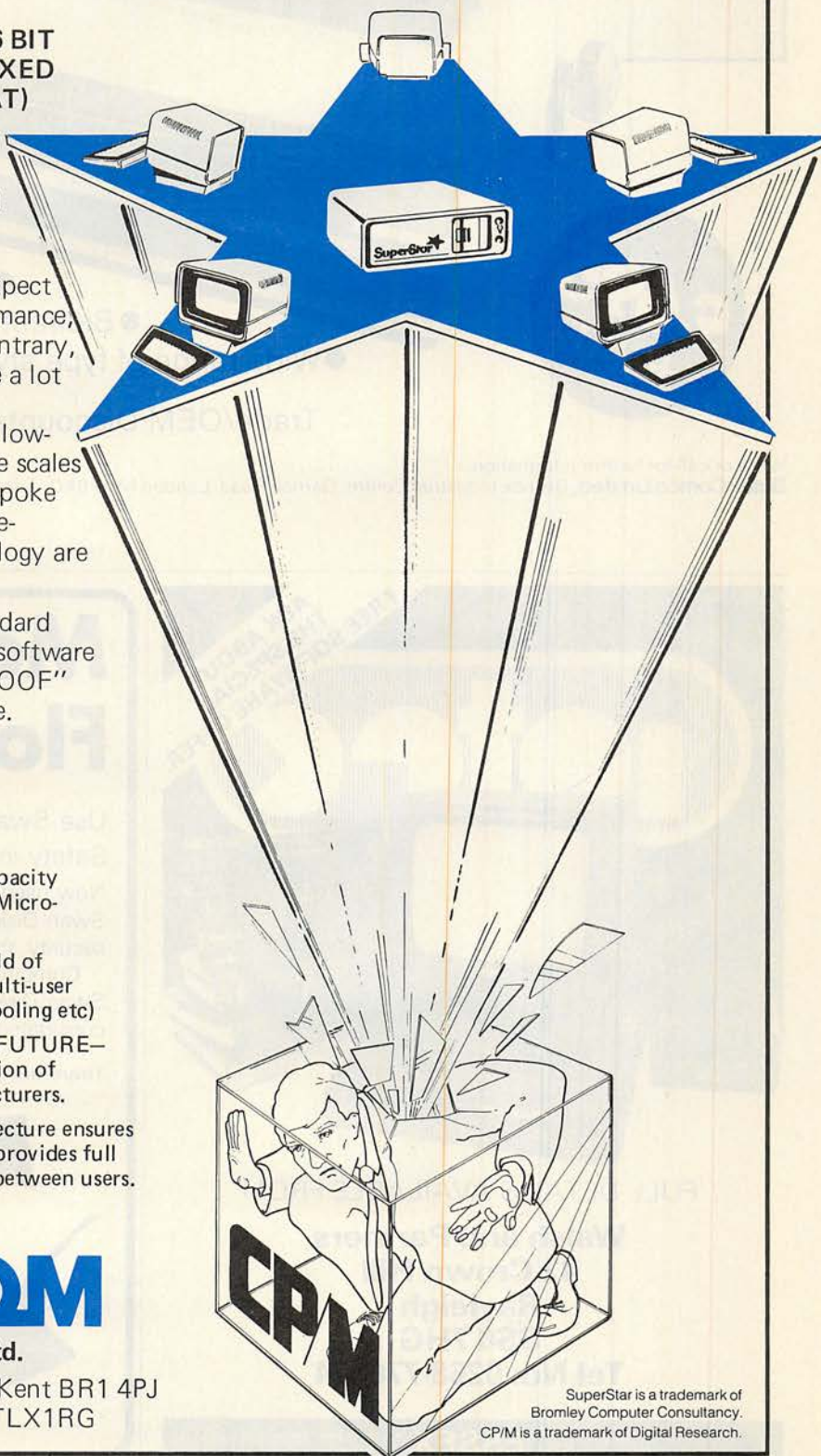

SuperStar is a trademark of
Bromley Computer Consultancy.
CP/M is a trademark of Digital Research.

● Circle No. 157

THE STYLIST

a high quality daisy wheel printer



**£695
+VAT**

- V24/RS232 interface
- Proportional spacing
- Bidirectional/logic seeking
- Wide range of type styles and international languages

Trade/OEM Discounts available

Write or call for further information:

Butel-Comco Limited, Garrick Industrial Centre, Garrick Road, London NW9 6AQ. Telephone:01-202 0262.

BUTEL
Technology for business

● Circle No. 15



FULL DETAILS AVAILABLE FROM

Walsh and Partners
42 Crown Hill
Rayleigh
SS6 7HG
Tel No: 0268-776374

ESSEX

● Circle No. 159

Mailing Floppy Disks?

Use Swan Disk Mailers — and get Safety in the Mail

Now used by over 1,000 computer companies, Swan Disk Mailers provide outstanding postal security at economical prices.

Combining great strength with simplicity of use, Swan Disk Mailers are manufactured from rigid white corrugated, holding up to four disks.

There are two sizes available: 8.75" x 8.75" & 6" x 6"

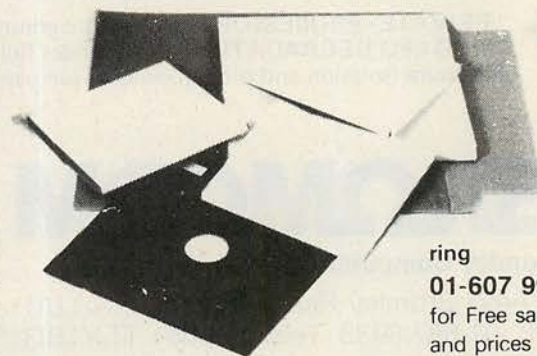

ring
01-607 9938
for Free samples
and prices

● Circle No. 16



PROGRAMS WITH A DIFFERENCE

from



WORD HANDLER



LIST HANDLER

SILICON VALLEY SYSTEMS, INC.

!! 66 COLUMNS ON-SCREEN!!

PLUS Full and Powerful Word Processing **WITHOUT ANY EXTRA HARDWARE** Will run on standard 48K Apple with one or two disk drives. With direct-to-disk editing its possible to have single documents larger than memory. PLUS all underlining, justification etc appears on the screen. **£109**

(£125.35 Inc.VAT)

upto 3000 records on ONE DISK

PLUS sorting on up to **8 DRIVES** allowing say, a Mailing List of **24000!!** Lists are totally user defined and can have as many as 255 fields! PLUS full merging with Text files to produce form-letters, price-list, in fact the only restriction is the users imagination. **£65**

(£74.75 Inc.VAT)

STUDYING FOR EXAMS?

Simply type your notes into our **E-Z LEARNER** program, and the computer will throw random questions at you until you have learned each subject thoroughly. **£25**

(£28.75 Inc.VAT)

LOTS OF READING TO DO?

Then you need a copy of our **RAPID READER** You decide on the speed you want to practice at and the computer will give you words sentences and paragraphs to read and then tests you for comprehension. **£25**

(£28.75 Inc.VAT)

Apple III

FREE WITH THESE APPLES!

Apple II



Accounting Business Systems
TABS
SALES LEDGER
PURCHASE LEDGER



Complete start-up business systems at the same cost as the hardware only

Unlike the 'discount boys' this offer includes **ON-SITE INSTALLATION**

2 hours BASIC INSTRUCTION and FULL AFTERSALES BACK-UP



PLUS APPLEWRITER III

SYSTEM COST (as illustrated) £2418

FREE SOFTWARE VALUE £659

OFFER ENDS 24th February 1983

24-hour ON-SITE MAINTENANCE AVAILABLE

(Prices quoted DO NOT INCLUDE VAT)

WORD HANDLER II LIST HANDLER

THE LAST ONE VISICALC

SYSTEM COST (with Hitachi monitor) £1602
FREE SOFTWARE VALUE £519

NewBrain AT LAST

SOME SOFTWARE!

GAMES

All NEWBRAIN PRICES include VAT

GOBLER

The well-known Arcade game of eat and be eaten **£10.00**

TYCOON/PELMANISM

TYCOON requires you to buy and sell shares with the computer, throwing in random factors that affect prices. PELMANISM is the game that test your memory making cards into pairs. **£12.00**

WORMS

Chasing your own tail can be very tricky **£9.95**

HOME & BUSINESS

HOME BUDGET

Keep track of the family finances quickly and easily. **£12.00**

DIARY

12 months appointments birthdays etc. **£12.50**

WORD WORKER

A very efficient word processor. Ideal for students and people who write **£29.95**

DATA BASE

Store up to 800 records and sort on up to 11 fields. **£31.50**

INVOICE & CREDIT NOTE

Issues and keeps track of all your Invoices. **£69.95**

INVOICE REVIEW

Analyses and reports all Invoices issued. **£27.50**

(if both programs bought together, DEDUCT £12.45 from total)

NEWBRAIN

Model AD £263.35
(with LCD display)

Model A £228.85

Full product support and Guarantee



WE ARE ACCREDITED DEALERS

We will assist you all the way through with installation

FULL STAFF TRAINING BY TABS IS AVAILABLE IF REQUIRED

MARS

MANAGEMENT ACCOUNTING & REPORTING SYSTEM

FOR POWERFUL FINANCIAL MODELLING
For ALL CP/M systems **£295**
(£339.25 Inc.VAT)

Mail Order

Prices include Post & Packing

Full after-sales service is included with all Software

Callers very welcome.

Our retail shop is open from 10 till 6 (Closed Wednesday all day)

10 Eastfield Parade
Forbes Avenue, Potters Bar
Herts. EN6 5ND
Potters Bar (0707) 44808

24hr Telephone ordering service on 0707 59669

NAME	Qty	Item	Cost	P&P
ADDRESS				
Postcode				
Telephone				
MAKE				
MODEL				
ACCESS				
BAR CARD				
			Sub-totals	
Cheque/P-Order/Cash/Card No. for				

NO STAMP REQUIRED! just place in an envelope and post to:-



Potters Bar computers

FREEPOST 9009 Potters Bar, Herts., EN6 2BR



Software needn't put you in a straitjacket.

If you were putting your business on to computer, selecting software used to put you on a hiding to nothing.

First you had to know exactly what you wanted even before you fully understood what it was. Next you had to gradually learn about all the inevitable and frustrating limitations.

Now comes the strait jacket bit. Because then you have to start praying that your needs aren't going to change. If they did it was start again time. And what's worse, pay again time.

Now there's Silicon Office. A truly flexible system that is whatever software you want it to be.

It is designed so that you can realise more and more of its full potential as you work with it.

You can tell Silicon Office what you want in plain English.

It has an incredibly simple command set with commands like:

'Get record (GR)', 'Copy disk (CD)', 'Delete record (DR)', etc.

But the real genius of Silicon Office is that it can change with your needs. Even if you shut down one operation and start a completely unrelated enterprise, Silicon Office can cope.

Included in the bargain is a formidable word processing capability with direct access to the whole of the data base. So don't put yourself in a strait jacket. Take a look at Silicon Office - soon.

SILICON OFFICE

THE FLEXIBLE SOFTWARE SYSTEM

To: Bristol Software Factory, Kingsons House,
Grove Avenue, Queen Square, BRISTOL BS1 4QY.

Please send me full details of Silicon Office

Name _____

Company _____

Address _____

PC _____

● Circle No. 163

The LEEDS

COMPUTER CENTRE

For all your computer needs

**CPU+
64k Ram**

CPU £125.00

plus V.A.T.

CPU plus 64k RAM

£225.00 plus V.A.T.

64k RAM £125.00 plus V.A.T.

COMPLETE TWIN DISK SYSTEM

£675.00 plus V.A.T.

I/O Card £125.00

plus V.A.T.

**80x25
Video
Controller**

MULTIBOARDS use 80-Bus and are fully Nascom compatible e.g. disks, enhanced video, Input/Output or Ram expansion.

**Floppy
Disc
Controller**

MULTIBOARDS make computers **MULTIBOARDS** enhance:-

GEMINI, Nascom or QUANTUM
Send for full details

The QUANTUM 2000

is ideal for business applications. It can have up to THREE drives giving 2.4 megabytes of disk storage. Its expansion capabilities are almost infinite, thanks to the flexibility of Multiboard plus 80-Bus.

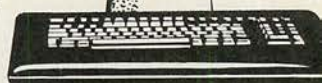

GEMINI GALAXY 64K 2.2 CP/M MICROCOMPUTER

A cost effective solution to the small business, educational or home user requiring a reliable Z80 based CP/M computer
From **£1450.00** plus V.A.T.



We are an official Sharp computer centre

As one of SHARP'S biggest distributors, we always have stocks. We have the expertise to advise you on interfaces and software. We developed the QUANTUM MZ 80k Hi-Res which gained official SHARP approval.

PLEASE CALL FOR LATEST PRICES.

MZ80A with £75.00 free software **£475.00** plus V.A.T.

MZ80B with 64k plus GRAPHICS RAM

£850.00 plus V.A.T.

PC1211 **£65.00** plus V.A.T.

CE122 PRINTER **£60.00** plus V.A.T.

PC1500 **£145.00** plus V.A.T.

CE150 PLOTTER **£130.00**

plus V.A.T.

QUANTUM MZ80K

HI-RES **£100**

plus V.A.T.



We stock the following printers:- EPSON, SEIKOSHA, and more important, we know how to interface them to a variety of computers.

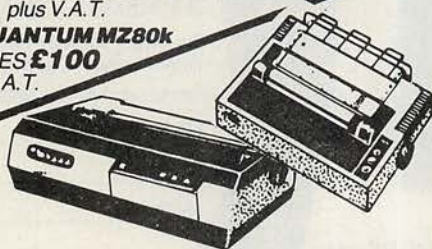

Only the new HX20 portable computer from Epson fulfils these requirements

WANTED: PERSONAL ASSISTANT
ESSENTIAL REQUIREMENTS
1. Must work all hours - all conditions
2. Excellent memory essential
3. Good telephone manner - able to communicate
4. Never run out of power
5. Go anywhere - at a moment's notice
6. Will fit comfortably on Boss's lap

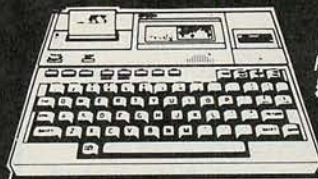

From **£402** plus VAT

HX-20
PORTABLE COMPUTER

The first truly portable computer with full size keyboard, built-in printer, micro cassette drive, high resolution display, rechargeable batteries give hours & hours of use and give enough power to retain memory when computer is switched off, and is only 1.7ins. thick and about A4 size. THINK it in England, COMPUTE it over France, PRINT it in Saudi and SAVE it on your main system back in England. That's what HX20 can do for you - and it's cheaper too. For a standard desk top of roughly the same power as HX20 you could pay about twice as much - that's real value for money!

BITS & PCS

COMPUTER PRODUCTS LTD

Trading as Leeds Computer Centre. Please call or write for full details
Leeds Computer Centre, The Balcony, 60/62 Merrion Centre, LEEDS.
Tel: 0532-458877



• Circle No. 164

PRACTICAL COMPUTING March 1983

ATA THE PRICE BEATERS



Apple
fresh new 48K Apple
only £579
 (While stocks last)

Visicalc

Latest packaging versions

Visicalc.....	£121
Visitrend/Plot.....	£149
Visidex.....	£149
Visifile.....	£159
Visischedule.....	£180

APPLE II REV E
AVAILABLE NOW
ONLY £649
 phone for details

Epson Printers

Unbeatable Value!

MX80T (Type 3).....	£290
MX80F/T (Type 3) ..	£315
MX100F/T (Type 3)	£420
Other printer prices on application	

Software

Report.....	£75
Master 3.....	£139
Factory 5.....	£199
Chemagic.....	£55
Phmagic.....	£55
Smith 4.1.....	£65
Tool Kit.....	£42
File Pascal.....	£149
ewriter.....	£39
ewriter II.....	£85
star 3.0.....	£155
merge.....	£59

Disk Drives

Apple disk drives at these incredible low prices!

With Controller.....	£270
Without Controller.....	£220

Apple III

128K.....	£1995
256K.....	£2495
Secondary Disk Drive.....	£240
Profile Hard Disk.....	£2095

Please phone for comprehensive list.

Hitachi 12" Green Screen Monitors Only £90 FREE

Anti-Glare Screen

Interfaces

Parallel Printer Card.....	£70
Serial Printer Card.....	£105
Pascal Card.....	£105
Digitek Colour Card.....	£99
Z80 System (New version).....	£220
80 Col System (Videx).....	£200
Soft Switch (Videx).....	£25

16K RAM Card.....£48
128K RAM Card.....£350

Accessories

Numeric Keypad.....	£75
Joystick (TKC).....	£29
Paddles.....	£19
Cooling Fan.....	£55
10 BASF 5 1/4" Disks.....	£20
Listing Paper.....	£18
Locking Disk Box.....	£20

Mac Orbit Accounting Modules:
 prices on application - Please
 phone for list.



IBM
 PC 64K UK Spec -
 Power supply £2749

Unbeatable Value

System Expansion

Memory Board.....	£277
16K Memory Board.....	£382
32K Memory Board.....	£476
64K Memory Board.....	£572
128K Memory Board.....	£980
Blue.....	£392
Blue.....	£392

Hard Disks

10 Winchester.....	£1648
20 Winchester.....	£2197
40 Winchester (with tape backup).....	£2699

Printer Accessories

Graphics Monitor.....	£155
Printer Monitor.....	£625
Printer/ Graphics Card.....	£340
Chronous Comms Card.....	£170
Printer adapter.....	£63
Joysticks.....	£42
Pen.....	£159

Phone for details

Please add 1.5% to your order for UK delivery charge.
 Payment accepted by cash/bankers draft/building society
 cheque for immediate despatch.

Goods are normally in stock, however, please confirm before
 ordering.

Open from 9.30am to 5.00pm Mondays to Saturdays.
 Delivery of 30 days is available on official orders from PLCs. Hospitals
 and educational establishments, subject to a 5% surcharge.

Please enclose cheque with order. Please allow 10 days for cheque clearance.

International orders welcome!

ata systems

ALBION HOUSE, 1, BACK HILL LONDON EC1
 01-278 3838/01-278 5285 Telex 25102 Albeta G

IBM Software

IBM Pascal Compiler.....	£359
IBM Cobol Compiler.....	£838
IBM Fortran Compiler.....	£420
IBM Basic Compiler.....	£409
IBM Macro Assembler.....	£119
UCSDP - System Pascal.....	£749
UCSDP - System Pascal Compiler.....	£210
UCSDP - System Fortran 77.....	£749
Fortran Compiler 77.....	£210
CP/MC86.....	£287
Visicalc 256K.....	£159
Supercalc.....	£175
Time Manager.....	£108
Volkswriter.....	£146
Easywriter II.....	£229
Wordstar.....	£245
Mailmerge.....	£89
dBase 2.....	£329
Desktop Plan.....	£196
Graph Magic.....	£99
Visitrend/Plot.....	£189
Visidex.....	£166
Visifile.....	£156
Micro-finesse.....	£499

All M.P.S.L. Business
 Accounting Software in stock
 at unbeatable prices, please
 phone for list.

Games

Championship Black Jack.....	£28
Microsoft adventure.....	£42
Deadline.....	£42
Zorks 1 to 3 (each).....	£29

Phone us for a Better Deal

While Stocks Last

Come in & Take Away
Mail Order

We accept both Access
 and Barclaycard subject
 to a 5% surcharge.
 Telephone orders are
 welcome on

01-278 3838

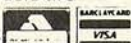

All prices plus 15% VAT
 E. & O.E.

Hewlett Packard 7470A Plotter

RS 232 or HPIB
 Interfaces
 Outstanding Value
 @ £975

Complete range of Desktop Computers in stock



SIRIUS 1

ACT Sirius I 128K with 1.2 mb S/S Disks.....	£2095
ACT Sirius I 128K with 2.4 mb D/S Disks.....	£2549
ACT Sirius I 128K with 1.2 mb D/S Disks and 10 mb Winchester.....	£3995
External 10 mb Winchester Hard Disk.....	£2549
128K Additional Memory.....	£349
384K Additional Memory.....	£795

Software

C Basic 86.....	£159
Level II Cobol with forms 2.....	£549
Microsoft Basic Compiler.....	£239
Microsoft Pascal Compiler.....	£299
Microsoft Fortran Compiler.....	£299
Microsoft Cobol Compiler.....	£439
CP/M Programmers Kit.....	£169
MS 6 Dos Programmers Kit.....	£169
IEEE 488 Package.....	£169
Graphix/Bisigraf Graphics Pack.....	£169
ACT Pulsar Software at unbeatable prices	

commodore COMPUTERS

4016 16K.....	£495
4032 32K.....	£625
8032 32K.....	£799
8096 96K.....	£1075
Super Pet 9000.....	£1345

DISK DRIVES

2031 171K Single D/ Drive.....	£349
4040 343K Dual D/ Drive.....	£625
8050 950K Dual D/ Drive.....	£799
8250 2 mb Dual D/ Drive.....	£1195
9060 5 mb Hard Disk.....	£1795
9090 7.5 mb Hard Disk.....	£2245
C2N Cassette Unit.....	£36

Software prices on application

Please phone for free price list.

Britain's specialists in software London's choice for hardware

Our reputation in software makes us a choice for hardware

Hardware

A copy of our own Autocode 1, the world's leading automatic program generator is given with our compliments for every hardware sale over £1,500



ACT
Sirius 1

Full range of 16 bit machines up to 896K RAM and 10 MB hard disk with CP/M86, MSDOS & Microsoft BASIC from £2396.



IBM Personal Computer

Full range of 16 bit machines from 64K RAM and 700KB floppies. Many expansion cards available. from £2395.

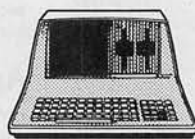

SUPERBRAIN

Full range of 8 bit machines from 330 KB to 10 MB hard disk with CP/M80 & Microsoft BASIC from £1495.

PRINTERS

OKI Microline and Epson. Full range of dot matrix printers from £235.

Daisy Wheel
NEC Spinwriters and TEC
Starwriters from £995,
Feeders & hoods.

HARD DISK SUBSYSTEMS

Corvus range
from £1995
Tape back-up and networks.

INSTALLATION & TRAINING

Consultation, installation and training are available for every system sale.

MAINTENANCE

Full field and factory maintenance contracts are available.

Software

POPULAR SOFTWARE

A wide range of the most popular software packages are available from £125.

SEMINARS

Seminars are held in the heart of London on our speciality, dBase II.

STEMMOS SOFTWARE

We have developed a range of packages aimed at the business and engineering market including the world's leading program generator

Autocode 1

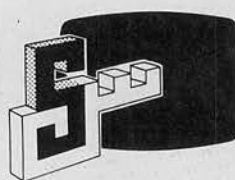

STEMMOS

The Key to successful software

Please send details and full price lists

HARDWARE
 MAINTENANCE
 SOFTWARE
 dBASE SEMINARS

Name _____

Company _____

Address _____



STEMMOS

344 Kensington High Street
London W14 8NS Tel: 01-602 6242
Telex: 893003 STEMOS G

EP4000

EPROM EMULATOR PROGRAMMER



- EP4000 emulates/programs all NMOS EPROMs up to 4k x 8.
- *2564/2764/Bipolar PROMs programmable with adaptors
- 300ns access time in emulation mode
- Editing facilities — data entry, match, display, shift, move, clear, define, block program, etc.
- Input/Output as standard — RS232C (ASCII Hex and binary), 20mA, printer, cassette, parallel handshake and DMA
- Video output for memory map display
- Fully buffered cold ZIF socket
- Price £545 + VAT + £12 delivery
- Ex-stock delivery. Write or phone for more details

2564*, 2764*, 2732A*, 2732, 2532, 2716, 2516, 2758, 2508 2716(3), 2708, 2704

P8000

THE PRODUCTION PROGRAMMER TO HANDLE ALL NMOS EPROMS



- Checks, Programs, Compares up to 8 devices simultaneously
- Handles all NMOS EPROMs up to projected 128K designs with no personality modules of characterisers — See list below
- Easy to use, menu driven operation for blankcheck, program, verify, illegal bit check, checksum, self-test
- Constant display of device type, mode and fault codings
- Individual socket LED indicators for EPROM status
- Comprehensive EPROM integrity checks — Illegal bit check, data and address shorts, constant power line monitoring
- Full safeguard protection on all sockets
- Automatic machine self test routine
- Powered down sockets
- Cost effective price — £695 + VAT
- Available from stock. Write or phone for more details

2564, 2764, 68764, 68766, 68732-1, 68732-0, 2732A, 2732, 2532, 48016, 2716, 2516, 2758A, 2758B, 2508, 2716(3), 2708, 2704

SOFTY 2 2716 EMULATOR PROGRAMMER



- 2716 Emulator/Programmer
- Can program 2532/2732 in two halves
- Multifunction touch keypad
- Editing facilities: Data entry/deflection, block shift, block store, match byte, displacement calculation
- High speed cassette interface and serial interface
- Direct output to T.V.
- Price £169 + VAT

MODEL 14 EPROM ERASERS



- 14 EPROM Capacity
- Fast reliable erase time
- Built-in 5-50 minute timer (UV141)
- Safety interlocked to prevent eye and skin damage
- Convenient slide tray loading of devices
- UV141 available ex-stock £78 + VAT
- UV140, similar to UV141, but without timer £61.50

GP Industrial Electronics Ltd

Unit E, Huxley Close, Newnham Ind. Estate, Plymouth PL7 4JN
Tel: Plymouth (0752) 332961 Telex: 42513 SHARET

ANNOUNCING

The Computer Trade Show '83

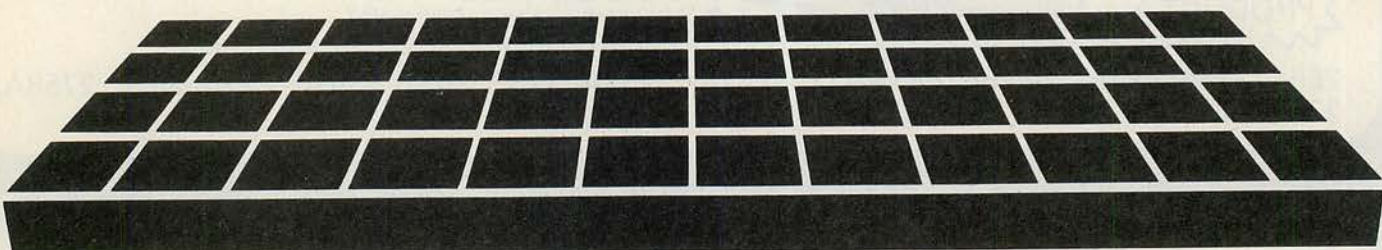

Wembley Conference Centre April 26-28 1983 . . .

. . . will be the most important trade show of the year – it will bring computer manufacturers and suppliers into direct contact with systems and software houses, computer OEMs, dealers, distributors and computer retailers. And no-one is better able to launch the definitive computer trade show than IPC. We know the computer market, publishing journals like Computer Weekly, Systems International and Practical Computing. We organise the computer industry's leading exhibitions: COMPEC and its regional offshoots in Wales, the North and Scotland; COMPEC Europe; The Computer Fair; The Northern Computer Fair; The Midlands Computer Fair; the CAD Exhibition; CAD North, and several others.

What's more, we have the right venue. London and the South East dominate the UK market for sales of computer systems and peripherals, and the Wembley Exhibition and Conference Centre is right in the heart of the region. Get more information about The Computer Trade Show '83 by coupon today or telephone.....on 01-643 8040.



The Exhibition Manager
The Computer Trade Show
IPC Exhibitions Ltd
Surrey House, Throwley Way
Sutton, Surrey SM1 4QQ.

Please send more information on Exhibition stand space

Please ask a salesman to telephone

Name _____

Position _____

Company _____

Address _____

Telephone Number _____



The New British Minstrel FROM **£2,455** with Winchester Drive

Generous Dealer and
Local Authority Discounts

Winchester Drive makes Minstrel the preferred professional Computer

*Read the remarkable specification of this truly professional new British machine,
with unrivalled reliability, versatility, software and support.*

TECHNICAL SPECIFICATION

- Versatile and highly adaptable
- Built for reliability and ease of servicing
- Horizon compatible
- Superlative software: CP/M, MINOS, Turbo-DOS, and multi-user application packages
- British manufacture

CHECK THESE OUTSTANDING FEATURES

Standard system

- S100
- 5-20 Mb Winchester drive
- 64K RAM
- Horizon compatible, 400 Kb – 1.6 Mb floppies
- Z80 Processor

Other Configurations Available

- Multi-user systems
- Multi-processor systems
- 16-bit processor using powerful 68000 processor

Invitation

For more information about the brilliant new British Minstrel computer, or to find out your nearest U.K or European Dealer, write or telephone: Andrew Ward or Tony Harris



Minstrel Hotel Microsystems Ltd. **01-328 8737**
69 Loudoun Road, London NW8 0DQ Telex: 266828

PADA/C - a dream come true

At last a proven, reliable computer software system designed specifically for the professional Accountant.

PADA/C gives you everything you ever needed in a computer system and also links up with the Word Processing package WORDSTAR & MAILMERGE.

£299

INCOMPLETE RECORDS
ACCOUNTING SYSTEM
PLUS -
TIME AND COST
RECORDING SYSTEM

OSBORNE

Available on all microcomputers supporting CP/M 2.2, CP/M 86, and MS.DOS the Padmede range of Business Application software also includes: - Nominal/General Ledger, Purchase/Creditors Ledger, Sales/Debtors Ledger, Sales Invoicing and Stock Control.

Padmede
COMPUTER SERVICES

351 Fleet Road, Fleet, Hampshire. Telephone: Fleet (02514) 21892/3 Telex: 85

For further details of the PADA/C System and the full range of PADMEDE Business Applications
Software please complete and return.
My existing hardware is:

Name _____
Company _____
Address _____
Tel. No. _____
Position _____

LISA IS the long-awaited Apple IV. It is a 16-bit machine, based around the Motorola 68000, as expected, and comes with a 5Mbyte hard disc and 1Mbyte of RAM as well as two floppy-disc drives. But the distinctive thing about the Lisa is the software, which is, as Apple claims, revolutionary.

While other manufacturers try to decide which operating system will become the 16-bit standard, coming down variously in favour of Unix, MS-DOS, CP/M-86 or whatever, Apple has been more radical by doing away altogether with the operating system in the sense of a separate entity the user has to deal with.

Instead, the Lisa comes with a set of application programs covering all the major office tasks, completely integrated in terms of both data compatibility and a consistent command structure. Lisa uses graphics symbols and a special pointing device, the mouse, to simplify control of the system for the user. Additional applications, whether from Apple or from independent vendors, will fit into this overall operating environment.

Details about the Lisa are being announced now though the machine will not be available till the summer. The price will probably be around \$12,000, although lower prices have appeared in the U.S. press without confirmation from Apple. It is unambiguously an office machine, intended for use as a personal tool by professional and business people. In the course of an afternoon with the machine I

APPLE Lisa

The long-rumoured Apple office micro lives up to its promise, reports Ian Stobie.

learnt what it is like to use — which is after all the important thing, especially with this machine — but not much about its internal workings.

What then is the Lisa like to look at? When it is not turned on it looks quite conventional. It is a three-box system, or three and a half boxes if you count the mouse. The keyboard unit is on the end of a

coiled telephone-style cable. The keyboard layout has not been finalised yet, but it will differ between the U.S. and Europe. The U.K. version will probably resemble the ISO standard keyboard used on the new Apple IIe but with the addition of a separate numeric keypad. In any case, changing keyboards is just a matter of plugging in the

(continued on next page)



APPLE Lisa

(continued from previous page)

new unit. All keys are software redefinable.

The system box contains the screen, two floppy-disc drives and the CPU. The screen is exceptionally clear monochrome white on black, with a resolution of 720 by 364 points. Two of the newly designed, Apple-made 5.25in. "Twiggie" floppy-disc drives, each capable of holding 850K, sit next to it. Also in this unit is the 68000, which is a true 16-bit processor offering both a very large 16Mbyte address space, rapid processing and very good interrupt facilities suitable for supporting multi-tasking software. A full 1Mbyte of RAM lives on two boards inside the unit.

The third box is the 5Mbyte Winchester hard disc looking just like the Profile disc used with the Apple III, which is exactly what it is. Of this, 3Mbyte is available to the user. The large amount of software which comes with the system takes up the remaining 2Mbyte.

The mouse is a box about the size of a matchbox on the end of a slim cable leading into the back of the system box. It fits snugly in the hand and has a single large button on it. Underneath the box, a small rolling ball detects movement of the mouse on the table. You use it to move a cursor around the screen, and more particularly to select options, which the Lisa usually presents by displaying graphics symbols on the screen.

The mouse reduces the necessity to touch the keyboard, which speeds things up as well as making using the system more acceptable to European business people for their own personal use. Apple researchers have apparently discovered that, unlike their American counterparts, European executives — with the exception of German ones — consider typing undignified. Apple is also conducting research into voice input, and this will probably be incorporated into the Lisa interface once the technology is available at a reasonable price.

The Lisa environment is an integrated one where words, pictures and numbers can be handled with equal ease. Integration is at the user-interface level, not just at the internal file level. So it is not really adequate to describe the applications Lisa offers as a set of programs — to the user they appear simply as different tasks or jobs within the overall flow of work.

The metaphor Apple employs is that you are working at a desk. Simulated sheets of paper along with other symbols like waste-

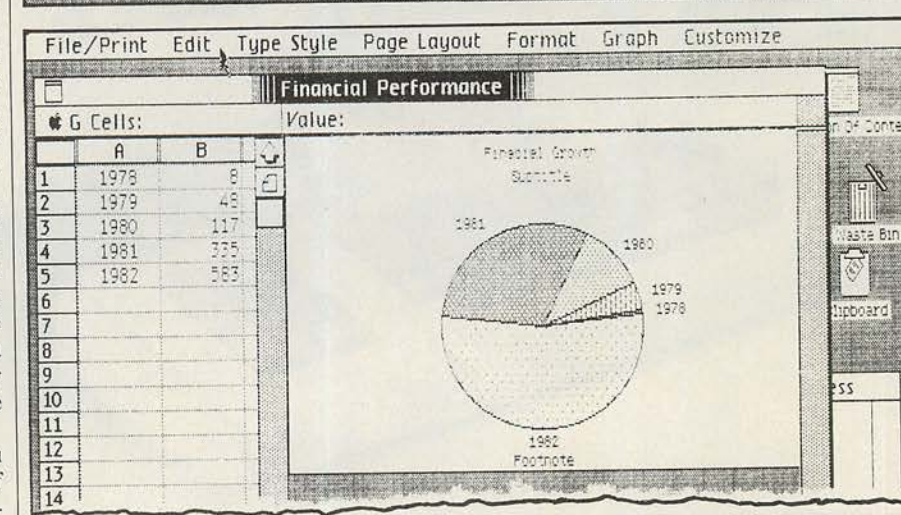
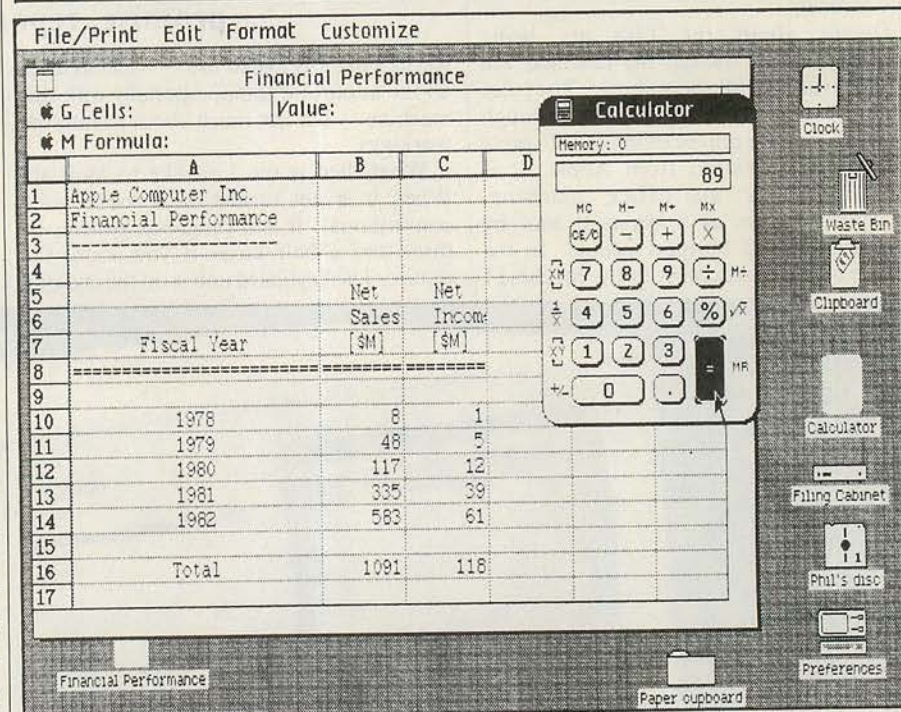
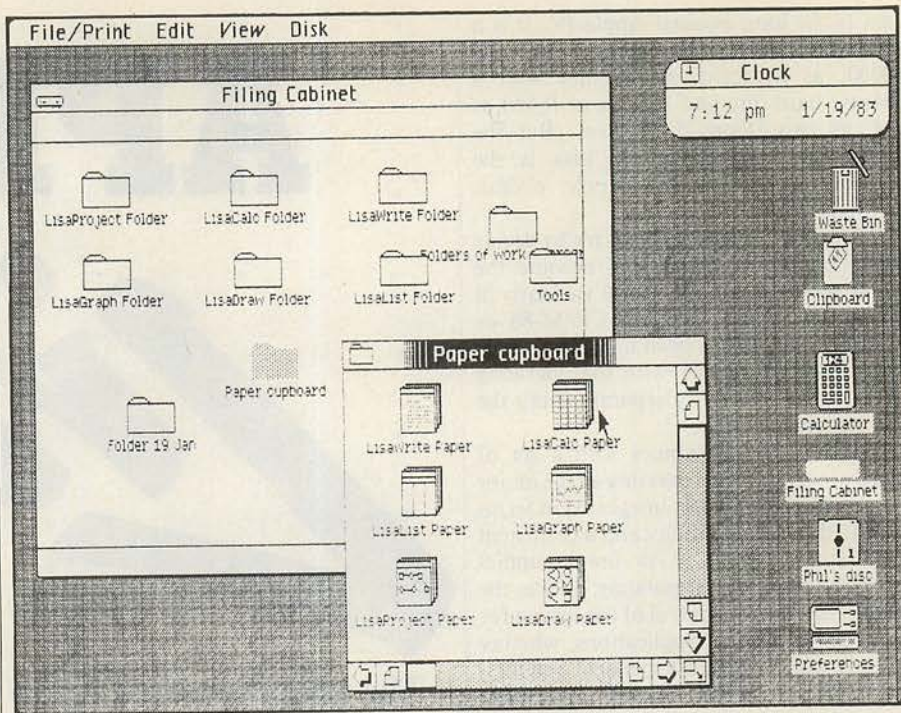

baskets are displayed on the screen. The currently active "sheet of paper" usually appears on top. Since the Lisa is a true multi-tasking system users can swap between tasks as easily as uncovering a piece of paper or taking a new one out of a drawer. In fact these are the precise metaphors employed by the Lisa.

Spontaneous flipping between tasks is encouraged by the speed of the system and the consistency of the command sets used in doing each job. For instance, moving a column when using the spreadsheet involves selecting the same cut, copy and paste options as moving a paragraph when word processing.

Lisa offers solutions to the common jobs which Apple identifies as being the core of the office information worker's task. Incidentally, Apple reckons that half the working population falls into this category, which is one reason for Apple's optimism about the Lisa's future. The tasks are: drawing; writing; calculating; graphing; listing, mailing and filing; project scheduling; and communicating with large computer systems.

For tasks that are not covered here Apple is providing a Pascal development system. It will come with a library of routines to allow the system developer to produce software which integrates smoothly into the Lisa environment, observing the same conventions for consistent handling of the mouse and graphics interface. By the time of launch in the summer, Apple hopes to have the common accounting applications available, produced in conjunction with independent software houses. Basic and Cobol will also be available, but the normal development language for Lisa will be Pascal, which is what the bulk of the Lisa software is written in.

The people at Apple U.K. have tried out the language Smalltalk on Lisa. The whole concept of Lisa's operating-system-free environment and the mouse-controlled desk top simulated in graphics owes a lot to the ideas produced by the Learning Research Group at the Xerox Research Centre in Palo Alto, which developed Smalltalk. This makes comparison between the Lisa software and Smalltalk itself an interesting prospect.

On starting the machine up the Lisa equivalent of a menu appears. Down the right-hand side of the screen is a row of graphics symbols: a wastebasket for rubbish, a clipboard for temporary storage, a picture of the Lisa itself for setting system preferences, a filing cabinet symbolising the main storage, and perhaps a drawer with a name on it for the floppy disc currently mounted.

Placing the cursor over one of the symbols, for instance the filing cabinet, and hitting the mouse button, activates it — or to stick with the analogy, opens it up. If any delay is involved the Lisa changes the cursor to an hour glass. With the Lisa, waiting is always accompanied by a reassuring message of some sort. Error messages are very clear and do not generally stop things dead, although to be honest we only managed to produce an error message in the course of our session

THE SELECTED NAME CAN NOT BE CHANGED

which followed a frivolous attempt to rename the clock. One of the strengths of the Lisa desk-top metaphor compared to an ordinary operating system is that it makes it easy for the user to distinguish between a plausible and an implausible command.

To continue with the same example, opening the filing cabinet brings up a large piece of simulated paper on the screen

showing what is in the filing cabinet. Since we are dealing here with a detailed and carefully worked-out metaphor, instead of data files and programs the filing cabinet contains empty folders, titled folders, a few assorted tools like a calculator and a clock, and pieces of paper. The pieces of paper are of various types and are the way into the powerful application side of the system. There is LisaWrite paper, LisaProject paper, LisaList paper, LisaGraph paper, LisaDraw paper and LisaCalc paper.

Cursoring over the LisaCalc paper symbol and clicking the mouse brings up a sheet of blank spreadsheet paper: we are in the Lisa spreadsheet application. Whatever was on the screen before is not wiped out but simply covered up — it can be seen peeping from behind the LisaCalc paper. So if you want to go back and continue your previous task you can. Nothing is deleted unless you explicitly tell the machine you want it deleted. Even if you hit the Off switch, before powering down the Lisa will save all the relevant data and take a snapshot of the current state of the jobs you were doing; when you switch on again your desk top will be there, exactly as you left it.

If while using LisaCalc or LisaWrite paper you are interrupted and need to do a quick computation, then a few swift mouse movements can get out the calculator, lay it in high-resolution graphics over the top of the LisaCalc or LisaWrite paper, and produce the results. Putting the calculator away — two quick clicks on the mouse with the cursor in the right position — reveals the undisturbed interrupted task.

(continued on next page)

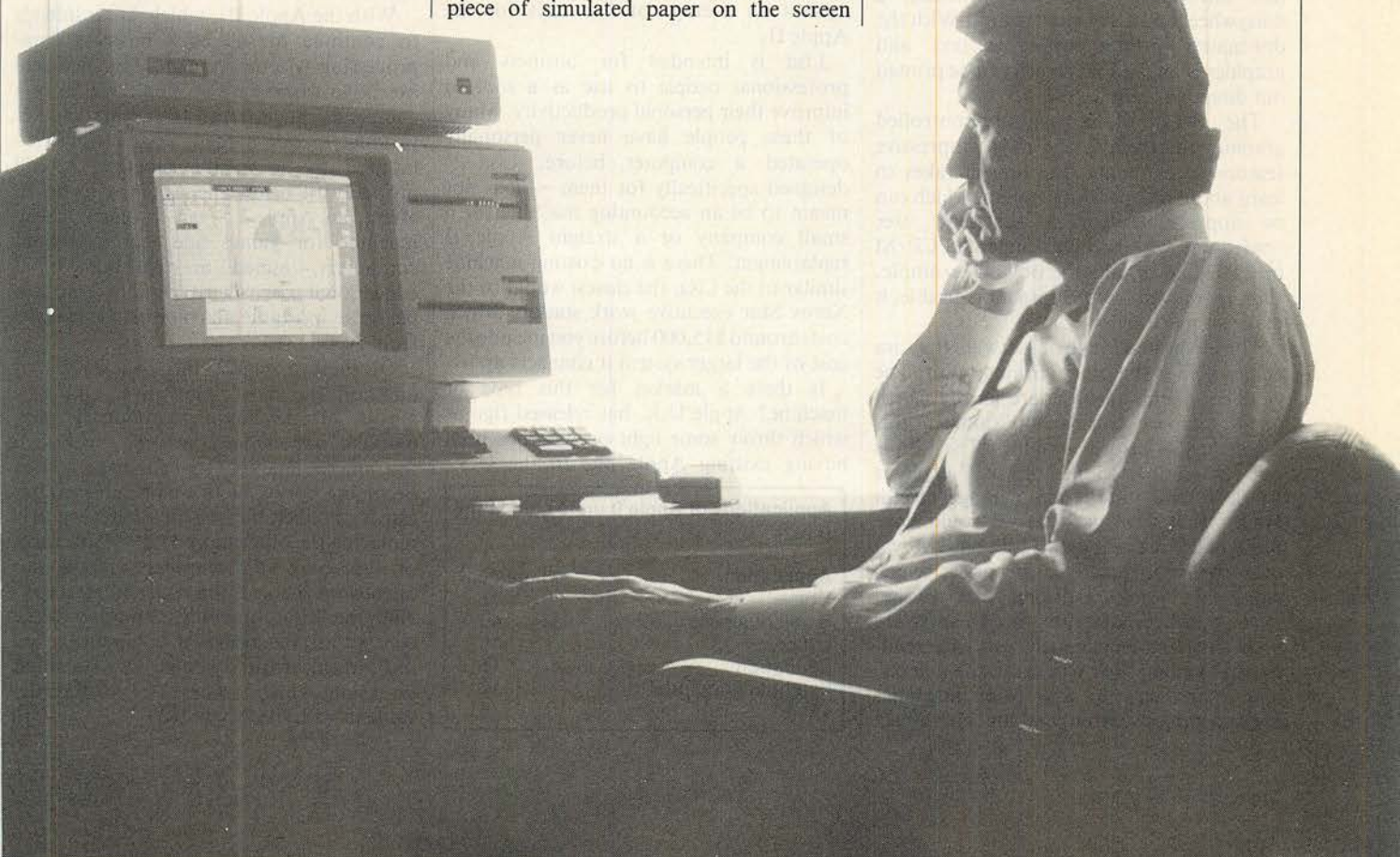

APPLE Lisa

(continued from previous page)

This all explains why the Lisa had to wait for 16-bit technology. It takes a full-feature 16-bit chip like the Motorola 68000 to handle everything that is going on below the user interface in such a truly multi-tasking environment.

From what I saw of it, LisaCalc looks as powerful as spreadsheet programs of the Multiplan type. Keys as well as commands are used in a consistent way so that, for example, Tab and Return produce movement across the spreadsheet paper and down it, just as you would expect after using the same keys for word processing on LisaWrite paper.

The true power of integrated software shows up once you have produced a column of figures. It really is the work of moments to bring out Lisagraph paper, cut and copy a column across and produce, from the range of options available, a pie chart. The chart can then be incorporated into a LisaWrite document, or it could be cut and copied on to LisaDraw paper where further additions and manipulations could be made.

Used pieces of paper can be filed in named folders in the filing cabinet. If untitled they are still saved in a retrievable way, unless thrown in the waste bin. Apple has introduced two new printers, a daisywheel and a dot-matrix unit. With the dot-matrix printer whatever text and graphics is on the Lisa screen can be printed out directly if required.

The Smalltalk-like mouse-controlled graphics interface is the most impressive feature. It eliminates the time it takes to learn about an operating system, which can be appreciable for a first-time user confronted with badly documented CP/M or CP/M-86 to take the obvious example. This not only makes the Lisa more usable, it makes it more sellable.

The integrated range of software the Lisa comes with is the other striking point. The wonders of the hardware are hardly worth mentioning by comparison, and in this Apple has its priorities right. "The Lisa is not just another 16-bit hot box," explains Apple's U.K. marketing manager Keith Hall. "If it was just that we could have brought it out a year ago." Lisa has 2Mbyte of software included in the price, which Apple says it took 200 person years to write.

A number of integrated software products from independent software vendors are making their way on to the market, and if 1982 was the year 16-bit machines and portables started making an impact

then 1983 looks like being integrated software year. Lotus Developments 1,2,3 for the IBM personal computer has received much praise in the U.S., but VisiOn from VisiCalc supplier Visicorp looks like being the closest thing to Lisa's software.

VisiOn also uses a mouse and Visicorp says it will be available this summer too. Without seeing VisiOn in operation it is not possible to say how much Apple gains by being able to optimise code for its own machine. What is clear is that Lisa exists now, and it is impressive. The investment necessary to bring out an integrated-software product must restrict the number of companies able to enter this market.

Although outshone by the software, any 16-bit 68000-based machine from as important a company as Apple — which claims to have sold 750,000 personal computers worldwide — could be expected to have an impact on the micro market. With the Lisa the radical nature of the software approach Apple has adopted makes the extent of this impact difficult to predict.

A very competitive atmosphere is predicted by Arthur Rock, who is a director of Apple, as well as of chip maker Intel. In Apple's annual report he says: "It's crucial to stay ahead of the competition: bring out products that fill different needs, and not just the same needs better." Lisa is an example of this strategy in action.

Lisa fits this description because the integrated software, concealed operating system and mouse-controlled user interface make the system very easy for the first-time user. Apple itself claims an order-of-magnitude improvement in the time taken to set the system up, become familiar with it and have the first practical application running — 20 minutes for the Lisa as against an average of five days for the Apple II.

Lisa is intended for business and professional people to use as a tool to improve their personal productivity. Many of these people have never personally operated a computer before. Lisa is designed specifically for them — it is not meant to be an accounting machine for a small company or a straight Apple II replacement. There is no existing machine similar to the Lisa; the closest would be the Xerox Star executive work station, which costs around \$15,000 before you include the cost of the larger system it connects up to.

Is there a market for this type of machine? Apple U.K. has released figures which throw some light on who has been buying existing Apple kit. In the U.S.,

Applications of Apple II units sold in the U.K.

Application	percent
Home	7
Small business	46
Office	18
Education	11
Scientific/industrial	12
Other	6

Summary spec

Manufacturer: Apple Computer Inc.; made in United States

Price: around \$12,000

System: 5Mbyte hard disc, two 850K floppies, detached keyboard, "mouse" pointing device; high-resolution display, 16-bit Motorola 68000 processor; 1Mbyte of RAM

Software in price: LisaWrite word processing; LisaCalc spreadsheet modelling; LisaList filing and mailing lists; LisaGraph business graphics; LisaDraw general-purpose graphics; LisaProject project scheduling; LisaTerm terminal emulation TTY, DEC VT-100 and IBM 3270 protocols

U.K. distributor: Apple Computer (U.K.) Ltd., Eastman Way, Hemel Hempstead, Herts HP2 7HQ. Telephone (0442) 60244. Available summer 1983.

where disposable incomes are higher, the Apple II sells more heavily to the home market. But the really distinctive feature of the U.K. market is the use of the Apple II as a small business data-processing machine, which is not really using it as a personal computer at all.

This reflects the comparatively large number of small businesses in the U.K. and also their more parsimonious nature. The real unexploited growth area, Apple believes, exists in the office sector. It is represented by only 18 per cent of Apple II sales, in spite of the fact that there are said to be 10 times as many office situations as small businesses in the U.K.

At the same time as Lisa is being announced, the updated version of the Apple II, the IIe, is being launched. Up to now Apple has been virtually a single-product company and Apple IIs are still selling at a rate of 20,000 a month.

With the Apple III, which Apple intends to continue to sell as a business data processing system, and the Lisa, a personal executive work station, Apple will have a complete range. And there is another product, code-named Macintosh, rumoured to be in the pipeline. It will probably fit below the Apple II to be, in effect, an Apple I — an extremely cheap machine for games and learning about computers, aimed at the home and educational user. There does not appear to be a truly portable machine on the horizon from Apple.

Of these machines the Lisa is without question the most innovative, and it is aimed at developing completely new markets for personal computers. Just when the micro market looked like it was becoming boring, with well-engineered but rather predictable 16-bit crates merely replacing the old standard CP/M machines or replacing minicomputers, Apple has opened the whole thing up by taking a risk. And the Lisa forcefully reintroduces the concept of the personal computer as an individual tool, almost a personal extension, which is where Apple originally came in with the Apple II.

'Now the world's most ingenious database program writes letters, you've found the ultimate business solution. And the Delta is a true transactional database – this is the biggest breakthrough for microcomputer users to date'

Nick Horgan, Managing Director, Compssoft Ltd.

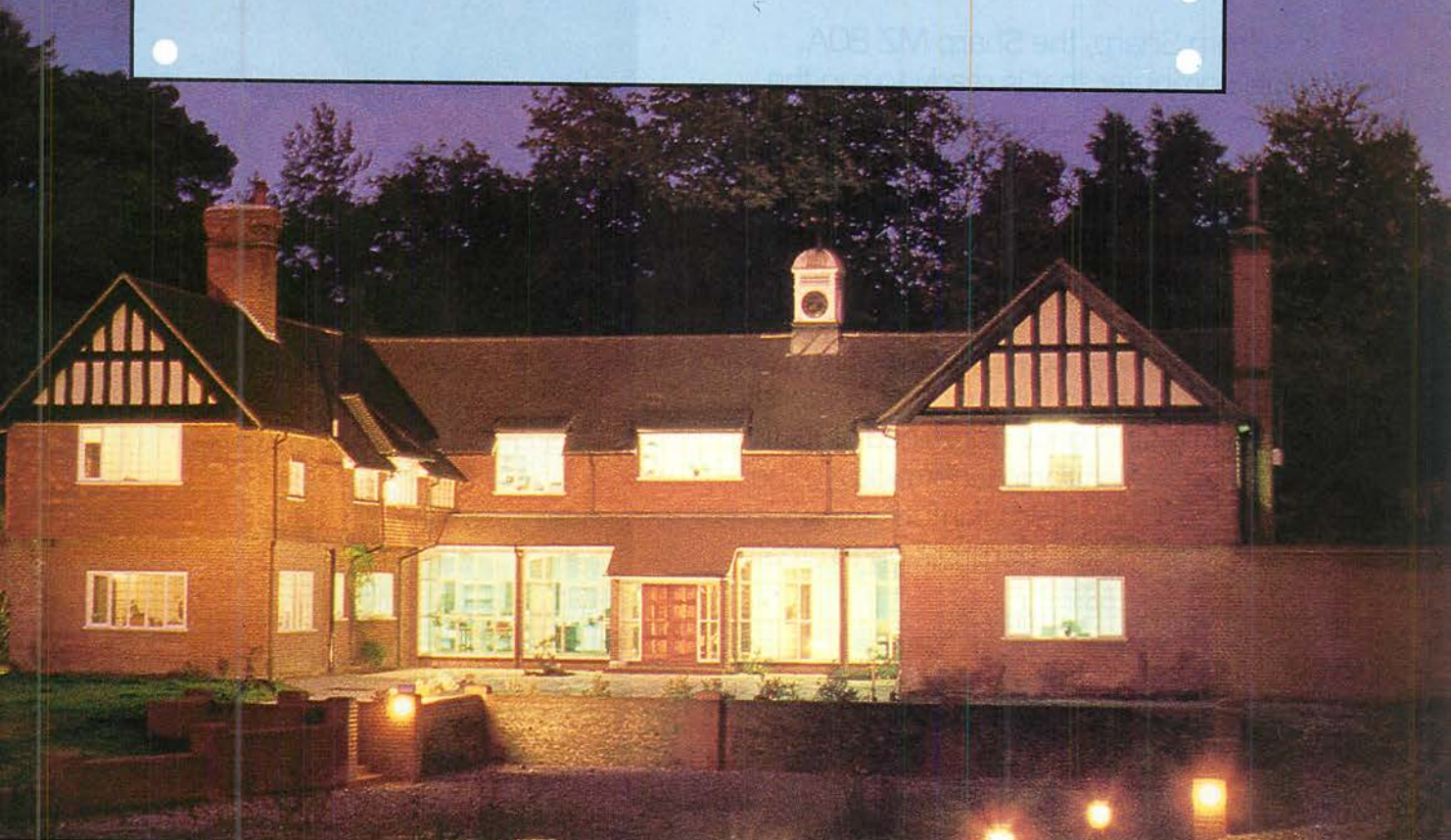

If part of your microcomputer's job is to store information, you need Compssoft's Delta.

Compssoft DMS is already Britain's No. 1 record keeping program. And with 4000 users to our credit, we can honestly say we know more about information storage & retrieval than anyone else. We listen to your comments & requests and now we've produced a world first – the Delta – a true transactional database.

If you'd like to know more, we have general brochures, full technical specifications & free

guides to DMS handling a multitude of business situations from order processing, invoicing & stock recording, through to library, personnel & hospital record management.

Find out more about the database revolution. Either telephone the office or clip the coupon now.

Compssoft's Delta – taking microcomputers into the third dimension.

Compssoft Limited

Hallams Court

Shamley Green

Nr Guildford, Surrey

England GU4 8QZ

Telephone: Guildford (0483) 898545

Telex: 859210 CMPSFT

● Circle No. 171



Please send me further details

Company

Contact

Address

Tel No.

THE DESK TOP GENIUS.

Now from Sharp, the Sharp MZ 80A. A personal computer that is ready to run the moment you own it. Because the CRT display, the typewriter-style keyboard and the cassette-based data storage are all integrated into one complete system that leads the operator, either amateur or professional, into an incredible new computer world.

For this computer has the power to do virtually anything within the range of Personal Computers. In it, Sharp has combined all its fine electronic technology in the field of information engineering to create



*MZ 80FB
Twin Mini Floppy Disc Unit.*

*MZ 80P6
Character Graphic Printer.
Also available MZ 80P4 and MZ 80P5*

a marvel of precision. Plus, when you purchase you get a valuable software package absolutely free.

The superb Sharp MZ 80A. Among its competitors, it is rated as a genius. To you, it will become a desk-top companion you will treasure, an invaluable part of your daily life.

Bringing to your school, office or home, the high-speed skills and advanced technology of the world of Sharp. Where great ideas come to life.



Specifications MZ 80A

CPU	Z 80
Memory	4K-byte ROM; 48K-byte RAM; + 2K-Video RAM.
Display	9 inch (23 cm); 40 characters x 25 lines Green screen.
Cassette	Manual control; standard audio cassette tape. Data transfer (Sharp PWM system) 1,200 bits/sec.
Keyboard	ASC11 keyboard; upper-/lower-case alphabet; graphic symbols; numeric keypad.
Other features	Built-in clock and music function. Auto repeat on all keys. 2-page video RAM (allows the screen to be scrolled up and down). *CP/M available.
Options available	Tape based Pascal Interpreter. Tape based Machine Language package. Sharp FDOS including BASIC compiler. Tape based Z-80 Assembler package.



Computer Specifications	Optional Printers		
	MZ 80P4	MZ 80P5	MZ 80P6
Printing method	Serial impact dot matrix		
Printing method	Variable sprocket; Friction	Variable sprocket	Variable sprocket; Friction
Number of characters	230		
Character make-up	9(W) x 8(H) dot matrix (normal-size characters)		
Number of digits	136/68 per line 160/80 per line	80/40 per line 136/68 per line	
Printing speed	150 cps (normal-size characters)	80 cps (normal-size characters)	
Print sweep direction	Bi-directional		
Other functions	<ul style="list-style-type: none"> • Software-controlled full graphic function • Programmable number of lines per page • Battery-operated memory of HOME position (MZ 80P4 only) 		

Prices and specifications subject to change without notice.

Floppy Disc Unit (MZ 80FB)

Two drives per unit; 5.25" dual-sided, double density; 70 tracks; soft-sectored; 16 sectors per track.

Memory capacity 280K bytes per diskette.

To: Sharp Electronics (UK) Ltd, Computer Division, Sharp House, Thorp Road, Newton Heath, Manchester M109BE. Tel: 061-205 2333.

Please send me details of the Sharp MZ 80A

Type of application: _____

Name: _____

Address: _____

Tel No: _____

The world of
SHARP
 where great ideas come to life.



*CP/M is a trademark of Digital Research Ltd.

LYNX

Despite its unassuming appearance Camputers' new micro promises CP/M capability for under £500. Bill Bennet tested it out.



THE LYNX MICRO sits on a fence: it does not know if it is a home computer or a "serious" computer, and this dilemma is reflected in its £225 price tag. It sits at the top of the home-computer price range but it is probably too cheap for business computer users to take it seriously. What they should take seriously is the fact that the Lynx is more powerful than the Apple II and about half the price.

Just who is going to buy the Lynx is not yet clear. It would be an ideal machine for the classroom but unfortunately it is not yet on the official list for educational buyers. The Lynx is also an ideal machine for someone who suspects that they need to find out about computers today, and may need a proper computer at a later date.

Although the casual observer can be forgiven for thinking otherwise, the Lynx is certainly more than a toy. It can quite quickly grow into a fully fledged CP/M system, and you will not have to pay the earth for that either.

There are four main components to a CP/M system: a Z-80 or 8080 processor, 64K of user memory, a floppy-disc unit and the CP/M systems disc. The first comes as

standard in the Lynx, which uses the Z-80A running at 4MHz. The Lynx comes with a standard 48K of memory but it can be extended in steps of 64K up to a total of 192K.

Although the standard memory is 48K, this cannot have been in the original design spec as some of the RAM within the case is on a board marked "memory exp". The first stage of memory expansion takes the total RAM size up to 96K — more than adequate for a CP/M system. Expanding the memory size above 128K gives the added advantage of still higher resolution than standard or a possible 80-column display width.

A floppy-disc unit is the component which is most frequently the barrier between home computing and serious processing work. Until recently it could not be crossed without the user shelling out a small fortune, but this has now changed. In the same way that scaled-down microcomputers became much cheaper during 1982, mass-storage devices will be less expensive in 1983.

The Lynx disc unit should be available later this year. It will be a single-sided,

single-density unit at the knock-down price of slightly under £200. It will only be capable of storing 150K on each disc, which is not very much and means that at least two drives will be required for any work that involves a lot of files.

At around £500 for a CP/M machine, the Lynx is a formidable micro. What makes it particularly useful is the way that the system can be put together piecemeal, as the user's needs and budget allows. Lynx users will not need to scrap their machine because they have grown out of it, or at least not straight away.

Once the CP/M Lynx is up and running the user can begin to amass a collection of software and data which is not wasted since it can, if necessary, be transferred to another CP/M machine. Thus the Lynx offers the curious but potentially serious micro user a growth route that avoids waste. For the same reasons the Lynx would be ideal for schools and educational establishments. Users who just want to play games will also like the Lynx's facilities.

Anybody already acquainted with a low-priced home computer will appreciate the

Lynx's keyboard. It is probably the best keyboard available in its price range, with a typewriter-like central section and the usual special keys arranged around this core and marked in red. What I liked most about the keyboard was the unclutteredness — none of those horrible graphics characters printed on the side of the keys, or unreadable orange keywords above them. One fault is that a key depression is sometimes not noticed by the machine.

The quality of the keyboard, together with the ability to run CP/M, means that the Lynx can form the basis of a cheap and yet fairly efficient word-processor system. For example, a full WordStar system could be yours for about £550 plus the cost of a printer. There is to be a special Lynx printer, though it could in no way be considered as a letter-quality one: it will sell for under £100, and print in ink on tally-roll paper.

Users who are a little more fussy about print quality will be able to hook up the printer of their choice via the non-standard RS-232 output on the rear of the case. Rather than use a standard RS-232, the Lynx uses a DIN socket. The signals present are RS-232 in, RS-232 out and zero volts. The manual hints, on page 53, that if you want to hook your own printer up to the Lynx you might have to spend an evening soldering components together to build an interface. Having tried this in the past, it is not something I would recommend.

On the whole, the manual supplied with the review machine was adequate, and I understand a new one is being written. The main flaw is the lack of examples; concepts are explained fairly well, but they are not put into any context by example programs. It is nothing like as useful as the Sinclair Spectrum manual, which includes just about every piece of information the user could wish for.

Basic is the language used by the Lynx, a fact which will surprise no one. Forth will shortly be available and should be of great use to those interested in exploiting the excellent graphics available on the micro. I would also like to see Logo added to this list.

Lynx Basic is fine, but it has some odd quirks. The most annoying is that a variable name can only be a single character: a maximum of 52 variables is available using

both upper and lower-case characters. This limitation seems to be at variance with the structures included within Lynx Basic; after all, what is the point of including program structures that make a listing easy to read when the variable names are so cryptic?

The structures themselves are certainly welcome. As a full convert to the concept of named procedures I found the automatic indentation showing the program control very useful. However, debugging programs is made more difficult than it should be by the way the screen scrolls. Unlike most micros, the Lynx returns to the top of the screen when it has reached the bottom. If a program is longer than 24 program lines it will write the 25th line over the first.

Editing is also organised in a way that is different from just about every other microcomputer. To remove a line you must type in Del. The command has a similar format to List: that is, typing

DEL 100,200

will delete all those lines from 100 to 200. There is a Trace facility which can be switched on or off, listing all the program lines as the control reaches them. It is even

possible to slow down the operation of a program by using the command Speed which will delay the computer between each program line. The Line Edit mode is entered by typing either Control-E to edit a specified line, or Control-Q to edit the last line.

In addition to procedures Repeat-Until and While-Wend are available to satisfy the structured programming lobby, and they are welcome commands. The old favourite Gosub-Return is included too, of course. The Pause command is one that is appearing on a lot of micros these days. Its effect is to stop the computer from actually doing anything for a specified length of time.

Every computer claims high-resolution graphics on its specification. The Lynx has higher-resolution graphics than any other micro in its price range, and what's more it is capable of mixing all eight of its colours on screen at the same time. Nominally resolution is 248 by 256 pixels, but a memory expansion allows a resolution of 248 by 512.

(continued on next page)

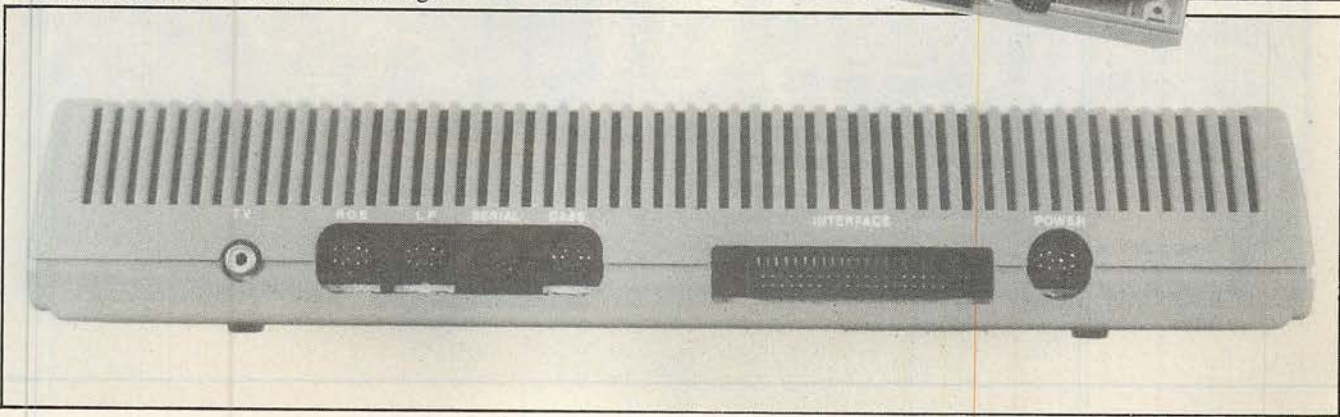
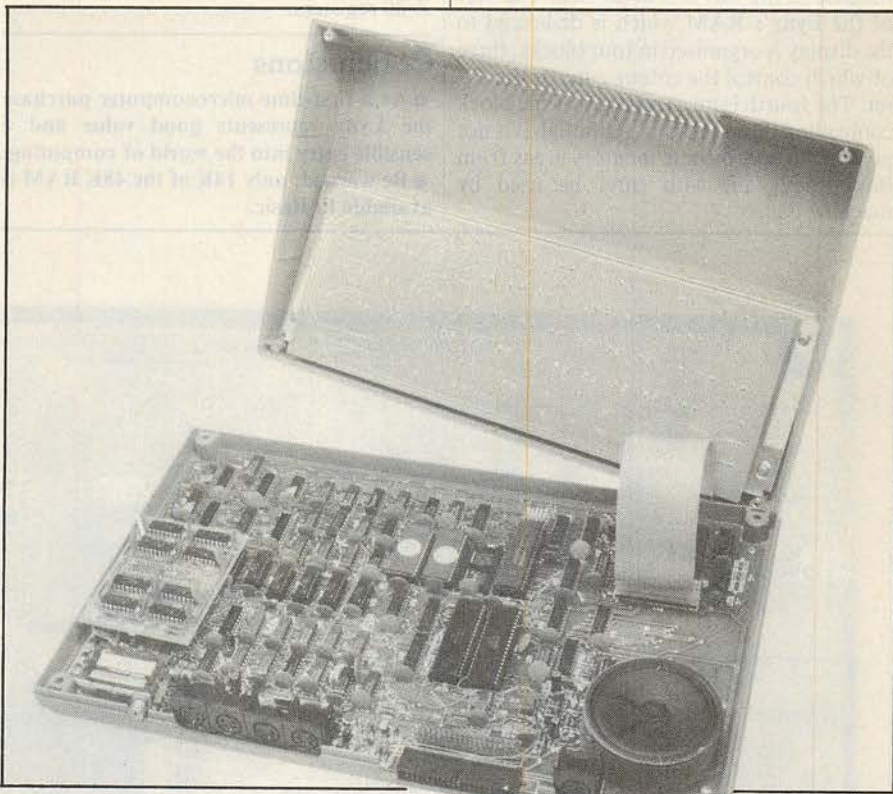

LYNX

(continued from previous page)

There are a number of features of the Lynx's graphics ability that are extremely powerful. My favourite is the way in which you could write Ink Red to write in red and Paper Green to write on a green background.

Printing characters on the screen in the normal way is easy enough, but there are some novel optional methods too. For example, a text string can be printed in any colour, and a VDU command makes it possible to overwrite existing text. By using the special Print@ command you can print a text string at any one of 120 by 240 points on the screen, a facility that can be used to print subscripts and superscripts.

Printing and using the Basic high-resolution commands are the only ways of creating displays with the Lynx. It is not possible to Peek or Poke the screen memory because of the way it is organised. The 32K of the Lynx's RAM which is dedicated to the display is organised in four blocks, three of which control the colour guns of the TV set. The fourth is an extra copy of the block controlling the green gun. Although it is not possible to access these memory areas from Basic they can, with care, be used by machine code.

The Protect command will make it essentially impossible to change the contents of a particular memory. For example, Protect Red freezes the memory controlling the red gun. Nothing else can be written in Red and everything already written will remain.

Designing a custom character set is rather fiddly, though rewarding. It is possible to play around with the cursor should you ever get bored with the flickering square. You can even designate a particular area of the screen to be the text window.

From Basic there is not much that can be done as far as making music is concerned. All there is to play with is a Beep statement, though the Sound command will send bytes from memory straight to the Lynx's six-bit sound output. The output is in turn connected to a loudspeaker, which is too quiet for my taste but will appeal to those people who jump at the sound of video games.

A machine-code monitor is included as standard and will be of real use to Z-80 machine-code programmers. It includes a front panel which displays the status of the Z-80 registers.

Conclusions

● As a first-time microcomputer purchase the Lynx represents good value and a sensible entry into the world of computing.

● Be warned, only 14K of the 48K RAM is available to Basic.

● The Lynx Basic has both strengths and weaknesses: arrays of more than one dimension are not possible without the user resorting to confusing programming gymnastics.

● The real keyboard and CP/M potential make the Lynx a serious micro, and the sound and high-resolution colour graphics make it a fun micro as well. □

Processor: Z-80A

Speed: 4MHz

Memory: 16K ROM; 48K RAM of which 32K manages the display

Keyboard: QWERTY standard-pitch typewriter-like keys

Display: 40 x 24 characters as standard; 80 x 24 on expanded machine
248x256 pixels standard; 248x512 pixels on extended machine
eight colours which can be resolved to a single pixel.

Sound: Internal speaker, accessed by Beep command from Basic, or directly from machine code; includes a six-bit digital-to-analogue converter

Language: Computers Basic, plus a machine-code monitor

Cassettes: User-defined baud rate; Verify command; will work with most recorders.

Ports: UHF TV; RGB + sync; composite video, mono monitor and light-pen; RS-232 serial port; cassette port; parallel expansion port.

Dimensions: 65x215x345mm.

Manufacturer: Computers Ltd, 33a Bridge Street, Cambridge CB2 2UW

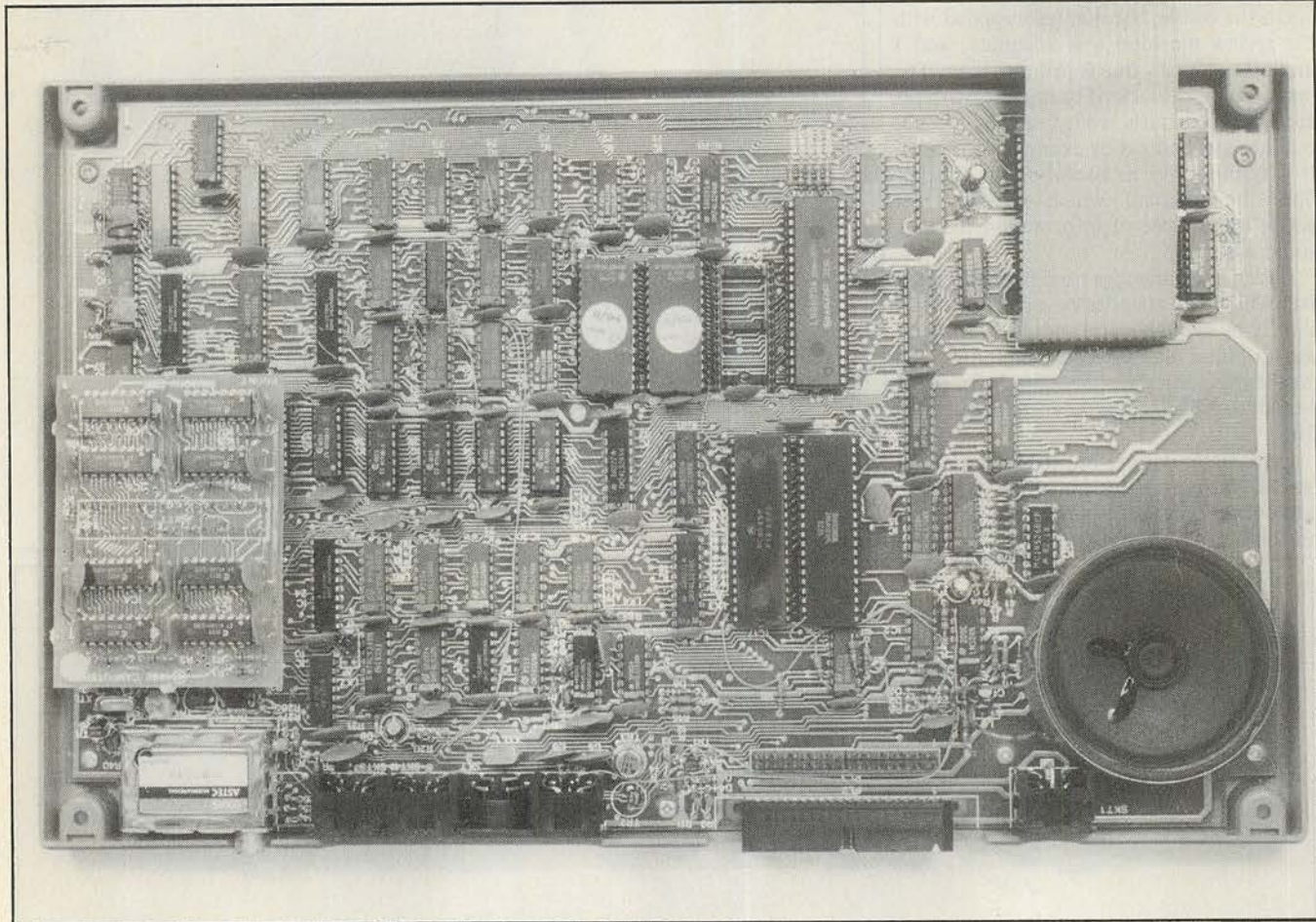

FUJITSU SP-830

Speed, simplicity and ease of maintenance are keys to the design of this daisywheel, reviewed by Chris Bidmead.

ZYGAL DYNAMICS grew up as U.K. distributor of the Diablo range of printers, but at the beginning of last year Zygald took on board a rival daisywheel from Japanese mainframe manufacturer Fujitsu. What at first made the Fujitsu SP-830 so attractive was its speed, although initial claims of 80 characters per second have been somewhat toned down to the current advertised figure of 70cps. As you will by now have realised, the brochure rate for daisywheel printers is not the same as the real-life speed, so no one will be very surprised that our bench tests show the printer as performing some 30 percent slower than the quoted figure.

Nevertheless the machine is fast, and its speed in the graphics test was particularly impressive. The key to this, which also promises increased reliability and maintainability and other such good things, is the simplicity of its drive mechanism, which makes the pulleys and wheels of the traditional approach look like something out of the middle ages.

All that drives the print head backwards and forwards across the page is a helical groove in the horizontal support bar. The support bar rotates under direct control of the linear motor, so a pin projecting from the underside of the print head is driven laterally. Imagine a bolt being rapidly and repeatedly screwed into and out of a nut, where the bolt is fixed laterally and the nut is not allowed to rotate, and you will have a

Motion minimisation is excellent.

picture of how the transfer of motion works.

You may also have some idea of the forces of friction involved. Friction is the one big hazard here because any wear in the groove will quickly manifest itself as character misalignment. A sloppy fit can be expected to accelerate the wear as the smooth, sliding action deteriorates into a savage hammering between the oversized walls of the groove.

Perhaps this explains why until recently we have only seen this elegant driving method used in dot-matrix printers, where character alignment is possibly regarded as less critical. Is Fujitsu compromising with quality? On the basis of practical experience

the answer is definitely no. I used the machine extensively during the test period, and even after a couple of months the alignment was still as good as ever.

Fujitsu has obviously put a lot of careful thought into this crucial pressure point, and the solution is as elegant as the main idea. The rotating helix is a solid bar of case-hardened steel and the pin is a softer metal deliberately designed to wear preferentially. It saves the bar in much the same way that hawthorn needles save precious 78s. To avoid slop the pin is tapered, as is the cross-section of the groove. The pin wears, the

(continued on next page)

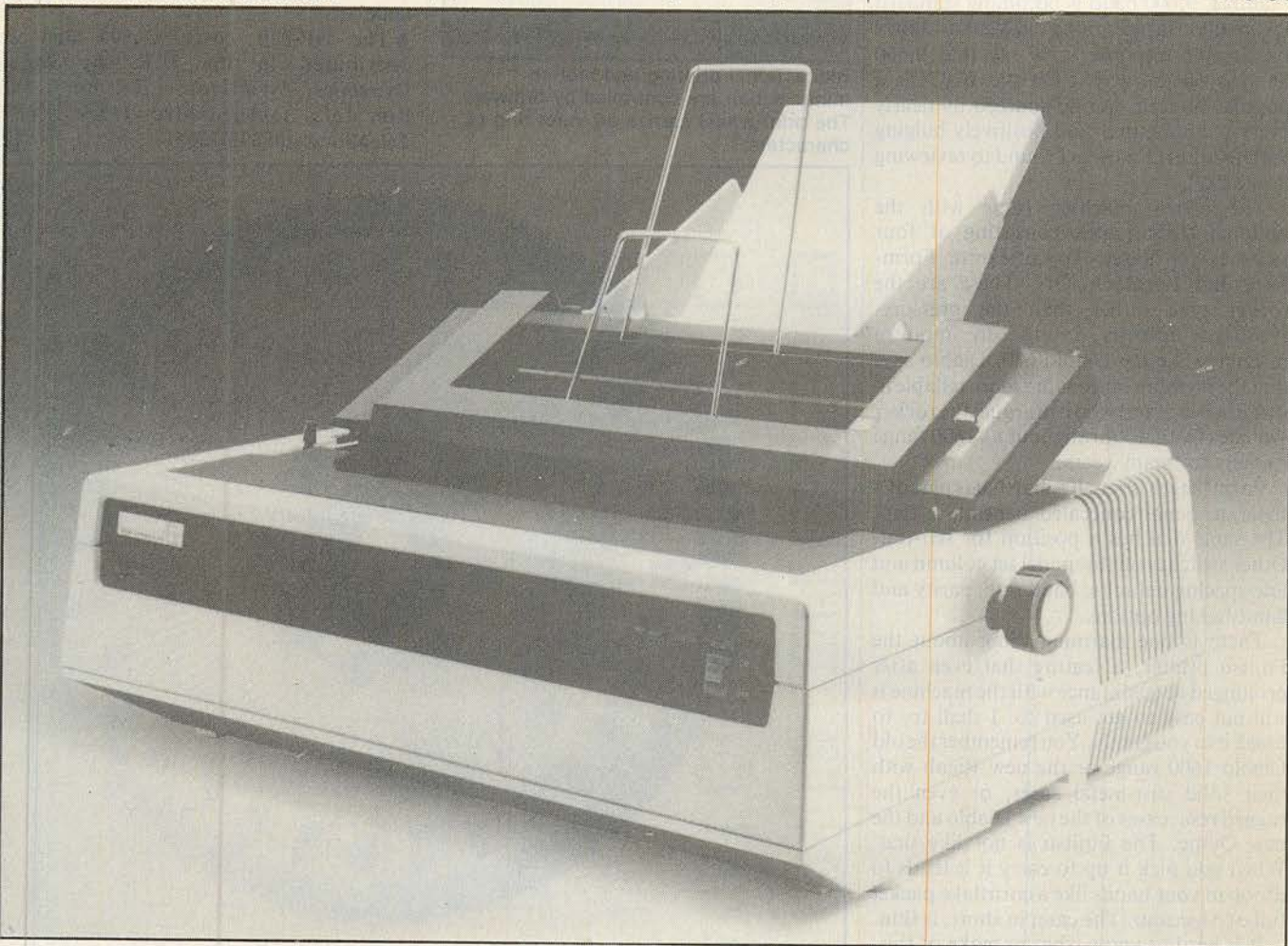

(continued from previous page)

spring-loading at its base forces it into the taper, the fit is maintained. After a year or so you simply replace the pin.

The print head itself has been pared down and with the ribbon removed there is nothing to obstruct it from being unlatched and pulled back through almost 90 degrees, which makes print wheel changing very simple. The print wheel itself is full of interesting possibilities; while being fully compatible with the Diablo standard it is also capable of carrying an additional inner ring of characters, bringing the total character set up to 127. Accessing these characters implies a shift mechanism in the print head, something like the famous Ricoh dog-bone, but unfortunately the review machine came without this feature.

Judged by the standards set by machines like the Flowriter the buffer is small, although adequate to support full bidirectional printing. Motion minimisation is very good indeed, as the formatted-text test shows — see table. The interface is RS-232 with provisions for XOn/XOff handshaking or hardware handshaking on the DTR line. ETX/ACK is not catered for, which is a pity.

More serious is the fact that the top speed is 1,200 baud. No daisywheel printer can steadily keep up with this data rate so there is no great loss of throughput here. It is really more a matter of having the flexibility to match a wide range of host speeds — for example, 9,600 baud is becoming standard in many installations. Zygals fairly predictable response is to say that 9,600 baud is on the way. "On the Way" is a popular product second-sourced by nearly every manufacturer and positively bulging with features. I must get round to reviewing it one day!

The review machine came with the optional front panel, consisting of four switches for Reset, Top-of-Form, Form-Feed and Local On/Off. These are the rocker type rather than the pressure-sensitive buttons found on modern machines like the Diablo 630. Diablo says that the pressure buttons are more reliable in sustained use, and who can argue: the rocker switches featured throughout its 1600 range printers for many years.

Form length is set on a dial that is part of a separate panel concealed beneath a flap. The same dial has a position for self-test. Other switches on this panel set column and line-spacing defaults, baud rate, parity and handshaking options.

There is one alarming thing about the Fujitsu printer, a feature that even after prolonged acquaintance with the machine is still not easy to get used to. I shall try to break it to you gently. You remember the old Diablo 1600 range or the new Ricoh with their solid cast-metal cases, or even the rugged resin cases of the new Diablo and the new Qume. The Fujitsu is not like that. When you pick it up to carry it it tends to droop in your hands like a cornflake packet full of Meccano. The case, in short, is thin.

It is hard to know what to make of this.

Benchmark tests for standard and formatted text, tabbing and graphics.

Test	Time	Comments
Standard text	1min. 15s.	About 48cps. Certainly the fastest daisywheel printer we have tested to date
Formatted text	36s.	Motion minimisation is excellent
Tabbing	35s.	Good alignment, not quite up to Diablo standard
Graphics	4min. 5s.	Very fast for RS-232 interface

There is, of course, nothing pansy about those flimsy Japanese apartment blocks built to flex with the earthquake: they remain standing when the bricks and mortar around them have been reduced to rubble. While the Fujitsu is sitting on a work surface going about its lawful business the case is perfectly adequate. In fact the ABS-like plastic it is moulded from is surprisingly strong. But so, I'm afraid, is my prejudice against anything floppy not spinning in a disc drive.

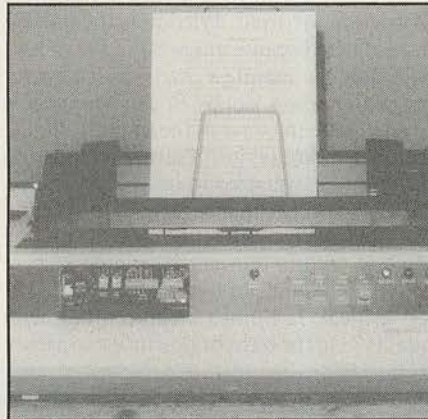

Bidirectional printing and motion minimisation are controlled by firmware. The print wheel carries an inner ring of characters.

Conclusions

- The Fujitsu daisywheel printer is a fast, low-noise machine with a well-implemented helical drive to move the print head.

- This novel technology, for a daisywheel, is another step in the process of simplification of the moving parts and should result in fewer and less costly repairs.

- Firmware helps speed up the machine by bidirectional printing and motion minimisation.

- An "outer casing minimisation" exercise has also been carried out in production. The plastic material is tough but flexes dramatically when you carry the machine or lift the front cover. This in no way degrades the performance of the machine, in fact the manufacturer would probably argue that the money has been spent where it matters — on the print mechanism. But it certainly challenges one's British prejudice that if machine is worth building it should be built like a tank.

- The SP-830 costs £1,500 and is distributed in the U.K. by Zygals Dynamics, Zygals House, Telford Road, Bicester, Oxfordshire OX6 0XB. Telephone: (08692)3361.

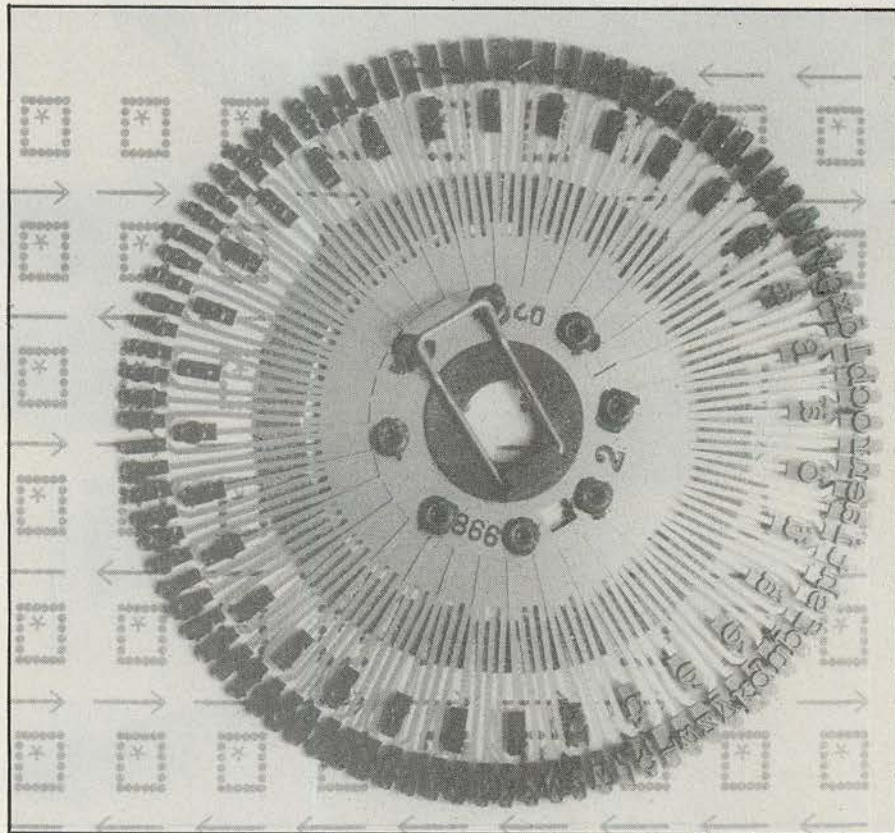

THE WORLD OF

BOS

BUSINESS OPERATING SOFTWARE

Choosing the right software... is the first and most important decision you have to make when choosing a computer.

Choose BOS, and you're choosing the most advanced business software for micro and mini computers available today.

BOS Reliability... BOS software has been tried and tested for over four years with 1000's of satisfied users all over the world—small firms, big businesses, DP departments, schools, accountants, doctors, solicitors and government departments. BOS software provides that assurance of maturity and reliability which no new software can hope to match.

BOS Portability... Now, for the first time, you can change or upgrade your computer and avoid the costs of software conversion. BOS software is equally at home working in single-user, multi-user or local networking mode and the unique BOS concept allows identical software to run on over 50 different computers including Apple II, Casu, Comart Communicator, DG Enterprise, DEC PDP-11 range, DMS 3/4, Durango, Equinox, IBM Series/1, IBM Personal, ITT 3030, MicroFive, Onyx, Panasonic, Northstar, Pertec, SD, Sharp PC3201, Sirius, Sord 223, Systime 500, Tandy TRS-80, TI model 1/2/4, Transdata, Trivector Triton 4, Triumph Adler 1600 range, Victor 9000.

BOS Quality... Designed and built in Britain by top software professionals and accountants for use by British business, there is a fully integrated range of BOS software to match all your business needs.

Choose from:—

- BOS Sales Ledger
- BOS Invoicing
- BOS Purchase Ledger
- BOS Nominal Ledger
- BOS Inventory Control
- BOS Payroll
- BOS Fixed Assets
- BOS AutoWriter
- BOS AutoIndex

BOS Nationwide Support... BOS software is written by MPSL, a world leader in microcomputer technology, and supplied and supported by over 50 selected independent BOS dealers throughout the country.

Remember, when you choose a computer, what you get out depends on the software you put in. So choose the best—choose BOS.

THE RIGHT SOFTWARE CHOICE

I'd like to know more about BOS software, BOS dealers and BOS compatible computers.

Name _____ Title _____

Company _____ Address _____

Telephone No. _____

Please return to David Blandford, Sales Director, MPSL, 87-89 Saffron Hill, London, EC1. Tel: 01-831 8811.

• Circle No. 173

PC 4

How to make work like a

First, neatly cut out the "370" label.

Now, when nobody's looking, nonchalantly tape it to your terminal, just under the "IBM," as if it really belonged there.

Then wait for your chance and quickly slip a dBASE II™ disk into your main drive.

That's it.

Your IBM Personal Computer is now ready to run a relational database system, the kind that IBM has on their mainframes. And you're ready with more data handling power than you would have dreamt possible before dBASE II.

You'll wonder how you managed without it.

You'll find that dBASE II, because it's a relational database management system (DBMS), starts where file handling programs leave off. dBASE II handles multiple databases and simplifies everything from accounting to department staffing to monitoring rainfall on the Upper Volta.

With a word or two, you CREATE databases, APPEND new data instantly, UPDATE, MODIFY, and REPLACE fields, records and entire databases. Organize months worth of data in minutes with the built-in REPORT. Do subfield and multi-field searches, then DISPLAY some or all of the data for any condition you want to apply.

And you've just begun to tap the power of dBASE II.

Easy to look at, easy to use.

Input screens and output forms couldn't be easier—just "paint" your format on the screen



and what you see is what you'll get.

You can do automatic calculations on fields, records and databases, accurate to 10 digits.

And you can use dBASE II interactively for answers right now. Or save your instructions, then repeat everything with two words: DO Manhours, DO Project X, DO whatever has to be done.

Use dBASE II to help make your choice:

Instead of just poring over a manual, you can check out dBASE II by running it on your own system free for 30 days.

your micro mainframe.



Visit your dealer and run through a hands-on demonstration. Then buy a package and use it on your IBM PC, Sirius or CP/M computer. If you don't like it, return it and you'll get your money back, no questions asked.

But if you do that, you'll have to remove that label. Because nothing short of a mainframe works like dBASE II.

For the name of your nearest dealer, contact one of our distributors: **Encotel Systems** 01-686 9687. Ferrari Software 01-751 5791. Interam 01-675 5325. Pete & Pam (0706) 227011.

Ashton-Tate

dBASE™

©1983 Ashton-Tate
dBASE II is a registered trademark of Ashton-Tate
CP/M is a registered trademark of Digital Research

● Circle No. 174

Computerise without compromise



The new All British QUANTUM 2000 computer system is outstanding among all the fine microcomputers now on the market. The explanation is simple. All microcomputer designers see Versatility on a high scale as their aim for the future. In the QUANTUM 2000 this ideal has actually been achieved, therefore it is demonstrably more advanced than any other.

QUANTUM 2000 offers every feature experts would look for in a new high technology 2.2 CP/M based microcomputer *plus* an

expansion potential which a few years ago would have required planning permission.

What QUANTUM means by Versatility:

1. Available with 1, 2 or 3 disk drives.
2. Disk drives can be 400K or 800K floppies OR
3. 5 or 10 meg. Winchester OR
4. A mixture of floppy and Winchester.
5. 192K of extra RAM can be added, in addition to the standard 64K.
6. If the standard Centronics plus RS232 ports are insufficient, just plugging in a board adds a few more.
7. IEEE 488? No problem! Plug in a card.
8. Other expansion cards available:
 1. REAL TIME CLOCK
 2. SPEECH SYNTHESIS
 3. NETWORKING (UP TO 32 TERMINALS)
 4. HIGH RES COLOUR
 5. A/D — D/A CONVERSION

Quantum QM 2000



Computing on the train

Ian Stobie tests Sony's Typecorder, a portable text processor, and looks ahead to a forthcoming word-processing package running on the Epson HX-20.

THE SONY TYPECORDER is a simple but nonetheless useful machine. It combines the functions of a dictation machine and word processor into a single portable package for use either just with a printer or linked into a larger office-wide system.

The basic Typecorder itself weighs just over 3lb. and has a full typewriter-style keyboard with a good touch-typing feel and a single-line 40-character upper- and lower-case LCD display. It is as compact as the full-sized typewriter keyboard layout allows, and an A4 sheet of paper will cover it completely. Four AA-sized batteries or their NiCad equivalent provide for about 5 hours of heavy use. It is, as claimed, a practical portable machine.

Sony avoids explicit reference to word-processing in its literature and has kept the whole thing deliberately simple. Nonetheless, being a regular user of word-processing kit, at first I did not like the Sony Typecorder. It is not very sophisticated compared to most of the word-processing packages that run on general-purpose microcomputers, and I found the editing features it offers too limiting. Sony provided a U.S. model for review and in the couple of months I had it I came to find the machine very useful.

What first changed my initial impression were the tape-recording functions of the machine. The Typecorder uses a built-in microcassette drive to hold both stored text and voice, and can be used like a conventional dictation machine. The equivalent of about 50 pages of A4 single-spaced text fits on each side of a C60 cassette or, obviously, about 30 minutes of speech.

The Typecorder comes with a neat microphone/controller and an earphone, and has a built-in speaker. You can record notes on a tape and subsequently type them into the Typecorder, which is more spontaneous than using a separate recorder and having to take it into the large, crate-like Research Machines 380-Z on which we normally run WordStar. However, for a finished article WordStar still scores as the Typecorder has severe limitations as a word processor.

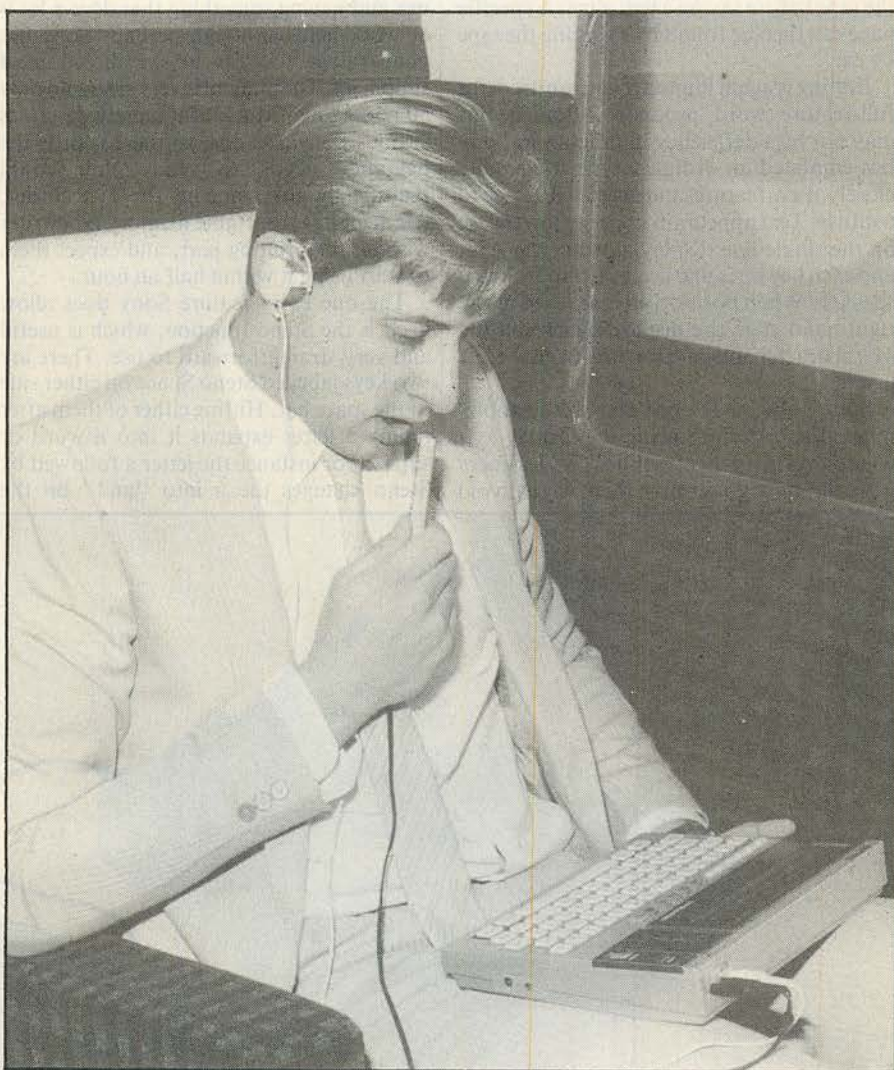

The Typecorder stores voice as well as keyed-in text on its built-in cassette.

The Typecorder comes with 2K of RAM — not very much by the standard even of a modern home computer. Sony does not say what CPU is used, and the machine is not user programmable in any way. The functions it comes with are the functions you get. Some 1,800 characters of the 2K memory space are available to the user for text storage, allowing about one A4 single-

spaced page to be dealt with at a time.

To use the Typecorder you switch on and start typing. After typing a page's worth you save it on to tape, which takes about 35 seconds and wipes memory, and then continue with the next page. Everything proceeds strictly on a page-by-page basis, so to edit an earlier page you have to load it

(continued on next page)

Computing on the train

(continued from previous page)

back into memory. The contents of memory are lost when the machine is turned off. Half-finished pages must be stored on tape at the end of a session.

There is no provision for saving named files — you have to keep track of what you have placed where yourself. The current tape position can be displayed on the LCD by holding down the Code key and typing S, but this helps no more than a conventional tape counter would. In a short document written sequentially this is not much of a problem, but it is still useful to record a name and date using the microphone on to the tape before saving a text page. A specific page can then be found by scanning the tape by ear.

Editing is again limited if you are used to a full-feature word processor, though this may not be a deficiency in practice as Sony has emulated an ordinary typewriter quite closely. Few features means few features to confuse. Text appears in upper or lower case on the single-line display as you type it in, and each key hit is marked by a blip from the speaker. When position 40 is reached at the right-hand edge the display clears and the 41st character appears, starting from the left again.

Sony obviously prefers this simple-minded approach to using the display as a window on to a wider text line. The designers generally have gone out of their way to avoid

alarming users with the wonders of technology, even when a wonder or two would really be quite welcome. Character delete and insert functions are provided on function keys, along with backward and forward scrolling, one 40-character line at a time.

There is no find and replace facility and no block move or other block operations, but they would not be found on a typewriter either and within the limits of a single A4 page you would hardly need them. Left and right margins can be set, the maximum line width being 80 characters, but paragraphs cannot be reformatted once typed in. Page size is restricted to 66 lines or 1,800 characters, whichever occurs first.

Although its limitations are all too obvious, the machine is still useful. The well-known trade-off in the computer world between having something that is easy to use and having something that does a lot is at work here, although perhaps Sony has gone rather too far in the direction of simplicity. The manual is very clear and only 50 pages long. Much of it merely describes various Sony add-ons, so there is little the beginner needs to read. You could realistically give someone the Typecorder, tell them it is a portable memory typewriter without the printing part, and expect them to start using it within half an hour.

The one extra feature Sony does allow itself is the Steno function, which is useful and very straightforward to use. There are two keys labelled Steno Space on either side of the space bar. Hitting either of them after typing a letter expands it into a word or suffix. For instance the letter a followed by Steno changes the a into "and" on the

display, be becomes "been", c "can", and so on.

If the letter is at the end of a string of characters the Typecorder will generate suffixes automatically. For instance if you type in "capa" and hit the Steno key i expands to "capable", b as in "capab" becomes "capability" and c as in "glac" becomes "glacial". Steno will also expand symbols to the equivalent word, so % becomes "percent", 0 becomes "zero", 1 becomes "one". The character strings Steno associates with each key are not user-definable but fixed so this glossary feature is limited, but it is nonetheless a useful frill.

Having used the Typecorder for text entry and for recording speech, the next thing you will want to do is print. Within the overall price, Sony provides a second unit called a Compact Printer. It is a rather heavy unit — about twice the size of the Typecorder itself — and mains powered, so it is best left for use at your base.

It will print on to ordinary typing paper or headed notepaper, but works rather better with its own glossy paper. The technology employed is a thermal print head pressing against a film ribbon and appearing to melt characters on to the paper. Ribbon cassettes are one shot only but easy to change. It was difficult to persuade the paper to stay straight, but once used to the thing the results were of good quality for the price — somewhere between dot-matrix and daisywheel quality.

There is no provision for using continuous stationery, but single-sheet operation is alright for letters and short documents like CVs. The Typecorder itself operates only on a page-by-page basis, so



The Typecorder's plain-paper printer is housed in a separate unit and uses a thermal print head.

each page of a long document has to be loaded into memory from tape, a process that takes about 30 seconds before it can be printed. Neither the printer nor the Typecorder itself is very suitable for longer documents. This article, for instance, extends in typescript to 15 double-spaced pages and is beyond the Typecorder's useful scope.

Sony provides other output options, including a communications/printer interface box, which has a Qume-compatible parallel and an RS-232C interface, fitting most dot-matrix and daisywheel printers. A number of other add-ons are available in the United States. The slightly comical electric typewriter actuator fits over the keyboard of an IBM-style typewriter and uses solenoids to thump the keys. There is also a paper-tape punch and an acoustic coupler available in the States.

More important for Sony's prospects in the large company fleet-sales market is the ability to transfer Typecorder files to larger Sony Series 25 word processors. This permits the Typecorder to become the portable part of an office-wide system, not just a stand-alone unit for personal use.

Is the Sony worth buying? If you want the recording facilities or plan to link to other word processors in the Sony range, the answer is yes. As a stand-alone device it is neat and simple, especially for the computer innocent. The more sophisticated *Practical Computing* reader buying out of his or her own pocket might prefer a more flexible and programmable machine.

By the time Sony starts selling in the U.K. there may be more machines with portable word-processing capacity to choose from, apart from the heavier and more expensive machines in the Osborne I class. The word-processing package being written for the Epson HX-20 will make an interesting comparison with the Typecorder. Several more expensive machines intended primarily for portable word-processing use, like the Teleram, may make it across the Atlantic this year.

The Sony does not look like being alone in this market. It is very simple, but if this is what you want or perhaps need, then as an aid to personal productivity I think the Typecorder probably does work.

Because of changes in requirement for portable terminals Sony will be probably making significant improvements to the Typecorder before it is introduced into the U.K. According to Kevin Melia, U.K. spokesman for Sony Communications System Division, redesign will result in a

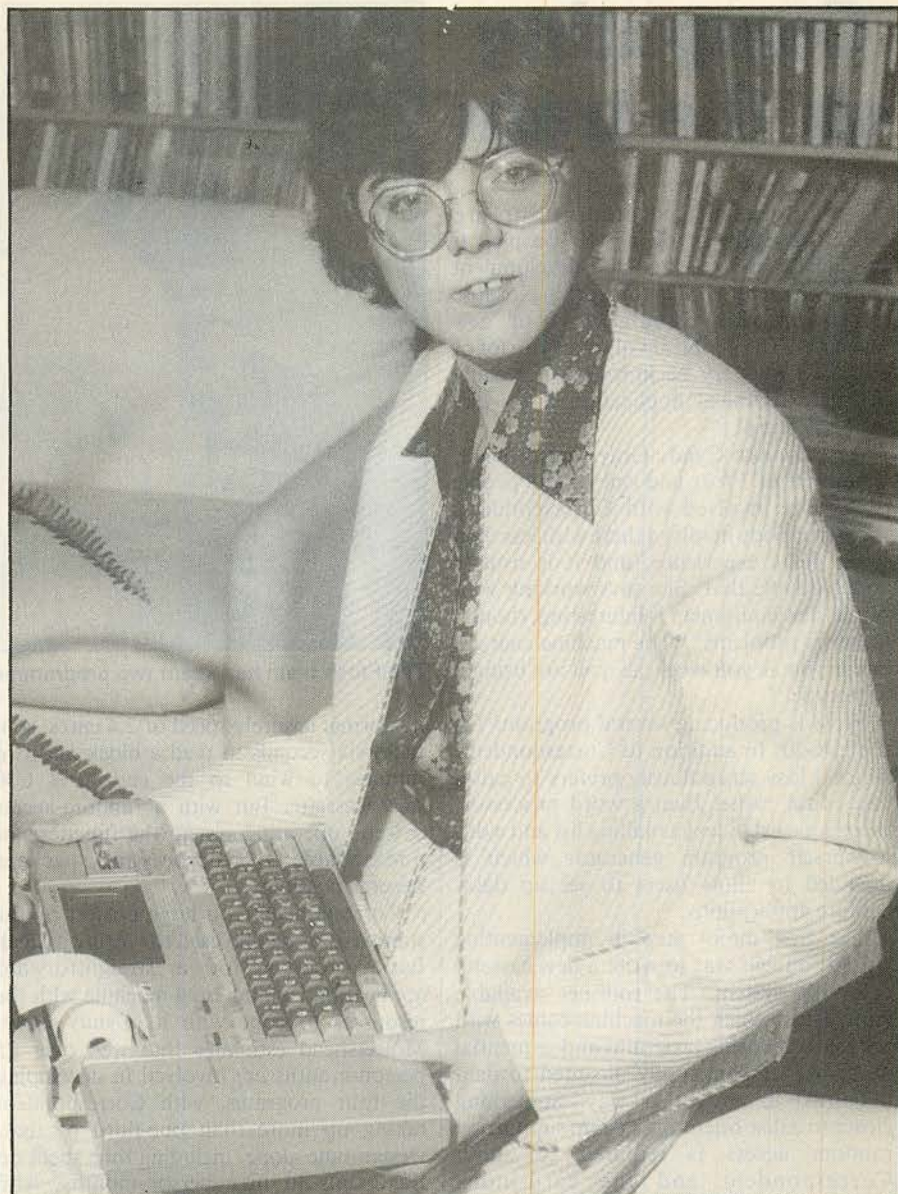

Ffoss chairman Cyndy Gray-Mottershead: "We know what we want."

machine which will be both cheaper and more capable.

The Sony Typecorder is not ambitious in terms of the word-processing features it offers the user. But software has to be designed to fit the constraints imposed by the hardware it will run on. How do you fit word processing of any kind on to a small portable machine, without discs and with limited memory? Ffoss Ltd, a software house based near Maidenhead, is currently writing a word processor to run on the portable Epson HX-20, providing an interesting example of what is involved.

The design problem is determined by the

environment. The standard Epson comes with 16K of RAM, around 13.5K of which is available to the user. It has a built-in microcassette drive, capable of holding about 100K to 120K on a C30 cassette, and a built-in 24-column printer, although for word-processing use it would probably be connected to a full-size printer like the Epson MX-80. Text is displayed on the HX-20's built-in 20-character by a four-line liquid crystal display.

Ffoss has decided to use the Epson expansion unit to make a little more elbow room. It costs about £80, so it will not add too much to the cost of a reasonably good word processor which people might be prepared to spend up to £200 for if it works. The expansion unit provides another 32K of memory, which can be divided up in various ways between RAM and ROM. Ffoss has opted for 24K ROM for the code and 8K RAM. Together with the 13.5K in the main unit Ffoss has a reasonable amount of memory to play with, provided the designers know what they are doing.

(continued on next page)

Typecorder specification

Manufacturer: Sony
Where made: Japan
Description: portable word-processing and dictation machine with matching printer
Size: 280 x 216 x 44mm.
Weight: 1.4kg.
Batteries: four AA or equivalent, giving about 5 hours continuous use
Power: 6V DC; AC adaptor provided

Display: single-line 40-character liquid crystal, 160 by 14mm.

Keyboard: full-size QWERTY layout, with six function keys and six tape-control keys

Price: probably around £750 for system comprising Typecorder with 2K RAM, built-in microcassette drive, rechargeable batteries and AC power adaptor, and separate A4 plain-paper Sony Compact Printer

Computing on the train

(continued from previous page)

Ffoss is a small, independent software house currently involving 10 people. It specialises in research-and-development work, which often calls for working in close association with manufacturers of new machines. The people involved have a lot of computer-industry background, especially in fairly technical application areas like process control.

According to Cyndy Gray-Mottershead, Chairman of Ffoss and one of the people principally involved with Correspondent, there is nobody involved there with less than seven years experience, and it is usually about double that. She says working with brand-new equipment is interesting, though it has its problems: "The machine changes under you as you work, as you are using a prototype."

Ffoss is producing several programs for the HX-20. In addition to Correspondent, which Ffoss scrupulously prefers to call a text editor rather than a word processor, there is a card index, a mailing list and a do-it-yourself program generator which is intended to allow users to set up data-capture applications.

The first major step in implementing Correspondent was to write a new cassette operating system. The routines available from Basic which the machine comes with are fine for storing programs and sequential data, but fundamentally ill-suited to data organised in any other way. Something closer to a disc operating system supporting random access is required for both Correspondent and the card-index program.

Rax, the new cassette operating system written by Ffoss, takes up 6K of the available space. It works by formatting the tape into blocks of 256 bytes and setting up a series of directories to keep track of where a particular named file physically resides on the tape.

The layout of blocks on the tape is not straightforward. There is a series of directories, and Rax is more complex than the typical small microcomputer disc operating system. According to Cyndy Gray-Mottershead, the magnetic recording surface of tape is not as well-behaved as disc blocks tend to move around as the tape stretches. In practice Ffoss has had considerable problems to cope with, and has had to delve into the depth of the hardware to implement Rax.

Rax allows the user to forget about how the tape is organised and to operate simply with named documents. Documents can be named, renamed and deleted, altered in size and copied into other documents, all of which would be impossible with the standard cassette operating system.

Using tape is still slow. The tape travels at



The Ffoss team has spent two programmer-years developing software for the HX-20.

its normal leisurely speed of 2.4 cm/s. so it takes six seconds to read a block and two minutes to wind to the end of a C30 microcassette. But with a random-access cassette operating system the functions of a reasonable word-processing package become possible.

Correspondent is a large project by the standards of people used to writing a quick Basic program for a straightforward application running on a machine with the resources to cope with it. Cyndy Gray-Mottershead estimates that well over 25 person-months are involved in developing the four programs, with Correspondent taking up more than one-third of that. Design time alone, including time spent on Rax, runs to nine person-months, with several different people involved in the work.

This development time is being expended principally to save memory. Everything is written in assembler, which takes longer to write but allows you to optimise for space. The 6301 CMOS processor chip used in the HX-20 has a very similar instruction set to the Motorola 6800, and Ffoss has written modifications to a 6800 assembler. Development is done on a larger disc-based system, and once the code is assembled it is downloaded to the HX-20 for testing.

All space available on the machine is grabbed by Correspondent. The HX-20 has five variable-sized program areas, allowing up to five applications to be held in memory simultaneously. But they must be saved to tape before running Correspondent, which needs all the space itself. With a word processor you want as much of the document as possible to be in RAM to avoid having to swap it backwards and forwards to your storage device; with a slow medium like tape it is even more important. Correspondent is able to store the equivalent of three A4 pages of text in the 12K work area.

Correspondent has the normal editing functions of inserting, deleting and moving text, together with the kind of search and replace, block move and copy operations found on reasonable word processors. The Epson HX-20 function keys are used to specify command scope, and the arrow keys move you around the document. The HX-20 20-character by four-line screen is at present treated as an 80-character line, not as a window into a larger virtual text area, although Ffoss is assessing both methods to see which users prefer.

The 24-column built-in printer is used as a preview printer for portable use. Initially Correspondent will work with the Epson MX-80 printer for full-size output, supporting all its facilities like condensed, underscore and double-strike printing. The printer is controlled by commands which are embedded in the text like WordStar dot commands, to specify things like page length and top and bottom margins.

Some features have not been finalised. Some provision to merge names and address from the mailing-list program into Correspondent documents is planned, but whether it will go as far as the ability to embed variables from the list files into the body of the text is not decided. As Cyndy Gray-Mottershead says: "We know what we want, what the user specification is. It's how much we can get into the machine."

Correspondent looks like being an interesting product, pushing a small portable computer like the HX-20 into new applications well beyond the super calculator range. Ffoss is a specialist in writing software, and the results of its efforts will be sold through Epson. But the scale of the effort involved in developing it demonstrates that portables are not toys. Writing programs for small machines is not simple — it can be more difficult than writing for big ones. □



The box is not always black ...

At Rair we're continually enhancing and upgrading our Black Box microcomputer range to meet the ever-changing, ever-growing needs of our customers.

That's why you'll often find our systems turning up under different names, different colours – not always black.

Our current Black Box range includes 8- and 16-bit microprocessors, that can be configured from simple

single-user floppy disk systems right up to powerful multi-user systems with Winchester hard disks and tape backup.

So next time you're choosing a microcomputer for a new application, remember to call us first.

With Rair, you can have any colour you like, including black.

RAIR

United Kingdom RAIR Limited 6-9 Upper St Martins Lane London WC2H 9EQ Telephone (01) 836 6921 Telex 298452

France RAIR Sarl 90 Avenue Champs Elysées 74008 Paris Telephone 010 331 225 4401 Telex 290177

West Germany RAIR Computer GmbH Clemensstrasse 5-7 5000 Köln 1 Telephone (0221) 219811 Telex 8881915

United States RAIR Microcomputer Corp. 4101 Burton Drive Santa Clara CA 95050 Telephone (408) 988-1790 Telex 677038

• Circle No. 176

COMMODORE 700 SERIES

THE BUSINESS COMPUTER

80-column display; 128K or 256K user RAM expandable to 896K, tilt and swivel screen. 8088 or Z80 second processor capability giving option of other operating systems such as CP/M. Built-in DMA disk-drives available. IEEE-488 and RS232C interface capabilities.

FROM

£995

EX VAT

*Registered Trademark of Digital Research Inc.

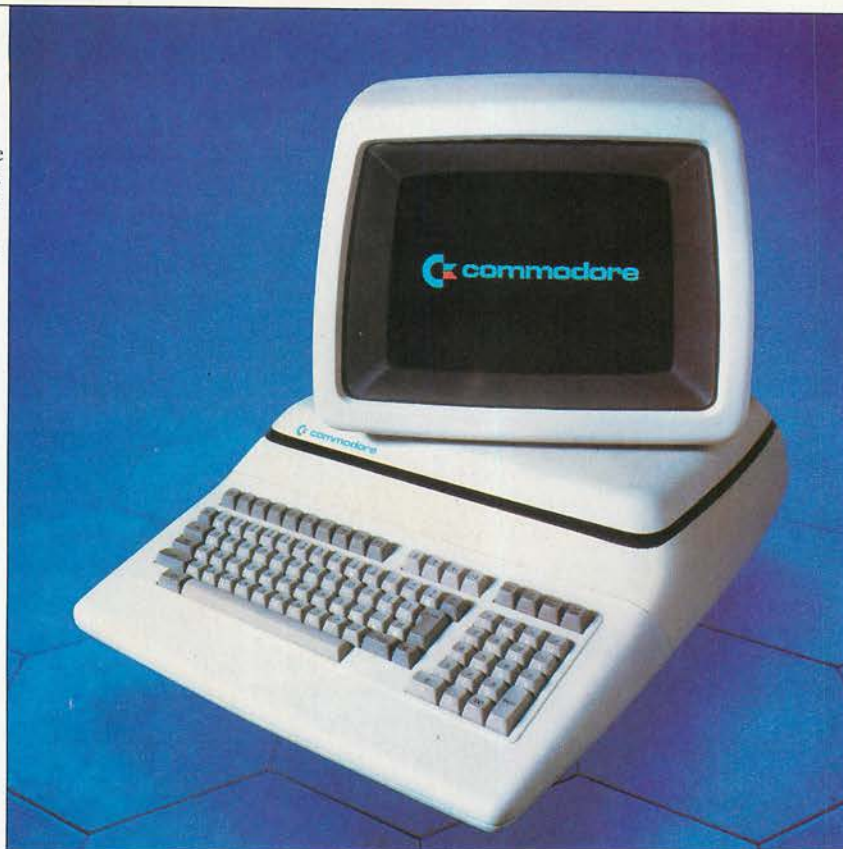

WEST COUNTRY

Avon Business Computers Ltd.
(Formerly Calculator Service and Sales (Bristol) Ltd)
192 Wells Road, Bristol, Avon BS4 2AX
Bristol (0272) 779452/3

Currys Micro Systems Ltd.
2 Channons Hill, Fishpond,
Bristol, Avon BS16 2EA
(0272) 650501

Radan Computational Ltd.
19 Belmont, Lansdown Road,
Bath, Avon BA1 5DZ
Bath (0225) 318483

A. C. Systems,
6 Cathedral Lane, Truro,
Cornwall TR1 2QS
Truro (0872) 79727

J. M. Computer Services Ltd.
14-15 Lemon Street, Truro,
Cornwall TR1 2LS
Truro (0872) 71626/70071

A. C. Systems,
53 Magdalen Road, Exeter,
Devon EX2 4TA
Exeter (0392) 211718

A. C. Systems,
75 Mutley Plain, Plymouth,
Devon PL4 7DS
Plymouth (0752) 260861

**J.A.D. Integrated Services
Plymouth Ltd.**
21 Market Avenue, City Centre,
Plymouth, Devon PL1 1PG
Plymouth (0752) 662616

Devon Computers,
The White House, 39 Totnes Road,
Paignton, Devon
(0803) 526303

**South Coast Business
Machines Ltd.**
South Coast House, Wimborne Road,
Ferndown, Bournemouth,
Dorset BH22 9NG
(0202) 893040

Computer Shack Ltd.
14 Pittville Street, Cheltenham,
Glos. GL52 2LJ
Cheltenham (0242) 584343

Milequip Ltd.
7a Hare Lane, Gloucester GL1 2BA
Glos. (0452) 411010

**Somerset Business
Computers,**
25 East Reach,
Taunton, Somerset
(0823) 52149

Computacenter Ltd.
Theatre Square,
Swindon Wiltshire SN1 1QN
Swindon (0793) 612341/2

Whymark Computer Centre,
20 Milford Street, Salisbury,
Wilts. ST1 2AP
(0722) 331269/26688

3 great deals.

COMMODORE 500 SERIES

THE SCIENTIFIC/ PROFESSIONAL COMPUTER

40-column 16-colour display to monitor or TV. 128K user RAM expandable to 896K. High-resolution graphics and 3-dimensional effect capability. Sound synthesis.

Second processor option. Prestel facility available.

8-bit parallel port to interface scientific equipment.

FROM

£695

EX VAT

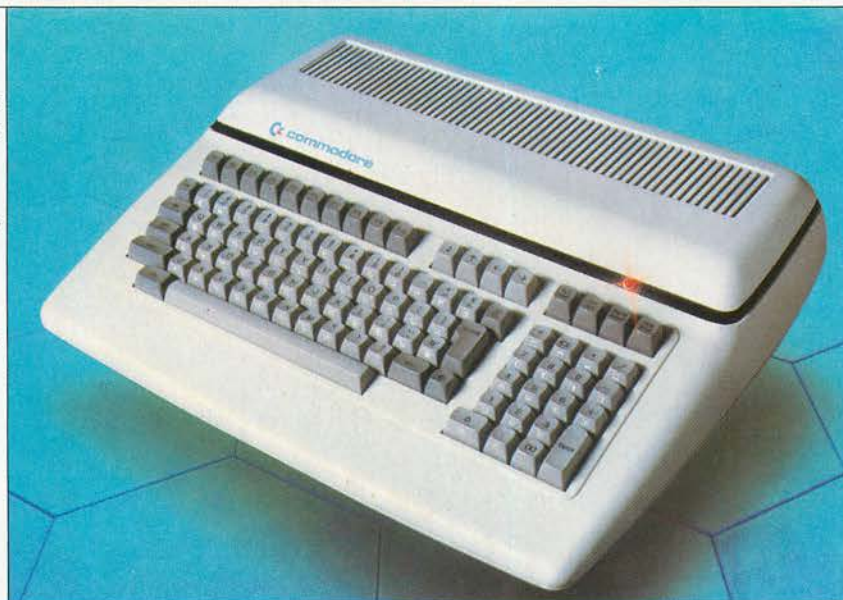

SOUTH AND SOUTH EAST

Currys Micro Systems Ltd.
(inside Currys) Units 91/93,
Arndale Centre, Luton, Beds LU1 1TB
0582 425079

HB Computers Ltd.
40-50 Collingdon Street, Luton, Beds.
(0582) 454466

MMS Ltd.
Ketwell House, 75-79 Tavistock Street,
Bedford, Bedfordshire MK40 2RR
Bedford (0234) 40601

Adda Computers Ltd.
275 Oxford Road, Reading,
Berks. RG1 7PY
Reading (0734) 585928

Adda Computers Ltd.
120 High Street, Slough, Berks. SL1 1JQ
Slough (0753) 72470/77514

Alphascan Ltd.
22 Hambridge Road, Newbury, Berks.
Newbury (0635) 30880

C.S.E. (Computers),
12 Wokingham Road, Reading,
Berks. RG6 1JG
Reading (0734) 61492

Kingsley Computers Ltd.
132 Desborough Road,
High Wycombe, Bucks. HP11 2PU
(0494) 449749

Amplicon Micro Systems Ltd.
Richmond Road, Brighton,
East Sussex BN2 3RL
Brighton (0273) 608331

South East Computers,
15 Castle Street, Hastings,
East Sussex TN34 3DY
Hastings (0424) 426844

**Alphanamerica Computer
Systems Ltd.**
Mixgate House, 38 Hamlet Court Road,
Westcliff-on-Sea, Essex SS0 7NS
(0702) 43304

Apollo Reprographics,
Unit 15A, West Station Industrial Estate,
Spital Road, Maldon, Essex CM9 6TW
Maldon (0621) 56933

**Computer Sales & Software
Centre Ltd.**
190-192 Cranbrook Road,
Ilford, Essex IG1 4LU 01-554 3344

Dataview Ltd.
Portreeves House, East Bay,
Colchester, Essex CO1 2XB
Colchester (0206) 865835

DDM Direct Data Marketing Ltd.
22 Warley Hill, Brentwood,
Essex CM14 5HA Brentwood (0277)
229379/230480/214168

Stuart R. Dean Ltd.
373 Southchurch Road,
Southend-on-Sea SSI 2PY
(0702) 62707

COMMODORE 64

THE PERSONAL COMPUTER

40-column 16-colour display to monitor or TV. 64K RAM. High-resolution graphics and 3-dimensional effect capability, music synthesiser.

Z80 additional processor option.

FROM

£299

EX VAT



BBC/Atom graphics digitiser

J C Flowers describes an interface to enter graphics data, which you can build yourself without breaking the bank.

THERE ARE ONLY TWO cheap and easy ways of providing digital x,y co-ordinate information to a computer. The first technique is to use a light-pen, which operates by detecting where the position of the CRT raster, or scanning spot, when the photo-detector in the pen is illuminated. The x,y co-ordinate positions are latched inside the computer at this moment. Cheap light-pens will not resolve very small pixels, so only relatively coarse plotting can be achieved, and drawing has to be in freehand on the tube face.

The second technique uses some kind of potentiometer to obtain a reference to a particular position of a point on a map or drawing. A very simple x,y plotting tablet

can be made using two orthogonally mounted slider potentiometers with Perspex cursors fixed to the slides, as shown in figure 1.

If linear potentiometers are used, the x,y co-ordinate positions are linearly related to potentiometer travel. I chose this method for the ultimate in cheapness and to develop the necessary circuitry. The tablet uses two 10K slider potentiometers, which cost £2 each, and gives a 5cm. square plotting area. The longer the slider travel, the bigger will be the plotting area, so buy the biggest pots you can afford.

If you need a larger plotting or digitising area try the moving-arm x,y digitiser, which can be built to handle whatever size drawing

you may wish to digitise. It consists of two equal-length pieces of wood or metal potentiometer shafts — see figure 2. The size of the platen or plotting area is determined by the length of the arm, which must be able to cover its area.

Provided linear pots are used there is a linear resistance-versus-angle law for each potentiometer. The actual x,y co-ordinate values have to be calculated by the computer using rectangular-to-polar conversion, where

$$x = R \cos(\theta - \alpha) - R \cos \alpha$$

$$y = R \sin(\theta - \alpha) + R \sin \alpha$$

The full travel of each potentiometer is not used to cover the platen, so the maximum and minimum resistance values have to be

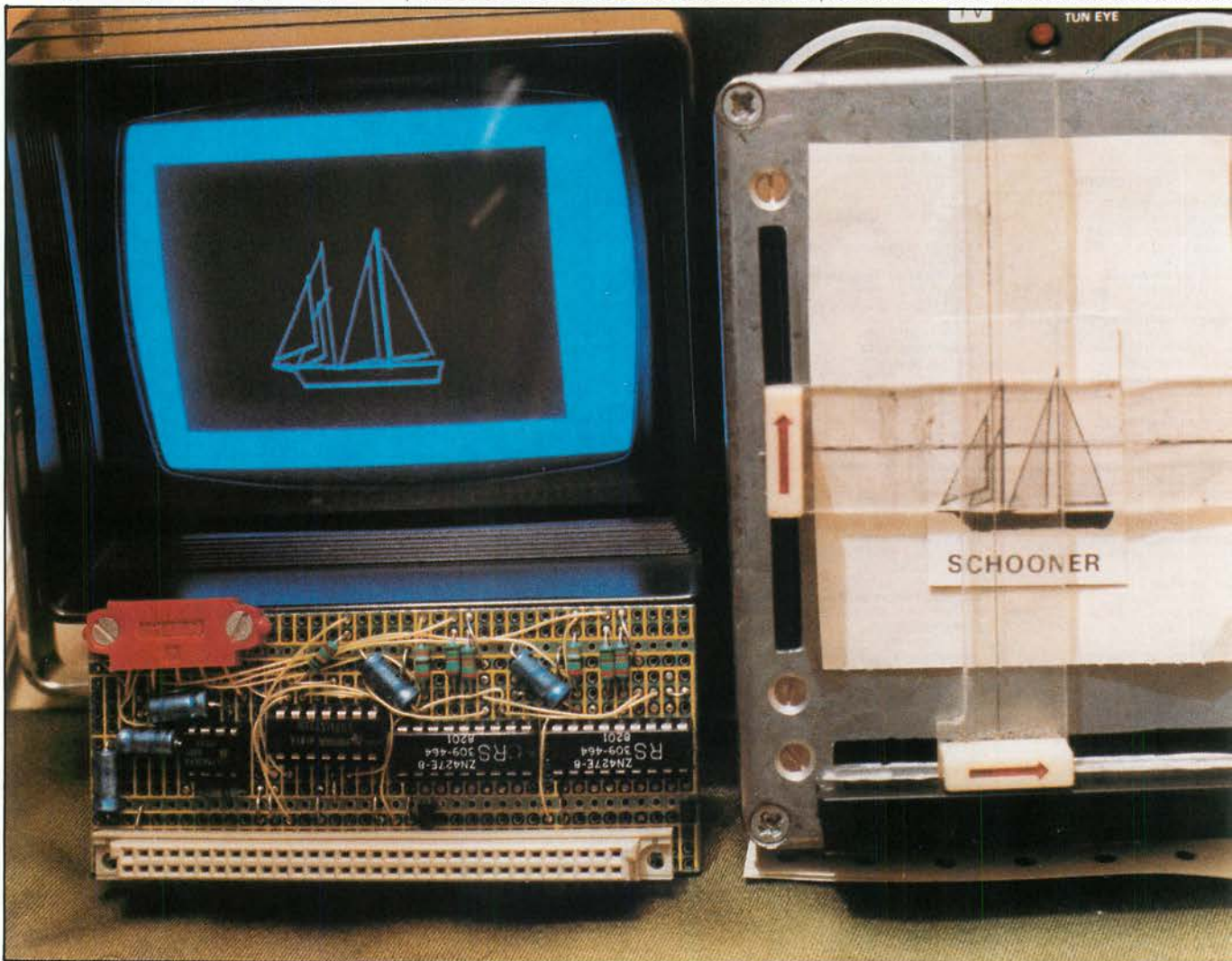

determined experimentally. Appropriate scaling is applied before determining the angle from the resistance or resultant voltage value.

Most microprocessors do not measure resistance values but rather the resulting voltage on the potentiometer slider terminal when the potentiometer is connected across a fixed voltage source. To do this it is necessary to convert the variable voltage output to a digital number using an analogue-to-digital converter.

Many microcomputers already have A-D converters fitted as standard; if you have BBC Micro model B you will be able to connect the potentiometer outputs from the graphics digitiser directly to the analogue input port where up to four channels are available.

If you have a purely digital I/O capability, using perhaps a VIA or PIA chip such as the 6522 as used on the Acorn Atom, you will have to construct your own dual eight-bit A-D converter. The circuit shown in figure 3 gives good performance when coupled to a joystick controller, and is even fast enough to digitise speech. The design can be built for about £25, which compares favourably with commercial offerings. The circuit diagram has been drawn to show precisely how pins on the integrated circuits are wired, looking down on the ICs.

The A-D converter will plug directly into the Acorn Atom bus connector if constructed on a small piece of Verocard or similar prototyping material. The numbered pins refer to what you will find printed on a 64-way mating DIN connector, not what is printed on the Atom's circuit diagram which for some reason has the a and b pins reversed. The ICL-7660 is used to generate -5V from the Atom's +5V supply; this is required by the A-D converter chips so that they can keep digitising down to zero volts on their input.

The 74LS73 device is a dual JK flip-flop

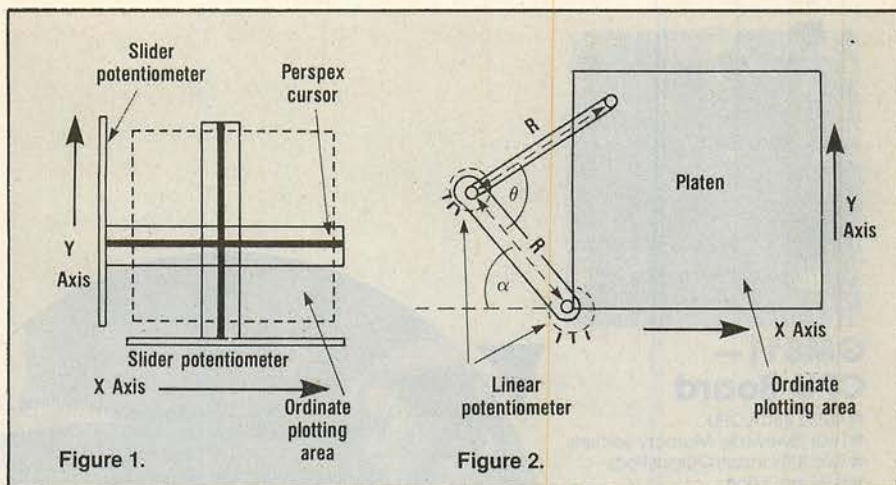

Figure 1.

Figure 2.

Quantity	Radiospares stock number	Description
1	304-598	voltage generator
1	305-125	dual JK flip-flop
2	309-464	A-D converter
1	162-940	
2		
2		
2		
5		
2		
1	467-475	
to suit		A-D converter parts list.

which is connected so as to divide the Atom's 1MHz microprocessor clock down to 250kHz so it provides the clock signal and correct start timing for the Ferranti ZN427E eight-bit A-D converter devices. The ZN427E is a successive-approximation A-D converter and contains a D-A converter, voltage comparator and successive-approximation register.

When it is asked to make a conversion by pulsing pin 4 low, the ZN427E internally toggles each of its eight bits starting with the

most significant bit and sees if the resulting answer from its internal D-A converter, when compared to the incoming analogue signal, is bigger or smaller. It sets all its eight bits finally to equal numerically the incoming signal and then signals it is ready by taking pin 7 high, at the same time placing the data on the bus where the Atom can read it as it appears on the 6522 VIA input pins.

This process is quite fast, and with the
(continued on page 103)

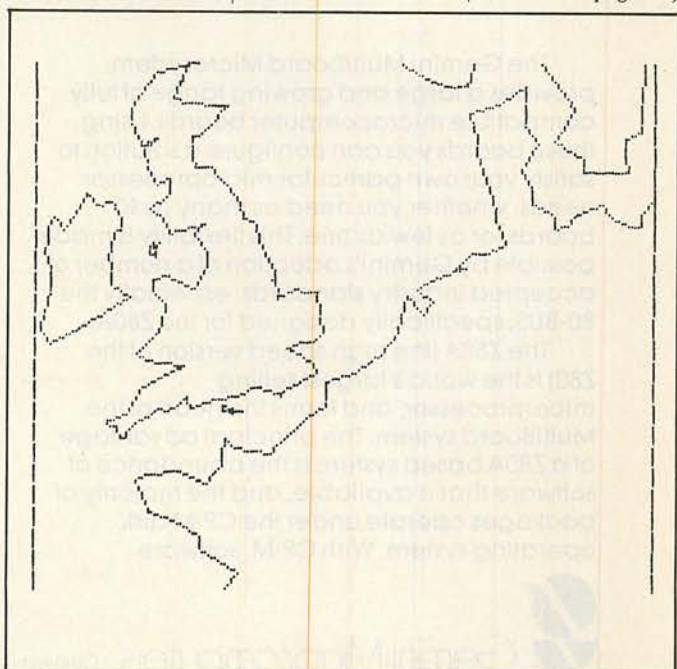
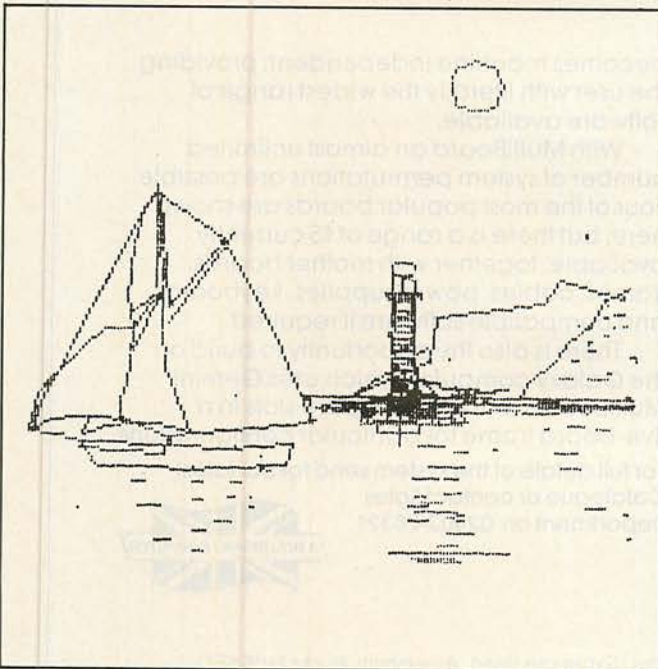

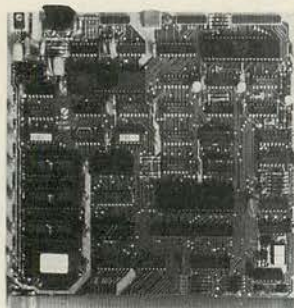

GM811 – CPU Board

- ★ 4MHz Z80A CPU
- ★ Four 'Bytewise' Memory Sockets
- ★ Two 8-Bit Input/Output Ports
- ★ 8 Bit Input Port
- ★ RS232 Serial Interface
- ★ 1200 Baud CUTS Cassette Interface

GM812 – IVC Board

- ★ 80x25 Display Format
- ★ On-board Z80A Microprocessor
- ★ Buffered Keyboard Input
- ★ Programmable Character Generator
- ★ 160x75 Pixel Graphics
- ★ Light Pen Input

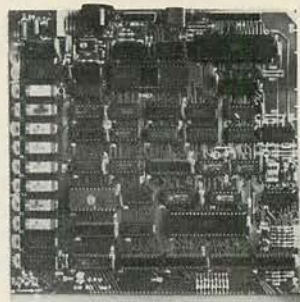
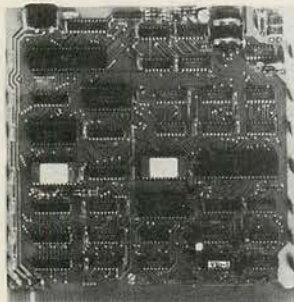

GM813 – CPU/64K RAM Board

- ★ 4 MHz Z80A CPU
- ★ 64K Dynamic RAM
- ★ RS232 Serial Interface
- ★ Two 8-Bit I/O Ports
- ★ 1200 Baud Cassette Interface
- ★ Extended and Page Addressing Modes

GM 829 – FDC/SASI Board

- ★ Single/Double density operation
- ★ Single/Double sided drive operation
- ★ Up to 3 mixed 3.5", 5.25" and 8" drives
- ★ Industry Standard SASI hard-disk interface

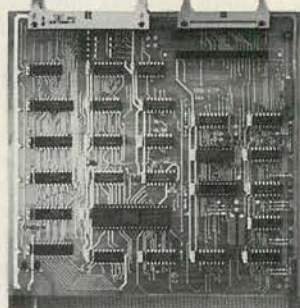

15 80-BUS SOLUTIONS

The Gemini Multiboard Microsystem provides a large and growing range of fully compatible microcomputer boards. Using these boards you can configure a solution to satisfy your own particular microprocessor needs, whether you need as many as 10 boards, or as few as one. This flexibility is made possible by Gemini's adoption of a number of accepted industry standards; especially the 80-BUS, specifically designed for the Z80A.

The Z80A (the high speed version of the Z80) is the world's largest selling microprocessor, and forms the heart of the MultiBoard system. The principal advantage of a Z80A based system is the abundance of software that is available, and the majority of packages operate under the CP/M disk operating system. With CP/M, software

becomes machine independent; providing the user with literally the widest range of software available.

With MultiBoard an almost unlimited number of system permutations are possible. Four of the most popular boards are shown here, but there is a range of 15 currently available; together with mother boards, frames, cables, power supplies, keyboards and compatible software if required.

There is also the opportunity to build on the Galaxy computer, which uses Gemini MultiBoards, but has two spare slots in a five-board frame for particular configurations.

For full details of the system send for our latest Catalogue or contact Sales Department on 02403-28321.



Gemini Microcomputers Oakfield Corner Sycamore Road Amersham Bucks HP6 5EQ

● Circle No. 263

Graphics digitiser

(continued from page 101)

circuit as shown can take place at a 27kHz rate quite suitable, for instance, for digitising speech. The input to each converter is on pin 6 via a 3.9K resistor. If speech use is required, then set the x or y potentiometer to half way and connect the output of your amplifier via a large capacitor to the potentiometer slider terminal.

Otherwise, the x and y potentiometers of the chosen graphics digitiser are connected with one end to ground and the other to the ZN427E pins 7 and 8, which provide a 2.5V reference potential. If you make 0 and 255 the digital outputs of the converter at either end of the potentiometer travel you will not have to do any scaling in software.

When you are satisfied that your wiring is correct, plug the circuit into your Atom's bus connector. The current consumption will be about 80mA. The digitiser plotting program will enable plotting to commence, and can be used to test your circuit. The Rem statements explain the program. The two Conversion Complete signals at A21 and A12 should not normally have to be used in Basic but may be necessary for timing purposes if you write a machine-code program to use the system for speech processing.

Digitiser plotting program.

```

4REM Plotter: XY PLOTTING FACILITY.
5?#209=#55;?#B802=#00;?#B803=#00
10 DIM LL(2),P(-1);L=#80;M=#82;?M=#00;A=#30
20 P.#21
30C
40:LL0 JSR #FFE3
50STA L
60RTS
62:LL1 JSR #FE71
64STY M:RTS
70J
75!A=#022D80A9;A!4=#4CF90BB0
80P.#6;CLEAR4
85A!8=!#3FE;!#3FE=A
90LINK LL0
92IF ?L=#20 GOS.b;REM SPACE BAR PLOTS FROM LAST TO NEXT POINT
94 IF ?L=#40 GOS.c;REM M MOVES FROM LAST TO NEXT POINT
96IF ?L=#98 G.d;REM X MARKS ORDINATE POSITIONS.
97REM TAP X AGAIN TO CANCEL MARKER
100G.#0
120END
140b?#B800=#CE;?#B800=#CC;?#B800=#CE;REM START CONVERSION
150WAIT;WAIT
160X=?#B800;Y=?#B801
170X=32+(X*192/255);Y=Y*192/255;REM SCALE FOR SQUARE PICTURE
175DRAWX;Y;F=X;U=Y;R.
180c?#B800=#CE;?#B800=#CC;?#B800=#CE
190 WAIT;WAIT
200X=?#B800;Y=?#B801
210X=32+(X*192/255);Y=Y*192/255
220MOVEX;Y;F=X;U=Y;R.
230d?#B800=#CE;?#B800=#CC;?#B800=#CE
235WAIT;WAIT
240X=?#B800;Y=?#B801
250X=32+(X*192/255);Y=Y*192/255
260MOVE(X-1);Y;PLOT5;(X+1);Y;MOVEX;(Y-1);PLOT5;X;(Y+1)
262WAIT
264MOVE(X-1);Y;PLOT7;(X+1);Y;MOVEX;(Y-1);PLOT7;X;(Y+1)
265WAIT;WAIT;WAIT;WAIT
266MOVEX;Y;LINK LL1
270IF ?M=#08 THEN MOVEF;U;G.#0
280G.#0
    
```

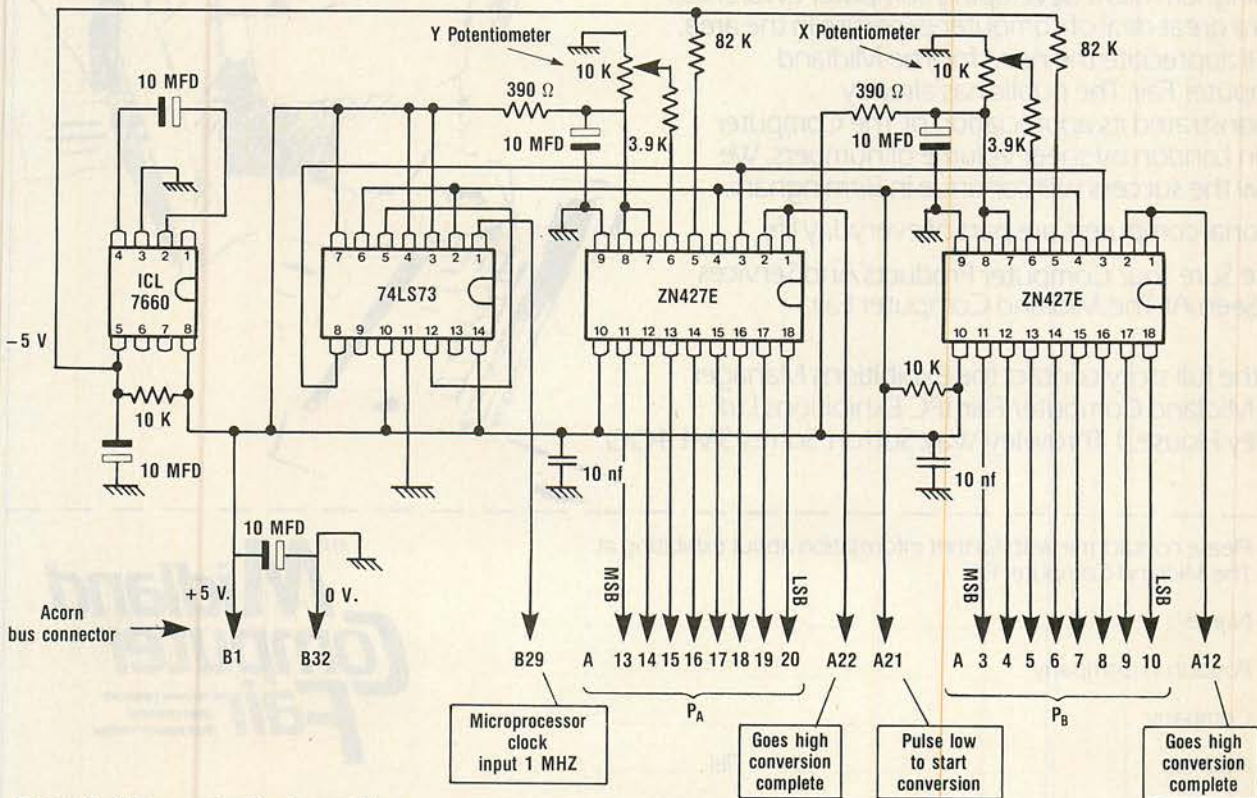

Figure 3. A-D converter for Acorn Atom.

NOW in Birmingham – the centre of industrial Britain ...

THE Midland Computer Fair

Personal computers
Home computing
Small business systems

Bingley Hall, Birmingham.
April 28-30, 1983

Sponsored by **Practical Computing** and **YOUR COMPUTER**

This exhibition is the ideal showcase for companies who need to demonstrate their products to the fast expanding market for home and personal computers, small business systems and associated software. When you consider that the markets for personal computers are regional and that Birmingham has a developing computer awareness with a great deal of computer expertise in the area, you'll appreciate the need for The Midland Computer Fair. The public has already demonstrated its appreciation of The Computer Fair in London by sheer volume of numbers. We know the success will continue in Birmingham.

Personal computers are part of everyday life.

Make Sure Your Computer Products And Services Are Seen At The Midland Computer Fair.

For the full story contact the Exhibitions Manager,
The Midland Computer Fair, IPC Exhibitions Ltd,
Surrey House, 1 Throwley Way, Sutton, Surrey SM1 4QQ.

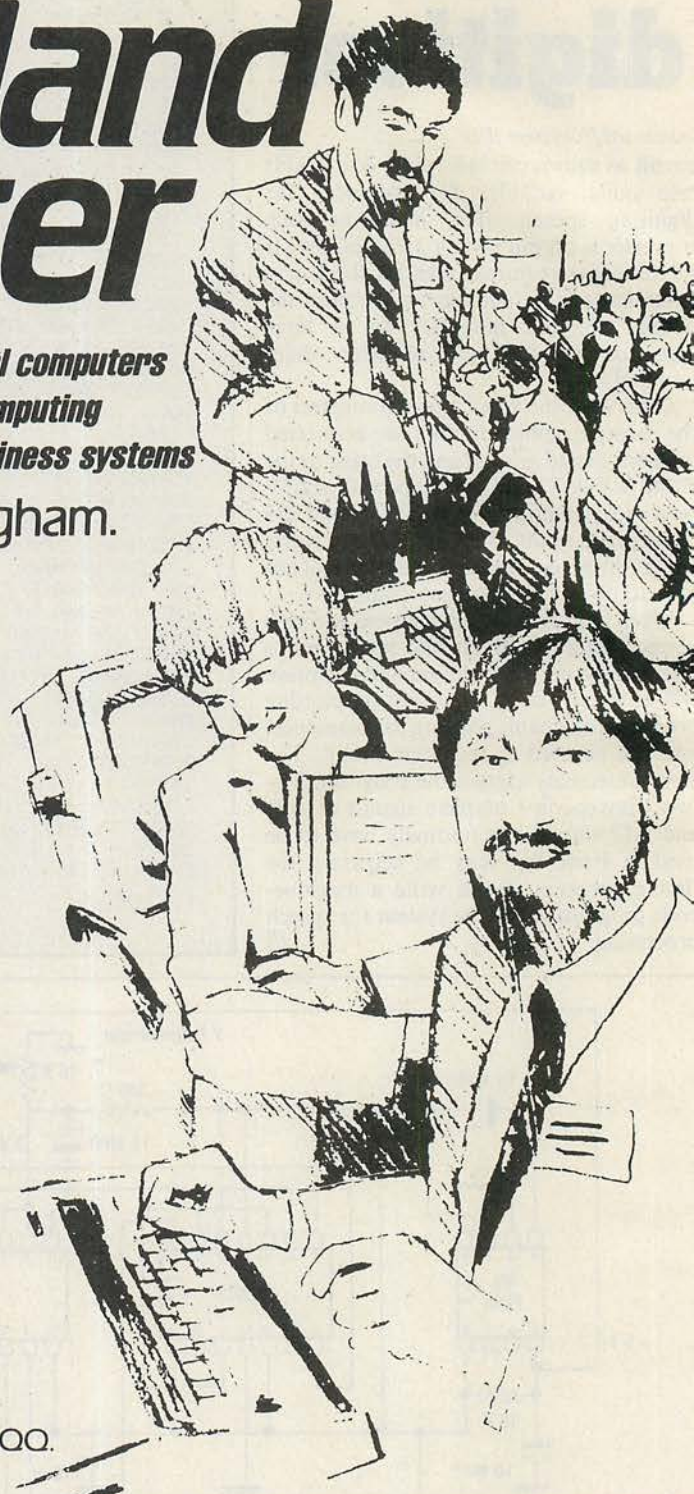

Please contact me with further information about exhibiting at
The Midland Computer Fair.

Name _____

Position in Company _____

Company _____

Address _____ Tel _____

THE **Midland Computer Fair**
Personal computers
Home computing
Small business systems



TOUGH TO OUTGROW

It's no surprise so many businesses today are using our CompuStar® multi-user microcomputer. All sorts of businesses, those at the top and those on the way, know that only CompuStar can give them the big system performance they'll need as they grow. And they know that *only* CompuStar can deliver that performance at a fraction of the cost of most other systems.

CompuStar® solves the small business computer dilemma. It's ideal for those first time business users who need only single-user capability. But it's also perfect when those small businesses grow into large corporations. That's because CompuStar is *truly* expandable... all the way up to 255 workstations, each with its own processor and internal computer memory. And that means fast, fast response, even when many users are on-line at the same time.

Whether you're a small business with big plans or a big business with an eye for economy, CompuStar® has the performance and versatility that's tough to outgrow... the price/performance ratio that's impossible to beat!

STANDARD FEATURES

- 350K/750K/1.5 MB workstation disk capacities
- 64K RAM and twin processors in each workstation
- An easy-to-read 12-inch non-glare screen
- Operator convenience features—numeric keypad and visual text highlighting
- Microsoft® Basic
- CP/M+ operating software
- Truly multi-user and multi-processor

STORAGE OPTIONS

- 10 MB—compact, low-cost and tabletop
- 96 MB—80 fixed and 16 removable megabytes
- 144 MB—reliable, rugged Winchester storage

CompuStar® is built and backed by the company that's been in the microcomputer business as long as microcomputers have been in business. Would you trust *your* business to anything less? CompuStar®. Tough to beat. Tough to outgrow!

*Microsoft is a trademark of Microsoft Corp.
†Registered trademark of Digital Research

**INTERTEC
DATA
SYSTEMS®**

CORPORATE HEADQUARTERS, 2300 BROAD RIVER ROAD • COLUMBIA, SOUTH CAROLINA 29210 • (803) 798-9100 • TWX 810-666-2115

Any four colours can be selected at a time from the palette of 255 available.

Automatic character magnification.

Random breakdown in High voltage capacitors

5-Sep-83

Mean

Mean

User-defined shading patterns.

Fast block fill facilities provided.

```

100 CLEAR 200
110 DIM H(7)
120 TEXT
130 PUT 12
140 CALL "RESOLUTION",0,2
150 I=6
160 REM DEFINE COLOURS
170 CALL "COLOUR",0,0,0,0
180 CALL "COLOUR",1,6,0,0
190 CALL "COLOUR",2,230

```

Ready:

Enter week number -- 33
Enter year -- 83
Enter station number -- 3

Text in 40 character mode with 80 character mode overlaid.

Characters can be oriented in any of four directions.

'Windows' can be defined and scrolled independently.

A picture may be worth a thousand words but it still tells only half the story about graphics on the 380Z.

For a start, our standard graphics functions include point plotting, line drawing, instant block fill, block copying, offsetting, and Exclusive Or Plotting.

Then there is the important fact that our High Resolution Graphics is supported by Basic, Algol and Fortran. And since the Graphics is contained in its own 16K of RAM, every byte of user memory remains available for applications program use.

It is also worth noting that 380Z graphics are equally effective in monochrome — for 'colour' just read 'shades of grey'. Again there are 255 shades available, and there's also a very useful facility for fading up and down throughout the grey scale.

There are also the special effects — such as moving between graphics 'pages' for pseudo-animation, or the

ability to produce 'instant' graphics by drawing them with the colour 'switched' off and then 'switching' on.

Next, not only can 380Z graphics pictures be saved on and retrieved from disc, they can also be output to one of a range of popular dot matrix printers.

Remember, too, that HRG is not a third-party add-on but designed, developed, and supported by Research Machines itself as an integral part of the 380Z.

And finally, we've now implemented GINO. So for the first time this well-established, professional suite of flexible, device-independent graphics software from the CAD Centre is available on a micro.

GRAPHICS MACHINE



RESEARCH MACHINES
MICROCOMPUTER SYSTEMS

If you are interested in graphics — for scientific, technical, and industrial research; or in secondary or higher education; or for design, engineering, or control, then you will be interested in the 380Z.

RESEARCH MACHINES LTD Mill Street, Oxford OX2 0BW, Tel: (0865) 249866

Monday morning computing guide

Start the week off with Chris Naylor's A-Z guide and find out what the manual's instructions really mean.

Bit The part of your program that is right.

Boolean See *Binary* or *Logic*.

Branch See *Boolean*.

Bug A method of programming in which error messages are selectively arranged into simple words appropriate to the task in hand.

Byte Eight bits, only one of which is wrong.

Call A simple but powerful method of leaving the section of code from

which you knew where you were to enter another section of code, of unknown location, thereby enabling the program to corrupt all variables and finally return control to a third section of code which actually appears to belong to another program altogether. See *Dump*.

Clock A mechanical device which mocks your computer by its reliability and speed.

(continued on next page)

Absolute address Read no further, this is the definition you want.

Acceptance testing A lengthy and time-consuming process in which the job specification is gradually and completely altered to match the equipment supplied.

Access time About 30 seconds, usually.

Accumulator A method of problem accretion initiated by an early attempt to solve one problem only by computer.

Accuracy A precise concept defined by the number of bits used in number storage: for example, 16-bit accuracy. The last bit is always wrong. Each operation on a number makes the next bit wrong also. After 16 operations the whole number is wrong. See also *Inaccuracy*, *Dump*.

Acronym A Completely Random Ordering Never Yields Meaning.

Address See *Indirect Address*.

Algol A variable star of the eclipsing type with a period of 69 hours.

Algorithm A series of instructions for solving a specific problem. Not to be confused with a program, which is just one realisation of these instructions implemented on a machine, other than the machine you have, for solving a specific problem unrelated to the particular problem you have, and which fails.

Alphameric The logical result of trying to say "alphanumeric" first thing in the morning.

Architecture The most impressive part of any computer system — the box it comes in.

Array A simple but powerful method of reducing available storage.

Assembler The language in which 10 percent of all programs must eventually be written.

Associative memory A system of memory hardware which is able to note that address x has a fault in it, and so that address x doesn't feel bad about it is able to reproduce this fault randomly throughout the entire system.

Babbage A British genius, born 1791, who invented computers and then discovered the First Law of Computers — they don't work.

Backing store A method of data storage, additional to main memory, which is designed to make the computer itself seem relatively cheap by comparison.

Basic The only high-level language which can be mastered completely in less time than any program written in it will take to execute.

Benchmark A precise method of measuring the ability of a computer to do something which nobody in their right mind would ever want it to do.

Binary A simple but powerful method of losing your data.

I KNEW I SHOULD'VE
THUCK TO
THPATHE INVADERTH!

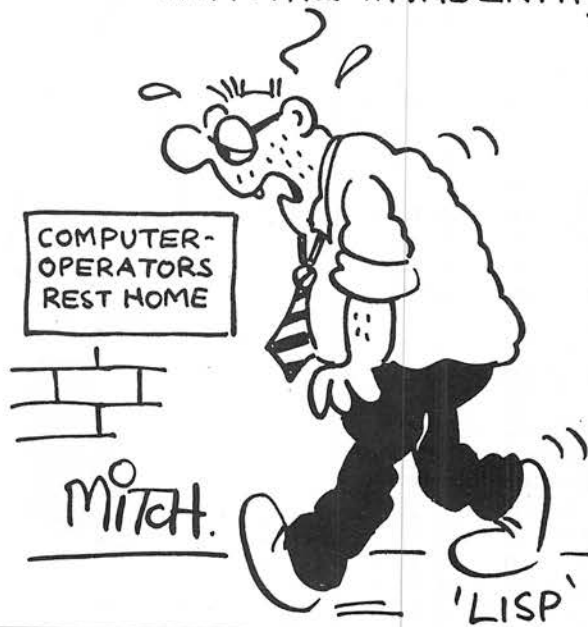

Monday morning computing guide

(continued from previous page)

Cobol A high-level language designed to enhance long-term employment prospects.

Compatible A theoretical concept. See *Incompatible*.

Compiler A program written specifically to treat a higher-level language program as data, reduce it to machine code in parts and rearrange these parts before giving up. See *Unsupportable*.

Conditional See *Iteration*, if you haven't seen it already.

Cumulative error See *Accuracy*. Then see it again.

Cursor A programmer against a deadline.

Cycle time The time a program takes to give you exactly the same errors you started off with.

Data A vital collection of variables which, when held in memory, leave no room for the program.

Database A vital collection of variables which could not conceivably be held in memory, whether there is a program there or not.

Database management system A program without which those vital variables could never be accessed and, with which, they will not fit in memory.

Data dictionary A method of describing data in such a way that you always know exactly how much of it has been lost.

Data manipulation A method of programming designed to make the data match the answers you know are right.

Data transmission A method of corrupting someone else's data from a safe distance.

Default An application for which the program might be useful. Not the intended application.

Direct access A method of reading or writing the wrong piece of data at high speed.

Dump A method of programming based on the assumption that there must be something useful in memory if only you can find it.

Editing See *Dump*.

Elliot A real computer manufacturer from the days when programmers were men who drove machines that

were iron and a program patch meant Sellotape.

Emulate A program which behaves like another program by virtue of being a precise copy of it.

Encode To render permanently incoherent.

Encrypt To render permanently cryptic.

Enhance To encode or encrypt.

Entry point A point in the program to which the machine goes before you have had time to stop it going there.

Erase An attempt to read vital data of which you have no back-up copy.

Error A section of output that, momentarily, you are unable to justify.

Expert system A computer system that can replace the human expert by sitting on a desk, consuming electricity, and saying *Illegal Command*.

Fifth generation A method of program maintenance much worse even than usual. See *Maintenance*.

File An unstructured, undocumented, unreadable and interminable section of data produced by someone else's program, which will cause any part-way decent program to crash instantaneously on catching mere sight of the file header.

Floating point A system of number representation based on the assumption that you know the answer already.

Fortran A traditional high-level language designed to enable scientists to corrupt the system without having to call in outside help.

Function A standard section of code, inaccessible from outside itself, which reduces the amount of memory available to the rest of the program.

Global A fault which permeates the whole system.

Goto A method of leaving the current section of code with no means of ever returning, in order to enter a further section of code which, you now recall, has not yet been written. See *Dump*.

Hard copy Evidence. The main reason for using VDU screens.

Hardware That part of a computer which never fails and is, therefore, unable to do anything useful by itself.

Hexadecimal A simple but powerful method of concealing your activities.

High-level language A programming language which allows you to express powerful statements in an unexecutable fashion.

If A general class of wish-fulfillment statements.

Incompatible The main argument in an expression designed to obtain a hardware upgrade.

Indirect address See *Address*.

Initialise. A method of damage control used at the end of each program run.

Interpreter A slow Compiler; see *Compiler*.

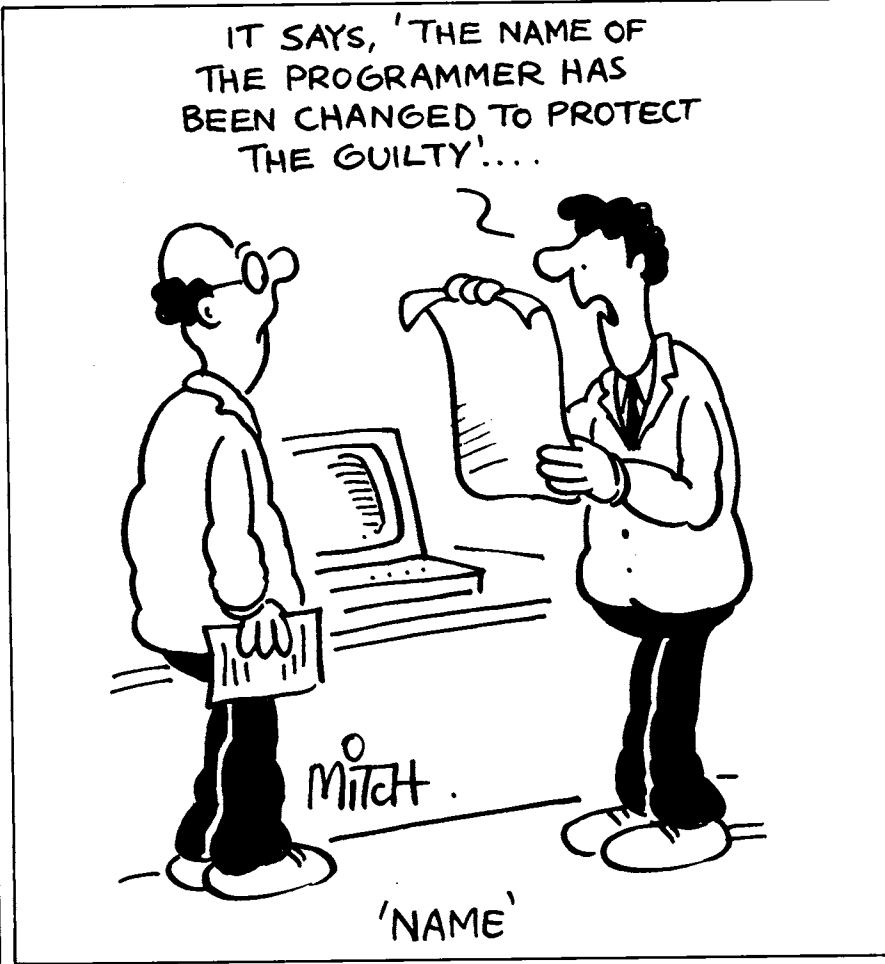

Iteration See *Iteration*.

Label An identifier used to mark a section of code for access from another section of code by means of a Goto or a Jump or a Call, subject to the condition that each label must occur at least twice or not occur at all or be a system label.

Library A collection of subroutines designed to enhance the length of a program without influencing its operation.

Lisp A highish-level language designed to weaken both the distinction between program and data and the programmer's grip on reality.

Literal A simple but powerful method of writing the answer in by hand.

Local A subroutine without entry or exit points.

Logic A formal and powerful method of explaining why the program doesn't work.

Loop See *Iteration* and *Loop*.

Machine code The language you should have learned.

Macro A machine-code subroutine designed to save the programmer the inconvenience of having to corrupt large areas of store by hand.

Maintenance A programming method in which development work is carried out by the programmer's children and their children's children.

Matrix A method of mathematical notation which bears strong but insufficient resemblance to arrays.

Memory A free-fire zone for both programs and data. A no-go area.

Mnemonic Something whose precise use one forgets.

Name The identifier by which a variable, but not this variable, is known.

Null A formal expression for the value of a system.

Number cruncher This is too horrible to describe in what is, after all, a family journal.

Operating system A master program which, alone, can destroy all lesser programs.

Own A method of ensuring that a local variable remains local; see *Unsupported*.

Parameters The actual values of some variables which define an operation. An n parameter operation always has $n - r$ parameters defined, where r is a random number.

Parity A state of equivalence in which neither you nor the computer know the answer and so you toss for it.

Password A system of computer security in which a secret number is assigned to each user and then written out in a list and left by the console in case anyone forgets their particular number.

Peek See *Dump*.

Poke A sophisticated method of dump-modification.

Pointer A sort of dog which always seems to know which way the data went.

Pop up, push down a frustrating condition which will not go away.

Polish notation An algebraic notation in which all of the numbers are entered first, thus making it impossible to tell where one number ends and another one begins. See *Dump*.

Portable A uniform method of programming so that a program developed on one machine may be run on any other machine with exactly the same result. The result is that it does not work on any machine.

Prefix A method of arranging a demonstration so that, just this once, the program works.

Proprietary software A program whose ownership is certain but whose purpose is not.

Prototype A program which does not work perfectly but is still better than the program you eventually get.

Quotes A method of denoting key words in some languages and string expressions in others. Quotes always occur $n + 1$ times where n is an even number.

Recursion A subroutine which can be entered from within itself or from outside itself but not from any other point, and which may not be exited while the initial condition holds, or while any other condition holds unless there is a note in the manual to the contrary.

Redundancy A means of encoding data such that, when corrupted, it is possible to reconstruct the original form of the data inexactly from other data elements, which might well have been corrupted also for all you know. Communications experts have now developed algorithms which can carry out redundancy checks on data almost as fast as it comes in.

Reserved words The first choice for variable names.

Reverse Polish notation A method of price justification for expensive calculators.

Seek time The time it takes to read from disc a piece of data which isn't there.

Sort The arrangement of items in an order with respect to some variable, but not the variable or the items you originally had in mind. A method of scrambling the contents of a disc. See *Encode, Dump*.

Spec An unreasonable request.

Stack A large number of unreasonable requests.

Storage An area of memory, either main or peripheral, which is insufficient for any reasonable needs.

String A small section of code which makes sense but is unexecutable.

Structured A method of programming which makes the unreasonable



request that you should know what you wish to program before you start to program it. More usually: a method of describing a program by reference to something it happens to do.

Subroutine A section of code which should have been written earlier.

Suite A single program which will not fit into main memory.

Symbolic The specification of the machine you bought.

System disc A general-purpose storage area for programs and data.

Table A method of writing in a large number of answers by hand.

Test data A collection of variable values consisting of all those values for which the program will work.

Turnkey A special-purpose computer which, at the turn of a key, reveals its purpose to be other than that for which you bought it.

Type The data format of a variable. Type is always Real.

Unsupported A class of features without which any given system is useless.

Utility A program which is widely available yet useless.

Variable The contents of a location in memory which can be accessed by means of two or more variable names.

Verification A method of program checking which is known not to reveal any errors.

Write protection A mechanical method of physically preventing a program from writing to a tape or disc containing valuable data which your program has just overwritten due to omission of this precaution.

X Marks the spot in the dump where you last saw your program.

Yarn A complex and subtle explanation of great length which demonstrates why it is logically impossible for the system to be working yet.

Zero Division by: not again, surely ☐

Confuse-an-Apple

Geoff Buckeridge's program lets you run Pet programs on an Apple without having to make a laborious line-by-line conversion.

MOST PEOPLE quickly become used to or even attached to their own computer's features, functions, commands and idiosyncrasies. When you are writing programs from scratch there will usually be an easy way of doing things with the tools you have available to you; problems only arise when you try and convert a program designed for one machine for use on another.

I have an Apple II and nearly always write my own programs, but if I find a published program that I would like to use it is invariably written for the Commodore Pet. In this case it is necessary to convert the program before it can be keyed into your system, which can often be a time-consuming and even daunting task.

Faced recently with a mammoth conversion job, I wondered whether instead of tackling it manually my time would be better occupied in devising an automatic conversion program which could be used for similar occasions in the future. My first step was to decide which features I would most like to have on my Apple. Once implemented they would provide my system with an immense increase in flexibility and eliminate the need for conversion. The features are:

- The ability to incorporate cursor-control and screen-format characters within Print statements. The alternative Apple solution is messy, to say the least.
- A consecutive screen memory map and the ability to access these locations through Peek and Poke at the same memory addresses used by the Pet. The Apple screen map is far from logical.

The resultant program allows Apple users

to type in Pet listings with a minimum number of modifications and even those can be done mentally so there should be no need to make intermediate notes. It can be split into three main sections: cursor-control conversion, screen Poke conversion and screen Peek conversion.

The Pet allows eight special control characters to be incorporated in Print statements. They are either graphic or inverse characters, which makes the listing untidy. Confuse-an-Apple allows you to enter a row of cursor-control characters starting and ending with a ^.

For example,
PRINT "[CLS][15 CR][12 CD][REV]hello
[OFF]"

converts to:

```
PRINT  
" ^ CRRRRRRRRRRRRRRRRDDDDDDDDDD-  
  DDDDI ^ hello ^ N ^ "
```

The special characters are:

U — cursor up
D — cursor down
R — cursor right
L — cursor left
I — Inverse Print mode
F — Flash Print mode
N — Normal Print mode
H — cursor to top left of screen
C — clear whole screen and cursor to top left
E — clear screen from cursor to end of line
S — clear screen from cursor to end of screen
B — ring bell

The screen-Poke conversion part of the program allows you to Poke the same memory locations as if you were using the Pet, so there is no need to recalculate memory addresses. The only problem is that the Apple has 24 screen lines and the Pet has 25. Any attempt to Poke an address in the

25th line will result in an Illegal Quantity error at run time.

For example,
POKE 33000,130
converts to:

&POKE 33000,130
Expressions and variables can be used freely within the range 32,768 to 33,727.

The same rules apply for Peek as for Poke. As long as you avoid the 25th line there will be no problem. For example,

Y = PEEK (X/2)
converts to:
Y = USR (X/2)

The USR function is used here because its syntax is similar to Peek.

The Confuse-an-Apple program makes use of three of the more unusual features of the Apple: the COut hook, the ampersand and the USR function. Characters are normally printed to screen through the COut routine in Apple's monitor, but they can be rerouted via the COut hook at locations \$36 and \$37 to a user subroutine anywhere in memory.

The cursor-control module makes use of this to intercept each character before it goes to screen. If a ^ is found then it is assumed that all characters from then on are cursor-control commands. A second ^ causes a switch back to normal printing mode.

Wherever a & occurs in an Applesoft program it will cause a jump to a subroutine at \$385, used by the &Poke module. The subroutine first checks that the keyword Poke follows the & sign. Anything else will result in a syntax error. Next it evaluates both expressions and checks that they are within range. If not, an illegal-quantity error is displayed. The address in the first expression is converted to its Apple counterpart and the value of the second expression is stored at that address.

The USR function is designed to pass floating-point numbers from Basic to machine-code routines. The Peek module immediately converts the number to an integer and checks that it is within range. If not, an error message occurs. The Pet address is again converted to an Apple address and the routine returns to Basic with the contents of that memory location in the floating-point accumulator.

Confuse-an-Apple sits in memory just below DOS and should be protected from being overwritten by moving Himem below it. It should be initialised at the beginning of your program with a Call 37632 statement, and it would be wise to disconnect it before you exit with a Call 37684. The example listing demonstrates all three features of Confuse-an-Apple.

Demonstration program.

```
8 REM CONFUSE-AN-APPLE
9 REM DEMONSTRATION
10 HIMEM : 37632
20 CALL 37632
30 LIST : LIST : LIST
40 FOR X = 32768 TO 33727
50 IF USR ( X ) = 160 THEN &POKE X,174
60 NEXT X
70 POSS = " ^ RRRRRRRRRRRRRRRRRRRRRRRRRDDDDDDDDDD ^ "
80 PRINT POSS ; " ^ ARRF ^ B ^ LDDI ^ C ^ LLLLNB ^ D "
90 CALL 37684
100 END
```

Computers in

For managers introducing new technology the problems do not end with the choice of software. John Dawson offers advice on how to keep staff happy when computers are in the offing.

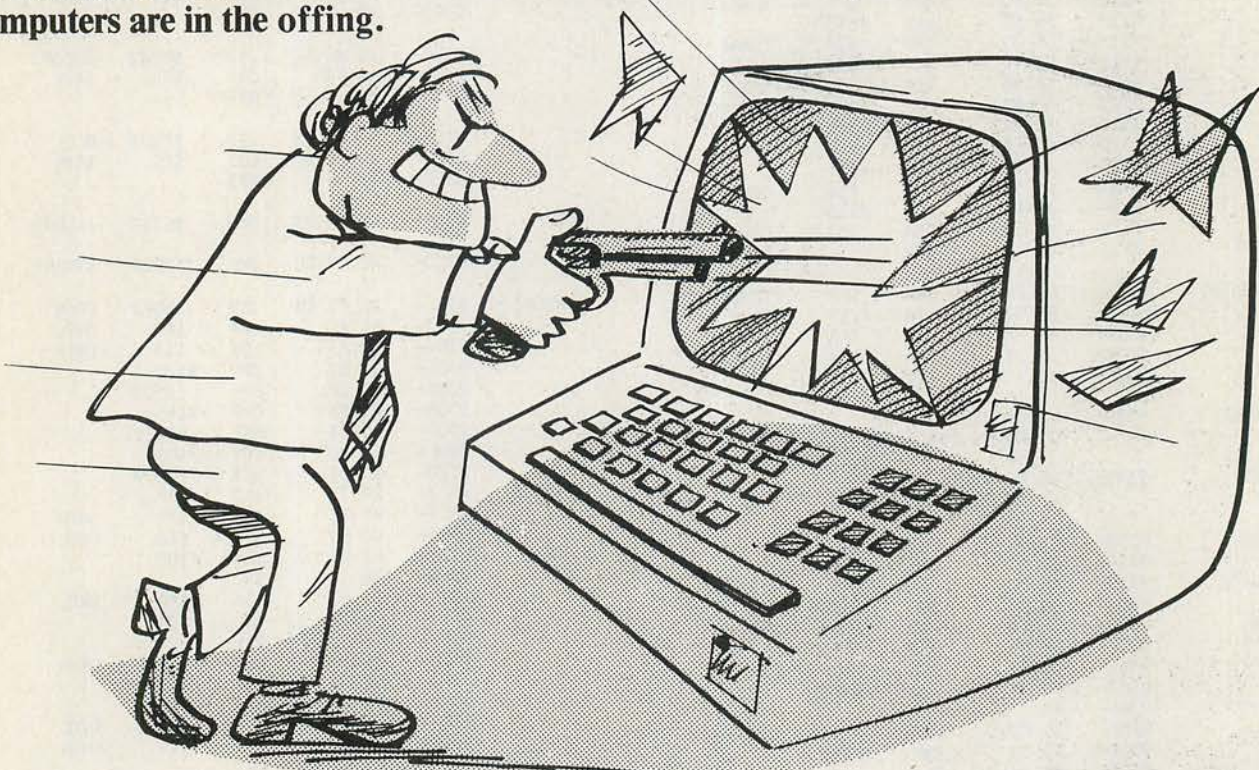

INDUSTRIAL RELATIONS can be a positive part of management as well as the bloody-minded antagonism usually reported to the public. It makes no difference whether you are introducing a computer with 100 terminals scattered across the west of England for stock control or bringing in a single-operator Apple for repeat prescribing in a GP's surgery. The history of computing, small and large, is littered with the debris of poor industrial relations and in this area, at least, the problem is international rather than being confined to Britain.

Large-scale computing systems have revolutionised the management of many companies involved in providing goods or services or in handling information. Computing systems interact with historical and organisational goals and political pressures to shape the internal structure of the company. Yet that is not the whole of the problem: computing systems of all sizes shape the way in which organisations interact with individuals.

The industrial relations of introducing a computer into an organisation may require formal negotiations with unions or simply talking to people and helping them through a minor crisis at work. For both real and mythical reasons computers are threatening

to someone who is simply told to use one or, worse still, excluded from a new project to use computers at work.

When you set about introducing a computer you are acting, in effect, as both systems analyst and designer. Systems analysis is threatening to many grades of staff: if you lean on the desk of a subordinate for half an hour asking questions and then leave with the attitude that it is all pretty simple you deny that person the expertise that they have taken years to acquire. You should aim to synthesise a design for a system that will build on the experience of staff and, in doing so, offer work to those staff that is more satisfying.

If there has never been a computer in your department and you can see applications for a machine then you have the opportunity to plan and work through the introduction of a system free from many of the hampering attitudes that can lead to rejection of computers out of hand. There are many positive benefits for any grade of staff involved in using a computer, and with careful management it is possible to achieve most of the benefits without the disadvantages that may also occur.

The two ends of the spectrum of applying computers to tasks within an organisation

are essentially the same as any other aspect of management. At one end is the authoritarian didactic style and at the other a *laissez faire* leaderless group approach.

It is possible to instruct subordinate staff to use a new computer system and then obtain very detailed information from the machine about the number of keystrokes in each hour made by a data-preparation operator, or the rate at which a typist using a word processor generates standard letters. The performance of a middle-grade sales executive, for example, can be monitored in far greater detail than before by the automatic calculation of indices based on his or her sales figures.

After a computer was installed at the head office of one chain store local managers came to dread Monday morning because the machine was programmed to deliver reports of each store's performance to a senior manager before they arrived on the store manager's desk. Arbitrary and punitive systems are all too easily established, and the damage they can cause to a company's operations is out of all proportion to any small support given to the position of an insecure senior executive.

Conversely, it is possible to introduce a computer or word processor as a tool that may be used by staff when they think they

workers out?

have a job that can be done better on the machine than by a manual method. The choice of using the machine or not using the machine then rests with the individual, who will continue to report to his or her manager about progress towards various objectives, as they did before the computer arrived.

Which route will you follow? Within limits, neither is necessarily better or worse than the other, and success will depend on the style of management already in existence in your organisation. But the wrong approach can generate intense passive resistance or even active violence towards the computer: one man took a large-calibre revolver and shot an American computer to relieve his frustration and anger.

Table 1 illustrates how common sense and courtesy can be combined to forge a successful management approach to information systems which directly affect the staff of an organisation. A similar approach by anyone planning to introduce a computer will lay a solid foundation for success. If you are involved in the introduction of a computer for work that does not involve keeping information about your

employees on the machine you will still need co-operation, enthusiasm and initiative if the application is to be successful.

The cardinal rule for bringing in a machine is to involve both the people who will use the machine and those who will be affected by it from the earliest possible stage, and listen to what they have to say. Listen not only to the words but to how they are said. Bringing in a computer is a crisis to many people, and you may hear arguments on one level accompanied by contradictory voice inflections or non-verbal signals.

Reasons for wanting a computer in an office or refusing to consider the possibility of a machine may be irrational, camouflaging personality clashes or collective discontent. Are there nuances that will reveal a latent discontent, leading in time to a pay claim for operating the computer or disproportionate trouble over the noise made by a cooling fan or printer? Remember that participation in making decisions about the computer system will help to commit people to the success of the venture. You are unlikely to infect everyone with your own degree of enthusiasm, so aim

for satisfactory solutions to problems rather than total conversion.

In practical terms, you will need a steering group to agree how the system is to be introduced: another committee in a world already sinking beneath the weight of discarded plastic coffee cups left over from diffuse, frustrating discussions that go nowhere and achieve less. Yet whether you have a formal committee or a gang of people who meet from time to time to overcome common problems, you must talk through the introduction of any effective computer system before it arrives and for some time afterwards.

Time spent in the steering group is an investment that will pay you handsome dividends over and over again as your plans progress. The steering group will have to include both the people who will use the computer and those who will simply be affected by the machine. Nothing will lead you more quickly towards an industrial-relations disaster than spending time with the people who are playing with the new toy to the exclusion of staff doing a long-standing and valuable job for the company. An overall agenda for consideration by the steering group is set out in the panel on the next page.

As well as working with the steering group you should talk individually to members of staff in your department. Each of them will have a personal perspective on the machine; some will feel threatened about losing their job, others may fear a loss of status or that their work will become merely a matter of sitting in front of a terminal with a loss of social contact with other members of the department. Before the first meeting of the steering group you should have talked individually to all the people who report to you and should have eliminated as far as possible hostile or aggressive attitudes.

You cannot evade the question of job losses or job displacement. If you plan to reduce the number of staff as a consequence of introducing the computer system then you will do so most successfully by honestly declaring your intentions at an early stage. Staff should be given the opportunity to prepare alternative proposals, which will often have real benefit for the organisation. If you do hide the intention of making staff redundant then the remaining staff are unlikely to trust you in the future.

There are differences between small computers and large systems when you come to press the switch that will start the machine for its first day of work. A small computer will often be employed for a number of tasks, and the order in which you start to put them on to the machine may be far more flexible than on a larger

(continued on next page)

Table 1. Criteria for humanising management information systems.

Procedures for dealing with users

- The language of a system should be easy to understand
- Transactions with a system should be courteous
- A system should be quick to react
- A system should respond quickly to users if it is unable to resolve its intended procedure
- A system should relieve users of unnecessary chores
- A system should provide for human information interface
- A system should include provisions for corrections
- Management should be held responsible for mismanagement

Procedures for dealing with exceptions

- A system should recognise as much as possible that it deals with different classes of individuals
- A system should recognise that special conditions might occur that could require special actions by it
- A system must allow for alternatives in input and processing
- A system should give individuals choices on how to deal with it
- A procedure must exist to override the system

Action of the system with respect to information

- There should be provisions to permit individuals to inspect information about themselves
- There should be provisions to correct errors

There should be provisions for evaluating information stored in the system

There should be provisions for individuals to add information that they consider important

It should be made known in general what information is stored in systems and what use will be made of that information

The problem of privacy

In the design of a system all procedures should be evaluated with respect to both privacy and humanisation requirements

The decision to merge information from different files and systems should never occur automatically. Whenever information from one file is made available to another file it should be examined first for its implications for privacy and humanisation

Guidelines for system design having a bearing on ethics

- A system should not trick or deceive
- A system should assist participants and users and not manipulate them
- A system should not eliminate opportunities for employment without a careful examination of consequences to other available jobs
- System designers should not participate in the creation or maintenance of secret data banks

From Computers and Management in a Changing Society by Donald Sanders and Stanley Birkin

Steering groups

A steering group can provide a means of focusing discussion on to issues surrounding the introduction of a computer. The group will be useful after the machine has arrived as well as during the planning stages. Dealing with the choices and problems that surround the introduction of a computer can be a rewarding part of working with other people; equally, bad management, suspicion and unresolved hostility can wreck a well-intended and useful plan.

- **The time-scale for implementation.** Will the whole system start work from day 1 or will parts of the system be brought into operation at different times? Will you choose the "big bang" approach to entering data into the computer, aiming to transfer your records within the shortest possible time? Or will you go the "continuous evolution" route in which you put all your new records and transactions on to the machine and work backwards through your old records at a defined and agreed rate to add them to more recent ones?

- **Personnel.** Do you plan to train a group of people to use the computer, excluding others from operating the machine; or will all the staff in the department be able to do work on the machine? I have seen incipient problems in a GP surgery where the computer terminal was placed in an upstairs room and a single person was responsible for developing the system to the stage where other members of the staff could use the computer on a routine basis. The woman entering the data began to feel isolated from the other members of the staff, and discontent about "that computer upstairs" could be felt among the clerks working on the reception desk. At the same time there may be sound reasons for making one person responsible for "housekeeping" tasks around the computer.

- **Associated changes in the organisation.** The Health and Safety at Work Act should concern you at this point. Some of the wilder claims about the dangers of VDUs have subsided but there are occupational-health matters as well as the pragmatic details of office organisation.

Using a VDU can precipitate a binocular instability in people who manage very well in normal circumstances. Concentrating for long periods on a screen at a close distance and typing from unsupported documents can generate headaches and backache if the ergonomics of the VDU and keyboard design are inadequate. Just because the equipment looks smart it's not always comfortable to use.

Will you need to resite telephones or desks to allow the computer to function efficiently? Printers are noisy and distracting pieces of equipment, and though acoustic hoods are available they take up considerable areas of desk space. How will the inevitable wires be routed to avoid the risk of somebody tripping and breaking their neck?

Will the lighting in the office have to be altered to avoid glare from the VDU screen? What changes in work flow will there be within your department and between you and other parts of the organisation? For example, a general practitioner will have to print out the notes held on his or her computer when a patient moves and registers with another doctor. The task is routine but should be planned for a quiet part of the week.

- **Plan for failure.** Things will go wrong at any level, from incorrectly installed keytops on the keyboard so that the instruction manual does not match the terminal you are using, all the way up to the loss of 10Mbyte of typing when someone erases a hard disc with no back-up copy. RS-232 serial terminals are standard only in that the same label is used for the interface.

What will you do when your keen, highly motivated office junior or surgery receptionist says "I'm not going back on that bloody machine"? How will you cope when somebody disconsolately brings you a printout that looks like a hex dump of the machine's monitor program and says "I can't get that letter on the word processor to print properly"? You will be lucky to avoid a trough in morale some time during the machine's installation period. If you are not prepared it can shake your own confidence, and that will be a disaster.



(continued from previous page)

installation. In other words, your choice of the first job to go on to the computer may be made for reasons that have nothing to do with the mechanics of the system; it can be made for human reasons.

Choose an application that offers immediate results. There is nothing like a quick victory to hearten the troops and

consolidate your position as a leader. In small operations such as a general practice or hospital department, for example, word processing is an encapsulated use for the computer which you should be able to implement quickly without having to enter vast quantities of data. Users will be able to see results from a word-processing program in as little as 20 minutes and it can

productively be brought into the work of the surgery or the department in a few days.

Resist the temptation to move on to the next application too quickly. Assess the attitudes of the users before your personal thirst for progress has you rushing ahead. As with all management you must aim to lead from the front, but without being so far in advance as to be out of touch.

When it's time to stop playing games and get down to business...

Unfortunately, many of today's desk top computers are designed with too much emphasis on home use. That's fine, if you want to balance your checkbook, play "space war" or draw pictures. But when you have serious business requirements for a computer, you want one designed specifically for business.

The RAIR Business Computer is just that. A computer designed specifically for business applications, incorporating a host of features—optimised for the business environment. 8- and 16-bit microprocessors allow users to run available 8-bit—plus newer 16-bit—applications software simultaneously. And an integral high-capacity Winchester disk drive—plus provision for additional hard disk support—provides sufficient on-line storage for virtually any business application.

Advanced communications software allows the RAIR Business Computer to connect to mainframe systems and networks. And expanded RAM memory supports simultaneous access from up to four user workstations, each including an ergonomically designed, detached keyboard, high-resolution colour display, and optional workstation printer.

So if you're serious about a computer for business, call RAIR for details about our Business Computer. We're not playing games.

RAIR Limited
6-9 Upper St. Martins Lane
London WC2H 9EQ
Phone (01) 836 6921, Telex 298452

• Circle No. 181

SYSTEM SPECIFICATION

Microprocessors: Concurrent 16-bit 8088 plus 8-bit 8085

RAM Memory: 256 kbytes expandable to 1024 kbytes

Integral Disk Storage: 19-Mbyte Winchester drive plus 1-Mbyte floppy drive

Storage Options: Up to 4 add-on Winchester drives plus streaming tape backup

Communications: 4 workstation ports (RS-422-compatible), plus 2 synchronous/asynchronous programmable RS-232 ports

WORKSTATIONS (up to 4)

Keyboard: Ergonomic, low-profile, 83 keys, 10 programmable function keys, 10-key numeric keypad (with cursor/editing functions)

Color Display: High-resolution, 80 characters x 25 lines, upper and lower case, 8 programmable foreground/background colors

Printer: Bidirectional, 80 characters-per-second, friction and tractor feed

SOFTWARE

Operating System: User-friendly, multi-tasking, CP/M, MP/M, PC-DOS compatible

Languages: BASIC, COBOL, Pascal

Applications: Spreadsheet, Database, Text Processing Communications

CP/M and MP/M are trademarks of Digital Research
PC-DOS is a trademark of IBM

the RAIR Business Computer.



Looking ahead on a micro

Adrian Hill describes how to forecast the effect of altering one variable in complex real-life systems.

ONE WIDELY USED method of forecasting is to devise a model which accurately reflects the past behaviour of a system and then uses it to predict the future behaviour. The model is usually a mathematical one: in general, the more complex the model the more accurate the results, and it is common to use extensive sophisticated numerical methods in good models.

The KSIM forecasting method uses very simple mathematics. There is one equation to use, and the most complex function used

is exponentiation, but though the maths is fairly simple the results can be useful.

The method was devised by Julius Kane and is now one of the standard methods used in systems dynamics, a discipline concerned with the way in which a system's parts interact to influence its overall behaviour. KSIM is specifically concerned with finding the particular variables relevant to the behaviour of the system and evaluating the way in which pairs of variables affect each other.

For example, if you wish to examine the behaviour of a simple local transport system you might decide to consider:

- use of private cars
- use of buses
- use of tube
- price of petrol
- price of diesel
- price of electricity

These variables are not the only ones which could be considered; they are simply possible candidates.

```

rem
rem .....
rem
rem      KSIM simulation program
rem      written for BASIC-2 compilers
rem      running under CP/M.
rem
rem .....
rem
rem .....
rem
rem      variables etc. used in this program
rem
rem      cim(x,y) - cross impact matrix
rem      vname$(x) - variable name
rem      vval(x) - current variable magnitude
rem      nval(x) - next variable magnitude
rem      z1 ... z17 - counters
rem      an$ - users response
rem      var - number of variables
rem      inerr$ - input error flag
rem      temp - processed user response
rem      ins - no. of steps in time period
rem      per - time period
rem      namef$ - file name
rem      (tempu )
rem      temp1 ) parts of the main
rem      tempv ) equation.
rem      temps )
rem      xpou )
rem      xpol ) parts of exponent
rem      sxpo )
rem      za$ - unused user response
rem .....
rem
rem      set up arrays with max. no. of elements
rem
rem      dim cim(20,20), vname$(20), vval(20), nval(20)
rem
rem
rem      *** print into. message to screen
rem
rem      for z2 = 1 to 5
rem      print chr$(12)
rem      for z1 = 1 to 250 : next
rem      print : print
rem      print" * ..... *"
rem      print" * * ..... *"
rem      print" * K S I M S I M U L A T I O N *"
rem      print" * ===== *"
rem      print" * * ..... *"
rem      print" * * ..... *"
rem      print" * adapted by A P Hill, Jan '82 *"
rem      print" * from a method by Julius Kane. *"
rem      print" * * ..... *"
rem      print" * * ..... *"
rem      for z1 = 1 to 750 : next
rem      next z2
rem
rem      *** check if data is on disk, or to be
rem      *** input manually from the console.
rem
rem      print chr$(12)
rem      input" is your data already on disk (y/n);an$
rem      if (an$ = "I") or (an$ = "y") then 20 else 30
rem
rem      *** load data from disk file in next section
rem
rem      20 input" enter the name of the data file"; namef$
rem      file namef$
rem      print" reading data...."
rem      read z1; var
rem      for z3 = 1 to var
rem      read z1; vname$(z3)
rem      next z3
rem      for z9 = 1 to var
rem      for z8 = 1 to var + 1
rem      read z1; cim(z9,z8)
rem      next z8
rem      next z9
rem      for z7 = 1 to var

```

	Car use	Bus use	Tube use	Petrol price	Diesel price	Elec. price	Ext. sources	Starting value
Car use	-1	0	+1	-2	+2	+1	+1	0.7
Bus use	-1	+1	-1	+1	-1	+1	-1	0.3
Tube use	+1	-1	-1	+1	+2	-1	0	0.5
Petrol price	-1	+1	0	-1	+2	+1	+1	0.6
Diesel price	+1	0	-1	+2	0	+1	+1	0.6
Electricity price	0	0	0	+1	0	0	+1	0.6

The impact is that of the variable along the top, on the variable down the side.

Table 1. Cross-impact table for local transport example.

Any number of variables could be chosen: with six variables there are 36 interactions, or cross-impacts, between pairs. An extra variable must be added to represent the impact of all other sources on each of your six variables. There is no need to consider the impact of your variables on this external variable as it is assumed that they have no significant effect.

A numerical notation is used to denote the effect of the cross-impacts. In this implementation the values are limited to the range 0 to 3, though in other programs the range may easily be changed. The number indicates the magnitude of the impact: a cross-impact value of zero indicates that the variables have no effect on each other; a

value of 3 indicates a very large effect. The cross-impacts may be either positive or negative. A positive impact indicates that the effect is in the same direction, and a negative impact indicates that the effect is in the opposite direction to the cause.

Once you have decided the values of the cross-impact variables they can be tabulated as shown in table 1. Three of the values were arrived at as follows:

Impact of petrol price on car use: if petrol costs rise, people are more reluctant to use their cars; impact is -2.

Impact of petrol price on tube use: if people use cars less as petrol price increases, some of them will use tube; impact is +1.

Impact of diesel price on petrol price: when

diesel price rises, all other oil products would probably increase in price; petrol is transported in trucks; impact is +2.

In the cross-impact table the most important column is the one marked External. In it you can change the number to represent the effect of any extra conditions you may wish to impose on the system. This can be useful for evaluating the effect of proposed new legislation: for example, if you wish to see what the effect would be of prohibiting the use of private cars use the value -3 for the impact of External upon car use.

After testing the other values in the cross-impact table with a few trial runs you adjust them to give a fairly good representation of the past behaviour of the system. The model is then ready to predict future behaviour, and you can alter the External effects to test particular options open to the system.

Having set up the cross-impacts it is necessary to represent the actual magnitude of the variables. The KSIM method requires that the values representing the magnitude of the variable must lie in the range 0 to 1. If you consider that car use is now as high as it could be, allocate the value 1; if you consider tube use is very low, use the value 0.1. The

(continued on next page)

```

read £1; vval(z7)
next z7
read £1; per, ins
close 1
print"  all data loaded."
goto 180
rem
rem *** load data from console in next section. ***
rem
30 print : print
input"  how many variables"; var
print"  now enter a name for each variable:"
  for z10 = 1 to 500 : next
  print chr$(12)
  for z6 = 1 to var
  print"  no. "; z6 ; " variable name";
  input vname$(z6)
  next z6
  print chr$(12)
  print : print
  print"  now enter the cross impact values:"
  print"  use values between 0 and 3."
  print"  either +ve or -ve."
  print : print
  for z5 = 1 to var
  for z4 = 1 to var
100  print"  impact of "; vname$(z4); " on "; vname$(z5);
  gosub 1000
  if (inerr$ = "yes") then print"*** invalid entry ***": goto 100
  cim(z5,z4) = temp
  next z4
110 print"  impact of EXTERNAL on ";vname$(z5)
  gosub 1000
  if(inerr$ = "yes") then print"*** invalid entry ***": goto 110
  cim(z5,var + 1) = temp
  next z5
print chr$(12)
print : print
print"  now allocate starting value "
print"  for each variable."
print : print"  use values between 0.00 and 1.00"

for z11 = 1 to var
120 print"  enter value for "; vname$(z11);
  input temp
  if ( temp>1.00) or ( temp<0) then 130 else 140
130 print"*** invalid entry ***" : goto 120
140 vval(z11) = temp
  next z11
  print chr$(12)
  print : print : print
  input"  state time period in years"; per
  print : print
  input"  state number of steps within this period"; ins
  rem
  rem *** check if data is to be written to ***
  rem *** the data file for future use. ***
  rem
180 print chr$(12)
  print : print : print
  input"  write data to 'KSIMDATA' (y/n)"; an$
  if ( an$<>"Y") and ( an$<>"y") then 190
  rem
  rem *** write data to disk file in next section. ***
  rem
  namef$ = "KSIMDATA"
  file namef$
  print £1; var
  for z12 = 1 to var
  print £1; vname$(z12)
  next z12
  for z13 = 1 to var
  for z14 = 1 to var + 1
  print £1; cim(z13,z14)
  next z14
  next z13
  for z15 = 1 to var
  print £1; vval(z15)
  next z15
  print £1; per, ins
  close 1
  print : print

```

(listing continued on next page)

Looking ahead on a micro

(continued from previous page)

allocated values should reflect the magnitude of the variable at the start of the simulation.

If you want the model to reflect the past behaviour of the system, allocate values that reflect the state of each variable at that time in the past from where your run is to start. The values are only set at the start of the simulation; the program itself will change them as the simulation proceeds so that they always represent the current value of each variable. With the variables identified, set up and evaluated, you now have to specify the period for which you wish the simulation to run and the length of the time intervals within that period.

The KSIM method calculates the new value for the magnitude of each variable once during each time interval according to the following rules:

A variable will increase or decrease in magnitude according to whether the net impact upon it from the other variables is positive or negative.

A variable is less susceptible to the impact of other variables as it approaches its own upper and lower limits.

A variable produces a larger impact on the whole system as its magnitude increases. The new value for the magnitude of a variable at the new time ($t + \Delta t$) is related to the old value at time t by the following transformation:

$$|x_i(t + \Delta t) \leftarrow x_i(t)^{P_i}$$

where the exponent P_i is given by:

$$P_i(t) = \frac{1 + \frac{\Delta t}{2} \sum_{j=1}^N (|\alpha_{ij}| - \alpha_{ij}) x_j}{1 + \frac{\Delta t}{2} \sum_{j=1}^N (|\alpha_{ij}| + \alpha_{ij}) x_j}$$

where Δt is the time interval and α_{ij} is the cross-impact of variable x_j on variable x_i .

Although the equation looks involved, when expressed in ordinary English rather

than mathematical notation it becomes:

$$(1 + ((\frac{1}{2} \text{ of time interval}) \times (\text{sum of -ve impacts}))) + (1 + ((\frac{1}{2} \text{ of time interval}) \times (\text{sum of +ve impacts})))$$

The value of P_i varies for each of the variables according to the value of the cross-impacts upon it and the magnitude of the variable acting on it. It must be calculated explicitly each time it is required.

The program is written for the Basic-E compiler running under CP/M. Non-CP/M users may be unfamiliar with the fact that line numbers are optional on statements other than those to which control is passed directly. Figure 1 shows the algorithm on which it is based. The main part consists of three nested For-Next loops. The inner loop evaluates the sum of the cross-impacts from each variable to give the exponent required by the middle loop, which recalculates the magnitude of each variable. Each calculation is done once during each loop of the outer loop, which represents the time period.

The program is self explanatory when running, but you should note down the cross-impact table and starting values before starting as it is easy to become confused when entering lots of numerical data. The first input required is to state whether you will enter data manually from

(listing continued from previous page)

```

print"  written data to 'KSIMDATA'."
rem
rem *** next section is the part including      ***
rem *** all of the calculations.                ***
rem
190 print chr$(12)
print : print
print"  Ready to proceed...."
print : print
input"  enter any key to start.": za$
print chr$(12)
namef$ = "KSIMRSLT"
file namef$
pbi = per / ins
print $l; var
rem
for time = 1 to per step pbi
rem *** Add plotting routine here.              ***
rem *** to plot nval(1) ..... nval(var)        ***
rem *** if graphics are available in your system. ***
  for z13 = 1 to var
    tempu = 0 : templ = 0
  rem
  rem
  for z14 = 1 to var + 1
    tempv = cim(z13,z14)
    temps = (vval(z13))*tempu
    if ( tempv<0 ) then 300
    templ = templ + temps
    goto 400
  300  tempu = tempu + abs(temps)
  400  next z14
  xpou = 1 + ( pbi * tempu )
  xpol = 1 + ( pbi * templ )
  sxpo = xpou / xpol
  nval(z13) = vval(z13)^sxpo
  next z13
for z17 = 1 to var
  vval(z17) = nval(z17)
  print $l; nval(z17)
next z17
print"  completed time period no.": time
print : print
next time
rem
rem *** this is the end of the main section      ***
rem *** now print final value of each variable   ***
rem *** to the screen.                          ***
rem
print chr$(12)
print : print
print"  Final Values are:"
print
for zz = 1 to var
  print"  ";vname$(zz);" - "; int(100*nval(zz))/100
next zz
stop
rem
rem *** next section is the subroutine to test   ***
rem *** that the cross-impact values lie in the ***
rem *** range 0 to 3.                            ***
rem
1000 input temp
    if ( abs(temp)>3) then 1100
    inerr$ = "no"
    return
1100 temp = 0
    inerr$ = "yes"
    return
rem
rem *** end of this program.                      ***
rem
end

```

the keyboard or load it from a disc file. If manual entry is selected, the inputs required are:

- The names to be used for each variable.
- The cross-impact table, one element at a time, entered by name as prompted by the program.
- Starting magnitudes for each variable.
- The time period to be used for the run.

The results output to the results file are intended for plotting in graphical form and are not labelled in any way. The plotting should ideally take place during the simulation run, in which case numerical output to the results file would not be required.

No graph-plotting routine is included in the program, as graphics capabilities vary too widely from machine to machine for such an example routine to be of any use; individual users should add such routines as their machines will allow where indicated in the program. If this is not possible, then either the results should be plotted by a separate program or drawn by hand.

The program opens the results file as a sequential file and will write in the results as

a simple list of numbers. The first number is not actually part of the results but simply states the number of variables used in the simulation. The results themselves follow, and are the successive magnitudes for each variable.

For each time interval there will be one new value for each of the variables. You must skip several results each time. For example, if there were five variables in the simulation then reading every fifth number in the results file would give the successive magnitudes of one of the variables.

The program creates an additional output file containing the cross-impact and initial magnitude data, together with the time period and number of intervals in a form suitable for direct reading by the program as input data at any subsequent run. This file is named KSIMData, the results file being KSIMRslt.

The KSIM method is capable of producing very realistic results but, as always, poor data gives poor results. To generate an accurate simulation of a real system you must be quite sure you have included all relevant variables and used suitable values for the cross-impacts and original magnitudes. The choice of which variables to include in the system, their original magnitudes and the cross-impacts are all subjective decisions. Real systems may be influenced by many more sources than are apparent, and if any of these sources are omitted from a simulation the results will be invalid. □

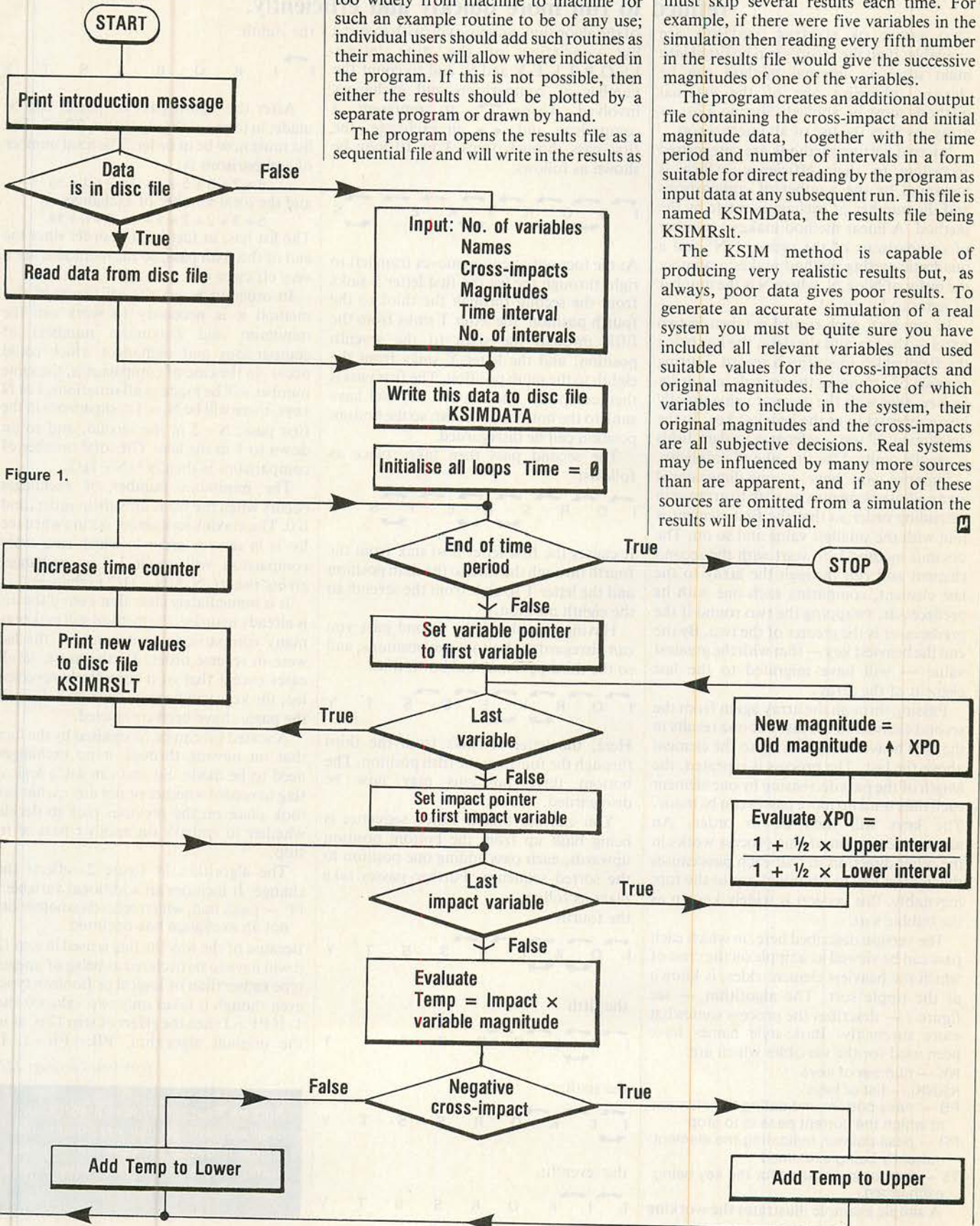

Figure 1.

Know your sort

Starting with a simple sorting procedure, Andrew Featherstone explains how it can be refined to run more quickly and efficiently.

TWO KINDS OF SORTING METHOD are available: if all the records can be fitted into main store an internal method can be chosen, otherwise one of the external methods must be applied. Sorting a list or array involves the use of an internal sort.

Internal sorting methods are categorised according to their efficiency, which is measured by the number of comparisons and the number of exchanges made by the method. A linear method makes a number of comparisons of the order of N^2 and a quadratic sorting method makes a number of comparisons of the order of $N \log_2 N$, where N is the number of items to be sorted.

In any sort, each record is taken in two parts — the key and the data, the key being the field which identifies a record. Sorting consists of arranging the records into order by key, that with the greatest value usually being referred to as the heaviest key. In the description of sorts, reference to data fields is usually omitted for the sake of simplicity.

Suppose you have a one-dimensional array whose elements you wish to arrange in ascending order so that the first element is that with the smallest value and so on. The obvious method is to start with the second element and run through the array to the last element, comparing each one with its predecessor, swapping the two round if the predecessor is the greater of the two. By the end the heaviest key — that with the greatest value — will have migrated to the last element of the array.

Passing through the array again from the second element to the last but one results in the next heaviest key sinking to the element above the last. The process is repeated, the length of the pass decreasing by one element each time until no more passes can be made. The keys will then be in order. An alternative version of this process works in the other direction so that each pass causes the lightest key to "bubble" up to the top; inevitably, this version is widely known as the bubble sort.

The version described here, in which each pass can be viewed as a ripple on the crest of which the heaviest element rides, is known as the ripple sort. The algorithm — see figure 1 — describes the process somewhat more succinctly. Basic-style names have been used for the variables which are:

NK — number of keys
 K\$(NK) — list of keys
 PB — pass bottom, indicating the element at which the current pass is to stop
 PP — pass pointer, indicating the element currently being examined
 T\$ — temporary location for the key being exchanged.

A simple example illustrates the working

of the algorithm. Suppose you wish to sort a list consisting of the nine letters I, S, O, R, T, K, E, Y and S, and to count the number of comparisons and exchanges involved. Using \rightarrow to represent a comparison and \leftrightarrow an exchange, the first pass through steps 3 to 10 may be shown as follows:



As the focus of attention moves from left to right through the list the first letter S sinks from the second through the third to the fourth position, the letter T sinks from the fifth through the sixth to the seventh position, and the letter Y sinks from the eighth to the ninth position. The first pass is then complete. The heaviest key will have sunk to the bottom of the list, so the bottom position can be disregarded.

The second pass then takes place as follows:



It causes the first letter S to sink from the fourth through the fifth to the sixth position and the letter T to sink from the seventh to the eighth position.

Having completed the second pass you can disregard the bottom two positions, and so the third pass may be shown thus:

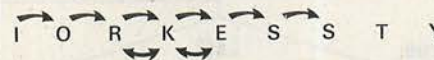

Here, the letter R sinks from the third through the fourth to the fifth position. The bottom three positions may now be disregarded.

You can see that a sorted sequence is being built up from the bottom position upwards, each pass adding one position to the sorted sequence. Further passes take place as follows:



the fifth

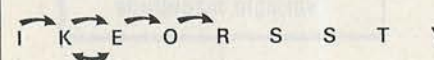

the sixth:

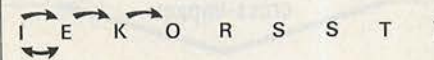

the seventh:

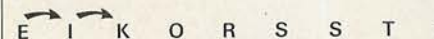

the eighth:



After the eighth pass no passes can be made; in terms of the algorithm $PB=1$. The list must now be in order. The total number of comparisons is

$$8+7+6+5+4+3+2+1=36$$

and the total number of exchanges is

$$5+3+2+2+1+1+0+0=14$$

The list has, in fact been in order since the end of the sixth pass, so the method is not a very efficient one.

In order to assess the efficiency of this method it is necessary to work out the minimum and maximum numbers of comparisons and exchanges which could occur. In the case of comparisons, the same number will be made in all situations. For N keys, there will be $N-1$ comparisons in the first pass, $N-2$ in the second, and so on down to 1 in the last. The total number of comparisons is then $N*(N-1)/2$.

The minimum number of exchanges occurs when the list is already in order, and is 0. The maximum number occurs when the list is in reverse order in which case every comparison will result in an exchange, giving rise to $N*(N-1)/2$ exchanges.

It is immediately clear that even if the list is already in order, the method still makes as many comparisons as it would if the list were in reverse order. Furthermore, in all cases except that of a completely reversed list, the keys will become ordered before all the passes have been completed.

A sorted list can be recognised by the fact that on passing through it no exchanges need to be made. So you can use a logical flag to record whether or not any exchanges took place on the previous pass to decide whether to embark on another pass or to stop.

The algorithm in figure 2 reflects the change. It includes an additional variable: PF — pass flag, which records whether or not an exchange has occurred

Because of the way the flag is used in step 12 it will have to be declared as being of integer type rather than of logical or Boolean type, even though it takes only two values 0 and 1. If $PF=1$ then the effect of step 12 is, as in the original algorithm, $PB:=PB-1$. If

(continued on page 122)

Andrew Featherstone is a software engineer with British Aerospace; this article is based on work done by the author as part of an HND project at Oxford Polytechnic.

Figure 1.

```

(1) PB: = NK
(2) repeat
    (3) PP: = 2
    (4) repeat
        (5) if K$(PP-1) > K$(PP)
            then (6) T$: = K$(PP)
                (7) K$(PP): = K$(PP-1)
                (8) K$(PP-1): = T$
        (9) PP: = PP + 1
    until PP > PB
    (10) PB: = PB - 1
until PB < 2
    
```

Figure 2.

```

(1) PB: = NK
(2) repeat
    (3) PF: = 0
    (4) PP: = 2
    (5) repeat
        (6) if K$(PP-1) > K$(PP)
            then (7) T$: = K$(PP)
                (8) K$(PP): = K$(PP-1)
                (9) K$(PP-1): = T$
                (10) PF: = 1
        (11) PP: = PP + 1
    until PP > PB
    (12) PB: = PB * PF - 1
until PB < 2
    
```

Figure 3.

```

(1) PB: = NK
(2) repeat
    (3) PF: = 0
    (4) PP: = 2
    (5) repeat
        (6) if K$(PP-1) > K$(PP)
            then (7) T$: = K$(PP)
                (8) K$(PP): = K$(PP-1)
                (9) K$(PP-1): = T$
                (10) PF: = 1
        (11) PP: = PP + 1
    until PP > PB
    (12) PB: = PF - 1
until PB < 2
    
```

Figure 4.

```

(1) PT: = 2
(2) PB: = NK
(3) PF: = 0
(4) repeat
    (5) PP: = PT
    (6) repeat
        (7) if K$(PP-1) > K$(PP)
            then (8) T$: = K$(PP)
                (9) K$(PP): = K$(PP-1)
                (10) K$(PP-1): = T$
                (11) PF: = PP
        (12) PP: = PP + 1
    until PP > PB
    (13) PB: = PF - 1
    (14) if PB ≥ PT
        then
            (15) PP: = PB
            (16) repeat
                (17) if K$(PP-1) > K$(PP)
                    then (18) T$: = K$(PP)
                        (19) K$(PP): = K$(PP-1)
                        (20) K$(PP-1): = T$
                        (21) PF: = PP
                (22) PP: = PP - 1
            until PP < PT
            (23) PT: = PF + 1
until PB < PT
    
```

Exchange sort.

```

1100 REM STRAIGHT EXCHANGE SORT
1101 LET PB=NK
1102 LET PP=2
1103 IF K$(PP-1) <=K$(PP) THEN GO
TO 1107
1104 LET T$=K$(PP)
1105 LET K$(PP)=K$(PP-1)
1106 LET K$(PP-1)=T$
1107 LET PP=PP+1
1108 IF PP<=PB THEN GOTO 1103
1109 LET PB=PB-1
1110 IF PB>=2 THEN GOTO 1102
1111 RETURN
    
```

Logical ripple sort.

```

1200 REM LOGICAL RIPPLE SORT
1201 LET PB=NK
1202 LET PF=0
1203 LET PP=2
1204 IF K$(PP-1) <=K$(PP) THEN GO
TO 1209
1205 LET T$=K$(PP)
1206 LET K$(PP)=K$(PP-1)
1207 LET K$(PP-1)=T$
1208 LET PF=1
1209 LET PP=PP+1
1210 IF PP<=PB THEN GOTO 1204
1211 LET PB=PB*PF-1
1212 IF PB>=2 THEN GOTO 1202
1213 RETURN
    
```

Integer ripple sort.

```

1300 REM INTEGER RIPPLE SORT
1301 LET PB=NK
1302 LET PF=0
1303 LET PP=2
1304 IF K$(PP-1) <=K$(PP) THEN GO
TO 1309
1305 LET T$=K$(PP)
1306 LET K$(PP)=K$(PP-1)
1307 LET K$(PP-1)=T$
1308 LET PF=PP
1309 LET PP=PP+1
1310 IF PP<=PB THEN GOTO 1304
1311 LET PB=PB*PF-1
1312 IF PB>=2 THEN GOTO 1302
1313 RETURN
    
```

Shaker sort.

```

1400 REM SHAKER SORT
1401 LET PT=2
1402 LET PB=NK
1403 LET PF=0
1404 LET PP=PT
1405 IF K$(PP-1) <=K$(PP) THEN GO
TO 1410
1406 LET T$=K$(PP)
1407 LET K$(PP)=K$(PP-1)
1408 LET K$(PP-1)=T$
1409 LET PF=PP
1410 LET PP=PP+1
1411 IF PP<=PB THEN GOTO 1405
1412 LET PB=PF-1
1413 IF PB<PT THEN GOTO 1423
1414 LET PP=PB
1415 IF K$(PP-1) <=K$(PP) THEN GO
TO 1420
1416 LET T$=K$(PP)
1417 LET K$(PP)=K$(PP-1)
1418 LET K$(PP-1)=T$
1419 LET PF=PP
1420 LET PP=PP-1
1421 IF PP>=PT THEN GOTO 1415
1422 LET PT=PF+1
1423 IF PB>=PT THEN GOTO 1404
1424 RETURN
    
```

(continued from page 120)

PF=0 then its effect is PB:-1. PB becomes less than 2, so the condition $PB < 2$ holds and another pass is not started.

The same simple example as before will illustrate the difference in the working of the changed algorithm. Each pass takes place as follows:

First pass

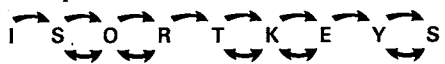

Second pass

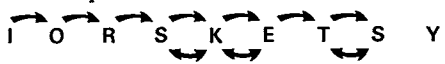

Third pass

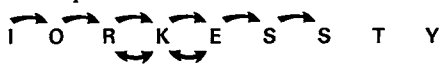

Fourth pass

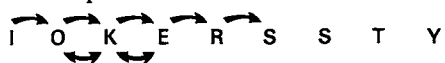

Fifth pass

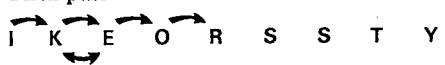

Sixth pass

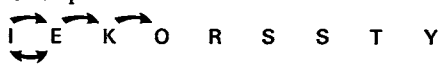

Seventh pass

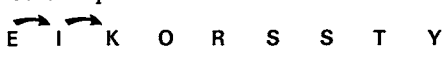

No exchanges were made in the seventh pass and so the list must now be in order; in terms of the algorithm $PB = -1$. The total number of comparisons is 35 and the total number of exchanges is 14.

In this example the revised algorithm has detected that an eighth pass would be superfluous and so saved itself from making an unnecessary comparison. The change has therefore increased the efficiency of the method by reducing to the minimum the number of comparisons. If given an ordered list of keys, this method will run through them once and then stop, having made $N-1$ comparisons. The maximum number of comparisons remains $N*(N-1)/2$. The minimum and maximum numbers of exchanges remain the same, 0 and $N*(N-1)/2$ respectively.

In the general case, rather than the best case of the ordered list or the worst case of the reversed list, some reduction in the number of comparisons almost always results. Yet the method is still not as efficient as it could be. Suppose that somewhere in the middle of the process a pass has just been completed somewhere near the bottom of the list during which the last exchange took place somewhere near the top of the list. An exchange having occurred, another pass commences to run from the top of the list down to the element which was the last but one in the previous pass. Since the last exchange occurred somewhere near the top of the list, all the elements from then on must have been in order, and the comparisons made by the new pass after the element at which the last exchange took place are unnecessary.

By making the flag introduced in the last

method an integer variable rather than a logical one it can be used to record the position at which an exchange takes place. So at the end of a pass the flag will hold the position at which the last exchange occurred. The algorithm in figure 3 demonstrates this new use. The variables are as before except that PF now takes integer values other than 0 and 1.

Using the previous example, the working of the new algorithm can be illustrated as follows:

First pass

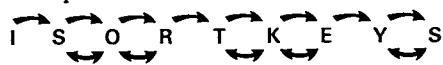

Second pass

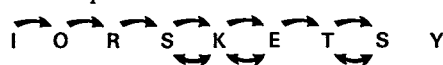

Third pass

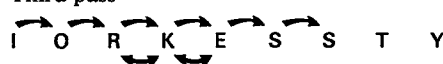

Fourth pass



Fifth pass



Sixth pass



In the sixth pass the last exchange was between positions two and one — in terms of the algorithm $PB=1$ — and so the list must now be in order. The total number of comparisons is 27 and the total number of exchanges is 14. The revised algorithm does not embark on an unnecessary seventh pass, and has thereby saved two comparisons. It also saves two unnecessary comparisons on each of the fourth, fifth and sixth passes. The efficiency of the method is therefore increased by the change.

At first sight there appears to have been no improvement in efficiency: the minimum and maximum numbers of comparisons remain unchanged at $N-1$ and $N*(N-1)/2$ respectively, and the same goes for the minimum and maximum number of exchanges at 0 and $N*(N-1)/2$ respectively. In the general case, however, a good reduction in the number of comparisons does follow from the change.

Yet there is still room for further improvement. Suppose you have a list of keys which are all in order except that the heaviest key is at the top end. The method will sort this list in one pass, during which the offending key will sink from the top to the bottom. So far, so good.

Now suppose you have a list of keys which are all in order except that the lightest key is at the bottom end. After one pass the method will have moved the offending key up by one element, and so to move the key to the top requires almost as many passes as there are keys. If passes ran not from top to bottom but from bottom to top the first

case would need many passes and the second only one. Rather than scanning in one direction only each time, the direction of scan can be alternated so that each pass consists of a scan in one direction followed, if necessary, by a scan in the other. This method is known as the shaker sort.

Figure 4 gives an algorithm for the shaker sort. There is one new variable:

PT — pass top, indicating the element at which the current upward-running scan is to stop, complementary to PB

Steps 5 to 13 are the old downward scan; steps 15 through 23 are the new upward scan. Step 14 prevents the upward scan taking place if the downward scan has found that the list has been sorted. The effect of the process is to cause sorted heavy keys to accumulate in the bottom end of the list and sorted light keys to accumulate in the top. The sort is complete when the sets of sorted keys in the ends meet in the middle — that is, when PB and PT have crossed.

Using \curvearrowright to represent comparisons in the upward scan the shaker sort acts on the previous example as follows:

First pass



Second pass

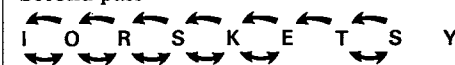

Third pass

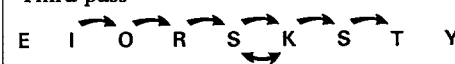

Fourth pass

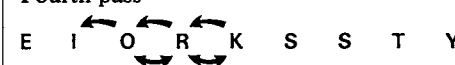

Fifth pass

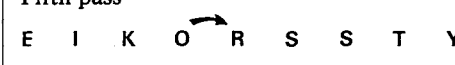

At the end of the fifth pass PB is less than PT, so the list is now in order. The total number of comparisons is 25 and the total number of exchanges is 14. In this instance the algorithm has reduced the number of comparisons by two.

The minimum and maximum number of comparisons and exchanges are unchanged by the new method: $N-1$ and $N*(N-1)/2$ for comparisons; 0 and $N*(N-1)/2$ for exchanges. In the general case an appreciable reduction in the number of comparisons is usually achieved, though a possibility of unnecessary comparisons occurring still remains.

Suppose that during an upward scan a light key is picked up, which comes to rest towards the top of the sorted sequence of keys which has grown at the top end of the list, so that there is a number of sorted keys below it. The next downward scan now starts from the element below the new arrival, running down through the sorted sequence below it and making comparisons which are unnecessary. A better place to start the downward scan would have been at the bottom of the sorted sequence, and the same applies to the complementary situation at the other end. □

Auto Word

Drive down disc drive prices!



Auto Word
CANON MDD 6106
£169
40 TK SS



Auto Word
CANON MDD 220
£229
1MB STORAGE

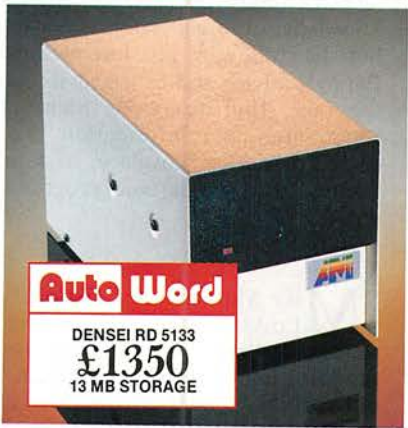

Auto Word
DENSEI RD 5133
£1350
13 MB STORAGE

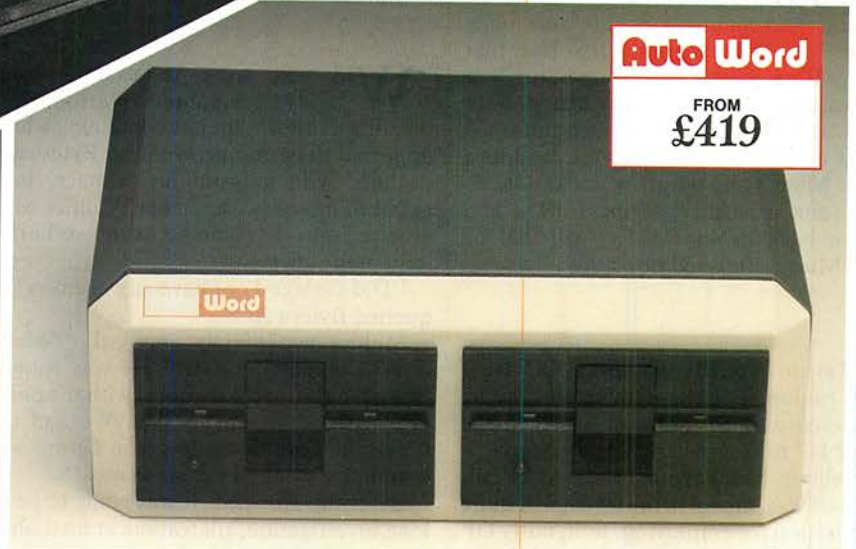

Auto Word
FROM
£419

CANON MDD 5 1/4" SLIM FLOPPY DISC DRIVES STD. INTERFACE

MODEL	NAKED DRIVE	SINGLE BOXED & PSU	DUAL BOXED & PSU
6106 (40 TK SS 250K)	£139	£169	£329
6108 (40 TK DS 500K)	£169	£199	£389
*120 (80 TK SS 500K)	£189	£219	£429
*220 (80 TK DS 1000K)	£229	£259	£509

*HARDWARE/SOFTWARE SELECTABLE TO RUN IN 40 TK OR 80 TK MODE WITH LED MODE SELECT DISPLAY

APPLE™ COMPATIBLE SLIM BOXED DRIVE

MODEL	SINGLE DRIVE	DUAL DRIVE
A6106 (40 TK SS 250K)	£180	£360

ALL CANON DRIVES CARRY A 12 MONTH WARRANTY!

CDC 5 1/4" FLOPPY DISC DRIVES PRICES FROM:	
SHUGART SA800 (8" SS) FLOPPY DISC DRIVE	£119
SHUGART SA850 (8" DS) FLOPPY DISC DRIVE	£319
TANDON TM848-1 (8" SS SLIM) FLOPPY DISC DRIVE	£429
TANDON TM848-2 (8" DS SLIM) FLOPPY DISC DRIVE	£349
	£399

THE AUTOWORD EXECUTIVE RANGE OF DUAL 5 1/4" and 8" BOXED DRIVES. TOP QUALITY UNITS. ALSO AVAILABLE WITH OWN LOGO AND COLOURS. PRICES FROM:

£419

HAVE YOUR FLOPPIES FLOPPED? AUTOWORD LEAD THE FIELD IN ACROSS THE RANGE DISC DRIVE REPAIR. COMPETITIVE PRICES ON APPLICATION.

5 1/4" WINCHESTER HARD DISC UNITS.

THE DENSEI HARD DISC (6.7M/13M) CONFIGURED TO RUN ON:

*TRS 80 III™ *APPLE II™ *IBM P.C.™

MODEL	PRICE	TRS 80 III/APPLE II	IBM PC
RD 5067 (6.7M)	£1195	With case, power supply, host adaptor, disk controller and software patches	To fit existing system with host adaptor and software patches
RD 5133 (13.3M)	£1350		

ALL PRICES ARE EXCLUSIVE OF VAT

The **Auto Word** is spreading!

AutoWord Services Ltd. 164 St. Pauls Avenue Slough Berks SL2 5ER Telephone: (0753) 78424/79599

● Circle No. 183

MONKEYNUT MYSTERY

by Peter van der Linden

"What?" roared the irate voice at Mike Multics the operations manager, who was nervously shuffling his feet. "Here I am negotiating bonus monkeynut sacks for my DP staff, and you come in whining about disc drives going down." The office door, sprawlily labelled T Watson, DP Manager, was quivering under the outburst almost in sympathy with the operations manager within. "And stop shuffling your feet."

The little operations manager stilled his feet and tried again. "I wouldn't normally bother you, Mr Watson. It's just that George Fore, my night-shift operator, was underneath the disc drive when it went down. It fell on him. He's been squashed as flat as day-old beer. He's as dead as a dodo. Mind you, the drive looks OK — we'll soon wipe the stickiness off it and have it back in service. Er, will that be all?" Multics finished hopefully.

Watson rolled his eyes in frustration. For the umpteenth time he wondered why he had ever accepted the job of DP manager with Mighty Marvin's Marvellous Monkeynuts Ltd. After all, 4M, as it was known in the trade, had quite a reputation for employing, well, nutty DP staff. Watson inwardly wished he had followed his grandfather and father into the family business, selling Itty-Bitty Machines from a stall in the Saturday market. Outwardly, he stifled his immediate urge to fire the operations manager, and reached for the telephone instead.

Two hours later the last worldly remains of George, the squashed operator, has been neatly scooped up and decanted into jam jars. Watson turned round to find a rotund individual with a tatty ginger beard surveying him coolly.

"My card," said the stranger, presenting it with a grandiose flourish. "The agency sent me. I believe I may be of some assistance to you."

Watson took the proffered item and examined the finely engraved script. It read:

"A P L Byteswap, Computer Consultant. Bugs located." Watson idly turned it over, and noticed that the reverse was also engraved: "A P L Byteswap, Private Detective. Locations bugged."

The DPM made a quick decision. "Alright," he said, "Find out what happened, and I'll pay agency rates plus two sacks of monkeynuts."

"Done" agreed Byteswap, who would have been willing to settle for the agency rate plus one sack.

"Will you want to examine the body?" enquired Watson, indicating a row of jam jars containing what appeared to be cranberry sauce. Byteswap declined with a fastidious grimace, but asked to interview the finder. Multics was escorted into the room between two burly data prep supervisors.

"Did George Fore have any enemies?" queried Byteswap.

Multics was plainly annoyed. "What does it matter if he did? He was found locked in the machine room, with the only key in the door on his side. We had to break the door down to get in before we even knew what all the noise was."

Byteswap frowned. It was going to be a long investigation, till teatime at least and perhaps the best part of tomorrow morning as well. There was only one possible way of speeding up the inquiry and getting all those monkeynuts in time for the weekend: Byteswap would consult the Pre-antipenultimate One.

The PO was an artificially intelligent program which could only be run from a smart Japanese terminal. The unusual name stemmed from the time it had proved Fermat's fourth-to-last theorem. It was at least 57th generation by now, as Byteswap had been working on it haphazardly for several years.

It had started life as a combined syntax editor

and pattern matcher, but Byteswap had elegantly bootstrapped it up. He had incorporated more and more features in each version, until it had evolved into a general-purpose problem solver. It used to spend a lot of time upgrading itself, until eventually it became bored.

Nowadays its only fault seemed to be a distressing, atavistic tendency to lisp. If Pappy, as Byteswap lovingly referred to it, was disposed to talk to him, he would surely soon have the answer to the mystery.

"Cherchez la femme," lisped Pappy tentatively. "Honi soit qui mal y pense," and obstinately refused to discuss the matter further until Byteswap installed an extra megabyte of memory. Byteswap's knowledge of foreign languages was small, but he followed his interpretation of Pappy's advice and collected six slaps on the face, four telephone numbers and some interesting information. The last came from Miss Lovelace, a statuesque brunette who was the chief programmer at 4M.

"Mike Multics killed George," Miss Lovelace confided in breathless tones. "George and Mike were rivals for my affections. I knew one of them would kill the other sooner or later. Men do that over me, you know. I suppose Mike will go to prison, and poor George is no more. Who will look after me now?"

Miss Lovelace poignantly leaned towards Byteswap, fluttering her soft eyelashes. Byteswap turned

three shades of red, coughed nervously and suddenly remembered an urgent appointment elsewhere. Things were getting out of hand, he decided.

Byteswap drove straight to the Watsons' market stall. "Another insoluble case?" old Mr Watson jeered, as they strapped the memory boards on to the back of Byteswap's motorcycle. At home, Byteswap speedily installed the memory upgrade and powered up the system.

Pappy came straight to the point. "It's quite thimble" the oracle rumbled. "Miss Lovelace killed George Fore. She did it out of hatred of the operations department, caused by too many late-night call outs."

Byteswap listened avidly as the machine thundered on.

"The modus operandi was also thimble. Lovelace wrote a two-stage program, to drive the disc which crushed George. The first stage merely set the disc-status light on and called for operator attention. When the luckless operator came over and pressed the reset button, it triggered the second part of her program. It repeatedly accessed the outer track of the highest disc at a furious pace.

"Lovelace had previously loosened the disc fastenings, and after a second or two the tremendous pounding of the disc head destabilised the entire unit. It toppled forward and made cranberry sauce out of poor George Fore."

Incredulous, Byteswap inquired how Pappy had reached this solution.

"Bah! Xyzzy! Thimble! I asked the 4M mainframe," was the scornful reply. "And I've already shopped Lovelace direct to the Police National Computer, Interpol, Fore Meade, and GCHQ Cheltenham. The criminal! That disc unit could have been permanently damaged."

Byteswap roared back to 4M to claim his coveted monkeynuts. As he arrived Miss Lovelace was being ushered into a police van. She was fluttering her eyelashes at the sergeant, and Byteswap faintly overheard her plaintively asking him who would look after her now.

Inside the 4M factory Watson welcomed Byteswap into his office, where the tubby detective outlined the whole incredible story. The grateful DPM immediately tossed Byteswap the promised monkeynut bags and promised to cancel night-shift operations and programmer call outs immediately.

"I imagine this must have been the trickiest case you've ever solved?" Watson suggested.

Byteswap chuckled reprovingly, "No, no," he contradicted, mentally suppressing

Pappy's role. "That distinction belongs to the events surrounding the tragic demise of old Professor "Pop" Stacks, who choked to death on a fission chip. Nobody knew the cause of death until I discovered that Stacks had been nibbling a 64K RAM chip."

"Great heavens!" exclaimed Watson. "What a tragedy." "I'll say," agreed Byteswap. "64K RAM chips were scarcer than hen's teeth at the time."

"But how did you ever establish the cause of Stacks' death?" persevered the DPM.

Byteswap smiled inscrutably. "Alimentary, my dear Watson," he replied and popped another marvellous monkeynut into his mouth.



Enveloped by BBC sounds

THE BBC MICRO has an exceptionally powerful noise-generation facility. Three tone generators, a white-noise source and the Envelope command together make for a system that can do almost anything from providing laser zaps to playing Wagner as a three-part harmony. But to make even one channel produce a complex sound involves setting up no less than 18 parameters — 14 for Envelope and four for the Sound — many of which interact in subtle ways.

This program makes the sound commands easier to understand by allowing you to change one or more parameters and listen to its effect immediately, without having to type in all the others at the same time. That in itself is useful, but the program makes life even easier by drawing the pitch and amplitude envelopes on the screen for you. You can change a parameter, see immediately how it should alter the sound, adjust it if that is not correct and listen to the result whenever you like.

The program splits the screen into two parts. The lower third shows the Envelope and Sound statements with all their parameters. The top of the screen is taken up by a graphics display of the pitch and amplitude envelopes generated by those statements. The graphs only show the first five seconds of any sound; for the program to fit into a 32K machine, no room is

David Peckett's program makes learning to use the BBC Envelope and Sound commands easier.

Table 1. Main program areas.

Lines 140-250 format the screen.
 Lines 260-370 define the system variables.
 Lines 50-660 are the heart of program, selecting the next operation to be performed.
 Lines 700-790 perform cursor control
 Lines 1070-1420 scan the keyboard, read in a number, keeping it in the correct space, and check it for validity. If it is correct the system is updated, otherwise the old value is retained.
 Lines 1450-1480 make the noise.
 Lines 1640-2220 draw the amplitude envelope.
 Lines 1760-1870 draw the attack phase.
 Lines 1900-2000 draw the decay phase if needed.
 Lines 2030-2110 draw the sustain phase, if needed.
 Lines 2140-2220 draw the release phase, if anything left.
 Lines 2250-2790 draw the pitch envelope.
 Lines 2330-2370 handle pitch autorepeat.
 Lines 2600-2710 handle the case of the pitch trying to go past 0 or 255 and wrap it round as necessary.

available to make it adjust the time scale automatically. In practice, five seconds is plenty long enough to see and hear how a sound behaves.

The graphs are scaled vertically from 0 to 255, and the two envelopes appear on the same axes; the BBC Micro defines frequencies as being from 0 to 255 and amplitudes from 0 to 126. To make it easy to tell the two graphs apart, the pitch envelope is drawn in red and that for the amplitude in yellow; against a cyan background colour both are perfectly clear in colour and in monochrome.

The program cannot actually control all 18 of the parameters in the Envelope and Sound statements. Since it automatically sets up Envelope 1 and uses Sound channel 1 to make the noise, there is no point in altering these three parameters, which do not alter the sound anyway. Any of the remaining 15 may be altered independently of each other by using the Left and Right Arrow keys to position the cursor and typing in the desired value. All the values are checked and the program will prevent you setting any value out of range.

The program can be instructed to update the graphs automatically every time you alter a parameter or — shades of VisiCalc — only when you wish to. The mode selected is displayed by a H for Hold, or I for Immediate in the top right of the

BBC sound demonstration program.

```

L.
10 REM** ENVELOPE and SOUND demos
20 REM** 14.11.82, by David Peckett
30 MODE1
40 DIM Pm(18),NpM(18),VpM(18),PmSize(
1:18),Sequence(19)
50 PROCInit:REM** Set things up
60 PROCEnv_snd_snd
70 PROCMain:REM** Do it
80 *FX4
90 CLS
100 END
110
120 REM** Set up the display
130 DEF PROCInit
140 UDU 28:0:31:39:26:REM** text area
150 UDU 19:0:61:0:19:3:0:0:REM** Ke-de
fine coils
160 CLG
170 GCOL 0:3
180 MOVE 120:239:DRAM 111:239:DRAM 11
1:1050:REM** Draw axes
190 UDU 5
200 MOVE 100:230:PRINT "0":MOVE 563:23
0:PRINT "2.5":MOVE 1095:230:PRINT "5":MOVE
71:250:PRINT "0":MOVE 7:639:PRINT "128":M
OVE 7:1023:PRINT "255"
210 MOVE 770:230:PRINT "(secs)"
220 UDU 24:112:240:1279:1023:29:112:24
0:REM** New graphics area
230 Hold:=TRUE:MOVE 1132:780:PRINT "H":
REM** Mark starting value
240 UDU 4
250 COLOUR 131:COLOUR 2:CLS
260 FOR I:=1 TO 18:Pm(I):=0:NEXT
270 Pm(1)=1:Pm(2)=1:Pm(15)=1:Pm(16)=1
REM** Starting values for parameters
280 FOR I:=1 TO 19:READ Sequence(I):
NEXT:REM** Sequence for cursor moves
290 FOR I:=1 TO 18:READ NpM(I),VpM(I),
:NEXT:REM** Screen pos of each
300 FOR I:=1 TO 18:READ PmSize(I),P
mSize(1,I):NEXT:REM** Limits
310 *FX 4:1
320 *Pm:=2:REM** % steps/10msecs
330 *Vp:=3:REM** % steps/unit
340 REM** Data for arrays
350 DATA 2:2,3:4,5:6,7:8,9,10,11,12,13
,14,17,14,17,18:18:REM** Parameter seq
360 DATA 0:2,5:2,10:2,15:2,20:2,25:2,
30:2,35:2,0:3,5,3,10:3,15,3,20:3,25:3,6,
5,11,5,16,5,21:5:REM** Param pos:ns
370 DATA 1,1,1,255,-126,127,-128,127,-
128,127,0,255,0,255,0,255,-127,127,-127,
127,-127,0,-127,0,0,126,0,126,1,1,1,1,0:
255,0,255:REM** Range of each param
380 ENDPROC
390
400 REM** Print the ENVELOPE and SOUND
parameters
410 DEF PROCEnv_snd_snd
420 CLS
430 PRINT "ENVELOPE":
440 PRINT TAB(0,5) "SOUND":
450 FOR I:=1 TO 18
460 PRINT TAB(NpM(I),VpM(I)): LEFT
$(STR$(Pm(I))+* "4):REM** Value
470 IF (I<>14) AND (I<>18) PRINT ",
":
480 NEXT
490 PRINT TAB(Pm(2),VpM(2)):REM** Se
t cursor
500 CurPm:=2
510 ENDPROC
520
530 REM** Program core
540 DEF PROCMain
550 REPEAT
560 Key:=INKEY(0)
570 IF Key=13 PROCZero:REM** CR for
zero
580 IF Key=32 PROCNoise:REM** Space
590 IF (Key=47 AND Key=58) OR (Key=4
5 AND PmSize(0,CurPm)<0) PROCNumber
600 IF Key=72 PROCHold:REM** "H" for
HOLD
610 IF Key=73 PROCImmed:REM** "I" fo
r IMMEDIATE
620 IF Key=83 SOUND 17:0,0,1:REM** "
S" to stop sound
630 IF Key=95 AND Hold PROCGraphs:R
EM** "U" to update the graphs
640 IF Key=136 PROCLeft:REM** Left a
rrow
650 IF Key=137 PROCRight:REM** Right
arrow
660 UNTIL Key=81:REM** "0"
670 ENDPROC
680
690 REM** Move cursor right
700 DEF PROCRight
710 CurPm:=Sequence(CurPm+1)
720 PRINT TAB(Pm(CurPm),VpM(CurPm)):
730 ENDPROC
740
750 REM** Move cursor left
760 DEF PROCLeft
770 CurPm:=Sequence(CurPm-1)
780 PRINT TAB(Pm(CurPm),VpM(CurPm)):

```

graphics screen. The noise can be generated at any time by pressing the space bar.

The program contains Rems to show its main features but since it is a tight fit in 32K some further notes are needed to elaborate on its operation. Table 2 shows the main variables in the program. In the program itself global variables have names starting with capital letters, while local variables start with lower case. The main areas of the program are as shown in table 1, which appears opposite.

At the start of the program ProcInt sets up the screen to separate the graphics and text windows and fills the arrays which control the input and positioning of the parameters shown at the bottom of the screen. It also sets the Hold flag to show that the graphics area should only be updated at the operator's request and not when each parameter is altered.

ProcMain is the heart of the program, reading the keyboard to see what to do next and selecting the appropriate function procedures to do it. It offers the following basic choices:

Position the cursor by way of the Left and Right Arrow keys.

Set the selected parameter directly to zero, or enter any desired value into it.

Make the sound.

Stop a sound which may be running on too long.

Set the Hold mode so that the graphs are only updated when U is pressed — this is useful if you wish to alter several parameters in one go.

Select the Immediate mode to change the graphs every time that a parameter is altered. In this mode the U key does nothing.

Finally, to exit the program press Q for Quit.

Numbers are input via ProcNumber, which only takes note of the numeric keys < and — if it is the first character. It allows a maximum of four characters to be entered, since this is the size of the parameter fields in the displayed Envelope and Sound

Table 2. Main program variables.

Pm(18)	array holding the current value of each Envelope and Sound parameter
XPm(18)	x-position of each parameter in text window
YPm(18)	y-position of each parameter in text window
PmSize(1,18)	maximum and minimum permitted values of each parameter
Sequence (19)	array showing the order in which the cursor should address the displayed parameters
AmpOK	flag used to control the effects of unusual amplitude-control parameters
CurPm	the number of the parameter to which the cursor is pointing
Durn	the total duration of the note, defined in screen co-ordinates
Hold	flag for graphics updates
I%	general-purpose counter
Key	ASCII value of the last key pressed
N\$	string representation of an input number
PtchOK	flag used to control effect of zero length PN1-PN3
Xpix	number of x-co-ordinate steps per 0.01s.
Ypix	number of y-co-ordinate steps per y-axis unit
Xstep	number of x-co-ordinate steps per time unit
X1, Y1	last position of graphics cursor
Xa, Ya	graphics start position for each line when drawing pitch envelope
Xrel, Yrel	relative graphics cursor movement

statements and is terminated by pressing the Return key. If a number outside the possible range for that parameter is input, it is ignored and the original value is retained and redisplayed.

Nearly half of the program is concerned with actually drawing the graphs, a procedure which starts simply with ProcGraphs calling ProcErase to clear the screen. ProcAmpl then draws the amplitude envelope, at the same time setting up the variables Xstep and Durn for later use when the frequency envelope is drawn. It is particularly important to calculate the sound's duration before drawing the frequency envelope since the release phase of the sound will often extend the duration beyond that defined by the fourth parameter, D, of the Sound command.

Each of the four phases of the amplitude envelope is drawn by its own procedure, consisting mainly of complex If-Then-Else statements. This construction is forced on the program by the many different possibilities generated by the complex nature of the Envelope statement. For instance, what if the sustain phase tries to take the amplitude below zero? Alternatively, what if the change of amplitude per step in the decay phase, AD, tries to take the amplitude in the opposite direction to the desired target level, ALD?

The *Users' Guide* does not explain at all clearly what happens in some of these more complex cases; the program is the end result of a lot of trial and error as to what actually goes on. For instance, if AD is going in the opposite direction to ALD, the sound's amplitude jumps straight to ALD and does not ramp to it.

Once it has drawn the amplitude envelope, the program can go on to draw the pitch envelope, since it now knows exactly how long the sound is to last. The core of this part of the program is at lines

(continued on page 129)

```

790 ENDPROC
800
810 REM** Update flag to HOLD
820 DEF PROCHold
830 PROCSetFlag
840 PRINT" H"
850 UDU 4
860 Hold=TRUE
870 ENDPROC
880
890 REM** Clear the update flag
900 DEF PROCImmed
910 PROCSetFlag
920 PRINT" I"
930 UDU 4
940 Hold=FALSE
950 ENDPROC
960
970 REM** Common parts for PROCHold and
  PROCImmed
980 DEF PROCSetFlag
990 UDU 5:REM** Join cursors
1000 GCOL 3,3
1010 MOVE 1132,780:REM** Top right
1020 IF Hold THEN PRINT "H" ELSE PRINT
  "I":REM** Clear whatever's there
1030 MOVE 1132,780:REM** Reset cursor
1040 ENDPROC
1050
1060 REM** Read a number
1070 DEF PROCNumber
1080 LOCAL len,nkey#
1090 N$=CHR$(Key)
1100 len=1
1110 PRINT N$:
1120 REPEAT
1130 nkey#=GET#

```

```

1140 IF (nkey#="0" AND nkey#="9" AND
  D len=4) OR (nkey#="." AND len=0) THEN#
  nkey#=len:len+=1:PRINT nkey#:REM** Valid
  key?
1150 IF #C(nkey#)=127 AND len>0 len=
  len-1:NE=LEFT$(N$,len):FRID nkey#:REM**
  * Delete?
1160 UNTIL #C(nkey#)=13:REM** CR
1170 IF N$="" OR N$="." N$="0":REM** Fo
  rce zero
1180 PROCNumValid:REM** OK
1190 PROCUpdate
1200 ENDPROC
1210
1220 REM** Force a zero value
1230 DEF PROCZero
1240 IF CurPm=2 THEN N$="1" ELSE N$="0"
1250 PROCUpdate
1260 ENDPROC
1270
1280 REM** See if a number is valid
1290 DEF PROCNumValid
1300 LOCAL valid,num
1310 num=ENL(N$)
1320 valid=num#PmSize(0,CurPm) AND num
  #PmSize(1,CurPm):REM** In range?
1330 IF NOT valid N$=LEFT$(PmCurPm)+UD
  U 7:REM** Keep what we've got
1340 ENDPROC
1350
1360 REM** Update the position
1370 DEF PROCUpdate
1380 PmCurPm=ENL(N$):REM** New value
1390 PRINT TAB(CurPm):PmCurPm+UD
  LEFT(N$) " "
1400 IF NOT Hold PROCDrawAmpl:REM** Uda
  te?

```

```

1410 PROCDrawAmpl:REM** Next parameter
1420 ENDPROC
1430
1440 REM** Make sound
1450 DEF PROCMake
1460 ENVELOPE Pm 1),Pm 2),Pm 3),Pm 4),P
  m 5),Pm 6),Pm 7),Pm 8),Pm 9),Pm 10),Pm 1
  1),Pm 12),Pm 13),Pm 14)
1470 SOUND Pm 15),Pm 16),Pm 17),Pm 18)
1480 ENDPROC
1490
1500 REM** Update graphs
1510 DEF PROCDrawGraphs
1520 PROCMake
1530 PROCDrawAmpl:PROCDrawPitch
1540 ENDPROC
1550
1560 REM** Clear graphics
1570 DEF PROCMake
1580 CLG
1590 PROCSetFlag:REM** Restore Hold mar
  ker
1600 UDU 4
1610 ENDPROC
1620
1630 REM** amplitude envelope
1640 DEF PROCDrawAmpl
1650 GCOL 0,2
1660 MOVE 0,0
1670 Xstep=(Pm 2) NOD 128:#Ders:REM** X
  move per time step
1680 Durn=ENL(Pm 10)+Pm 18)+5*(Pm 13):REM
  ** Duration
1690 PROCMake
1700 IF AmpOK PROCMake

```

(listing continued on next page)

BBC sounds

(listing continued from previous page)

```

1710 IF Am=OK PROC Sustain
1720 PROC Rise
1730 ENDPROC
1740
1750 REM** Attack phase
1760 DEF PROC Attk
1770 LOCAL aa:ala:at
1780 Am=OK=TRUE
1790 aa=Pw(9)*Vr1x
1800 ala=Pw(15)*Vr1x:REN** To screen co-
ords
1810 IF aa=0 THEN at=ala*ster/aa:REN**
Check there is an attack
1820 IF aa=0 at=0:REN** Jump to it?
1830 IF at=Durn ala:ala:Durn/at:at:Durn
:Am=OK=FALSE:REN** Enough time left?
1840 IF aa=0 AND at=0 AND ala=0 Am=OK=FA
LSE:Durn=0:REN** False start?
1850 PLOT 1,at:ala:REN** Draw it
1860 XI=at:VI=ala:REN** Present posn.
1870 ENDPROC
1880
1890 REM** Decay phase
1900 DEF PROC Decy
1910 LOCAL ad:ald:at
1920 ad=Pw(10)*Vr1x
1930 ald=Pw(14)*Vr1x:REN** Screen co-ord
s
1940 IF ad*(ald-VI)<0 OR (ad=0 AND ald>
VI) ad=378*SGN(ald-VI):REN** Is ramp in
correct direction?
1950 IF ad<0 AND ald<VI THEN at=XI+(Ca
ld-VI)*ster/ad ELSE IF ad<0 AND ald=VI
THEN at=VI ELSE at=Durn:ald=VI:Am=OK=FA
LSE:REN** Is it decaying?
1960 IF at=Durn ald=VI+(ald-VI)*Durn/3
177*at-XI):at=Durn:Am=OK=FALSE:REN** Kee
P on screen
1970 PLOT 5,at:ald
1980 XI=at:VI=ald:REN** Update
1990 IF VI=0 Durn=XI:Am=OK=FALSE
2000 ENDPROC
2010
2020 REM** Sustain phase
2030 DEF PROC Sust
2040 LOCAL aa:ala:at
2050 aa=Pw(11)*Vr1
2060 at=Durn XI:REN** Time left
2070 ala=VI*stet:ster:REN** Final lev

```

```

el
2080 IF ala=0 at=at+XI*(ster/aa+at):
2090 ala=0:Durn=XI:at:REN** Reached zero
val?
2090 PLOT 5,Durn:ala
2100 XI=Durn:VI=ala
2110 ENDPROC
2120
2130 REN** Release phase
2140 DEF PROC Rise
2150 LOCAL aa:at
2160 aa=Pw(12)*Vr1x
2170 IF aa=0 THEN at=1000-XI ELSE at=VI
*ster/ABS(aa):REN** How long?
2180 IF VI=0 at=0:REN** Finished already
?
2190 at=FN(1000-XI/at):XI:REN** Keep
on screen
2200 Durn=Durn+at:REN** add release tim
e
2210 PLOT 1,at:at:ster
2220 ENDPROC
2230
2240 REM** Draw the pitch envelope
2250 DEF PROC DrawPitch
2260 LOCAL y:star
2270 GCOL 0,1:REN** Select colour
2280 y:star=Pw(17)*Vr1x:REN** Starting
freq
2290 XI=0:VI=y:star:REN** Start pos.
2300 MODE XI,VI
2310 I=3
2320 PITCH=TRUE
2330 REPEAT
2340 IF I=3 AND PITCH DRAW XI:y:star
:VI:y:star:REN** Start of freq cycle
2350 IF (Pw(15)=0 AND Pw(15)+3=0) THE
N XI=Durn:DRAW XI:VI ELSE PROC Pitch:REN**
Level to the end of the sound?
2360 IF PITCH I=(I+1) MOD 3 +3:REN**
Count 3-5 if non-zero ster
2370 UNTIL XI=Durn OR (Pw(2) AND 88
0) AND I=3 AND PITCH:REN** Repeat fre
q. env?
2380 IF (Pw(2) AND 880) DRAW Durn:VI:RE
N** If not repeat, level to end
2390 ENDPROC
2400
2410 REN** Pitch lines
2420 DEF PROC PLine
2430 LOCAL xtemp:ytemp
2440 Xrel=Pw(14)+3*ster:REN** Relative
3
2450 PITCH=Xrel:0)

```

```

2460 IF NOT PITCH Xrel=ster:REN** Han
dle zero ster length
2470 xtemp=FN(1000-Xrel/Durn):REN** Ke
ep on screen
2480 IF PITCH THEN Pdm=Pw(13)+3 ELSE
Pdm=1:REN** Handle zero ster length
2490 Vrel=Pw(15)+Pdm*Vr1x:temp=Xrel:RE
N** Relative V
2500 Vrel=temp
2510 Na=XI:Va=VI:REN** Start pos.
2520 REPEAT
2530 ytemp=Va+Vrel:REN** Target V
2540 IF ytemp>767 THEN PROC P2:Zaa(TR
UE) ELSE IF ytemp<0 THEN PROC P2:Zaa(FAL
SE) ELSE PROC Pstr:REN** Allow for foldi
ng
2550 UNTIL Vrel=0
2560 XI=Na:VI=Va:REN** Where we end up
2570 ENDPROC
2580
2590 REM** Draw a folding pitch line. U
P=TRUE shows going up
2600 DEF PROC P2:Zaa(UF)
2610 LOCAL xtemp:ytemp
2620 IF UF ytemp=767 ELSE ytemp=0
2630 ytemp=ytemp-Va:REN** How far to sc
reen edge
2640 xtemp=Xrel+ytemp/Vrel:REN** Scale
X movement
2650 PLOT 1,xtemp:ytemp:REN** Draw to e
dge
2660 IF UF PLOT 1,0,-767 ELSE PLOT 1,0,
767:REN** To other edge
2670 Na=Xa:xtemp
2680 Xrel=Xrel-xtemp
2690 IF UF Va=0 ELSE Va=767
2700 Vrel=Vrel-ytemp:REN** Update point
ers
2710 ENDPROC
2720
2730 REM** Pitch if no foldback
2740 DEF PROC Pstr
2750 PLOT 1,Xrel:Vrel
2760 Na=Xa+Xrel
2770 Va=Va+Vrel:REN** Adjust pointers
2780 Vrel=0:REN** To end REPEAT
2790 ENDPROC
2800
2810 REM** Find the min of 2 numbers
2820 DEF FNMin(a,b)
2830 LOCAL dummy
2840 dummy=a
2850 IF b<a dummy=b
2860 d=dummy

```

Two new cards to really

SCREENMASTER 80



At long last! A truly sophisticated 80 column card is now available for your Apple computer. Digitek provides you with an outstanding word processing capability as well as graphics/text display applications.

The truth is, the Screenmaster 80 is not just another 80 column card, — its many built-in features convert your Apple into a truly versatile computer. Once installed there is no need for removal to operate the Apple normally, neither does it suffer from heat problems (common to many other column cards), as it functions with low power consumption.

Other features include: Upper and lower case characters, natural type-writer-like 'shift' and 'shift-lock', fast program editing, and 8 operating modes under keyboard control. It also supports Applesoft commands, Hi-Res and Lo-Res commands, has 3 scrolling speeds, split screen, and six cursor modes, to name but a few.

It is also compatible with all Apple languages and operates with software programs such as Applewriter II and Visicalc. To really show off the Screenmaster 80 we provide you with a demonstration and utilities disk.

If you are really into Apples the Screenmaster 80, used in conjunction with Digitek's Super Printmaster III and Ram-Master cards will provide you with the ultimate capability of printing, buffering, and memory management.

Digitek (International) Limited, 37c West Street, Horsham, West Sussex RH12 1PP, England. Tel: 0403 66550/66581

(continued from page 127)

2330 to 2370, which cycle repeatedly through the three pitch segments allowed by the Envelope syntax. Normally a sound will autorepeat its pitch envelope until its time runs out, but the program also checks the setting of bit 7 of the T parameter, held in Pm(2). If it is set, it disables the autorepeat. The envelope then cycles just once and the note stays constant at the final value if reached.

Autorepeating also ends if pitch durations PN1, PN2 or PN3 are zero. If so, the pitch of the generated noise simply advances by the value defined in the associated PIn at each time step. This is also not explained in the *Users' Guide*, but it gives a way of generating a note which is continually cycling its pitch. The zero PnN also overrides any autorepeat selection defined by bit 7 of the T parameter.

The changing frequency of each step in the pitch envelope is drawn by ProcPline, which in turn calls on ProcPZigZag and ProcPstrt to actually put the lines on the screen. ProcPZigZag takes care of the case where the pitch at the end of a given section wants to go below zero or above 255. In these cases, the actual pitch jumps from 0 to 255 or from 255 to 0 as it crosses the edge; the program must spot these jumps and draw appropriate lines. In the easy case of the pitch staying between 0 and 255 ProcPstrt simply draws a straight line.

Once you have entered the program, you will see a display of the starting Envelope

and Sound parameters, most of which are zero, and a blank graphics screen with only the axes marked. You can enter data into any alterable parameter simply by positioning the cursor on it, using the Left and Right Arrow keys, and starting to type in the number, starting with a - sign or any digit. You may delete as normal and, when you are ready, press Return.

If the number you have entered is outside the permitted range of that parameter — see page 182 and 185 in the *Users' Guides* — the computer will beep and the original value will be restored. To set a value to zero, simply press Return when you position the cursor. Once each number has been correctly entered the cursor automatically moves on to the next alterable parameter.

If the system is in the Immediate Update mode, shown by an I at the top right corner of the screen, the graphs will be revised every time that you change a parameter. In Hold mode, when an H is on the screen, the update will not take place until you press U; whenever the program starts up it is automatically set to Hold. To select Hold, press H; Immediate is chosen by pressing the I key.

The note you have defined may be sounded at any time by pressing the space bar; to stop it press S. You can repeat the note as often as you like. Pressing Q will exit the program, while no other key has any effect.

Although the program accurately displays the pitch and amplitude envelopes

it has certain limitations. When it is first run, all the parameters are zeroed. You should put sensible values into them before you try to draw the graphs, otherwise there is a remote chance of a divide-by-zero error. Although error trapping is fairly thorough, there simply was not room to put full checks for every possible mistake into the program, but once you are past the start you will not have any problems from this area. Once running, the program will accept any legal value of any alterable parameter, even though some give unexpected results.

Secondly, the program draws each element of the two envelopes as a straight line, whereas the BBC Micro actually produces staircase changes of pitch and amplitude. With large values of the T parameter you can actually hear the individual steps, although the changes normally sound like the smooth lines drawn by the program and shown everywhere in the *Users' Guide*. This slight simplification was chosen simply to ensure that the program drew the graphs quickly; originally it drew steps, but was very slow for small values of T.

Finally, the program only draws the first five seconds of any note, although it sounds the full duration. This is a compromise chosen to fit the program into 32K while retaining Mode 1 graphics to give acceptable resolution. In practical terms, none of these limitations has much effect on the program, which is easy to use and gives an excellent idea of what is happening. □

make your Apple blossom

RAMMASTER RANGE

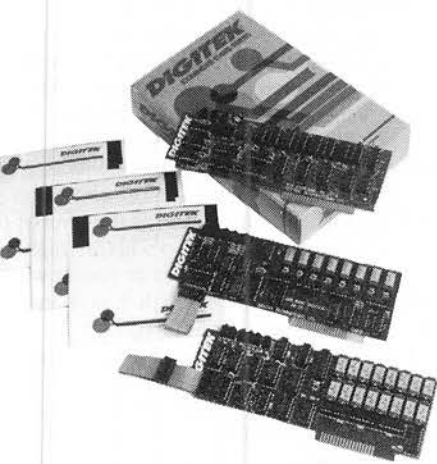

DIGITEK
EXPANDER CARDS

Digitek is a trademark of Digitek (International) Limited. Super Printmaster III, Screenmaster 80, and Ram-Master are registered trademarks of Digitek (International) Ltd. Apple is a trademark of Apple Computers Incorporated. CP/M is a trademark of Digital Research. Visicalk is a registered trademark. Super Printmaster III patent pending.

More data storage, increased program capability — with Digitek's new range of plug-in Ram-Masters 16K, 64K, 128K, which use the latest low power D-Ram chips.

These Ramcards not only add extra memory to your Apple's standard 48K, but also make more efficient use of its existing memory by providing you with the advantage of loading alternative languages such as Pascal or Fortran, Memory management and Data Buffering for off-line printing (when used in conjunction with the new Super Printmaster III).

We also ensure you are informed which memory sub-banks are in use by equipping them with bank switching LED 'status' indicators along the top of the board where they are easy to view. We've also made installation simple.

To show you graphically the enormous capability of the Ram-Master range, every 64K and 128K Ramcard will have a demonstration program and a number of utility programs on disk, giving you versatility which no other Ramcard can provide.

Visicalk expand pre-boot disk and CP/M, Pascal Disk Emulators are available.

You can make more of your Apple, by plugging in the Ram-Master, Digitek's Super Printmaster III, and Screenmaster 80, to have at your fingertips a full colour word processing/graphics system.

Call in at your local Apple dealer or fill in the coupon — and let us make your Apple blossom.

Please send me		I enclose my cheque	
Screenmaster 80	£185	<input type="checkbox"/>	for £ _____ Payable to
Rammaster 16K	£85	<input type="checkbox"/>	Digitek (International) Limited
Rammaster 64K	£213	<input type="checkbox"/>	Add 15% VAT P&P FREE
Rammaster 128K	£319	<input type="checkbox"/>	Card _____
Further Information		<input type="checkbox"/>	No. _____
		<input type="checkbox"/>	Telephone Order 0403 66550
Name _____			
Address _____			

Post Code _____			

Digitek (International) Ltd, 37c West Street, Horsham, Sussex, RH12 1PP

• Circle No. 184

Space Raiders

FOR RAIDERS read invaders — this is a standard implementation of the popular pub/arcade game. In the Sinclair version from Psion, 55 aliens gradually work their way down the screen while you defend Earth.

The aliens come in five ranks and you have three bases to hide behind. There is also a mother ship moving slowly backwards and forwards at the top of the screen, which you can hit for a bonus.

There are three major problems with this game. The first is a limitation of the Spectrum's design — you have to move your blaster backwards and forwards with the Z and X keys, and use the space bar to fire. The game would be much more fun to play using a joystick, and it seems strange that such a play-orientated micro does not have a joystick port.

The second problem is the sound, which is so feeble as to be hard to hear. Again it is a shame the Spectrum does not have more versatile sound facilities.

The third problem could be due to the nature of the machine or the program. The game runs incredibly slowly. Psion could have called the game Water Invaders, converting the aliens into jelly fish and the blaster into a miniature crab — it would be more in line with the feel of the game.

Specification

Type: arcade game with barely audible sound

System: 16K or 48K Spectrum

Manufacturer: Psion for Sinclair

Price: £4.95

Rating: 6/20

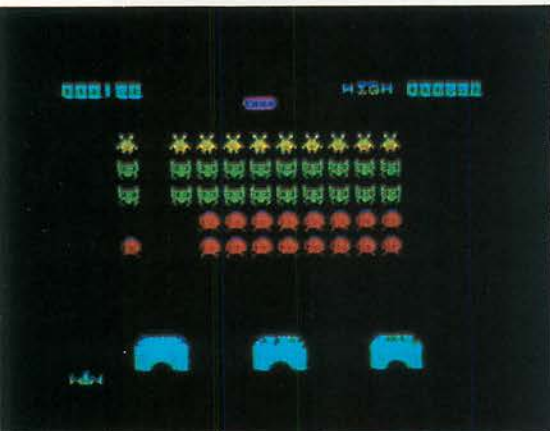

Spectral Invaders

BUG-BYTE'S VERSION of Space Invaders is very similar to Psion's, as you would expect — though I cannot see anything particularly Spectral about the Bug-Byte aliens. The main advantage of the Spectral version is that it can be played by one or two players, the screen holding both scores. Unfortunately, you are asked to enter 1 or 2 for the number of players at the start of every game.

The Bug-Byte version also has five rows

Spectrum games

Jack Schofield tests six cassettes.

of 11 aliens, but in this case each row is a different colour. The animation of the aliens is more imaginative and they move in a more alien invader fashion. You have four bases to hide behind instead of three, although the Bug-Byte aliens demolish them rather more quickly than the Psion ones.

Blaster movement is controlled not with Z and X but with the Caps Shift and Z keys, the space bar again being used to fire. In both games the music is equally feeble. The Bug-Byte version has slightly better animation, but is rather more difficult to play. This is mainly because it is hard to see the alien bullets coming at you, which makes it hard to dodge them effectively.

The game is probably adequate if you just want to have a version of Space Invaders to play at home but, frankly, playing it is not exactly gripping;

Specification:

Type: arcade game with colour and barely audible sound

Format: cassette tape

System: 16K or 48K Spectrum

Manufacturer: Bug-Byte Software, 98-100 The Albany, Old Hall Street, Liverpool L3 9EP

Price: £5

Rating: 7/20

Chess

ON LOADING, Psion's chess program displays an attractive blue screen with a black and yellow chess board. Numbers and letters are provided on all four sides for entering the moves in algebraic notation.

First you are given a choice of playing or setting up a particular position, then you choose white or black, then the level of play, from 0 to 9. You enter moves in the normal way, and the computer displays them during the game in columns labelled You and Me, showing up to 14 moves at a time. The computer gives a tiny beep on making a move.

Chess, or Master Chess as it says on the screen, plays a very good game even at level 3. It should challenge the vast majority of chess players — unless my own game has declined more than I thought.

The instructions are brief but to the point. The program offers a good range of facilities, including recommended moves which are suggested on request.

You can change the level of play, save the current game to cassette for reloading later or copy the complete screen to a printer. You can also use the cursor controls to set up a particular position. All round Psion has produced a good chess-playing game.

Specification:

Type: board game

Format: cassette tape

System: 48K Spectrum

Manufacturer: Psion for Sinclair

Price: £7.95

Rating: 15/20

The Chess Player

NOT WITHSTANDING the curious robot on the cassette cover this is a straightforward chess game. Quicksilver has dressed it up with a hysterical introduction: "The earth hung in the void, turning on its' (sic) axis basking in the sun. Thus far in its' life the earth had suffered no major discomforts," etc., etc. Anyway The Chess Player has produced a board from Dimension X and you are playing for the future of the Earth.

Unfortunately, the mass of words on the cassette label leave no room for simple instructions, such as how to operate the game. When questions appear on the screen, there is no guide as to how to answer them — although reasonably intelligent guesses such as P for play seem to work OK. When it asks for the level of play it gives no guidance to whether high numbers are better or worse or just how many levels there are, though it says on the cassette label there are six.

I tried level 1 to be told in large letters: "Ha Ha! You've no chance!" You do not always get the same message on the same level. On another game on level 1 I was told "This will be a tough match."

Later, in a straightforward Ruy Lopez, it responded to 3.B-N5 with "That was a good move". Fortunately it does not exclaim "Well that was really dumb!" if you throw your queen away.

The board appears against a black

background. The "black" squares are blue, and the "white" pieces are red. Though the graphics are quite attractive it is very difficult to see black pieces against blue squares, which gives the machine something of an unfair advantage.

The Chess Player displays only two moves on the board at once, and the total number of moves played. In other respects it is quite similar to Psion's Chess.

On level 1 The Chess Player plays very quickly at a passable but hardly inspired level. On level 6 I gave it 10 minutes to make its second move before abandoning the game. On level 3 most people will find a good compromise between the rate of play and the degree of difficulty.

It is not easy to say whether The Chess Player plays better than the Psion offering. Certainly it seems to have a slightly better grasp of strategy but this might be an illusion inspired by the fact that the Psion's Chess plays a more active and vigorous game. Perhaps the Quicksilva game seems more subtle.

In terms of screen presentation and convenience of use and number of features the Psion version scores. The worst thing about the Quicksilva game is the poor legibility of the board. For this reason I cannot rate it quite as highly, but it would undoubtedly keep the keen chess player amused.

Specification

Type: board game

Format: cassette tape

System: 48K Spectrum

Manufacturer: Quicksilva Limited, 92 Northam Road, Southampton SO2 0PB

Price: £6.95

Rating: 13/20

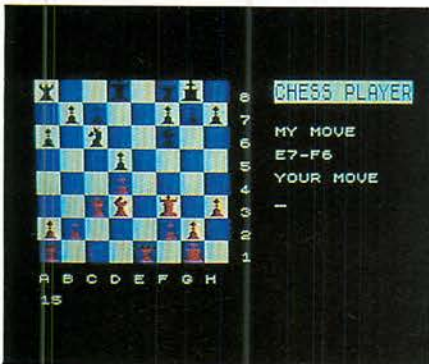

Hungry Horace

HUNGRY HORACE is an extremely silly game which is somewhat similar to Pacman. You are a small fat body with two black legs, and Horace is a goggle-eyed head.

The game is played in a simple maze where your task is to go round and gobble up asterisks while avoiding Horace. When he catches you he eats you. All the mazes have traps, and they also have exits: when you take an exit the screen clears and you appear in another maze. As in Pacman

you sometimes get the chance to eat items of fruit. You turn into a hideous ghost-like face and can eat Horace, just for a change.

The board is large in area but not in complexity, being based on a 10-by-six grid. You get a different view of Horace according to the direction he is heading. If he is going sideways, you get a sideways view; if he's going towards the bottom of the screen you see him full-face; if he's going up the screen you see the back of his head.

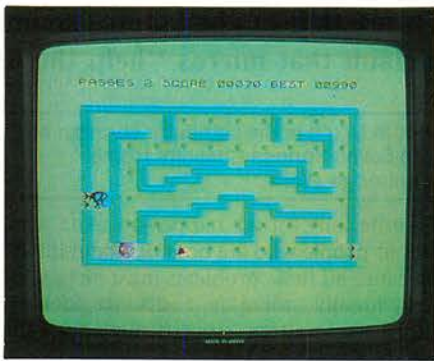

The sounds are a little better than average for Spectrum software, though that is not saying a great deal. The main problem with Horace is learning the keys. The game uses I for up and A for down, and the I and P keys for left and right. It is not a particularly satisfactory choice.

The best thing about Hungry Horace is that the action is fast, which makes it challenging. Though patently ridiculous, Hungry Horace is fun to play.

Specification

Type: arcade-type game with colour and sound

Format: cassette tape

System: 16K or 48K Spectrum

Manufacturer: Psion with Melbourne House for Sinclair

Price: £5.95

Rating: 14/20

Penetrator

THE BLURB for Penetrator describes it as "the fastest and most exciting game for your 48K Spectrum". Not having played all of them I cannot guarantee the truth of this claim but it is certainly one of the most challenging, and few games for any microcomputer offer as many user facilities.

Penetrator is a Scramble-type game where you must fly your fighter through a complicated series of landscapes and caverns while either shooting, bombing or dodging the numerous rockets that are trying to destroy you. The eventual aim is to survive all four defence rings and to blow up an illegal cache of neutron bombs.

The game requires a great deal of practice to play well, but fortunately — and, I believe, uniquely — Penetrator is equipped with extremely good learning facilities. For a start it will quite happily

play a demonstration game, and there is no better way of finding out what a game is all about.

If you press T you move into a training mode. Here you are allowed an unlimited supply of fighters, which you will certainly need to master each stage separately without continually restarting the game. Finally Penetrator can be customised to your own skill level.

The game allows you to redesign the moving horizontal landscape to make it easier to fly through. You can also reduce or increase the number of missiles and radar bases. In stage 4 you can reduce the number of enemy paratroopers, which look like black masks.

You must also give some thought to flying backwards through the landscape if you wish to be able to escape after blowing up the neutron bombs. Redesigning the landscape does take considerable time and effort, but it is possible to save the result on tape for reuse.

It must be admitted that Penetrator is not easy to play without a joystick. Control of the fighter is by using the Q and A keys for up and down and the P and O keys for forward thrust and braking relative to the scrolling landscape. P also acts as a fire button: you use short presses to fire and long ones for thrust. This may sound difficult but in practice it works well.

To drop bombs you just hit any key on the bottom row, which is a good way of getting round the Spectrum's lack of a proper space bar. Again it shows thoughtful game design.

The action in Penetrator is not all that fast and furious, but it takes place in a limited area with your fighter constantly under attack, so it does require quick reactions. The movement of the fighter itself is smooth, considering the method of controlling it. Missiles move slowly but quantity makes up here for the limited graphics.

The instructions on the cassette label are excellent and include good advice about playing the game. Re-reading the instructions can actually improve your scores!

Even if you do not much like Scramble as a game, Penetrator is quite playable. Even if you do not have a Spectrum to play it on, the concept of game design and user friendliness within the limitations of the Spectrum make a worthwhile instruction course. Congratulations to the author, Philip Mitchell. More games for all machines should be written this way.

Specification

Type: arcade game with colour graphics and sound

Format: cassette tape

System: 48K Spectrum

Manufacturer: Melbourne House, 131 Trafalgar Road, London SE10

Price: £6.95

Rating: 15/20

Programming for disabled users

Robin Nixon puts in a plea for software that can be tailored to individual users' needs. Only when it becomes available will the claim that micros "help the disabled" become justified.

RECENTLY THERE HAS been a marked growth in the number of microcomputers being used by the disabled. Although the technology has been available, it was never fully used until prices came within the reach of individuals.

Now that the market is flooded with micros, there are new problems. The first is that of input devices. Due to the nature of handicap, there is no hardware that can be mass-produced cheaply. Each individual needs individually tailored equipment. It is not so much of a problem until you start writing the software, and discover all the possibilities of input that your program has to take into account.

The second problem is output. Many disabled people have impaired vision, so a TV screen will not always be the best of choices. Speech synthesis is improving by leaps and bounds, but is still difficult to use

Robin Nixon is the computer librarian at the Seven Springs Cheshire Home, Tunbridge Wells.

— especially for a blind person. And what about people who are both deaf and blind? Because all these problems must be tackled individually, there is a distinct lack of software written specifically for the disabled.

Writing programs for the disabled can be very challenging and also very rewarding. When you see someone who has never been able to write a letter or play any games without the help of another person using your software, and thus becoming more independent, you know you have created something worthwhile. Although an outline of how to write for the disabled is helpful there is no real replacement for actually visiting a home or school and getting to

know the people involved. This includes the staff, as they have a better idea than anyone, except the resident concerned, of the abilities of each person. They are the people who will tell you exactly what is needed and give you some good ideas about how to get going.

The most commonly used input devices are based around a scanning system, normally using either one or two switches. Using one switch, a cursor can be made to scan horizontally along an alphanumeric matrix — see figure 1. To type the letter y the first switch would be pressed and held down until the cursor had scanned along to bak — see figure 2. Upon releasing the switch the cursor scans down. When the chosen letter is highlighted by the cursor the switch is pressed again, and the letter is entered into the computer — see figure 3.

The two-switch mode is similar, except



Rocking arms facilitate hand and arm movement for a proof reader suffering from the effects of muscular atrophy.



Two word-processing systems: WordStar can be accessed using a mouthstick, and MacApple, a pedal-operated system.

The first switch is used for the horizontal scan and the second for the vertical. The first switch, when pressed a second time, enters the letter. The matrix can be replaced at any time by a punctuation board, a number board, or a word or phrase board.

It may seem a rather slow way of going about it, but many handicapped operators have such limited use of their limbs that a system like this is the best until speech-recognition technology reaches a very high standard. Of course many people will be able to use more than two switches: the speed of entry increases with each switch.

The methods of input are virtually limitless: a lot of thought needs to be put into the selection and development of an input for each individual user. Apart from the two most common outputs, video and printer, there are very few others that are easy to use. Speech synthesis is perhaps the most widely used of the alternatives. Its standard of voice reproduction is intelligible, and will become better as a great deal of work is being done in this field. Eventually the hardware will become cheaper and more simple to use.

Many disabled users have some kind of

eye tremor or other deficiency of vision. So, if a visual display is chosen, it must be exceptionally clear and as large as possible. One way of making video output clearer is to use two screens. The first could contain the letter matrix and any other relevant information, such as the last word or sentence typed in. The size of the letters displayed could then be as large as the user required leaving, hopefully, plenty of room on the main screen for running the program.

The output you find the best may be very

Robin Nixon's Krypton game.

```

100 HOME
110 P = 0:V = 3:H = 6:F = 50
120 FG = 1
130 SP = 4
140 GOSUB 1020
150 HOME
160 IF PEEK (0 - 16287) > 127 THEN 160
170 FOR X = 0 TO 9:R(X) = X: NEXT
180 FOR X = 1 TO 20:B = INT ( RND (1) * 10 ):C = INT ( RND (B) * 10 )
190 D = A(B):A(B) = A(C):A(C) = 0: NEXT
200 UTAB 1: HTAB 16: INVERSE: PRINT "KRYPTON": NORMAL: PRINT
210 UTAB 4: PRINT "PRESS GREEN WHEN THE ROOM NUMBER YOU
    WANT IS LIT OR PRESS RED FOR A NEW GAME"
220 B = INT ( RND (1) * 10 ): 1
230 FOR X = 1 TO 4
240 C = INT ( RND (1) * 10 ): IF B(C) > 0 THEN 240
250 B(C) = 3
260 IF X = 3 THEN B(C) = B(C) - 1
270 NEXT
280 FOR X = 1 TO 3
290 C = INT ( RND (1) * 10 ): IF B(C) > 0 THEN 290
300 B(C) = 4
310 NEXT
320 X = 0
330 R = INT ( RND (1) * 10 )
340 UTAB 9: HTAB 1: PRINT "YOU ARE IN ROOM NUMBER "; INVERSE: PRINT A(R)
    ;; NORMAL
350 SC = SC + 1
360 UTAB 12: HTAB 1
370 ON B(R) + 1 GOTO 480,380,410,410,500
380 PRINT "YOU HAVE FOUND THE POWER CRYSTALS FOR THE TELEPORTER."
390 PRINT "                ";P = 1
400 GOTO 550
410 PRINT "YOU ARE IN A TELEPORTER"
420 PRINT "                ";
430 PRINT "                ";
440 UTAB 14: HTAB 1
450 IF P = 0 THEN PRINT "YOU DO NOT HAVE THE POWER CRYSTALS. THIS MACHINE
    IS THEREFORE "; INVERSE: PRINT "OUT OF ACTION": NORMAL: GOTO 550
460 GOSUB 800
470 GOTO 550
480 PRINT "                ";
490 PRINT "                ";
500 PRINT "YOU HAVE BEEN EXPOSED TO KRYPTONITE.":K = K + 1: IF K = 5 THEN
    510 PRINT "ANOTHER "; INVERSE: PRINT 5 - K: NORMAL: PRINT "TIMES AND
    YOU WILL "; INVERSE: PRINT "DIE": NORMAL
520 PRINT "                ";
530 PRINT: PRINT
540 HTAB 1: UTAB 22: INVERSE: PRINT "KRYPTONITE EXPOSURE": NORMAL: PRINT
    " = ";K;
550 UTAB 18: HTAB 1: PRINT "YOU CAN GO TO ROOMS ";
560 G = R - 1: IF G < 0 THEN G = 9
570 H = R + 1: IF H > 9 THEN H = 0
580 INVERSE: PRINT A(G): NORMAL: PRINT " AND "; INVERSE: PRINT A(H):
    ; NORMAL
590 GOSUB 650
600 IF X < > A(G) AND X < > A(H) THEN FOR Z = 1 TO 1000: NEXT: GOTO 5
    90
610 IF A(G) = X THEN R = G: GOTO 630
620 R = H
630 FOR S1 = 1 TO 100:S = PEEK ( - 16336 ): NEXT
640 GOTO 340
650 UTAB 24: HTAB (6): PRINT "0 1 2 3 4 5 6 7 8 9";
660 FL = 0
670 INVERSE: GOSUB 780
680 S = - 16336
690 S = PEEK (S) - PEEK (S) - PEEK (S) - PEEK (S) - PEEK
    (S)
700 FOR Z = 1 TO F
710 IF PEEK (0 - 16287) > 127 THEN 770
720 IF PEEK (1 - 16287) > 127 THEN FL = 1
730 NEXT: NORMAL: GOSUB 780:X = X + 1: IF X > 9 THEN X = 0
740 IF FL AND FG THEN RETURN
750 IF FL THEN RUN
760 GOTO 670
770 NORMAL: GOSUB 780: RETURN
780 UTAB 24: HTAB X + Y + H
790 PRINT X: RETURN
800 UTAB 12: HTAB 1: PRINT "
810 INVERSE: UTAB 12: HTAB 1: PRINT "PRESS RED TO TELEPORT": NORMAL
820 IF PEEK (1 - 16287) < 128 THEN 820
830 IF PEEK (1 - 16287) > 127 THEN 830
840 UTAB 14: HTAB 1
850 IF B(R) < > 2 THEN PRINT "SORRY THIS TELEPORTER DOESN'T WORK
    NOT EVEN WITH POWER CRYSTALS": RETURN
860 FLASH
870 PRINT "CONGRATULATIONS!! YOU HAVE SUCCESSFULLY COMPLETED YOUR MISSION
    !!!!!!"
880 NORMAL
890 PRINT: PRINT "YOUR SCORE = ";SC + K
900 FOR X = 1 TO 300:S = PEEK ( - 16336 ): NEXT
910 FOR X = 1 TO 50:S = PEEK ( - 16336 ): NEXT
920 FOR X = 1 TO 300:S = PEEK ( - 16336 ): NEXT
930 UTAB 24: HTAB 6: FLASH: PRINT " "; PRESS RED TO PLAY AGAIN << ";
940 IF PEEK (1 - 16287) > 127 THEN 940
950 IF PEEK (1 - 16287) < 128 THEN 950
960 NORMAL: RUN
970 UTAB 9: HTAB 1: PRINT "
980 PRINT "                ";
990 FOR X = 1 TO 200:S = PEEK ( - 16336 ): NEXT: FOR X = 1 TO 200:ZZ = Z
    Z + 1:S = PEEK ( - 16336 ): NEXT: FOR X = 1 TO 200:ZZ = ZZ + 1:ZZ =
    ZZ + 1:S = PEEK ( - 16336 ): NEXT
1000 FOR X = 1 TO 50:ZZ = ZZ + 1:ZZ = ZZ + 1:ZZ = ZZ + 1:ZZ =
    ZZ + 1:S = PEEK ( - 16336 ): NEXT
1010 FLASH: UTAB 9: HTAB 12: PRINT "YOU'RE DEAD!!!!": NORMAL:K = SC + K
    ; GOTO 850
1020 UTAB 1: HTAB 1: PRINT "PRESS RED IF THIS IS THE SPEED YOU WANT."
1030 PRINT: PRINT " TO CHANGE THE SPEED PRESS GREEN."
1040 PRINT: PRINT: PRINT "
1050 PRINT "0=FASTEST 9=SLOWEST"
1060 UTAB 12: HTAB 15: PRINT "SPEED = ";SP: GOSUB 650
1070 IF FL THEN FG = 0: RETURN
1080 F = (X + 1) * 10
1090 SP = X
1100 GOTO 1060

```

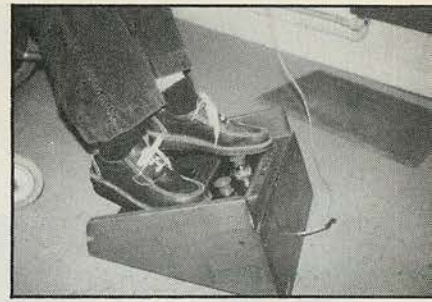
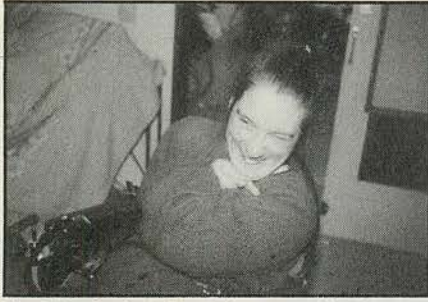

The MacApple WP and communications system is based on an Apple II with twin discs, controlled by a foot-operated console.

Disabled users

(continued from previous page)

surprising. I know one young man who has extremely poor vision and almost no hearing. He uses a hand-held buzzer, from which he feels pulses of morse code which the computer translates from any text stored in memory. He is a keen football supporter and likes to follow the scores. Instead of spelling them out to him on his hand in finger language, it is easy to type them into a computer and leave him to go over them in his own time.

Whatever the program you are writing, it is essential to bear in mind that most users will be very inexperienced in the use of computers. A Help menu must be accessible

at all times. Also the program needs to be interesting and not too complicated. A comprehensive manual would be a boon since many disabled users have to rely on unskilled assistance.

Games programs can be very useful in an environment where there is naturally a large amount of free time. The most popular games are Scrabble, Monopoly, Othello, Chess and Draughts. Action games such as Space Invaders and Pacman would be especially welcome if a simple method of input were chosen and the speed of play made variable to allow for those with slower reflexes.

Although there are many communication programs around, they are mostly based on the same scanning system. A possible alternative is to develop a language based on thoughts and symbols, each of which would be entered into the computer, and the combination translated into English.

Good programs for drawing anything

from pictures and graphs to mathematical functions are in short supply. A program that I have not as yet come across is a routine to allow the user to enter and run Basic programs — not as easy as it sounds.

I have deliberately not been explicit in the description of the software that is now available. There is a good chance that, if left to your own imagination, you will come up with a totally new concept in the design of programs for the disabled. But if you do need help write to the author at Seven Springs Cheshire Home, Pembury Road, Tunbridge Wells, Kent TN2 4NB where there is a national program library for the disabled. We would like to see your programs shared by as many people as possible.

sp	E	bak	S	H	ret
T	A	I	L	B	W
O	N	D	M	G	,
R	C	Y	F	J	.
U	P	V	X	Z	*
+ -	K	Q	uc	::	?

sp, space; bak,backspace; ret, return; uc, upper case

Figure 1. Possible display for a scanning system.

a.	[sp]	E	bak	S	H	ret
b.	sp	[E]	bak	S	H	ret
c.	sp	E	[bak]	S	H	ret

Figure 2. Scanning horizontally.

[bak]	bak	bak	bak
I	[I]	I	I
D	D	[D]	D
Y	Y	Y	[Y]
V	V	V	V
Q	Q	Q	Q
a.	b.	c.	d.

Figure 3. Scanning vertically.



An alternative mouthstick controller allows MacApple to be used by operators without the need to exercise fine control of the limbs.

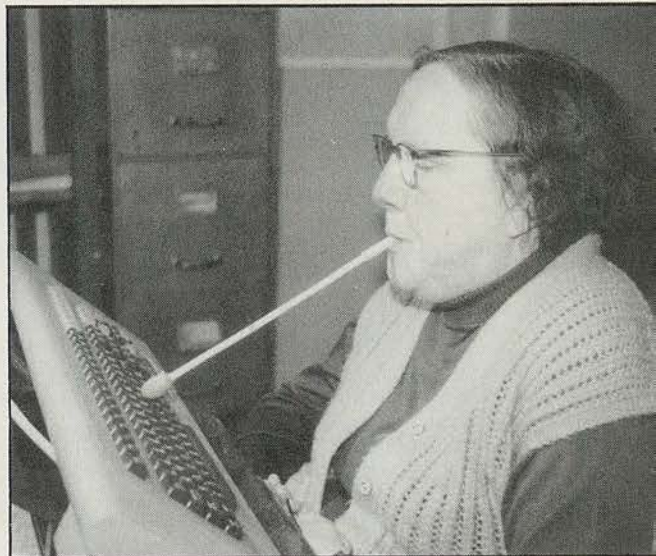

WordStar on an LSI micro enables a secretary to relearn typing skills lost through the effects of multiple sclerosis.

NOW!

Cossor's fast test and repair service is available to all users of

SORENSEN
POWER SUPPLIES

NASHUA
COPYING
MACHINES

Qume
SPRINT PRINTERS

AMPEX
VDU's

datasouth
PRINTERS

These are just some of the companies who have now appointed us as UK service agents and whose customers can take advantage of our unrivalled test and repair service.

Our world-wide reputation for high quality products means that all our repair work is done to the highest standard (MOD Defence Standard 0521 in fact). Additionally, we have insurance cover for the time your equipment is in our hands. So, this is a service that you can trust.

Just as important, our service is fast - in emergencies we can repair single boards within 48 hours.

If you own any of these products, or indeed have any electronics service problems to discuss, just telephone Henry Lassman on Harlow (0279) 26862. We know we can help.

Cossor Electronics Limited
Service Division
The Pinnacles Elizabeth Way
Harlow Essex CM19 5BB.

COSSOR
electronics

Thinking for tomorrow

A Raytheon Company

**WE CAN ASSIST
YOUR COMPANY**

If you are a supplier of electronics products, you may well find that your marketing will benefit with the backing of our nationally recognised service organisation. Why not call us to discuss it?

● Circle No. 185

M-TEC

M-TEC COMPUTER SERVICES

BRINGS OUT THE PROFESSIONAL IN YOU

WRITE IN **BBCBASIC (Z80)**

AT LAST! **BBCBASIC** to run on YOUR CP/M Computer

WHY STRUGGLE ON using OLD FASHIONED basics when you can have ALL THE ADVANTAGES of **BBCBASIC (Z80)** on YOUR computer?

Of course, we can't turn your computer's video display into a high resolution colour monitor, but we can give you all the other features of **BBCBASIC**, including:-

LONG VARIABLE NAMES

MULTI-LINE REPEAT UNTIL STATEMENTS

MULTI-LINE NAMED FUNCTIONS

MULTI-LINE NAMED PROCEDURES

POWERFUL DIRECT MEMORY MANIPULATION USING THE INDIIRECTION OPERATORS

AN IN LINE ASSEMBLER USING STANDARD Z80 MNEMONICS

VERY SOPHISTICATED PARAMETER PASSING IN THE CALL STATEMENT

SERIAL RANDOM AND INDEXED DISK FILES PLUS THE ABILITY TO ACCESS ANY BYTE IN THE FILE

CLEAR SCREEN, TAB(X), TAB(X,Y), POS, VPOS and TIME. Plus ALL THE OTHER STANDARD COMMANDS etc

You can copy any program written in older 'standard' versions of BASIC with little change OR you can write well structured and easy to read programs like a professional.

You need never say GOTO again. But we won't stop you

Price, including postage, £95 + vat

BBCBASIC(Z80) will run on any computer using CP/M 2.8 or later and a Z80 processor. It comes complete with an instruction manual, a tutor on file handling, and configuration notes.

M-TEC Computer Services, Ollands Road, Reepham, Norfolk
Telephone Norwich 870620

Trade enquiries welcome

● Circle No. 186



FULL DETAILS AVAILABLE FROM
Mercator Technical Services Ltd
Unit 13 Stag Industrial Estate
Atlantic Street
Broadheath Altrincham
Tel No: 061-945 3421

CHESHIRE

● Circle No. 187

Returning by popular demand
Britain's biggest Micro show

THE Computer Fair

Personal computers
Home computing
Small business systems

Sponsored by Practical Computing and **YOUR COMPUTER**

at Earls Court,
London
16-19 June
1983

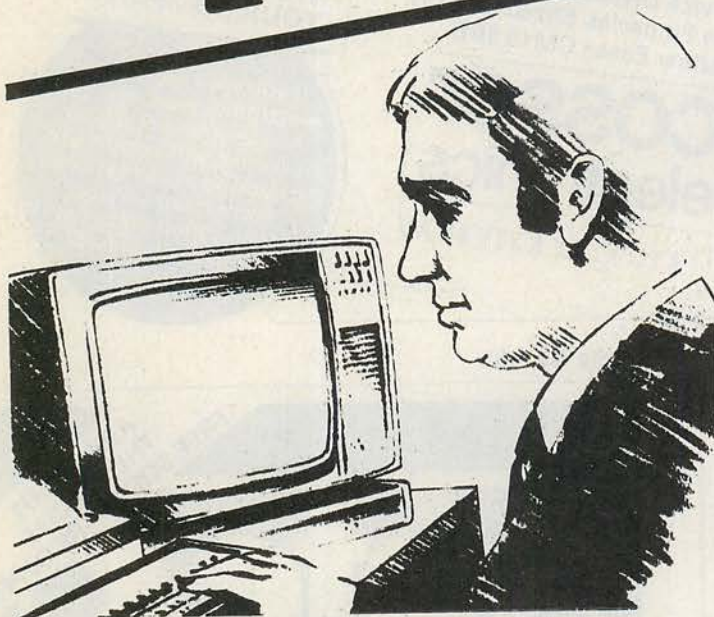

Your chance to promote your products and services at Britain's No. 1 Micro Show

Whatever branch of the business you're in – manufacturing or supplying: microcomputers, peripherals, associated accessories, software, books, video games – you need The Computer Fair.

This year the show will be bigger, open for four days – including a special Businessman's preview on the first day – and will be staged in a much larger area. Hits of last year – the Sinclair Village, Club Avenue

and the Micro Mouse Contest – will again be featured at The Computer Fair '83.

Last year 38,432 people passed through the turnstiles in only three days – this year is going to be an even greater success. Complete and return the coupon below for further information.

**Return to: The Exhibition Manager,
The Computer Fair, IPC Exhibitions Ltd,
Surrey House, 1 Throwley Way, Sutton,
Surrey SM1 4QQ.**

**THE
Computer
Fair** Personal computers
Home computing
Small business systems

Please contact me with details about exhibiting at The Computer Fair

NAME _____

POSITION IN COMPANY _____

COMPANY _____

ADDRESS _____

TEL _____

Practical Computing Back Issues

Each month Practical Computing examines personal computers, peripherals and software packages, providing unbiased critical comment on the strengths and weaknesses of the products reviewed. This, together with descriptions of programming techniques, and the Open File Section which contains hints and items for users of Apple, Pet, Tandy, BBC and Sinclair Computers, makes Practical Computing an invaluable source of information and advice. So if you've missed a particular issue make sure that you're not missing out on information which could be of real value to you. Just check through the Contents of our Back issues, then fill in and return the coupon below.



March 1982
Reviews: Sirius; Kontron; Ricoh printers; Sales Ledger package. Apple software; Adventure — history of the game and its offshoots; Patsy — how to assess your skill as a programmer.

cost networking; Superfile for data base management. Town planning — a role-playing game; Data posts explained; Cryptanalysis.

April 1982
Reviews: Oki IF-800; HP-83; Hornet — critical path package. Computer-aided design; 3-D graphics; Education — reading program. Sorting; Computing on the farm.

October 1982
Reviews: CCS — 300; Dragon 32; Sound chaser — synthesiser system for Apple II. Monte Carlo methods; Applesoft compilers; Wordpro revisited; Graphics for BBC micro; Applications programming for beginners Chris Curry interview.

May 1982
Reviews: PBM-1000; Genie I and II; Arfon light pen; MBasic; Superscale. Will personal computers oust main frames? Education — Learning multiplication tables. Sampling.

November 1982
Reviews: Commodore 64; dBase II; Bit Stik high-resolution graphics for the Apple; Microcache. Using the BBC Micro as a graphics terminal. Fourier transforms with VisiCalc. Education — timetable planning.

June 1982
Reviews: North Star Advantage; Percom; Hard-disc Superbrain; MBasic. Education — Schools' Software; Testing language ability. Stock control on a micro; Income tax assessment; CP/M explained.

December 1982
Reviews: Eagle II and TMK 330 business micros; GraForth on the Apple; Wordcraft on the Vic-20; games on the Atari. Micros under £200 — the essential facts. How to manipulate memory on the BBC Micro. Plus - a complete listing of a Monopoly program for the Pet.

July 1982
Reviews: Sinclair Spectrum; Sord M-23; Atari 800; Qume Sprint 9 printer. Structured programming in Basic; CP/M file copying; Power — utility package for the Pet. Clive Sinclair interview.

Fill in the coupon and return it with your remittance to

August 1982
Reviews: Sharp PC — 1500; Televideo 802; Graph pac for high res graphics. Towards intelligent programs; Stock control on Apple II; APL described.

Practical Computing

Address as on coupon

To obtain any of these back issues please complete and return the coupon. Prices per copy including post and packing are UK £1.50, Europe £2.00, Rest of world £2.50 (Air Mail).



Issue (month)	Year	Quantity required

To: General Sales Dept., Room 108, IPC Business Press Ltd., Quadrant House, The Quadrant, Sutton, Surrey SM2 5AS.
Please send me the back issues detailed left - for which I enclose cheque/PO for £..... payable to IPC Business Press.

Name

Address

THE BEST SELLER OF 1982

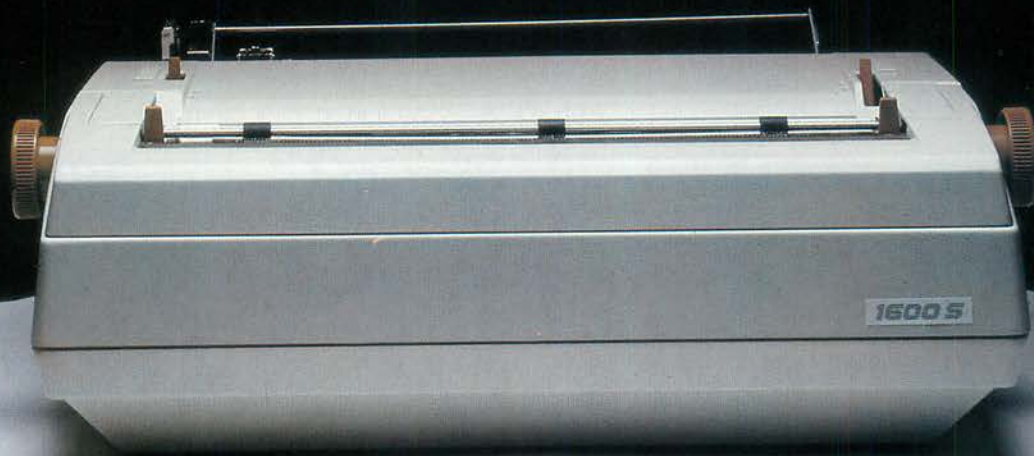

In 1982 the RICOH 1600S outsold every other comparable printer because of its speed, reliability, intelligence, flexibility and sophistication.

Because it is compatible with all known systems and software packages.

Because of the 12 month warranty that Micropute offer.

Because Micropute are a company who care, who are constantly aware of changing needs and who can fulfill any special requirements.

Not least of all, because of the price

In 1983, there will be thousands more satisfied customers.

We hope that you will be one of them.

ONLY MICROPUTE GIVE YOU SUPERCOVER

As an extra bonus Micropute Supercover will provide a 12 month on site maintenance for only £99.00 parts and labour.

Please send details of the RICOH 1600S
and 1300S

Name: _____

Position: _____

Company: _____

Address: _____

Telephone: _____

● Circle No. 190 RP2

**DON'T
FORGET THE
RICOH 1300S**

...a little bit slower but
every bit as clever.



MICROPUTE

Micropute, Catherine Street, Macclesfield,
Cheshire SK11 6QY. Tel: (0625) 615384.

This card is valid for six months only

FREE READER ENQUIRY SERVICE

Please send me more information on the items circled below:

101	102	103	104	105	106	107	108	109	110	111	112	113	114	115
116	117	118	119	120	121	122	123	124	125	126	127	128	129	130
131	132	133	134	135	136	137	138	139	140	141	142	143	144	145
146	147	148	149	150	151	152	153	154	155	156	157	158	159	160
161	162	163	164	165	166	167	168	169	170	171	172	173	174	175
176	177	178	179	180	181	182	183	184	185	186	187	188	189	190
191	192	193	194	195	196	197	198	199	200	201	202	203	204	205
206	207	208	209	210	211	212	213	214	215	216	217	218	219	220
221	222	223	224	225	226	227	228	229	230	231	232	233	234	235
236	237	238	239	240	241	242	243	244	245	246	247	248	249	250
251	252	253	254	255	256	257	258	259	260	261	262	263	264	265
266	267	268	269	270	271	272	273	274	275	276	277	278	279	280
281	282	283	284	285	286	287	288	289	290	291	292	293	294	295
296	297	298	299	300	301	302	303	304	305	306	307	308	309	310
311	312	313	314	315	316	317	318	319	320	321	322	323	324	325
326	327	328	329	330	331	332	333	334	335	336	337	338	339	340
341	342	343	344	345	346	347	348	349	350	351	352	353	354	355
356	357	358	359	360	361	362	363	364	365	366	367	368	369	370
371	372	373	374	375	376	377	378	379	380	381	382	383	384	385
386	387	388	389	390	391	392	393	394	395	396	397	398	399	400
401	402	403	404	405	406	407	408	409	410	411	412	413	414	415
416	417	418	419	420	421	422	423	424	425	426	427	428	429	430

BACK NUMBERS ORDER FORM

Please send me the back numbers of Practical Computing detailed overleaf for which I enclose Cheque/PO for £....

Prices per copy (including post and packing) U.K. £1.50. Europe (excluding U.K.) £2. Elsewhere overseas (airmail) £2.50.

PAYMENT WITH ORDER ONLY

Name

Address

NAME

ADDRESS

Tel:

PRACTICAL COMPUTING MARCH 1983 PCO 8363

SUBSCRIPTION ORDER FORM

Please send me Practical Computing each month for 12 months

Cheques should be made payable to IPC Business Press Ltd. Cash with order please.

Name

Address

Signed Date

Subscription rate U.K. £12

Overseas £18

Airmail rates can be supplied on application to the Subscription Department.

PRACTICAL COMPUTING
SUBSCRIPTION MANAGER
IPC BUSINESS PRESS
OAKFIELD HOUSE
PERRYMOUNT ROAD
HAYWARDS HEATH
SUSSEX RH16 3DH

AFFIX
STAMP
HERE

PRACTICAL COMPUTING MARCH 1983 PCO 8363

BACK NUMBERS ORDER FORM

MONTH	YEAR	QUANTITY

PRACTICAL COMPUTING MARCH 1983 PCO 8363

AFFIX
STAMP
HERE

PRACTICAL COMPUTING
 READER SERVICE DEPARTMENT
 OAKFIELD HOUSE
 PERRYMOUNT ROAD
 HAYWARDS HEATH
 SUSSEX RH16 3DH

SUBSCRIPTION ORDER FORM

Please send me Practical Computing each month for 12 months

Cheques should be made payable to IPC Business Press Ltd. Cash with order please.

Name

Address

.....

.....

.....

Signed Date

Subscription rate U.K. £12

Overseas £18

Airmail rates can be supplied on application to the Subscription Department.

AFFIX
STAMP
HERE

PRACTICAL COMPUTING
 SUBSCRIPTION MANAGER
 IPC BUSINESS PRESS
 OAKFIELD HOUSE
 PERRYMOUNT ROAD
 HAYWARDS HEATH
 SUSSEX RH16 3DH

PRACTICAL COMPUTING MARCH 1983 PCO 8363

Open File

This regular section of *Practical Computing* appears in the magazine each month, incorporating Tandy Forum, Apple Pie, Sinclair Line-up and other software interchange pages.

Open File is the part of the magazine written by you, the readers. All aspects of microcomputing are covered, from games to serious business and technical software, and we welcome contributions on CP/M, BBC Basic, Microsoft Basic, Apple Pascal and so on, as well as the established categories.

Contributors receive £30 per published page and pro rata for part pages, with a minimum of £6. Send contributions to: Open File, *Practical Computing*, Quadrant House, The Quadrant, Sutton, Surrey SM2 5AS.

Apple Pie: Menu catalogue; DOS writer; Date validation — introduced by John Harris	139
Sinclair Line-up: Press any key; Music; Spectrum games; Asteroid dodge	146
Accent Atari: Load and List; List "C:"; Screen save; Quick tricks — introduced by Jack Schofield	149
Tandy Forum: Noise input; Program protection; Tandy DOS; New data for old; Speedier graphics — introduced by John Wellsman	153
BBC Bytes: Caterpillar; Screen dump — introduced by John Harris	157
Commodore Corner: Simple sorting; Key wait routine — introduced by Mike Todd	161
End of File: Handling dates, in MBasic; Print At on the Sharp MZ-80K — the first of our regular sections on portable or general-purpose routines	165

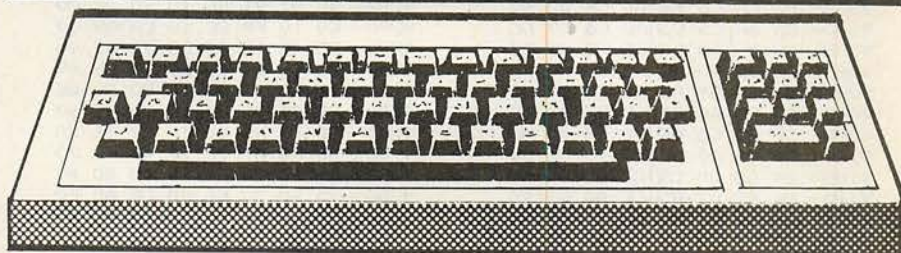

Guidelines for contributors

Programs should be accompanied by documentation which explains to other readers what your program does and, if possible, how it does it. It helps if documentation is typed or printed with double-line spacing — cramped or handwritten material is liable to delay and error.

Program listings should, if at all possible, be printed out. Use a new ribbon in your

printer, please, so that we can print directly from a photograph of the listing and avoid typesetting errors. If all you can provide is a typed or handwritten listing, please make it clear and unambiguous; graphics characters, in particular, should be explained.

We can accept material for the Pet, Vic and Sharp MZ-80K on cassette, and material for the larger machines can be sent on IBM-format 8in. floppy discs.

APPLE PIE

by John Harris



Menu catalogue

AN OBJECT CODE PROGRAM to exhibit the start address and length of binary program files on disc together with details of other files in the catalogue comes from J J Taylor

(continued on next page)

Menu catalogue.

```

JLOAD HELLO
JLIST 300,310

300 HOME : VTAB 10: PRINT " CATA
    LOG BY J.TAYLOR"
301 PRINT
305 PRINT "                14 WOODWA
    Y CLOSE,"
306 PRINT
307 PRINT "                TEIGNMOUT
    H,DEVON."
308 VTAB 20: PRINT "CALL 36864 0
    R $90006 TO RETURN TO MENU"
309 FOR I = 1 TO 5000: NEXT I
310 PRINT "BRUN MENU CATALOG"
    
```

Menu catalogue. Hex dump.

JBLOAD MENU CATALOG,A#9000
JCALL -151

*9000.9512

9000-	4C 17 91 A9 90 A0 0B 20	919B-	A9 04 85 24 A0 00 B1 1A	935B-	00 B1 1A C9 00 F0 17 C9
900B-	D9 03 60 01 60 01 00 11	91A0-	20 4A FF 20 BC 93 20 C7	9360-	80 F0 13 C9 04 F0 20 C9
9010-	0F 1C 90 00 60 00 00 01	91AB-	93 20 3F FF A0 00 B1 1A	936B-	84 F0 1C C9 82 F0 29 C9
901B-	00 00 60 01 00 01 EF DB	91B0-	20 ED FD C0 14 F0 13 CB	9370-	02 F0 25 4C D6 94 20 5B
9020-	AA BD BD BD BD BD BD BD	91B8-	4C AE 91 4C 67 92 C6 1F	937B-	FC A0 00 B9 07 91 F0 29
902B-	BD BD BD BD A0 CD C5 CE	91C0-	4C 6D 92 A9 00 85 0B 4C	9380-	20 ED FD CB 4C 7B 93 20
9030-	D5 A0 C3 C1 D4 C1 CC CF	91C8-	6A 92 A5 0B F0 F5 A5 1A	938B-	5B FC A0 00 B9 0F 91 F0
903B-	C7 A0 BD BD BD BD BD BD	91D0-	4B A5 1B 4B AD 10 90 4B	9390-	1B 20 ED FD CB 4C 8C 93
9040-	BD BD BD BD AA 8D AA	91DB-	AD 0F 90 4B AD 13 90 4B	939B-	20 5B FC A0 00 B9 B5 90
904B-	D7 C9 CC CC A0 D2 D5 CE	91E0-	AD 14 90 4B 3B A5 1A 4B	93A0-	F0 07 20 ED FD CB 4C 9D
9050-	A0 C2 D2 D5 CE A0 CF D2	91EB-	E9 03 85 1A A0 00 B1 1A	93AB-	93 A0 01 B1 1A F0 07 20
905B-	A0 C5 D8 C5 C3 A0 C1 D3	91F0-	8D 0F 90 6B 85 1A 3B A5	93B0-	ED FD CB 4C AB 93 20 8E
9060-	A0 C1 D0 A0 D2 CF D0 D2	91FB-	1A E9 02 85 1A B1 1A 8D	93BB-	FD 4C D0 03 A5 1A E9 01
906B-	C9 C1 D4 C5 AA 8D AA BD	9200-	10 90 A9 00 8D 13 90 A9	93C0-	85 1C A5 1E 85 1D 60 B1
9070-	BD D4 D9 D0 C5 BD BD C6	920B-	80 BD 14 90 20 03 90 AD	93CB-	1C C9 82 D0 0F A9 AA 20
907B-	C9 CC C5 CE C1 CD C5 BD	9210-	0C 80 8D 0F 90 AD 0D 80	93D0-	ED FD A9 C1 20 ED FD A9
9080-	BD BD BD BD BD BD BD A0	921B-	8D 10 90 A9 80 8D 14 90	93DB-	A0 20 ED FD C9 02 D0 0F
908B-	C2 D3 D4 C1 D2 D4 A0 C2	9220-	A9 00 8D 13 90 20 03 90	93E0-	A9 A0 20 ED FD A9 C1 20
9090-	CC C5 CE AA 00 CB C5 D9	922B-	AD 01 80 20 DA FD AD 00	93EB-	ED FD A9 A0 20 ED FD C9
909B-	A0 CE CF AE A0 CF C6 A0	9230-	80 20 DA FD A9 A0 20 ED	93F0-	84 D0 11 E6 0B A9 AA 20
90A0-	D4 C8 C5 A0 D0 D2 CF C7	923B-	FD A9 A0 20 ED FD AD 03	93FB-	ED FD A9 C2 20 ED FD A9
90AB-	D2 C1 CD A0 D4 CF A0 D2	9240-	80 20 DA FD AD 02 80 20	9400-	A0 20 ED FD C9 04 D0 11
90B0-	D5 CE BA AD 00 8D 84 D2	924B-	DA FD A9 00 85 0B 6B 8D	940B-	E6 0B A9 A0 20 ED FD A9
90BB-	D5 CE A0 00 C2 C9 CE C1	9250-	1A 90 6B 8D 13 90 6B 8D	9410-	C2 20 ED FD A9 A0 20 ED
90C0-	D2 D9 AF C1 D0 D0 CC C5	925B-	0F 90 6B 8D 10 90 6B 85	941B-	FD C9 01 D0 0F A9 A0 20
90CB-	D3 CF C6 D4 A0 CF D2 A0	9260-	1B 6B 85 1A 4C 6A 92 4C	9420-	ED FD A9 C9 20 ED FD A9
90D0-	C5 D8 C5 C3 A0 C6 C9 CC	926B-	9E 92 20 8E FD 1B A5 1A	942B-	A0 20 ED FD C9 81 D0 0F
90DB-	C5 D3 A0 D0 CC C5 C1 D3	9270-	69 23 85 1A 90 03 4C 8B	9430-	A9 AA 20 ED FD A9 C9 20
90E0-	C5 8D A0 A0 A0 A0 A0 A0	927B-	92 A5 1F 69 01 85 1F 1B	943B-	ED FD A9 A0 20 ED FD C9
90EB-	C1 CE D9 A0 CB C5 D9 A0	9280-	A0 00 B1 1A C9 00 F0 16	9440-	80 D0 0F A9 AA 20 ED FD
90F0-	D4 CF A0 C3 CF CE D4 C9	928B-	4C 81 91 CE 10 90 2C 00	944B-	A9 D4 20 ED FD A9 A0 20
90FB-	CE D5 C5 AE A0 A0 A0 A0	9290-	C0 10 FB 2C 10 C0 A9 00	9450-	ED FD C9 00 D0 0F A9 A0
9100-	A0 A0 A0 A0 A0 A0 00 8D	929B-	85 4B 1B 4C 5E 91 A9 00	945B-	20 ED FD A9 D4 20 ED FD
910B-	84 C5 D8 C5 C3 A0 00 8D	92A0-	85 4B A9 00 20 4B F9 A9	9460-	A9 A0 20 ED FD 60 A0 02
9110-	84 C2 D2 D5 CE A0 00 20	92AB-	00 85 22 8D 19 90 20 8E	946B-	A9 00 4B A5 44 D9 A4 B3
911B-	5B FC A9 00 85 73 A9 90	92BB-	FD A9 0F 8D 10 90 A9 60	9470-	90 12 F9 A4 B3 85 44 A5
9120-	85 74 AD EA B7 8D 0D 90	92CB-	8D 14 90 C6 1F A9 16 20	947B-	45 E9 00 85 45 6B 69 00
912B-	AD E9 B7 8D 0C 90 A9 02	92C0-	5B FB A2 26 20 4A F9 20	9480-	4B 4C 6B 74 6B 09 B0 C0
9130-	85 F9 85 22 20 5B FB A0	92CB-	8E FD 20 8E FD A0 00 B9	948B-	02 F0 03 20 ED FD 8B 10
913B-	00 84 0B 89 20 90 F0 07	92D0-	95 90 20 ED FD C9 AD F0	9490-	D7 60 0B 4B A9 00 85 EB
9140-	20 ED FD CB 4C 3B 91 A9	92DB-	0B CB 4C CF 92 CA 4C E5	949B-	A2 00 8D 11 95 E4 F9 F0
914B-	05 85 22 A9 16 20 5B FB	92E0-	72 A2 00 A0 00 20 35 FD	94A0-	12 ED 2F 0F 20 B6 94 1B
9150-	A9 60 85 1E A9 01 85 1F	92EB-	C9 8D D0 03 4C FD 92 20	94AB-	65 EB 85 EB 90 EC E6 EC
915B-	20 BE FD 4C 6E 91 A5 1E	92F0-	ED FD 9D 11 95 C9 8B F0	94B0-	4C 9A 94 6B 2B 60 0B 4B
9160-	69 01 85 1E 8D 14 90 A5	92FB-	E4 E8 4C E5 92 8A C9 02	94BB-	06 EB 26 EC A5 EC 4B A5
916B-	1F 69 01 85 1F 1B 20 03	9300-	F0 11 A2 00 BD 11 95 A2	94C0-	EB 06 EB 26 EC 06 EB 26
9170-	90 A9 0E 85 1A A5 1E 85	930B-	01 9D 11 95 A9 B0 A2 00	94CB-	EC 1B 65 EB 85 EB 6B 65
917B-	1B A0 00 B1 1A C9 00 F0	9310-	9D 11 95 20 92 94 1B A9	94D0-	EC 85 EC 6B 2B 60 A9 00
9180-	3A A5 1A E9 03 85 1C A5	931B-	60 85 1B A9 01 85 ED A9	94DB-	85 0B 85 24 A9 16 20 5B
918B-	1E 85 1D B1 1C C9 FF F0	9320-	0B 85 1A A0 00 B1 1A C9	94E0-	FB A0 00 B9 BC 90 F0 07
9190-	2D A5 1F 85 44 20 66 94	932B-	FF D0 1B C6 ED 1B A5 1A	94EB-	20 ED FD CB 4C E3 94 2C
		9330-	69 23 85 1A 90 07 E6 1B	94F0-	00 C0 10 FB 2C 10 C0 A0
		933B-	E6 ED 4C 1F 93 E6 ED 1B	94FB-	00 A9 00 85 24 A9 16 20
		9340-	4C 23 93 A5 ED C5 EB F0	9500-	5B FB 20 42 FC A9 00 85
		934B-	03 4C 2D 93 A5 1A 69 01	950B-	24 A9 16 20 5B FB 4C CF
		9350-	85 1A 90 02 E6 1B 1B A0	9510-	92 FF B3

(continued from previous page)

of Teignmouth, Devon. After listing, the program allows any of the files to be Run, BRun or Execed as appropriate, using a numeric selection return. Mr Taylor normally ends programs with a return to menu option, Call 36864.

Frightening though the condensed hex listing is, the full source listing takes rather a lot of space. Mr Taylor will send you a disassembled listing or, if you prefer, disc copy on receipt of a disc — SSDD 40 track. His address is included in the Hello program extension printed.

DOS writer

With computer literacy growing as it is there are now two kinds of programmer: those who work in a commercial programming environment and those who don't. It is clear to which group Andrew Cox of Brigg, South Humberside belongs.

He has sent a code generator capable of placing DOS commands into a Basic program.

Andrew Cox says the program was written to allow people to include short disc-access routines in their programs without having to learn the Apple DOS. The routines it can write cover a great deal of the everyday problems of storing variables and arrays on disc, and retrieving them. The program should be suited to people in a computer club, for example, who do not have the time to keep writing such routines. The programs produced will also show how DOS is used, maybe to people taking the O-level computer course where DOS is not covered by the syllabus.

No commercial programming manager that I have ever met is going to allow a product like that on his site, and not many commercial programmers would want him to, whether it generates Basic, Cobol or what you will. It limits his flexibility of

design, puts a further barrier between him and his machine and tends to make him more a program user than a program creator.

But for the rest of us, why not? It has the advantage of fewer keystrokes to a given result, and leaves the monotonous part of the code to take care of itself and highlights the problem needing solution.

What we have printed here is the listing itself, together with a sample run from which the menu-selection has been suppressed to save space.

Example program 1 sets up variable and array values, and calls the generated subroutine to store them on disc. Example program 2 retrieves these values — with the curious exception of ZZ = 1 — and displays them for verification.

The disc contents are catalogued to the printer at the end of program 1. An Exec file created from within the same program is

(continued on page 144)

DOS writer.

```

JLOAD DOS WRITER
JLIST

10 F1 = 0
20 TEXT : HOME : PRINT TAB (15)
   ; "DOS WRITER": PRINT : PRINT
   : PRINT "PLEASE WAIT A MOMEN
   T"
30 OP# = "APPEND TEXT FILE": WR# =
   "WRITE TEXT FILE": CL# = "CLO
   SE TEXT FILE": D# = CHR# (4)

40 DIM A#(255), A(9,1)
50 PRINT D#; "OPEN TEXT FILE"
60 PRINT D#; "DELETE TEXT FILE"
70 PRINT D#; "OPEN TEXT FILE": PRINT
   D#; "WRITE TEXT FILE": PRINT
   "MON C, I, O": PRINT D#; CL#
80 GOSUB 100
90 GOTO 310
100 REM MAIN SUBROUTINE
110 HOME : VTAB 2: HTAB 15: PRINT
   "MAIN MENU"
120 HTAB 15: FOR Y = 1 TO 9: PRINT
   "-": NEXT : PRINT
130 VTAB 6
140 HTAB 15: PRINT "1. CATALOG"
150 PRINT
160 HTAB 15: PRINT "2. EXEC FILE
   WRITER"
170 PRINT
180 HTAB 15: PRINT "3. STORE VAR
   IABLES"
190 PRINT
200 HTAB 15: PRINT "4. STORE ARR
   AY"
210 PRINT
220 HTAB 15: PRINT "5. RETRIEVE
   VARIABLES"
230 PRINT
240 HTAB 15: PRINT "6. RETRIEVE
   ARRAY"
250 PRINT
260 HTAB 15: PRINT "7. QUIT"
270 PRINT
280 PRINT : HTAB 20: INPUT "ENTE
   R ITEM NO. "; A#
290 IZ = VAL (A#): IF IZ < 1 OR
   IZ > 7 THEN VTAB PEEK (37)
   - 2: GOTO 280
300 RETURN
310 IF F1 = 1 THEN 360
320 HOME : INPUT "NAME OF PROGRA
   M : "; NA#
330 PRINT : INPUT "STARTING FROM
   WHICH LINE : -"; L
340 F1 = 1
350 PRINT D#; OP#: PRINT D#; WR#: PRINT

   "LOAD "; NA#: PRINT D#; CL#
360 ON IZ GOTO 370, 420, 870, 600, 1
   020, 680, 1050
370 HOME : INPUT "WHICH DISC DRI
   VE (1 OR 2) "; D
380 IF D < > 1 AND D < > 2 THEN
   370
390 PRINT D#; OP#: PRINT D#; WR#
400 PRINT L: "PRINT CHR#(4);"; CHR#
   (34); "CATALOG, D"; D; CHR# (34)
   : L = L + 10
410 PRINT D#; CL#: GOTO 1240
420 HOME : INPUT "ENTER NAME OF
   EXEC FILE YOU WISH TO CR
   EATE : "; NB#
430 IF LEN (NB#) < 1 THEN 420
440 INPUT "DO YOU WISH TO EXECUT
   E IT AT THE END? (Y/N)"; A#

450 IF LEFT# (A#, 1) < > "Y" THEN
   A# = "N"
460 HOME : PRINT "INPUT COMMANDS
   , TO STOP TYPE 'RETURN' ALO
   NE"
470 FOR I = 0 TO 255: GOSUB 1150
   : A#(I) = A#: IF A# = "" THEN
   490
480 NEXT : I = I - 1
490 A = I - 1
500 PRINT D#; OP#: PRINT D#; WR#
510 PRINT L: "REM FILE "; NB#: L =
   L + 10
520 PRINT L: "PRINT CHR#(4);"; CHR#
   (34); "OPEN "; NB#: CHR# (34):
   L = L + 10
530 PRINT L: "PRINTCHR#(4);"; CHR#
   (34); "DELETE "; NB#: CHR# (34)
   : L = L + 10
540 PRINT L: "PRINTCHR#(4);"; CHR#
   (34); "OPEN "; NB#: CHR# (34):
   L = L + 10
550 PRINT L: "PRINTCHR#(4);"; CHR#
   (34); "WRITE "; NB#: CHR# (34)
   : L = L + 10
560 FOR I = 0 TO A: PRINT L: "PR
   INT "; CHR# (34); A#(I); CHR#
   (34); L = L + 10: NEXT
570 IF A# = "Y" THEN PRINT L: "P
   RINTCHR#(4);"; CHR# (34); "EX
   EC "; NB#: CHR# (34): L = L +
   10
580 PRINT L: "PRINTCHR#(4);"; CHR#
   (34); "CLOSE "; NB#: CHR# (34)
   : L = L + 10
590 PRINT D#; CL#: GOTO 1240
600 GOSUB 670
610 PRINT L: "PRINTCHR#(4);"; CHR#
   (34); "DELETE ARRAY "; NB#: CHR#
   (34): L = L + 10
620 PRINT L: "PRINTCHR#(4);"; CHR#
   (34); "OPEN ARRAY "; NB#: CHR#
   (34): L = L + 10
630 PRINT L: "PRINTCHR#(4);"; CHR#
   (34); "WRITE ARRAY "; NB#: CHR#
   (34): L = L + 10
640 FOR I = 1 TO A: PRINT L: "FOR
   I "; I: " = "; A(I, 0); " TO "; A(I,
   1) : L = L + 10: NEXT
650 PRINT L: "PRINT "; NB#: (" "; FOR
   I = 1 TO A: PRINT "I "; I: ", ";
   : NEXT : PRINT CHR# (8); ")
   : L = L + 10
660 GOTO 830
670 REM SUBROUTINE
680 HOME : INPUT "ENTER THE NAME
   OF THE ARRAY : "; NB#
690 IF LEN (NB#) < 1 THEN 680
700 INPUT "HOW MANY DIMENSIONS ?
   "; A
710 IF A > 9 THEN HOME : PRINT
   "ARRAY TOO COMPLEX, SIMPLIFY
   ": GOTO 700
720 FOR I = 1 TO A
730 HOME : PRINT "ENTER THE EXTE
   NT OF THE DIMENSION"
740 PRINT "IN THE FORM 'FROM', 'T
   O'": INPUT A(I, 0), A(I, 1): IF
   A(I, 1) < A(I, 0) THEN PRINT
   "THE FIRST DIMENS ON MUST BE S
   MALLER THAN THE SEC ON D": FOR
   J = 1 TO 5000: NEXT : GOTO 7
   30
750 NEXT
760 PRINT D#; OP#: PRINT D#; WR#
770 PRINT L: "REM ARRAY "; NB#: L =
   L + 10
780 PRINT L: "PRINTCHR#(4);"; CHR#
   (34); "OPEN ARRAY "; NB#: CHR#
   (34): L = L + 10
790 IF IZ = 4 THEN RETURN
800 PRINT L: "PRINTCHR#(4);"; CHR#
   (34); "READ ARRAY "; NB#: CHR#
   (34): L = L + 10
810 FOR I = 1 TO A: PRINT L: "FOR
   I "; I: " = "; A(I, 0); " TO "; A(I,
   1) : L = L + 10: NEXT
820 PRINT L: "INPUT "; NB#: (" "; FOR
   I = 1 TO A: PRINT "I "; I: ", ";
   : NEXT : PRINT CHR# (8); ")
   : L = L + 10
830 FOR I = 1 TO A: PRINT L: "NEX
   T": L = L + 10: NEXT
840 PRINT L: "PRINTCHR#(4);"; CHR#
   (34); "CLOSE ARRAY "; NB#: CHR#
   (34): L = L + 10
850 PRINT D#; CL#
860 GOTO 1240
870 HOME : INPUT "NAME OF FILE :
   "; NB#
880 IF LEN (NB#) < 1 THEN 870
890 FOR I = 1 TO 255: HOME : PRINT
   "ENTER NAME OF VARIABLE "; I:
   PRINT "'RETURN' ALONE TO FI
   NISH : -";
900 INPUT " "; A#(I): IF A#(I) = "
   " THEN GOTO 920
910 NEXT : I = I - 1
920 A = I - 1
930 PRINT D#; OP#: PRINT D#; WR#
940 PRINT L: "PRINTCHR#(4);"; CHR#
   (34); "OPEN "; NB#: CHR# (34):
   L = L + 10: IF IZ = 5 THEN RETURN
950 PRINT L: "PRINTCHR#(4);"; CHR#
   (34); "DELETE "; NB#: CHR# (34)
   : L = L + 10
960 IF IZ = 5 THEN RETURN
970 PRINT L: "PRINTCHR#(4);"; CHR#
   (34); "OPEN "; NB#: CHR# (34):
   L = L + 10
980 PRINT L: "PRINTCHR#(4);"; CHR#
   (34); "WRITE "; NB#: CHR# (34)
   : L = L + 10
990 FOR I = 1 TO A: PRINT L: "PRI
   NT "; A#(I): L = L + 10: NEXT
1000 PRINT L: "PRINTCHR#(4);"; CHR#
   (34); "CLOSE "; NB#: CHR# (34)
   : L = L + 10
1010 PRINT D#; CL#: GOTO 1240
1020 GOSUB 870
1030 PRINT L: "PRINTCHR#(4);"; CHR#
   (34); "READ "; NB#: CHR# (34):
   L = L + 10
1040 FOR I = 1 TO A: PRINT L: "IN
   PUT "; A#(I): L = L + 10: NEXT
   : GOTO 1000
1050 HOME : PRINT "PLEASE WAIT A
   MOMENT ---"
1060 PRINT D#; OP#: PRINT D#; WR#
1070 PRINT "RENAME "; NA#: "ORIGI
   NAL "; NA#
1080 PRINT "SAVE "; NA#
1090 PRINT "HOME: LIST"
1100 PRINT "NOMON C, I, O"
1110 PRINT "DELETE TEXT FILE"
1120 PRINT D#; CL#
1130 PRINT D#; "EXEC TEXT FILE"
1140 NEW
1150 A# = ""
1160 X = POS (0): Y = PEEK (37)
1170 IF X > 40 THEN X = 1: Y = Y +
   1
1180 GET X#
1190 IF X# = CHR# (13) THEN PRINT
   : RETURN
1200 IF X# = CHR# (34) AND F2 =
   0 THEN A# = A# + CHR# (34) +
   " "; CHR# (34); " "; CHR# (34): F2
   = 1: GOTO 1230
1210 IF X# = CHR# (34) AND F2 =
   1 THEN A# = A# + CHR# (34) +
   " "; CHR# (34); " ": F2 = 0: GOTO 12
   30
1220 A# = A# + X#
1230 POKE 36, X: POKE 37, Y: PRINT
   X#: GOTO 1160
1240 HOME : INPUT "SUBROUTINE (Y
   /N) ? "; A#: IF LEFT# (A#, 1) <
   > "Y" THEN 80
1250 PRINT D#; OP#: PRINT D#; WR#
1260 PRINT L: "RETURN": L = L + 10

1270 PRINT D#; CL#: GOTO 80

JCATALOG
DISK VOLUME 001
A 007 HELLO
B 007 MENU CATALOG
A 002 PRINTSET
A 010 FARLIE
T 003 TEXT FILE
A 017 DOS WRITER
A 002 EXAMPLE 2
A 006 EXAMPLE

JLOAD DOS WRITER
J100 GO TO 280: REM MENU SUPPRESS

JRUN
DOS WRITER

PLEASE WAIT A MOMENT
ENTER ITEM NO. 1
NAME OF PROGRAM : -EXAMPLE
STARTING FROM WHICH LINE : -1000
WHICH DISC DRIVE (1 OR 2) 1
SUBROUTINE (Y/N) ? N

ENTER ITEM NO. 2
ENTER NAME OF EXEC FILE YOU WISH TO
CREATE : -EXAMPLE EXEC
DO YOU WISH TO EXECUTE IT AT THE END?
(Y/N) Y
INPUT COMMANDS, TO STOP TYPE 'RETURN'
ALONE
CATALOG

SUBROUTINE (Y/N) ? N

ENTER ITEM NO. 3
NAME OF FILE : -VARIABLES
ENTER NAME OF VARIABLE 1
'RETURN' ALONE TO FINISH : -A
ENTER NAME OF VARIABLE 2
'RETURN' ALONE TO FINISH : -Z
ENTER NAME OF VARIABLE 3
'RETURN' ALONE TO FINISH : -A#
ENTER NAME OF VARIABLE 4
'RETURN' ALONE TO FINISH : -Z#
ENTER NAME OF VARIABLE 5
'RETURN' ALONE TO FINISH : -N%
ENTER NAME OF VARIABLE 6
'RETURN' ALONE TO FINISH : -A
ENTER NAME OF VARIABLE 7
'RETURN' ALONE TO FINISH : -
SUBROUTINE (Y/N) ? N

```

(listing continued on next page)

(listing continued from previous page)

```

ENTER ITEM NO. 4
ENTER THE NAME OF THE ARRAY :-AZ
HOW MANY DIMENSIONS ?2
ENTER THE EXTENT OF THE DIMENSION
IN THE FORM 'FROM','TO'
?1,5
ENTER THE EXTENT OF THE DIMENSION
IN THE FORM 'FROM','TO'
?1,4
SUBROUTINE (Y/N)?N
    
```

```

ENTER ITEM NO. 4
ENTER THE NAME OF THE ARRAY :-B
HOW MANY DIMENSIONS ?2
ENTER THE EXTENT OF THE DIMENSION
IN THE FORM 'FROM','TO'
?1,3
ENTER THE EXTENT OF THE DIMENSION
IN THE FORM 'FROM','TO'
?1,2
SUBROUTINE (Y/N)?N
    
```

```

ENTER ITEM NO. 4
ENTER THE NAME OF THE ARRAY :-C#
HOW MANY DIMENSIONS ?1
ENTER THE EXTENT OF THE DIMENSION
IN THE FORM 'FROM','TO'
?1,26
SUBROUTINE (Y/N)?Y
    
```

```

ENTER ITEM NO. 7
PLEASE WAIT A MOMENT---
    
```

JLOAD ORIGINAL EXAMPLE
JLIST

```

10 REM THIS TESTS OPTIONS 1-4
20 A = 1:Z = 26:A# = "HELLO":Z# =
  "GOODBYE":N# = 14:VA = 12.34

30 DIM AZ(5,4),B(3,2),C#(26)
40 FOR I = 1 TO 5: FOR J = 1 TO
  4:AZ(I,J) = 5 * I + J: NEXT
  : NEXT
50 FOR I = 1 TO 3: FOR J = 1 TO
  2:B(I,J) = 1.1 * I + J: NEXT
  : NEXT
60 FOR I = 1 TO 26:C#(I) = STR#
  (I): NEXT
70 GOSUB 1000
80 END
    
```

JLOAD EXAMPLE
JLIST

```

10 REM THIS TESTS OPTIONS 1-4
20 A = 1:Z = 26:A# = "HELLO":Z# =
  "GOODBYE":N# = 14:VA = 12.34

30 DIM AZ(5,4),B(3,2),C#(26)
40 FOR I = 1 TO 5: FOR J = 1 TO
  4:AZ(I,J) = 5 * I + J: NEXT
  : NEXT
50 FOR I = 1 TO 3: FOR J = 1 TO
  2:B(I,J) = 1.1 * I + J: NEXT
  : NEXT
60 FOR I = 1 TO 26:C#(I) = STR#
  (I): NEXT
70 GOSUB 1000
80 END

1000 PRINT CHR# (4);"CATALOG,D1
  "
1010 REM FILE EXAMPLE EXEC
1020 PRINT CHR# (4);"OPEN EXAMP
  LE EXEC"
1030 PRINT CHR# (4);"DELETE EXA
  MPLE EXEC"
1040 PRINT CHR# (4);"OPEN EXAMP
  LE EXEC"
1050 PRINT CHR# (4);"WRITE EXAM
  PLE EXEC"
1060 PRINT "CATALOG"
1070 PRINT CHR# (4);"CLOSE EXAM
  PLE EXEC"
1080 PRINT CHR# (4);"OPEN VARIA
  BLES"
1090 PRINT CHR# (4);"DELETE VAR
  IABLES"
1100 PRINT CHR# (4);"OPEN VARIA
  BLES"
1110 PRINT CHR# (4);"WRITE VARI
  ABLES"
1120 PRINT A
1130 PRINT Z
1140 PRINT A#
1150 PRINT Z#
1160 PRINT N#
1170 PRINT A
    
```

```

1180 PRINT CHR# (4);"CLOSE VARI
  ABLES"
1190 REM ARRAY AZ
1200 PRINT CHR# (4);"OPEN ARRAY
  AZ"
1210 PRINT CHR# (4);"DELETE ARR
  AY AZ"
1220 PRINT CHR# (4);"OPEN ARRAY
  AZ"
1230 PRINT CHR# (4);"WRITE ARR
  AY AZ"
1240 FOR I1 = 1 TO 5
1250 FOR I2 = 1 TO 4
1260 PRINT AZ(I1,I2)
1270 NEXT
1280 NEXT
1290 PRINT CHR# (4);"CLOSE ARR
  AY AZ"
1300 REM ARRAY B
1310 PRINT CHR# (4);"OPEN ARRAY
  B"
1320 PRINT CHR# (4);"DELETE ARR
  AY B"
1330 PRINT CHR# (4);"OPEN ARRAY
  B"
1340 PRINT CHR# (4);"WRITE ARR
  AY B"
1350 FOR I1 = 1 TO 3
1360 FOR I2 = 1 TO 2
1370 PRINT B(I1,I2)
1380 NEXT
1390 NEXT
1400 PRINT CHR# (4);"CLOSE ARR
  AY B"
1410 REM ARRAY C#
1420 PRINT CHR# (4);"OPEN ARRAY
  C#"
1430 PRINT CHR# (4);"DELETE ARR
  AY C#"
1440 PRINT CHR# (4);"OPEN ARRAY
  C#"
1450 PRINT CHR# (4);"WRITE ARR
  AY C#"
1460 FOR I1 = 1 TO 26
1470 PRINT C#(I1)
1480 NEXT
1490 PRINT CHR# (4);"CLOSE ARR
  AY C#"
1500 RETURN
    
```

JLOAD DOS WRITER

J100 GO TO 280:REM MENU SUPPRESS

JRUN

DOS WRITER

PLEASE WAIT A MOMENT

ENTER ITEM NO. 5
NAME OF PROGRAM :-EXAMPLE 2

```

STARTING FROM WHICH LINE :-1000
NAME OF FILE :-VARIABLES
ENTER NAME OF VARIABLE 1
'RETURN' ALONE TO FINISH :-X
ENTER NAME OF VARIABLE 2
'RETURN' ALONE TO FINISH :-Y
ENTER NAME OF VARIABLE 3
'RETURN' ALONE TO FINISH :-X#
ENTER NAME OF VARIABLE 4
'RETURN' ALONE TO FINISH :-Y#
ENTER NAME OF VARIABLE 5
'RETURN' ALONE TO FINISH :-Z#
ENTER NAME OF VARIABLE 6
'RETURN' ALONE TO FINISH :-ZZ
ENTER NAME OF VARIABLE 7
'RETURN' ALONE TO FINISH :-
SUBROUTINE (Y/N)?N
    
```

```

ENTER ITEM NO. 6
ENTER THE NAME OF THE ARRAY :-XX
HOW MANY DIMENSIONS ?2
ENTER THE EXTENT OF THE DIMENSION
IN THE FORM 'FROM','TO'
?1,5
ENTER THE EXTENT OF THE DIMENSION
IN THE FORM 'FROM','TO'
?1,4
SUBROUTINE (Y/N)?N
    
```

```

ENTER ITEM NO. 6
ENTER THE NAME OF THE ARRAY :-Y
HOW MANY DIMENSIONS ?2
ENTER THE EXTENT OF THE DIMENSION
IN THE FORM 'FROM','TO'
?1,3
ENTER THE EXTENT OF THE DIMENSION
IN THE FORM 'FROM','TO'
?1,2
SUBROUTINE (Y/N)?N
    
```

ENTER ITEM NO. 6

```

ENTER THE NAME OF THE ARRAY :-Z#
HOW MANY DIMENSIONS ?1
ENTER THE EXTENT OF THE DIMENSION
IN THE FORM 'FROM','TO'
?1,26
SUBROUTINE (Y/N)?Y
    
```

ENTER ITEM NO. 7
PLEASE WAIT A MOMENT---

JLOAD ORIGINAL EXAMPLE 2
JLIST

```

10 REM THIS TESTS OPTIONS 5-6
20 X = 0:Y = 0:X# = "":Y# = "":Z# =
  0:ZZ = 0
30 DIM XX(5,4),Y(3,2),Z#(26)
40 GOSUB 1000
50 PRINT "1=":X: PRINT "26=":Y: PRINT
  "HELLO=":X#: PRINT "GOODBYE="
  :Y#: PRINT "14=":Z#: PRINT
  "12.34=":ZZ
60 PRINT "23=":XX(4,3): PRINT "3
  .2=":Y(2,1): PRINT "20=":Z#(
  20)
70 END
    
```

JLOAD EXAMPLE 2
JLIST

```

10 REM THIS TESTS OPTIONS 5-6
20 X = 0:Y = 0:X# = "":Y# = "":Z# =
  0:ZZ = 0
30 DIM XX(5,4),Y(3,2),Z#(26)
40 GOSUB 1000
50 PRINT "1=":X: PRINT "26=":Y: PRINT
  "HELLO=":X#: PRINT "GOODBYE="
  :Y#: PRINT "14=":Z#: PRINT
  "12.34=":ZZ
60 PRINT "23=":XX(4,3): PRINT "3
  .2=":Y(2,1): PRINT "20=":Z#(
  20)
70 END
    
```

```

1000 PRINT CHR# (4);"OPEN VARIA
  BLES"
1010 PRINT CHR# (4);"READ VARIA
  BLES"
1020 INPUT X
1030 INPUT Y
1040 INPUT X#
1050 INPUT Y#
1060 INPUT Z#
1070 INPUT ZZ
1080 PRINT CHR# (4);"CLOSE VARI
  ABLES"
    
```

```

1090 REM ARRAY X#
1100 PRINT CHR# (4);"OPEN ARRAY
  X#"
1110 PRINT CHR# (4);"READ ARRAY
  X#"
1120 FOR I1 = 1 TO 5
1130 FOR I2 = 1 TO 4
1140 INPUT XX(I1,I2)
1150 NEXT
1160 NEXT
1170 PRINT CHR# (4);"CLOSE ARR
  AY X#"
1180 REM ARRAY Y
1190 PRINT CHR# (4);"OPEN ARRAY
  Y"
1200 PRINT CHR# (4);"READ ARRAY
  Y"
1210 FOR I1 = 1 TO 3
1220 FOR I2 = 1 TO 2
1230 INPUT Y(I1,I2)
1240 NEXT
1250 NEXT
1260 PRINT CHR# (4);"CLOSE ARR
  AY Y"
1270 REM ARRAY Z#
1280 PRINT CHR# (4);"OPEN ARRAY
  Z#"
1290 PRINT CHR# (4);"READ ARRAY
  Z#"
1300 FOR I1 = 1 TO 26
1310 INPUT Z#(I1)
1320 NEXT
1330 PRINT CHR# (4);"CLOSE ARR
  AY Z#"
1340 RETURN
    
```

JLOAD EXAMPLE
JRUN

(continued on page 144)

DOUBLE DENSITY OSBORNE AND PRAXIS

£1599
+ VAT

THE OFFICE OF
THE FUTURE TODAY

1 The heart of this office of the future is the powerful new "double density" Osborne 1 portable computer with 64k memory, two 200k disc drives and built-in monitor. The Osborne is linked to an Olivetti Praxis 30 11cps daisy-wheel printer/typewriter for printing your work superbly. In addition you get software (sold elsewhere for up to £800) to make your office of the future into a word-processor or a financial planner.

And as a special bonus we add the exciting new UCSD Pascal.

3 The Olivetti Praxis 30 is a new style electronic typewriter with its own memory, automatic erase, and a double keyboard which gives you 14 extra characters. Use your Praxis on its own as a prestige easy-to-use typewriter,

or plug it into your Osborne and use it as a high quality computer printer.

2 Your Osborne and Praxis are a remarkable combination. The machines are so portable you can carry them both home instead of working late. Plug them together slip the Wordstar/Mailmerge disc into the drive and you have a word-processor with twice the capacity of earlier Osbornes. Change discs for Supercalc and you have the power of a dozen clerks for your budgets. Then Osborne types your work perfectly on Praxis.

O-COMPUTERS

A member of the C/WP Group
104-106 Rochester Row, London SW1
Telephone: 01-828 9000

● Circle No. 191

(listing continued from page 142)

DISK VOLUME 001

```
A 007 HELLO
B 007 MENU CATALOG
A 002 PRINTSET
A 010 FARLIE
A 017 DOS WRITER
A 006 EXAMPLE
A 005 EXAMPLE 2
A 002 ORIGINAL EXAMPLE 2
A 006 ORIGINAL EXAMPLE

IRENAME ARRAY A2,ARRAY XZ
IRENAME ARRAY B,ARRAY Y
```

```
IRENAME ARRAY C,ARRAY Z#
IRUN EXAMPLE 2
I=1
Z#=2#
HELLO=HELLO
GOODBYE=GOODBYE
I4=I4
I2.34=I
I3=I3
I.2=I.2
I20=I20

JEXEC EXAMPLE EXEC
J
```

DISK VOLUME 001

```
A 007 HELLO
B 007 MENU CATALOG
A 002 PRINTSET
A 010 FARLIE
T 002 EXAMPLE EXEC
A 017 DOS WRITER
A 006 EXAMPLE
A 005 EXAMPLE 2
T 002 VARIABLES
T 002 ARRAY XZ
A 002 ORIGINAL EXAMPLE 2
T 002 ARRAY Y
T 002 ARRAY Z#
A 006 ORIGINAL EXAMPLE
```

(continued from page 140)

used after the end of program 2 to show the store files.

The fact that this utility does not tie in with commercial practice saddens me, but that will not stop me from using it. The average commercial computer department is hampered more by its existing user software than by any other single liability, and redesigning with the inclusion of high-level generators like this would clear a lot of dead wood.

Date validation

Maurice Farlie of Balham, south London writes criticising Robin Kanagasabay's Apple Stock suite published last August: "I fully laud Robin Kanagasabay's intention to 'ensure that the program is easy to use and to make the operating environment friendly. Unfortunately, I think he has failed lamentably in some areas.

"The program displays an almost total lack of data for creating or modifying stock records, a potentially disastrous omission in any system. Garbage data, duplicate data

in fields which are used subsequently for searching, a record length exceeding 60 bytes and reports corrupted by fields which are too long are all practical possibilities.

"Nor is the program particularly 'friendly' when it does reject input as invalid. There is a price to pay in any program. This one needs over 11K of memory already but I suggest proper input validation is a necessary cost in any program with serious pretensions. I ought to admit my own extensive background in data processing, including some years as a systems designer and more recently in programmer training, though I am a relative newcomer to the world of micros."

Mr Farlie coincidentally offers a date-validation routine which, he says, properly validates the user input, allowing the user to omit leading zeros, and works for any date between January 1, 1901 and December 31, 1999. Output from the main routine are two fixed-length strings containing the date in Gregorian DDDMMYY and Julian YYDDD forms. They can serve as inputs to other date routines such as determining the

number of days between two dates or generating the date in the form:

THURSDAY 20TH AUGUST 1982

Numeric variables containing day, month and two-digit year numbers are also available.

Occasionally, the wrong date or an incorrect character is keyed in. Line 29600 automatically rejects invalid characters.

Users can backspace over one or more characters — lines 29582 to 29588 — and can also reject the date input and start again — lines 29660 to 29680. For the purpose of displaying messages and repositioning the cursor, SRow holds the line number and SCol the column number of the current cursor position. The date is built up in Inp\$.

Having keyed and tested the routine I think Maurice Farlie shows a touching faith in users not backspacing beyond their first input character. I hereby declare open the Apple Pie Date-Validation Routine of 1983 contest, winner to be declared strictly on merit. Comment on Maurice Farlie's contribution should be limited to no more than 250 words.

Date validation.

```
3LOAD FARLIE
3LIST

29400 REM ***** DATE SUB *****
29410 REM MTH BEGINNINGS & DAYS
      IN MTH FOR NON-LEAP YR
29420 DATA 001,052,060,091,121
      ,152,182,213,244,274,305,335

29430 DATA 31,28,31,30,31,30,3
      1,31,30,31,30,31
29440 DIM MTHBGN(12),DYSMTH(12)
29450 FOR I = 1 TO 12: READ MTHB
      GN(I): NEXT I
29460 FOR I = 1 TO 12: READ DYSM
      TH(I): NEXT I
29480 RETURN
29490 REM ***** END DATE SUB ***
**
29495 REM
29500 REM *****GET DATE SUB*****

29520 PRINT : INVERSE : PRINT "E
      NTER NEW DATE (DD/MM/YY) THE
      N 'RETURN'": NORMAL
29530 LET SROW = PEEK (37) + 1
29540 LET SCOL = 3: HTAB SCOL: CALL
      - 86B
29545 LET CCNT = 0
29550 LET INP$ = "": REM TO EN
      ABLE B/S TO 1ST CHAR ENTERED

29560 FOR CNT = 1 TO 9: REM +<C
      R>
29570 GET CH#
29580 IF CH# < > CHR# (8) THEN
      GOTO 29590
29582 LET SCOL = SCOL - 1: HTAB
      SCOL: CALL - 86B
29584 LET CCNT = CCNT - 1: LET C
      NT = CNT - 1
29586 LET INP$ = LEFT$ (INP$, (LEN
      (INP$) - 1))
29588 GOTO 29570
29590 IF CH# = CHR# (13) AND CN
      T > 5 THEN LET INP$ = INP$ +
```

```
"/": GOTO 29660
29600 IF ASC (CH#) < 47 OR ASC
      (CH#) > 57 THEN GOTO 29610
29602 PRINT CH#;
29605 IF CH# = "/" THEN LET CCN
      T = 0: GOTO 29620
29607 IF CCNT < 2 THEN CCNT = CC
      NT + 1: GOTO 29640
29610 LET MSG$ = "ILLEGAL CHAR":
      GOSUB 30000: GOTO 29570
29620 IF RIGHT$ (INP$, 1) = "/" THEN
      LET MSG$ = "INVALID SEQUENC
      E": GOSUB 30000: GOTO 29570
29640 LET SCOL = SCOL + 1
29645 LET INP$ = INP$ + CH#
29650 NEXT CNT
29660 HTAB (LEN (INP$) + 5): LET
      MSG$ = "OK": GOSUB 30100
29670 IF REPLY$ = "N" THEN VTAB
      SROW: GOTO 29540
29700 REM STORE IN GDTE# DDDMMYY

29705 LET GDTE$ = ""
29710 LET CCNT = 0
29715 LET INP$ = RIGHT$ (INP$, (
      LEN (INP$) - 1)): REM STRI
      P OFF LEADING '/'
29720 FOR I = 1 TO LEN (INP$)
29730 IF MID$ (INP$, I, 1) < >
      "/" THEN CCNT = CCNT + 1: GOTO
      29770
29740 IF CCNT = 1 THEN LET GDTE
      $ = GDTE$ + "0" + MID$ (INP
      $, I - 1, 1): GOTO 29760
29750 LET GDTE$ = GDTE$ + MID$
      (INP$, I - 2, 2)
29760 LET CCNT = 0
29770 NEXT
29780 LET DD = VAL (LEFT$ (GDT
      E$, 2))
29790 LET MM = VAL (MID$ (GDTE
      $, 3, 2))
29800 LET YY = VAL (RIGHT$ (GD
      TE$, 2))
29835 LET LYR = (YY / 4 = INT (
      YY / 4))
29840 LET SCOL = LEN (INP$) + 2
29845 VTAB SROW: HTAB SCOL: CALL
```

```
- 86B
29850 IF MM < = 0 OR MM > 12 THEN
      LET MSG$ = "MTH INVALID": GOSUB
      30000: GOTO 29540
29870 IF DD < = 0 OR DD > DYSMT
      H(MM) + (LYR AND MM = 2) THEN
      LET MSG$ = "DAY INVALID": GOSUB
      30000: GOTO 29540
29880 IF YY = 0 THEN LET MSG$ =
      "ZERO YR NOT ALLOWED": GOSUB
      30000: GOTO 29540
29900 REM **CONVERT DATE TO JUL
      IAN FORMAT
29905 LET JDTE$ = STR$ (YY + 10
      00 + MTHBGN(MM) + DD + (LYR AND
      MM > 2) - 1)
29910 IF LEN (JDTE$) = 4 THEN J
      DTE$ = "0" + JDTE$
29980 RETURN
29990 REM ***** END GET DATE SU
      B *****
30000 REM ***** GET INPUT ERRDR
      SUB *****
30010 VTAB SROW: HTAB SCOL + 2
30015 FLASH : PRINT MSG$: CHR# (
      7)
30020 FOR I = 1 TO 1500: NEXT I
30030 NORMAL : VTAB SROW: HTAB S
      COL: CALL - 86B
30040 RETURN
30045 REM *****END GET INPUT ER
      ROR SUB *****
30048 REM
30100 REM ***** PRINT MSG & GET
      Y/N SUB *****
30110 INVERSE : PRINT MSG$ + "?
      (Y/N) ": NORMAL
30130 LET SROW = PEEK (37) + 1
30140 LET SCOL = PEEK (36) + 1
30150 GET REPLY$: PRINT REPLY$:
30160 IF REPLY$ = "Y" OR REPLY$ =
      "N" THEN PRINT : GOTO 30190
30170 LET MSG$ = "Y/N ONLY": GOSUB
      30000: GOTO 30150
30190 RETURN
30195 REM ***** END PRINT MSG &
      GET Y/N SUB *****
30198 REM
```

C/WP BITES £200 OFF APPLE II E

Meet the Apple II E, the brand new much improved version of the tried and trusty Apple II. The "E" has (almost) everything you ever wished the Apple had. The memory has been increased to 64k with an optional expansion to 128k. The keyboard has sprouted extra keys, making 63 in all, with proper shift keys and four arrow keys to drive the cursor round the screen. The screen boasts capitals and lower case letters (40 to a line—or 80 with a low cost optional add-on). And for brilliant colour the "E" has a built-in PAL encoder—just add a modulator and it plugs straight into your colour television set.

The 80 column card is only £70 (no, it won't work with the Apple II Europlus). For £150, you can buy another card which provides both 80 columns and an extra 64k of memory which switches in and out as required.

Apple II has joined the big league.

But there's one thing Apple Computer has not changed. The "E" still runs all (or almost all) Apple II's enormous library of software without reprogramming or adaptation. Alas, the "E" costs more than its predecessor. But C/WP has had its way and is cutting £200 off the recommended retail price. The "E" is yours for a modest £645 plus VAT.

Or if you prefer it, we can still sell you an old-fashioned Apple II Europlus at the old-fashioned price—£499 plus VAT.



Prices do not include VAT.		RRP	C/WP Price
Apple II E		£845	£645
80 column card		£80	£70
80 column card + 64k		£180	£150
Monitor and stand		£170	£130
Disc drive with controller		£345	£270
Disc drive without controller		£245	£220
C/WP Contour	3 Mb	—	£995
	6 Mb	—	£1195
	12 Mb	—	£1495
	21 Mb	—	£1995
Multiplan		£185	£175

C/WP

**OUR PRICES STILL
TURN OTHERS GREEN**

108 Rochester Row,
London SW1.
Telephone: 01-828 9000

SINCLAIR LINE-UP

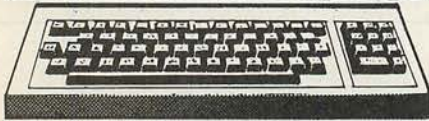

Press any key

THIS SHORT MACHINE-CODE ROUTINE by P Horton of Havant, Hampshire waits until you press a key then returns the code of the key you pressed.

The machine code is stored in a Rem statement 23 characters long and is used by the line:

```
LET A$=CHR$(USR 16514)
```

A\$ will contain the key pressed.

Press any key.

```
.LOOP CALL KSCAN CD BB 02
LD B,H 44
LD C,L 4D
INC L 2C
JRZ .LOOP 28 FB
CALL KFIN CD BD 07
LD C,(HL) 4E
LD B,00 06 00
PUSH BC 05
.WAIT CALL KSCAN CD BB 02
INC L 2C
JRNZ .WAIT 20 FA
POP BC 01
RET 09

10 REM 12345678901234567890123
20 LET A$="CDBB0244D2C28F8CDBB0
74E0600C5CDBB022C20FAC1C9"
30 FOR A=16514 TO 16535
40 POKE A,CODE A$*16+CODE A$(2)-
476
50 LET A$=A$(3 TO )
60 NEXT A
70 STOP
```

Asteroid dodge.

```
70 LET X=0: LET L=0: LET Y=3
80 DEF FN b()=INT (RND*7)
90 LET z=15
100 DEF FN a()=INT (RND*31)+1
105 PRINT AT Y,Z;"U"
110 LET a=FN a()
120 LET b=FN b()
140 LET a$="*#"
210 PRINT AT 21,a;a$
220 PRINT AT 21,b;a$
240 POKE 23692,255: PRINT AT 21
31;" ". PRINT
250 PRINT AT Y-1,Z-1;" "
260 IF SCREEN$(Y,Z)="*" THEN L
ET L=L+1
265 IF L=3 THEN GO SUB 2000
270 LET z=z+(INKEY$="0")-(INKEY
$="1")
275 BEEP .01,30
276 LET X=X+1
277 IF INKEY$=" " THEN LET Y=IN
T (RND*21)
280 GO TO 105
2000 PRINT AT Y,Z-2; FLASH 1;"SP
LAT"
2010 FOR N=1 TO 6: BEEP .05,30:
BEEP .05,20: NEXT N
2020 PRINT AT 0,0;"SCORE ";X
2030 FOR N=1 TO 400: NEXT N
2035 PRINT AT 21,0;"PRESS ANY KE
Y TO RUN AGAIN"
2040 IF INKEY$="" THEN GO TO 204
0
2050 RUN
```

To enter the machine code type in the Basic loader program and run it. Then delete all the lines except line 10. The routine can also be used as a foolproof version of the old "press any key to continue" routine.

Music

THE ZX-81 music program by M Wiseman of Downham Market fits into 4K. The notes are generated by the machine code stored in line 1. The length of a note is stored by Poke 16516,n, where n is the length. The pitch is controlled by Poke 16518,n and the note is generated by USR 16514. Instructions for the program are contained in Print statements from line 1000.

Spectrum games

TWO SHORT GAMES and a machine-code routine for the Spectrum come from C D Henderson of Edinburgh. The first is a simple version of Asteroids; you use Z and X to control your ship as you move down the screen, scoring points. If you reach the bottom you return to the top with a bonus of 25 points.

A simple but fast version of the popular game Brick-Out uses keys 6 and 7 to move you down and up. Both programs contain colour, sound and user-definable graphics so ZX-81 conversion would be difficult.

The machine-code routine is a fast scroll, unlike many others produced elsewhere:

```
10 Clear 32499
20 For a = 32500 to 32561: read b: Poke
a,b
30 Next a
40 Data 33, 1, 64, 17, 0, 64, 1, 128, 21, 237,
176, 201
```

It is called inside a For-Next loop by
RAND USR 32500

Asteroid dodge

A DODGE for the asteroids game comes from Justin Rowling of Sudbury, Suffolk. The scrolling is achieved in three steps:

```
POKE 22692, 255
PRINT AT 21, 31; " "
```

The Poke disables the automatic scroll. The Print At moves the next print position on the screen, and the print moves the display one: 1 moves left and 0 moves right.

Music.

```
1 REM * 2 ""COS 14 RAND +AC
S PI4#PEEK COPY / * (= RETURN / RE
M

2 POKE 16520,120
3 GOSUB 1000
10 DIM Z$(2,512)
20 LET N=1
25 DIM A$(2)
30 CLS
31 PRINT "NOTE=";N
40 GOTO 80
50 PRINT "NOTE?"
55 INPUT A
60 LET N=A
70 GOTO 30
80 PRINT "TIME(0=END)=";CHR$(
28+INT (CODE Z$(1,N)/16));CHR$(
28+CODE Z$(1,N)-INT (CODE Z$(1,N
)/16)*16)
90 INPUT A$
95 IF A$="0 " THEN GOTO 200
100 IF A$=" " THEN GOTO 130
105 LET Q=CODE A$*16-448+CODE A
$(2)-28
106 IF Q<0 OR Q>255 THEN GOTO 5
0
110 LET Z$(1,N)=CHR$(CODE A$(1
)*16-448+CODE A$(2)-28)
120 PRINT A$
130 PRINT "PITCH(0=REST)=";CHR$(
28+INT (CODE Z$(2,N)/16));CHR$(
28+CODE Z$(2,N)-INT (CODE Z$(2
,N)/16)*16)
140 INPUT A$
150 IF A$=" " THEN GOTO 180
155 LET Q=CODE A$*16-448+CODE A
$(2)-28
156 IF Q<0 OR Q>255 THEN GOTO 2
000
160 LET Z$(2,N)=CHR$(CODE A$(1
)*16-448+CODE A$(2)-28)
180 LET N=N+1
190 GOTO 30
2000 FOR A=1 TO 512
210 POKE 16516,CODE Z$(2,A)
211 REM 16,16=P
220 IF Z$(1,A)<>" " AND Z$(2,A)
=" " THEN GOTO 300
230 POKE 16516,CODE Z$(1,A)/1.5
240 IF Z$(1,A)=" " THEN GOTO 300
250 RAND USR 16514
260 NEXT A
270 GOTO 30
300 FOR B=1 TO CODE Z$(1,A)
310 NEXT B
320 GOTO 260
1000 PRINT "INSTRUCTIONS"
1010 PRINT "ENTER THE LENGTH A
ND PITCH AS 2 HEX DIGITS (E.G.
00,1A,FF) TO CHANGE THE NOTE
```

(continued opposite)

(continued from opposite page)

```

NO. TYPE A LENGTH VALUE GREAT
ER THAN FF. TO PLAY THE MUSIC
TYPE 00 FOR THE LENGTH,
TYPE A PITCH TO SAVE THE MUSIC
FF OR LESS VALUE GREATER THAN
0 CHANGE A IF YOU DONT WANT T
N/L. VALUE JUST PRESS N
1020 PRINT " "
1030 PAUSE 32768
1040 RETURN
2000 PRINT "ENTER A NAME"
2010 INPUT B$
2020 IF B$="" THEN GOTO 30
2025 POKE 16390,255
2030 SAVE B$
2040 IF PEEK 16390<>255 THEN PRI
NT "FOUND "B$
2050 PRINT "PRESS N/L"
2055 POKE 16390,0
2060 PAUSE 32768
2070 GOTO 30
    
```

NOTE VALUES (C+ MEANS C SHARP)

C	FF	D+	F1	D	E3	D+	06
CR	CA	F	0F	F+	04	G	0A
G+	A1	A	08	A+	0F	B	07
GC	7F	C+	75	D	72	D+	68
CG+	65	F	50	F+	5A	G	55
CC+	50	A	40	A+	46	B	44
CC	30	C+	30	D	39	D+	36
CC+	33	F	20	F+	20	G	20
G+	28	A	26	A+	24	B	22

Spectrum games.

```

1 FOR a=0 TO 7: READ b: POKE
USR "a"+b: NEXT b
2 DATA 0,BIN 00011000,BIN 001
11100,BIN 01111110,BIN 01111110,
BIN 00111000,BIN 00011000,0
3 FOR a=0 TO 7: POKE USR "b"+
a,BIN 00000111: NEXT a
4 GO TO 1000
5 LET hs=0
10 LET a=2: LET b=1: LET c=1:
LET d=1: LET e=1: LET f=7: LET s
=0: LET p=8: LET q=0
50 BORDER 0: INK 7: PAPER 0
60 PRINT "
65 FOR y=1 TO 15: PRINT TAB 31
" " : NEXT y
67 PRINT "
69 INK 5
70 FOR y=1 TO 15: PRINT AT y,2
0,"#":AT y,21,"#":AT y,22,"#": N
EXT y
72 INK 6
75 FOR y=1 TO 15: PRINT AT y,2
7,"#":AT y,26,"#":AT y,29,"#": N
EXT y
80 PRINT AT 19,3:"score hi-s
core ball"
90 INK 7
95 GO TO 200
100 IF SCREEN$(a,b)="#" THEN L
ET d=-d: BEEP .01,0: LET s=s+10:
PRINT AT 20,5,s:AT 20,24,e:AT 2
0,15,hs
102 PRINT AT a,b,"*": LET k=a:
LET j=b: LET a=a+c
110 IF a>=15 OR a<=1 THEN LET c
=-c
120 LET b=b+d
130 IF b>=30 OR b=1 THEN LET d =
-d
140 IF b=1 THEN GO TO 600
150 PRINT AT k,j:" "
160 IF INKEY$="6" AND p<13 THEN
LET p=p+1: GO TO 200
170 IF INKEY$="7" AND p>1 THEN
LET p=p-1: GO TO 200
180 GO TO 100
200 PRINT AT 0,0:" ":AT 0+1,0:"
":AT 0+2,0:" "
205 PRINT AT 0,0:"I":AT 0+1,0:"
":AT 0+2,0:" "
230 LET 0=p
300 GO TO 100
600 IF p=a OR p+1=a OR p+2=a TH
EN GO TO 150
603 PRINT AT k,j:" "
605 IF s=900 THEN CLS : LET f=f
+1: GO TO 65
607 LET a=INT (RND*3)+2
610 LET e=e+1: IF e>=f THEN GO
TO 900
    
```

```

650 PRINT AT 21,0:"press 'SPACE
for next ball"
660 IF INKEY$<>" " THEN GO TO 6
50
670 PRINT AT 21,0:"
":GO TO 100
900 PRINT "PRESS ENTER YOUR SCORE
":s: PRINT "hi-score"
910 IF s>=hs THEN LET s=hs: PRI
NT hs: FOR x=1 TO 200: NEXT x: C
LS : GO TO 10
1000 BORDER 4: PAPER 3: INK 1: C
LS
1005 LET a$="BREAKOUT @C.D.Hande
rson"
1007 PRINT " "
1010 FOR a=1 TO LEN a$: PRINT a$
(a TO a): PAUSE 5: NEXT a
1020 PRINT " " Move :UP 7
DOWN 6"
1025 PRINT " "
1030 PRINT FLASH 1:"PRESS ANY KE
Y": FLASH 0: PAUSE 0
1040 BORDER 0: PAPER 0: INK 7: C
LS : GO TO 5
1 CLS
10 FOR n=144 TO 145
11 FOR f=0 TO 7
12 READ a: POKE USR CHR$(n)+f
13 NEXT f
14 NEXT n
15 DATA 0,BIN 00011000,BIN 001
11100,BIN 01011010,BIN 00111100,
BIN 00011000,BIN 01100110,0
16 DATA BIN 00001000,BIN 01101
100,BIN 00111110,BIN 01111100,BI
N 00111110,BIN 01110111,BIN 0110
0000,0
17 GO SUB 300: LET x=2
18 BORDER 0: BRIGHT 1: INK 7:
PAPER 0: CLS : BORDER 0: PAPER 0
19 LET a=3: LET q=0: LET b=16:
LET s=0
20 PRINT AT a,b,"*"
21 FOR c=1 TO 7
22 PRINT AT INT (RND*4)+15,INT
(RND*31),"*"
23 NEXT c
24 FLASH 1: PRINT AT 0,0:"ASTE
ROID SHOWER": FLASH 0
25 PAUSE 100
29 POKE 23692,20
30 PRINT AT 21,INT (RND*31),"*"
31 PRINT AT 21,INT (RND*31),"*"
32 LET a$=INKEY$: PRINT AT a,b
":PRINT AT 21,0:" ": IF CODE
SCREEN$(a,b)=0 THEN GO TO 100
33 IF a$="x" THEN LET b=b+x: I
F b>31 THEN LET b=30
34 IF a$="i" THEN LET b=b-x: I
F b<0 THEN LET b=0
35 LET q=q+.25: IF q/2=INT (q/
2) THEN LET a=a+1: IF a=20 THEN
GO SUB 1000
36 PRINT AT a,b,"*":AT a-1,b:"
":AT a-2,b:" "
37 LET s=s+1
38 IF s>100 THEN LET x=1
39 BEEP .01,20+(20-x)
41 IF s/15=INT (s/15) THEN GO
TO 200
42 GO TO 20
100 CLS : PRINT s:" points": ST
OP
200 PRINT AT 21,INT (RND*31),"*"
205 GO TO 20
300 FLASH 1: PRINT AT 10,10:" A
steroid Shower": FLASH 0
310 PRINT AT 20,5:"ANY KEY TO C
ONTINUE"
311 PAUSE 0
312 CLS : BORDER 7: INK 0: PAPE
R 5
315 PRINT " " THE OBJECT OF
THIS GAME IS TO AVOID A NEVER END
ING ASTEROID SHOWER, YOU SCORE
POINTS FOR THIS AND WHEN YOUR SHI
P REACHES THE BOTTOM OF THE SCR
EEN YOU SCORE A BONUS & RETURN TO
"THE TOP"
320 PRINT " " "You move using:"
324 PRINT " "
325 PRINT " " Z-* -X"
340 PRINT AT 20,5:"ANY KEY TO C
ONTINUE"
350 PAUSE 0: CLS : RETURN
1000 LET s=s+25
1010 LET a=3: RETURN
    
```

Which one's for you?

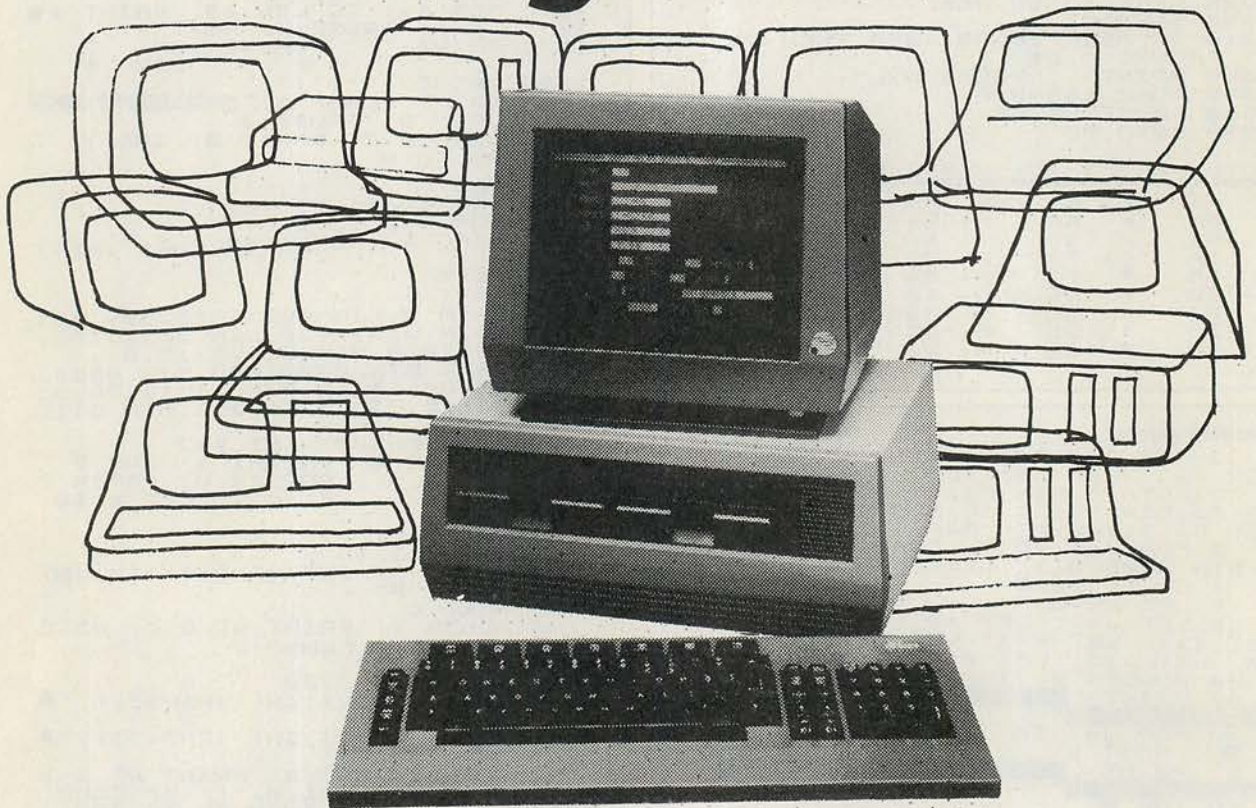

We choose the ACT Sirius 1

... and we make it our business to know just what the best options are in the micro jungle. We specialise in Management Information Systems for large organisations offering a complete and comprehensive service to financial and business managers.

- We will identify the hardware and software options
- We will design and develop systems to meet your needs
- We will train you and your staff
- And we back you up by giving ongoing support

With a customer base that reads like the Times Top 1000, you can be sure that our systems specialists speak your language, no matter what the industry.

Applied Micros

Applied Micros Limited, The Genesis Centre,
Birchwood Science Park, Warrington.
Tel: (0925) 819939

(SIRIUS is the registered trade mark of Applied Computer Techniques (Holdings) p.l.c.)

So if you want to plan a system, install a system, develop an existing system or just want to know more about Management Information Systems – speak to Applied Micros and find out why we choose the ACT SIRIUS I to give you the full service.

Applied Micros also offer the following technologies and products: dBASE II, MicroModeller, SuperCalc, Multiplan, Wordstar... Networking, Communications, Hard Disks... We are also a PULSAR SOFTWARE CENTRE.

Cut out and post this coupon if you want to find out how your organisation can benefit from our experience in Management Information Systems.

Name _____

Position _____

Name of Company _____

Address _____

Tel. No. _____

● Circle No. 261

ACCENT ATARI

by Jack Schofield

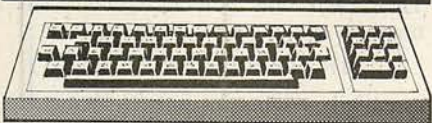

THE FIRST Atari Open File — January issue — did bring a response, albeit a small one. There is room for more so Atari users, send in your programs.

Load and List

The first program to arrive was on cassette in three versions, requiring CLoad, Load "C:" and Enter "C:". The programs were originally saved using CSave, Save "C:" and List "C:" respectively, and they are not interchangeable. It is an interesting piece of versatility, but why have three ways to save and load programs?

CSave is the standard method, and it saves a tokenised version of the Basic program. Tokenisation takes place when you press Return at the end of a line, which is why, if you type in SE. and then list the line, the Basic comes back with the full Setcolour. That is, it just holds a token, and it looks up the meaning of that token; it has no idea what you originally typed.

The big advantage of using tokens is that it is very memory-efficient because each token, with a couple of exceptions, takes up only one byte of RAM. Setcolour takes up only one byte. Long variable names like Netcost take up only one byte per use, after the first use.

There are three types of token, except for a couple of special cases. The three types are keywords, operators and variable names. Keywords can only be the first entry of a statement and Basic then supplies an invisible Let if you do not enter one.

Operators like + and = will be mixed up with variable names in the rest of each statement. The spottable difference between them is that operators have their upper bit off and variable names have it on. This means it is possible to have 128 variable names in a program and the tokens will run from 128 to 255 — one-byte numbers with the upper bit on.

So how does Basic know which variable name that byte stands for? Easy: it looks it up in the variable-name table, which has a starting address found from

```
PEEK(136) + 256 * PEEK(137)
```

Each time you type in a new variable name Basic gives it a number and keeps a record of what it stands for — Netcost or whatever. This obviously has a memory overhead

which has to be taken into account in addition to the one-byte cost per use.

A number of implications follow. First, the variable names are held in the order you typed them in, not the order they occur in the program. Second, if you mistype a name and press Return, the mistyped word is also added to the variable-name table. Third, it is much more memory efficient to use variables than to use binary-coded decimal numbers taking up six bytes each. And fourth, when you have finished the program it does not matter what the variable names are. They need not even be different.

Screen save

Bob McConaghie has also sent a useful Screen Save utility. Like Archimedes' hat, some graphics screens take a considerable time to draw. The utility uses the central I/O described in the operating-system manual. It is run by a small machine-code routine

which is created by reading the Data statement. After running the program, type Print M\$ and look at the result. Our inability to print it out prevents you from entering it directly.

The next part of the program draws something on a Graphics 8 screen with no text window. It means BufLen is equal to 7,680 bytes, the length of the screen memory.

The utility itself starts at line 1000. It only requires you to tell it how much memory to save, BufLen, and that M\$ contains the machine-code routine that calls CIO to perform the Save. To save to cassette instead of to disc just change D:Name to "C:".

What about the load routine? Well, that is exactly the same, except for two Poke values and the fact that you change 8, which means Output, to 4, which means Input as follows:

```
OPEN # 1,4,128,"D:SCREEN.SAV"
```

(continued on next page)

Screen save.

```
10 DIM M$(6):REM Needed for small
20 REM machine code routine
30 FOR L=1 TO 6:READ A
40 M$(L,L)=CHR$(A):NEXT L
50 DATA 104,162,16,76,86,228
99 REM Small routine for demonstration
100 GRAPHICS 24
110 SETCOLOR 2,0,0
120 COLOR 1:REM Draw using colour one
130 FOR L=0 TO 156 STEP 4
140 PLOT L+80,0:DRAWTO 236,L
150 PLOT 80,L:DRAWTO L+80,156
160 NEXT L
170 BUFLen=7680
190 GOSUB 1000
200 END
300 REM ERROR HANDLING
305 REM Should only be necessary when
306 REM restoring saved information
310 POP :REM Remove RETURN entry from stack
320 GRAPHICS 0
330 PRINT "ERROR- ";PEEK(851)
340 END
1000 REM SCREEN SAVE UTILITY
1010 REM Ensure that both M$ and BUFLen
1015 REM are set before coming here
1020 HI=INT(BUFLen/256)
1030 LO=BUFLen-HI*256
1040 OPEN #1,8,128,"D:SCREEN.SAV"
1050 POKE 850,11
1060 POKE 852,PEEK(88)
1070 POKE 853,PEEK(89)
1080 POKE 856,LO
1090 POKE 857,HI
1100 POKE 858,8
1110 REM All set now call CIO
1120 X=USR(ADR(M$))
1130 IF PEEK(851)<>1 THEN 300:REM ERROR
1140 CLOSE #1
1150 RETURN
```

CHANGE THESE LINES FOR
THE LOAD ROUTINE

```
1050 POKE 850,7
1100 POKE 858,4
```

(continued from previous page)

Or, again, use "C:" for cassette instead.

Now, send in your programs so we can all benefit from that nifty routine you have burnt midnight oil on.

List "C:"

The difference between CSave and List "C:" is that a Listed program is still in ASCII character format and not tokenised, as is obvious if you list a program on the screen. Listing it to the cassette works in the same way. The disadvantage is that for various reasons it is slow and takes up much more tape. But you can use it to perfect your program typing, and it also allows you to merge programs together.

Take a program you have CSaved and CLoad it, then use Print Fre(0) to find the amount of RAM you have left. Save the program to another tape using List "C:", then type New to clear RAM. Rewind the tape and type Enter "C:" to reload the Listed version.

Now you should find that the program takes up less RAM, because when the lines were Entered, it was exactly as though the program had been typed in afresh. If you inspect the variable-name table the variable names will be in the order they appear in the program. Now CSave the program for future use. If you are a poor typist you will be surprised how much memory this routine saves.

Note that before Entering a program you type New, whereas you do not have to do so if you type CLoad. CLoading a program automatically clears the previous one, whereas Entering one does not, so you can merge programs or add standard subroutines from tape, as long as both

programs have different line numbers. If two lines have the same number, the last one entered replaces the previous one exactly as it does when you are writing a program.

At this point you may wonder why I have not given you a complicated routine to inspect the variable name table. The reason is that there is a very simple way of doing it. The Atari has a wonderfully simple I/O system where each device is addressed by a single letter:

E — the keyboard/screen editor
 K — the keyboard alone
 S — the screen alone
 P — the printer
 C — the cassette recorder
 D — the disc drive.

If you want to send something to a different device you only have to change one letter. You can use these cassette routines with disc; or Save a program to the keyboard, though this is not a lot of use. However, as well as Listing a program to cassette you can Save one to the screen.

If you simply type Save "S:" a tokenised version of your program will be displayed. Write a three-line program using the variable names Ted, Bert and Ernie and do this. Among the mess of tokens at the top of the screen, the variables will be there in character form. That's the variable-name table.

Using Save "C:" instead of CSave is simply using the general I/O instead of the CSave system. It also saves the program in tokenised form, but I'm not sure what else it implies. There is a bug in Atari Basic: sometimes the cassette buffer is not cleared, preventing CSave from working properly.

The buffer can be cleared by issuing an LPrint statement first because Basic uses IOCB #7 for all CLoad, CSave and LPrint

operations, as explained on page 23 of the manual. If you don't have a printer, don't worry: LPrint will merely produce a harmless error message. Save "C:" seems to avoid this bug in CSave.

Quick tricks

One way to save memory by using tokens instead of floating-point numbers is to write a subroutine on the lines of:

```
N1 = 1:N2 = N1 + N1:N3 = N2 + N1:N4 = N2 + N2:N5 = ...
```

Then each time your program needs a number, use your variable instead:

```
10 FOR X = N2 TO N10 STEP N2
```

essentially adding an integer format that Atari Basic lacks.

A more interesting idea is to change all the variables in a program to the same variable. It was described by Bill Wilkinson in his Insight: Atari column in October 1981's *Compute!* The listing shows a program by John Wiley of Microbits in Albany, Oregon which changes every character in the variable-name table into a Linefeed CHR\$(155), effectively hiding the variable and making the program unreadable. What's more, it effectively deletes itself afterwards.

Lines 32700-30 change the line numbers of the listing so line numbers bigger than 32512, high byte 127, are greater than 32768, high byte 128. Basic does not know about line numbers higher than 32767.

The listing contains only 10 statements. Type it in and List it to tape. Load your program and then Enter the routine. Type Goto 32600 to run it, then save your working but incomprehensible-looking program in the normal way. □

Quick tricks.

```
32600 START=PEEK(130)+256*PEEK(131)
32610 VEND=PEEK(132)+256*PEEK(133)
32620 FOR X=START TO VEND
32630 POKE X,155
32640 NEXT X
32700 X=PEEK(136)+256*PEEK(137)
32710 X=X+1
32720 IF PEEK(X)>126 THEN POKE X,128:END
32730 X=X+PEEK(X+1):GOTO 32720
```

```
32600 START=PEEK(130)+256*PEEK(131)
32610 VEND=PEEK(132)+256*PEEK(133)
32620 FOR X=START TO VEND
32630 POKE X,155
32640 NEXT X
32700 X=PEEK(136)+256*PEEK(137)
32710 X=X+1
32720 IF PEEK(X)>126 THEN POKE X,128:END
32730 X=X+PEEK(X+1):GOTO 32720
```

Effects of Quick tricks listing.

```
5 REM ORIGINAL PROGRAM
10 PRINT CHR$(125):REM CLEAR SCREEN
20 POKE 752,1:POSITION 10,10
30 PRINT "PRACTICAL COMPUTING"
40 A=INT(255*RND(1))+1:B=INT(255*RND(1))+1
50 FOR C=1 TO 5:POKE 710,A:POKE 712,B
60 SOUND 0,A,10,8:SOUND 1,B,10,8:NEXT C
70 GOTO 10

CORRUPTED USING CHR$(65) OR A
INSTEAD OF CHR$(155) OR LINEFEED

5 REM CORRUPTED LISTING
10 PRINT CHR$(125):REM CLEAR SCREEN
20 POKE 752,1:POSITION 10,10
30 PRINT "PRACTICAL COMPUTING"
40 bCORRUPTED LISTING
=INT(255*RND(1))+1:AAAAAAAAAAAAAAAAAAa=INT
(255*RND(1))+1
50 FOR AvvAv=1 TO 5:POKE 710,bCORRUPTED
LISTING
:POKE 712,AAAAAAAAAAAAAAAAAAa
60 SOUND 0,bCORRUPTED LISTING
,10,8:SOUND 1,AAAAAAAAAAAAAAAAAAa,10,8:
NEXT AvvAv
70 GOTO 10
```

God didn't make little Green Apples...

Datalink isn't the largest dealer in the SW of England

In the same way as we all know who's responsible for nature's bounty, there's no secret about the stature of Datalink in the S.W. of England. Especially if you happen to be one of those highly professional, computer orientated blue chip and multi-national companies who are customers of ours.

And when you think that we only took three growing seasons to reach our present position it says a lot for why companies, large and small, come

to us. Things like professionalism, knowledge, service and pricing.

If you're sceptical we'll give you some names where you can check. Names that you *will* have heard of.

Let's hope we can use your company as a reference, too, before long.

And bear fruit with the rest.

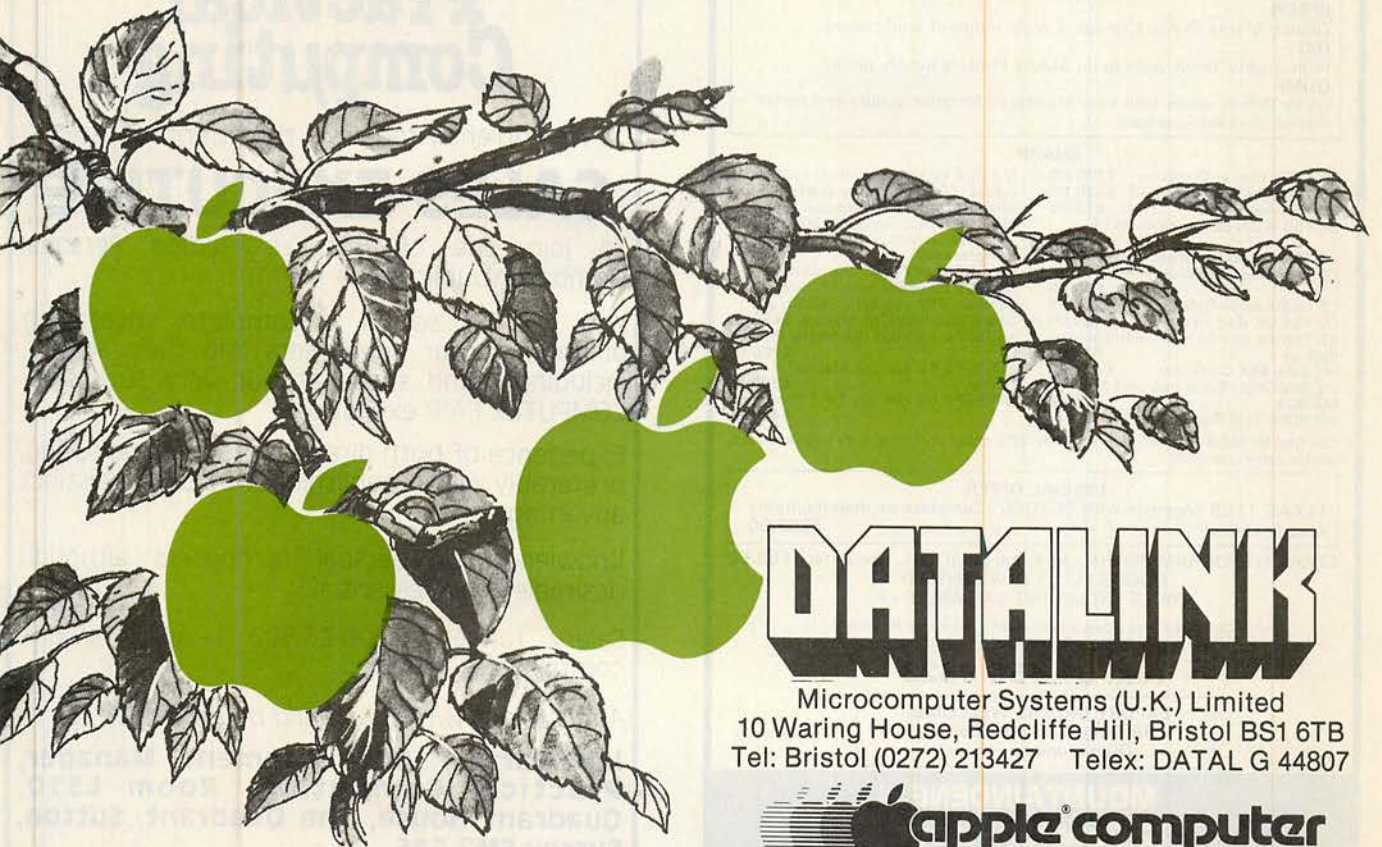

DATA LINK

Microcomputer Systems (U.K.) Limited
10 Waring House, Redcliffe Hill, Bristol BS1 6TB
Tel: Bristol (0272) 213427 Telex: DATAL G 44807

 **apple computer**
Authorised Dealer and Service Centre
24hr answering service

● Circle No. 212

PORTABLE COMPUTERS

EPSON HX/20

(Brief case Computer. Weighs less than 4lb. 16K expandable to 64K. Full size ASCII keyboard. Runs on own power for 50 hours. Complete with serial and RS 232/Interface. £400.00

Add on fac. inc. Barcode. Reader/ Microcassette/Acoustic Couplers for telephone link up etc.

HP75C (The new portable computer 16K expandable to 48K size just larger than a reporters notebook, weighs under 2lb). Will interface with other HP equipment incl. *Items detailed below ideal for Eng./SCI/ travelling business executive. (600 appointments can be stored in MEM built in international clock full size keyboard etc). £700.00

Turn your 41C/CV System into a hand-held Computer with these accessories

• **Portable Digital Cassette Drive** (stores up to 131,072 bytes on a moveable mini date cassette. Files can be given "Meaningful" names. Average file access 13 secs. works on rechargeable batteries and is completely portable) £310.00

• **HPIL Extension Module** (This interface module enables you to communicate with up to 30 peripherals including line printers, measuring instruments, mass storage devices, such as cassette drive above, printer below and even other computers). £76.00

• **Thermal Printer (82162A)** as original printer plus automatic left/right/centre print justification, extra buffer elements (101 Bytes) giving more storage data without slowing system. Greater graphics capability. Control sequences can be executed without being printed, etc., etc., rechargeable batteries completely portable. £273.00

Extended function and memory modules for HP41C/CV now in stock.

HP41C (Newest Sci. from HP)	£114.75
HP41CV (incorporating quadram)	£161.75
HP41C Card reader	£114.75
HP41C Printer (82143A)	£213.95

In stock the new HP10C 11C 15C/16C.

HP ECONOMY PACK

HP41C together with card reader, and printer (82143A). All complete as manufacturers spec. £438.00

HP BUDGET PACK

HP41CV together with card reader and printer (82143A). All complete as manufacturers spec. £485.95

COMPUTER PRINTERS

For up to date prices please telephone.

EPSON

Quality Matrix Printers to suit a wide range of applications.

OKI

High quality small, light quiet Matrix Printers keenly priced.

QUME

Daisy Wheel series sets new standards for print quality and performance at realistic prices.

SHARP

PC 1500 Pocket Computer	£130.00	MZ-80A complete with I/F card, cables, CP/M operating system and Sharp Disc BASIC & Manual	£650.00
CE 148 RS232 and Cent I/F	£130.00	MZ-80B 64K Computer 320x200 High Res. screen Software controlled cassette unit	£43.00
CE 15A Appli Tape	£13.00	MZ-80B Dual Floppy Disc Drives for MZ-80B complete with I/F card, cables, CP/M operating system and Sharp Disc BASIC & Manual	£650.00
CE 150 4 Col printer/cassette I/F	£115	MZ-80P4 150 cps Dot Matrix Printer	£700.00
CE 151 4K Add on mem	£43.00	MZ-80P5 80 cps Dot Matrix T/F Printer	£360.00
CE 152 Cassette Recorder/Player	£34.00	MZ-80P6 80 cps Dot T/F F Printer	£400.00
CE 153 Add on Soft Card	£69		
CE 155 8K Add on mem	£69.00		
CE 158 8K add on mem with battery back up	£75.00		
MZ-80A 48K Computer	£425.00		
MZ-8080AEU Expansion Unit for MZ-80A	£86.00		

The SHARP MZ-80 P4, P5 and P6 PRINTERS come complete with interface card, printer cable and ROM.

SPECIAL OFFER

TEXAS T159 together with PC100C (Complete as manufacturers specifications) £265.00

TEXAS TI PROGRAMMER (Hexadecimal Octal. Dec. Converter) £52.50
GOODS FULLY GUARANTEED.
PRICES EXCLUDING VAT AND P+P.

Company and Government orders accepted by phone.
Barclaycard/Access/Visa accepted by phone

Tel.: 01-455 9823

EXPORT ORDERS WELCOMED
Air Freight/Air Post Delivery
Quotations on request

MOUNTAINDENE
22 Cowper Street
London EC2

● Circle No. 271



FULL DETAILS AVAILABLE FROM

Synergy Computer Systems
E Block University Village

U.E.A.

Norwich

Tel No: 0603-503015

EAST NORFOLK

● Circle No. 272

Practical Computing

We currently require a bright enthusiastic

SALES EXECUTIVE

to join one of Britain's leading Personal Computer publications.

You will be selling a complete advertising package to our advertisers and their agents, including stand space at our very successful COMPUTER FAIR exhibitions.

Experience of both direct and telephone selling, preferably within publishing, would be a distinct advantage.

Knowledge of personal computers although desirable is not essential.

Salary range £6,300-£6,800 (+April review), company car provided.

Applications with CV should be addressed to:

Ian Carter, Advertisement Manager,
Practical Computing, Room L310,
Quadrant House, The Quadrant, Sutton,
Surrey SM2 5AS.

TANDY FORUM

by John Wellsman

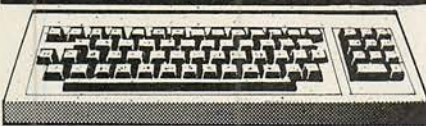

Noise input

HERE IS an item to control the world with your TRS-80, sent by Dr J S Lowe of Keyworth, Nottingham. He describes it as "speech input made easy", but to be accurate, for "speech" use "noise". No special equipment is required; all you need is a tape recorder with its own microphone, a level II keyboard and the standard connecting leads.

First, connect up the cassette recorder as usual, except that the cassette input plug need not be used. If the recorder does not have a built-in microphone plug in an external one.

Then press in the record tab sensor, and press the Record and Play keys as if for recording.

Then, press in the record tab sensor and press the Record and Play keys as if for recording. Video Genie users need an external cassette recorder, using the leads from the second cassette interface. The cassette is now actively picking up sounds from the microphone and feeding signals into the computer to port 255, the cassette Read/ Write port. To detect an input you use the function Inp(255). To see if it is working, try running this program and then tapping or shouting at the microphone:

```
10 CLS
20 IF INP(255) = 255 THEN PRINT @ 488,
"NOISE": FOR N = 1 TO 1000: NEXT
N:GOTO 10 ELSE GOTO 20
```

The word "noise" will appear on the screen

as soon as a noise occurs. Note that while no noise occurs a loop is set up inside line 20, but directly a noise does occur whatever response you have set up occurs. The port must be reset before it can be tripped again. It is achieved by the commands CLS, Clear or Print CHR\$(23).

Dr Lowe states that Inp(255) works fine on his Video Genie in spite of the fact that the second cassette interface is supposed to operate through port 254.

Program protection

This little program will enable you to give your programs a lot of protection. It demonstrates a way of preventing the unauthorised Listing or LListing of your coding. Line 60 puts on the blinkers and line 120 will take them off again.

One snag is that you cannot use an ordinary Input function when you use this lock. Use an Inkey\$ routine instead as in lines 70 to 90. However, if you are using Disc Basic, the snag becomes a little more serious when you Input from a file, because the same problem occurs. The program ends.

The only way to get over it is to invoke the Poke in line 120 immediately before the Input, and then invoke the Pokes in line 60 immediately afterwards. There is one other snag. It can only be effective with people who do not read *Practical Computing*.

Tandy

Tandy model I and III users are most fortunate in their wide choice of disc operating systems. They have in addition to Tandy's own TRS-DOS, NewDos 2.1, NewDos 80 versions 1 and 2, L-Dos and its little brother and others not generally available in the U.K. Apart from NewDos 2.1, which the authors at Apparatus conceded was a rewrite of TRS-DOS with amendments and embellishments, all the others are independent creations, though to a greater or lesser extent they include some of the TRS-DOS's external architecture. Some of the utilities offered by these systems take a lot of learning, and I would not advise anyone to change their DOS merely because a new and more fashionable one has appeared on the scene.

The various system options on NewDos 80 seem to give people trouble. What is often forgotten is that you must reboot immediately after setting the parameters — they will not work until and unless this is done.

New data for old

Andrew Parsonage of Saltney Ferry, Chester has worked out a way of recording a single item of data in a program and altering it, if necessary, each time the program is used. As it stands, it can only be used with model I, level 2.

The essential factor is that the line containing the data must be the first line in the program, though the line number is immaterial. Another restriction is that the new data must be the same length as the old data. It can be less, and this is taken care of in lines 130 and 140. Then in line 150 the new data is Poked into the address of the old data.

If the data is numerical it can be read in line 170 as Val (ND\$) and the padding zeros will be ignored. If the data is a text string then instead of adding zeros, substitute a CHR\$(128), which is a space. It will not work with Disc Basic as programs do not always start at the same address. However, the starting point can be found at addresses 16548, least-significant byte, and 16549, most significant byte, and the address to be Poked should be six addresses above this. With the use of LineInput, it is possible to poke in more than one item of data.

Andrew Parsonage suggests that this routine could be useful in games, for instance, recording the highest score. But it could also be used for more serious purposes, such as automatically recording the number of times that a program has been used.

Speedier graphics

M K Offen of Newcastle upon Tyne, sent a most interesting account of his experiments with strings in the graphics field. He makes the important point that if you have a complex graphic design to display on the screen, it is far quicker and much more striking to build up the display into one or more very large string variables, and then print them, rather than laboriously define and print a display one character at a time.

```
For instance:-
10 FOR X = 1 TO 64
20 AS = AS + CHR$(191)
30 NEXT:PRINT AS
```

is faster in the actual display than

```
10 FOR X = 1 TO 64
20 PRINT CHR$(191);
30 NEXT
```

These two loops only illustrate building large strings. When only one character is used, Print String\$(64,191) would be the way to perform the operation of the first loop. To show the use of large string variables, which can hold up to 255 characters, Mr Offen gives a program which draws a simple pictograph-type map — see listing 1.

(continued on next page)

Noise input.

```
1 DATA 000000
110 INPUT "NEW DATA";ND$
120 RESTORE:READ ED$
125 'GOTO 200
130 IF LEN(ND$)>LEN(ED$) THEN
PRINT "ERROR. NEW DATA LARGER
THAN EXISTING DATA.":STOP
140 IF LEN(ED$)=LEN(ND$) THEN 150
ELSE ND$="0"+ND$:GOTO 140
150 FOR C= 1 TO LEN(ND$):POKE
C+17134,ASC(MID$(ND$,C,1)):
NEXT C:
160 RESTORE:READ ND$
170 PRINT "NEW DATA READS";ND$
180 STOP
```

(continued from previous page)

There is some delay in building the string A\$, but once it is completed it can repeatedly be printed on the screen with no delay at all. If a display is used in a game, the time spent in building the string can be hidden by printing directions on the screen. By the time they have been read the string will be complete.

From an operating point of view, a rather quicker way is to build up each line or part of

a line into a string by adding the actual characters, then adding the strings up to a maximum of 255 characters. With four such giant characters you can cover the entire screen, except for four characters. Printing these will come a very good second to a machine language display. The disadvantage is that the planning and coding of the program takes a lot of thought and time, but the results are well worth the effort made.

Listing 2 illustrates the speed at which this will work. It takes about half a second to print the whole screen. Remember to avoid what look like more elegant methods of building strings. For instance, in lines 50 and 60 small loops could have been used to construct the large strings. But loops take time and can perceptibly slow the routine down. Try it and see. Always add the strings together with + and do not forget the ; where necessary.

Program protection.

```

10 ' THIS IS A DEMO OF THE LIST
AND LLIST DISABLE ROUTINE
20 ' THE NORMAL "INPUT" FUNCTION
WITH THIS BRINGS THE PROG TO AN
END SO AN INKEY$ FUNCTION MUST
BE USED INSTEAD - SEE LINES 70 -
90
30 CLS:PRINT@192,"TO GO BEYOND
THIS LINE WILL DISABLE THE LIST
& LLIST FUNCTION."
40 PRINT:PRINT"PRESS ANY KEY TO
CONTINUE"
50 J$=INKEY$:IF J$="" THEN 50
60 POKE16863,195:POKE
16864,114:POKE 16865,0
70 PRINT@448,"ENTER YOUR NAME"
80 I$=INKEY$:IF I$="" THEN 80 ELSE
IF I$=CHR$(13) THEN 90 ELSE
A$=A$+I$:PRINTI$;:GOTO 80
90 PRINT@576,"YOUR NAME IS ";A$:
100 PRINT@704,"THIS ENDS THE
PROGRAM. NOW TRY AND LIST IT.":
110 PRINT:PRINT"IF YOU CAN'T, TYPE
";CHR$(34);"RUN 120";CHR$(34);
" AND TRY AGAIN.":END
120 POKE 16863,201
    
```

Speedier graphics — listing 1.

```

1 CLS:CLS CLEAR 100
10 CLEAR 510
15 FOR Y=1 TO 15
20 FOR X=1 TO 15
30 READ N$
40 IF N$="W" THEN A$=A$+CHR$(191):
GOTO 80
50 IF N$="S" THEN A$=A$+" ":GOTO
80
60 IF N$="A" THEN A$=A$+"*":GOTO
80
70 IF N$="T" THEN A$=A$+"T"
80 NEXT
90 A$=A$+CHR$(10)
100 NEXT
110 CLS:PRINTCHR$(23);A$;
120 GOTO 120
1000 DATAW,W,W,W,W,W,W,W,W,W,
W,W,W
1010 DATAW,S,S,S,S,A,T,T,S,S,S,S,
S,S,W
1020 DATAW,S,S,S,S,T,A,A,T,T,S,S,
S,S,W
1030 DATAW,S,S,S,T,T,T,A,T,T,T,S,
S,S,W
1040 DATAW,S,S,S,T,T,T,A,A,T,T,T,
S,S,W
1050 DATAW,S,S,S,T,T,T,T,A,T,T,T,
S,S,W
1060 DATAW,S,S,S,S,T,T,T,A,A,A,T,
T,T,W
1070 DATAW,S,S,S,S,T,T,T,T,T,A,T,
T,T,W
1080 DATAW,S,S,S,S,S,T,T,T,T,A,A,
T,T,W
1090 DATAW,S,S,S,S,S,S,T,T,T,T,A,
T,T,W
1100 DATAW,S,S,S,S,S,S,S,T,T,T,A,
A,T,W
1110 DATAW,S,S,S,S,S,S,S,T,T,T,T,
A,T,W
1120 DATAW,S,S,S,S,S,S,T,T,T,T,A,
T,T,W
1130 DATAW,S,S,S,S,S,S,S,T,T,T,A,
T,T,W
1140 DATAW,W,W,W,W,W,W,W,W,W,W,
W,W,W
    
```

Speedier graphics — listing 2.

```

1 CLEAR 1500:CLS
5 A=RND(40):B=RND(40):C=RND(40):
D=RND(40)
20 A$=STRING$(4,166)+
STRING$(4,32):A$=A$+A$
30 B$=STRING$(4,32)+
STRING$(4,166):B$=B$+B$
50 A$=A$+A$+A$+A$:B$=B$+B$+B$+B$
60 PRINTA$;B$;A$;B$;A$;B$;A$;B$;
1000 C$=CHR$(160)+CHR$(190)+
CHR$(180)+STRING$(4,32):
C$=C$+C$+C$
1010 PRINTSTRING$(A,32);C$:PRINT
STRING$(B,32);C$:PRINTSTRING$(
C,32);C$:PRINTSTRING$(D,32);
C$
    
```

product news

Software	RRP	Our Normal Price (Each)	Special Discount Price
DBase II relational database management package	£435.00	£415.00	£395.00
Flexible disks	RRP	Our Normal Price (Each)	Special Discount Price
8" SS/SD	22.50	21.50	18.50
SS/DD	31.50	29.90	25.50
DS/DD	39.05	37.20	30.70
5 1/4" SS/DD 40 tracks	19.40	18.50	17.20
SS/DD 80 tracks	25.90	24.70	22.40
DS/DD 40 tracks	30.70	25.00	22.50
DS/DD 80 tracks	37.50	32.05	27.50
These discs are certified up to 12 million passes. The discount price includes free library case with the disks.			
Cassettes	RRP	Our Normal Price (Each)	Special Discount Price
C12	0.50	0.45	0.40
C15	0.55	0.50	0.45
These cassettes are inclusive of Library Case. For purchases of 10 or more cassettes please reduce the price by 10% and round it to the nearest penny e.g. C15 would cost 40p for 10 or more. Axon			
Ribbons	RRP	Our Normal Price (Each)	Special Discount Price
Epson MX80	6.50	5.50	4.50
*Microline 80	2.90	2.75	2.05
*Commodore 3022	2.50	2.25	1.85
Commodore 4024 tally 1000	4.50	3.27	2.95
*Olympia ES100	2.05	1.85	1.67
Epson MX100	9.20	8.50	7.85
Annadex 9500	9.75	9.35	8.45
Bracho			
Qume M/S Mark II	3.08	2.75	2.24
Qume M/S Mark III	3.95	3.78	3.40
Qume M/S Mark IV	7.50	5.75	5.25
Fabric Mark II	3.08	2.75	2.24
Diabolo Hytype II M-S	4.26	3.85	3.40
II cloth	4.30	3.95	3.45
NEC Multistrike	8.70	6.03	4.50
Fabric	7.00	6.30	4.67
The above are original branded ribbons except those marked *.			
Qume and Diabolo branded wheels	6.50	5.50	4.75
Storage Boxes	RRP	Our Normal Price (Each)	Special Discount Price
Hard Library Cases			
8"	2.80	2.25	1.75
5 1/4"	2.05	1.75	1.40
Colours available Blue, Beige, Black, Grey.			
Lockable Storage Boxes			
8" Holds 40	22.50	20.00	16.50
8" Holds 90	26.00	30.00	24.20
5 1/4" Holds 40	17.50	14.50	11.50
5 1/4" Holds 90	22.50	20.00	16.50
Multiple Storage Units			
8"	4.50	4.05	3.40
5 1/4"	4.05	3.75	3.20
The above Multiple Storage Units interlock horizontally and stack vertically, ideal for disk library.			
Listing Paper	RRP	Our Normal Price (Each)	Special Discount Price
11 x 9 1/2 x 1 part (boxed 2200)	(Per Box) 12.50	(Per Box) 10.50	9.50
11 x 14 1/2 x 1 part (boxed 2200)	14.50	13.50	11.75
11 x 155-16 1 part (boxed 2200)	14.85	14.25	12.75
Binders to house above size paper	RRP	Our Normal Price (Each)	Special Discount Price
11 x 9 1/2 pressboard	2.50	2.05	1.85
Plastic	2.75	2.25	2.00
11 x 14 1/2 pressboard	2.65	2.20	1.95
Plastic	2.95	2.55	2.15
11 x 155-16 pressboard	2.95	2.25	1.95
Plastic	3.15	2.65	2.20
Drive Head Cleaning Kits	RRP	Our Normal Price (Each)	Special Discount Price
8"	17.50	15.50	12.50
5 1/4"	17.50	15.50	12.50
IBM Self Loading Machines for System 34/38	RRP	Our Normal Price (Each)	Special Discount Price
12.85	11.50	9.50	
Self Adhesive Labels	RRP	Our Normal Price (Each)	Special Discount Price
3 1/2 x 17/16 1 across (boxed 8000)	(Per box) 38.50	34.80	30.25
3 1/2 x 17/16 2 across (boxed 8000)	41.60	39.20	33.20
3 1/2 x 17/16 3 across (boxed 8000)	32.50	28.08	20.04
Other sizes available. Please telephone our Sales department			

DEALERS Please ring in for bulk discount Prices subject to fluctuation.

ORDERING GOODS

Please note the above prices are excluding VAT and delivery and insurance. The post and postage are as follows. £3.50 for all goods per box. Please send us a cheque or postal order for the goods inclusive of VAT and delivery. Please allow 14 days for the delivery.

GIVE US A CALL ON 01-226 8809

Or write FREEPOST to: Business Reply Service NW3243

druvic international supplies co., ltd



31 CORSICA STREET, LONDON N5 1BR TEL. NO. 01-226 8809.

● Circle No. 194



COMMODORE 700 SERIES



ALSO:



SEE THE NEW **SYSTIME**

Systime S500

MULTI-USER, MULTI-TASKING 16BIT MICRO. VERY FAST & POWERFUL.



We have a constant changing range of 2nd Hand and Ex-Demo Equipment

Call us on 01-952 0526 For Latest Stock.



CBM VIC-20



MATRIX PRINTERS

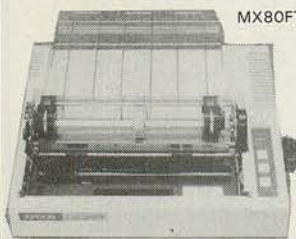

MX80FT-3

OPTIONAL 16K BUFFER

DAISY WHEEL PRINTERS



BROTHER HR-1 Daisywheel Printer 16-20 CPS + 2K BUFFER



FLOWRITER RP 1600 60 CPS + 2K or 8K BUFFER

SOFTWARE

Word-processing
Payroll
Incomplete Records
Book-keeping
Invoicing
Stock Control

Sales Ledger
Purchase Ledger
Record Keeping
Financial Packages
Time Recording
Silicon Office
Data Base

PROFESSIONAL ADVICE GIVEN

ACCESSORIES

Floppy Discs
Printer Ribbons
Stationery
Labels
Installation & Training
Maintenance

BOOKS

Full Range of Computer Books on show

DEMONSTRATION AT YOUR PLACE

PLEASE CALL FOR AN APPOINTMENT ANY TIME



DAVINCI COMPUTER SHOP

65 High Street, Edgware, Middx. HA8 7DD.

Open Mon-Fri 9.00-5.30
Sat 9.30-5.00

Telephone: 01-952 0526



● Circle No. 195

ASK ABOUT THE SPECIAL FREE SOFTWARE OFFER.

FULL DETAILS AVAILABLE FROM

Datamart Ltd
587 Lanark Road
Edinburgh
Tel No: 031-441 6961

MIDLOTHIAN

● Circle No. 196

eyeball to eyeball the way to see high technology in Rhymney Valley

The Financial incentives of the Rhymney Valley are plain to see. So are the companies of the region, who have found a wealth of Electronic and Engineering skills.

The Rhymney Valley has over 1,000,000 sq. ft. of factory space, served by the U.K. Motorway Network, close to Rail, Air and Sea Terminals, and can offer your business:

- REGIONAL DEVELOPMENT GRANT.**
15% or 22% Grants on Building and Machinery.
- SELECTIVE ASSISTANCE FOR NEW PROJECTS.**
- SPECIAL ASSISTANCE FOR OFFICE & SERVICE INDUSTRIES -**
up to £8,000 per job created.
- REMOVAL EXPENSES FOR EMPLOYEES.**
- HOUSING FOR KEY WORKERS.**
- TRAINING COSTS -** up to 80% of costs. Including instructors wages.
- LOW INTEREST LOANS FROM THE E.E.C.**

For further information, please contact **Alan Bruce, Industrial Development Officer**, Rhymney Valley District Council, Council Offices, Park Road, Hengoed, Mid Glamorgan, CF8 7YB Tel: **Hengoed (0443) 812241.**

Rhymney Valley

● Circle No. 197

BBC BYTES

by John Harris



Caterpillar

THE GAMES sent to BBC Bytes are certainly varied: Shingo Sugiura of Putney sent in one that beeps and trills in a satisfactory fashion, speeds up in the currently accepted games mode as progress is made and severely penalises inattention.

The ecological description posits a hungry caterpillar needing guidance toward fresh food buds. Contact with big black blocks of insecticide, of which the world boundary is also composed, proves instantly lethal. On adequately depleting its environment of sustenance the caterpillar passes to another plane of existence, or screen, where surrounded by replenished stocks it tucks in.

Screen dump

If all readers of this column were kitted out with identical hardware I could be sure that the programs would work for everyone. Last month there was a text-dump routine which works fine on 80-column printers, but only because the Carriage-Return commands, VDU 1,13, had been de-selected.

Some users will only get satisfactory results by selecting the two occurrences, VDU 2,1, 13,3, while others will need to include Linefeeds as well, VDU 2,1, 13,1,10,3. I have not heard of anyone needing any other permutation. This is general to all the programs with print op-

(continued on next page)

Caterpillar.

```

10REM ***CATERPILLAR***
20REM (C) SHINGO SUGIURA
30MODE7:DIMX%(17):DIMY%(17)
40HI%=30:SCORE%=0:SCREEN%=1
50PROCINSTRUCTIONS
60MODE1:COLOUR 130:VDU23;10,32;0;0;
0;
70PROCINIT:CLS
80PROCWALL
90PROCOBSTACLES
100PROCFOOD
110IF INKEY(-98)=-1 THEN A$="LEFT"
120IF INKEY(-67)=-1 THEN A$="RIGHT"
130IF INKEY(-73)=-1 THEN A$="UP"
140IF INKEY(-105)=-1 THEN A$="DOWN"
150PRINTTAB(X%(LGTH%),Y%(LGTH%));" "
160IF A$="LEFT" THEN X%(1)=X%(1)-1
170IF A$="RIGHT" THEN X%(1)=X%(1)+1
180IF A$="UP" THEN Y%(1)=Y%(1)-1
190IF A$="DOWN" THEN Y%(1)=Y%(1)+1
200PROCCALCULATE
210VDU26
220COL%=POINT(X%(1)*32+16,(31-Y%(1))
*32+26)
230IF COL%<>2 THEN PROCHECK
240PROCANIMATE
250COLOUR0:PRINTTAB(9,30);SCORE%
260GOTO110
270DEFPROCINSTRUCTIONS
280PRINTTAB(13,1);CHR#141"CATERPILLA
R"
290PRINTTAB(13,2);CHR#141"CATERPILLA
R"
300PRINTTAB(10,3);"BY SHINGO SUGIUR
A"
310PRINTTAB(1,7);"YOU MUST GUIDE THE
HUNGRY CATERPILLAR"
320PRINTTAB(1,8);"TOWARDS THE FRESH
BUDS WHILE AVOIDING"
330PRINTTAB(1,9);"THE INSECTICIDE BL
OCKS."
340PRINTTAB(1,10);"IF YOU TRY TO GUI
DE HIM BACKWARDS HE"
350PRINTTAB(1,11);"WILL TWIST HIS LE
GS AND DIE."
360PRINTTAB(14,13);"CONTROLS:-"
370PRINTTAB(12,15);"UP-----' ' "
380PRINTTAB(12,16);"DOWN-----' / "
390PRINTTAB(12,17);"LEFT-----' Z "
400PRINTTAB(12,18);"RIGHT-----' X "
410PRINTTAB(7,20);"PRESS ANY KEY TO
START":A$=GET$
420ENDPROC
430DEFPROCINIT
440ENVELOPE1,1,3,2,-2,6,6,6,100,0,0,
-5,100,0
450VDU23,224,255,255,255,255,255,255
,255,255
460VDU23,225,24,60,126,231,231,126,6
0,24
470VDU19,1,2;0;19,3,6;0;
480A$="RIGHT":LGTH%=3
490FOR INIT=1TO17:Y%(INIT)=15:NEXTIN
IT
500FOR INIT=1TO17:X%(INIT)=INIT+1:NE
XTINIT
510ENDPROC
520DEFPROCCALCULATE
530FOR CAL%=17 TO 2 STEP -1
540X%(CAL%)=X%(CAL%-1)
550Y%(CAL%)=Y%(CAL%-1)
560NEXTCAL%:ENDPROC
570DEFPROCANIMATE:COLOUR1
580FORANI%=1TOLGTH%
590PRINTTAB(X%(ANI%),Y%(ANI%));CHR#2
25
600NEXT ANI%:ENDPROC
610DEFPROCHECK
620IFCOL%=0 OR COL%=1 THEN PROCDEAD
630IF COL%=3 THEN SCORE%=SCORE%+2:SO
UND1,1,100,2

```

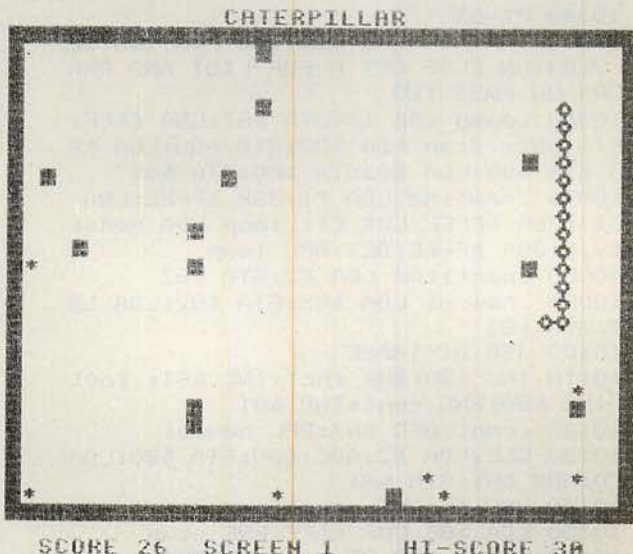

(listing continued on next page)

(continued from previous page)

tions in this column, and I shall try to point out the problem areas as and when they arise.

This month I have a complementary screen dump routine from Simon Letts of Warrington. Rather than incorporate these routines in programs, it can be easier to precede them with a print select, VDU 2, ProcRoutine and End, making them into stand-alone programs. Then Chain at the appropriate point in the main program, when the screen contents are to be

reproduced on the printer. There are situations when having the routines immediately available is a necessity.

The routine will dump, in high resolution, the contents of the screen on to an Epson MX-100F/TIII printer. If you have a non-Epson printer you will doubtless relish the challenge of amending the control codes to achieve the desired results on your own gear. Epson MX-80III users will find the CR generated by .newline in line 10070 will need removing. Mk II owners should find the control codes used are

identical and that the routine works with the same amendment.

Since the printer cannot handle colour the routine must make some compromise, and the convention adopted is that all odd-numbered logical colours are printed as white and evens as black. This can be reversed as shown in line 10250 if you so desire.

The procedure must be assembled by using ProcAssem, after which ProcMC-Dump can be used at any time to dump the current screen contents.

(listing continued from previous page)

```

640LGTH%=LGTH%+1
650IFSCREEN%*28=SCORE% THEN PROCUPDA
TE
660ENDPROC
670DEFPROCWALL:COLOUR0
680PRINTTAB(14,1);"CATERPILLAR"
690PRINTTAB(3,31);"SCORE ";SCORE%
700PRINTTAB(13,30);"SCREEN ";SCREEN%
710PRINTTAB(25,30);"HI-SCORE ";HI%
720FOR WALL=1 TO 38
730PRINTTAB(WALL,1)CHR$224
740PRINTTAB(WALL,28)CHR$224
750NEXT WALL
760FOR WALL=1 TO 28
770PRINTTAB(1,WALL)CHR$224
780PRINTTAB(38,WALL)CHR$224
790NEXT WALL
800ENDPROC
810DEFPROCBOBSTACLES
820FOR OBS=1 TO SCREEN%*4+10
830PRINTTAB(RND(34)+1,RND(27)+1)CHR$
224
840SOUND0,-15,6,1
850FOR DELAY=1 TO 100:NEXT DELAY
860NEXT OBS:ENDPROC
870DEFPROCFOOD:COLOUR 3
880FOR FOOD=1 TO 20
890FOR DELAY=1 TO 80:NEXT DELAY
900SOUND1,-10,RND(200),1
910PRINTTAB(RND(34)+1,RND(26)+1)"*"
920NEXT FOOD:ENDPROC
930DEFPROCUPDATE:SCREEN%=SCREEN%+1
940GOTO70:ENDPROC
950DEFPROCDEAD:IF SCORE%>HI% THEN HI
%=SCORE%
960PRINT""DEAD":*FX15,0
970RESTORE1040
980FOR MUSIC=1 TO 11
990READ A,B,C
1000SOUND3,-10,A,B:FOR REST=1 TO C:NE
XT REST
1010NEXT MUSIC:SCREEN%=1:SCORE%=0
1020PRINT"TRY AGAIN?":ANS$=GET$:IF AN
S$="Y" THEN 70
1030IF ANS$<>"N" THEN 1020
1040DATA61,10,1000,61,8,700,61,4,550,
61,12,950,73,8,600,69,7,650
1050DATA69,9,800,61,5,500,61,10,100,5
7,7,100,61,20,10

```

Screen dump.

```

>LOAD "A.LETTS"
>LIST
10000 DEF PROCASSEM
10010 VDU14:REM PAGE MODE ON
10020 DIM Q% 150
10030 FOR C=0 TO 3 STEP 3:REM TWO PA
SSES
10040 P%=Q%
10050 [OPT 0 \ NO LISTING FOR TESTED
VERSION ELSE OPT C FOR LIST AND ERR
ORS ON PASS TWO
10060 .dump LDA £3:STA &83:LDA £&FF:
STA &82:.scan LDA &82:STA &88:LDA &8
3:STA &89:LDA £0:STA &80:STA &81
10070 .newline LDA £1:JSR &FFEE:LDA
£13:JSR &FFEE:LDX £7:.loop LDA densi
ty,X:JSR &FFEE:DEX:BPL loop
10080 .partline LDA £2:STA &87
10090 .newcol LDA &88:STA &82:LDA &8
9:STA &83
10100 JSR BITIMAGE
10110 INC &80:BNE incl:INC &81:.incl
INC &80:BNE cont:INC &81
10120 .cont DEC &87:BPL newcol
10130 CLC:LDA £2:ADC &80:STA &80:LDA
£0:ADC &81:STA &81
10140 CMP £5:BNE partline
10150 LDA &83:CMP £&FF:BNE scan
10160 RTS \ END OF MAIN PROGRAM
10170 .BITIMAGE LDA £0:STA &86
10180 LDA £7:STA &85
10190 .loop LDX £&80:LDY £0
10200 LDA £9:JSR &FFF1
10210 LSR &84:ROL &86
10220 LDA &82:BNE DEC1:DEC &83:.DEC
1 DEC &82
10230 LDA &82:BNE DEC2:DEC &83:.DEC2
DEC &82
10240 DEC &85:BPL loop
10250 LDA £1:JSR &FFEE:LDA &86:\ EOR
£&FF \REMOVE FIRST \ TO PRINT WHITE
ON BLACK (AS SCREEN)
10260 JMP &FFEE
10270 .density:JNEXT
10280 REM DATA FOR BIT IMAGE DENSITY
10290 !P%=&01E00101:!(P%+4)=&011B014
B
10300 ENDPROC
10310 DEFPROCDCDUMP
10320 *FX5,1
10330 REM CLEAR PRINTER-SET LINE SPA
CING(23/216")
10340 VDU1,13,1,27,1,51,1,23
10350 MOVE0,0
10360 CALL dump
10370 VDU1,27,1,50:REM RESTORE LINE
SPACING
10380 ENDPROC

```

Wego Computers Ltd



The Sequential Switching Unit for powering up and down various devices in the correct sequence. **£75 + VAT**



BackPack – A standby power supply that fits internally within the PET and Disk Drive. It gives at least 15 minutes to close the system down in an orderly fashion. **£140 + VAT**



The Card Reader is now available with an optical read head, which can also read punch cards. **from £650 + VAT**



The TNW 1000 – an output only addressable serial interface IEEE to RS232C. **£110 + VAT**



Wego Computers Ltd
22a High Street, Caterham, Surrey CR3 5UA
Tel: Caterham 49235 Telex 933660 WEGO-G

● Circle No. 198

SOLIDUS SYSTEMS

STOCK CONTROL WITH STOCKFILE

- * 9486 on-line items, TWO SECOND access.
- * Part numbers up to 20 characters long, alpha or numeric.
- * Complete report generation facility plus 5 pre-defined master reports.
- * Any report can be printed in any sequence.
- * Provides the data-base for STOCKSELLER and STOCKMAKER.

TOTAL SALES CONTROL WITH STOCKSELLER

- * Up to 1750 customers, unlimited number of invoices.
- * Produces customised invoices, quotes, packing slips, credit notes, statements and backorders.
- * Complete sales and profit analyses, summaries, month & year-to-date statistics, customer aged trial balance.
- * Individual discounts for each line item on an invoice.
- * Up to 9 V.A.T. rates and full V.A.T. reporting.

MANUFACTURING CONTROL WITH STOCKMAKER

- * Processes 980 assemblies with up to 90 components per assembly and six levels of sub-assembly.
- * Determines availability of stock for production.
- * Calculates cost prices of finished goods.
- * Updates stock levels of raw materials & finished goods.
- * Reserves stock for future production.

designed for the Apple II Plus* microcomputer



SOLIDUS INTERNATIONAL CORPORATION (UK) LTD Tel: (01) 688 5164
Mill House, Wandle Road, Beddington, Croydon, CR0 4SD.

● Circle No. 199

**THE MODERN WAY
TO CONDUCT
YOUR BUSINESS**

Software that isn't hard...

Accounting Plus is a comprehensive software package, comprising eight individual programs, purpose built for the modern responsive business.

Each program can be bought individually and then used as a 'building block' in a fully integrated system.

Programs cover most aspects of modern business — Sales Ledger, Sales Order Processing, Bought Ledger, Purchase Order Processing, Nominal Ledger, Stock Control, Point of Sale and Payroll.

Look carefully at the integration diagram below and consider how many of our competitors offer you this sort of coverage and this sort of flexibility. This sort of integration.

And it isn't hard.

A single key entry updates information in all other related programs. Automatically. Without fuss.

Consider again how much valuable time and effort this will save.

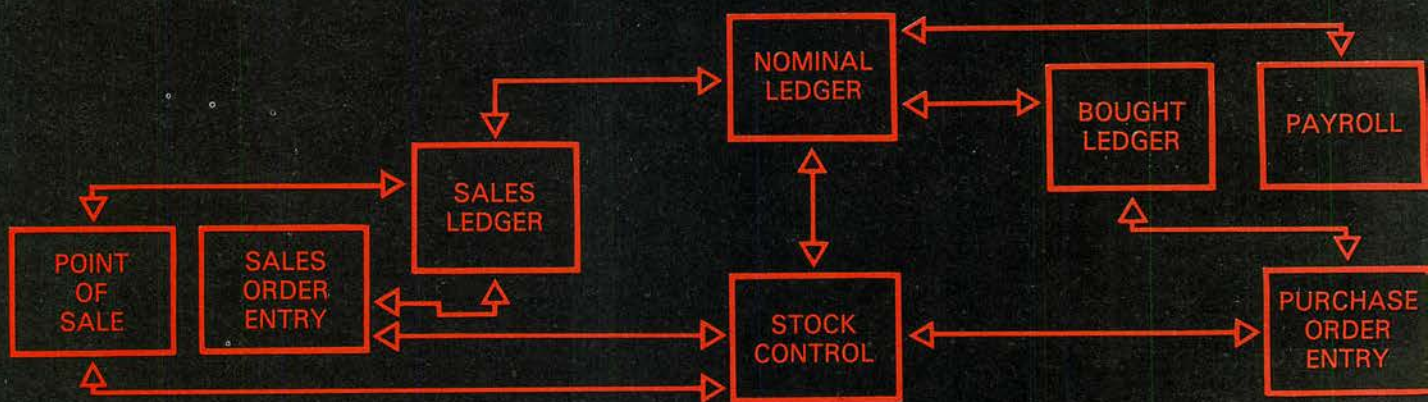

Our competitors make extravagant claims about integration. None is as complete as **Accounting Plus**. Perhaps the hard-nosed industry reviewers are our best recommendation:

Dr. Kathy Lang writing of **Accounting Plus** in *Micro Computer Week* said, "The system certainly seems to live up to its claim of integration: basic transactions were followed through all the way to Profit and Loss and to the balance sheet ..."

In *Practical Computing*, Simon Rushbrook Williams thought, "... the software is remarkable in its completeness, its thorough error messages and its uncrashability."

Neville Ash reviewing **Accounting Plus** in *Micro Decision* commented, "Accounting Plus does not let you make mistakes."

High praise indeed! **Accounting Plus** really is a complete, 'user friendly' system. Easily understood prompts, error and help messages appear on screen leading you through the program.

Training is available and, naturally, the Mediatech name for reliability means that you can be sure that help and technical back-up are just a phone call away.

...so you see, Software doesn't have to be hard to be good

MEDIATECH SOFTWARE

Woodside Place, Alperton, Wembley, Middlesex HA0 1XA England
Tel. 01 903 4372 Telex 8814541

Please send me an explanatory brochure on Accounting Plus.

NAME _____

POSITION _____

COMPANY _____

ADDRESS _____

TELEPHONE _____

I may qualify for a dealership.

Please send a dealer application pack.

PC3/83

COMMODORE CORNER

by Mike Todd

Simple Sorting

IN PRACTICAL COMPUTING'S Pet Corner, May 2981, we published a string sort routine by Simon Letts of Warrington. Now he has written two more sort routines, which will sort integer or floating-point arrays.

For each there is a Basic loader program and a disassembly. I have written simple checksum into the Basic loader, which adds up all the numbers in the Data statements and checks the total against the final Data value. If there is a discrepancy, then there is a number wrong somewhere. If the program works without any error message, then you can be sure that you have typed it in correctly.

The machine-code routines are fully

relocatable, since they contain no absolute address references to themselves, and will work on Basic 2, 3 or 4 Pets. Like the original string sorts they are limited to 255 items. To use the routine, set element 0 in the array to the start address of the routine, A(0)=826 if used as shown, and then execute.

POKE 180,C:SYS A(0)

where C is 1 less than the number of items to be sorted. For integer sort use A%(0).

Putting the Sys address in the first element of the array guarantees that the pointers to the array are already set up when the routines are entered, and saves having to search for them. If you need to use this first

(continued on next page)

Floating sort loader.

```
1 REM *****
2 REM *
3 REM * FLOATING SORT - LOADER *
4 REM *
5 REM *****
```

```
10 FOR I = 826 TO 964
11 READ A : POKE I, A
12 Q=Q+A
14 NEXT I
15 READ A: IF Q<>A THEN PRINT"CHECKSUM ERROR"
```

```
1000 DATA 216, 24, 165, 68, 105, 5, 133, 181, 165, 69, 105, 0, 133, 182
1010 DATA 166, 180, 165, 181, 133, 183, 133, 185, 165, 182, 133, 184, 133, 186
1020 DATA 24, 165, 185, 105, 5, 133, 185, 165, 186, 105, 0, 133, 186, 160
1030 DATA 1, 177, 185, 81, 183, 16, 6, 177, 183, 48, 48, 16, 38, 177
1040 DATA 183, 16, 17, 160, 0, 177, 185, 209, 183, 144, 34, 208, 24, 200
1050 DATA 192, 5, 208, 243, 240, 25, 160, 0, 177, 183, 209, 185, 144, 17
1060 DATA 208, 7, 200, 192, 5, 208, 243, 240, 8, 165, 185, 133, 183, 165
1070 DATA 186, 133, 184, 202, 208, 180, 160, 4, 177, 183, 133, 179, 177, 181
1080 DATA 145, 183, 165, 179, 145, 181, 136, 16, 241, 24, 165, 181, 105, 5
1090 DATA 133, 181, 165, 182, 105, 0, 133, 182, 198, 180, 208, 132, 96
2000 DATA 18856
```

Integer sort loader.

```
1 REM *****
2 REM *
3 REM * INTEGER SORT - LOADER *
4 REM *
5 REM *****
```

```
10 FOR I = 826 TO 941
11 READ A : POKE I, A
12 Q=Q+A
14 NEXT I
15 READ A: IF Q<>A THEN PRINT"CHECKSUM ERROR"
```

```
1000 DATA 216, 24, 165, 68, 105, 2, 133, 181, 165, 69, 105, 0, 133
1010 DATA 182, 166, 180, 165, 181, 133, 183, 133, 185, 165, 182, 133, 184
1020 DATA 133, 186, 24, 165, 185, 105, 2, 133, 185, 165, 186, 105, 0
1030 DATA 133, 186, 160, 0, 177, 185, 81, 183, 16, 6, 177, 183, 48
1040 DATA 25, 16, 15, 177, 183, 209, 185, 144, 17, 208, 7, 200, 192
1050 DATA 2, 208, 243, 240, 8, 165, 185, 133, 183, 165, 186
1060 DATA 133, 184, 202, 208, 203, 160, 1, 177, 183, 133, 179, 177, 181
1070 DATA 145, 183, 165, 179, 145, 181, 136, 16, 241, 24, 165, 181, 105
1080 DATA 2, 133, 181, 165, 182, 105, 0, 133, 182, 198, 180, 208, 155, 96
2000 DATA 15850
```

Simple Sorting. Table 1.

Integer sort		Floating sort				
036D	036F	0372	0374	036D	036D	0373
30	10	B7	B9	30	10	10 Ascending
10	30	B9	B7	10	30	30 Descending

(continued from previous page)

element of the array, set the value of 033F to zero. It can be done by changing one value in line 1000. For the floating sort, change the 5 to a 2, and for the integer sort change the 2 to 0 and then call

POKE 180,C : A(0) = A(0) : SYS 826

Here the A(0)=A(0) is used to set up the array pointers.

It is possible to change the sorts from ascending to descending sorts by changing

The Exclusive-Or and conditional branch at 0367 to 036A determine whether the current items being compared have the same sign and need to be compared for magnitude, or whether the sign will be used to decide which is the smaller number. As the Pet stores the mantissa of floating-point numbers using a sign and magnitude method, the floating sort needs two magnitude sort comparisons. One for negative number at 0375 to 0385, and one for positive numbers at 0386 to 0396. These sort the numbers into opposite order according to their sign, for example 9 is greater than 5 but -9 is less than -5.

Although the sorts are limited to 255 elements, 256 if you use element 0, I am sure that it would be possible to rewrite the routines, to allow larger arrays to be sorted. I suspect that it would result in the program losing its compactness and portability.

Lists 3C/2a,b,c,d.

Key Wait routine

This program for the Vic-20 by Pieter Hintjens of Edinburgh helps overcome problems that can crop up when a program displays a Hit Any Key prompt. Many programmers find this a convenient way of interacting with the user but are inclined to forget that the user can take it literally, being as likely to hit Stop as A,S,D,F, etc.

The Key Wait routine will loop endlessly until the brave user presses a key — any key, including Stop and Shift, except Restore. The routine should be called at the start of the program, or else after any cassette operations as it resides in the cassette buffer starting at 828.

To use the Wait routine, use a line something like:

230 PRINT "PRESS ANY KEY TO CONTINUE": SYS 828

The program only starts again once the key is released to prevent Stop from halting the run.

Floating sort.

```

033A D8          CLD
033B 18          CLC
033C A5 44      LDA $44
033E 69 02      ADC #$02
0340 85 B5      STA $B5
0342 A5 45      LDA $45
0344 69 00      ADC #$00
0346 85 B6      STA $B6
0348 A6 B4      LDX $B4
034A A5 B5      LDA $B5
034C 85 B7      STA $B7
034E 85 B9      STA $B9
0350 A5 B6      LDA $B6
0352 85 B8      STA $B8
0354 85 BA      STA $BA
0356 18          CLC
0357 A5 B9      LDA $B9
0359 69 02      ADC #$02
035B 85 B9      STA $B9
035D A5 BA      LDA $BA
035F 69 00      ADC #$00
0361 85 BA      STA $BA
0363 A0 00      LDY #$00
0365 B1 B9      LDA ($B9),Y
0367 51 B7      EOR ($B7),Y
0369 10 06      BPL $0371
036B B1 B7      LDA ($B7),Y
036D 30 19      BMI $0388
036F 10 0F      BPL $0380
0371 B1 B7      LDA ($B7),Y
0373 D1 B9      CMP ($B9),Y
0375 90 11      BCC $0388
0377 D0 07      BNE $0380
0379 C8          INY
037A C0 02      CPY #$02
037C D0 F3      BNE $0371
037E F0 08      BEQ $0388
0380 A5 B9      LDA $B9
0382 85 B7      STA $B7
0384 A5 BA      LDA $BA
0386 85 B8      STA $B8
0388 CA          DEX
0389 D0 CB      BNE $0356
038B A0 01      LDY #$01
038D B1 B7      LDA ($B7),Y
038F 85 B3      STA $B3
0391 B1 B5      LDA ($B5),Y
0393 91 B7      STA ($B7),Y
0395 A5 B3      LDA $B3
0397 91 B5      STA ($B5),Y
0399 88          DEY
039A 10 F1      BPL $038D
039C 18          CLC
039D A5 B5      LDA $B5
039F 69 02      ADC #$02
03A1 85 B5      STA $B5
03A3 A5 B6      LDA $B6
03A5 69 00      ADC #$00
03A7 85 B6      STA $B6
03A9 C6 B4      DEC $B4
    
```

```

03AB D0 9B      BNE $0348
03AD 60          RTS
03AE 91 B5      STA ($B5),Y
03B0 88          DEY
03B1 10 F1      BPL $03A4
03B3 18          CLC
03B4 A5 B5      LDA $B5
03B6 69 05      ADC #$05
03B8 85 B5      STA $B5
03BA A5 B6      LDA $B6
03BC 69 00      ADC #$00
03BE 85 B6      STA $B6
03C0 C6 B4      DEC $B4
03C2 D0 84      BNE $0348
03C4 60          RTS
    
```

Integer sort.

```

033A D8          CLD
033B 18          CLC
033C A5 44      LDA $44
033E 69 02      ADC #$02
0340 85 B5      STA $B5
0342 A5 45      LDA $45
0344 69 00      ADC #$00
0346 85 B6      STA $B6
0348 A6 B4      LDX $B4
034A A5 B5      LDA $B5
034C 85 B7      STA $B7
034E 85 B9      STA $B9
0350 A5 B6      LDA $B6
0352 85 B8      STA $B8
0354 85 BA      STA $BA
0356 18          CLC
0357 A5 B9      LDA $B9
0359 69 02      ADC #$02
035B 85 B9      STA $B9
035D A5 BA      LDA $BA
035F 69 00      ADC #$00
0361 85 BA      STA $BA
0363 A0 00      LDY #$00
0365 B1 B9      LDA ($B9),Y
0367 51 B7      EOR ($B7),Y
0369 10 06      BPL $0371
036B B1 B7      LDA ($B7),Y
036D 30 19      BMI $0388
036F 10 0F      BPL $0380
0371 B1 B7      LDA ($B7),Y
0373 D1 B9      CMP ($B9),Y
0375 90 11      BCC $0388
0377 D0 07      BNE $0380
0379 C8          INY
037A C0 02      CPY #$02
037C D0 F3      BNE $0371
037E F0 08      BEQ $0388
0380 A5 B9      LDA $B9
0382 85 B7      STA $B7
0384 A5 BA      LDA $BA
0386 85 B8      STA $B8
0388 CA          DEX
0389 D0 CB      BNE $0356
038B A0 01      LDY #$01
038D B1 B7      LDA ($B7),Y
038F 85 B3      STA $B3
0391 B1 B5      LDA ($B5),Y
0393 91 B7      STA ($B7),Y
0395 A5 B3      LDA $B3
0397 91 B5      STA ($B5),Y
0399 88          DEY
039A 10 F1      BPL $038D
039C 18          CLC
039D A5 B5      LDA $B5
039F 69 02      ADC #$02
03A1 85 B5      STA $B5
03A3 A5 B6      LDA $B6
03A5 69 00      ADC #$00
03A7 85 B6      STA $B6
03A9 C6 B4      DEC $B4
03AB D0 9B      BNE $0348
03AD 60          RTS
    
```

Key wait routine in Basic, and corresponding op code mnemonics.

1000 DATA 173, 141, 2, 208, 16, 165, 197, 201, 64, 240, 245, 165, 197, 201
 1010 DATA 64, 208, 250, 169, 0, 133, 198, 96, 234
 1020 FOR I = 0 TO 21: READ A: POKE 828 + I, A. NEXT: RETURN

wait:	lda \$028D	; check for shift, chift or control keys
	bne exit	; if not 0 then one pressed
	lda \$C5	; now look at key pressed
	cmp #\$40	; 64 means no key pressed
	beq wait	; so go round again
loop:	lda \$C5	; if a key was pressed, wait until
	cmp #\$40	; it is released — this prevents STOP from
	bne loop	; stopping the program once back in Basic.
exit:	lda #\$00	; cancel any characters
	sta \$C6	
	rts	; return control to Basic.



You'll be glad you chose a personal computer with power enough to grow with your needs.

The ICL Personal Computer with power to grow as you need it.

Choosing the wrong personal computer can work out very costly, because though they grow to meet your needs, they just don't grow enough.

The new ICL Personal Computer gives you more. It's a versatile, professional personal computer. It can start with a single Visual Display Unit, naturally, and it has a wide range of functions to meet your increasing requirements. And it can grow larger than most other personal computer systems, because its capacity for additional hardware is greater.

Starting at £2,895 with one VDU

The ICL Personal Computer provides a range of options enabling you to have a system tailored to meet your changing needs.

For example, by adding a fixed-disc, you can have eight times the original storage capacity, and support up to 4 VDUs. And there is an extensive range of Personal Computer hardware.

Wide range of integrated accounts and other application software available, providing limitless possibilities.

So your secretary can do her word processing, you can do your forecasts, your accountant can do the invoicing, and your programmer can do his own thing, all at the same time. That's what makes ICL Personal Computer more than just a personal computer.

And because ICL is Europe's leading computer company, with thousands of satisfied users in over 80 countries worldwide, we can offer ICL Trader Point service and maintenance back-up that's second to none.

What more could you ask for, apart from a demonstration?



trader point

To: **Johnson microcomputers** Johnson House · 75-79 Park Street · Camberley · Surrey

Please send me further information on the new ICL Personal Computer.

Name _____ Position _____

Company Name & Address _____

_____ Telephone _____

Type of Business _____



Johnson microcomputers

Johnson House · 75-79 Park Street · Camberley · Surrey
Telephone 0276 20446

Robophone Answering 24 hrs. Prestel page No. *200632
Mailbox No. 027620448

48 Gloucester Road · Bristol · Telephone 0272 422061
113 Stratford Road · Shirley · Birmingham B90 3AY
Telephone (021) 745 3246

● Circle No. 182

END OF FILE

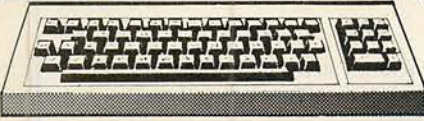

MBASIC ROUTINE

Handling dates

TO STORE a date, three variables are required, one each for the day, month and year, notes Joe Ryan of Killiney, County Dublin, Ireland. For a simple program the storage space so used should be no problem, but in a long program which, for example, includes records containing dates, the amount of storage used to hold the dates could become significant. a routine to sort such records in chronological order would be quite complex. A further problem in working with dates is that the validation of input data is not easy, given that the highest valid day in a month can be 28,29,30 or 31, depending on the month in question.

These two MBasic subroutines simplify all operations associated with inputting, storing, sorting and displaying dates. As an added bonus, the listing includes a function which will return the day-of-week for any date.

The subroutines are at lines 230 and 390 respectively. The first one is called when the input of a date is required: if the date given is outside the range chosen — line 130 — or if it is an invalid date an error message is printed and a new input is sought. This program will work for the years 1901 to 1999, set by Z1 and ZN respectively. The range between Z1 and ZN should not exceed 89 years in order to avoid the possibility of an integer overflow.

Assuming a valid date is given, the date is then converted to a single integer ZX and the subroutine terminates. The returned value, ZX, is used for storing the date, and the dates stored in this form can be sorted in chronological order by an integer sort. All the variables used in these subroutines commence with the letter Z, which makes it relatively easy to include them in any program without corrupting the other variables used.

The second subroutine is called when it is required to convert a date which is stored in the computed integer form to a string, for printing. For this purpose ZX must contain the computed integer when the subroutine is called and, on return, ZX\$ will contain the date in a form suitable for printing. In

Handling dates.

```

100 ' INITIALISATION FOR DATE ROUTINES
110 DEFINT Z:DEF FNDAY$(Z) = ZD$(Z MOD 7)
120 DIM Z(12),Z$(12),ZD$(6):FOR Z = 1 TO 12:READ Z$(Z),Z(Z):NEXT
130 Z1 = 65:ZN = 82 ' Z1 is first year, ZN is last year
140 ' first set up array ZD$( )
150 Z = 0:FOR ZZ = 1 TO Z1-1:IF (ZZ MOD 4 = 0) THEN Z = Z + 366
    ELSE Z = Z + 365
160 NEXT:ZZ = Z MOD 7:IF ZZ = 0 THEN ZZ = 7
170 FOR Z = 7-ZZ TO 6:READ ZD$(Z):NEXT
180 IF (ZZ <> 7) THEN FOR Z = 0 TO 6-ZZ:READ ZD$(Z):NEXT
190 GOTO 1000 ' main program
200 DATA JAN,31,FEB,,MAR,31,APR,30,MAY,31,JUN,30,JUL,31,AUG,31,
    SEP,30,OCT,31,NOV,30,DEC,31
210 DATA MON,TUE,WED,THU,FRI,SAT,SUN
220 '
    INPUT A VALID DATE & COMPUTE DATE-INTEGGER ZX
230 INPUT "Day (1..[28/31]) ? ",ZD
240 INPUT "Month .. (1..12) ? ",ZM
250 INPUT "Year ..... 19",ZY
260 IF (ZM < 1) OR (ZM > 12) THEN 370
270 IF (ZY MOD 4 = 0) THEN Z(2) = 29 ELSE Z(2) = 28
280 IF (ZD < 1) OR (ZD > Z(ZM)) THEN 370
290 IF (ZY < Z1) OR (ZY > ZN) THEN 360
300 ' date is valid, so compute ZX
310 ZX = (ZY - Z1) * 365:IF (ZM < 3) THEN ZZ = ZY - 1
    ELSE ZZ = ZY
320 ZL = 0:FOR Z = Z1 TO ZZ:IF (Z MOD 4 = 0) THEN ZL = ZL + 1
330 NEXT ' ZL gives the number of leap-days encountered
340 Z(2) = 28:FOR Z = 1 TO ZM:ZX = ZX + Z(Z-1):NEXT
350 ZX = ZX + ZD + ZL:RETURN
360 PRINT "Date entered is out of range - try again":GOTO 230
370 PRINT "Date entered is invalid - try again":GOTO 230
380 '
    WITH ZX COMPUTE DATE-STRING ZX$(ALSO ZD,ZM,ZY)
390 ZZ = ZX:ZY = Z1
400 IF (ZY MOD 4 = 0) THEN Z = 366 ELSE Z = 365
410 ZZ = ZZ - Z:IF (ZZ > 0) THEN ZY = ZY + 1:GOTO 400
420 ZZ = ZZ + Z:ZD = 0
430 IF (ZY MOD 4 = 0) THEN Z(2) = 29 ELSE Z(2) = 28
440 FOR Z = 1 TO 12:ZD = ZD + Z(Z):IF (ZD >= ZZ) THEN ZM = Z:
    ZD = ZZ + Z(Z) - ZD:Z = 12
450 NEXT
460 ZX$ = RIGHT$(STR$(ZD),2) + " " + Z$(ZM) + STR$(1900 + ZY)
470 RETURN
    
```

addition, variables ZD,ZM & ZY will contain the day, month and year respectively.

At any time, the day-of-week may be calculated by using the function FNDAY(X), where X is the date in the computed integer form used in this program: on initialisation the array ZD\$() is set up with the days of week, ZD\$(1) being the day on which January 1 in year Z1 falls, and so on. Using the Mod operator, it is then a relatively simple matter to come up with the day-of-week for any day.

MBasic Mod operator gives the remainder after an integer division. The subroutines may be run with other versions of Basic which do not include Mod by using floating-point variables, and by replacing X Mod 7 by

$$(X - (7 * INT(X/7)))$$

and If (X Mod 4 = 0) by
IF (X/4 = INT(X/4))

SHARP MZ-80K

Print At command

THIS SHORT ROUTINE by Piers Hendrie of Cambridge is for MZ-80K users who do not use an extended Basic. It will enhance the Sharp Basic SP-5025 to enable it to have a very useful form of the Print At command. The routine has the format: PRINT (X,Y); "SHARP, First and Foremost". The routine saves typing in all those reverse-field cursor arrows that waste so much time and memory. After you have entered and run the routine, you can save a new copy of Basic with the two USR calls 33 and 36 decimal. Do not save the new Basic over Sharp's Basic in case there is an error.

Print At command.

```

100 DATA 295,139,22,91,69,28,295,169
110 DATA 25,123,254,25,218,152,19,58
120 DATA 114,17,285,154,22,44,285,169
130 DATA 25,123,254,40,218,152,19,58
140 DATA 113,17,285,154,22,93,195,69,28
150 FOR I=15836 TO 15876
160 READ E
170 POKE I,E
180 NEXT I
190 POKE 7221,228
200 POKE 7222,61
210 POKE 4354,5
220 POKE 4355,44
230 POKE 4358,65
240 POKE 4351,13
250 PRINT [12,15];
    "Continue..."
    
```

NOW
BETTER
THAN EVER

Now You Can Back-Up Your Protected Software

COPY II PLUS



The Ultimate Utility for the Apple® II

Versatile

Back-up Visicalc and all your Visis, PFS and PFS Report, . . . and many, many more

Fast

Only 45 seconds for Fast Copy
Less than 3 minutes for Bit Copy

Easy to Use

Menu driven for ease of use. Full instructions on backing up dozens of popular programs.

Comprehensive

Includes all the file handling and DOS utilities you will ever need

- change booting program
- copy or remove DOS
- verify and compare files for differences
- analyse disks with the nibble editor
- check disk drives

Best Value

All this at a price which makes Copy II Plus better value than ever

Send cash with order, or quote your Access or Diners Card to:

**ORCHARD
SOFTWARE**



17 Wigmore Street
London W1
Tel: 01-580 5816



Amazing Value at
£35 + VAT
Why Pay More ?

Dealer Enquiries Welcome

Current Copy II Plus Owners: Send your original disk with £15 + VAT for an update to Version 4

● Circle No. 20



FULL DETAILS AVAILABLE FROM

The Computer Terminal
44 Cathedral Place
London EC4
Tel No: 01-236 2187

GREATER LONDON

● Circle No. 203



**STEMMOS LTD.
ANNOUNCE**

THE WORLD'S LEADING AUTOMATIC PROGRAM GENERATOR AUTOCODE I™

Automatic development of dBase II™
program code without any programming

- ★ Automatic Menus and Sub-Menus
- ★ Automatic Data Entry Screens
- ★ Automatic Data Entry Routines
- ★ Automatic Edit/Validation
- ★ String, Numeric, Date and calculated fields
- ★ Automatic Multiple Reports
- ★ Automatic Programs in dBase code with interactive screens
- ★ No prior knowledge of dBase II is needed.

AUTOCODE I £120
dBASE II & AUTOCODE I . . . £450
STEMMOS LTD. (Excluding VAT)

World leaders in automatic programming

344 Kensington High Street,
London W.14 8NS
Tel. 01 602 6242 Telex 893003 Stemmos G.

(AUTOCODE I™ STEMAMOS LTD.
dBase II™ Ashton-Tate)

● Circle No. 20

PORTABLE MICRO'S

TAKING THE COMPUTER A STEP FURTHER

EPSON HX20

A computer small enough to fit into a briefcase yet with a full size typewriter keyboard, LCD virtual screen, printer and microcassette facility actually built in. High speed serial communication with other computers plus the Epson reliability - a world beater.

A FULL SIZE QWERTY KEYBOARD WITH 68 KEYS INCLUDING 5 FUNCTION AND 13 SPECIAL KEYS. LCD DISPLAY WINDOW SHOWING ANY 20 COLUMN BY 4 LINE PART OF A VIRTUAL SCREEN UP TO 255 CHARACTERS WIDE. 50 HOURS BATTERY LIFE WITH MAINS ADAPTER FOR OVERNIGHT CHARGING. BUILT IN PRINTER 5 x 7 MATRIX, 24 COLUMN WITH BIT ADDRESSABLE GRAPHICS. OPTIONAL BUILT IN MICROCASSETTE OR ROM PACK.

HX20UA PORTABLE MICRO UNIT WITH OPERATING MANUAL £402.00
HX20MC-SA MICROCASSETTE DRIVE £75.00



NEWBRAIN

You thought it would never arrive, but here it is with all those promises fulfilled. We never appreciated the full computing potential of the NEWBRAIN but suffice to say, it's a machine with a great future. We'll be able to tell you how to fully utilize the considerable power of the NEWBRAIN and take advantage of all that CP/M software.

THE NEWBRAIN IS A FULLY SPECIFIED PROFESSIONAL COMPUTER BUILT TO THE HIGHEST STANDARDS OF ENGINEERING AND RELIABILITY, CHOSEN BY LEADING OEM SUPPLIERS DESIGNED TO FACILITATE EASY EXPANSION FOR USE WITH THE CP/M OPERATING SYSTEM AND THE ADDITION OF 5 1/4" FLEXIBLE AND WINCHESTER DISKS; 12" GREEN PHOSPHOR PROFESSIONAL STANDARD MONITOR; 80 CPS PROFESSIONAL QUALITY DOT MATRIX PRINTER WITH PIN ADDRESSABLE GRAPHICS.

NEWBRAIN MODEL A £199.00
NEWBRAIN MODEL AD £229.00



HEWLETT PACKARD

HP75C A TOTALLY NEW PORTABLE PERSONAL COMPUTER. An executive tool for the man in a hurry. 600 appointments can be held in memory. Never miss a board meeting or a birthday. In addition, - an impressive scientific aid to engineers and Scientists with magnetic card strips for handy programs and a magnificent BASIC.

HP75C SPECIFICATION 5" x 10" x 1" WEIGHING 26 oz. 16K RAM EXPANDABLE TO 24K. 48K OPERATING SYSTEM WITH 187 KEYWORDS AND FULL SCIENTIFIC BASIC. 8 BIT CPU, 32 CHARACTER LCD DISPLAY WITH SCROLLING TO 96 CHARACTERS; FULL INSTRUMENT AND PERIPHERAL CONTROL USING THE HPIL INTERFACE LOOP 30HR BATTERY LIFE WITH RECHARGER. 3 PLUG IN 16K ROM MODULES. A FULL REDEFINABLE TOUCH TYPE 'QWERTY' KEYBOARD WITH EDITING KEYS AND HIDDEN NUMERIC PAD. A BUILT IN PROGRAMMABLE ALARM/TONE GENERATOR AND APPOINTMENT CALENDAR. THIS IS ONE OF THE MOST COMPACT AND POWERFUL PORTABLES WITH HP'S SCIENTIFIC AND TECHNICAL BACKGROUND AND SUPPORT DOCUMENTATION. ITS POWER IS YOURS TO APPLY.

HP75C PORTABLE COMPUTER £728.40
HP-82700A 8K MEMORY MODULE £142.75



SHARP PC1500

This machine is the least expensive portable on the market. It is ideal for salesmen, contract engineers and anyone wanting to produce figures or small graphics for clients. Its 4 colour printer is a masterpiece of simplicity and it offers a medium speed BASIC for keeping standard programs in RAM. It is particularly useful for engineers who wish to do 'set calculations' on site and produce results on the spot. Great value for money.

WITH 16K BYTES OF ROM AND UP TO 11.5K BYTES OF RAM MEMORY, WITH BATTERY PROTECTION. UP TO 36 PROGRAMS STORAGE CAPACITY. BASIC PROGRAM LANGUAGE WITH TWO DIMENSIONAL ARRAYS AND VARIABLE STRINGS. QWERTY KEYBOARD WITH UPPER AND LOWER CASE. FULL RANGE OF SCIENCE AND MATHS FUNCTIONS (STATISTICS WITH MICROL SOFTWARE) ALARM CLOCK AND CALENDAR, MULTI TONE GENERATOR, MINI GRAPHIC 7 x 156 DOT MATRIX DISPLAY. ALL UNDER BASIC PROGRAM CONTROL. LINE WIDTH 26 CHARACTERS.

CE-150 FOUR COLOUR GRAPHIC PRINTER/TWO CASSETTE INTERFACE.

PC 1500 COMPUTER £147.78
CE150 PRINTER/TAPE INTERFACE £130.39
CE155 8K RAM MEMORY MODULE £69.52



Visit our Portable Micro Centre or contact us for further information.



Telephone and mail orders accepted on Barclaycard or Access
All prices exclude carriage and VAT

59/61 Theobald's Rd. London WC1X 8SF. Tel: 01-405 5240/2113. Telex: 24224 (Ref. 1422).

For full proposed range of Portable Computers and typewriters, including the Osborne, Kaypro II, Teleram, Panasonic, Toshiba, Andromeda, Brother, Husky, please contact us for price and availability. Not all items are yet in production so it is best to telephone for delivery details.

HONEYFOLD

BOOKLIST

Over 1000 Titles

We have concluded agreements with some major book suppliers around the world that allow us to offer immediately the biggest computer book list in Europe. We have a shortform price list of all our titles that we will send you and we also have a 200-page, cross referenced, catalogue with editorial on hundreds of titles that will give you a bookshop of your own. This catalogue costs £1.00. We know our prices are better than elsewhere and we can still offer a monthly service of new books to those on our mailing list.

In early 1983 we will start a book club and hope to offer you even better purchasing power. Let us hear from you. We are equally willing to talk to computer shops where our range and customer use of our catalogue will allow them to offer a much greater service to their customers.

LIST OF PUBLISHERS

ADDISON WESLEY
BRADY
CAMELOT
COMPUSOFT
CORD
COMPUTER SCIENCE PRESS
DESIGN
DILITHIUM PRESS
HARRIS
HAYDEN
IJG COMPUTER SERVICES
JOHN WYLLIE & SON
LEXINGTON
LITTLE
MCGRAW HILL
MIT PRESS
MATRIX PRESS

OSBOURNE
PETROCELLI
PRENTICE HALL
RESTON
ROBOTICS PRESS
SAMS
SENTURY

SPECTRUM
SYBEX
TAB PUBLICATIONS
VAN NOSTRAND REINHOLD CO



NOW AVAILABLE

DR. WATSON

Computer Learning Series



VIC 20 SPECTRUM DRAGON BBC PET

The Dr. Watson Computer Learning Series

A new series of books on computer languages, carefully graded to suit different abilities and written specifically for the new micros. The whole series is presented in a consistent style and each book comes with a cassette containing all the major programs developed in the book.

Learning BASIC is FUN. Learning assembly language is FUN – ask Dr. Watson! Learn BASIC with your Spectrum, Dragon or BBC by writing your own games, your own music program and – yes – an Adventure game designed by you! Just in case though, if you can't wait to learn, the good Doctor provides a cassette. So you can run and enjoy the games and then settle down to see how they work – and add YOUR improvements.

Learn ASSEMBLY-LANGUAGE with your PET, VIC 20, Spectrum or BBC, using your own assembler – supplied in a cassette with the book and used throughout in all the demonstration routines. Just in case, too, there's a tutor to show you how the noughts and ones of binary and the E's and F's of Hex work. A book to make sure you learn assembly-language EASILY. Cramped full of sample programs and exercises.

BOOK AND SOFTWARE

£14.95
INC VAT & POST

VIC 20

TOTL PROFESSIONAL SOFTWARE

TOTL TEXT

SIMPLY THE BEST: Page numbering • Right and left margins • Skip to top of page • Centered title lines • Character and line spacing • Graphics characters • Full cursor control in editing • Add, change, delete characters • Specify printer device number • Print

mailing labels • Paragraph control • VIC 1515 expanded characters • Single, double, triple spacing • Tab position control • Upper and/or lower case • Full screen editing • Scroll up and down through text • Insert, delete blocks of text • Multiple copies of document

Up to 4 heading lines per page • Footing line at bottom of page • Up to six 80 column lines may be entered and printed within the body of a document • Footnotes • Keyboard inputs

£16.95

TOTL LABEL

A completely practical program for computerising address books or business mail lists. You define width, number of lines and number of characters. The program alphabetizes and you can assign account or customer numbers for further search control. You can print the whole list or selected labels. Make full use of your computer.

£14.95

TOTL TIME

Easy to use, menu driven • Add, change, delete • Browse, (display on screen) • Inquiry display, (date range, Person, Project) • Save and load files on tape or disc • Use of full colour in screen display

Time report • 56 different bar chart report formats • Organise by Person, Project, activity • Sequence beginning or ending date or activity number • Four years, one year, six months, seven weeks, six 9 hour days, two 24 hours

£16.95

RESEARCH ASSISTANT

It takes a competent programmer to write the program to create and control the necessary data files that will let you recall specific data at will. Here are three programs that will allow you to compile information from books, periodicals, accounts, dates in fact any data you wish to keep, to organise it and, most important of all, to create cross reference lists by keyword to help you locate the right reference when you need it.

£16.95

HONEYFOLD

Honeyfold Software Limited
Standfast House, Bath Place,
High Street, Barnet, London.

OFF~THE~PEG SOFTWARE CAN BE VERY UNCOMFORTABLE



Most software packages place you in a strait-jacket.
Now COGENT can supply CP/M software tailored to your vital requirements at near package prices.

The use of program generators enables us to produce reliable, professional software quickly.

Remember, it's the right software that makes your computer worthwhile.

Interested? Call Richard Gordon.

01-794 0179(24 hrs)

COGENT Systems Limited

COMPUTER SYSTEM DESIGNERS & CONSULTANTS
251/253 Finchley Road London NW3 6LS

* CP/M is the T/M of Digital Research Corporation

● Circle No. 207



FULL DETAILS AVAILABLE FROM

**The Computer Room
Thorn House
Eastville Road
Yeovil
Tel No: 0935-20268**

SOMERSET

● Circle No. 208



FULL DETAILS AVAILABLE FROM

**Huddersfield Computer Centre
2/4 Cross Church Street
Huddersfield
Tel No: 0484-20774**

WEST YORKSHIRE

● Circle No. 209

DIRTY MAINS!

a computers' worst enemy

REGUVOLT-a computers' best friend!

A 'dirty' mains supply can often jeopardise the performance of your computer, causing data loss, system crashes and sometimes, damage to both hardware and software.

Raw power, direct from the mains, is prone to transients or voltage 'spikes', which are usually caused by the variation and switching of electrical loads in the vicinity of your computer (e.g. photocopiers, lifts, domestic appliances etc.).

These 'spikes' play havoc with the mains, and then your computer suffers!

A Reguvolt Mains Conditioner will solve the problem, by providing

complete electrical isolation between the mains and your computer system. Transients are suppressed, and a 'clean' and stable voltage supply is maintained.

Where *total* mains security is concerned, a Reguvolt really is your computers' *best* friend!

Please send for further details today.

Single and 3-phase models available, from 120VA to 60kVA.



Cetronic Components Ltd.
Hoddesdon Road, Stanstead Abbots,
Ware, Herts SG12 8EJ, England.
Tel: Ware (0920) 871077 Telex: 817293

● Circle No. 210

A panel of advisors

Made by Texas Instruments to guarantee you reliability, this professional calculator is invaluable to microprocessor designers, logic circuit engineers and all computer specialists.

At the touch of a button, the LCD programmer speeds up conversions in hexadecimal, octal and decimal bases. It offers speed, ease and accuracy for program debugging, and eliminates long hand calculations and conversions.

The specially designed ergonomic keyboard incorporates a printed binary table for ease of use as well as a 3 key constant memory and a constant key. It comes with the reputation of Texas Instruments and the full back up services from Sumlock Bondain.

The T.I. - LCD Programmer - you can count on it. And its at the low price of only **£43.95** (includes VAT & P&P).

Please send me my T.I. - LCD Programmer.

I enclose a Cheque or Postal Order for £43.95 or please debit my Access/Barclaycard account number.

Name _____

Address _____

Postcode _____

Send to: Sumlock Bondain, 263-269 City Road, London EC1V 1JX. Tel: 01-250 0505.

SUMLOCK BONDAIN LTD.
263-269 City Road, London EC1V 1JX. Tel: 01-250 0505.



NEW
FROM SUMLOCK
BONDAIN



● Circle No. 21

An average crop

Michael Trott evaluates a selection of Apple books

THE APPLE II has been a popular machine with business and educational users for many years and, as those who have access to one will know, every aspect of its use and every extra card or peripheral seems to have its own separate guide. *The Apple II User's Guide* brings these together in one relatively compact and comprehensive book covering setting up, programming in Basic, and use of discs, graphics, sound and machine language in no greater depth than the various guides provided with the equipment.



At first glance it would seem of little value though some readers may feel that it provides a more convenient reference than several separate books. The text is clearly written and attractively presented but it is a pity that the author's literary skills could not have been directed towards producing something newer and more exciting.

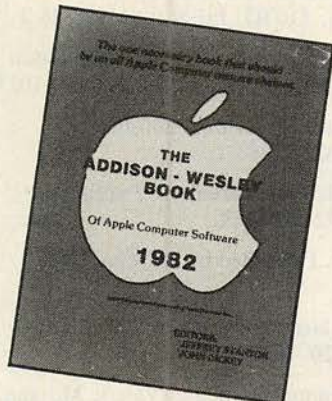

Rather more useful is the *Addison Wesley Book of Apple Computer Software*, described by the publishers as, "the one necessary book that should be on all Apple computer owners' shelves". Something of an exaggeration perhaps, but the book could be of value to those seeking software for their micro, listing as it does the sources of several hundred business, education, utility and games programs.

Actually the book goes further than this by providing reviews of the software with an indication of its usefulness, reliability, visual appeal, adequacy of documentation and availability. The reviews are thorough, well considered and often quite critical and amusing. Unfortunately, this is an American publication and the prices which are quoted in dollars may prove misleading in Britain. Since the source of much of the software is also American one might also question its availability. A call to my local Apple dealer confirmed that most of those with a high availability rating can be obtained easily from any good dealer, making this a useful book for the software hunter.



Also to be recommended is Howard Berlin's *Circuit Design Programs for the Apple II*. The author has written a similar book for the TRS-80 reviewed in an earlier issue of *Practical Computing*. Berlin's aim in writing the book is summed up when he quotes Leibnitz: "It is unworthy of excellent men to lose hours like slaves in the labour of calculation". He has achieved this aim by producing a useful guide to the use of the Apple for those involved in designing electronic circuits.



There are bound to be some bad books in any collection. Take, for example, *Mostly*

Basic: Applications for your Apple II Book 2 by Howard Berenbon. It is also available for the TRS-80, meaning that Mr Berenbon has produced not one but two truly awful books. Since it contains singularly unoriginal programs and many repetitions this is a book to avoid.

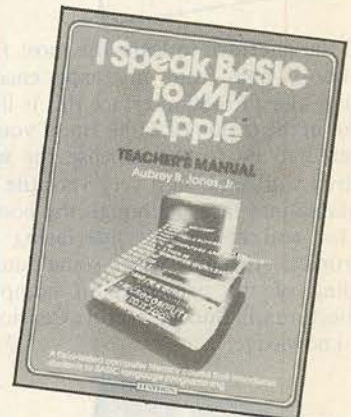

Not much to laugh about in the previous book, but *I Speak Basic to My Apple* by Aubrey B Jones Jr contains some real howlers. Described as a field-tested computer-literacy course it is really an introductory text for teaching Basic. The Teachers' Manual reviewed claims that the course was developed for use by teachers with little or no experience of computers. Leaving aside the issue as to whether this situation should ever be allowed to arise, any teacher in this position who attempts to use this text is unlikely to encourage good programming habits or any real understanding of computers.

My quarrel is not so much with the lesson content, which is no better or worse than many other similar introductory texts, but with the notes for teachers on how to present the work. Advice of the form: "You might like to have an Apple II available", when explaining the keyboard; "Make sure the class knows what a compiler does", when describing the interpreter; and best of all "If you do not know anything about RAM or ROM, don't worry about it", are just a few of many idiotic suggestions. Please, please do not allow this book through the school gates.

Apple Interfacing on the other hand is a much more interesting and useful book. Having previously produced similar texts for the TRS-80 the authors use their experience to lead the reader carefully through the 6502 processor and the basic principles of interfacing to the construction of a general-purpose interface which provides the opportunity for further experiments.

It is fair to point out that it is necessary to
(continued on next page)

(continued from previous page)



build the interface to learn the most from the book, and from my experience in building the TRS-80 interface this is likely to cost in the region of £100. But if you are prepared to go to the expense the work involved will result in a very versatile and adaptable interface. Although the book is not for real novices at interfacing and electronics, readers with some understanding of the principles of computer architecture will find it a useful extension to their knowledge.

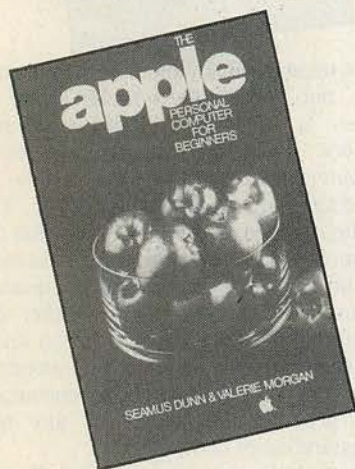

An introductory book which claims to be aimed at the non-mathematical and lives up to that claim deserves to be commended. Such a book is *The Apple Personal Computer for Beginners* by Seamus Dunn and Valerie Morgan. In compact and carefully sequenced chapters the authors provide a sound introduction to the Apple and programming in Basic to bridge the gap between the manufacturer's manual and a Basic text.

The topics covered include starting up, programming, disc management, graphics, introducing machine code and producing a structured program. The listings provided are clear and easy to read and the inclusion of answers to the exercises set marks a refreshing if unusual departure from the practice of many authors. Experienced users will find nothing particularly new or exciting in this book but careful reading will reveal that the authors have taken an established product and produced a no-frills introduction for the possibly wary potential user.

Rather less well presented is Richard Haskell's *Apple Basic*. Covering much the same ground as Dunn and Morgan the author provides a more comprehensive explanation of the concepts involved but assumes a higher level of mathematical ability. *Apple Basic* is liberally sprinkled with black-and-white photographs of the screen, mainly of program listings, which are frequently of poor quality and detract from rather than enhance the effect of the book.

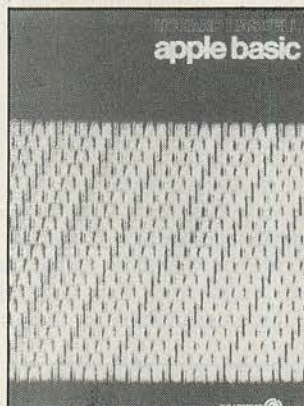

As a course text for schools and colleges, for which it is intended, the book may be regarded as unsuitable due to its heavy reliance on examples of American origin — using as they do dollars and cents and the stars and stripes. The lack of relevance of these examples, from a teaching point of view, is perhaps less serious than the book's reliance on examples which presuppose a level of mathematical ability which may not be present in many pupils, who may still be able to learn to write programs proficiently if the material were better presented.

However the book has its good points, notably in its treatment of loops in which the idea of Do-While, Do-Until, Repeat-While and Repeat-Until loops is clearly explained by drawing a comparison with

train tracks with branch lines and stations. Unfortunately the bad points, including the price of £10.35 for 183 pages, outweigh the good.

Aimed at those wishing to extend their programming skills and to make more effective use of their micro *Assembly Language Programming for the Apple II* by Robert Mottola attempts to provide an introduction to this topic. To a large extent he is successful. Topics covered include entering and editing code, assembling a source code, labels, registers and different addressing modes. The book is well set out and written in a clear and sensible manner, and will undoubtedly assist the reader in making sense of more detailed books on the 6502 processor.



Finally a games book, *Golden Delicious Games for the Apple Computer* is more than a collection of computer games. It contains advice and techniques for creating games on the Apple. Starting at novice programmer level the authors demonstrate how to build general-purpose routines for music, high- and low-resolution graphics and entering data to incorporate into complex games.

The advice given is sound and should lead to the production of well structured programs. If the routines appear rather longer than necessary this is because they are presented in a form that can be easily understood, making this a very good beginners book. M

- The Apple II User's Guide* by Lon Poole, Martin McNiff and Steven Cook. Published by Osborne/McGraw-Hill, 385 pages, £10.95. ISBN 0 931988 46 2.
- The Addison-Wesley Book of Apple Computer Software* edited by Jeffrey Stanton and John Dickey. Published by The Book Company, 401 pages. ISBN 0 201 10279
- Circuit Design Programs for the Apple II* by Howard M Berlin. Published by Howard W Sams, 132 pages, £10.90. ISBN 0 672 21863 1.
- Mostly Basic: Applications for Your Apple II* by Howard Berenbon. Published by Howard W Sams, 217 pages, £9.05. ISBN 0 672 21864 X.
- I Speak Basic to My Apple* by Aubrey B Jones Jnr. Published by Hayden Book Company, £6.55. ISBN 0 8104 6165 X.
- Apple Interfacing* by Jonathon S Titus, David G Larsen and Christopher A Titus. Published by Howard W Sams, 206 pages, £8.20. ISBN 0 672 21862 3.
- The Apple Personal Computer for Beginners* by Seamus Dunn and Valerie Morgan. Published by Prentice Hall, 257 pages, £4.95. ISBN 0 13 039131 X.
- Apple Basic* by Richard Haskell. Published by Prentice Hall, 183 pages, £10.35. ISBN 0 13 039 099 2.
- Assembly Language Programming for the Apple II* by Robert Mottola. Published by Osborne/McGraw-Hill, 143 pages, £9.50. ISBN 0 931988 51 9.
- Golden Delicious Games for the Apple Computer* by Howard M Franklin, Joanne Koltnow and Leroy Finkel. Published by John Wiley and Sons, 150 pages, £8.75. ISBN 0 471 09083 2.



Software News



INNOVATIVE TRS 80-GENIE SOFTWARE

from the professionals

Learn Chess from the Masters with

CYBERCHESS[®]

CHESSE IMPROVEMENT SYSTEM

Now you can learn chess from the Masters with the Cyberchess Chess Improvement System. The Cyberchess System is **not** just another computer chess game. This is a vast and ever expanding "Chess Improvement System" that instructs and analyzes your moves and strategies.

Start off with Cyberchess "System" Program Pack. This packet contains:

- The Cyberchess 'System Program' — required to play all the Cyberchess games.
- Two fully analyzed amateur class games (rating: unrated — 1650).
- Two fully analyzed professional class games (rating: 1600 — 2200).
- Complete set of easy-to-understand instructions.

And there are over 100 program packs available with more being released all the time!

Each program pack is rated amateur or professional and contains four complete and fully analyzed games. Each game was designed or actually played by a highly rated Chess Master. There is a unique 'instruction mode' to analyze your moves and an exclusive 'rating' system to provide mathematical rating of all your moves.

Whether you are an amateur or a seasoned professional, the Cyberchess System has something for you. Cyberchess allows YOU to select the level of play and challenge to match your increasing abilities. Expand your understanding of the royal game of chess with this powerful and effective learning tool. If you like to play chess . . . you'll love Cyberchess!

Compatible with Tandy 1 & 3, Genie V/G, 1 & 2.
Disk based for TRSDOS and NEWDOS.

- CG1 System Disk (playing utility plus 2 amateur & 2 professional games) **£19.80**
 CG2 Games Disk with 4 amateur games (requires CG1) **£14.80**
 CG3 Games Disk with 4 professional games (requires CG1) **£14.80**

Plus V.A.T. and 75p P. & P.

other machines

We have started to supply some of our more popular programs in non TRS-80 format for other machines as follows:

BBC (MODEL B)

JUMBO

The 747 simulation that has swept the TRS-80 community worldwide! So memory tight that there was no room for full colour.

Cassette **£17.25**

MYSTERIOUS ADVENTURES

The English written, machine language series of adventures. Seven in number, at the moment the following are presently available on the BBC:

- The Golden Baton
- The Time Machine
- Arrow of Death Part I
- Arrow of Death Part II
- Escape from Pulsar 7
- Circus
- Feasibility Experiment

Cassette (each) **£10.06**

FAIRYTALE

Basic adventure mainly aimed at the kids but for all the family! Uses a scenario of nursery rhymes and fairytales within which to find the treasures.

WONDERLAND

A follow-up Basic adventure to Fairytale. Fairytales and nursery rhymes again plus cartoon characters.

Cassette (each) **£10.06**

V.A.T. included

P. & P. 75p for any quantity

TEL: [0424] 220391/223636

MOLIMERX[™] LTD
A J HARDING (MOLIMERX)

TELEX 86736 SOTEX G

1 BUCKHURST ROAD, TOWN HALL SQUARE, BEXHILL-ON-SEA, EAST SUSSEX.

TRS-80 & VIDEO GENIE SOFTWARE CATALOGUE £1.00 plus £1 postage.

LONDON COMPUTER CENTRE



ACT Sirius 1

1.2 Mb Disk Storage £2395
2.4 Mb Disk Storage £2895

Now available
Z 80 CP/M Add-on board
to run all CP/M 8 bit or
16 bit software

NEW

**Sirius
Hard Disk 10 Mb
Available Now!**

Wordstar Magic Wand Spellbinder
Spellstar D Base II T/Maker Calcstar
Milestone Datastar Microstar
Fortran Cobol Pascal or any CP/M
software

NEW



EPSON QX10

the revolutionary
small Business
Computer

In Stock
NOW!

TELE-VIDEO SINGLE-USER TO MULTI-USER



Sales



Invoice



Purchasing

806/816

Word Processing



Payroll



Nominal



CP/M Software

Wordstar £195
Spellstar £130
Grammatik £65
Foot Note £75
CPM/IBM £99
CPM/DEC £99
T Maker II £150
D Base II £395
Autocode £120
Milestone £195
Task £195

NEW

EPSON HX20
the Portable
Computer £402



Epson Type 3 MX 80/FT
MX 100



NEW

New Superbrain 2
from £1595
Dedicated Wordstar Keypad



AUTO SHEET
FEEDER £580
New! 12" Wide
Automatic
Sheet Feeder
fits all below



NEW

AUTHORISED TANDY DEALER
11 Mb Hard Disk model 11/16
runs CP/M & TRS DOS £1895

Model 16
128K
from £3129

Model II
with TRS DOS
and CPM at
no extra charge
from £1995

Model III
16K £599
48K £649
48K with 2 disk
drives £1395



DAISY WHEEL PRINTERS LETTER QUALITY PRINTING



- * **FLOWRITER RP 1600. 60 CPS** The most intelligent Daisy. Proportional spacing with Right Justification on WORDSTAR, WORDPRO, APPLE WRITER, SCRIPSIT etc. **£1500.**
- * **TEC 40. 40 CPS** JAPANESE DIABLO 630 uses Diablo Daisy Wheel & Ribbons **£1135.**

HARD DISKS

for Superbrain,
TRS 80 Model II, Apple

Model 6 6 Mb Formatted **£1595**
Model 12 11.5 Mb Formatted **£1895**

- * Specially designed Hybrid heavy duty power supply
- * Data Error Recovery



All prices are Exclusive of VAT and Delivery. Dealer Enquiries invited on all Products.
Large range of CPM Software available. Please phone for Prices.

Demonstrations on all models.

43 GRAFTON WAY, LONDON W1P 5LA (Opposite Maples)
OPENING HOURS: 11-7 MON-FRI 12-4 SAT Tel: 388 6991/2
24 hour answer phone: 01-388 5721

Printer's error * ? *

by Douglas Tate

The numbers resulting are codes for letters:

- 65 — 97, a
- 85 — 117, u
- 67 — 99, c
- 84 — 116, t
- 85 — 117, u
- 51 — 83, S
- 83 — 115, s
- 0 — 32, space
- 79 — 111, o
- 80 — 112, p
- 65 — 97, a
- 85 — 117, u
- 76 — 108, l
- 71 — 103, g
- 0 — 32, space
- 69 — 101, e
- 1 — 33, !
- 65 — 97, a
- 48 — 80, P
- 57 — 89, Y
- 0 — 32, space
- 84 — 116, t
- 77 — 109, m
- 73 — 105, i
- 79 — 111, o
- 35 — 67, C
- 82 — 114, r
- 84 — 116, t
- 73 — 105, i
- 76 — 108, l
- 78 — 110, n
- 67 — 99, c

```
10 DIM Z(9)
20 FOR X=1 TO 9 STEP 1
30 READ Z(X)
40 NEXT
```

```
310 FOR Z=1 TO 9
320 P.Z(X);"$";LEFT$(X,3)
330 NEXT
```

```
1210 DATA A,B,C,D,E,F,G,H,I,
```

ATICATOC
BFANCHIPS
CCALFINEORDC
DCTINGISORRID
EPRAMISEDTOBYMEA
FTASBIGASBOXES
GINGMENOWMAVIS
HPUTISANDINISPOCKIT
ICOMGREYMALKIN

NOW SIR, you say that your printer is playing up. Listing looks OK except that you have nothing to put the bits in order at the end. Ah, so that is the printout — as far as I can see there is a command gone wrong and a symbol missed out — both in the same line. It's not the printer sir. Now, which computer have you got? Oh, one of those, well that explains it, doesn't it sir!

Solution to February puzzle

GMRA'ANA = anagram = number of digits in each binary line. Each page of the drawing contains eight, seven-bit binary numbers. With this list of 32 codes add 32, the ASCII code for space.

These letters when rearranged make

**Practical Computing
Salutes You!**

Easy!



A+G COMPUTERWARE

SPECIAL BBC OFFER

EPSON MX80 FT3 PRINTER

+

PRINTER CABLE!

+

500 SHEETS LISTING PAPER!

FOR ONLY **£330**

WHILE STOCKS LAST ONLY

TEAC SINGLE DISK DRIVE WITH CABLE (BBC)
ONLY £185.00

TEAC TWIN DRIVE WITH CABLE (BBC)
ONLY £345

UP TO 30% ROYALTIES!!

We are looking for quality software for BBC — Spectrum — Dragon — Oric etc.

Please write in strictest confidence with details. Fulllest author recognition and extensive advertising.

Add £8 carriage + 15% VAT to all prices
Pre-paid orders or Access.
Ring for full price lists.



P.O. Box 34, Cheadle, Cheshire, SK8 4PT

Telephone 061-428 2014

● Circle No. 214



FULL DETAILS AVAILABLE FROM

**Hill Price Davison
Walham House
Walham Grove
London SW6
Tel No: 01-381 3266**

GREATER LONDON

● Circle No. 215

WHEN IT COMES TO MICROCOMPUTER SOFTWARE WE WROTE THE BOOK

How do you stay up-to-the-minute with the rapidly changing world of microcomputer software? Get the Lifeboat Catalogue.

The latest innovations The new Lifeboat Catalogue is packed with the latest state-of-the-art software. And if we publish a new program after the latest catalogue has gone to press, we enclose a flash bulletin in your copy.

The greatest selection Because Lifeboat is the world's largest publisher of microcomputer software, our catalogue offers you the greatest selection of programs for business, professional and personal use. Our more than 200 programs range from the integrated accounting and professional practice systems to office tools for book-keepers and secretaries to sophisticated tools for programmers. Included are business systems, word processors, programming languages, database management systems, application tools and advanced system utilities.

We specialise in software that runs on most small business computers. Our more than 60 media formats, including floppy disks, data cartridges, magnetic tape and disk cartridges, support well over 100 different types of computer.

Get full service We give the crucial dimension of after-sales service and full support to everything we sell.

That includes:

- An update service for software and documentation.
- Telephone, telex and mail-order services in the London office and at overseas offices in the United States, France, Switzerland, West Germany and Japan.
- Subscriptions to Lifelines,TM the monthly magazine that offers comparative reviews, tips, techniques, identified bugs and updates that keep you abreast of change.

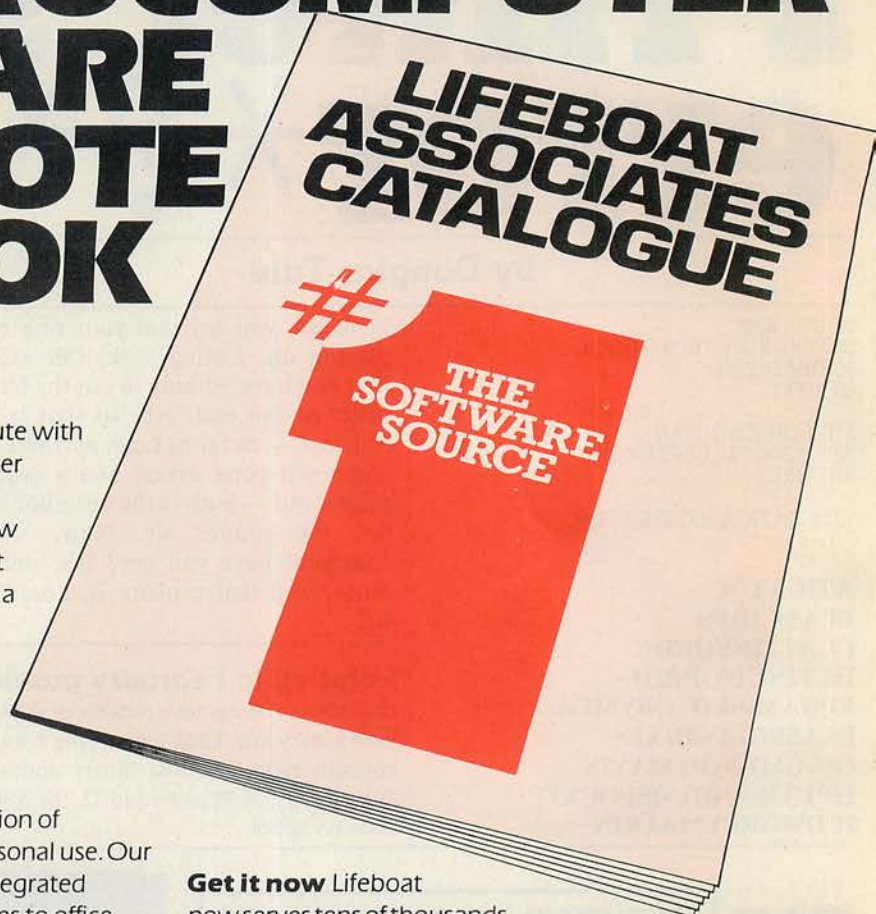

Get it now Lifeboat now serves tens of thousands of satisfied customers with our breadth of up-to-date, fully tested, fully supported and competitively priced software.

You may not need all we offer, but we offer just what you need. After all, we wrote the book.

Lifeboat Associates
World's foremost software source

Mail coupon to: Lifeboat Associates

PO Box 125, London WC2H 9LU or call 01-836 9028

Please send me a free lifeboat catalogue.

Name

Title

Company

Address

Postcode

Copyright © 1981, by Lifeboat Associates.

Lifeboat Worldwide offers you the world's largest library of software. Contact your nearest dealer of Lifeboat.

USA Lifeboat Associates 1651 Third Ave. New York NY 10028 Tel (212) 860-0300 Telex 640693 (LBSOFT NYK) TWX 710 581-2524 **JAPAN** Lifeboat Inc. OK Bldg. 5F 1-2-8 Shiba-Daimon Minato-ku Tokyo 105 Japan Tel 03-437-3901 Telex 2423296 (LBJTYO) **ENGLAND** Lifeboat Associates Ltd PO Box 125 London WC2H 9LU England Tel 01-836 9028 Telex 893709 (LBSOFTG) **SWITZERLAND** Lifeboat Associates GmbH Hinterbergstrasse Postfach 251 6330 Cham Switzerland Tel 042-36-8686 Telex 865265 (MICO CH) **WEST GERMANY** Intersoft GmbH Schlossgartenweg 5 D-8045 Ismaning W. Germany Tel 089-966-444 Telex 5213643 (ISOFTD) **FRANCE** Lifeboat Associates SARL 10 Grande Rue Charles de Gaulle 92600 Asnieres France Tel 1-733-08-04

● Circle No. 270

>NEXT MONTH

>LANGUAGES

The special feature section of the April issue of *Practical Computing* will be devoted to the most popular and most important microcomputer languages, including a survey of Basic dialects. If you are looking for an alternative to Basic then don't miss our coverage of APL, Cobol, Forth, Lisp, Logo, Pascal and Prolog.

We'll be looking at their strengths, weaknesses and possible applications, together with their potential for the future.

A comprehensive table will tell you which languages are available for which machines.

>BUSINESS MICROS

The major products tested include the Olivetti M-20 and Cifer Series 1 microcomputers. The Olivetti is a 16-bit machine which is unusual in using the Zilog Z-8000 processor — and it's fast. The Cifer is a British CP/M micro that has a novel and interesting architecture, and yes, it can be 16-bitted.

>AND MUCH MORE!

- Word processing on home micros — we take a detailed look at some of the programs available, including the "word processor on a chip" for the BBC machine.
- A comprehensive guide to machine-code programming on the Sinclair Spectrum.
- Plus all the usual reviews and departments including all the programs in Open File, news and your letters.
FREE: on the cover you will also find a pen from the Berol company which has been specially designed to write on floppies without damaging them.

Make sure you don't miss the April issue of

Practical Computing

On sale at W H Smith and all leading newsagents after March 16.

ASK ABOUT
THE SPECIAL
FREE SOFTWARE OFFER.



FULL DETAILS AVAILABLE FROM

Oak Computer Systems
St George's House
Cattawade
Manningtree
Tel No: 020-639 5097

ESSEX

● Circle No. 216

ASK ABOUT
THE SPECIAL
FREE SOFTWARE OFFER.



FULL DETAILS AVAILABLE FROM

Starwest Computer Services
20 Lime Street
Bedford
Tel No: 0234-213547

BEDFORDSHIRE

● Circle No. 217

Come to Kenilworth for
SHARP
OFF-THE-SHELF
RELIABILITY

We have MZ80 A & B and PC 1500 with Software back-up expertise to advise you on your requirements. See the advanced technology of SHARP on demonstration.

— THE LARGEST U.K. NASCOM DEALER —

Come to Kenilworth for
DRAGON
FANTASTIC VALUE FOR MONEY

British built and designed. 32K RAM as standard, (expandable to 64K Bytes). Plus extensive facilities for colour graphics. 9 colour, 5 resolution display. Advanced sound. Prices from only £199. inc. VAT.

Full ranges of Software – tapes, cartridges, joysticks, books etc.

— THE VERY POPULAR —

Come to Kenilworth for
SINCLAIR
A MOST POPULAR MODEL

SINCLAIR ZX81 at £49.95
16K RAM PACK at £29.95
SINCLAIR PRINTER
at £59.95

ZX81 1K RAM, one-touch Keyboard, complete with all connecting leads. 16K RAM pack plugs into expansion port enabling use of sophisticated ZX Software. ZX printer had full alphanumerics and graphics, 50cps, 32 characters per line.

EDUCATIONAL USES—

Our main product line – Nascom – will act as an excellent stand-alone system, optionally with High Resolution Colour Graphics and will attach to an economical Local Area Network. Ask for details of our recent installations in the educational field.

Yes... come to Kenilworth
Business & Leisure
Micro Computers
16, The Square, Kenilworth,
Warwickshire CV8 1EB.
Telephone: (0926) 512127.

Come to Kenilworth
THE LARGEST UK
NASCOM DEALER

We are the largest NASCOM distributors in the U.K. and are up-to-date with all the latest hardware and software. Colour, Sound, Speech, Educational, Business, Home, or any application you have in mind.

Kit Computers with power supply, £260 excl. VAT.

Built Computers with power supply, £375 excl. VAT.

— SHARP OFF-THE-SHELF RELIABILITY —

Come to Kenilworth for
QUIBS
BUSINESS SYSTEMS

An integrated Nominal, Purchase and Sales Ledger with optional invoicing and stock packages using the QUANTUM (British) with up to 2.25 M BYTE of floppy discs. Very competitive prices. But best of all friendly, professional advice on the best system.

— THE WELSH DRAGON —

Come to Kenilworth for
WORD
PROCESSING

We can offer a choice of low cost systems that will cut the cost of business letters and documents; repeat letters; speedy correction from video screen. Prices from as little as £1,600 incl. VAT.

— QUIBS BUSINESS —

COMPUTASOLVE LTD

8 Central Parade, St. Marks Hill, Surbiton, Surrey.

Tel. 01-390 5135

(100 yards from Surbiton station)

YOU KNOW WHAT YOUR
BUSINESS PROBLEMS ARE...
COME TO COMPUTASOLVE LTD
AND LET US HELP YOU
TO FIND A SOLUTION

We stock many standard business packages including accounting systems by TABS and PEACHTREE, and record management systems from COMPSOFT.

If there isn't a suitable package available we can develop software to suit your particular needs.

The hardware we can supply ranges from home computers to powerful business micro systems.

Word Processing Software is available on all of our business systems.

● Circle No. 218



FULL DETAILS AVAILABLE FROM
North Staffs Business
Technology Centre
33(a) Ironmarket
Newcastle-under-Lyme ST5 1RS
Tel No: 0782-613606

STAFFORDSHIRE

● Circle No. 22

● Circle No. 218

A bit far-fetched

IT HAS LONG BEEN TRUE in our industry that what you see advertised and what you can buy are two totally different things. The two are now moving so far apart that a new rule has to come into operation: "If it isn't obsolete, you can't get it and you wouldn't want it if you had it."

This sour conclusion is prompted by a recent attempt to bring to you, gentle reader, a review of the 16-bit operating systems. To judge by the printed word, 16 bit has come and gone: but even so we thought it might be a good idea to assemble in one spot machines running CP/M-86, MS-DOS, Xenix and whatever. Well, after very energetic attempts by many persons what arrived on the day was a single, battered IBM PC running PC-DOS. Its colour did not work and no one knew how to mend it. As for the others, it was as if they had never been.

PC-DOS looks like CP/M but with some very annoying frills. When you turn the machine on, it does nothing for long enough to convince you that it has broken in some fundamental way — long enough, in fact, for you to start ringing those who know and love it, if there be any such. No, it hasn't broken, it's just that every time you reboot it has to test all its memory to see that nothing got sick in the night. Then you have to go through one of those infuriating interrogations about who you are and what date it is — being careful to type in the date in American order with redundant zeros — just the way you would never do it if left on your own.

After 20 years of computing, has no one the wit to write a program that understands "04" is the same as "4"?

All this agony, and it then runs some pretty stolid business software. The stuff is beautifully packaged, I will give it that. The manuals are nicely printed with many neat drawings of where to put your pudgy fingers on the keys. They are those grey blobs with letters on them. Do you know what letters are? Who's a clever boy then!

The silk screening on the plastic binders rises, in some cases, to an art form. The binders arrive inside cloth-textured boxes. The whole thing has evidently been packaged by someone whose last job was producing "old master" editions of the classics for sale to readers of Sunday colour magazines. The packaging is impressive; the software not terribly.

There was one exception: a scrawled-on disc with three tattered pages of manual had a most impressive real-time simulation of flying a light aeroplane. The instruments worked and the whole thing behaved aerodynamically. Even the countryside was in three dimensions with a huge pylon thing to fly into if you wanted an early death. It is



by Peter Laurie

the only piece of software I have seen which could not possibly have run on an eight-bit machine. But, again, it was just as boring as actually flying about in a Piper Cub or some such.

In an attempt to bring you some more solid news, I talked to two people who had implemented MS-DOS, Microsoft's answer to CP/M-86. They said it was alrightish, but there was a little problem about files. What sort of problem about files? Oh, nothing much. Just that it will not allow you to have files bigger than 200K. I suppose that does not matter much at the moment because most 16-bit machines have tiny discs. If you want to do serious data processing you have to buy an eight-bit machine.

Another reason I wanted to see MS-DOS was a utility described in Microsoft's brochure which would turn Z-80 code into 8086 code. As the proprietor of some eight-bit software that many people urgently want converted in this way, I was most interested. On the day, it did not appear. Calls to Microsoft produced no news of it. Evidently the man who printed the brochure had thought it would be a nice idea and would cheer everyone up, so he threw it in. It will appear, we are told, with MS-DOS 1.2 or 2 or whatever the next number is. When might that be? Who can tell.

The second operating system we wanted to look at was Xenix, a micro version of Unix. No problems about Xenix: it worked wonderfully, we would be most impressed. One small snag, though, the machine it was

on was stuck in customs and had accumulated more warehouse costs than it was worth. The best thing seemed to be to abandon the machine to the warehouse owners. So much for Xenix.

The third was CP/M-86, which one is reliably informed works just like CP/M-80 — that's the sort we are used to. There did not seem a lot of fun in that so I will not, for the moment, be writing a review of 16-bit operating systems.

Everyone is so hysterically frightened of being left at the post that they are announcing "products" that are no more than a gleam in someone's eye. The result is a most unnerving kaleidoscope of whirling progress, made all the more alarming as you can never see any evidence for it. Anywhere.

Evidently, everyone thinks that the opposition must be so far ahead that they are out of sight, and this spurs them to even greater heights of pre-announcement.

Yet there is, as we have discovered over the last few months, a sensible core of people with real jobs to do and real needs for well-established products. They realise that the 16-bit machines may, one day, be very nice, but for the moment they are embryonic. They will make do perfectly well with what eight bits can do for them. When there are lots of people around using 16 bits, lots of dealers who understand them and lots of software for them, then it might be sensible to change. But then one reflects that the "16-bit revolution" burst on us two years ago and has yet to arrive.

It is up to the micro journals to try to keep things on the rails. Normally it is the function of the press to tell of what is new and exciting; in this odd business it should be its function to tell of what is old and reliable. Journalists must realise that an announcement or even a prototype of a new machine or a new software system is only the beginning. It may catch on or it may not. Its builders may be able to supply customers' demand or they may not. It may need some accessory which other people have to supply, and they may not.

The problem from the journalists' point of view is that this makes for rather boring material. There are, depending on whose fingers you count, some 20, 50, 100 magazines and papers competing for the attention of a new mass market interested in computing. It is a rule of computing that the less you know about it, the more you expect. You and I know enough about it to be pleasantly surprised by a successful run of address labels; newcomers expect something more exciting than that. There are too many journalists and PR people willing to oblige them, and in the end the result will be a vast amount of confusion and disappointment. □

NOW in Birmingham – the centre of industrial Britain . . .

THE Midland Computer Fair

*Personal computers
Home computing
Small business systems*

Bingley Hall, Birmingham.
April 28-30, 1983

Sponsored by **Practical Computing** and **YOUR COMPUTER**

This exhibition is the ideal showcase for companies who need to demonstrate their products to the fast expanding market for home and personal computers, small business systems and associated software. When you consider that the markets for personal computers are regional and that Birmingham has a developing computer awareness with a great deal of computer expertise in the area, you'll appreciate the need for The Midland Computer Fair. The public has already demonstrated its appreciation of The Computer Fair in London by sheer volume of numbers. We know the success will continue in Birmingham.

Personal computers are part of everyday life.

Make Sure Your Computer Products And Services Are Seen At The Midland Computer Fair.

For the full story contact the Exhibitions Manager, The Midland Computer Fair, IPC Exhibitions Ltd, Surrey House, 1 Throwley Way, Sutton, Surrey SM1 4QQ.



Please contact me with further information about exhibiting at The Midland Computer Fair.

Name _____

Position in Company _____

Company _____

Address _____ Tel _____

THE Midland Computer Fair
*Personal computers
Home computing
Small business systems*



The POWER BANK

system compatible sine wave output

Plug your microcomputer, VDU and Printer into the POWER BANK and forget about a disabling break in the electricity supply. This unit will continue to run your system in the event of a mains failure... WITH NO INTERRUPTIONS TO YOUR WORK!

Vital when running business. This unit will of course suppress MAINS SPIKES and SURGES. Batteries included (sealed for life)
120VA £320.00 and 250VA £450.00 (output) units available

Power Testing (Sales) Ltd
65a Shenfield Rd, Shenfield, Brentwood, Essex CM15 8HA
Tel Brentwood (0277) 233188 Telex 24224586

● Circle No. 224

TRS80 — VIDEO GENIE SOFTWARE

We offer a great selection of games and utilities from many leading software houses at reduced prices. As a special offer, to introduce you to our software, we are giving away, well almost, a software pack with a super variety of 25 full length programmes on it, and all for only £7.50. Do not miss out! Send for our illustrated catalogue today. Please enclose an s.a.e.

SPARTAN SOFTWARE
Department PC
9 Cotswold Terrace,
Chipping Norton, Oxon.
Telephone: 0608 3059

● Circle No. 225

POSEIDON COMPUTER SERVICES LTD.

Of Hampton S.W. London Dealer
FOR SIRIUS 1

DEMONSTRATION BY APPOINTMENT
MOST TYPES OF PRINTERS SUPPLIED
BESPOKE SOFTWARE A SPECIALITY
COMPETITIVE PRICES
FULL UK DELIVERY

ACT SIRIUS 1
TELEPHONE: 01-941 1447/5986;
TELEX 8954665 GITS

● Circle No. 226

MICROWARE

(London Ltd)

COMPLETE DISC DRIVE SUB SYSTEMS

For Tandy; Video Genie; Nascom

AND ALL POPULAR MICROS

SINGLE UNITS **£175**
DUAL UNITS **£295**

BBC MICRO

SINGLE UNIT FROM £135

Includes PSU and attractive desk top cabinet

- Fully guaranteed CDC disc drives
- Cast aluminium chassis
- 5 mili sec track to track
- 250k; 500k or 1MB
- Industry compatible

Microware

(London Ltd)
637 Holloway Road,
London N19
Tel: 01-272 6237
01-272 6398

● Circle No. 227

SEARCHING FOR BEST PRICE

FOUND BEST PRICE... GO TO ORCHARD

PET	CASSETTE	RRP	
C2N		£55	Our own transport delivers nationwide weekly. All you need is our Best Price Quotation. Contact us now! For super service.
4016	16K	£550	
4032	32K	£695	
8032	32K	£895	
8096	96K	£1195	
DISK DRIVES			
2031	170K	£395	
4040	343K	£695	
8050	1M	£895	
8250	2M	£1295	
9060	5M	£1995	
9090	7.5M	£2495	
PRINTERS			
4022P	80COL B/DIR	£395	
8023	136COL	£895	
8300	DAISY	£1395	

Our price is unprintable.
Contact NOW for best price quotation.
If you know what you want why wait?

ORCHARD COMPUTER SERVICES
ORCHARD HOUSE, 21 ST. MARTINS ST.,
WALLINGFORD, OXON.
TEL: WALLINGFORD (0491) 35529

● Circle No. 228

DISKETTES AT UNBEATABLE PRICES

WABASH diskettes 5 1/4" SSSD
£13.50 per box
8" SSSD £16.00 per box
VERBATIM 5 1/4" SSSD £17.50 per box
8" SSSD £23.00 per box
Prices exclude VAT at 15%.
Postage and packing free. Send for price list to:

Marlowfield Limited
Hesketh Bank House, 7-11 Yellow House Lane, Southport, PR8 1ER.
Telephone: (0704) 36082

● Circle No. 229

CAN YOUR MICRO READ THIS?

Bar-code identification for...

PET/CBM APPLE BBC

Bar-codes give a speedy and error free means of data entry and provide a foolproof method of identification for any item or document. Typical uses include stock control, libraries, filing systems, security & checkpoint verification, point of sale terminals, spare parts identification, etc., etc. Many organisations are adopting bar-coding as a way of introducing computer techniques into the work environment. Already most grocery products are bar-coded at source and many other areas of industry and commerce are following. Bar-codes will soon be commonplace.

Our system contains all the hardware & software needed to implement a bar-code system on your computer now. Software to print bar codes on an Epson printer is included. More information on request... please state your micro & area of interest.

Price £199.00 + VAT

Special systems can be designed... contact consultant Lee Allen.

LOWEST PRICES IN UK

EPSON MX80 FT3

Epson, Seikosha, Dragon, NEC, TEC, Microline, Qume, Diablo, BMC, Sanyo, Anadex, Centronics, Mannesmann-Tally etc. etc. All these famous name computer products and more at guaranteed lowest UK prices. Most can be delivered to your door within 24 hours. Send SAE for full lists or phone for a quote.

ALTEK (PC) 1 Green Lane
Walton-on-Thames, Surrey
Please phone before calling (093 22) 44110

● Circle No. 230

OSBORNE 1

- praxis daisywheel **£425**
- NEC/Epson/OKI **£ call**
- Monitors + cable **£ 99**
- OSBORNE **£ call**
- Games for Osborne from **£19**

We specialise in Osborne & hold large stocks of above.
CALL FOR SUPERB PRICES

FRASER ASSOCIATES
Buckingham (02802) 6087

● Circle No. 231

SHOP WINDOW

Every computer needs a **CHATTERBOX!**
"OK Spock, you win this time...." **NEW!**
SAVE ££££ ONLY **£49**



for **ZX81 SPECTRUM**
NASCOM, VIC, PET, BBC, APPLE, TRS80, IBM, CRAY, ETC.
(Please state)

At last! Genuine phonetic synthesis at a sensible price. Gives your computer an *unlimited* vocabulary (nothing more to buy!). Self contained speaker/amplifier, Sinclair connector etc, PLUS Expansion socket for **BIG EARS AND** Monitor socket for Music Board. Full instructions, technical notes and programme examples supplied with this outstanding educational unit.

OR COMPLETE D.I.Y KIT **£39**
DEALER ENQUIRIES WELCOME

As seen on BBC TV "Computer Programme"
*** BIG EARS *** STOP! GO! LEFT! RIGHT!



SPEECH INPUT FOR ANY COMPUTER

Hugely successful Speech Recognition System, complete with microphone, software and full instructions. **BUILT TESTED & GUARANTEED** ONLY **£49**
PLEASE STATE COMPUTER: UK101, SPECTRUM, ATOM, NASCOM2, Vic 20, Micron, ZX80/81, PET, TRS80, MZ80K, APPLE II, BBC MICRO
NEW: FAST MACHINE CODE FOR ZX SPECTRUM **£7.40**

ZX81/SPECTRUM
MUSIC SYNTHESISER (STEREO)
+ 16 LINE CONTROL PORT



Play 3-part music, sound effects, drums etc. Full control of attack, decay and frequency. Input/Output lines provide control and monitor facility for... Home Security, Robot Control, Model Railway etc. etc. Works with or without 16K RAM.

Add keyboard to make a live performance polyphonic synthesiser! Full instructions/software included.

AMAZING VALUE AT ONLY £19.50 (KIT)
Extra 23 way connectors at £2.60 **£25.50 (BUILT)**

THE COMPOSER
Music Programme for above synthesiser. Enter and play 3 part harmony. Includes demonstration tunes. Recommended **£7.40**



COLOUR MODULATOR KIT **£15**
RGB in, PAL/UHF out (not for ZX) BUILT **£20**

SPECIAL OFFER I.C. **£18**
SPEECH OUTPUT CHIP SX-01
Phoneme Speech Processor DATA **£0.60**

Please add VAT at 15% to all prices. Barclay/Access orders accepted by telephone. All enquiries S.A.E. please

WILLIAM STUART SYSTEMS Ltd
Dower House, Billericay Road, Herongate, Brentwood, Essex CM13 3SD, England
Telephone: Brentwood (0277) 810244



● Circle No. 232

CHALLENGE.....AND PROFIT
POOLS PREDICTION
"Computer aided forecasting can significantly increase the chance of winning"
THE DATA ...

- * Available for your analysis — the complete record of all English Football League games 1977-82 (20,280 matches).
- * Not simply win-lose-draw record, but the *actual scores and dates*, allowing sophisticated analysis.
- * Simple numerical array format.
- * Full documentation.
- * Supplied with starter analysis programs in BASIC and PASCAL.

• TAPES (2 years data) £7.50
• DISCS (5 years data) £15.00
• Apple DOS/Pascal/CPM Superbrain • Rair • Pet
• TRS 80 • Dragon • ZX-81 (16K) • Spectrum • most others — please enquire
Selec Software, 37 Councilor Lane, Cheshire, Cheshire, SK8 2HX. 061-428 7425.

● Circle No. 233

BookKeeper

BUSINESS ACCOUNTING SYSTEM

A simple self-contained accounting system — available now on CP/M-based microcomputers.

BookKeeper will help you to maintain orderly books of account — without the complexities of a fully integrated ledger system.

For further details, contact:
Mike Lewis Consultants Ltd.,
48 Willoughby Road,
London N.W.3
Tel: 01-794 3886

● Circle No. 234

BRAIN SURGEON

Anita Electronic Services (London) Ltd are specialists in the repair and service of Superbrain I and II and associated printers including Apple silent type, Centronic, Anadex, NEC, QUME, Ricoh and Empson.

We also specialise in the repair of Commodore and Apple computers.

We offer a fast on-site service or alternatively repairs can be carried out at our workshops should you wish to bring in your machine.

Maintenance contracts are available at very competitive prices. Trade enquiries welcome.

For further information telephone or write to:

MR D. WILKINSON
Anita Electronic Services Ltd.,
15 Clerkenwell Close,
London E.C.1.
01-253 2444

● Circle No. 235

SHOP KEEPERS

Our Mr. Retailer Programme makes your cash register Redundant. In return Mr. Retailer will keep all your books up to date at the Time of Sale of your goods as used in large chain stores. Including Stock Control, VAT, Creditors, Debtors, Salesmans Commission, Trial Balance, Issues invoices, receipts, Payment on Account, Monthly Statements. Invaluable reports available at any time. Untrained shop or office staff can operate. Written for business men not for programmers. CP/M Based.

Superbrain 64K 350K	£1495.00
Shelton Signet 2FS 64K 400 K	£1212.00
Epsom MX80/FT-3	£366.00
Mr. Retailer (by mail order only)	£375.00
Mr. Retailer	£975.00

DEMONSTRATION CLEARANCE	
Superbrain QD 700K	£1550.00
Epson MX80/FT-2 (with RS232 interface)	£325.00
Paper Tiger 440 (few hours use only)	£245.00

TRS 80 16K LII Software
Original Games, Superb Graphics, 3 on tape **£5**
Also 16K business software tapes

ACCESS COMPUTERS
2 ROSE YARD MAINSTONE
KENT. TEL (0622) 58356

● Circle No. 236

PURCHASING MANAGERS

Packaged or tailored software available for stock control and ordering. Used by purchasing departments in a number of large companies.

Phone Mike Gardner on
01-421 0266

cats software
96 Grimsdyke Road,
Hatch End Pinner
Middx HA5 4PW

● Circle No. 237



INTERESTED IN COMPUTERS?

Then Computer Park '83 is the ideal holiday. Wide range of computers and peripherals: robots, programmable railway layout, electronic music, speech synthesisers, light sequencers etc.

Residential in Northants Country House August 1983. Suitable for 10-year-olds upwards.

Details from:
Computer Park '83
The Nook, Back Lane, Little Addington,
Kettering, Northants NN14 4AX.

● Circle No. 238

CRITICAL PATH PERT

PROJECT PLANNING SOFTWARE
for CP/M Microcomputers

up to 1200 activities/1500 events
First Year Licence **£375**
Renewals & s/w update **£40**
Manual only **£10+£1 p&p**

We also supply a wide range of general purpose CP/M microcomputer systems and software. Systems can be configured to a wide variety of user requirements from single-user up to fully comprehensive multi-user microsystems.

Contact:
Pete Berry on 0234 40511 or 0525 405167
CBACS LTD.
31 Goldington Rd., Bedford MK40 3LH.

● Circle No. 239

MICROCOMPUTER INSURANCE

Comprehensive cover at a reasonable premium:

- All Risks Cover (incl. Transit) — up to £8,000 for £20
- Increased Cost of Working — to reinstate lost data
- Breakdown & Derangement — alternative to maintenance agreement

Write with details of equipment to:

Geoffrey Hoodless & Associates
Freeport (no stamp required)
Woking
Surrey GU21 3BR
Tel: Woking (04862) 61082 (24 hrs)

● Circle No. 240



DISKS STATIONERY PRINTERS

Special offers on disks, stationery and printers

Flippy diskettes in boxes of 10
 5 1/4" s/s s/density s/sectored only £15.00
 8" s/s s/density s/sectored only £15.00
 (Add £1.00/box P & P + Vat.)

Continuous stationery-1000 sheets
 9 1/2" x 11" Plain single part only £4.95
 9 1/2" x 11" Plain (with 1/2" margins) only £5.96
 14 1/2" x 11" Lined or plain single part only £7.00
 (Includes delivery, excludes Vat.)

Printers from Newbury Labs

Special Introductory Offer
 A free box of 9 1/2" x 11" Stationery with every Newbury Printer purchased

The 8510 (11" carriage) only £480.00
 The 1550 (15" carriage) only £650.00

For the printer that has everything standard, buy The Newbury 8510 or 1550. Price includes 6' cable



CDP Consultants Limited
 WICKEN ROAD CLAVERING
 ESSEX CB11 4QT
 Ring Clavering (079985) 617

● Circle No. 251

DEMONSTRATION
 MODELS
 SUPERBRAIN QD I
 £1200
 SUPERBRAIN QD II
 £1400
 CAMBRIDGE DATA LTD.
 01-348 3298

● Circle No. 252

OPEN HOUSE for COMPUTER NOVICES

Choose your time — day or evening. Learn at your own pace on Apple, Pet or CP/M Computers. BASIC programming and Business Packages.

including

Trial Course £15 —
 4 hours computing practice

Brochure from:
 MICROCOMPUTER ADVISORY
 CENTRE

Polytechnic of the South Bank, Borough Road,
 London SE1 0AA.

Tel.: 01-928 8989 Ext. 2468

● Circle No. 253

PSION

MICROCOMPUTER PROGRAMMERS & ANALYSIS

Psion is a substantial and rapidly growing micro-computer applications and software house.

We require creative, skilled and able programmers and analysts. Applicants should have experience of assembly language and machine-code on one or more microprocessors. This is an exciting opportunity to work with a dedicated team in Central London in the fastest-growing area of computers.

Salary range £8,000 to £15,000 per annum depending on skill, experience and creative potential.

PSION LTD., 2 Huntsworth Mews,
 Gloucester Place, London NW1.
 Telephone: 01-723 6919 or 01-723 9408

● Circle No. 254

THE EXTRAORDINARY EPSON HX20 FOR £402



£402

£402

FULL FUNCTION

The full function, truly portable computer. Featuring LCD Screen, Full typewriter keyboard, Printer and Microcassette.

FEATURES

16K to 32K RAM, 32K to 64K RAM, RS232C and serial interfaces, 18 user definable programme functions, 50 hours power supply, RAM memory retained after switch-off.

HX20 HARDWARE

STOCK NO.	DESCRIPTION	PRICE
HX20	95677D HX20 Portable Computer	402.00
HX20-UA	95676F HX20 (and transit case)	411.00
HX20 MC-SA	95681X Microcassette Drive	75.00
HX20EU-SA	95682H 16K Byte RAM expansion Module	80.00
H00BR-JA	95683F Barcode Reader	82.00
702	95686X External Cassette Cable	5.70
714	95688C Cable to connect an external printer (serial)	15.00
716	95690H Cable to connect 2 HX 20 computers using 8-Pin RS232 Sockets	15.00
717	95689E Cable to connect 2 HX 20 computers using high speed serial interface	15.00
H00-CR-RA	95692D Cartridge ribbon for printer	2.20
H00-RP	95691F Paper Rolls for printer (pack of 5)	2.60
H00-CT	95678B Microcassette tape	1.60

HX20 SOFTWARE from £30

The following economically priced software (from £30) is available in microcassette or pre-programmed ROM format.

DESCRIPTION	DESCRIPTION
DIY	A programme generator
EPSON SIMPLICALC	A spread sheet package
THE PERSONAL OFFICE	Including 3 month rolling diary and card index system.
CORRESPONDENT	A powerful word processing package
MLIST	A complete mailing list programme with link to correspondent
SALES ORDER	Package which can be linked to mainframe computers
COMMUNICATION	Packages for specialist applications are available

These prices do not include VAT. Carriage and packing extra

FROM



Edinburgh Way, Harlow, Essex CM20 2DF



PHONE HARLOW
 (0279) 442971

● Circle No. 22

QUALITY, VALUE, PERFORMANCE & COMPATIBILITY

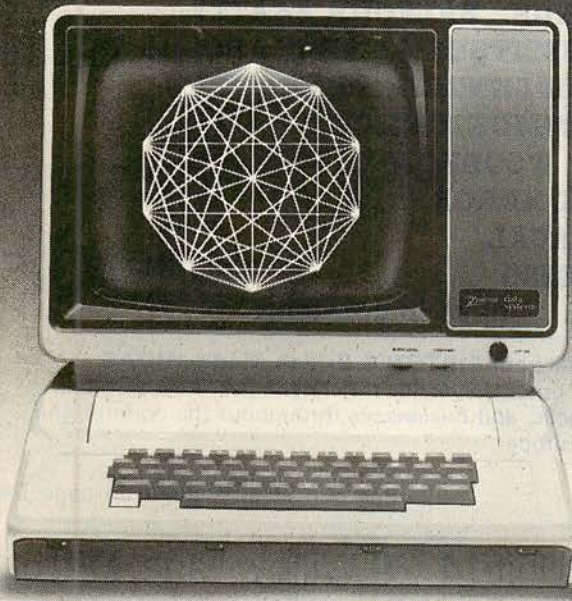

THE ZVM-121 VIDEO MONITOR

- Highly attractive prices available direct to OEM's/Dealers.
- Unmatched value through high quality and high volume manufacturing.
- Compatibility with the majority of popular microcomputers.
- High resolution video display with improved character definition.
- Versatile exterior controls facilitate display adjustments.

The ZVM-121 is a high quality, high resolution 12" monochromatic video monitor. Backed by massive resources and decades of experience in video electronics, Zenith Data Systems provides you with reliable products from a reputable source.

ZENITH data systems
BRISTOL ROAD, GLOUCESTER GL2 6EE
Telephone: (0452) 29451

● Circle No. 255

OSBORNE I portable computer. Little used, 64k, twin disks, complete with all software, original packing and extra cables. All as new. Save £500. £800. Tel: Weaverham (0606) 853570.

OU SELF TEACH course PT502. Comprises computer, peripheral board and detailed manuals to teach you Z80/8085 assembler etc. Excellent condition £250. A. Taylor. 05097 2386.

APPLE II PLUS, 48K, TV modulator, hobbycard, many programs on cassettes, loads of mags and £30 of books. £600 or reasonable offer. Phone 0604 715554.

RAIR BLACK BOX CP/M used microcomputer. Rair maintenance transferable anywhere UK, Wordstar, Mailmerge, Datastar, Supersort, Spellstar, Calcstar, Diagnostics, BSTS, BSTAM, CBASIC, MBASIC, PASCAL MT+SPP, COBAL, PL/1, MACRO80, dBASE 2, Integrated Accounts Package includes: Stock Control, Invoicing, Sales Ledger, Purchase Ledger, Nominal & Management Accounts, Payroll. Choice of models: 3/20 64K twin floppy disk with hazeltine screen, total new list price over £8,500. Bargain £2,750. Plus VAT, or model 3/30 128K 5 megabyte 2 hazeltine screens, total new list price over £11,500 bargain £4,750 plus VAT. Tel: London, 01-486 1670 anytime.

OFFERS Invited for surplus PERTEC 9.Track Tape Transporters Model T7840/9/12.5 c/w Formatter, Interface and P.S.U. one unit cabinet mounted. one set of four items boxed. Telephone 06076-66589 day 0602-392802 evenings.

8032 SOFTWARE Wordpro 4+ £185.00. Visicalc £75.00, Petaid £145.00. Quick Sale — Buying House. Simon, Redhill (0737) 60986

V.GENIE, 48K, Monitor, £600 Software £400 AJF. 19 Clarence Road, Gorleston, Norfolk.

SPECTRUM — FED is a switching unit which eliminates the need to swap plugs when loading or saving programs £5.00. Or with switch to operate recorder via remote socket £7.50 Brainwaves, 1 Stour St., Manningtree, Essex.

"ITT 2020 COMPUTER, Palsoft 32K. Reasonable offers please. (0704) 66156 evenings".

DRAGON 32? The Scottish Dragon Club Welcomes New Members. Send £8 for membership card, free games tape, newsletter, etc... to The Scottish Dragon Club, TF, 1 Walker St., Edinburgh.

BBC SOFTWARE (A/B 16k): New Dungeon and Dragon Adventure game. £6.95. Cassette, instructions, list of others. s.a.e. Ray Curnow, 108A Napier Rd., Gillingham, Kent.

"APPLE II — Software, unused, VISIFILE £129. — VISITERM £55. Tel. 01-499 5193 (daytime) 01-543 5579 (evening)"

SORCERER 32K. Basic and Development ROM Pacs. Video Monitor. Two Micropolis Disk Drives. \$100 Box. MBASIC CP/M and Micropolis Basic. Documentation. £550 01-552 6026 (Evenings).

PET 3032 (Basic 4 ROMS) cassette, toolkit, Papermate, manuals £395; Rosemount, Romney Hill, Maidstone (37643).



COMPLETE Apple II system with 2 disk drives, colour television monitor, USCD Pascal, auxiliary 6809 processor, real-time clock, serial and parallel interface, supertalker, romplus, joystick. Standard software plus symbolic assemblers and linker. Games included Sargon, Space Invaders, Asteroids and Adventure. Excellent conditions. £1300 or nearest offer. Phone 030587-571 evenings or weekends.

TRS 80/VG Basic-Calc — Basic matrix spreadsheet program for 16K II with full instructions. £4.95. Personal Finance — allows up to 28 user defined accounts, standing order payments etc. £4.95. Both for £8.50. D. Gariun, 23 Fieldway, Liverpool L15 7LU.

ANADEX DP9501 Line Printer. 120 cps. 15.6 inch paper. High density graphics. Currently connected via Centronics interface to Apple II. Printer stand. Ribbons. £1,080 new. Hardly used. £595.

"VIC/540 Single Disc Drive. £300 or offer. Brand New. Tel. (044-484) 583"

APPLE II disk drives. Bargain at £400 + VAT & postage for two units including control card. Tel. 077-473 3714.

DRAGON-32 SOFTWARE. Business software from £9.95. Educational & games from £2.95. S.A.E. appreciated. MISTRY MAGIC (PC), 75 St. Margaret's Road, Bradford BD7 2BY.

COLOUR GENIE SOFTWARE. Business software from £19.95. Educational & games from £4.95. S.A.E. appreciated. MISTRY MAGIC (PC), 75 St. Margaret's Road, Bradford BD7 2BY.

WANTED — Cromenco System Three — telephone Mike Lawrence 0734 587661 (day) or 0784 61033 (evenings).

PET 32K (3032) — nearly new. Includes cassette and software e.g. Invaders, Chess, Draughts, Debug, Disassembler and Pet pro. Also magazines, books and homebrew sound box. £520. Phone Ian Findley 01-732 9015 (home) 01-732 9836 Ex. 31 (wk).

COMPUTER. PET 32K. Professionally maintained. Business keyboard. Games and Word Processing available. £400. Tel. 01-570 5783.

Z80 ASSEMBLY Programming lecture notes. 10 available at £3.00 + p&p each. TRS80 level 2, offers invited. Tel. 0827 59572.

PET 8096. Disk drives 8050. Olympia Daisy Wheel Printer and Silicon Office. Little used. Surplus to requirements. £2,600 o.n.o. Tel. (0295) 66555/50796.

SHARP MZ-80K. 48K Integral VDU + Cassette. Games and Business Software. Little used. £350 ono. Tel: 021-705 1659.

INVERSE CHARACTERS for hi-res TRS-80 model one. Highlight your display for £4.50. Dundee (0382) 739251.

FOOTBALL POOLS PREDICTOR for BBC micro, A or B. uses unique mathematical and statistical forecasting methods. On cassette with full instructions, £4.99. MAYDAY SOFTWARE, 181 Portland Crescent, Stanmore HA7 1LR.

AIM-65 On-board printer, display, timers and I/O Lines plus 4K Ram, Basic and VDU board. Some utility programs on prom. Phone Chelmsford 351704

APPLE II + 48K, Apple Pascal System, BMC Green Screen, DOS3.3 drive, Epson MX-FT/II (Graphics) and Tymac Parallel Interface, All in original boxes. £1500 — Royston 46484 (evenings).

SOFTY II Hardly used 5 months old complete with TV bargain £149 + vat Tel. Horsham 51366, 12-1pm, Mr Doo

APL? It's the only modelling tool for me!



'Financial Analysts need the power of APL with the simplicity of PPL to do their modelling work.

Nothing else comes close and I'd be hard pressed to even imagine trying to do so.'

WHAT IS APL?

APL is a concise programming language which has achieved great success in the larger firms and institutions. They have long discovered that APL is the answer to using the computer as a problem-solving tool with an economy on programing time which programmers in conventional languages do not believe until they've seen for themselves.

WHAT IS PPL?

PPL - *Personal Programming Language* - is a brilliant new package, written in APL which enables the novice or experienced programmer to quickly exploit the strengths of APL painlessly. PPL is suitable for anyone, and you will never outgrow it.

WHO IS A.P.L.?

A.P.L. (Alan Pearman Limited) is a firm, established in 1977, dedicated to APL, especially on the micro. We were the first firm in the UK to bring APL on the Z80 and thus within the reach of many thousands for whom APL had been inaccessible. Now we sell APL on many machines, using Z80, 8088 and 68000 processors. As well as hardware, we run APL courses regularly, sell APL books, and do APL consultancy. Our package, PPL is the latest and most comprehensive of our applications software which has included database, statistics, wordprocessing, and communications, among others.

HOW TO FIND OUT MORE:

A comprehensive and well-written guide is available, price £25.00 plus £1.00 p & p, describing PPL. Send off for it today and be amazed at the power that you can get from this package. Payment by cheque welcome or Visa accepted.



The system illustrated is an IBM PC with high resolution colour screen, with 576K RAM and APL, this costs £3850.

The Columbia PC, a superior IBM look-alike, gives you far more RAM for the same price, as well as other extras.

We also have Z-80 machines running APL. Please enquire for the current position.

Alan Pearman Limited

Maple House, Mortlake Crescent, Chester CH3 5UR Tel: Chester (0244) 46024

Bringing personal computing to all

● Circle No. 223



All-In-One

Exceptional desktop computer power with a flexible and expandable system to meet the business needs of today and tomorrow!



Low Profile

The 16-bit Micro

EuroMicro™
SYSTEM Z100

with 8-bit compatibility AND COLOUR GRAPHICS

EuroMicro's new desktop computer system runs CPM-86 and CPM-80/CPM-85 programs. Manufactured for EuroMicro by Heath-Zenith, the Z100 offers:
From **£1,895**

Microprocessors
8088 for 16-bit power
8085 for 8-bit compatibility
Memory
128 Kb expandable to 768 Kb
Storage
320 Kb to 10 Mb (floppy and Winchester disk)
Operating Systems
CPM-85, CPM-86, MSDOS
Multi-user
Up to 8/10 terminals
Graphics
High resolution 640 x 500 pixel
Colour
High definition 8 colour pixel

Communications
2 RS 232 ports, expandable to 10, and 1 parallel port. (IEEE 488 available soon)
Signetics 3661 chip ensures hardware compatible communications with most mainframes
Expansion
IEEE S100 BUS/5 Slots
Power supply
300W switched mode; ensures high stability and regulation
Application Software
Word processing, financial modelling, business management, integrated accounting — all from leading software houses, including PEACHTREE

EuroMicro's ANSWER TO HIGH PERFORMANCE AND flexibility

EuroMicro™
SYSTEM M8/16

- 8088 8MHz for CPM-86/MPM-86
- 8085 5MHz for CPM-80/CPM-85
- 10 MHz Static Memory
- IEEE S100/20 slots
- MPM-86
- CPM-86
- CPM-80
- Disk options 5" or 8" floppy or winchester
- Options include:
IEEE488 interface
ADDA
EPROM blowing/emulation
Colour graphics

WE'VE been quietly busy developing a range of computers that will allow rapid development of software for CPM-86. The EuroMicro M8/16 will support up to 7 CPM-86 users in an MPM-86 environment.

AND

For those who have an investment in CPM-80 software, we've thoughtfully provided a second processor to run CPM-80 programs as well. **IN FACT** you can run any combination of up to 7 CPM-80 and CPM-86 tasks simultaneously, each user having their own environment.

For details call **01-341 2447**

EuroMicro™

EuroMicro Limited
EuroMicro House, Coleridge Lane, London N8 8ED, England
Telephone: 01-341 2447

A true Multi-user Multi-tasking Microcomputer housed in an attractive 20 slot Mainframe with many possible IEEE S100 options.

Ideal for the development of CPM-86 programs for the large number of table top computers based on the 8088/8086 processors.

From **£2,995**



Prices shown are exclusive of VAT