

Practical Computing

Win a
£1,000 +
RML 480Z outfit

35p March 1984
Volume 7 Issue 3

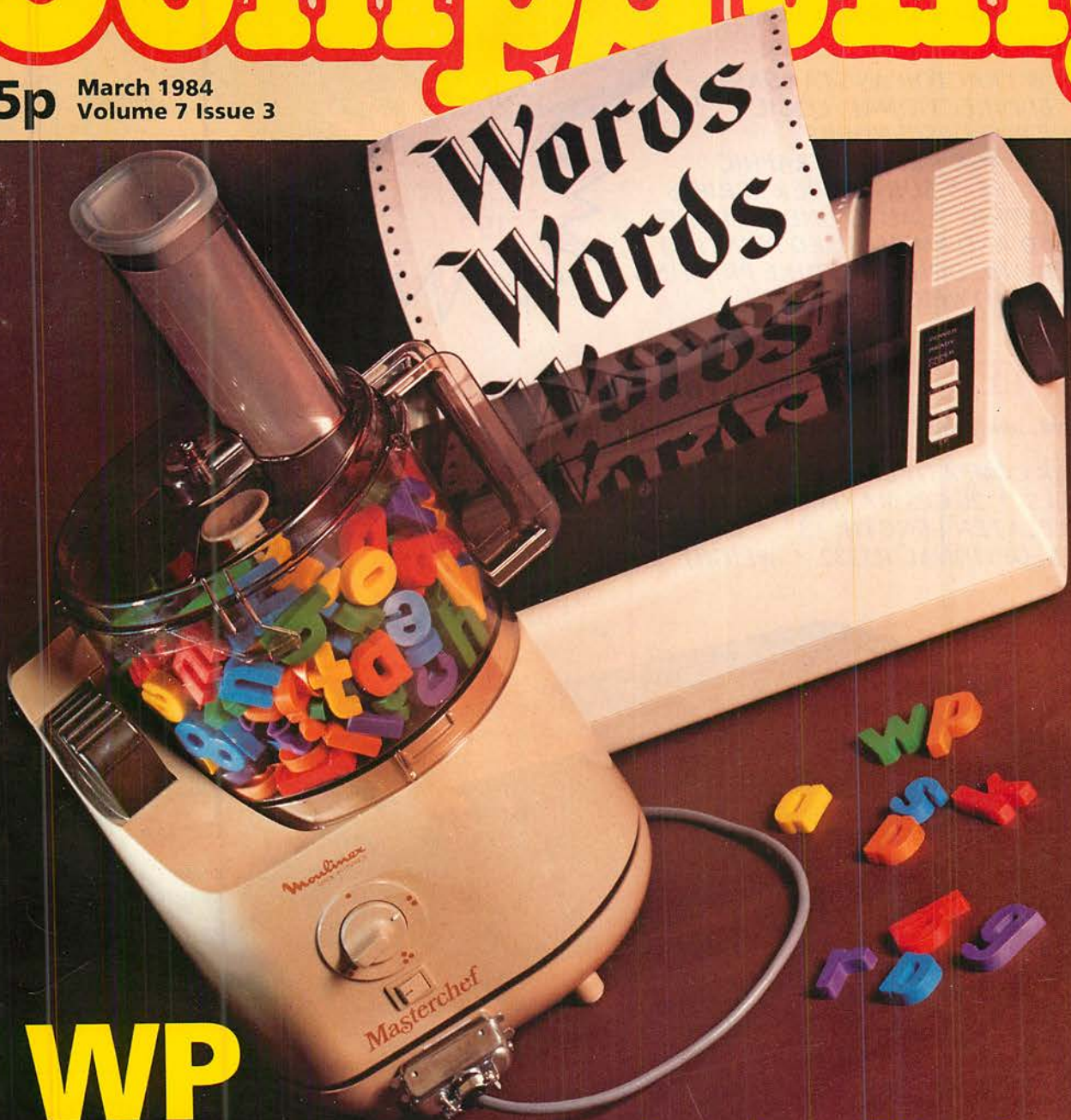

W/P

Packages for home, school and business

**Previews – Apple Macintosh, Sinclair QL
Graphics routines for the Commodore 64**

BBC text editor IBM PC W/P Atari games

Oz Expert systems Top 10 portables

Denmark DKr34.50, Greece Dra 245, Holland DFL8.50, Italy L4100, Spain Pts 360, Switzerland SFr7.40, Germany DM8.50, France Fr32.60, Canada C\$4.50, Australia A\$3.00, Singapore M\$6.35, USA \$3.95(D72162)

LIST

RML
competition
on page 103

PRACTICAL COMPUTING

MARCH 1984

>NEWS

13 HARDWARE NEWS
Even more new micros, with offerings from Motorola, Microdata, ITT and many other firms.

21 SOFTWARE NEWS
Zilog puts CP/M on chip, and Acorn offers a cassette-disc exchange service.

29 PRINTOUT EXTRA
Book publishers are moving into software. Glyn Moody looks at which, and why.

>FEATURES

103 £1,000 RML 480Z COMPETITION
You could win a complete Research Machines outfit worth over £1,000 including software.

114 FICTION MINDPROBE
Michael Abbott looks ahead to a future where computers can see into the human mind.

118 TEXT EDITOR FOR THE BBC
A program by Peter Hodson which transforms your BBC Micro into an intelligent typewriter.

122 COMMODORE 64 GRAPHICS — PART 1
Boris Allan's series provides graphics routines and support for Basic programmers.

127 TOP 10 PORTABLES
Ian Stobie reviews the most interesting developments in battery-powered lap computers.

130 A WALK IN XEROX PARC
Christopher Roper visits the Palo Alto Research Center where Lisa-like systems were first developed.

>REVIEWS

88 MACINTOSH — THE LITTLE LISA
Ian Stobie tries out Apple's affordable version of the mighty Lisa.

96 THE AMAZING UNITRON 2000
Roger Cullis checks out a £389 Taiwanese micro which offers both 6502 and Z-80 processing.



100 RESEARCH MACHINES 480Z
RML's business-like new micro and software package brings real software like WordStar to the classroom

104 NEW £399 QL — THE ULTIMATE SINCLAIR
Jack Schofield previews Sinclair's 68000-based home/education and business micro.

106 OZ
A development of the spreadsheet technique tailored for management accounting, assessed by Glyn Moody.

108 NEW EXPERT-SYSTEMS SOFTWARE
Expert Systems expert Chris Naylor compares Hulk, a £25 package for the BBC, and the £1,738 Expert Ease for the IBM PC.



134 ATARI GAMES
The best selection of games ever reviewed in *Practical Computing* . . . but don't look at the prices.

177 COMMODORE BOOKS
Mike Todd's selection from the torrent of books on the 64 and other Commodore micros.

>WORD PROCESSING

51 WP FOR HOME, SCHOOL AND OFFICE
Glyn Moody summarises the development of word processing through Homeward, Edward and WordStar, while Jack Schofield takes a closer look at America's best selling Bank Street Writer.

56 IBM PC WP 1: TRENDTEXT
A powerful British program available for most eight-bit and 16-bit micros.
2: WORDPLUS PC
Paul Myerscough tries the package that claims to be the easiest to use.
3: MULTIMATE
This sophisticated American program emulates a Wang-style dedicated word processor — the ultimate?

64 A FISTFUL OF PACKAGES
A selected listing of some of the hundreds of word processors, and where to find out more about them.

>REGULARS

5 EDITORIAL — THE RIGHT TO BACK-UPS
Copying and piracy — the thin end of the wedge in *PCW*'s climb-down.

7 FEEDBACK
Readers' letters — a round-up of suggestions, corrections and complaints.

35 CHIP-CHAT THE BIG MATCH
Ray Coles on chips that compare text strings.

38 SOFTWARE WORKSHOP
Mike Lewis offers advice for handling screen messages.

145 OPEN FILE 146
Free software listings for the Apple, BBC, Commodore, Tandy, Research Machines and IBM PC.

189 LAST WORD — THE FIFTH GENERATION
Christopher Roper ponders on the march of progress in AI.

**COMPUTER
DEALERS!**

BITTEN OFF LESS THAN YOU CAN CHEW?

• multi-user
systems with
• **UNIX**
system V

You'd be doing much better with a fast selling system to really get your teeth into?

You're selling personals but need a really good multi-user system at the top end? . . .

or may be you're selling mini systems and need a high performance well priced alternative?

YES, YES, YES!

Then we've got just what you need to cure product starvation. We'll also help you grow fast and increase profitability margins.

Take a good look at Alpha Micro:

- 7 Terminal table top system AM1000
- 30 Terminal AM1042E ● 40 Plus Terminal AM1092 ● compatible software through the range ● best operating system in its class ● excellent dealer margins ● all the support you'll ever need

ALPHA MICRO

We eat Apples for Breakfast

***Call Alpha Micro Dealer Manager, Laurie Bright,
on 0753-821922 for the full story.***

Alpha Micro GB is the wholly owned subsidiary of Alpha Microsystems of Irvine, California.

*Alpha Microsystems (GB) Ltd, Berkshire House, 56 Herschel Street,
Slough, Berkshire Telephone: 0753-821922*

*Alpha Microsystems Belgium, Chaussee de la Hulpe 130, Box 14,
1050 Brussels, Belgium Telephone: 660 5093/5094*

**Become an
Alpha Micro dealer now
and start chewing up
the competition**

LONDON COMPUTER CENTRE

NEC ADVANCED PERSONAL COMPUTER

16 bit 8086 128K RAM
2.4 Mb Disk storage
CP/M86-MSDOS
Green Screen
Colour Display



£1,985
£2,595



apricot

256K RAM 16 Bit
Nearly £1,000 Software included
from £1,495

SIRIUS 1

1.2 Mb Disk storage £2,395
2.4 Mb Disk storage £2,895
10 Mb Disk storage £3,995

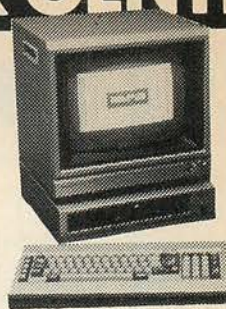

NEW!

**SANYO
555
£999**

16 bit 129K Expandable
to 256K. MSDOS. 2 Drives
£1,200 software included
(Wordstar, Mailmerge, Spellstar, Supersort,
Datatar, Reportstar, Calcstar)

SANYO 550 £799

MSDOS One Drive
Software included worth £500
(Wordstar, Calcstar)

LCC SPECIAL BUNDLE

NEC APC RRP £1,985
NEC Dot Matrix Printer RRP £395
Benchmark WP Software RRP £311
Cables RRP £30
£2,721
you pay £1,985
you save £736

COMPUTERS

EPSON QX10 £1,735
TANDY 4 from £1,299
TELEVIDEO 806/816 PHONE
SUPERBRAIN PHONE

PORTABLES

CORONA PC
IBM PC Compatible
256K RAM
Twin Drives £2,295
ZORBA with free 12"
Monitor. Software
worth £800 included £1,395

LAP PORTABLES

NEC 8201 16K £475
EPSON HX20 16K from £402
TANDY 100 8K £433

DOT MATRIX PRINTERS

STAR DELTA 10 160cps £359
GEMINI 10X 120cps £219
EPSON FX80 160cps PHONE
" FX100 160cps PHONE
" FX80 160cps PHONE
" FX80FT 100cps PHONE
NEC 8023 100cps £375
TOSHIBA 2100 £1,130
CANON PT1080A Colour Printer £453

DAISYWHEEL PRINTERS

FLOWRITER 1600 £1,600
TEC F10 40cps £1,350
TEC F1500 £450
JUKI 18cps £399
UCHIDA 18cps £399

SHEET FEEDERS

BDT 3 Tray Auto £695
BDT Single £375

HARD DISKS

Hard Disks for IBM PC
Sirius QX10, NEC
10 Mb £1,545
15 Mb £1,695
20 Mb £1,995
20 Mb Tape Streamer £1,495

PLOTTERS

HEWLETT-PACKARD 7475A
6 Pen colour £1,447
HEWLETT-PACKARD DXY 800/101
6 Pen colour A3 £520
PIXY3 3 Pen colour A4 £599
SWEET PEA 6 Pen colour
HP7475A Compatible £995

MODEMS/MONITORS

Buzz Box. Direct Connect Modem £65
Sendata Acoustic Coupler £220
Philips 12" Green. Hi Res £75
Taxan 12" RGB Hi Res for IBM £399

ACCESSORIES

Floppy Disks Printer Buffers
Daisywheels Paper
Ribbons Labels
Cables Computer cleaning kits
Disk containers

SOFTWARE 8/16 Bit

The comprehensive range includes

WORDSTAR £235	D BASE II £349
SUPERCALC II/III £190/£275	SPELLING CHECKER £80
WORD PROCESSING £	LANGUAGES £
Spellbinder 290	MBasic 215
Peach Pack* 332	MBasic Compiler 235
Multimate 332	C Compiler 330
Spellstar 134	Fortran 80/86 325
Maillist 50	Cis Cobol/Forms2 399/105
Grammatik 85	Pascal MT+ 240
FINANCIAL PLANNING	Pascal MT+*SSP 350
Plannercalc 85	ACCOUNTING
Multiplan 170	Pegasus from 250
Lotus 1-2-3 357	Peachtree from 325
D BASE CORNER	Sage 375
FastBase 150	Exact 500
Autocode 195	Pulsar from 195
Quickcode 205	COMMUNICATIONS
Dgraph 190	Bstam 130
Friday 185	Crosstalk 135
Infostar 266	Moveit 80/86 90
DMS 400	*Incl. PeachSpell/Maillist
UTILITIES	Please telephone for the LCC
Sid £60, ZSid £76,	Software Catalogue
Mac £133	

FORMATS: Superbrain, Televideo, Sirius, Sanyo, Osborne
Northstar, 8" SD, DEC, Epson QX-10, IBM
ICL, H-P, XEROX, ALTOS, Apricot, NEC-APC & many more
All prices are exclusive of VAT

New! The fast and easy way to generate your own dBase 11 Applications programs - use fastBase. £150.

- * only fastBase allows 7 index files per data base, all others allow 1 index file
- * only fastBase allows report generation on 3 files others 1 file
- * fastBase Structures Command files with indentations allowing maximum speed in execution
- * fastBase uses a series of on-screen prompts and Help Menus to lead you through the process of generating your own dBase 11 Command files.

Dealer enquiries invited
on all products.

**DEMONSTRATIONS
SALES-SERVICE
SUPPORT**

43 Grafton Way, London W1P 5LA (Opposite Maples)

Opening Hours: 10-7 Mon-Fri. 12-4 Sat.

01-387 4455 (4 lines) Telephone Answering Service After Office Hours

Telex: 8953742

Legislation letdown

THE RECENTLY PUBLISHED Green Paper on Intellectual Property Rights and Innovation offers cold comfort to those who were looking to Parliament for legislation to protect the computer industry from the ravages of software pirates. Apart from a gratuitous insult to the teaching profession, which is roundly accused of inciting pupils to copy proprietary programs, and a brief mention of the desirability of using patents and registered designs as a national database, the annual theft of, according to some estimates, £700 million worth of software is dismissed with the comment that "specific adaptation of the existing system could be made if felt warranted".

At present software writers who seek a remedy in the courts are setting sail in uncharted waters. The need to interpret existing laws such as the Copyright Act, 1956 and the Patents Act, 1977 which were intended to protect something quite different, means that the outcome is far from certain. Since the cost of a High Court action is counted in tens of thousands of pounds, small software houses are, not unnaturally, reluctant to embark on litigation.

A barrier to early legislation is that the problem is an international one. For an effective solution to be devised, there will have to be a multilateral agreement, similar to the Berne Convention on copyright. Although there are moves by private members to introduce a bill in Parliament, without Government backing these seem doomed to failure.

Roger Cullis,
Cranleigh,
Surrey.

Date and algorithms

ONE REASON why the Apple II microcomputer has been so successful as a business and scientific machine is VisiCalc, the original spreadsheet program.

The key concept in a spreadsheet is the idea of a table of entries, where certain entries in the table are arithmetically related to other entries. A typical application is the working out of financial projections.

The success of VisiCalc has spawned other members of the Visi family but one drawback to VisiCalc is that it cannot interface to other programs one might wish to use unless extra packages are purchased. There is not any way in which tabular data produced by ordinary programs can be directly

interfaced to VisiCalc. It is always possible for the data produced by another program to be used by VisiCalc, if you are willing to enter the data by hand.

I have written some batch programs in Fortran which performed extensive manipulations of large sets of data, and produced tables of results as disc files. These disc files were then read by Basic programs, to allow interactive examination.

Fortran was used because it was best suited to taking large sets of data and speedily performing complex floating-point calculations.

I used Basic because it was the only interactive language available on-line, and because, for small sets of data, such as tables, in an exploratory analysis, it was sufficiently flexible.

The point is, if microcomputers have a place in more

serious large-scale applications, there have to be systems which will allow traditional data-processing — large volumes of data, and fixed algorithms.

To claim that spreadsheet programs — small amounts of data, and changing algorithms — solve data analysis for microcomputers, is not sensible. There now seems to be an industry created to convert files to VisiCalc Dif format, indicating the tendency in microcomputer software to create user-dependency, and forget standards.

Boris Allan,
Stockport,
Cheshire.

Pace and panache

L SHANNON — see Feedback, January 1984 — did not get on his Spectrum the hoped for "pace and panache" of John Hooper's suggestion for replacing Gotos by For-Next loops.

The reason is that in Sinclair Basic the return from Next to the beginning of the loop is achieved by exactly the same mechanism as Goto — searching through line numbers from the beginning until the right number is found; and, on the Spectrum, a further search for the right statement in a multi-statement line.

To get the pace and panache you need a Basic interpreter, such as Microsoft, that provided an absolute address for a Next to return to.

W E Thomson,
Aldeburgh,
Suffolk.

Buying for business

I READ the article by Lionel Moon in your January issue with amazement. I cannot believe that he has any idea about business microcomputer systems.

Is he seriously suggesting that all the market leaders in the U.K. are wrong because IBM, Sirius, DEC, Commodore and Apple do not sell systems based on the S-100 bus and 8in. drives? Both of these went out

with the dinosaur. In fact the major manufacturers are moving to 3.5in. drives.

His remarks about the benefit of buying expandable systems are correct but our experience of selling over 1,000 micros during the last three years suggests that 95 percent of people want a single-user system; the fact that there is almost no networking software for any of the common systems seems to have escaped him. Multi-user micros themselves are often extremely slow and as such almost impossible to use in business.

On his recommendations for printers I can only say that he has obviously never tried to print out 200 statements at the end of the month on a daisywheel. There is no such thing as the best choice printer, it all depends on the application and most of the time a dot matrix is the better choice.

The only useful paragraph is the one recommending the choice of the software first. I cannot understand why people want to buy an updatable system; if you update it the chances are that your software will not run and you are still paying for the first system anyway. If you want to buy a micro you must plan to use for two or three years.

Why did you publish such a load of rubbish? The market is confused enough without Lionel Moon's ravings.

D Saunderson,
KGB Micros Ltd,
Windsor,
Berkshire.

Illogical twaddle

RARELY, if ever, have I seen such a lot of illogical twaddle in an otherwise high-quality journal as January's Last Word by Danielle Bernstein.

I do not doubt that her basic premise is correct. Micro adverts are sexist; so too are most others. Her selected examples and style of writing do little to substantiate her case and instead reveal far more about her own prejudices. To cite a few examples:

- I have checked several newsagents for the display of magazines and cannot find any consistent evidence for her assertions.

(continued on next page)

Our Feedback columns offer readers the opportunity of bringing their computing experience and problems to the attention of others, as well as to seek our advice or to make suggestions, which we are always happy to receive. Make sure you use Feedback — it is your chance to keep in touch.

(continued from previous page)

- She tells us that the word "mistress" does not, at first, suggest to her the opposite of "master". It does to me. This statement serves only to reveal her preconceptions.
- She says that Virgin Games is so named as to deliberately degrade women. What about all the other meanings of the word; especially as an adjective? The fact that the company sells games to boys is irrelevant to her contention.
- Her most amazing claims concern the Acorn advertisements. She tells us that "the stereotype is that men are supposed to cooperate while women compete". What would she have told us if the pictures had been reversed? Probably that "the stereotype is that men are assertive and dominant while women are shown in a supportive role". Danielle may have a point but she cannot prove it by regurgitating a lot of unsubstantiated half truths. The available information should provide ample evidence for a more academically sound analysis.

Peter Amey,
Salisbury,
Wiltshire.

Computer ignorance

I WOULD like to reply to Danielle Bernstein, "The invisible woman", *Practical Computing* January issue. I think the advertisers are seeing the market realistically — the woman is almost invisible. The computer industry was growing up at the same time as women's rights and women had as much chance as men to become a part of that industry. However,

many women did not take this opportunity, so men are still the decision makers.

I recently went to a computer fair (ugh) where most of the schoolgirls seemed more interested in congregating in the toilets to smoke while the boys played with the computers. The so-called experts on the stands were mostly men while the women handed out leaflets.

I have also been to business computer exhibitions and seminars where women were very much in the minority. On these occasions men carefully explained to me in words of one syllable how word processors worked but generally handed out leaflets when I asked about spreadsheets and accounting packages etc. On one memorable occasion a representative on a stand was spending a lot of time explaining to two men how a particular spreadsheet worked while another representative said that they only had an automatic demonstration and proceeded to read a pamphlet to me.

I feel that it is not until more women get themselves into the computing industry that this situation will change — but women are their own worst enemies. While talking to a friend recently on the telephone I mentioned that when I had finished talking to her I was going to spend some time on our home computer. She said, "Oh, I haven't got time to play games". Who's playing? Whilst in full-time employment I worked in a large computing department and am now trying to start my own computer-based company. So until more women show an interest in computers they are going to be treated as computer-ignorant, because that is exactly what they are.

Christine E Argyle,
Mijdrecht,
Netherlands.

Commodore 64 compatibility

I WOULD BE SORRY if potential buyers of the Commodore 64 were put off by the write-up in the November issue of *Practical Computing*, especially by the statement that the Basic "is incompatible with all others, including Commodore ones".

I bought a Commodore 64 simply because programs are very largely interchangeable between the 64 and the 8032 which I use at work. The only problem I have found is with Peeks and Pokes, but these I use rarely, and it is a simple matter to write a routine which asks "Is the computer a 64?", and then sets variables for the numbers accordingly.

A program saved on tape from the 8032 loads and runs without difficulty on the 64. When running a program saved from the 64 into the 8032, there is a slight difficulty in that it is loaded starting at address 2049 when the 8032 expects to find it at 1025. My system is to power up the 8032, type 0 Rem

Figure 1.

```
*** commodore basic 4.0 ***
31743 bytes free
b*
pc irq sr ac xr yr sp
.: 0005 e44f 30 00 5e 04 f8
```

Figure 2.

```
*** commodore basic 4.0 ***
31743 bytes free
b*
pc irq sr ac xr yr sp
.: 0005 e44f 30 00 5e 04 f8
.m 0401 0401
.: 0401 07 04 00 00 0f 00 00 00
```

Figure 3.

```
*** Commodore basic 4.0 ***
31743 bytes free
b*
pc irq sr ac xr yr sp
.: 0005 e44f 30 00 5e 04 f8
.m 0401 0401
.: 0401 01 00 00 00 0f 00 00 00
.x
Ready.
```

followed by Return, and then load the program from tape. Next, I enter the monitor by typing Sys4, which gives me a display as in figure 1. I display the contents of the start of the Basic program by typing m 0401 0401, and get the display in figure 2, which shows a link to two zero bytes, indicating end of program. Using the cursor controls, I alter the first two numbers to 01 08, not forgetting to press Return, and finally type x followed by Return to get back into Basic — see figure 3. The program is then listed, line 0 is edited out, and the program runs perfectly.

To me, one of the best points about the 64, as with the 8032, is the ease of editing lines. If only other manufacturers would use an editor so user-friendly.

R Pidgeon,
Wotton under Edge,
Gloucestershire.

BBC software

IN YOUR review of BBC software — September 1983, page 138 — you state that for most versions of the game, extra lives may be obtained by adding the line

42 ? & FDD = 6

where 6 is the number of lives you want. Users of the old version of Snapper — that is, the one with ghosts instead of the goggle-eyed Martians shown on page 135 — will have found that this produces a very odd effect.

The correct line for this version is

42 ? & FD1 = 6

The maximum number of lives obtainable by this method appears to be 128, which should be enough for anyone to reach the mystic Acorn.

Angus J Rodger,
Monmouth,
Gwent. 



It looks like any other personal computer.

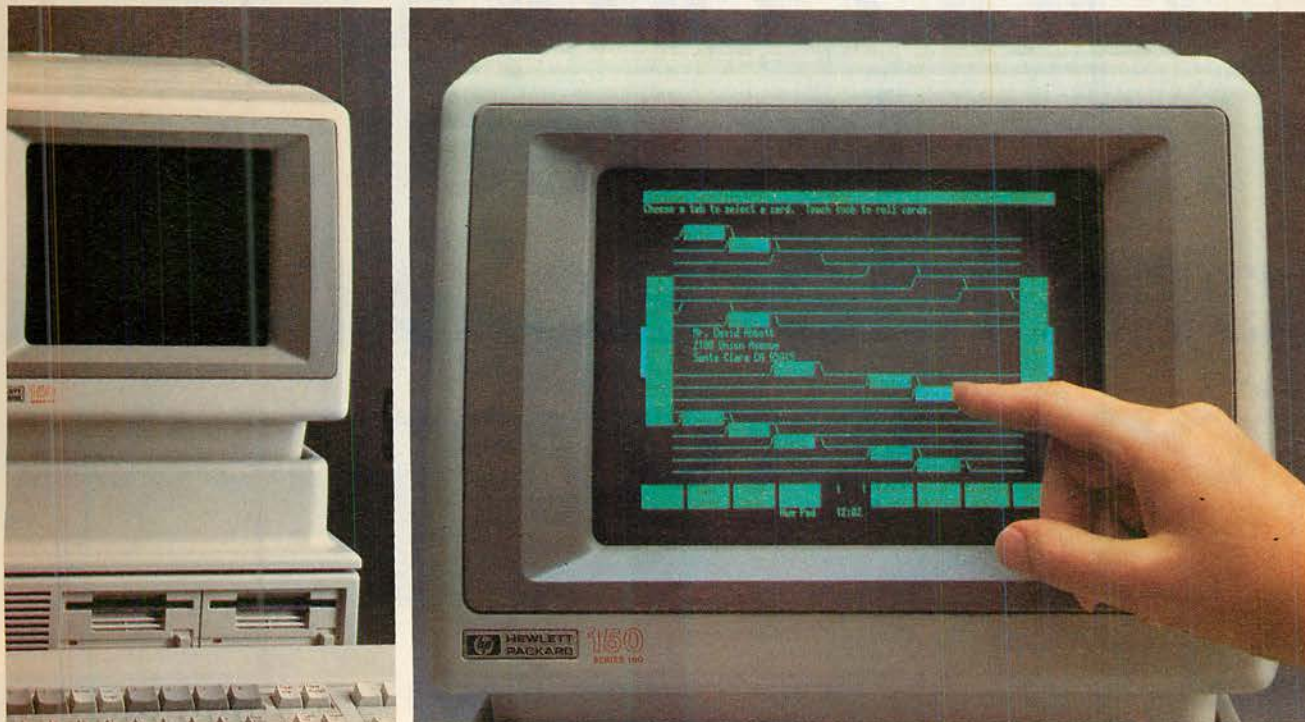

Until you touch it.

The HP-150 Touchscreen personal computer. The most practical personal computer in the world.

Switch on. The unique, plain-language touchscreen tutor invites you to select the application you need. Choose the personal card file, for instance. Just touch the screen and remove your finger.

Then watch the high resolution screen for that address to unfold before your eyes—magically, effortlessly.

It's the same with editing. Point to the screen to move a whole paragraph or a single word on a letter or memo.

The action is so simple with touch, that mistakes are less likely than with the traditional keyboard operating systems.

For the first time, you can compose or revise your presentation documents with-

out memorising complicated word-processing codes.

One touch will alter a forecast on the electronic spreadsheet analysis. Another will turn your figures into a pie or bar chart.

The HP-150 operates on the industry standard MS™/DOS®. So you have a wide range of proven software applications, including specialist business packages like graphics, accounting and integrated solutions.

And is there a keyboard? Of course. A full keyboard, designed also to give you the option of managing the HP-150 on keys alone.

You'll probably find our screen hard to resist, though. And we suspect that once you touch it, you'll never touch any other personal computer.

Get in touch on 0734 696622 ext. 4252.

HP 150 at a Glance.

User Memory:
256K-640K bytes.

Operating System:
MS-DOS 2.0.

Microprocessor:
16 bit, 8088, 8Mhz.

Permanent Memory:
(ROM) 160K bytes.

Diagnostics:
Power-on self-testing.

Display Screen:
Touch-activated, green phosphor
80 characters x 27 lines
9 x 14 character matrix
Upper and lower case
Simultaneous text and graphics capability
390v x 512h graphics resolution
1024 characters and symbols in ROM

Keyboard:
107 keys, 8-ft. cord attaches to system unit, 10-key numeric pad, 12 function keys (8 screen labelled)

Compact Size:
2.1 sq. ft. desk space

Communications:
2 RS-232 ports (Built-in)
HP-IB (IEEE-488) (Built-in)
IBM 3278 (SDLC, BSC), early 1984
Up to 19,200 bits per second

Peripherals:
Choice of printers (including optional internal printer), plotters, 3.5" floppy drives (264KB formatted), Winchester hard discs (5 and 15 MB).

*MS™/DOS is a trademark of Microsoft Corporation.

 **HEWLETT
PACKARD**

● Circle No. 104

Whatever computer you buy, it's bound to leave something to be desired.

But with the LSI Octopus, you can add just what you desire afterwards,

merely by slotting a board in the back.

Even if you only come to realise you desire it years after you decide on the computer.

Our computer leaves considerable room for improvement.

Room for graphics board.

Room for telecommunications board.

Room for RAM expansion board.

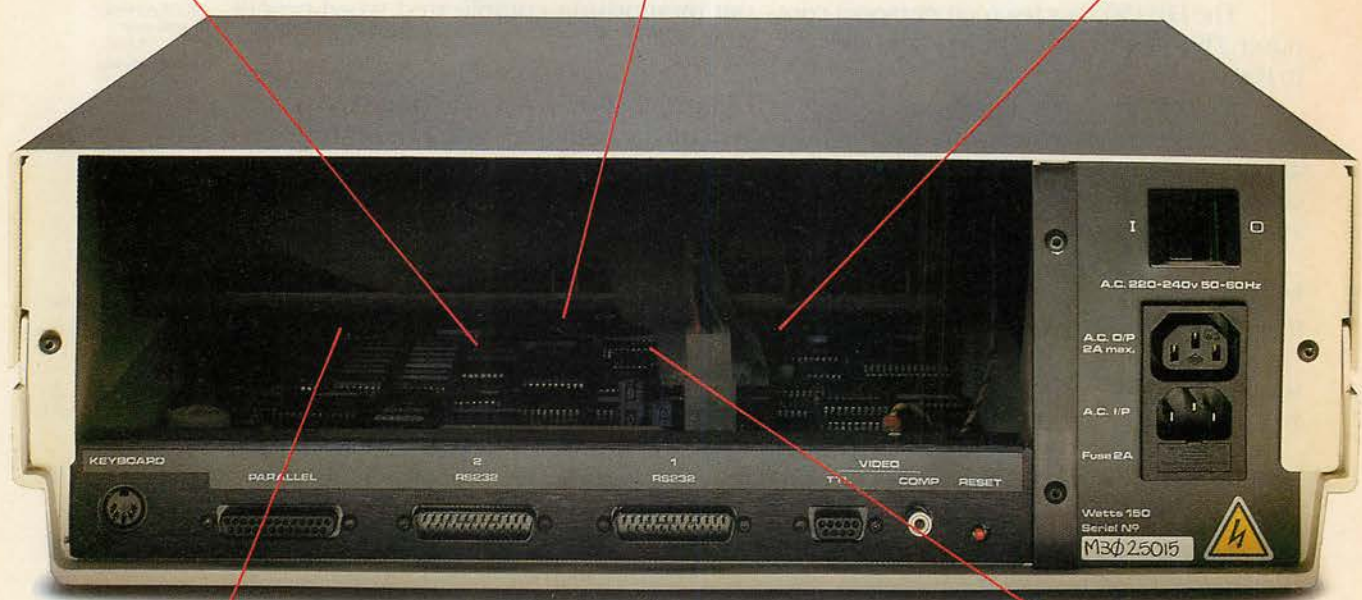

Room for network board.

Room for..? Still on the drawing board.

More importantly, you'll be able to use all the facilities in the future which you can only imagine today.

In the captions opposite are examples of what the five option boards available now and now can offer you.

From simple memory expansion to the most sophisticated full-colour graphics.

But these are by no means the only options open to you.

Your starter for £1500.

For around fifteen hundred pounds you can opt for an LSI Octopus system at its simplest.

The central computer with one disc drive and a 109-key, fully-programmable keyboard.

Any standard TV set can be used as a monitor.

Even on this version we've included features like direct memory access, colour and a real-time clock.

A couple of thousand pounds would buy you a fully-fledged business computer system, including two disc drives and a high resolution monochrome monitor.

For another thousand pounds or so, you could choose a system with the extra speed and capacity of a Winchester drive.

Sooner or later, you'll want to plug in more terminals, so that more people can use the computer. Ultimately, you may even use an option board to set up a whole LSI Octopus network.

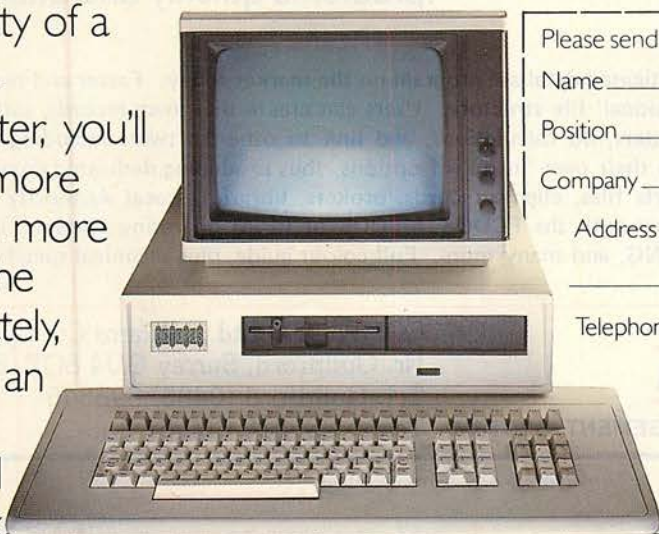

Free 'Axis'.

Though you'll need to plan for the future, here's a present we'll give you right away.

'Axis'

Free with any but the most basic kit, it represents over a thousand pounds worth of software.

Capable of keeping your purchase, sales and nominal ledger, it would almost certainly be the first package you'd have to buy.

And like all our software, it's designed with the thought for detail that makes for real convenience and efficiency.

Software from elsewhere.

For more specialised tasks, there's plenty of business micro software on the market these days.

Virtually all of it is quite acceptable to our computer.

Including both the tried-and-tested 8-bit software and the 16-bit material that will offer the faster programming of the future.

Another instance of our leaving considerable room for improvement.

Please send me details of the LSI Octopus computer system.

Name _____

Position _____

Company _____

Address _____

Postcode _____

Telephone _____



The growing business computer.
LSI Computers, Copse Road, St. Johns, Woking, Surrey G21 1FX.
Telephone 04862 23411 PC/5/84

COMPSOFT

THE EVOLUTION OF DATABASE MAN



From the beginning of time man has been fascinated by his inability to solve even his simplest problems ...



As man's knowledge grew, so did his problems ... and so did his inability to solve them ...



And man's knowledge was vast. – And so were his problems. But he was no nearer solving them ...



From the beginning of **Delta**, man has been fascinated by his ability to solve even the most complicated problems quickly and effortlessly.

Delta is the most comprehensive and sophisticated database program on the market today. Faster and more powerful than ever before, Delta offers a unique 'three dimensional' file structure. Users can create their own records, sort, select, print reports, labels and print automatic personalised letters, do calculations, and link to other software including Lotus 123, Multiplan, Wordstar, Peachtext, etc. Users can design their own 'menu' of options, thus producing dedicated database systems. Delta is perfect for stock recording, personnel, parts files, clients records, brokers, libraries, Local Authority records, etc, etc, etc. Available for most business microcomputers with the PCDOS, MSDOS or CP/M operating systems, including the IBM PC, SIRIUS, APRICOT, XEROX, EPSON, WANG, and many more. Full colour guide, plus technical specification free on request on Guildford (0483) 898545.



DELTA

COMPSOFT DATA MANAGEMENT SYSTEM

COMPSOFT Ltd., Hallams Court, Shamley Green,
Nr. Guildford, Surrey GU4 8QZ, England.
Tel: Guildford (0483) 898545
Telex: 859210 CMPSFT

Oric refurbished

ONCE UPON A TIME this magazine described the Oric as a "smashing little micro", while bemoaning the blippy keyboard and bug-ridden ROM. With the launch of the Oric Atmos 48K as a replacement for the Oric 48K, these problems have been corrected.

Oric has given the new model a real keyboard you can type on, a new Basic ROM, a new colour scheme and a very much smarter appearance all round. The Atmos is also claimed to run most of the original Oric

software, but unfortunately it is somewhat more expensive at £170.

Oric's long-promised 3in. microfloppy disc drive, costing about £250 and holding 320K, is expected soon. When it does arrive Oric could well turn out to have a smashing little system, but at a price rather too close to that of a discounted Commodore 64 for comfort.

Contact Oric Product International at Cowarth Park, London Road, Ascot, Berkshire SL5 7SE.



Beyond Apple's Macintosh

APPLE'S NEW 68000-based office computer, named after a large variety of Californian apple, is previewed on page 88 of this issue. But the Macintosh's arrival alongside the Lisa does not mean Apple intends to abandon its eight-bit machines. To underline the point two new machines designed to plug into the Apple IIe Applesoft software base are in the pipeline. No firm details are available yet, but Apple is expected to reveal some of its plans at the Macintosh's official launch.

One machine will probably be a home micro for both work and play, along the lines of the Commodore 64. The other may be a portable. This would give Apple four eight-bit machines, with the IIe and III retained, all built around the 6502. A third advanced 16-bit machine is likely to join the Lisa and Macintosh.

Track-balls

TRACK-BALLS are the joysticks of the future according to Sirton Computer Systems. Control is effected by means of a partially hidden tracker ball suspended on a low-torque mechanism. Two-dimensional hand movements are converted into equivalent X and Y signals with fingertip precision.



Sirton's Track-Ball Cursor Unit is designed for use with any hardware fitted with a standard eight-bit parallel input. The price is £325, and further information can be obtained from Sirton Computer Systems Ltd. Telephone: 01-640 6931.

ITT Xtra

STC BUSINESS SYSTEMS Ltd has announced the ITT Xtra micro in the U.K. Claimed to be "operationally compatible" — whatever that means — with the IBM PC, this 8088-based system runs at 5MHz and has 128K RAM as standard. A typical system costs around £2,500 and a 10Mbyte hard-disc system just under £4,000.

Together with the parallel and serial ports, the floppy-disc controller is located on the motherboard, leaving five IBM-



compatible expansion slots. The system is not, however, a complete IBM look-alike. Both the keyboard and main unit are considerably squatter in design, and the tilting and rotating monitor has a 14in. diagonal screen.

Further information can be obtained from STC Business Systems Ltd, Abbey Life House, 1-3 St Paul's Churchyard, London EC4M 8AR. Telephone: 01-236 9047.

Colex 16/32

THE COLEX 16/32 is a new portable based on the 80186 microprocessor running at a nifty 13MHz, and using a VME bus structure. The entry system offers 128K RAM, expandable to 256K; further expansion beyond 1Mbyte is possible via the bus. A 68000 card allows the MS-DOS operating system to be replaced by a multi-user Unix.

The 9in. amber screen allows 85 columns by 25 lines with a resolution of 640 by 440 pixels. The standard QWERTY keyboard has 15 function keys. The system with a single 720K 5.25in. floppy and 10Mbyte Winchester will cost around £3,500.

Information from Colex (U.K.) Ltd on (0990) 23377.

Commodore

IN AMERICA Commodore has unveiled the Triple Four, said to be "more than a games

(continued on page 15)

Shorts

Televideo has announced a hard-disc computer, the Tele-XT and the TPC II, a portable version of the IBMulator Tele-PC. No details yet about U.K. releases.

Hewlett-Packard's HP-86B is available in the U.K. through Rapid Recall Ltd. This upgraded version of the HP-86A has 128K RAM as standard and a built-in HP-IB, which is essentially a superset of the IEEE bus. The price has dropped too — to £1,194.72 precisely, plus VAT. Contact Rapid Recall Ltd on (0494) 26271.

Vector 4-S is the latest version of the Vector 4. It is claimed now to be able to read IBM PC and other soft-sectored discs. The entry price is about £2,500. Information on (07535) 69375.

Cambridge Microprocessor Systems has developed a 6809 processor board for the BBC Micro. It is aimed mainly at engineering applications. For £249, the second-processor unit comes with a Tube interface. CMS is on (0223) 276791.

Chubb's compact fire-protection cabinet, specially designed for floppy discs, can withstand temperatures of over 1,000°C. The cost is £450 plus VAT. For details telephone 01-637 2377.

The Flagship...



In keeping with a long tradition of producing fine quality dot matrix printers, Epson have now launched their new flagship. The LQ-1500 is a new breed of printer, that will give you the best of both worlds. A dot matrix printer, although capable of 200 CPS in draft mode, can be set to produce letter quality at 66 CPS by simply flicking a switch.

Like all Epson products, versatility has been a primary consideration of the LQ-1500, incorporating friction feed as standard with optional tractor and hopper feed and a carriage width of a full 15".

You now have at your fingertips

all the advantages of a daisywheel machine, in terms of quality, together with the added benefits of condensed or enlarged characters and proportional spacing, plus very high speed when set to operate in draft form.

Having superb graphics capabilities and optional 8-bit parallel (Centronics) RS 232 and IEEE interfaces, the LQ-1500 has taken

its rightful place at the head of the Epson fleet of fine dot matrix printers.

Epson have been leading the field in the design and production of printers for many years. Printers that are now successfully operating in all kinds of business environments, like the ever popular RX-8C and FX-80. With speeds of 100 CPS and 160 CPS respectively, dot addressable graphics and optional tractor feed available on the FX model, these two machines are extremely reliable and widely used.

The RX-80F/T has the same

How to turn a BBC Micro into 14 lab technicians. For only £325.

As if the BBC Micro weren't already famous for its versatility, we've now taken it a step further.

14 ways to control science.

With the simple, and remarkably inexpensive addition of the Acorn IEEE Interface, the BBC Micro can control, manage and exchange data with up to 14 separate devices compatible with the IEEE 488 standard.

Which means you get the speed, accuracy and repeatability of computer-controlled operations at a fraction of the price of other systems. And without sacrificing the IEEE 488 standard.

The possibilities are limitless. The peripherals can range from a simple printer or a digital voltmeter to oscilloscopes, logic analysers, spectrum analysers, function generators, frequency meters - even a complete configuration of multiple controllers and complex equipment.

The Interface is familiar.

A Read Only Memory plugs into one of the Micro's spare ROM slots, providing the Interface Filing System, a set of commands in plain English, and in the straightforward format already familiar to those who know the Micro. (Commands can be incorporated in any language available on the BBC Micro, including the popular BBC Basic.)

More facilities.

But the BBC Micro/IEEE Interface combination gives you more than just control.

Thanks to its renowned graphics capabilities, it provides the ideal way to present experimental results in

an instantly understandable form. A second processor can be connected for even faster processing and greater memory capacity. Or the Micro can be linked into Acorn's Econet local area network.

And even more.

And with its additional 1 MHz Bus connection, the Interface can even be linked to other interfaces, including Acorn's Teletext adaptor.

Finally, because the Interface operates independently, the BBC Micro is free to perform all its other functions as well.

So you can take advantage of the ready-made programs covering education and business subjects. You can use it as a word processor. Add a disc drive. And that's only the beginning.

How to get yours.

The IEEE Interface costs just £325, matches the BBC Micro in colour and profile, and comes complete with integral power supply and file server ROM.

If you're a credit card holder, you can order the IEEE by ringing 01-200 0200 anytime.

Or 0933 79300 during office hours.

(By ringing the same number, you can get the address of your nearest stockist, or full details of the BBC Microcomputer system if you don't already have one.)

Alternatively, you can order the package by sending the order form below to: Acorn Computers, c/o Vector Marketing, Denington Estate, Wellingborough, Northants NN8 2RL.

Please allow 28 days for delivery.



Credit card holders, telephone 01-200 0200 anytime, or 0933 79300 office hours.



Technical Specifications.

PCB carrying IEEE 488 bus interface circuitry, using TMS 9914 integrated circuit.

Internal power supply.

Height 70mm. Depth 350mm. Width 210mm. Weight 2.1kg.

Colour: BBC Computer cream.

Construction: Moulded top and bottom to match BBC Computer profile. ABS injection moulded plastic.

Power in: 240v, 50Hz, 3w.

Operating Temperature: 10° to 35°C.

Designed and manufactured to comply with BS415 Class 1 standard.

To: Acorn Computers, c/o Vector Marketing, Denington Estate, Wellingborough, Northants NN8 2RL. PC3

Please send me _____ Acorn IEEE Interfaces at £325 each, incl. VAT and delivery. I enclose PO/cheque payable to Acorn Computers Limited Readers A/C or charge my credit card.

Card Number _____

Amex/Diners/Visa/Access (Delete)

Name _____

Address _____

Postcode _____



**ACORN
COMPUTER**

Signature _____

Registered No. 140 3810 VAT No. 215 400220

The Flagship...

A white Epson LQ-1500 dot matrix printer is shown from a three-quarter perspective. A small white flag with a red pole is stuck into the top of the printer, displaying the text 'EPSON LQ-1500'. The printer is set against a background of a stylized world map with black grid lines. The printer has a paper tray on top, a control panel with several buttons and a dial on the right side, and the Epson logo on the front left.

EPSON
LQ-1500

In keeping with a long tradition of producing fine quality dot matrix printers, Epson have now launched their new flagship. The LQ-1500 is a new breed of printer, that will give you the best of both worlds. A dot matrix printer, although capable of 200 CPS in draft mode, can be set to produce letter quality at 66 CPS by simply flicking a switch.

Like all Epson products, versatility has been a primary consideration of the LQ-1500, incorporating friction feed as standard with optional tractor and hopper feed and a carriage width of a full 15".

You now have at your fingertips

all the advantages of a daisywheel machine, in terms of quality, together with the added benefits of condensed or enlarged characters and proportional spacing, plus very high speed when set to operate in draft form.

Having superb graphics capabilities and optional 8-bit parallel (Centronics) RS 232 and IEEE interfaces, the LQ-1500 has taken

its rightful place at the head of the Epson fleet of fine dot matrix printers.

Epson have been leading the field in the design and production of printers for many years. Printers that are now successfully operating in all kinds of business environments, like the ever popular RX-80 and FX-80. With speeds of 100 CPS and 160 CPS respectively, dot addressable graphics and optional tractor feed available on the FX model, these two machines are extremely reliable and widely used.

The RX-80F/T has the same

The Fleet



Advanced features as the RX-80 but having both friction and tractor feed as standard, it's a totally versatile machine at a thoroughly realistic price.

With an ever watchful eye on the changing face of the printer market, Epson have identified a growing need for a high speed printer with the ability to accept wider paper. Thus was born the FX-100, again including all the advantages of its predecessors.

Epson are always looking for ways to improve products, a policy which has kept us one step ahead during a lifetime of being the first name in printers.

Fill in the coupon now to find out which member of the Epson printer family meets your requirements.



EPSON

**Extraordinary product.
Exceptional quality.**

Epson (UK) Limited, Freepost,
Wembley, Middlesex HA9 6BR.
Sales Enquiries: Freephone EPSON.
General Enquiries: 01-902 8892.
Telex: 8814169.

- I would like a demonstration of the LQ-1500 printer.
- Please send me details of my local stockist.
- Please send me details of the range of Epson printers.

Name _____

Position _____

Company _____

Address _____

Tel: _____

PC3/DMP

● Circle No. 111

SOFTWARE AND TECHNOLOGY 4

A disk for every micro. While 8-bit micro-computers may boast a 'standard' operating system, one of its gravest shortcomings has been the lack of a common disk format. It has meant that data created with the same software package but on different computers could not be moved from one machine to another running the same operating system. With 16-bit micros running MS-DOS, this situation has been remedied. MS-DOS uses one data format common across all machines. This means that files from Multiplan or documents from Microsoft Word are completely transferable between any MS-DOS micros.

Enhancing high-level languages. Today's computer hardware offers a staggering array of new facilities, particularly where graphics and sound are concerned. As hardware develops, software writers have a choice between buying a special package just to achieve the most rudimentary on-screen graphics or music, or using a high-level language with built-in graphics and music commands. In fact, it would be foolish to expect proven languages like BASIC not to evolve as hardware becomes more sophisticated. With the latest version of its GW BASIC Interpreter, Microsoft has enhanced BASIC one step further for this new hardware. The language has a large number of graphics and sound extensions supporting new input devices such as joysticks and light pens, with graphics commands that can rotate defined objects at will on the screen, and the ability to open windows and see objects shrink or expand automatically as window sizes alter. The combination of advanced hardware and software like GW BASIC means that programs written in Interpretive BASIC can now run at speeds approaching those of programs written in lower-level languages. Features of this type would have been unheard of two years ago – but just think what sort of facilities may be available in tomorrow's high-level languages.

Europe's leading Financial Planning package. Even though the European Economic Community sometimes finds it hard to agree just who pays how much to whom and for what, it has at least reached a firm decision on one aspect of financial planning. When it comes to spreadsheets there appears to be great accord between France, Germany and the UK. Microsoft's Multiplan, translated to work in the natural languages of those countries has come out as the number one European spreadsheet package. According to a recent European survey in one of the monthly computer journals, Multiplan has emerged as the favourite spreadsheet. Microsoft has brought the same linguistic resources to bear on Word, its text processing package, and hopes that in 1984 Word will achieve the same international success as Multiplan.

How does a standard evolve? The microcomputer industry has traditionally established its standards by two routes. The S-100 bus, MS-DOS and 8-bit CP/M evolved while some manufacturers have consciously attempted to set standards as with the Ethernet network and the 3.5" Winchester disk format, hoping that others will follow in their footsteps. There has, however, recently been a new approach. At the end of 1983, an unprecedented commitment was made by 23 of the industry's leading microcomputer manufacturers to a new product from Microsoft. The product was Microsoft Windows – an enhancement to the MS-DOS operating system. Never before in microcomputing history has such a forceful public commitment been made to one product. Companies like DEC, Wang, Tandy, Apple/Rana, Altos, NCR, Compaq, TeleVideo and Eagle will all be offering the product on their MS-DOS based micros in 1984. More recently, the UK's leading 16-bit microcomputer manufacturer, ACT announced that it too, would be supporting Windows on the hugely successful Apricot. By mid-1984 we will be reaping the benefits that such standardisation offers – portable software running in the same manner on different machines; integrated software with different applications running together on the same machines; and software that's a whole lot easier to use.

MICROSOFT

Microsoft Ltd, Piper House,
Hatch Lane, Windsor, Berkshire.

Zilog to put CP/M on chip

TWO CHIP MANUFACTURERS, Zilog Corporation and American Microcomputers Inc., have reached an agreement with Digital Research to incorporate DR's Personal CP/M in a single-chip operating-system processor.

AMI will design the chip, which will then be manufactured and marketed by both AMI and Zilog. Development is expected to be swift — Digital

Research expects products incorporating the new processor to be available to users within six months.

The new processor will be based on Zilog's eight-bit Z-80, with Personal CP/M actually contained in the chip's on-board ROM. This brings big advantages for hardware manufacturers, allowing powerful computers to be designed with fewer com-

ponents and produced at greatly reduced cost.

Personal CP/M is an extension of CP/M 2.2, with help screens, visual prompts and other user-friendly features. It is compatible with earlier eight-bit versions of CP/M. The development of the new chip promises to open up the huge CP/M software base to users of a new generation of cheap home computers.

Acorn cassette-to-disc copying

HAVING TAKEN *PCW* to the High Court to discourage people from copying its BBC cassette software across to disc, Acornsoft is now offering a cassette-disc exchange service itself — at a price, of course.

The scheme works like this. If you already own an Acornsoft program on cassette the company will sell you a disc copy of the same title for half the normal price; you also have to send in your cassette. So having bought Starship Command, for example, at £9.95 on cassette, you can send it off, together with another £5.75, and Acornsoft will send you a Starship Command disc.

In effect BBC users face large software-conversion costs when they upgrade their systems, if they go along with Acornsoft's game. But most computer companies do not attach such significance to the physical medium on which a program resides. Most business software, for instance, is distributed on floppy disc and then copied across to hard disc for actual use. The purchaser is, in effect, buying the right to use the software on a particular system.

If Acorn's rivals in the home-computer business make a point of publicly adopting the policy of allowing users freely to convert their software as they

upgrade their systems, the BBC Micro will be at a clear commercial disadvantage. Sales of disc drives for the BBC Micro may suffer, and eventually the computer itself may be hit.

For details of the Disc Replacement Service contact Acornsoft Ltd, 4a Market Hill, Cambridge CB2 3NJ.

Keydraw

KEYDRAW for the ACT Sirius lets you prepare reports where text is mixed with charts. Flow charts, organisational diagrams, pie, bar and other types of chart can be produced, and text added.

Keydraw requires a Sirius with 256K to run and an Actwriter, C Itoh or similar dot-matrix printer. The price is £250.

Details from Tarot Ltd, Tarot House, 16 Worbeck Road, London SE20 7SW. Telephone: 01-650 2999.

BBC utilities from Beebug

BEEBUG, the independent BBC user group, is bringing out a range of practical utility and application programs for the BBC Micro.

Toolkit, price £27, is a set of utilities on an 8K EPROM for BBC Basic programmers. Among its facilities Toolkit has

a full-screen program editor which lets you search and replace strings and selectively renumber specified program lines.

Spellcheck, costing £19, is a disc-based spelling checker which works with the popular Wordwise word processor. A version for View is promised too. Spellcheck's initial dictionary contains 5,000 words, and you can add up to 17,000 more on 40-track discs or 34,000 on 80-track discs.

Teletext Pack comes on disc at £12 or cassette at £10. It consists of two programs: a tutorial which explains how to use mode 7 graphics from Basic, and a Teletext editor. The editor lets you create mode 7 screens interactively, and it will then generate the appropriate Basic Print statements for inclusion in your programs.

Other Beebug program offerings include Machine Code Monitor, a database called Masterfile, a computer-aided design package and a graphics plotting utility.

Contact Beebug, PO Box 109, High Wycombe, Buckinghamshire HP11 2TD.

Magazine Index

THE MICRO USERS' YEARBOOK provides a comprehensive index to articles in the 10 leading U.K.

(continued on page 23)

In Brief

● A complete set of business accounting software to run on Unix machines has just been launched in the U.K. Written entirely in C, the integrated package is called Cintra. Individual modules for payroll, sales, purchase and nominal ledgers are available separately, with prices starting at £350. Details from Computer House, 172 New Bridge Street, Newcastle upon Tyne. Telephone: (0632) 617001.



● Royal Birkdale for the 48K Spectrum is a golfing simulation game which accurately re-creates the famous golf course. The price is £6.90. Contact Ocean Software Ltd. Telephone: 061-832 9143.

● Computers in Medicine is the subject of a video produced by the British Medical Association. Called *The Days after Tomorrow* it is aimed at doctors who are thinking of introducing a computer into their practice or hospital. A short leaflet is also available. Both are free to BMA members; a nominal charge is made to other doctors. Contact BMA Film Library, BMA House, Tavistock Square, London WC1H 9JP. Telephone: 01-387 4499.

● Infidel is a lavishly packaged adventure game for the IBM PC and the Apple II. It has you looking for a lost pyramid in the Egyptian desert. The Infidel game disc is accompanied by an ancient map, stationery from an Egyptian hotel and other bits and pieces help you solve the mystery. Planetfall is a similarly packaged game from the same authors, this time with an SF scenario. Each game costs £33.95 plus VAT from Pete and Pam Computers.

(continued from page 21)

microcomputer magazines. The 200-page loose-leaf file sets out to cover every article of substance of more than half a page, including hardware and software reviews and programming articles.

The current edition covers the period September 1982 to October 1983. Updates are to be published every six months. Three indexes allow you to access the information by general subject area, by computer name, or by one of 70 key words. We are already finding our copy useful for finding articles in our own back numbers.

The Micro Users' Yearbook costs £8, or £12 for the book plus two 1984 updates. Contact Computeam Consultants Ltd, White Court, Chilmington Causeway, Tonbridge, Kent TN11 8LE. Telephone: Penshurst (0892) 870802.

Microdata's natural language

FIFTH-GENERATION computing comes a step closer with the launch of the first commercial natural-language environment. It involves the use of an interpreter called Natural Language, Microdata's Applications Language Liberator and Microdata's Pick-based relational database, called Reality.

The system allows you to query the database in your own words: "Show me all the bills," for example. Natural Language uses inference to try to work out what you mean, and if possible it produces something like a list of bills. Then it asks, "Was this what you wanted?" If stuck it will ask for synonyms for words it doesn't recognise, or to be allowed to ignore them, or offer a multiple-choice selection of options as a prompt.

The key thing is that it remembers what you tell it. In fact, it keeps a Personal Knowledge file of its users' idiosyncracies. Thus two people can use the same command, and the program may fetch two completely different sets of data.

All this means users can query the database in English without learning an elaborate



Microdata's M-1000 runs Natural Language software.

computer language or syntax, or even getting the spelling right, since in cases of doubt the program makes an intelligent guess.

This is impressive stuff even on one of Microdata's 32-bit super-minicomputers. But now Microdata has launched the M-1000 work station — effectively a hard-disc based microcomputer. It uses an Intel 80186, has a better specification than the IBM PC XT and costs slightly less, though you still don't get much change out of £6,000. However, it runs the same software as Microdata's average £100,000 mini installation. Microdata is also planning to make the software available separately as Microreality for the IBM PC XT.

Microdata is essentially a British company, based in Hemel Hempstead, though it has been bought by McDonnell Douglas, the American aerospace corporation. It employs about 1,000 people in the U.K. and has an annual turnover of around £50 million. Users include an array of major names like American Express, the NatWest Bank, Texaco, BL, GEC, Thorn-EMI, British Telecom, Courtaulds and Unilever.

Contact Microdata at Maylands House, Maylands Avenue, Hemel Hempstead. Telephone: (0442) 61266.

Softsel awards mirror U.S. taste

ZAXXON was the hottest product of the year in America

according to Softsel, a leading international software distributor. The game was awarded top prize in the company's annual Hot List awards for shooting to the top of the recreational section of the charts and staying there for 14 weeks.

Softsel distributes software to around 5,000 dealers in the U.S. and compiles weekly charts of its best selling programs for display in the computer stores. Separate charts are provided for recreational, business, education and other categories. Returns from the 450 dealers the company supplies in the U.K. were not taken into account for the 1983 awards.

Zaxxon is available in the States for the Apple, Atari, Commodore 64 and Tandy Color Computer. Though it was the year's most spectacular product, it did not get the best seller award in the recreational category. This honour belongs to Frogger from Sierra On-Line. Frogger runs on the

Apple, Atari, IBM and Commodore 64, and clocked up greater sales by continually hovering around the top of the chart.

Best selling business program was Lotus 1-2-3, and as we go to press it is still at number 1, immediately above Bank Street Writer.

Best selling program in the educational category was Mastertype, running on the Apple, Atari, IBM and Commodore 64. It too is still at number 1, as is the best-selling book *Kids and the Apple* from Datamost.

International competition

A FIRST PRIZE of \$100,000 is being offered in the International Video Game of the Year competition. The organisers are looking for games running on any popular home micro which embody original ideas. Copies will not be considered.

Prizes will be awarded in six categories — arcade, simulation, strategy, adventure, sport and other. Winning games will be marketed, with a 10 percent royalty going to the authors; reading the small print suggest the prizes are advances on these royalties. Apparently winners will receive their prizes on TV.

Details from Video Games International Ltd, Pinewood Studios, Iver Heath, Buckinghamshire SL0 0NH. Telephone: (0753) 651700.



Softerm 2 lets you use an Apple II Plus or IIe as a terminal connected to a host computer system. The program is claimed to let you run applications written for many popular terminals without any program changes being necessary. File operations can be performed in CP/M, Pascal and DOS 3.3 program formats. The price is £119 from Pete and Pam Computers.

The new generation of plotters

for all business & scientific graphics

- A3 paper
- 8 pens
- RS232, IEEE Cx1/faces

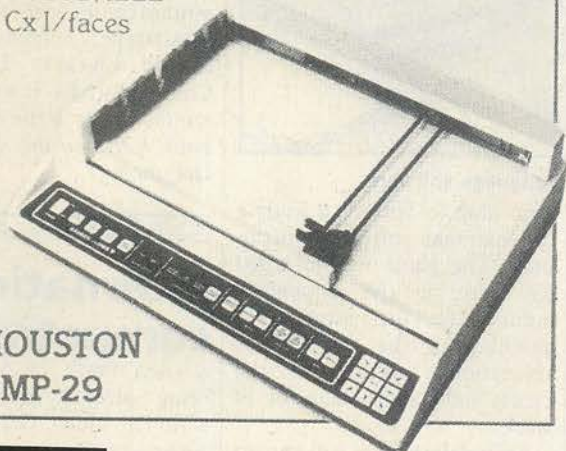

HOUSTON
DMP-29

Low cost, high performance
intelligent plotting

- A3/A4 paper
- Interchangeable pens
- RS232 & IEEE 1/faces



HOUSTON DMP40



**Sintronic
Electronics**



Sintronic Electronics Ltd

Arkwright Road, Reading, Berks RG2 0LS
Tel: Reading (0734) 875464
Telex: 847395

For professional career opportunities contact our Personnel Department

**NEW LOW COST
AI PLOTTER
NOW AVAILABLE**

● Circle No. 114

Micro Computer Disks Ltd

Computer supplies for the end-user

LOWEST PRICES FOR HIGHEST QUALITY PRODUCTS

MAXELL FLOPPY DISKS
DYSAN FLOPPY DISKS
MEMOREX FLOPPY DISKS

prices from **£20.50** per box
prices from **£22.50** per box
prices from **£13.50** per box

Ribbons (over 50 varieties in stock)

Multistrike High Capacity Ribbons
Diablo/Qume Daisywheels

£1.95!!
only £3.95 each!!

NO MIDDLE MEN! NO FRILLS! STRAIGHT FROM THE WAREHOUSE!

0990 23002/3

M.C.D. LTD 8 DOWER HOUSE, TRUSSHIL, SOUTH ASCOT, BERKSHIRE SL5 9AN

● Circle No. 115

Free software, only £225.

If you own a BBC Micro, you can now download, store and run programs transmitted free of charge via Ceefax) with the new Teletext Adaptor, priced £225 inc. VAT.

These programs make up the BBC Telesoftware Service (which is intended to become a computer software broadcasting channel) and although primarily educational, they will soon develop into general interest and business areas.

And, as they will change every two weeks, you'll soon be able to build up a vast bank of top quality software without ever having to put your hand in your pocket.

But that's not all the adaptor has to offer. It also enables you to gain access to the normal teletext store of data. This is different to simply having a teletext TV because it means

this data can now be transferred to memory and manipulated in any way you wish (making graphs or bar charts for instance).

It's yet another development in our programme to help you fully realise your BBC Micro's potential.

If you're a credit card holder you can order the Teletext Adaptor by ringing 01-200 0200 at any time or 0933-79300 during office hours.

(You can also find out the address of your local BBC Micro dealer by calling the same numbers.)

Alternatively, you can order it by sending off the coupon below.



Technical Specifications

Access to Teletext and Telesoftware Services broadcast on U.H.F. channels E21 to E69.
Speed of max. data capture rate approx. 128k baud.
(8 lines of Teletext per frame.)
Height 70mm. Width 210mm. Depth 350mm. Weight 2kg.
Colour: BBC Computer cream.
Construction: Moulded top and bottom to match BBC computer profile. ABS injection moulded plastic.
Controls: Four tuning potentiometers on rear panel.
Mains on/off switch on rear panel.
Power in 240v, 50Hz, 15w.
Operating Temperature: 10° to 35°C.
Designed and manufactured to comply with BS415 Class 1 standard.

To: BBC Microcomputers, c/o Vector Marketing,
Denington Estate, Wellingborough, Northants NN8 2RL.
Please send me _____ BBC Teletext Adaptors at £225 each, inc. VAT and delivery. I enclose PO/cheque payable to Readers A/C, Acorn Computers Ltd, or charge my credit card.

Card Number _____
Amex/Diners/Visa/Access (Delete)

Name _____

Address _____

_____ Postcode _____

Signature _____

Registered No.140 3810 VAT No. 215 400220

The BBC Microcomputer System.

Designed, produced and distributed by Acorn Computers Limited.

PC3

The MTX Series described; straight from the author's mouth

MANUAL

The first section (of the manual) is a basic tutorial. The grass roots information is here and I could not find any major mistakes. The second part is on Noddy giving a good guide as to how it can be written. . . . The third and fourth sections are on graphics and sound. Both are quite detailed and easy to follow. The fifth section is on how to interface Assembler to Basic.

Personal Computing Today Feb 84.

The provisional manual, which runs to some 250 A4 size pages, has a wealth of detail for the machine-code specialist.

Electronics and Computing Monthly.

INTEGRATED INTERACTIVE SOFTWARE

The MTX ROM has been designed to allow the maximum interaction between components of the software. A single program can be written which uses NODDY to display text and graphics, and a BASIC control program which calls routines written in assembly code. This is a feature of future generation computers not available on any other micro.

BASIC

The Basic is fast and accurate, all the calculations being done in floating point maths, so that you don't lose accuracy to gain speed.

Personal Computing Today Feb 84.

The latest addition to the Memotech range DMX80 Matrix Printer - 80 characters per second print speed, eight character formats, dot addressable graphics, £295.00 including VAT.

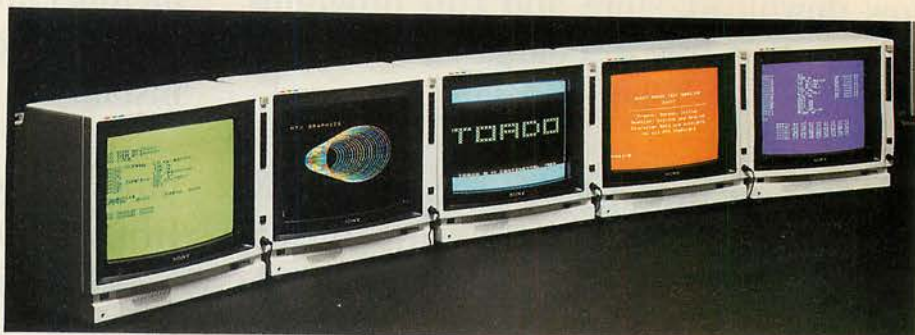

Integrated Software - a five to one advantage. Assembler/Disassembler, High resolution Graphics, Arcade style games, Noddy for easy text handling and Front Panel for testing and debugging machine code.

NODDY

A language new to me called Noddy is included in the MTX which is designed to make text handling easy, especially for beginners.

Hobby Electronics.

Also provided is the easy to use beginner's language (Noddy) and a child oriented learning language Logo.

Practical Computing Dec 83.

(Noddy has only 11 commands) that need to be mastered before some quite complex question-and-answer-type programs can be written.

Your Computer Nov 83.

Noddy's . . . main use is for displaying text and I can see applications in the computer assisted learning (CAL) field. Writing in Noddy is like a mixture of Logo and Forth.

Personal Computing Today Feb 84.

ASSEMBLER/DISASSEMBLER

The Assembler can be accessed through BASIC. When used in conjunction with the PANEL it enables the programmer to single step through

and test machine code programs. This is not new to computing, but it is to a home micro.

As well as being able to modify and disassemble sections of code, you can set break points, examine and alter register values, and even single step through code. I hope other Z80 micro manufacturers (particularly in the Cambridge direction) take note of these debugging aids.

Popular Computing Weekly Nov 83.

The Assembler is called from Basic, and it assembles the code in situ, as part of the Basic listing.

Hobby Electronics.

Z80 BOARD

The MTX Series is a more powerful tool for education than the 6502 because it produces a more powerful assembler, allows the PANEL function to be used, and enables integrated software to be written.

RML's 450Z has a (PANEL) function but that is a computer which costs considerably more than the MTX 500.

Hobby Electronics.

FULLY INTEGRATED AND EXTENDED GRAPHICS

The only aspect of the series where extensions to standard language are allowed is in the most comprehensive and integrated graphics available on a home micro.

32 Sprites are supported either 8 x 8 or 16 x 16. They are easy to use and define and do not use extra memory as in the BBC B because they have their own area of RAM.

Personal Computing Today Feb 84.

Graphics are very easy to create and manipulate, even for beginners.

Which Micro Jan 84.



MTX512 plus twin 5 1/4" disc FDX. A CP/M based business system - £1245 inc VAT.

SOUND

The simplification of the sound commands for ease of programming has in no way compromised the quality of the sound produced.

Sound is of great importance for use in games but on many microcomputers it is inadequate. Not so with the MTX... *Your Computer Nov 83.*

As well as good graphics capability the MTX boasts the same sound chip as the BBC micro - the Texas 76489. It has three tone channels and one noise channel, and is easily controlled from Basic. Volume and frequency can also be controlled, using a much easier method than the 14 parameters needed by the BBC. *Popular Computing Weekly Nov 83.*

The commands are sufficiently complex to enable the computer to be used as a synthesizer. *Electronics and Computing Monthly.*



Input/Output Monitor, Hi-Fi, Power, TV, Centronics, Cassette Mic and Ear, and two Joystick ports all come as standard; the twin RS232 ports are available as expansions.

HARDWARE

Inside the case is what one comes to expect from Memotech - a very neat PCB that holds all the components including the main chips - namely a Z80A processor and TMS 9929 graphics chips as well as about 30 others. *Popular Computing Weekly Nov 83.*

If you are familiar with the ZX81 peripherals that Memotech also make you will know that the company has an eye for good design and does not skimp on materials it uses. *Electronics and Computing Monthly.*

CP/M OPERATING SYSTEM

The Series is designed to run under the CP/M operating system. This is the Disc Filing System used on the vast majority of microcomputers in business. Since a program written on one CP/M machine can be transferred and run on almost any other, this makes available 15,000 CP/M based business programs. The powerful LINK program can give access to any device operating under CP/M. With its excellent software support and because of its modular nature, the series is a cost-effective and efficient entry to serious business and educational computing.

FULL-TRAVEL KEYBOARD

It has a professional quality keyboard. This and its elegant styling make it suitable for word processing and business use. *Your Computer Nov 83.*

NODE RING

MTX computers can operate together without expensive network systems. Units linked via the ring can share software peripherals and communicate with each other. Many other makes of computer can be interfaced with the ring as terminals.

EDUCATIONAL USAGE

There will be many people who have seen a front panel display on the 380Z computer in secondary schools or

colleges, and the MTX panel is very similar.

Hobby Electronics.

The new language Noddy and the Logo type Turtle Graphic commands would appeal particularly to the growing education market.

Your Computer Nov 83.

Applications are obviously going to suggest themselves in areas of the school curriculum, the fast-training of personnel in commerce, and in adventure-game writing.

Hobby Electronics.

The MTX expansion potential is well thought out. The key to both the MTX Ring system and to the Disc Drive systems is the communications (RS232) board mentioned earlier.

Electronics and Computing Monthly.

UPGRADABILITY

The MTX 500/512 is part of an existing range of products which can be bought separately and integrated into a single powerful system, now.

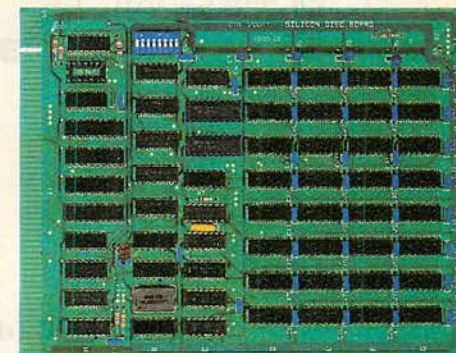

Silicon Disc RAM Board 256K fast access RAM

There is plenty of room for expansion with the MTX and Memotech have planned a progression up to their small business machine with 80 column display (instead of the standard 40 x 24) Floppy discs, Silicon (or RAM) discs, and a hard disc under development. *Personal Computing Today Feb 84.*

There are a multitude of sockets along the back consisting of two Joystick sockets, cassette connections, Centronics printer circuit, aerial socket, power socket and audio and video output. There is also provision for two RS232 sockets... in addition the left hand end of the case has a large expansion socket with all the CPU signals on it - Memotech thoughtfully supply a plastic Blanking Plate to protect and conceal it when not in use. *Popular Computing Weekly Nov 83.*

CP/M is a registered trademark of Digital Research Inc.

MEMOTECH

Station Lane Industrial Estate
Witney, Oxon, OX8 6BX.
Telephone (0993) 2977
Telex: 83372 MemtecG.

A New Era...



prices from
£1,735 (exc. VAT)

...in reliability and performance.

The **NEC APC** - dependable 16-bit processing, at a price you can afford.

Significant disk capacity, high-resolution display, optional colour and a comprehensive selection of applications software are just a few of the **APC's** high performance features.

Over the past seven years we have become established as leading suppliers of high-quality microcomputer products. Our comprehensive service includes pre-sales advice, training, installation and full technical support.

Take your business into the future with the **NEC APC** from Interam.

For further details or to arrange a demonstration contact:

APC Sales,

Interam Computer Store,
FREEPOST, London SW12 9AG
Tel: 01-675 5325 Telex: 925859



INTEDAM
INTERAM
COMPUTER SYSTEMS LTD

1st FLOOR, THAMES HOUSE, SOUTHBANK BUSINESS CENTRE, 140 BATTERSEA PARK RD. LONDON SW11 4NB TEL: 01-622 9373 TELEX: 925859

● Circle No. 118

Software comes of age

Glyn Moody on the impact of software publishing on conventional publishers

IT IS A COMMONPLACE that the pattern of micro buying is now largely determined by the availability of systems and applications. Many a fine machine has died a death through being unable to support the operating system of the moment, or through not offering enough of the right packages. This state of affairs has come about through the specific way in which the micro market and its associated software has developed. The sheer size of the market has meant that its financial clout cannot be ignored, and the almost haphazard pattern of its growth has changed the structure of software buying and selling.

Home grown

Initially, hobbyist machines ran on almost exclusively home-grown software — indeed this was part of the original appeal of the micro. As micros became respectable, a new class of user evolved, who wanted ready-made programs as well as machines.

Two of the largest software houses around today sprang from a couple of these early programs that were in the right place at the right time. CP/M was designed in rather a hurry to provide a working operating system for the Z-80; and Digital Research now offers a panoply of operating systems, all extensions and enhancements of that one idea. Similarly, VisiCalc began life as a neat practical package for the Apple II; today the associated company Visicorp produces a range of related software. Like Topsy, these software houses "just grew".

Alongside the large corporations, there have always been a plethora of smaller software operations, usually based around some knowledge of Basic and two cassette players in the front room. These "one man and his dog" outfits have proliferated in the wake of the success of home machines such as the Spectrum and the BBC Micro. In between these extremes, there is a group of software publishers, ranging from Peachtree downward, who employ teams of experienced programmers to produce a range of application software for home and business consumers.



in software, the newer companies are often let down by their lack of marketing expertise and retail outlets. It is surprising that conventional book publishers who do have such expertise have until recently adopted a cautious attitude to the possibilities opened up by micros in software publishing. Now, however, a number of major houses are edging gingerly into the market-place.

For some time popular publishers like Pan and Granada, together with a host of educational houses, have been producing books about computers, and books of program listings. Now Penguin has joined their ranks, with the announcement of a link up with Acornsoft to produce the Penguin Acornsoft Computer Library. Penguin hopes to move on to offer combined book and software packages before finally cutting the apron strings and producing software that can stand on its own merit.

Education is a common area for the first faltering steps by conventional publishers into software. The government schemes for micros in schools have prepared the ground and furnished a market. Conventional selling channels are readily adapted in what is a repackaging of earlier products. The material of an established educational book series often translates across easily into a software package. Whether this is the best approach is debatable since detailed programming skills are kept to a minimum and so are more easily overseen by editors without in-depth computer knowledge.

Primary educational software is a popular area for this, and in recent months Cambridge University Press, Longman

and Macmillan have all announced software ranges. A significant shift is that these programs do not aim to teach computer studies or literacy as such, nor are they seen as a teacher substitute. They are conceived to be teacher aids and resources for conventional subjects — in other words, the software equivalent of books.

As far as the organisation of such new ventures is concerned, patterns vary. Heinemann Computers in Education was set up two years ago as a separate arm of Heinemann Educational Books. Other companies, like John Wiley and Sons and McGraw-Hill, have a more integrated approach, with book and software departments working together closely. For Cambridge University Press and Macmillan the scale of the operation is indicated by the production targets of about 50 programs a year; other companies are more conservative.

Exploitation

Some publishers are starting to exploit the particular strengths of their lists in areas other than education. For example, Oxford University Press is planning to launch three word-based packages in conjunction with Wang Computers: a speller based on the *Concise Oxford English Dictionary*, a quotations package and a style guide. Another interesting development involves daily newspapers, which have already increasingly diversified their publishing activities. The *Daily Mirror* has launched Mirrorsoft, a series of home computer programs, and the *Financial Times* has produced financial-modelling system.

In many ways these recent developments represent a coming of age for software publishing. The next step for publishing houses will be a move into applications software. The convenient tie-ups with current book lines and the security of tried-and-tested marketing pitches will be greatly reduced, and the risks correspondingly greater. But as advancing technology begins to impinge on the whole book-publishing process, publishers will find themselves more and more involved in providing products in a purely software format. ■

PRODUCTS FOR COMMODORE

SPEED UP ANY BASIC PROGRAM WITH OUR COMPILERS

Up to 40 times speed increase, reduced program size.

BASIC COMPILERS

Petspeed Compiler for 4000/8000 series _____ £125.00

Integer Basic Compiler for 3000/4000/8000 series £75.00

CROSS-COMPILERS FOR BASIC

Portspeed: Compiles source on 8000 series to run on CBM 64 _____ £125.00

X-64: Integer compiler compiling on 8000 series giving machine code executable on CBM 64 _____ £125.00

B-Port: Compiles source on 8000 series to run on 700/B-128 series _____ £450.00

X-700: Integer compiler compiling on 8000 series giving machine code executable on 700/B-128 _____ £450.00

GIVE YOUR VIC OR 64 FULL IEEE AND RS232

Not a cartridge. Compatible with any software.

Interpod: Free-standing interface giving IEEE488 and RS232C capabilities to CBM64/VIC20 _____ £99.95

SPECIAL OFFER

Order 5 or more Interpod and get a free Portspeed!

All prices are exclusive of VAT. There is also a small charge for post and packing. Dealer discounts are available on all products except the 700 cross-compilers.

Compilers are supplied ex-stock; Interpod supplied 7-days ex-stock.

COMMODORE SOFTWARE

Native compilers for the CBM 64 and the 700/B-128 are available only from Commodore.

Oxford Computer Systems (Software) Ltd.
Hensington Road, Woodstock, Oxford OX7 1JR, England
Telephone (0993) 812700 Telex 83147 Ref. OCSL

VISA ACCEPTED

● Circle No. 119

COMMUNICATIONS

Tandata

SMART MODEMS

Auto dial, direct connect, with 8 telephone & 8 ID store on modem, 1200/75bps or full multirate (1200/75, 75/1200, 300/300 full duplex, 1200/1200 half duplex). Many advanced features. From £99. Also special terminal, Prestel and downloader software for BBC APPLE COMMODORES with more following

ELECTRONIC MAIL
PRESTEL
BULLETIN BOARD
TELECOM GOLD
COMPANY DATA BASES
MICRONET 800
TELESOFTWARE
MICRO-TO-MICRO "CHAT"

Tandata Marketing Limited,
Albert Road North, Malvern, Worcs. WR14 2TL
Telex: 337617 Prestel * 799 # Telecom Gold: TAN 001

Please send me Smart Modem literature and Order Form

NAME _____
COMPANY _____
ADDRESS _____

PCJ 84

● Circle No. 120

MICROCOMPUTER

PRICE BREAKTHROUGH!

TWIN-DRIVE COMPUTER SYSTEM

FROM ONLY

£799

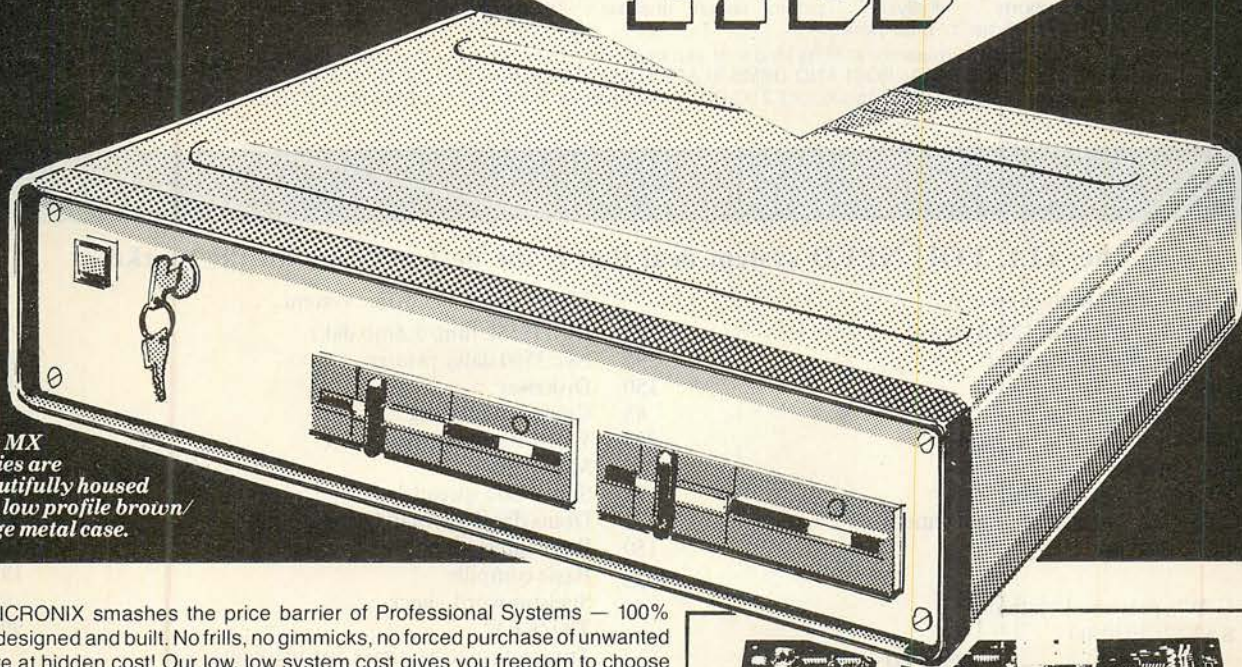

The MX Series are beautifully housed in a low profile brown/beige metal case.

Now MICRONIX smashes the price barrier of Professional Systems — 100% British designed and built. No frills, no gimmicks, no forced purchase of unwanted software at hidden cost! Our low, low system cost gives you freedom to choose and buy software to suit your requirement and still save money! Four models to choose from and a massive 21 Mbyte Hard disk Subsystem is also available. Based on the versatile MICRONIX 80HD Single Board Micro all models have • Z80A MHz CPU • 64k (expandable to 128k) RAM • 24 x 80 VDU • Floppy Disk Controller • SASI Hard Disk Interface • Real Time Clock/Calendar with battery back-up • Two RS232c Ports • Two Parallel I/O • Buffered BUS • ASCII Parallel Keyboard Port • Composite Video • CP/M compatible Operating System. Just add a terminal or video monitor and a keyboard (optionally available) and you are in business!

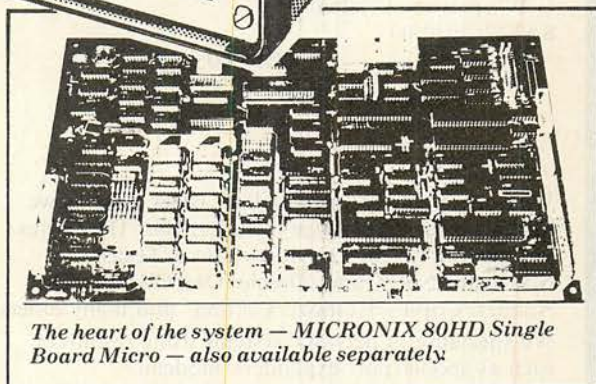

The heart of the system — MICRONIX 80HD Single Board Micro — also available separately.

LOOK AT THESE PRICES!

MODEL MX400:
400K TWIN 5 1/4" SYSTEMonly £799
MODEL MX800:
800K TWIN 5 1/4" SYSTEMonly £899

MODEL MX1600:
1600K TWIN 5 1/4" SYSTEMonly £999
MODEL MX2400:
2400K TWIN 5 1/4" SYSTEMonly £1,199



micronix computers Ltd

KEYBOARD: 102 Key Low Profile ASCII Keyboard only £125 (£5 carriage)
HARD DISK: Mass Storage Hard Disk Sub-systems complete with Software and ready to plug into any MX System above:
Model MX115HD 11.5 Mbyte Hard Disk only £1,250
Model MX216HD 21.6 Mbyte Hard Disk only £1,399
All prices are exclusive of carriage (£15 per System) and VAT.

Suite 2, 26 Charing Cross Road, London WC2. Tel. 01-240 0213/0217. Telex 295173 VILORD G

● Circle No. 121

*******THE NEW DBMS III (series III of the world's first 'task-robot-programs')*******

*******FEATURES*******

1400 character record sizes.....	32000 records per filename.....	12 online file architectures.....
mathematical scratchpad.....	20 main/200 sub fields per record.....	240 fields using cross-referencing.....
record relational indexes.....	field and record related formulae.....	cross-record calculations.....
translateable to any language.....	'Jump-to' any of 32000 records per file.....	'Jump-to' any record in 12 files.....
User-definable reporting.....	random/binary/key/multiple field search.....	User-definable files/field words/sizes.....
field protection/classification.....	'if-then' questioning.....	endless 'either-or' matching.....
either-or, same as, greater, smaller.....	file protection/password entry.....	formulate/recall on selection criteria.....
sorts 'alpha or numeric' any window.....	range match, not match, integer match.....	13 interrogation question types.....
12 online file architectures.....	sort speed 500 records per 20 seconds.....	short filing output/audit trails.....
		Word-star & Mbasic compatible.....

DBMS III.7 NEW SWITCH MODE FACILITY ENABLES YOU TO CROSS UP TO 12 DIFFERENT FILES (32000 RECORDS PER FILE) PRE-SELECTING ANY OF UP TO 20 FIELDS PER RECORD/FILE FOR DISPLAY/PRINT OUTPUT (240 FIELDS) IN ALL. ONE MASSIVE ENQUIRY CAN PASS THROUGH 384,000 RECORDS

You might have two files whose records are directly related to each other, so that the first file (say containing names and addresses) refers to the second file (say financial and other information relating to the same record numbers in the first file) directly. Then you can simply select that in file 1 you are interested in just the name and telephone numbers, whereas in file 2, you are interested in the income, trading period and number of branches, information. Your enquiry can then pass through both files highlighting that information only. Actually there doesn't need to be a strict correlation between the same record numbers in different files, and you can also on just one JUMP command go to any record in any of the 32000 records in any of the twelve files and carry on cross-referencing from there onwards.

DBMS'S MACROS WORK FROM THE MOMENT YOU INSERT THE 'TASK DISK' IN THE COMPUTER

Simply design your file, give its fields your words, setup your report mask, and then enter your records. Switch to 'automatic drive' and formulated any task you wish to program to fulfill, the task is stored as a macro. Take a copy of the program on another 'task disk' and from then on, the task disk will function without a single key-stroke. Think of a number of such 'task disks' such as "stock-re-order reports"; "stock-valuation reports"; "analysis"; "patient history analysis"; "research-analysis"; "budgetting-analysis"; "vehicle-location control"; "librarian analysis"; "plus more?"

Not only does this program surpass most of its kind that you might buy elsewhere, but if you buy the hardware from us, then you get it FREE . . . DBMS II (WITHOUT MACROS) AND DBMS III ARE FULLY IMPLEMENTED UNDER CPM-86 (tm) AND MS-DOS (tm) I.E.: SIRIUS/VICTOR/IBM DBMS II IS £395.00 (or £250.00 by mail order ex. training) . . . DBMS III is £575.000 (or £295.00 by mail order ex. training).

The ALL YOU NEED system deal that is the best package on the market.

The personal budget system . . .		The professional office system . . .	
Sirius 1 (128k ram/1200k disks)	2195	IBM (256k ram/5.6mb dsk)	3995
Oki microline 80 printer	295	Nec 3550 daisy printer	1895
Diskettes	150	Diskettes	150
Cables and testing	85	Cables and testing	85
Word-star word processor	295	Word-star word-processor	295
Mail-merge	95	Mail-merge	95
Super-calc spreadsheet	195	Super-calc spreadsheet	195
Dbms III.7 database management	575	Dbms database management	575
Basic interpreter	150	Basic interpreter	150
	4035	Basic compiler	195
G.W's price as a system		Spelstar word-check	95
SAVES 1040.00		The 'KEY'	995
	2995.00	Transactional-database for invoicing/ mailshot/sales ledger/purchase ledger/ order-entry/personnel files/aged debt analysis/ letters/disk spreadsheet etc Direct telephone link to our system by modem	295
Why not phone in for details of other systems we have to offer. Our range includes: Ibm/Dec/Sirius/ Superbrain/Epson Televideo/Sanyo/Texas/ North-star Nec/Qume/Diablo/Oki/Olympia/Dre Anadex/Corvus/Compac/Corona/ and many others!!		modem software	95
We specialise in network systems using resources such as spools/port-expanders/modems/ hard-disks/ramdisks/concurrent ramtasks etc.		Dos 2.00	60
		Cpm 86	60
		Concurrent cpm 86	375
		Cbasic 86	95
			9700
		G.W's price as a system	
		SAVES 2005.00	
			7695.00

If you want serious advice by the experts: just call 01-636-8210 or 01-6310-4818 and leave your name & address on our 24 hour answerphone. We will send you a complete info-pack. Terms: C.W.O./C.O.D. prices exclude VAT. Showroom demonstrations only by prior appointment. Unless otherwise agreed, all warranties are the standard 'return to base' manufacturer's warranty. Annual maintenance facilities are available nationwide upon request.

Telephones: 01-636-8210 01-631-4818 Telex: 892031 TWC G.
G.W. Computers incorporated in Boston, Mass. USA.
Gramma (Winter) Ltd. 43/55 Bedford Court Mans, Bedford Avenue, London WC1.

AN IMPORTANT ANNOUNCEMENT FOR POTENTIAL SYSTEM BUYERS

Any serious buyer knows that although the HARDWARE and SOFTWARE are both inter-dependant, the choice of software is CRITICAL to the consequence of having useless piece of hardware nor not.

With this in mind our standard system deal gives you the software free with a system purchase. However, if you want more!

NOW we have a piece of software that is a challenge to the highest state of the art on micro-computers today. It's the first of its kind world-wide. It is called THE KEY, and it will unlock the power of your micro to the limits of your imagination. It is very expensive however, because it is the first to embody many features of other programs, in one single program that has over-lapping functions. It costs 995.00 Stg., and is available with a system purchase.

it features, the entire list of functions already covered by our program called DBMS III.7a to be seen elsewhere in our advertisement. PLUS. + + + + + + + + +
Paint any form including upwards from 100 (depending upon size of ram in hardware) data fields on the screen. Screen width up to 250 columns. Page lengths 100 lines.

The form might be a letter where data fields on the screen. Screen width up to 250 columns. Page lengths 100 liens.

The form might be a letter where data fields are name-addresses. Search files and accept any fields on teh database into any fields on the letter. The form might be a spreadsheet, where searches call records (in columnated

style) from the database and perform calculations, the difference here is that unlike other 'calc' programs giving you 254 lines per spreadsheet, THE KEY gives you 32000 lines if your database has that many records.

The standard attributes of any field, allow you to SEARCH OTHER FILES for fields to accept into any field on the current form, plus allowance to POST OTHER FILES any fields from the current form into any fields on that file. RELATE TO AS MANY OTHER FILES, as the number of data fields you have on the master form. Make data fields CALCULATE AGAINST FORMULAE, and other data fields. VALIDATE DATA INPUTS critically character by character; numerically, alphabetically and date-wise.

NO MANUAL NEEDED, all help menus accessible by hitting 'esc' at any point in the three major modes of activity (create, data entry, data query).

You can set up dozens of individual files that eventually are inter-connected through one master form; like an invoice, order, personnel-file, stock control, mail-shot. The master form may at every juncture of a data field, go outside the current form to supplementary forms for data retrieval, or post-filing.

Come along the computing road with us. We're out in front so you'll get the best there is at the price. On IBM and SIRIUS.

The first robot-concurrent-forms-database-text-processor-spreadsheet-no-manual-all-in-one-program.

G. W. COMPUTERS LTD — Tel: 01-631 4818

Contains the highest state of the art software available today

FORMS/TEXT/CALC/DBMS IV ALL IN ONE PROGRAM — "KEY" — at £995

When you budget for a complete system of software you eventually end up with a host of packages like, Sales, Purchases, Nominal, Data, Text, Calc, Mailshot, Invoice, Order, Workflow, Personnel, and so on.

The list is endless and the outlay several thousands of pounds.

- Features. Design a form as wide as a window of 250 characters, long as needed. Cursor movements are 'left, right, up, down, delete left delete right, tab right-left-up-down' Paint your form as you like directly on the screen.
- Text..... Write a letter as you see it on the screen, edit it then simply enter ^P to print.
- Calc..... Set into the form, your data fields, "££££££" and specific file-related activities, formulae and validation checks. Enter values and see the spreadsheet calculate itself.
- Database. Search files for data to be inserted to fields specified. All the features of DBMS III, explained elsewhere in our ad.

Here's an example of an invoice you might design for your stationery

You could design your own spreadsheet, order form, statement, or any other kind of form that is required to fit your existing stationery.

INVOICE <0>££££££££££				
To £<1>££££££££££££££	From: G.W. Ltd			
£<2>££££££££££££££££££	55 Bedford Court Mans.			
£<3>££££££££££££££££££	Bedford Avenue			
£<4>££££££££££££££££££	London W.C.1.			
£<5>££££££££££££££	Tel: 01-636 8210			
Date <6>££.££	Tax point <7>££.££	Agent <8>££££		
Quantity	Description	Cost	Tax	Total
<9>£££	<10>££££££££££££££££££	<11>££	<12>££	<13>££££
<14>££	<15>££££££££££££££££££	<16>££	<17>££	<18>££££
and so on...				
Total...<19>££££££		Tax...<20>££££		

- <??> items <1> to <5> internal command to request name input, and then search an address file for details.
- <??> items <6> to <7> request date input and validate.
- <??> item <8> request agent number and validate range.
- <??> <9> request quantity, validate range.
- <??> <10> request description, search file, accept, and calculate fields <11>, <12>, <13>, if finished in-voice then calculate fields <19> and <20>

Now comes the more valuable facility, you can provide the 'FORM' with file-related instructions, not only to request a 'console' input for a file search against names, and stock, but after the invoice is finished the fields you have selected may be passed to related files.

EG: Send fields <0>, <1>, <6>, <7>, <11>, <12>, <13>, <19>, <20> to a sales ledger.
Then send fields <9>, <10>, <11>, to product analysis file.
Then send fields <0>, <1>, <7>, <19>, <20> to V.A.T. file
Then send fields <10>, <11>, <12>, <13> to Nominal ledger.

● Circle No. 122

Available at present only on SIRUS/IBM PC.

If the number of computer systems on the market leaves you totally bewildered, we don't blame you.

And that's not your only problem. If you are not very careful, the system you buy today could well be obsolete tomorrow. That's how fast computer technology is progressing.

But take heart. There is one computer system that won't become obsolete. Because it is modular in concept it can be expanded both inside and outside to accommodate extra capacity and new advances—as well as being able to increase in size and capability to keep pace with your own growth or changing requirements.

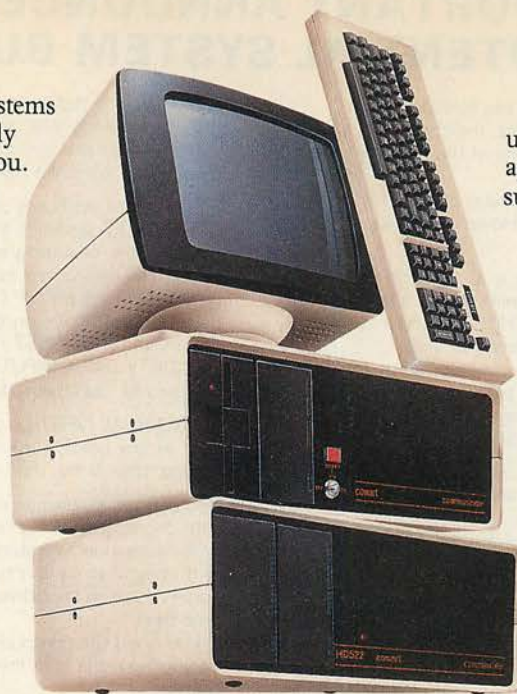

You have a choice from a virtually unlimited range of CP/M compatible application software. Plus the support of total dealer back-up.

And, most important, you won't find that you've bought a system that suddenly doesn't meet your needs. The Communicator offers the facility to enhance and upgrade existing models to take account of new applications.

Comart have also met the stringent CCTA requirements. Which means we are A1. In short, Comart Communicator systems can keep pace with both progress and innovation.

So don't get bogged down with obsolete equipment. Contact your Comart dealer for a demonstration now.

The Comart Communicator. One computer system that won't sink into obsolescence.

What's more, it's British.

At any one of the addresses listed below you can see the remarkable flexibility of a Comart Communicator system for yourself.

In under three years, it has become a complete family of compatible, fully expandable microcomputer systems, covering

20 models and including single user, multi-user and multi-processing systems.

To become technical for a moment, there's a choice of 8 or 16 bit processors, up to 1 megabyte of RAM and a wide range of floppy and hard disk storage capacities and add on modules.

COMART COMMUNICATOR SPECIFICATIONS

	CP100 Series Systems	CP1000 Series Systems
Microprocessors:	8 Bit Z80A (1 to 5)	16 Bit 8086
Memory:	64K-512K bytes	256K-1M byte
Storage:	390K or 790K byte diskettes 5M or 20M byte hard disks	390K or 790K byte diskettes 5M or 20M byte hard disks
Operating Systems:	CP/M, MP/M II & CP/NET	CP/M86, MP/M86
	Multi-processor, 1 to 5 users	1 to 8 users
Features common to both CP100 & CP1000 Series Systems		
Keyboard/Display:	105 Key, detached 14" green screen, swivel tilt.	
Expansion:	Internal—S100 cards, mainframe communications & protocols. External—stackable modules inc. cartridge tape & 8" floppy & hard disks.	

CP/M, MP/M II, CP/M86, MP/M86 & CP/Net are trademarks of Digital Research Inc. Z80A is a trademark of Zilog Corp. MS-DOS is a trademark of Microsoft Corp. Comart and the Comart logo are trademarks of Comart Ltd.

comart

Comart Limited, Little End Road, Eaton Socon, St. Neots, Huntingdon, Cambridgeshire PE19 3JG.
Tel: (0480) 215005. Telex: 32514 Comart G

A member of the Comart Group of Companies

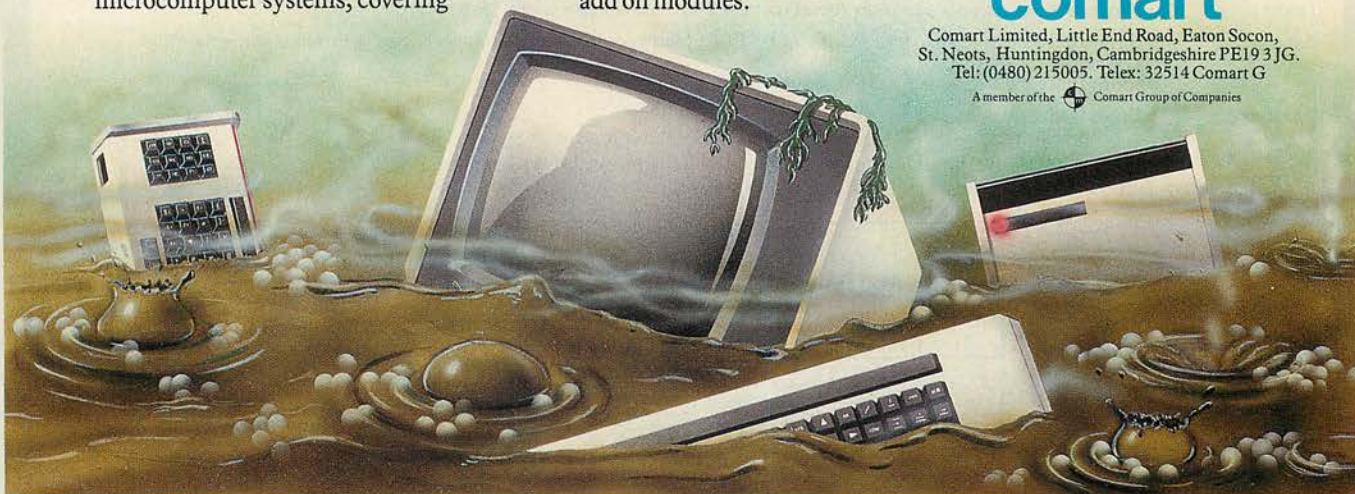

COMART COMMUNICATOR UK DEALERS

ABERDEEN
Granite Chips
Tel: 0224 22520

BEDFORD
Remdes-Bradley
Tel: 0234 68581

BEDS (AMPHILL)
M. E. Marketing
Tel: 0525 404262

BEACONSFIELD
Proton Computer Services
Tel: 04946 4910

BELFAST
Cardiac Services
Tel: 0232 625566

BIRMINGHAM
The Byteshop
Tel: 021-622 3165

CAMBRIDGE
Hi-Tek
Tel: 0954 81931

CAMBS (ST NEOTS)
Westcom
Tel: 0480 217217

CHANNEL ISLANDS
Bell Data Systems
Tel: 0481 26662

COLCHESTER
Eurotec Consultants
Tel: 0206 72538

DONCASTER
Spot Computers
Tel: 0302 25159

DUBLIN (EIRE)
Lendac Data Systems
Tel: 0001 710226

EDINBURGH
Holdene Microsystems
Tel: 031-557 4060

GLASGOW
The Byteshop
Tel: 041-221 8202

GLENROTHES
Computer Services Scotland
Tel: 0592 773710

LEEDS
Holdene
Tel: 0532 459459

LONDON EC4
Zygal Dynamics
Tel: 01-248 4883

LONDON SW2
Jarogate
Tel: 01-671 6321

LONDON SW6
Datafit
Tel: 01-385 6141

LONDON NW1
The Byteshop
Tel: 01-387 0505

MANCHESTER
The Byteshop
Tel: 061-236 4737

NOTTINGHAM
The Byteshop
Tel: 0602 40576

READING
M. E. Electronics
Tel: 0734 667663

SHEFFIELD
Hallam Computer Systems
Tel: 0742 663125

SOUTHAMPTON
The Byteshop
Tel: 0703 334711

STOCKPORT
Alpha Business Computers
Tel: 061 477 7799

SWINDON
Great Western Computing
Tel: 0793 485517

TORQUAY
Conoal
Tel: 0803 24311

WATFORD
Lux Computing Services
Tel: 0923 47367

WILMSLOW
Holdene
Tel: 0625 529486

WORTHING
Ace Computing Services
Tel: 0903 35411



The big match

RECENTLY I RECEIVED in the post no less than five copies of the same edition of the Digital Equipment Corporation new products bulletin *DEC Update*. Like most other American computer manufacturers, DEC is well known for its generosity with data books and technical magazines. But five copies, of the same magazine does seem excessive. Clearly there had been a foul-up in the DEC mailing list database.

Closer inspection revealed that the mailing labels on the envelopes were all different. To a hyperintelligent mega-being such as our postman it was obvious that all the envelopes were intended for me, despite the misspelled name on one envelope, the wrong company name on another and the inclusion of an unnecessary street name on a third. The conclusion is simple: compared to our postman the DEC database program is a real dunce, blind to the glaring similarities shared by the five mailing labels. Surely, I reasoned, a garbage-collection program could easily spot these similarities and purge the database of unnecessary destinations.

A moment's reflection convinced me that it may not be that simple. The computer time required to search a database consisting of many thousands of addresses, each consisting of a hundred or more characters, looking not for direct duplicates but for mere similarities, may make it more cost-effective to send out the redundant magazines.

Inept computers

A similar example of the ineptitude of current computers when faced with recognising similarities in text strings appears, most annoyingly, when they respond via the keyboard to those user-friendly query or prompt messages displayed on the VDU. Well written software will at least recognise that Y means Yes and N means No. Raise the intellectual level of the man-machine interchange much above that of the average three-year-old and the chances are that the computer will respond with a user-friendly message such as ? or, in more advanced systems

REDO FROM START

Of course, it is possible to write computer routines which recognise that

I AM EIGHT

means the same as "8" in response to the question

HOW OLD ARE YOU, EARTHLING?

but to make such features universal is either too much trouble or too time consuming at run time. What is sorely needed is some sort of hardware that specialises in recognising similarities between text strings; our very fast but exceedingly dim central processor would then not have to check things out the hard way.

Thanks to Proximity Technology Inc. and its new PF-474 chip that need may soon be satisfied. Inside the 40-pin dual-in-line package of the PF-474 there is a single

NMOS chip containing 45,000 active devices organised as the world's first intelligent string comparator. It is capable of comparing two strings of up to 127 characters each, reporting on the similarities that it finds by means of a 32-bit fraction which ranges in value from 0 for no similarities, to 1 for a perfect match. Even better, the PF-474 contains a ranking sub-system which keeps track of the 16 best matches it finds while the search continues. At the end of a database search the 16 closest strings can be recalled for further investigation or for modification.

Grey-matter CPU

Despite the undoubted abilities of the PF-474, it still can't compete with the average postman, who can actually understand the meaning of the text strings on the envelope. This facility allows the rapid assessment of similarities even by a very slow "grey-matter" CPU. The PF-474 operates purely statistically and makes no attempt at semantic analysis. This can sometimes be an advantage, especially if the strings are in code or in a foreign language, a situation which might put our postman into an infinite Do loop.

To programmers, the PF-474 appears to be a 1,024 byte region of memory split into four main blocks of 256 bytes each. The first block is the control section used to transfer control and status information concerning a search in progress. Next comes a parameter block organised as a look-up table which contains one byte of information for each of the 256 possible characters available in an eight-bit representation. For each character, three attribute parameters are stored: Weight, Bias, and Compensation. Every one of the possible characters can have individually established attribute parameters so that comparisons can be tuned to suit the application.

Third block

The third block is used to store the reference and current strings. The fourth block is used by the ranker for control purposes and to store the eight-byte entries in the ranked list. Four bytes denote similarity value; the other four contain the record number.

The parameter memory is used to vary the chip's notions of similarity by means of the character attribute values. The Weight attribute defines the importance of a particular character in a match, so spaces could be given a low weight while vowels might rate a higher weighting than consonants. The Bias attribute is used to add a directional preference to the comparison process. When bias is negative, a match at the start of a string will have more effect on the outcome than a match at the end, and vice versa for a positive bias. The third attribute, Compensation, allows trading off between two different types of dissimilarities, namely Permutation, or scrambling, and Content arising from insertions, deletions or changes. A low compensation value causes the PF-474 to ascribe less importance to variations in the position of a letter; a high compensation causes it to ascribe less importance to missing letters.

The programmer's ability to vary the terms on which the PF-474 computes similarity makes this device a great deal smarter than any achievable software implementation of a string-matching routine. It also enables the chip to be used with any eight-bit code, including straight numerical binary, not just ASCII. This in turn opens the door to the use of the PF-474 in a host of other pattern-recognition problems, such as image processing or speech recognition, for example.

Pipelined path

The PF-474 is fast. It takes only 75 microseconds to compare two 45-character strings, thanks to a pipelined computation path which is nine stages deep. This level of performance is at least an order of magnitude faster than anything which could be achieved on the best general-purpose microprocessor emulating the PF-474 algorithms in software. It can be increased still further by using multiple devices acting in parallel on separate areas of memory.

If, like me, you can't wait to get this sort of capability running on your own system then you may be in luck. Proximity Technology has designed PF-474 interface boards for the IBM PC and the Apple II, and also has the all important software divers available to go with them. □

BUY AN apple

In our Winter Sale

while stocks last

The Professional Home Solution

Apple IIe 64K
Disk Drive
With Controller } **£760**

Includes over **£300**
of extras

TV modulator colour and
sound

3 Apple books

£100 Training Voucher

Apple Monitor Voucher

Software Vouchers

Micronet/Prestel Voucher

Windfall Voucher

Apple Sports Bag

The Personal Solution

APPLE IIe

Apple IIe 64K
Disk Drive with
80 column card
12" High Res.
Monitor } **£900**

Apple IIe	£599
Monitor	£90
Colour Monitor	
RGB and Composite	£199
Disk Drive	
Without	£200
80 col + 64K	£150
Applewriter	£119
Quickfile	£ 60
Multiplan	£175
80 Col. Card	£50

The Business Solution

APPLE III

Apple III 256K
Monitor III
SOS System Software
with Apple II emulation
built in disk drive } £1999

Apple III 256K
Computer as above
plus Profile 5mbyte
hard disk } £2800

Applewriter III	£130
Visicalc III	£170
Quickfile III	£ 55
(All 3 packages for £295)	
Complete range of invoicing, ledgers and stock packages available.	

THE SUPPORT PACKAGE

- **Training** — Free half day appreciation course before you BUY
— Free one day application training when you buy your Apple from us.
- Full year guarantee on all parts and labour.
- On site maintenance available.

Simmons Magee Price Promise

We will guarantee to compete with any
advertised price on APPLE.

Printers

EPSON	RX80	£242
	RX80ft	£269
	FX80	£350
OKI	82A	£299
	92	£439

For computerised solutions to business problems contact

SIMMONS MAGEE COMPUTERS LTD

13 YORK STREET, TWICKENHAM, MIDDLESEX TW1 3JZ

01-891-4477

ALL PRICES EXCLUSIVE OF V.A.T.

48K SPECTRUM OWNERS *Read This From*

...LET'S GET DOWN TO BUSINESS...

★ ★ ★ FINANCE MANAGER ★ ★ ★

FINANCE MANAGER is a powerful, flexible and fast MENU DRIVEN general purpose program carefully designed to handle up to 255 separate accounts for domestic and business accounting applications. The magic of MACHINE CODE has enabled us to produce the very latest "on the page" presentation which lets you enter and edit data naturally, as if with a pencil and paper.

These screens are just a sample to show the style of the program:

But that's not all, not by a long way. This program automatically raises a corresponding debit or credit for every entry, and will even open a new account if an entry features an unrecorded account name.



Accounts can be **MERGED, DELETED, ANALYSED, MARKED** as priority, **RENAMED, EDITED** and **SCROLLED**. Transactions can be **RECONCILED, AMENDED, DELETED, PRINTED, DESCRIBED** for analysis and **RENAMED**. Standing orders can be **APPLIED, REMOVED, DESCRIBED, AMENDED, DELETED** and even **DUMMIED** for planning purposes. Other features include **DATE CHANGE, RUNNING TOTALS, 2 KEYBOARD MODES, PRINT PAGE/LINE/BLOCK/FROM END/FROM START/FROM DATE** etc., **LIST BALANCES, FIELD ERASE/INSERT/DELETE, EXIT TO BASIC**. You may not want all these features but they are there just in case.

★ ★ ★ ADDRESS MANAGER ★ ★ ★

ADDRESS MANAGER utilises the same "on the page" presentation as **FINANCE MANAGER** and offers Spectrum owners a professional standard address filing, indexing and retrieval system. Below are examples of the screen presentations.

ADDRESS MANAGER has been carefully constructed to provide the user with a tool that is extremely friendly and easy to use, the speed and presentation of this program are second to none.



ADDRESS MANAGER features **MULTIPLE INDEXING** via our 3 way 3 character index, an ability to store over 400 full names and addresses or 1500 individual names/titles.

USES include storing and updating names, addresses and phone numbers, printing out Xmas card lists, etc, mail order work, customer classification by type size (doctors have used this program to catalogue patients by treatment).

★ ★ ★ 80 COLUMN-PLUS 80' VERSIONS ★ ★ ★

80 column versions of both these programs are available. These work in conjunction with the Kempston Centronics Interface and Centronics Printer. Write to us for a quotation for the software, the interface and the latest high performance Japanese Dot Matrix Printer — you will find our prices very competitive.

VISIT YOUR LOCAL SOFTWARE STORE NOW AND ASK FOR FINANCE MANGER AND ADDRESS MANAGER BY NAME —

also available from selected branches of WH SMITH, BOOTS and MENZIES

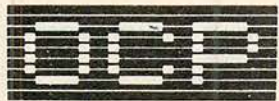

SOFTWARE ★ ★ ★ SIMPLY THE BEST ★ ★ ★

If you experience difficulty obtaining your copies of these programs send a cheque or postal order for £8.95 (£19.95 for **PLUS 80** versions) or telephone your details to (0753 888866):

Oxford Computer Publishing Ltd.
4 HIGH STREET, CHALFONT ST PETER, BUCKS SL9 9QB

IF YOU have ever developed a large suite of programs, such as an accounting system or a payroll, you will have come across the problem of operator messages. Apart from the tedium of having to code scores of Print statements, the sheer bulk of text needed for menus, prompts, error messages and help screens threatens to swamp the programs.

A common solution is to hold all the messages on a direct-access disc file, to be read in as needed. But frequent disc accesses will slow down the program considerably. Ideally, you need to keep the most common messages in RAM, and the others on disc. The trouble is that often you have no way of knowing in advance which messages are going to be needed at which times.

Least used

The solution to this problem provides a good illustration of the least used/first discarded algorithm. This technique has many applications in programming. The basic idea is to store the most frequently used items in a buffer. As each new item — in this case, a message — enters the buffer, it pushes out the item that has been used the least often.

Here is what you do. First, set up a disc file containing all the messages that you are likely to need. Listing 1 shows an interactive program that will do this. The program is written in Microsoft Basic, but it is easily translated to other dialects and languages. For simplicity, assume that the messages are fixed in length. Each message is identified by a consecutive message number which is the same as its record key. The program will invite you to enter a message number. It will then display the text of the corresponding message, if any. You may press the Return key to retain this message, or enter a new text to replace it. To stop the process, enter X instead of the message number.

Separation helps

The beauty of this arrangement is that it keeps the messages separate from the application programs. You can enter the messages as you go along, and change them without having to alter your coding. Think how useful this would be if you ever wanted to bring out a foreign-language version of your software.

Listing 2 shows a separate program that will initialise a new message file, setting the entire text to spaces. This is not vital, but it will save garbage from creeping into the text the first time that you use the interactive update program.

In the programs that actually use the message file you will need a table to hold the more frequently used messages. In fact, you need two tables: one to hold the text itself and another for the corresponding message numbers. You will also need a subroutine, similar to the one shown in listing 3, line 5000.

Putting the message across

This month Mike Lewis offers some tips on handling text for prompts and menus.

Listing 1.

```

100 ***** AN INTERACTIVE PROGRAM TO SET UP AND UPDATE THE
                MESSAGES FILE
110 '
120 ***** CONSTANTS USED:
130             MAXMESS%=250             *HIGHEST MESSAGE NUMBER
140             MESSLGTH%=32            *MESSAGE LENGTH
150             MESSFILE$="MESSAGES.TXT" *FILE NAME
160 '
170 OPEN "R",1,MESSFILE$,MESSLGTH%:
                FIELD 1, MESSLGTH% AS MESSBUFF$ *OPEN THE FILE AND ALLOCATE
                A BUFFER FOR IT
180 '
190 PRINT: LINE INPUT "Message number? ", THISNO$
200 IF THISNO$="X" OR THISNO$="x" THEN
                CLOSE 1: END *PROGRAM TERMINATES
210 IF VAL(THISNO$)<1 OR VAL(THISNO$)>MAXMESS% THEN
                PRINT: PRINT "Out of range": GOTO 190 *INVALID MESSAGE NUMBER
220 THISNO%=VAL(THISNO$)
230 '
240 GET 1, THISNO% *READ EXISTING TEXT
250 '
260 PRINT "Old message... "; MESSBUFF$
270 LINE INPUT "New message... "; THISMESS$
280 IF LEN(THISMESS$)>0 THEN
                LSET MESSBUFF$=THISMESS$: PUT 1, THISNO% *REWRITE WITH NEW TEXT
290 GOTO 190

```

Listing 2.

```

100 ***** PROGRAM TO INITIALISE A MESSAGE FILE
                SETS ALL MESSAGE RECORDS TO SPACES
110 *****
120 *****
130 *****
140 ***** CONSTANTS USED:
150             MAXMESS%=250             *HIGHEST MESSAGE NUMBER
160             MESSLGTH%=32            *MESSAGE LENGTH
170             MESSFILE$="MESSAGES.TXT" *FILE NAME
180 '
190 OPEN "R",1,MESSFILE$,MESSLGTH%:
                FIELD 1, MESSLGTH% AS MESSBUFF$ *OPEN THE FILE AND ALLOCATE
                A BUFFER FOR IT
200 LSET MESSBUFF$=" " *SET THE BUFFER TO SPACES
210 FOR J%=1 TO MAXMESS%:
                PUT 1, J%:
                NEXT J% *FILL THE FILE WITH SPACES
220 CLOSE 1: END *CLOSEDOWN

```



You call this subroutine whenever you want to display a message. Set the message number in the appropriate variable, in this example

THISMESS%

The routine searches the message number table for the required code. If the code is not present, it reads the message from the disc file and puts it at the bottom of the table, overwriting what was there before.

After it has displayed the message, the subroutine swaps it with the one immediately before it in the table. It also swaps the message numbers. In this way, the messages that are used most often will trickle through to the top of the table, and the less common ones will tend to the bottom, where they will become eligible

for overwriting by new items coming in.

This is a very efficient way of handling large amounts of text. The commoner messages can be fetched extremely quickly, and disc accessing is kept to a minimum. The extra coding needed will add very little to the overhead of your programs, and in most cases the whole process will be faster than the alternative: loading every message every time the program is run.

Length varies

Among the enhancements that you may wish to make to this technique is altering it to cater for variable-length messages. A simple way of doing this would be to make

each message a multiple of the basic length. The first byte of each message should be used to indicate the number of such multiples used.

An important question is the size of the message table, which in the example is

LIMIT%

You have to balance the additional searching time needed for a large table against the reduced number of disc accesses. Your best bet is to experiment until you find the best setting for your application.

Consider too the initial values of the table entries. The algorithm will work perfectly well if the table starts empty, but it will not reach full efficiency until it fills up. You may like to initialise the table so that it contains any messages that are likely to be needed at the start of the run — a sign-on message or copyright notice perhaps.

Listing 3.

```

1000 ****      SKELETON OF A PROGRAM TO DEMONSTRATE THE USE
                OF A MESSAGES FILE.

1010 ****
1020 ****      THE PROGRAM CARRIES OUT THE NECESSARY INITIALISATION
                AND THEN DISPLAYS A MENU, THE TEXT OF WHICH IS HELD
                ON THE FILE AS MESSAGES 25 - 35.

1030 ****
1040 ****      THE ACTUAL MESSAGE HANDLING ROUTINE STARTS AT LINE 5000
1050 *

1060 ****  CONSTANTS USED:
1070      MESSLGTH%=32          *MESSAGE LENGTH
1080      MESSFILE$="MESSAGES.TXT" *MESSAGES FILE NAME
1090      LIMIT%=20           *NUMBER OF ENTRIES IN TABLE
1100 *

1110 ****  INITIALISATION:
1115 *
1120 OPEN "R",1,MESSFILE$,MESSLGTH%:
        FIELD 1, MESSLGTH% AS MESSBUFF$      *OPEN THE MESSAGES FILE
1130 DIM TXT$(LIMIT%), MESSNO%(LIMIT%)      *ALLOCATE THE TWO TABLES
1140 *
1150 *

2000 ****  DISPLAY MENU:
2010 *
2020 FOR THISMESS%= 25 TO 35
                *THISMESS% CONTAINS REQUIRED
                MESSAGE NUMBER
2030     PRINT      *DO A BLANK LINE BEFORE EACH
                ACTUAL LINE OF TEXT
2040     GOSUB 5000 *CALL THE MESSAGE ROUTINE TO
                OUTPUT THE REQUIRED TEXT

2050 NEXT THISMESS%
2060 *
2070 *

5000 ****  MESSAGE-HANDLING ROUTINE:
5020 *      ON ENTRY, THISMESS% CONTAINS REQUIRED MESSAGE NUMBER
5030 *
5040 FOR J%=1 TO LIMIT%:
        IF MESSNO%(J%)=THISMESS% THEN
                MPOINT%=J%: GOTO 5070      *MESSAGE ALREADY IN TABLE
5050 NEXT J%
5060 GET 1, THISMESS%: MPOINT%=LIMIT%:
        MESSNO%(MPOINT%)=THISMESS%: TXT$(MPOINT%)=MESSBUFF$
                *MESSAGE NOT IN TABLE, SO
                READ IF FROM DISK AND PUT AT
                END OF TABLE
                *PRINT THE MESSAGE
5070 PRINT TXT$(MPOINT%)
5080 IF MPOINT%>1 THEN
        SWAP TXT$(MPOINT%), TXT$(MPOINT%-1):
        SWAP MESSNO%(MPOINT%), MESSNO%(MPOINT%-1)
                *MOVE MESSAGE UP ONE PLACE
5090 RETURN
    
```

Mailmerge speed-up

ONE OF the selling points of Micropro's WordStar package is its ability to print one document while you are editing another. This background printing does make the keyboard response sluggish, but you miss it when it is not available, and many people have wished it could be extended to merge-printing — that is, printing with Mailmerge.

Simultaneous printing and editing is possible with Mailmerge, after a fashion, although the technique is not described in the manual. It works like this. First, merge-print the document in the normal way, but answer Y when Mailmerge asks

DISK FILE OUTPUT?

Specify a suitable temporary file for the output. Mailmerge will write an image of the eventual printout on this temporary file, the whole process taking a fraction of the time needed to print to paper.

Next, print the temporary file using the normal print option, not merge-print. In this case, answer N to

DISK FILE OUTPUT?

but answer Y to

SUPPRESS PAGE FORMATTING

Your Mailmerge output will now go to the printer, during which time you may carry on editing. Finally, delete the temporary file.

However, there are a couple of snags. The process cannot handle certain dot commands, such as those for character width and line height, and you may need to re-enter these in the intermediate file. Also, micro-justification does not work, since all spaces will be "hard". But the biggest snag is the large amounts of extra disc space that this process will need. Whether it is worth it is for you to decide.

Funny how no one takes an interest in floppy disks until they go wrong.



As one floppy disk looks much like any other, you probably pay scant regard to the type being used with your micro. Until that dreaded day when something happens (or rather doesn't happen) and the words 'Disk Error' means your irreplaceable data has gone forever.

Suddenly, everyone from the Managing Director

downwards wants to know why something as important as a floppy disk wasn't chosen with more care.

Having realised a floppy disk's true worth, 3M make them 32% less abrasive than the industry average.

They can exceed 10 million passes (equivalent to changing data every hour for centuries) as opposed to the



3M is a trademark.

ere 3½ million expected by disk drive manufacturers.
And each and everyone is subjected to analogue and
igital tests before leaving the factory.

Which is why we guarantee them for life.

Naturally, if you're already using disks that have
ven trouble-free service so far, you may see no reason to

change them. Just pray that decision never comes to the
attention of the Managing Director.

If you would like to know more about 3M floppy
disks or where your closest distributor is, give us a ring at
3M on Bracknell (0344) 58502.

Who's brave enough to choose the floppy disks in your company?

PETE & PAM - THE APPLE, IBM

AUTHORISED FOR APPLE SALES IN LANCASHIRE

THE INCREDIBLE JACK OF ALL TRADES

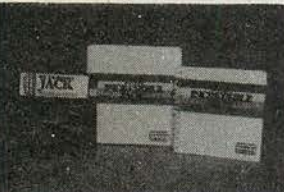

What is the incredible JACK of All Trades?

JACK is an integrated applications software package for Apple II computers. "Integrated" means that JACK can do Word Processing, Data Base Storage and Retrieval, and Calc Analysis all at the same time. Because it is integrated JACK lets you do all these things with just one simple set of commands.

Who should buy JACK?

JACK is perfect for the first-time computer buyer who works with information, be it words, numbers, or lists with words and numbers in them. You can learn JACK just once and do three times as much with your computer as with any single-function software. And JACK costs far less than buying three different programs! Experienced computer-users who need to integrate their applications should also consider JACK. If you've ever wished you could integrate a document and a calc model without scissors and glue, or 'printing to disk', JACK is for you.

What kinds of work can I do with JACK?

If your work consists of words, lists, or numbers, JACK can probably handle it. If you work with words and numbers at the same time, or lists with numbers, or even lists with words, JACK will make that work easier than any other software you can buy. Things you can't do with most software are easy with JACK: write a memo with calculations and do those calculations at the same time; or create form letters from a mailing list with a single command, or make a list of 'what-if' options and select the best one by simply telling the computer what you want.

What else makes JACK special? Convenience. Most people use computers to prepare documents, to handle information, and to answer "what-if"-type questions. Without JACK, it takes a separate program to do each task. But most people don't work that way. We work on tasks that involve words, numbers, and record-keeping all together. And those tasks don't conveniently sort themselves into "word processing tasks", "calc tasks", and "data base tasks". By allowing you to work on one task in all three ways, at the same time, JACK offers greater convenience than single-function software packages. JACK is THE software that lets your personal computer work the way YOU do, instead of the other way around.

How long will it take me to get going with JACK? Experienced computer-users have picked up JACK in as little as half an hour. First-timers may take a day or two. JACK comes with a step-by-step tutorial of seven lessons, so you can go at your own pace.

INCREIBLE JACK
£129.50 + VAT

SPECIAL OFFER

LIMITED PERIOD ONLY
APPLE DOT MATRIX
PRINTERS
£299 plus VAT



300bps (30 characters per second) FULL DUPLEX over the public telephone network

Remarkable low price

Conforms to CCITT V21 international standard

Originate and answer mode

Direct connect for best performance

Small and lightweight

British Telecom approved

Connect a terminal or computer to a normal telephone line through Buzzbox and data can be sent and received across the street, or literally, around the world!

Unlike acoustically-coupled modems, which are prone to data errors from extraneous noise, Buzzbox connects directly to the telephone line for high quality performance. It conforms to the international V21 standard for data transmission at 300bps full duplex, so there's no compatibility problem at the remote end.

Buzzbox operates in both Originate and Answer mode. It is powered by two PP3 batteries, or for prolonged use, an optional mains adapter can be provided. The modem is so small and lightweight it can comfortably be carried in a jacket pocket.

The digital interface conforms to RS232C (V24) levels and is fully compatible with terminals and microcomputers which have this interface at 300bps. The data interface is connected through a 5 pole DIN plug included with each Buzzbox.

£69.52 + VAT

JACK REPORT

WHAT IS JACKreport? JACKreport is a Report Generator designed for use with the incredible JACK-Of-All-Trades. JACKreport uses information from your JACK files to create customized reports.

WHOSHOUld BUY JACKreport? People who are considering JACK (or already using JACK) for personal filing. If you need to calculate the total value of your inventory, or count the number of labels in your mailing lists, or summarize data from your JACK files, JACKreport lets you turn this information into clear and useful reports.

£75 + VAT

THE C.I.A.

Is a list of powerful disk espionage utilities that allow you to investigate, edit, locate, list, trace, rescue, translate, patch, repair, verify, examine, protect, unprotect decrypt and analyse programs or textfiles on normal and protected disks.

£35 + VAT

MULTIMATE

Complete Function Key Orientation

Multimate™ is the fastest, easiest to use and most powerful word processor available on microcomputers today. Multimate™ offers a complete function key driven system for efficient document creation and modification. Most functions are performed while in the document (rather than from menus or utilities) with a minimum number of keystrokes.

Cursor Positioning Functions

Multimate™ has the most complete set of cursor positioning capabilities available today.

Editing Functions

The standard functions such as Insert, Delete, and Move, as well as the more complex functions, are self-prompting and are performed with a minimum number of keystrokes.

Formatting Functions

Full control over tab settings, line spacing and line length are provided by Multimate™'s format line feature. An unlimited number of format lines may be included in your document. Format line modification results in automatic text readjustment from the modified format line to the next format line or the end of the page.

Printing Functions

Multimate™'s complete printer control capabilities allow full utilization of the features available on your printer. Multimate™'s Header and Footer facility is unsurpassed in flexibility and ease of use. Alternate Headers and Footers are supported as well as the ability to change Header or Footer text as often as needed within a document.

Printer Control Codes provide special printing functions unique to your printer. Document printing is performed in a "background" mode so that while a document is being printed, you may create or revise another document. Foreground printing is also provided.

The Printer Queue Control allows you to control the documents to be printed by deleting a document from the queue, placing a document on hold or releasing it from hold, moving a document to the top of the queue, and restarting a document currently printing.

Advanced Functions

Multimate™'s Library function allows you to store an unlimited number of boilerplate phrases, paragraphs, or forms (up to one page each) on a diskette. These Library entries may be recalled for insertion into your document whenever specified.

Merge, Repagnate, Column Manipulation and the other advanced functions are also available and equally easy to use.

With the Column Manipulation function, you may Move, Copy, Delete, or Insert columns of text or numerical data in a page of your document with a few keystrokes.

Column Calculation functions provide you with the following math capabilities. Vertical and Horizontal Addition to sum columns or lines of numerical data. Subtraction, which is accomplished by designating a number as negative, and thereby is equivalent to adding a negative number. Combined, these column-oriented functions yield you considerable flexibility and versatility when creating or editing documents with numerical data.

Mylar Key Labels

See-through, color-coded, adhesive labels are provided for quick and easy identification of the function keys. Both a Help screen and a Function Location Chart are provided for use when you are working on an unmarked keyboard.

£339.00 + VAT



SPECIAL OFFER BASF DISKS

10 Disks for the price of 9! Single Sided Single Density suitable for Apples.

10 for £16.11 + VAT
100 for £148.50 + VAT

Double Sided Double Density suitable for IBM PC

10 for £24.75 + VAT
100 for £225.00 + VAT

Double Sided 96 tpi suitable for Sirius/Victor

10 for £30.60 + VAT
100 for £279.00 + VAT

A whole range of other disks available - ring for details.

5 1/4" Disk Boxes £1.95 + VAT
5 1/4" Head Cleaning Kits £15.95 + VAT

MAGICALC

Both the Apple II (minimum 48K) and the new IIe are supported, as well as expanded memory cards up to a total memory of 512K (four 128K cards). There are 254 rows and 63 columns of work space on the spreadsheet. The program works in 40 or 80 columns (most of the 80-column cards are supported). A 70-column format is provided using Hi-Res graphics. Both uppercase and lowercase entry/display are allowed. The program can be used with multiple drives including hard disks.

Q. What advanced spreadsheet features does MAGICALC have?
A.1. Columns may be different widths to fit your data and formats.



2. Columns may be made invisible to hide data or to operate as a third-window on the data (bring first and last quarter figures together, for example, while leaving the title and other windows unchanged).

3. Individual cells may be made invisible to hide sensitive data.

4. Cells may be protected to prevent inadvertent erasure.

5. Cells may be protected to allow only numbers or labels to aid in the setup of templates.

6. A "tab" to the next unprotected cell is provided for fast data entry into templates.

7. On-screen indication of Global Computation Order is provided, as well as Manual or Automatic Computations mode.

£69 + VAT

RENTAL

Want to rent an Apple or an IBM PC... a QX10 a Printer or anything else can think of? Call either our offices for a quote from one machine to five from one day to a thousand years.

Share Your IBM.XT Hard Disk or other Hard D

- * Local Area Network and Shared Resource Management
- * Broadcast Coaxial Bus Networks
- * Network errors handled similar to DOS
- * Multi-tasking use of Print Modems, etc.
- * Remote PC Execution
- * Background program execution at Shared PC
- * Multi-tasking use of Print Modems, etc.

- * Performance
- * Serial coaxial bus at megabit/sec up to 7000
- * No significant User PC degradation

- * IBM MS-DOS Transparency
- * MS-DOS 1.1,2.0
- * Off the Shelf program execution over network
- * File Transfers use MS-DOS commands
- * Ease of Use
- * Single PC slot for PCNet adapter card
- * Standard coax and BNC connectors
- * Automatic Load using AUTOEXEC BAT

- * Disk and File Sharing
- * Public and Private Files/Volumes and Disks
- * File/Record Locking and Unlocking
- * No Dedicated File Server. PC can act as File Server
- * Multiple File Servers
- * Compatible with
- * IBM *SYSGEN
- * Tallgrass
- * Many other well known hard disks

PC NET £1339.00 + VAT

THE APPLE-IBM CONNECTION

This might sound like heresy but we're sure that some of you are going to want to transfer any kind of file from and to the IBM-PC. The ability to upgrade files from the 8 bit Apple to the 16 bit IBM-PC must be of use to someone?

Can also be used to send electronic mail messages in an Apple / IBM-PC network. Comes with a disk for Apple and a disk for IBM-PC.

£139 + VAT

PC, & EPSON SPECIALISTS! AND LONDON, AND IBM PC IN LONDON.

SPECIAL OFFER A E WORD HANDLER

Functions seen on the screen.
Lower and Upper case
Underlining
Perscript, bold, and un-
dented tabs.
Left and normal justification

£39.95 + VAT

E LIST HANDLER

List Handler you can hold
up to 3000 records per drive so
24000 can be kept on-line
at the same time with multiple
drives.
Inventory
Form letters
Mailing lists
Voice
Product lists

- short newsletters
- personnel directories
- labels

List Handler will run on one
more drives, read and write
format and has unlimited
fields. **£33.95 + VAT**

PC CROSSTALK

The Crosstalk 16 XV1 comm-
unications package can emulate
many other terminals. It can
capture data and transfer data
files with error checking.

You can instruct it to call up
"LOG IN" and "S" commands to
another computer. It is simple to
operate and has a "help" facility.
It is fast and comes set-up to
operate on IBM 3101, DEC VT
100, ADDS Viewpoint, Televideo
910/920.

£134.48 + VAT

PACK-A-MAC HAS MORE MEANING THAN YOU THINK.

THIS IS "BUY-YOURSELF-A-BUFFER-MONTH"
You'll never again have to waste time waiting for your
printer!
The buffer will instantly increase your efficiency, and eliminate
frustration of waiting for a printer to finish. Now you can
simply dump your printing data directly to a buffer and
CONTINUE PROCESSING! Buffers come in a variety of
formats, methods, and sizes. There is a buffer available for any
combination of computer/printer. If in doubt, ask our staff
advice.

IN-LINE BUFFERS

Self-contained units with their own power supply.

Parallel In-line £199 32K Serial In-line £199
Parallel In-line £225 64K Serial In-line £225

Additional add-on (max 256K in total) £116 + VAT
All prices + VAT

ALL BY PRACTICAL PERIPHERALS INC.

EPSON INTERNAL PRINTER BUFFERS

The buffers go inside the printer and use its power supply

Practical Peripherals Parallel (upgradable to 64K) £115
Practical Peripherals Serial (upgradable to 32K) £115

Ports hardware handshake + XON/XOFF up to 19200
8K Wizard Parallel (upgradable to 64K) £109
All prices + VAT

APPLE INTERNAL BUFFERS

Keyboard docks to your existing interface, takes up one
slot and using the Apple power supply.

Bufferboard £109 + VAT 64K Buffer board £169 + VAT
Bufferboard for Apple parallel/Epson parallel/and Grappler
interfaces.

BUFFERED INTERFACES

Combined printer interfaces and buffers, taking up one slot
using the Apple power supply.

Buffered Grappler Parallel £179 + VAT
Microbuffer II Parallel £139 + VAT
Microbuffer II Serial £139 + VAT
Gram Serial/Parallel £129.95 + VAT
Gram Serial/Parallel £218.00 + VAT

THE APPLE PROFESSIONAL HOME COMPUTER



YOU GET:

An Apple IIe
Disk Drive with Controller
TV Modulator (Colour and Sound)
Exclusive Apple Bag
Plus MONEY OFF VOUCHERS
FOR

£25 off Apple IIe Monitor (£149
+ VAT)
£25 off 1 of the Apple discovery
games
or Apple Logo
or Applewriter IIe
or Quickfile IIe
46% off Micronet 800 Service a
saving of £79.95 which includes:

- * Modem
- * Communications Card
- * British Telecom Jack Plug Installation
- * Postage/Packing/Insurance

1 days FREE training at an Apple
Training Centre Value £100
Various Vouchers for money off
Pete & Pam distributed software.

£999 including VAT

Get into Personal computing in
a big way!

Ask about **INTEREST
FREE CREDIT**

PC SYSGEN IMAGE

Don't Pay More than you have to.

If you've invested in the IBM
PC-XT or an IBM expansion
chassis, chances are you're doing
important things.

Now: May we suggest that you
think ahead to the unthinkable:
total wipe-out. Your hard disk
may never crash and destroy all
your files. But it can. That's
why the Sysgen Image was
invented. It lets you back-up all
your data—your entire hard disk—
in about five minutes a day. On a
handy little tape cassette. It's
insurance against the unlikely
event that your hard disk will
lose what you've stored on it.

Just stop and ponder a moment
about what would happen to your
operation if you somehow lost all
the data, letters, invoices and
phone numbers on your XT's
hard disk.

£899 + VAT

SIDEWAYS™

FOR EASY READING HARD COPY

Now you can print all the
columns of your spreadsheet, all
at one time, all on one continuous
page. Sideways, the ingeniously
simple software program, causes
your hard copy to print out —
you guessed it — sideways. So
your spreadsheet columns need
never fall off the edge of your
printer paper again.

System requirements:
IBM Personal Computer
Parallel/serial printer interface

One of these graphics printers:
Epson MX-80/100, FX-80/100
IBM Graphics Printer
Okidata Microline series
C. Itoh Prowriter

IDS Prism, 460 or 560

Compatibility:

SIDEWAYS is compatible with
spreadsheet programs such as
Lotus 1-2-3, VisiCalc, Multiplan,
and Supercalc, as well as most
word processors. **£49.49 + VAT**

MULTI-TASKING PC DOS



AND MAKE ONE IBM PC WORTH NINE

TASCMASTER SOFTWARE does
that by converting PC-DOS to
CONCURRENT PC-DOS thus
enabling you to create up to 9
tasks and run up to 9 programs
simultaneously. TASCMASTER
DOES THE WORK OF NINE.

While you are working with a task
on the screen other tasks are
working for you. To give you
every board you may need for
your IBM PC we include with
TASCMASTER SOFTWARE a
powerful MULTIFUNCTION
board FREE!!

Take your choice of:
ADDRAM ELITE FEATURES or
ADDRAM PLUS FEATURES
with RAMDISK and RAMPOOL
SOFTWARE TOO.

By Profit Systems Inc.
£349.00 + VAT

COPY II PLUS

£39.95 + VAT

A set of disk utilities for Apple
II or IBM PC combining the
most asked for features into
one low priced package.

Includes: BIT COPY, SECTOR
EDITOR, VERIFY DRIVE
SPEED, COPY DISK, DELETE
DOS, VERIFY FILES, VERIFY
DISK, UNDELETE FILES.

BUSINESS USERS—

Ask about our specialist
computer leasing plan/or our
interest-free credit scheme!

SPRING SALE

SAVE 15%!!*

Wordstar Training Pack Apple	24.65
Mailmerge Training Pack Apple	24.65
Wordstar Training Pack IBM	24.65
Mailmerge Training Pack IBM	24.65
Versaform Hard Disk Ver. For II	250.75
The WORDprocessor BIBLE TUTOR	126.65
The WORDprocessor BIBLE Tut PC	126.65
Programmable Timer 7440	75.65
Finger Print Epson Print Mod	33.95
Sweet-P Plotter (parallel)	466.65
Sweet-P Plotter for IBM-PC	466.65
Sweet-P for Osborne	505.75
Pipeline Random Access buff 8K	126.65
Green 12" Monitor	114.75
NEC Colour Monitor	459.00
Microline 92 Parallel	339.15
Microline 92 Serial	364.65
Microline 93 Serial	526.15
Mouskattack	16.10
Cannonball Blitz	16.95
Lafpak	19.50
Rana Elite Three Drive DD/DD Dr	475.15
Rana Elite Three Plus DD/DD Dr	534.65
Super Disk Copy II	19.50
Smith Corona TPI D/W Serial	296.65
Smith Corona TPI D/W Parallel	296.65
DB Master Version 4.0	203.95

*OFFER IS 15% OFF THE MOST
RECENTLY LISTED PRICES.

DOUBLE STUFF!

A utility to allow you to
produce Double High Resolu-
tion and double low resolu-
tion graphics on an Apple
IIe (must have extended
64K 80 col card installed)
— using Apple soft BASIC
commands up to 560 x
192 pixel resolution.

£29.95 + VAT

APPLE IN EDUCATION : SPECIAL NOTICE

OF GREAT INTEREST TO UNIVERSITIES, COLLEGES, POLYTECHNICS, ITEC'S, SCHOOLS, YOUTH TRAINING SCHEMES

As part of a Pan-European incentive scheme, Apple are offering very substantial discounts to educational users of all Apple equipment except Apple
IIe bundles, Lisa, and Apple 32. The offer starts in January and ends 31st March, 1984.

PLEASE CONTACT US NOW FOR DETAILS — DISCOUNTS UP TO 40% ARE AVAILABLE! — MAKING THE APPLE IIe EVEN GREATER
VALUE FOR MONEY!

● Circle No. 126

Head Office:
NEW HALL HEY ROAD, Rossendale, Lancs., BB4 6JG
(0706) 212321 & 227011 Telex: 635740 PETPAM G

London Office:
1, GLENEAGLES ROAD, London, SW16 6AY
Tel: 01-769 1022 & 01-677 7631 Tlx: 923070 PPCOMP G



PRICES DO NOT INCLUDE VAT

Lines open for orders
8 a.m. - 6 p.m. Mon - Fri (Lancs)
9 a.m. - 6 p.m. Mon - Fri (London)
9.30 a.m. - 3 p.m. Sat (both offices)

HIGH QUALITY GREEN SCREEN VIDEO MONITORS

Designed for use with Professional and Personal Microcomputers where a high resolution display is required. Ideal for applications requiring 80 column mode or higher, high resolution graphics, etc.

CHECK THESE FEATURES:-

- ANTIGLARE SCREEN
- P31 GREEN FOR MINIMUM FATIGUE
- VIDEO RESPONSE 10Hz - 22MHz \pm 3db
- SUPERB RESOLUTION - UP TO 132 CHARS/LINE
- EXCELLENT GEOMETRY/LINEARITY
- HIGH STABILITY
- 230 VOLT 50Hz MAINS OPERATION
- COMPOSITE VIDEO 0.5/2.0V INPUT
- FLICKER FREE DISPLAY

£89

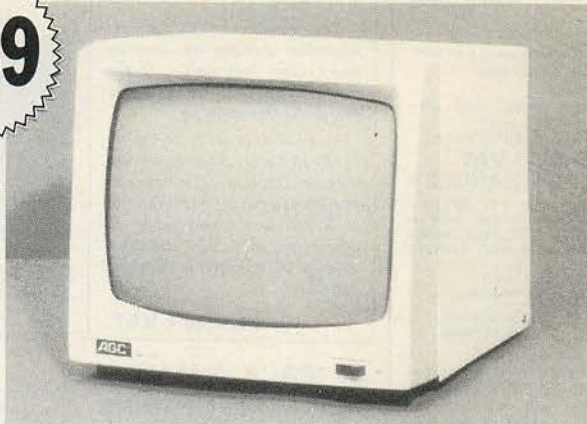

▲ 12" MODEL HM123

£87



▲ 9" MODEL HM910

ADD £5
Carriage/Postage

£85



▲ 9" MODEL HM911

DEALER
ENQUIRIES
WELCOME

THE LOWEST PRICE ANYWHERE

£389



FOR A PC WITH THESE FEATURES . . . LOOK AT THE SPEC. OF THE AMAZING UNITRON 2200 . . .

Dual processors - 6502 and Z80

- 64K of RAM
- 24K ROM with softswitch control
- Selectable 80 or 40 column text display
- Detachable keyboard
- Apple® II-compatible
- CP/M® compatible
- High and low resolution graphics capabilities
- Two disk I/O for your disk drives
- Game paddles/cassette/video interfaces

Prices exclusive of VAT
Same day despatch. Access welcome.

CHILTERN ELECTRONICS

HIGH STREET, CHALFONT ST. GILES, BUCKS. HP8 4QH
TELEPHONE: 02407 71234 TELELEX: 262284

ADD £9 Carriage/Insurance

Who chose the wrong database?

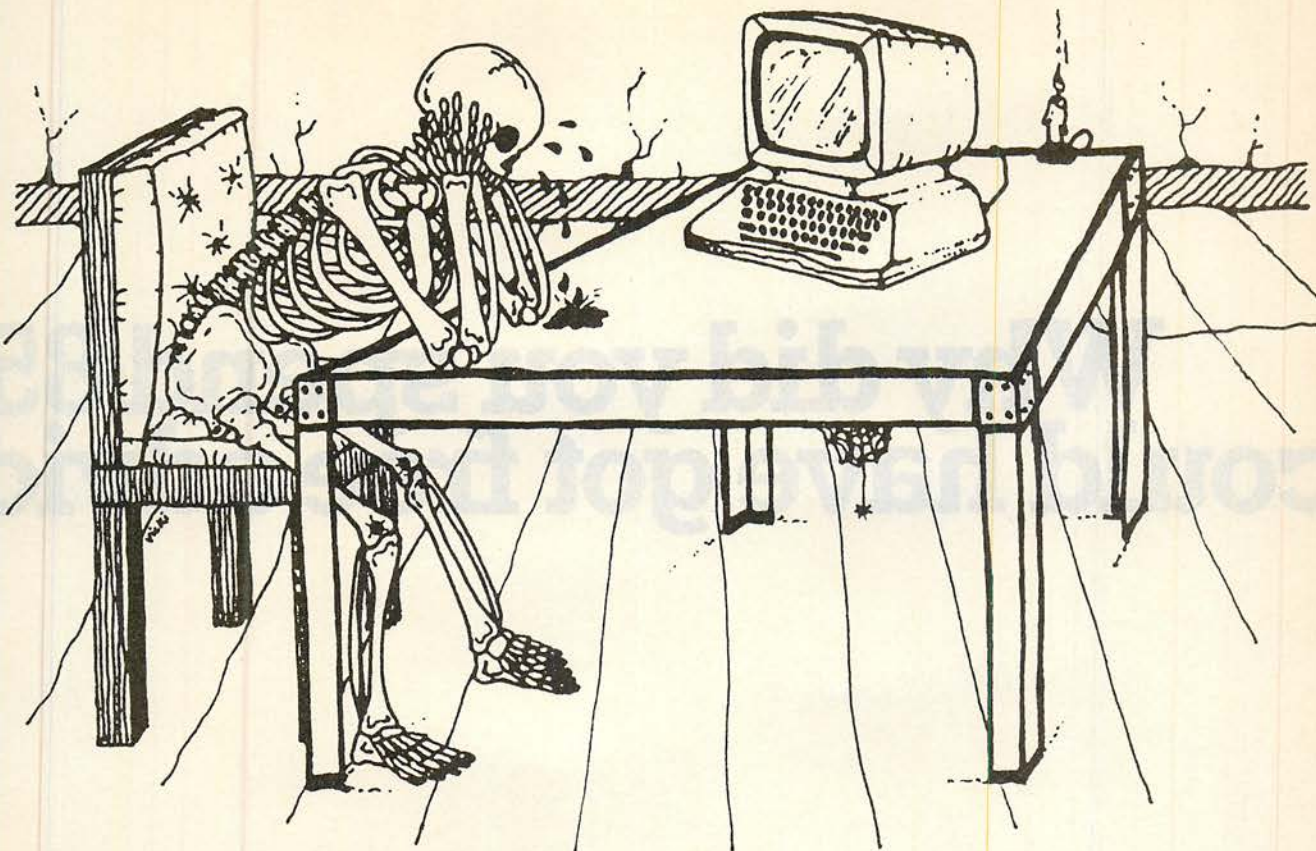

HE SHOULD HAVE USED

RESCUE!

THE PROFESSIONAL DATABASE

For: CP/M-80 MS DOS PC DOS2 PCOS

NEW! "HANDS ON" FOR ONLY **£10**
RESCUE EVALUATION SYSTEM

★ KEYSTROKE BY KEYSTROKE
WORKED INSTALLATION AND
RUN TIME EXAMPLES

★ INCLUDES TRAINING GUIDE

★ RING YOUR
DEALER NOW

★ PROGRAMME AS FULL SYSTEM
BUT FOR 20 RECORDS

QUDOS
SYSTEMS LTD

5 CHARTERHOUSE BLDGS
GOSWELL ROAD
LONDON EC1M 7AN

TEL. 01 253 3998

TELEX. 261729

● Circle No. 128

Who chose the wrong database?



Why did you spend 85, could have got free advice

HE SHOULD HAVE USED

RESERVED

THE PROFESSIONAL DATABASE

For: CP/M-80 MS DOS PC DOS

NEW! "HANDS ON" FOR ONLY £10
RESCUE EVALUATION SYSTEM

• RING YOUR
DEALER NOW

• INCLUDES TRAINING GUIDE

• KEYS TO BY KEYSTONE
WORKED INSTALLATION AND
RUN TIME EXAMPLES

• PROGRAMME AS FULL SYSTEM
• INT FOR 20 RECORDS

• RUN TIME EXAMPLES

TEL: 01 253 2996
TELEX: 261728

2 CHARTRHOUSE BLDG
60 WELLS ROAD
LONDON E11 1AN

QUODS SYSTEMS LTD

on this magazine when you and a demonstration?

- ALL TRACKS CERTIFIED 100% ERROR FREE
- ALL INTERNATIONAL STANDARDS MET OR EXCEEDED
- LIFE UP TO 5 TIMES LONGER THAN OTHER DISKETTES
- 8-YEAR WARRANTY

PRICES BELOW EXCLUDE VAT BUT INCLUDE
FIRST CLASS POST (FOR SPEED) AND PACKING

Cost	No. of Boxes	Price per box of 10
		19.80
		25.80
		35.50
		43.80
Total Excluding VAT		
VAT		
Total Price		

DISKOTEK
P.O. BOX 18
WORSLEY

No matter how long you stare at these pages you won't be able to see Pacman, plot graphs, fly planes, write Assembler or chat about shooting aliens with standard Ram.

A word of advice about computers



**FREE
WITH
ORDERS
OF
MINIMUM
5 BOXES
ANY DISK
TYPE
EITHER**

**1. 5 PLASTIC
LIBRARY
CASE
TO HOLD
10 DISKS
EACH
OR**

**2. PRESTIGIOUS
LAMBS NAVY
RUM CLASSIC
GLAMOUR
CALENDAR
WITH SUPERB
COLOUR PHOTOS
BY DAVID BAILEY**

STRICTLY
LIMITED
SUPPLY OF
CALENDARS
SO ORDER
EARLY IF
THIS IS YOUR
CHOICE

DISKOTEK

FOR VERBATIM DATALIFE
5 1/4" DISKETTES
SUPPLIED IN BOXES OF 10

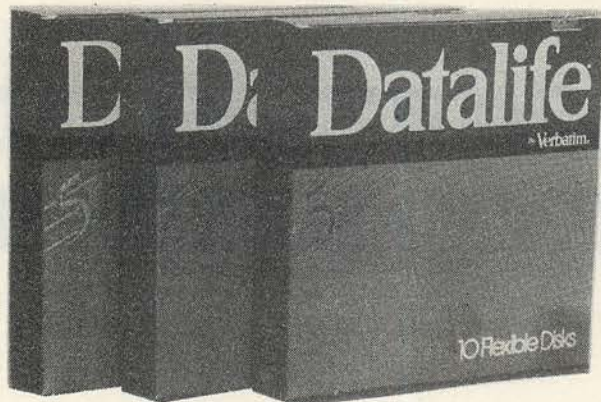

DISKOTEK
P.O. BOX 18
WORSLEY
MANCHESTER
M28 5HA
TELEPHONE:
(061) 799-1427
INCLUDING
EVENING WEEKEND
ANSWERPHONE

**HAVE YOU A
HIGH QUALITY
CALENDAR
IN YOUR OFFICE?
IF NOT ACT ON
OUR FREE
OFFER
QUICKLY**

WE SELL ONLY DATALIFE BECAUSE OF THEIR HIGH
QUALITY AND RELIABILITY

- 5-YEAR WARRANTY
- LIFE UP TO 5 TIMES LONGER THAN OTHER DISKETTES
- ALL INTERNATIONAL STANDARDS MET OR EXCEEDED
- ALL TRACKS CERTIFIED 100% ERROR FREE

**PRICES BELOW EXCLUDE VAT BUT INCLUDE
FIRST CLASS POST (FOR SPEED) AND PACKING**

All disks are suitable for both single
density and double density use

MD 525 single sided 48tpi/40 track
MD 550 double sided 48tpi/40 track
MD 577 single sided 96tpi/80 track
MD 557 double sided 96tpi/80 track

Price per
box of 10

No. of
Boxes

Cost

19.80

25.80

25.80

33.80

Total Excluding VAT

15% VAT

Total Payable

Strictly cash with orders to:

DISKOTEK
PO. BOX 18
WORSLEY
MANCHESTER
M28 5HA

Name..... Tel:.....

Address

..... Post Code

I enclose cheque/P.O. Payable to Diskotek
for the sum of £ _____

For orders of 5 boxes minimum of any disk type tick one of the boxes below
for preference:

- Please send me free of charge 5 plastic library cases
or Please send me free of charge Lambs Navy Rum 1984 Calendar

**New
available now!**

Z80 second processor for BBC Microcomputer with SAGE 400 integrated accounts program **£375**

+ VAT



GCC (Cambridge) Limited
66 High Street, Sawston, Cambridge CB2 4BG
Telephone: Cambridge (0223) 835330

Trade and local authority enquiries welcome.
Prices correct at time of going to press.

● Circle No. 131

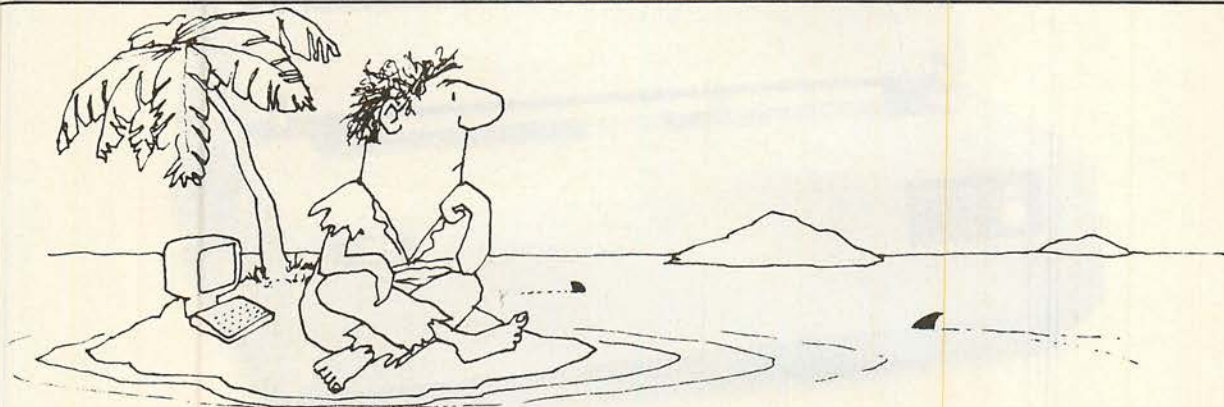

Feel like you're marooned?

The micro world has several islands that are good to live on for a while. The 8-bit CP/M island is well-established and comfortable, but plenty of people are now realising that the 16-bit islands called CP/M-86 and MS-DOS offer greater prospects. But moving from 8- to 16-bit can be hazardous - and which 16-bit destination do you choose?

For the software developer or serious programmer, Pro Pascal and Pro Fortran are passports for these three islands. Programs can be transported smoothly

from one to the other, and in each environment the acknowledged efficiency of the compilers ensures that programs make optimum use of the facilities available.

The 16-bit Pro Pascal and Pro Fortran compilers run on 8086/88-based micros with 86K physical RAM and CP/M-86 or MS-DOS, and each cost £320 + VAT. The 8-bit Pro Pascal and Pro Fortran compilers run on Z80-based micros with at least 56K physical RAM and CP/M, and each cost £220 + VAT.

Prospero

LANGUAGES FOR MICROCOMPUTERS

Prospero Software Ltd. 37 Gwendolen Avenue London SW15 6EP Tel: 01-785 6848

● Circle No. 132

OKI MICROLINE

Microline 84

Highest performance and reliability place these printers on top of the Microline printer series. The printhead is designed for over 200 Million character printing.

Printing speed is 200 cps in data processing mode and 50 cps is achieved in correspondence quality mode. Character types are user defined.

A choice of character sets is permanently stored in the printer's EPROMs.

Additional memory space is provided to store one's own specific character set. This happens by downloading the specific character set from one's computer to the printer before the printout begins.

The carriage width of 136 characters allows the use of A4 paper in portrait or landscape formats, from an optionally available single sheet feeder.

The interface parts allow for parallel or serial data transfer - buffered or unbuffered -, from most popular desk top computers and widely used PC's.



**MICROLINE - more than
150. 000 printers in Europe in use.**

OKI

OKI ELECTRIC EUROPE GmbH
Emanuel-Leutze-Str. 8 · D-4000 Düsseldorf 11
Telefon 02 11/59 20 31 · Telex 8 587 218

U.K. X-Data Ltd.
750/751 Deal Avenue
Trading Estate, Slough
Berkshire SL1 4SH
Tel.: 0044-753-72331
Tlx: 051-847728

COUPON

Please send me/us more information to:

- MICROLINE 84
 The whole MICROLINE program

PC3

Name: _____

Street: _____

City: _____

Phone: _____

● Circle No. 133

PRACTICAL COMPUTING March 1984

WP — a way with words

Glyn Moody considers the current state of the word-processing art and examines some packages for the office, school and home, while Jack Schofield gives Bank Street Writer a thorough going over on the Atari.

IF A MAN or woman on the Clapham omnibus were asked to name some serious uses of computers, he or she would almost certainly name word processing, along with spreadsheets and possibly databases. For many businesses, the first taste of micros is through a word processor. From the managing director impatiently awaiting the seventh revised draft of a memo, to the copy-typist who is producing the same final-demand letter day in, day out, everyone is able to appreciate the need for a machine storing a document and allowing it to be altered before printing.

It is no accident that we speak both of microprocessing and word processing. The main chip is a device for manipulating strings of bits. As soon as a letter is translated into binary — usually via the standard ASCII codes — letters and words become just another set of data that can be acted upon. Unlike the up-and-coming expert systems which require a conceptual leap in terms of analysis and implementation, word processing is already an established application.

Golden Age

We are entering the Golden Age of word processing: packages have been around long enough for basic characteristics and needs to have been established. As the user base continues to expand enormously so the competition among software houses increases, and with it, so the theory goes, the choice. This process will not go on indefinitely. Already the first faltering steps have been taken towards voice-recognition systems. When this technology is perfected the emphasis will shift to the intelligent dictating machine, rather than to the intelligent typewriter which is what word processors represent now. But the time-scale of, say, five to 10 years, is sufficiently long that the basics of word processing as we know it will be with us, if increasingly refined, for a good few years to come.

Although there were a number of precursors such as Scripsit, it was the word-processing package WordStar from Micropro that really defined standard word-processing functions and,

unfortunately, bedevils later packages through their aping of some of its less happy features.

This introduction to word processing begins by considering what solutions WordStar offered to what problems, and comparing this with two more recent products, Edword and Homeward. Unlike WordStar, which is geared largely to the business market and runs on CP/M machines, Edword is designed for schools and runs on the BBC Micro. Homeward, as its name suggests, is primarily for home use on the Apple, and is interesting for its use of the latest icon techniques.

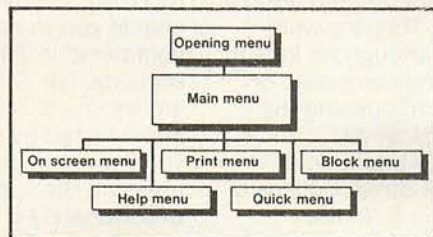
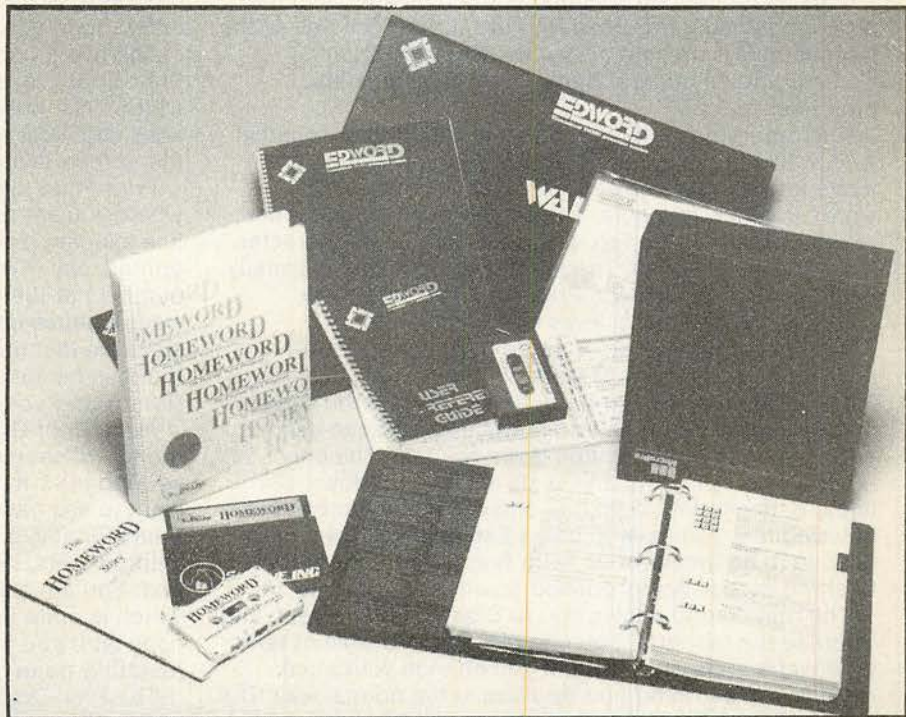

Figure 1. WordStar menu tree.

Although WordStar is generally accepted to be a very powerful and versatile word-processing system it is not user-friendly. This is despite the fact that its command structure uses a simple tree of menus — as shown in figure 1. When you boot WordStar the opening menu presents functions dealing with file management. After pressing D to open a file document, and giving it a name, the main menu is obtained. The format repeats that of the opening menu. Groups of commands called up by simple keystrokes, but already the dreaded control character, represented on menus by ^, has reared its ugly head.

Thus simple cursor movements are effected by pressing Control and one of a cluster of keys to the left of the keyboard: ^S for character left, ^D right, etc. One problem is that next to ^F, which allows you to move to the word on the right, is ^G, which deletes the current character. At each level of the menu the keyboard bristles with redefined meanings so that missing a

(continued on next page)



Varied documentation styles reflect different approaches to the user.

(continued from previous page)

key only slightly can cause drastic changes.

Other possibilities on this menu are moving to tab stops and inserting a Return. In WordStar, and in most subsequent word-processing software, Return inserts a hard — that is compulsory — Carriage Return. Other soft Returns arise naturally out of the wordwrap facility. Pressing ^B allows text to be rearranged within change margins.

The remaining commands take us down to the next level of menus. Pressing ^J introduces a sequence of useful Help screens. Again the format remains the same: single keystrokes select particular options. Pressing ^D produces the on-screen menu which lists commands for formatting the screen. In addition to standard options like Left and Right Margin, Paragraph Tabs and Normal Tabs, there is a centring facility and line-spacing command.

WordStar also has various toggles —

switches that can be On or Off — which represent particular options for screen format. For instance, when wordwrap is On, entered text that spills past the right-hand margin is automatically taken over on to the next line: no tedious manual Carriage>Returns are needed, and your concentration on the input copy is unbroken. In this mode, a whole word is taken, but a further possibility is to introduce soft hyphens. A soft hyphen gives WordStar the option of breaking a word at the soft-hyphen point. This is useful if a long word appears frequently in a text. Without soft hyphenation, such words will always be taken over in their entirety, leaving unsightly emptiness in the line behind. If the Justify toggle is On, then spacing is introduced to even the lines out.

The block menu is called up by ^K; from here, files can be saved, abandoned and exited from. As its name suggests, this menu is also concerned with block operations. One important feature of copy

on paper is being able to physically manipulate it by cutting it up and pasting it down in a different way. The possibility of moving chunks of text in a clean and effortless way is a prime advantage of electronic word manipulation. It is also an area where the differences in approach between various word-processing packages emerge.

Block pointers

WordStar defines the blocks by means of delimiters placed in the text. Naturally these markers are invisible in the final print; they are normally deleted after a saving to file. The characters and <K> mark the beginning and end of a block; this block can then be moved or copied elsewhere using the V and C commands. Block text is transferred to the current cursor position. Blocks can also be deleted and read, or written from one file to another.

(continued on page 54)

Bank Street Writer

Broderbund Software is best known for its collection of arcade games for the Apple and Atari micros, including several smash hits — Choplifter, AE and the original Apple Panic. Last year Broderbund entered a new area of publishing with the Bank Street Writer. This is a word processor that is supposed to be easy enough for kids to use. It could well be. This review is being composed on the review program within half an hour of opening the box and there are no obvious problems at all.

The Bank Street Writer was written by Intentional Educations Inc. together with The Bank Street College of Education, New York State, and Franklin E Smith, software design and marketing consultant. The manual credits 15 names. Broderbund is the publisher, and the program is being imported into the U.K. by Softsel. At the moment it is on disc only, for the Apple, Atari and Commodore 64 micros. Bank Street Speller is also promised.

The program is supplied on an autoboot disc together with a 32-page manual. After powering on, the program loads into its text-entry screen, with room for 2,333 words in a 48K machine. The screen provides four lines of information at the top, and an 18-line by 38-character box for you to type in. The main command line is usually headed Write Or Correct. Pressing the Escape key changes the command lines to the main menu.

The main menu offers a range of options, namely Erase, Unerase, Move, Moveback, Find, Replace and Transfer Menu. The text-entry block remains the same, except you cannot type into it. Instead, you can use the cursor keys to scroll up and down the text. The only other text movements are: U, up 12 lines; D, down 12 lines; B, beginning of text; E, end of text. To go back to entering text you have to press Esc again. All text entry is done in an Insert mode, with text to the right of the flashing cursor being pushed down the screen to fit.

The main menu allows you to Erase blocks of text, and Unerase the last one. You can also Move blocks of text, or Moveback the last block if you change your mind. Finally, you can Find and Replace in the normal way. The cursor stops at each example of the search string and

invites you to change it or not by answering a yes or no, Y/N question.

Selecting the Transfer Menu option brings up another two rows of commands offering nine new options which enable you to do things with the text once you have completed it. The options are Retrieve, Save, Delete, Rename, Init, Print-Draft, Print-Final, Clear and Quit. Init allows you to format a new disc. In each menu, options are selected by positioning the cursor over the option you want and pressing Return. The cursor is moved by pressing the space bar and the < and > keys. Unfortunately it is not possible to select an option by pressing the first letter of its name, as it is in many programs — for example, Multiplan. To return to the text-entry mode you press Esc once or twice.

The two printing options are Print-Draft and Print-Final. Print-Draft prints text double-spaced by 38-characters width. This makes it easy to proof-read and to find the lines you want to correct, since the hard copy matches the screen layout.

Print-Final takes you through a stream of options where you set the number of characters per line, set the line spacing, say if the file is chained to the last file printed, say if you want page numbering, put page numbers at the top or bottom of the page, say if you want a pause between pages, and finally, if you want to eject the last page. All of these options have defaults that can be set, so usually it is just a matter of pressing Return and scooting through them.

Next, Print-Draft invites you to type in a heading for the top of each page other than the first, and asks if you want to print the whole text. The prompt then asks if you want to see page breaks, and if so, allows you to adjust them. Finally, it asks if the printer is ready. All this, even with defaults, requires 15 Return-keys to print a two-page text. You are asked if you want to print another copy which is quite simple, but if you want to print another copy later you have to go through the whole process of resetting page-breaks and so on all over again.

The Print-Draft program uses a similar set of options to Print-Final, but in this case they are built into the

(continued from page 52)

The menu ^Q allows a number of basic cursor movements found in the main menu to be repeated. For example ^Q followed by D moves the cursor all the way to the right, not just one place as in the main menu.

The Miscellaneous group of commands includes the useful search and replace procedures. Pressing F after ^Q brings the prompt Find? asking for the word to be found. Similarly, A causes a Find? prompt followed by a Replace With?. After locating the first occurrence of the word to be found, a Y/N prompt allows replacement. Further refinements include backward searches, searches to the nth occurrence and global searches where the whole document is searched. In the last case it is possible either to approve each replacement individually, or not at all — but this is only recommended for those with great self-confidence.

Print menu

The final menu ^P deals with the print options. WordStar allows a full range of print effects, but at a cost. The menu presents the relevant command keystrokes: B for bold, T for superscript etc. When a command is entered, the screen shows each character preceded by the familiar ^. As with a block marker, this is invisible when printed, but changes the mode in the required way. Using strings of these characters before and after the relevant text allows you to set up elaborate print variations. But the resulting screen layout is ungainly and unclear. The ultimate solution is WYSIWYG — what you see is what you get — where the screen reproduces the final form of the document exactly. Recent word-processing packages are moving in this direction, though a full implementation is still awaited.

Facilities such as justification, word-wrap, block moves plus search and replace form the heart of WordStar and represent the core elements of any word-processing package. Most situations encountered in the office and at home can be handled using just this set of operations. But WordStar goes much further and offers a range of commands enabling detailed page layout.

For example a set of dot commands — entered by prefacing a two-letter command by a full stop — allows a specification of page breaks, and standard headings and footings. Assuming the printer can keep up with WordStar's prodigal command sequences, you can arrange for bi-directional printing, character pitch and line-height changes, plus switches between ribbon colours. Dot commands add a further level of complexity to WordStar by complementing and extending the control-key commands. Unfortunately, they also destroy what overall rationale was ever evident.

It is probably true to say that few people use the WordStar system to the full. But this is partly a result of the opaque series of

instructions needed for the more rarified options. For example, using the Quick menu, the reformatting procedure can even be controlled down to the speed; but the required sequence is the unmemorable ^QQ ^B3.

In fairness, it must be said that, like most things in constant use, the patterns become familiar. In a business situation, an operator can be trained to learn and use these sequences. But this is only feasible if a particular typist is "dedicated" to WordStar; as a general word-processing program that can be used by anyone in the office, WordStar falls short of current thinking on user-friendly software.

A number of solutions have evolved to bridge the gap between WordStar's power and its accessibility. Micros endowed with generous helpings of function keys are often provided with overlay programs that set keys to entire WordStar functions like Block Move etc. An appropriately labelled plastic card is then laid over the keyboard to name the keys. For machines without such luxuries, add-ons such as the Keystar box allow WordStar to be run by single keystrokes. In this case, the separate dedicated unit plugs into an RS-232C port.

A recent product from Clwyd Technics Ltd called Edword draws on many of WordStar's features and adapts them for the educational context. It comes as a ROM chip that plugs in alongside the chips for BBC Basic and the operating system, which must be version 1.2 or later.

Word processing can fulfil a real need in schools. Typing is widely taught and typing courses aim to teach two things: keyboard familiarity and technique, and the ability to produce perfect output. Pupils frequently become frustrated and alienated from keyboard work by the constant retyping required for perfect output. Word processing changes that by eliminating the need for perfect first-time entries. The

stress can be shifted on to keyboard familiarity and more creative aspects of keyboard input such as layout. Edword emphasises these aspects, and through a full error facility enables an interactive approach to be developed.

Running on the BBC Micro in either 40- or 80-column mode, Edword follows the WordStar tradition while making what use it can of the available function keys. Thus F9 becomes the Command key, comparable to the Control key in WordStar. Following this with single-letter commands allows operations like centring, block movements and print modes.

Object selection

The function keys F0 to F3 relate to object selection. Broadly speaking an object is equivalent to a WordStar block. But instead of defining blocks by semi-visible end markers, Edword permits words, lines, paragraphs or pages to be selected directly — a clear improvement.

Pressing F5 justifies the current object. Unfortunately one weakness of Edword is that it is not possible to unjustify text: inserted spaces must be removed by hand. Pressing F6 underscores an object, while F7 is a straight Delete option. If a particular object is selected, all of it will disappear; if

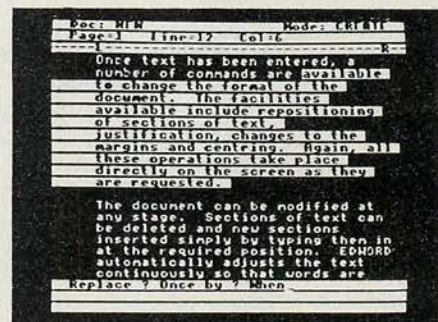

A highlighted Edword object.

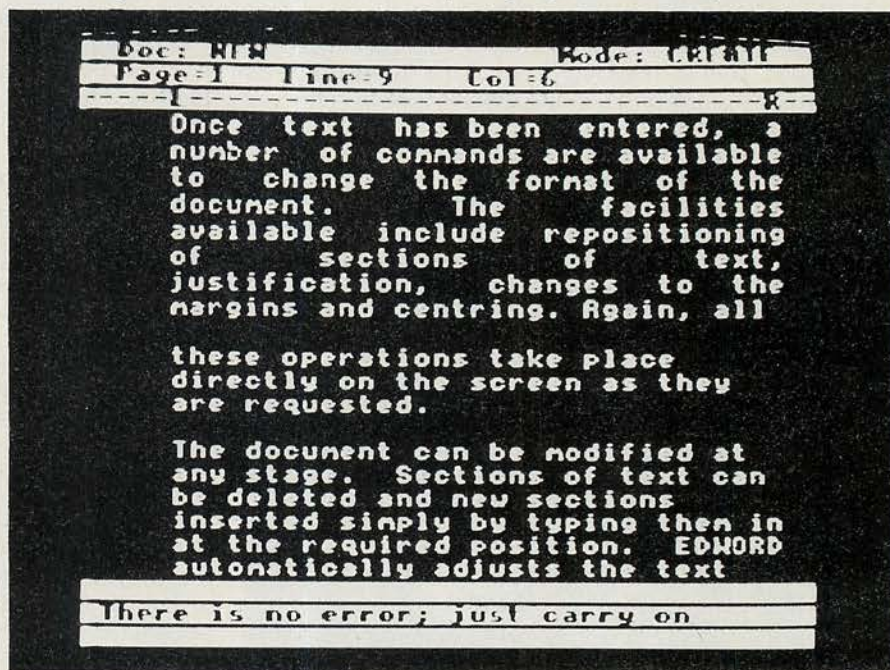

Users may interrogate Edword for error messages at any time.

not, only the character at the current cursor position vanishes. Pressing F8 calls up the print facilities, though only very limited type formats are available.

Other standard features such as searches and global replacements are offered, along with page formatting. A separate format table can be called up to allow margins and tab positions to be set.

Clearly Edword is very much in the WordStar mould, although it has moved away from the nested menu structure and only F9 has a large range of command options. A shift of emphasis is apparent in the manuals. The WordStar manual consists of a ring binder with full cross-referencing, menu tables, diagrams and line drawings featuring real-life WordStar situations. In contrast Edword has put together a veritable action pack for teachers and pupils.

Apart from a spiral-bound student's guide, there is a reference manual, teacher's guide, overhead-projector slides and wall-charts. The package appears well thought-out in terms of its operation in a school. However, like WordStar, Edword usually requires a conscious effort on the part of the user to translate the desired effect into a keyboard command. The manuals present the various options but with little explanatory background, and jargon is

used from the start. More could have been made of the opportunity to introduce pupils to a real-life application of the micro.

It is doubly apt that the word-processing package Homeward from Sierra On-Line Inc., should be written for the Apple II. First, this is software written specifically for home use — and what better machine than the one that started the home micro boom. Secondly, it uses the latest techniques of Apple's icons.

When you boot up from the Homeward disc the main menu of icons is displayed. They occupy the lower third of the screen, and particular functions are chosen by moving the icon cursor — a rectangular frame — using the cursor keys. The highlighted option is also named in the centre of the icon, which is often necessary

Prices and suppliers

WordStar: Runs under CP/M, MS-DOS.

Cost £295 plus VAT. Details from Micropro. Telephone: 01-879 1122.

Edword: Runs on BBC Model B with operating system 1.2 or later. Cost £56.95 plus VAT for starter pack including printer configuration cassette. The cost for the non-educational package, without the teacher's guide and wall-charts, is £48.95 plus VAT. Details from Clwyd Technics Ltd. Telephone: 035 283 766.

Homeward: Runs on Apple II, II Plus and IIe. Cost £33.95 plus VAT from Pete and Pam Computers Ltd. Telephone: (0706) 212321. Also on Atari and the Commodore 64, both at £35.95 plus VAT. Details from Softsel. Telephone: 01-844 2040. A version of Homeward also runs on the PCjr — see the February issue of *Practical Computing*.

since the imagination is sometimes stretched when trying to recognise Homeward's logo for making back-up documents for example.

The main menu offers print, edit, file, layout, customise and disc options. The chosen item is entered by hitting Return. This leads to a further menu of related choices. For example the Edit icon leads to a choice of moving, copying, finding and replacing text. The icon menus are nested to a maximum depth of three levels. As in Edword, the Esc key is used to move out of menus of commands to the next level. Hitting Esc at the level of the main menu converts the upper two-thirds of the screen into the typing area. The lower third now displays information on the RAM available and disc usage, as well as a miniature representation of the input area, complete with a tiny flashing cursor. Since the main display area can only accommodate about a third of a standard page in single spacing, this is a valuable facility. Double and triple spacing as well as margins are shown in proportion. Esc is also used to return to the main icon menu.

The icon structure allows nearly all file operations, from disc management to print style, to be set up by simple on-screen selections. The icons themselves are clear and generally sensible choices.

The bad news is that on-screen manipulation is palaeolithic. Once again the procedure of pressing Control followed by another key is used to move the cursor, toggle Insert mode and delete characters. Worse news is that the control codes are mostly different from those of WordStar.

The way ahead

Homeward, occupies an intermediate position in the evolution of the perfect word-processing package. Its use of icon menus is well conceived and implemented, and represents the way forward. The Apple II is partly to blame for the archaic cursor controls and as with WordStar, frequent use will go some way to alleviating this problem. The package is cheap at only £33.95 from Pete and Pam Computers, though the manuals are indifferent.

WordStar, Edword and Homeward represent successful responses to the particular needs of the business, school and home. Whatever its faults, WordStar will always be standard against which later word-processing packages will be measured — in particular to what extent they offer user-friendly prompts.

New word-processing systems will therefore probably develop in two directions: first, in the use of icon methods to allow ready access to a full range of WordStar type facilities, and secondly in the provision of a total environment for the manipulation of data, be it text, numeric or graphic. By the time these information processors are available, voice recognition will probably be viable. Marrying these two should produce some interesting results. □



Homeward's main icon menu.

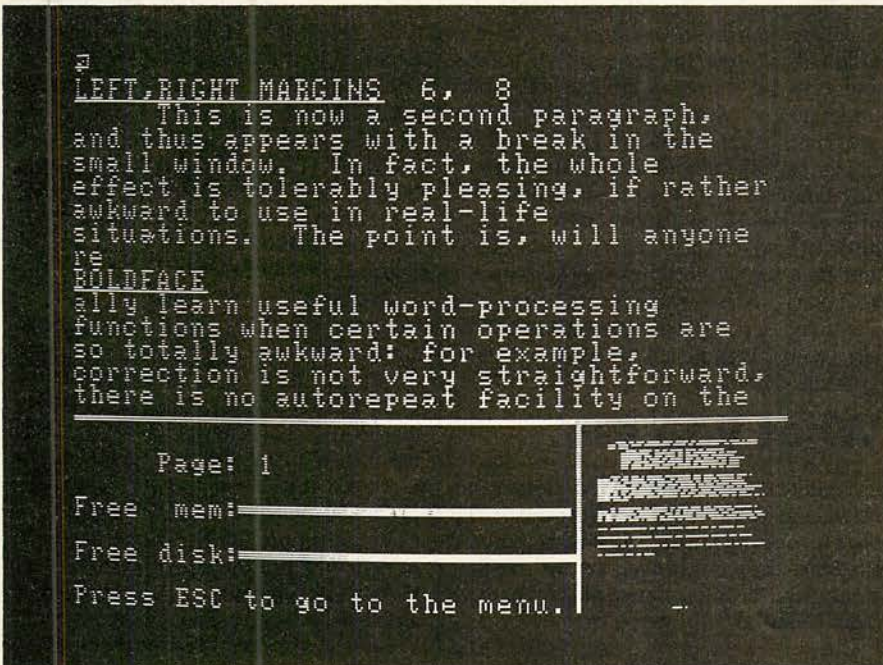

The full page format is shown in miniature as text is entered.

IN THE two-and-a-half years since its launch the IBM PC has become the main word-processing micro, and thus the most popular machine for word-processing packages. There are currently over 40 available in the U.K., without counting multiple-purpose offerings such as Silicon Office. In the U.S. — excluding all the British programs — my last count was 103. That means a new WP package has come out for roughly every week of the machine's lifetime.

More interesting than the volume is the quality of many of these programs. Microsoft's Word, for example, reviewed in our December 1983 issue, sets a new standard in ease of use, while Visi On Word from Visicorp also promises a Lisa-like environment with multiple windows.

In addition, virtually all the best established packages have been transferred to, and improved for, the IBM PC. Examples include Final Word and Mince, both from Mark of the Unicorn, and Perfect Writer, which we reviewed in February 1983. There are all the old favourites like WordStar, Spellbinder, Benchmark, Easywriter and Peachtext, which used to be Magic Wand.

If you like the Wang style of dedicated word processor, you can have Multimate, from Softword Systems, reviewed on page 60 of this issue. In any case, the IBM PC is exceptionally good as a word processor. The screen display given by the monochrome monitor is very clear and easy to read. In addition the keyboard, notwithstanding some regrettable

The one for WP

Jack Schofield assesses what it is about the IBM PC that has made it the foremost word-processing micro.

key placing, is superb for touch-typing.

This concentration on catering for the IBM PC need not be greatly to the detriment of other brands of micro. There is already a large market for IBMulators like the Columbia PC, supplied in the U.K. by Icarus, and PC-compatible transportables like the Compaq, Corona and Dynalogic Hyperion. In the future, with the launch of the Advance — see our October 1983 issue — and the PCjr the benefits will begin to be seen even at the cheaper end of the market. Also, successful packages that were designed originally for the PC will surely be transferred to other popular micros. With these thoughts in mind, *Practical Computing* has selected three WP packages on the IBM PC for this special report.

There is one limitation which must be

borne in mind: customising the keyboard. Many popular word-processing packages supply sticky labels or even customised keycaps so that the function-key assignments and so on can be easily identified. This makes the programs much easier to learn and use. When using several packages on the same machine, and switching between them at frequent intervals, it is impossible to use this facility.

Finally, remember that there is no single best word processor. Some are more suitable for long texts where perhaps formatting is not important and maths not required. Others are more suitable for shorter texts where the precise layout is most important. There are numerous other possibilities too. With so many packages available for the IBM PC, there must be something for everyone.

TRENDTEXT

An easy-to-use package converted for the IBM PC.

THE INTRODUCTION to our IBM word-processing reviews was composed using Trendtext, and comprised 618 words — or at least it did before it reached the subs' desk. Trendtext is a powerful package. It is easy to use, and has many extra facilities such as maths, graphics capabilities, mail-merging, contents and indexing, plus limited data-handling facilities and word counting. It also has a few idiosyncracies on the IBM PC, probably because it was not originally written for this machine.

Trendtext is supplied by Microtrend U.K. Pately Bridge, North Yorkshire. Though the company is a branch of the Dutch firm Microtrend International bv, the package was in fact written in the U.K. and is well supported here. However, the international nature of Microtrend's business means that great attention has been paid to coping with the IBM character set. The package provides for multi-lingual word processing, and claims to print all the characters that the IBM PC can generate. The ability to print Greek letters and

mathematical symbols as well as simple graphics makes Trendtext suitable for scientific word processing too. It was originally written for the eight-bit market and runs on most CP/M machines. The package reviewed here should, strictly speaking, be referred to as Trendtext-2.

The package comes in an A4-size four-ring binder with 11 chapters of computer-printed manual in letter-quality printing, not dot-matrix. There is also a sheet of red and blue sticky labels for customising the keyboard. All the labels are used for Trendtext-2, and subsets are marked off for use with Trendtext-1, Lexicom-1 and Lexicom-2.

What you see...

Trendtext is a menu-driven, document-orientated WYSIWYG word processor. To boot it you type Menu, followed by Return. Pressing any key then brings up the first menu, which offers a range of eight choices from 0 Exit to 7 Printer Selection.

Pressing 2 loads the word-processing program itself, and this brings up a menu offering nine choices from 0 Exit to 8

Merge Files. You press 2 again to edit a file, and then you are asked the drive name and file name. If the file name exists, Trendtext fetches it and puts it on the screen.

If the file name is not found the program asks for confirmation that this is a new file — after all, you may have the wrong disc in the drive. If the answer is Y, Trendtext creates it by writing the name to disc. You are then presented with the main text-entry screen, which looks like the one shown in figure 1.

The screen is commendably clear, and tells you the name of the document, the cursor mode, the current line number and the mode. In figure 1, the file called TText is on the hard disc drive C, the cursor is moving a character at a time, the line number is 1 and the program is in Insert mode for text entry.

Cursor movements can be made not only by character and by line, but also by word, by sentence and by paragraph. The facility to jump through text a sentence at a time is a delight. As well as moving by these units, Trendtext will also Delete by them. This is a powerful facility — but dangerous if you are in the wrong one. Trendtext uses the

Insert key for toggling in and out of the Insert mode; when you are out of it you select the type of cursor movement required by pressing the Return key.

Margins and decimal tabs can be set on the rule across the top after pressing the F2 key. While the screen can only show up to 80 characters across, Trendtext can scroll horizontally to a maximum of 255. It does so by jumping forward to a new screen each time you push beyond the limit of the old one.

Trendtext uses control characters, entered using the Control key and the IBM PC's 10 dedicated function and other special keys. The Control key is mainly to embed formatting controls for the printer, and there are 15 options in the range.

The printer Control options are easy to remember because most use the first letter of what you want to do. For example, Ctrl-B is used for Bold printing and Ctrl-C for centring text. Options include headers and footers, subscripts and superscripts, overstrike and underline. Choose Ctrl-X if you want to index something, or Ctrl-Z for merging text from another file. Ctrl-S stops the printer, in case you want to change a daisywheel in mid-page.

All the formatting commands produce an invisible character on the screen, and the function key F6 toggles them between Hide and Reveal. On Reveal they appear as inverse caps of the character, so you can check that the format controls are really there, but on Hide your text is clean and easy to read. It is an invaluable feature.

Conversion

One catch is that you enter Ctrl-H for a header, but to do so on the IBM you have to press Ctrl-A. The Ctrl-H symbol then appears on the screen. Ctrl-H, as so often in the word according to Microsoft, is a destructive backspace. The Range Right character is an inverse >, but to enter it you have to press Ctrl-R; meanwhile the inverse R on the screen is produced by pressing Return. These things happen all too often with conversions, and to pick them up you have to read very closely the IBM-specific details added to the standard manual.

Trendtext also offers a useful soft hyphen, Ctrl-G. If you set a 45-character margin then as you type in the text, it is displayed on 45-character lines, as shown in figure 1. It is tempting to put in hyphens to even out the lines; but suppose you insert a few corrections, or change your mind when printing out the text? Change the width to 50 characters, and Trendtext will happily reformat it while printing with those hard hyphens still in place. If you use soft hyphens, Trendtext joins the split words back together again if they fit on the same line.

The IBM function keys are used for large-scale editing functions such as large cursor movements or block moves, which are done quickly with F7 and F8. For example, F1 is used to Exit from editing a document, and F3 for Search and Replace.

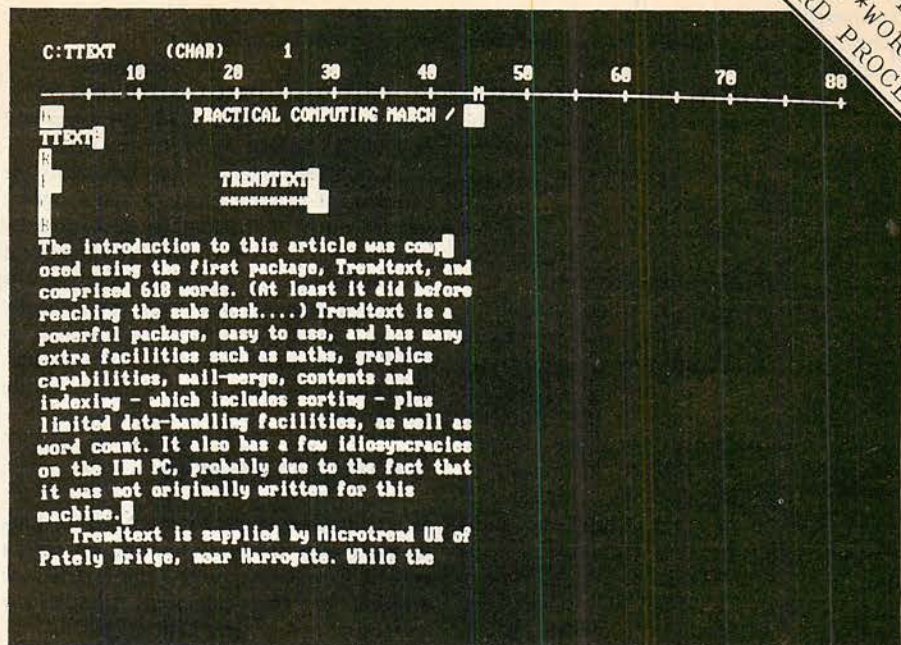

Figure 1. The Hide command banishes control character, shown here in inverse.

The bottom six function keys, numbered from 5 to 10, are also used with the Alt key for the screen calculator. For example, Alt-5 is used to add, Alt-6 to subtract, Alt-7 to multiply and Alt-8 to divide, these being the limit of Trendtext's computational ability.

Most other IBM PC special keys have been implemented correctly, so pressing PgDn moves you one page down the text. Oddly, however, the PgUp key takes you back to the very beginning of the text. If you really want to go up a page you have to press the Home key twice.

Trendtext is versatile and powerful, and seems to be able to handle virtually any sort of text. However, it does have a couple of limitations, and a few problems were encountered during the review. One of them is that you cannot change the margins or the line spacing while you are printing out text. This makes it complicated to produce texts with, say, extensive quotations, where the quotes are printed narrower and closer together than the main text.

Chained files

What you end up doing is Chaining files together. If you use the Chain facility, you simply write another file which contains only the file names of the documents you want to print, in the order you want them printed. Then you print the document as a succession of small files. It is a messy procedure compared with the ease of being able to embed line spacing and margin instructions directly in the text.

During this review my feelings for Trendtext went through three distinct stages. To begin with I liked it because it is very easy to use even if you have never used it before. While it has some more powerful features than WordStar, they are completely invisible to the user who does not require them; the package never looks

complicated. When you do need to learn a new technique, it can generally be found via the index at the back of the manual.

During stage two I began to dislike Trendtext a lot because the menus and defaults prevented me from using the package the way I wanted to. For example, before every printing session I would have to go through the default settings and change the number of lines, width, single to double spacing and so on. Then when I tried to install it on the XT hard disc drive C the user-friendly floppy version refused to accept any drive identifier except A and B.

Support

To silence my barrage of complaints and initiate stage three, a support-person came round from Microtrend. He revealed the secret control that provides access to the innards, so I was immediately able to make C: permissible, customise the defaults, and even write my own printer drivers using the simple utilities included. Within an afternoon I was back in love with the package, and have often used it since.

There are still some things I dislike about Trendtext. One of them is that it is all too willing to discard text from memory, which makes me nervous. For example, if you want to print a text, you save it and go to the Print menu, but this involves reloading the file you have just dumped. Similarly if, after printing, you decide to print another copy, this again is reloaded from disc.

This disconcerting habit arises because Trendtext is designed to cope with very long texts. When you have filled RAM it writes text to disc and carries on. Thus at the end of the text it goes back to where it definitely knows it can find the beginning — which is not in RAM but on the disc file it started before allowing you to start entering text. This is very good for people who write long texts or who only have 64K machines, but

(continued on next page)

(continued from previous page)

with 256K in an IBM PC and chained files available it is not a vital feature.

My second dislike is an extension of the first — there is no deep way to subvert the menu system. However, it must be admitted that using the menus provided is not particularly arduous.

My third dislike is that the package utilises some of the PC-DOS error trapping, instead of being completely self-contained. If you try to print without the printer on, you get Microsoft's wonderful message asking if you want to abort, retry or ignore the failure. Pressing A for abort would then leave you in the operating system with no word-processing program and not text.

When this happens with a Disc Full message the error can be a fatal one, and I lost one article because Trendtext told me my floppy was full. It wasn't, of course, but somehow Trendtext and I had been opening files and not closing them. Running the PC-DOS Checkdisc utility

produced another of Microsoft's wonderfully obscure epigrams,

14 lost clusters found in 14 chains
Convert lost chains to files (Y/N)?

The affirmative reply made an extra 412 free blocks appear, but no extra files.

This curious phenomenon highlights the problem of using a menu-driven program where you perform complex tasks just by hitting a function key, without knowing if everything really is happening the way it is supposed to. At any rate, periodically running Checkdisc solved the problem — which may have been of my creation. Microtrend now has a new challenge: trying to recreate it.

Conclusions

● Trendtext is easy to learn. It is particularly easy to do formatting on screen and, if necessary, preview the text before printing it. This makes it suitable for secretarial and general office work.

● It is one of the more powerful packages,

although it presents a simple face to the user. The facilities to print Greek and other foreign characters, print graphics, handle decimal tabs, do calculations and indexes make it suitable for scientific and technical use. It can handle long texts in pages too.

● The inclusion of extra features like mail-merging, limited data handling, word count and the production of indexes makes the package better value than it looks at first sight. However, it does lack a spelling checker.

● It was my experience that the package is well supported on the telephone, even when the people at Microtrend don't know they are talking to a computer magazine.

● The IBM PC implementation represents a compromise. Though the package does use the special facilities of the machine, it is probably just as good on other CP/M and MS-DOS micros.

● Trendtext costs £350 plus VAT from Microtrend U.K., Council Chambers, School Lane, Pately Bridge, Harrogate, North Yorkshire.

WORDPLUS-PC

A package written specially for the IBM PC, tested by Paul Myerscough.

WORDPLUS PC comes in an attractive 2lb. package which includes a manual matching IBM's own format. The program is on a single floppy disc, and there are some stick-on function-key labels and a quick reference card.

The documentation is designed for non-technical users. Without opening the *Guide to Operations* or the DOS manual supplied with the IBM PC you can learn all that is needed about formatting discs, making back-up copies, use of the keyboard and so on, and begin typing productively. A good, well paced tutorial introduction fills the first 234 pages and refers to several text files provided on the disc. The reference section, which follows, is organised into six different function-areas and covers about 100 pages. There are appendices on DOS, error messages, printer trouble shooting, command formats and an index.

Before you start to use it, Wordplus-PC must be configured to the printer in use. About 30 options are available on the set-up menu. It appears that the package was developed primarily for the NEC 3550 Spinwriter. Other printers may not be able to support all the features offered by the word processor, and it is possible that even a printer which appears on the option menu may not make a perfect match with the software. You should test your printer with all the text-formatting operations that are important to you, rather than make assumptions about compatibility. Of course, the same goes for all word-processing software.

You are very soon reminded that this software was produced with the PC in mind: the Caps Lock and Num Lock keys are both signalled on the screen. The Pg Up and Pg Dn keys are implemented and cause continuous, rapid scrolling which may be halted by hitting any key. The End key causes similar scrolling, while Home gives immediate access to the start of the text.

Text files are held in memory while being

edited, which limits their size to about 200 lines. This causes few problems, however, as files can be linked for printing purposes by an embedded command. The text window — see figure 1 — uses the first 22 lines of the screen. The last three lines are reserved for system information and messages which give the current cursor position, current options in effect and selection prompts.

Command	Function	Comments
bm	set bottom margin	0-255
ce	centre text	On/Off
cl	comment line	not printed
clp	comment with printer pause	displayed during printing
fo	define page footings	up to three lines
fp(n)	force page	if current page has <n lines remaining
fa	form advance	six or eight lines per inch
he	define page headers	up to three lines
hi	horizontal spacing	from 1/120in. to 14/120in.
ju	justification	
lm	set left margin	1-255
la	line advance	up to one full page
sp	line spacing	1,2, or 3
mr	margin release	- 255 to + 255
mj	micro justification	alignment by inserting fine spaces between characters
nf	next file	links document files
pl	page length	1-255
pn	page numbering	used with headers or footers
pi	pitch	10,12,15 chars/in.
ps	proportional spacing	needs printer support
ra	right alignment	On/Off
rm	set right margin	5-255
sf	sheet feeder control	
tm	top margin	0-255
vi	vertical spacing	1/48in. to 14/48in. per line

Table 1. Wordplus-PC formatting commands.

boon to the author working on a book. Rather than scrolling through masses and masses of verbiage, you can press F1 and, in response to the prompt

Go to Where?

you are whisked to whatever page takes your fancy.

But for all that it must be said it is not so good for the reviewer — or at least, this reviewer — who wants the whole text in memory for cut-and-paste and all the messing about involved in trying to produce a coherent article.

In other respects Multimate is an outstanding package. The helpfulness of the manual and screen prompts will be touched on later, and Multimate has many other features that could with advantage be added to other word processors.

The Format line at the top of the screen always tells you the page, line and column number of the cursor, for example. In the bottom right-hand corner of the screen there are the letters S: and N: which, with an arrow, tell you if Caps Lock and Num Lock are set on the IBM keyboard.

Inserting text

When you press the Ins key to insert, the existing text after the cursor disappears, as usual. In Multimate, however, the continuation is written at the bottom of the screen, to remind you how the text continues. Also, all the text entered while inserting shows brighter on the screen, so you can change your mind about an insertion while you can still see what you have inserted.

Deletion is also very well implemented. Pressing the Del key highlights the character at the cursor. When you move the cursor all further text between where the cursor is and where it was, is highlighted, so you can see exactly what you are about to delete and how well the remaining ends of the text join together. Pressing Del once again instantly removes all the highlighted text.

Finally, underline is implemented using the Overstrike mode, so two characters occupy one space. In other words, you

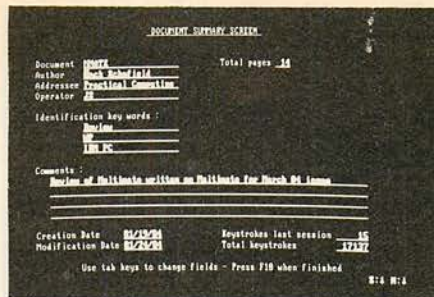

Document Summary screen.

underline on the screen exactly as you would on a sheet of typing paper.

The current user manual is for the 3.10/3.11 version, with a substantial paperback of corrections and enhancements. However, a card assures the buyer a 3.20 manual will be despatched when ready.

The manual is slightly larger than a PC-DOS v2 manual, and about as thick. It is beautifully printed, and ring-bound in a luxury padded cover. It includes a section on getting started, plus four separate training lessons to teach the use of the package. There are also sections on the utilities, a glossary and an index.

With the 3.20 update paperback the documentation is superb. You are not treated like an idiot, but nonetheless full details are provided for everything you need to do. There are also numerous screen displays reproduced in a second colour. Each point is numbered, and explanations are given where required. To quote an example more or less at random, you might be told: "2. Press the Delete (Del) function key. It's immediately to the right of the Ins key." This is followed by a long explanation of what the Delete key does.

It all contrasts wonderfully with standard computer manuals. Normally they either don't tell you exactly what to do — just enough to confuse you — or else blithely say "Press the Blip key three times" when, no matter how long you look for it, there just isn't a Blip key on the keyboard.

If you ever do get stuck, the Multimate manual's reference section is also excellent. It provides direct instructions down one

side of each page, and notes on the other. For example, if you want to move text, the instruction says: "2. Press the Move function key (F7)." The Note column adds, "The system will prompt MOVE WHAT? in the upper right-hand corner of the screen."

In use the program is very well supported by Help screens that can be called up from disc, as with Microsoft's Word. However, the Multimate manual is so well put together it seems a shame not to read it.

Customised keys

Like most new IBM word-processing packages, Multimate comes with a sheet of sticky labels to customise the keyboard. Because we were chopping and changing between different word processors on a single IBM PC the stickers were not used. Multimate is a powerful package, with around 100 commands, and under these circumstances the key codes take a bit of effort to remember.

Instead of using mnemonics, the program mostly uses the dedicated function keys, often in conjunction with Alt, Ctrl or Shift so you start by using the manual a lot. However, there is consistency in the choices. The F2 key is used for page commands: F2 inserts a page break, Shift-F2 combines pages, Alt-F2 tells you the page length and Ctrl-F2 starts repagination.

Other facilities include the usual Search and Replace, horizontal scrolling, merging text from disc, a library routine for storing frequently used headers like your address or whatever, plus both horizontal and vertical addition using the built-in calculator. There is also a spelling checker.

Without the key labels, Multimate is harder to learn than Trendtext, Wordpro Plus or even Microsoft Word, when these are also used without labels. However, it is not particularly difficult to practice.

Detail

The only time I was caught out was when I followed the instruction to use Shift-3 for automatic page numbering. This printed a £ sign at the top of each page. On the U.K. keyboard, the # sign has been moved next to the Return key. Multimate has so many commands it is not possible to describe them all. However, their implementation shows an attention to detail which makes the program a pleasure to use.

To run the spelling checker it is necessary to exit from the text and select 0 from the main menu. You then have to wait while your words are processed, and the screen tells you how many words have been counted, and how many misspelled or, more correctly, how many are not recognised.

To see these words you have to get back into the document, where you now find a winking marker at the start of each dubious

(continued on next page)

The Multimate solution

Multimate was written specifically for the IBM PC, and for a specific company, the Connecticut Mutual Life Insurance Company of East Hartford, Connecticut. Connecticut Mutual decided to move away from large computers and dedicated word processors into the brave new world of the micro. It was called "the Apple solution". Ironically, when the time came to buy the first 1,000 machines, the chosen micro was the IBM PC.

Connecticut's desire for novelty was not so strong that all the staff were forced to relearn how to do things. They were already using Wang dedicated word processors and liked them, and Connecticut planned to use the two systems side by side. The solution was to get something for the IBM PC that was, as far as possible, the same. It didn't exist, so Softword Systems Incorporated was commissioned to write it.

Naturally there were other companies with similar problems and similar needs, so it was not long before Multimate went on general sale to cater for them. After various updates, some of which represent radical improvements, we are now up to version 3.20.

Word processing: IBM

(continued from previous page)

word. You can then ignore the misspelling, or correct the word.

If you like, Multimate will suggest words it has in its dictionary that your word might be. If it is a new word, you can ask for it to be added to the dictionary. All of this is very easily done under menu control. The spellings are, of course, American, so "colour" is marked wrong and it suggests "customise" should have a z. However, this causes surprisingly few problems in practice.

Printing

Printing with Multimate is controlled partly by the settings on the format line within the text, and partly by a menu screen which is held with appropriate default values. One of the strengths of the package is that you can insert format lines where you like inside the text. This solves the problem experienced with Trendtext, which led to involved printing out using chained files. However, it also creates problems if the overall settings on the menu and the format lines are incompatible.

I'm sure it should not be blamed on Multimate, but I had terrible problems printing out the text of this article. Sometimes I got half a page of copy per page, sometimes I got stray blank pages between each page, and sometimes my page breaks did not coincide with the perforations in the paper.

On another memorable occasion, I somehow managed to get the first 10 lines of an article mistaken for a header, and studiously printed at the top of about 15 pages of copy. This is the one case where the manual makes it sound easy — and probably it is — but a lot of paper can pass under the rollers before the right result is obtained.

One nice feature of the printing routine is that it allows texts to be spooled for printing later at a set time. Printing can also take place in Background mode while you are working on another text — but not the one you are printing. Someone with more confidence in their printers than we have could leave the PC to print out a day's work after shutting up shop and going home for the evening. The Print Spool Queue can be edited, so you can interrupt the printing of one document, move another to the head of the queue, then resume printing of the old one.

One thing you see very little of in Multimate is error messages. If you get them, phone CBIS for an answer. During this review I did manage to crash the system while repaginating the text, and got an Out of Record Space error message. CBIS responded promptly with the information that there was a bug here which was being fixed. So no complaints about back-up.

Before phoning I indulged in a certain amount of random key-pressing, then rebooted the system using Alt-Ctrl-Del. When I re-paginated the text with a

different number of lines per page the system recovered and worked. I never lost any text, and that, surely, is a compliment to any word processor.

Conclusions

- Multimate is powerful, with many attractive features which are well implemented and therefore easy to use.
- The system seems rugged. It appears to be well supported by CBIS, which also supports the package in America, where it has much greater market penetration.
- The documentation is of the highest quality, though spoiled at the moment by being in the form of a manual plus an update. When the new manual arrives there should be no cause for complaint.
- If you are a fast writer and heavy corrector you will probably hate the restrictions imposed by having to work in pages. A partial solution is to start with large pages and repaginate at the end, but nonetheless it is restricting to someone used to having the whole text in memory. Others who work in different ways with different kinds of text may find it an advantage rather than a disadvantage.
- Multimate is supplied by CBIS Corporation, 50 Pall Mall, London SW1Y 5JH. Telephone: 01-930 2647. It is available for the IBM PC only and costs £346.50 plus VAT.
- It has a £ sign.

RENTAL SALES * RENTAL SALES

RENTAL

Try out a system of your choice before commitment. Avoid expensive purchase mistakes. Short term rentals available. Available to all users. Have a great deal and our own complete Before and After Sales Service.

Hardware	Software	Printer Range
Apricot £1600	Pulsar Accounts	T.E.C.
Sirius	Languages, Apl etc.	N.E.C.
IBM	Application Programs	Qume
Apple	Visicalc, Cad, Dbase 2,	Richo
BBC	Educational, Tutorial,	Epsons
Commodore	Chemist Labelling Prog.	MicroLine
Oric	Financial Control,	Act Writer
Future FX20	Utilities, Spread Sheet	Plotters
	<i>prog. etc.</i>	Juki

If you require **Mail Order** on Epson Printers, BBC, Oric, Commodore and any others then why not phone for best buy.

FREE SAME DAY DELIVERY & INSTALLATION WITHIN LONDON AT YOUR OWN CONVENIENCE

MICRO RENTAL SALES LEASE

MICRO COMPUTER SPACEDROME INTERNATIONAL (M.S.I.)

3 WESTHOLM, LONDON NW11

Tel: 01-458 5845

Open Mon. → Sat. 8.30-7.00

The FORTH ROBOT

The only educational robot arm to use FORTH the acknowledged control language.

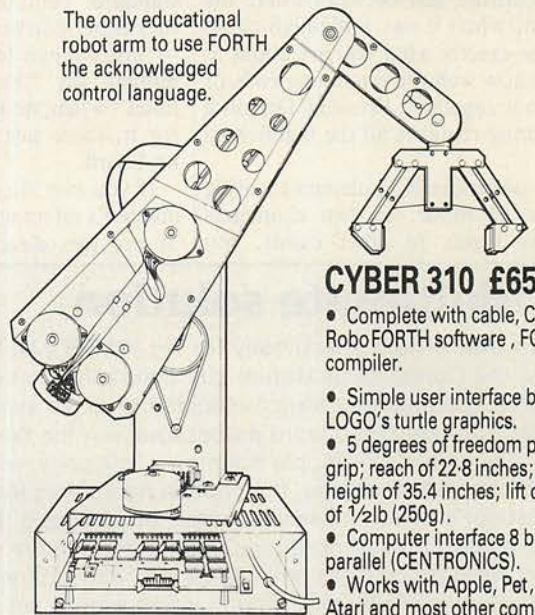

CYBER 310 £650 plus VAT

- Complete with cable, Cyber's RoboFORTH software, FORTH compiler.
- Simple user interface based on LOGO's turtle graphics.
- 5 degrees of freedom plus grip; reach of 22.8 inches; working height of 35.4 inches; lift capacity of 1/2lb (250g).
- Computer interface 8 bit parallel (CENTRONICS).
- Works with Apple, Pet, Acorn, Atari and most other computers. State make when ordering.

Details from

Cyber Robotics Ltd
61 Ditton Walk
Cambridge CB5 8QD
(0223) 210675



Microware and IBM — an unbeatable combination.

We promise to:

- Analyse and identify your requirements.
- Advise on your system needs.
- Supply and install your equipment.
- Provide the widest range of software support.
- Offer comprehensive maintenance contracts.
- Take pride in our unparalleled after sales service.

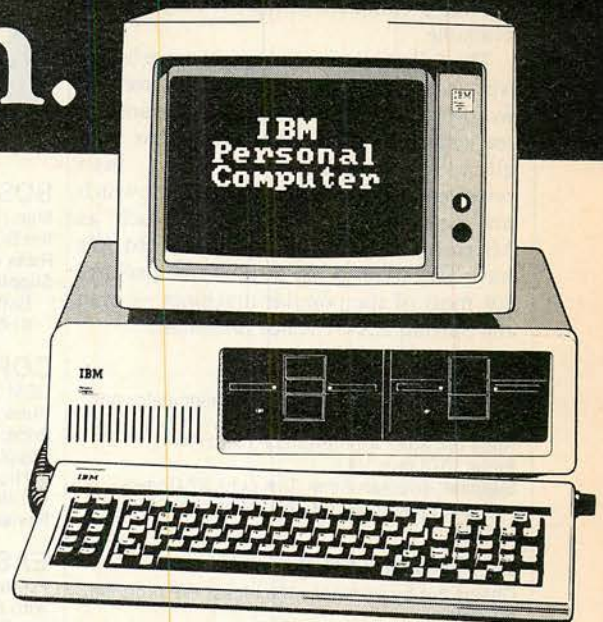

MEMORY EXPANSION

1. Memory expansion from 64-512K
2. Memory expansion with extended features:
 - Printer port
 - R232
 - Games control
 - Battery clock/calendar
 - Expansion up to 512K
3. Memory expansion for electronic disk (RAM) providing capacity of up to 2 Mb

MULTI-TASKING

- Multi-tasking software is now available for PC DOS – up to 9 tasks can be run
- Concurrent CPM

WINCHESTER DRIVES

1. PC Pair
 - Hard disk storage
 - 3.9" Winchester drives
 - Single board DTC controller plugs directly on to PC Bus
 - No additional power required
 - Fixed or removable second drive
2. Our range of 5 1/4" external Winchester provides up to 80 Mb of storage
 - Easy back up facility

NETWORKING

- PC net
- Local area network and shared resource
 - Independent of disk type ie XT, corvus etc
 - Independent hard disk system
 - Remote PC
 - IBM PC DOS 1.1, 2.0
 - Disk and file sharing
 - Low cost, easy to use
 - Simple to set up
 - Up to 16 PC's per file sharer

SOFTWARE

- Pegasus - Business application systems
- Sales Ledger
 - Purchase Ledger
 - Nominal Ledger
 - Invoicing
 - Payroll
 - Stock Control
 - Order Entry
 - D Base II Applications

Our complete list of software is too long to publish, but the widest range is available from stock including:
Wordstar, Mailmerge, Supercalc, D Base II, Fortran 80, Easyfiler, Easywriter, Visicalc

TRAINING

- We offer training to our IBM PC customers:
1. Computer aided training, which, after initial set-up, your PC guides you through the software
 2. On site personal training by our experienced professional instructors

MONITORS

- We recommend from our range the following:
- The new IBM colour monitor
 - LUXOR – high res. colour
 - AMDEK – the only IBM compatible amber screen monochrome available
 - HANTAREX – 14" high res. colour

SERVICE

- We offer a number of service options including:
1. Warranty/non-Warranty repairs
 2. Extended Warranty contracts
 3. Quick response service contracts covering both parts and labour

PURCHASE TERMS

1. Rental agreements
2. Leasing contracts
3. Approved credit purchase
4. Credit cards

Microware

Microware (London) Ltd
Showroom at 637 Holloway Road, London N19 5SS.
Phone 01-263 1125 or Telex 297598.

IBM Authorised Dealer

● Circle No. 134

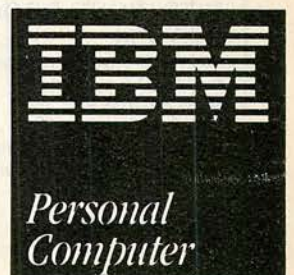

NEW! THE DAZZLER
High Res. Graphics Card for IBM.
1024 x 1024 pixels –
ask for information.

CHOOSING a word processor is far from easy. There are so many packages available: dozens run under CP/M and there are around 100 for the IBM PC alone. Even small micros like the Atari, Acorn BBC and Commodore 64 are getting into double figures. Obviously it is no longer possible to provide a complete listing of the packages available.

The following non-comprehensive listing will, however, help anyone who needs a word-processing package, or just wants to see what is available. Preference has been given to programs which have been reviewed in *Practical Computing*, or which are particularly interesting — such as Microsoft's Word and The Final Word. We have also tried to list at least one package for most of the popular machines — even the Sinclair ZX-81 is not forgotten.

ALPHATEXT

Menu-driven word processor with calculator and database-type facilities

Runs on: Adler Alphatronic P3 and P4

Price: £375 plus VAT

Supplier: Triumph Adler (U.K.) Ltd, 27 Goswell Road, London EC1M 7AJ. Telephone: 01-250 1717

APPLEWRITER II

Cheap, but by no means the nicest WP program for Apples

Runs on: Apple II, IIE, III

Price: £89-£119

Supplier: Apple Computers, Finway Road, Hemel Hempstead HP2 7PS. Telephone: (0442) 48151

Reviewed: PC, February 1983

APWRITER

Menu-driven text editor with filing facilities etc; written in Basic

Runs on: Epson HX-20

Price: £25

Supplier: AP Systems, 90-100 Brighton Road, Kingston, Surrey KT6 5PP

Reviewed: PC November 1983

ATARI WORD PROCESSOR

Disc-based program with excellent documentation

Runs on: Atari

Price: £100

Supplier: Atari International (U.K.) Ltd, Atari House, Railway Terrace, Slough, Berkshire. Telephone: (0753) 24561

Reviewed: See Atariwriter review, PC October 1983

ATARIWRITER

Easy-to-use but powerful ROM cartridge program; works with Mailshot program from Silicon Chip Ltd. Telephone: 01-549 6657

Runs on: Atari

Price: £65

Supplier: Atari International (U.K.), Atari House, Railway Terrace, Slough, Berkshire. Telephone: (0753) 24561

Reviewed: PC October 1983

BANK STREET WRITER

Disc-based program written by educationalists for use by non-specialists and children

Runs on: Apple II, Atari, Commodore 64

Supplier: Softsel

Reviewed: this issue, page 52

BITS WORD PROCESSING SYSTEM

Full-feature word processor which runs under the UCSD-P system

Runs on: IBM PC

Price: £250 plus VAT

Supplier: Boeing Computer Services, 19 Fitzroy Street, London W1. Telephone: 01-631 0808

Which one to choose?

BOS AUTOWRITER

Menu-driven word processor that integrates with the BOS Business Software office system

Runs on: BOS/5 and MBOS/5

Supplier: Microproducts Software (MPSL), 87-9 Saffron Hill, London EC1N 8QU. Telephone: 01-831 8811

CORRESPONDENT 20

ROM cartridge for the Epson HX-20

Runs on: Epson HX-20

Price: £85

Supplier: Epson (U.K.) Ltd, Dorland House, 388 High Road, Wembley, Middlesex HA9 6UH. Telephone: 01-902 8892

Reviewed: PC November 1983

EASY SCRIPT

Powerful but easy-to-use program on disc, works with Easy Spell; by Precision Software

Runs on: Commodore 64, 500, 700

Price: £75 upwards

Supplier: Precision Software, 675 Ajax Avenue, Trading Estate, Slough, Berkshire. Telephone: (0753) 79292

Reviewed: PC December 1983

EASY TABS

Easy-to-use package that works with the Easy Tabs accounting range

Runs on: CP/M, IBM PC

Price: £99

Supplier: Tabs, Sapers House, Chantry Way, Andover, Hampshire SP1 0PE. Telephone: (0264) 58933

EDWORD

Cassette or disc program written by teachers and intended for educational use

Runs on: Acorn BBC Micro

Price: £50

Supplier: Clwyd Technics, The Coach House, Kelsterton Road, Flint, Clwyd. Telephone: (0244) 816236

Reviewed: this issue, page 51

EXECUTIVE SECRETARY

User-friendly but slow package on disc

Runs on: Apple II, IBM PC, Olivetti, M-20

Supplier: Keen Computers, Minerva House, Spaniel Row, Nottingham NG1 6EP. Telephone: (0602) 412777

Reviewed: PC February 1983

FINAL WORD

Powerful package with two windows that can handle several texts at once; similar to Perfect Writer

Runs on: CP/M, IBM PC

Price: \$300

Supplier: Mark of the Unicorn, PO Box 423, Arlington, Ma 02174, U.S.A. Telephone: (617) 576-2760

FORMAT 80

Disc-based package with clever features from Elite Software

Runs on: Apple II

Price: £35

Supplier: Personal Computers Ltd, 220-226 Bishopsgate, London EC2. Telephone: 01-377 1200

Reviewed: PC February 1983

HES WRITER

Professional-style packages for small Commodore micros; available on disc or cartridge

Runs on: Vic-20, Commodore 64

Supplier: Softsel, Softsel House, Central Way, Feltham, Middlesex TW14 0XQ. Telephone: 01-844 2040

HOMEWORD

Disc-based package using icons; intended for use at home or by children

Runs on: Apple, IBM PCjr, Atari

Supplier: Softsel — see HES Writer

Reviewed: PC March 1984

INTEXT

Cassette-based program that makes maximum use of the Epson's built-in LCD display

Runs on: Epson HX-20

Price: £50

Supplier: Talbot Offset. Telephone: (0202) 519282

Reviewed: PC November 1983

ITE +

ROM-based 80-column word processor for the Epson HX-20

Runs on: Epson HX-20

Price: £50

Supplier: Transam, 59-61 Theobald's Road, London WC1X 8SF. Telephone: 01-405 5240

Reviewed: PC November 1983

JUNIPER WORD PROCESSOR

Menu-driven tape-based program

Runs on: Dragon, Oric

Price: £17.25

Supplier: Juniper Computing, 8 Pembroke Green, Lea, Malmesbury, Wiltshire.

LETTER PERFECT

Reasonably priced disc-based package which also links with Data Perfect; disc or ROM versions for Atari

Runs on: Apple II, Atari 800

Supplier: For Apple version — Pete & Pam, New Hall Hey Road, Rossendale, Lancashire BB4 6JG. Telephone: (0706) 212321/227011. For Atari version — Silica Shop, 1-4 The Mews, Hatherley Road, Sidcup, Kent. Telephone: 01-301 1111

Reviewed: PC February 1983

MEMOPLAN

Sophisticated package with multiple documents and split-screen facility from Chang Laboratories

Runs on: CP/M, MP/M, MS-DOS, PC-DOS

Supplier: MPI. Telephone: 01-591 6511

MICROSOFT WORD

Powerful word processor with multiple windows and optional mouse operation; easy to use

Runs on: IBM PC

Price: £275

Supplier: Microsoft, Piper House, Hatch Lane, Windsor, Berkshire. Telephone: (07535) 59951

Reviewed: PC December 1983

MULTIMATE

Three-disc program with many features including a spelling checker; written to bring Wang-style word processing to the IBM PC

Runs on: IBM PC

Price: £346.50

Supplier: CBIS Corporation. Telephone: 01-930 2647

Reviewed: this issue, page 60

This man can use...

**46 Microcomputers 6 Word Processors
16 Printers 2 Mini Computers**



...all without leaving his seat!

Clearway

is a low cost Networking device allowing ALL minis, micros, printers, mainframes etc. to communicate with each other.



- From £150 per connection (node)
- No controller needed.
- Easy installation
- Connects any hardware device through an RS232 interface
- Up to 99 nodes on the same ring
- File sharing software available
- Enables printer sharing
- Has special hunting feature
- Other models available
- Over 3000 nodes currently installed
- Manufactured and supported in UK

Mall the coupon now for full information

Real Time Developments Limited, Lynchford House, Lynchford Lane, Farnborough, Hampshire GU14 6JA. Telephone: Farnborough (0252) 546213 Telex: 858893 Fietel G

I am interested in Clearway - the low cost Networking device, please send me details

Name

Position

Address

Telephone

Send to: Real Time Developments
Lynchford House, Lynchford Lane, Farnborough, Hampshire GU14 6JA
Telephone: Farnborough (0252) 546213 Telex: 858893 Fietel G

● Circle No. 138

SPECIAL OFFER for CBM64

80-COLUMN/GRAFICCARD



- Digital clock
- Mixpossibility of 80-column screen with Hires CBM64-screen (also in colour)
- Grafic pictures; can be switched to background
- Upper line can be locked (for comments etc.)
- Adjustable line spacing for greater clarity on text screens

FREE ADDED!: Sophisticated Wordprocessor with extended manual

£ 59.95

★ Warning: Beware of (inferior) imitations of ZERO-products!

...Surprising bargains for VIC20 and CBM64

EXPANSION UNIT
with 2 slots
£ 5.95

EPROM CARD
two 2 k/4 k EPROM sockets.
Addresses are changeable.
£ 5.95

40/80 COLUMN CARD
Turn your VIC 20 into a professional computer. 40 or 80 columns instead of 22, very sharp and stable picture. Try it out without obligation!
£ 55.95

EPROM PROGRAMMER
for 2716, 2732, 2764, 27128, 2532 EPROMS
Can be easily connected to your computer. Control software in EPROM £ 6.50
£ 31

64 k RAM + 2 k EPROM
With software for RAM-files. Easily connected.
£ 55.95

EPROM-ERASER
erases 4 EPROMS simultaneously
£ 26.50

EXPANSION UNIT
With 5 slots, fully buffered, switches for deselecting slots, and on-board power supply
VIC 20 £ 29.95 * CBM64 £ 36.95

MACH3 PRINTER BUFFER

	16 k	32 k	48 k
par. input - par. output	£ 86	£ 98	£ 109
serial input - par. output	£ 94	£ 109	£ 123

for all our products: Dealer inquiries invited.

zero ELECTRONICS

149 KINGSTREET + GT.YARMOUTH NR30 2PA + TEL:(0493) - 2023 (NASH HOUSE)

- All prices exclude VAT. Shipping costs £ 1.50
- Supplier to schools, universities and government departments.
- We have good documentation of all our products, free of charge.
- All equipment can be tried out without obligation; if returned undamaged within 10 days, you only pay postage and packing costs.

● Circle No. 139

Add on for your micro DIGITAL MULTIMETER

Put your BBC Micro to good use in the electronic workshop/laboratory with this easy to construct Multimeter add-on. Simply plugs into the User and Analogue Ports to allow resistance, capacitance and voltage measurements to be displayed and read from the screen.

Measures: resistance up to 10 megohms (5 ranges)
capacitance up to 10 microfarads (5 ranges)
voltage up to 100V dc (3 ranges)
Software available.

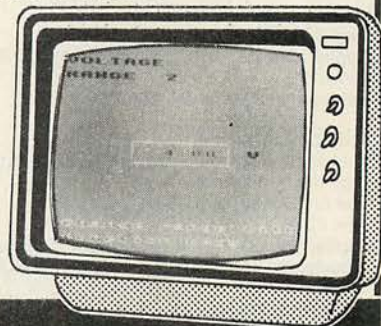

Although tailored for use with the BBC Micro model B, the hardware may be used with other computers equipped with an I/O and analogue ports.

EVERYDAY ELECTRONICS and computer PROJECTS

March 1984 on sale 17 Feb

90p

● Circle No. 140

**THE INTERNATIONAL VIDEO GAME OF THE YEAR COMPETITION
HERALDS THE "NEW AGE" IN VIDEO/COMPUTER GAMES**

\$175,000 TO BE WON

**AND THAT'S
JUST FOR
STARTERS!**

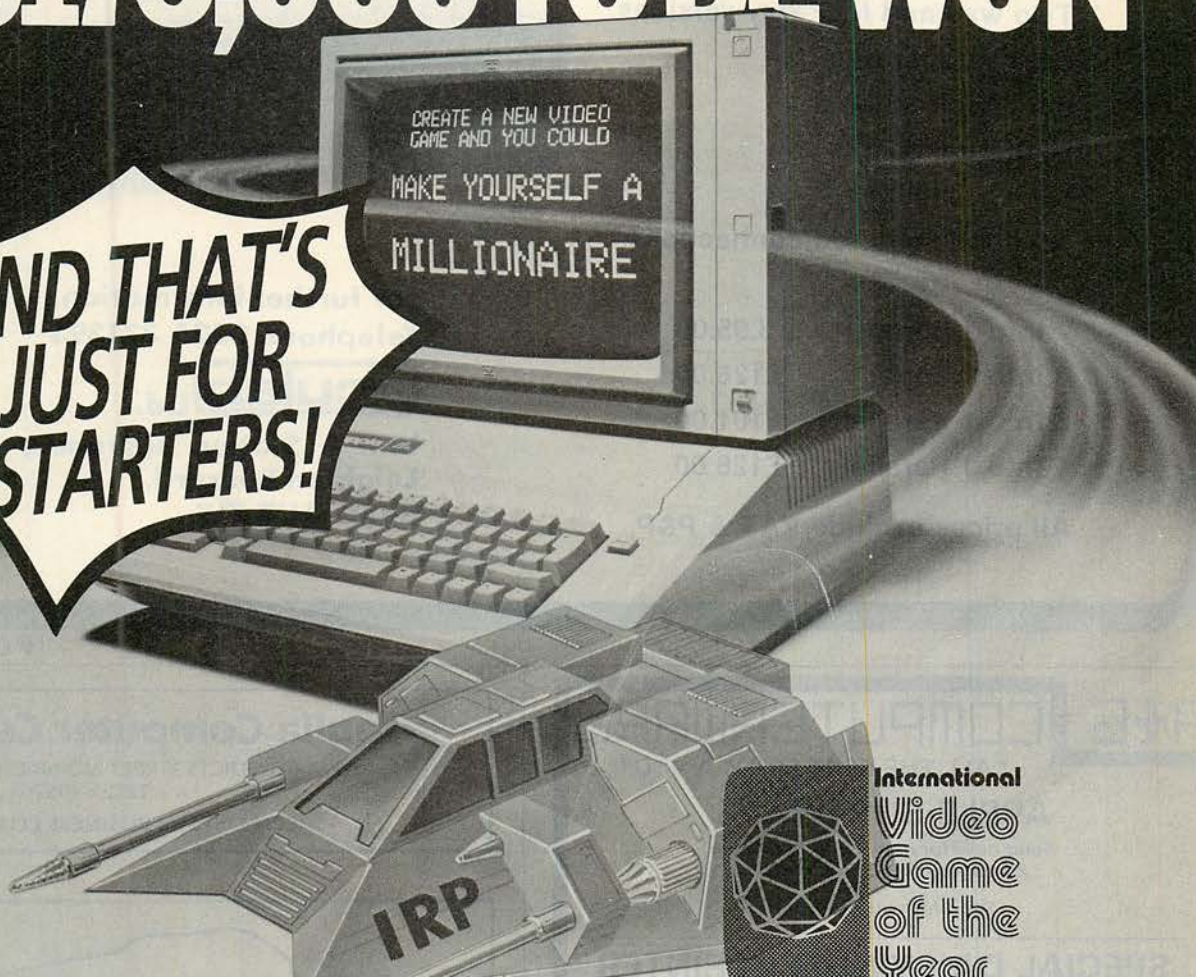

Create a brilliant, new video game and you could be on your way to becoming a millionaire. This fantastic competition, organised by I.R.P. (The International Register of Independent Computer Programmers Ltd) and the famous Mark McCormack International Management Group, offers programmers and inventors the opportunity of a life time. There are huge, immediate cash prizes and the on-going revenue of 10% of the sales of all games to distributors throughout the world, plus the chance to appear on an international TV show. Your skill and imagination could bring you fame and fortune!

\$100,000 FIRST PRIZE! PLUS FIVE \$15,000 RUNNER-UP PRIZES!

Devise a totally original new video game in one of these categories: SPORTS, SIMULATORS, ARCADE, STRATEGY, ADVENTURE/FANTASY or a special section which covers programmes that are not necessarily games but have outstanding Educational or Entertainment merit. We'll also be announcing a number of 'MERIT' awards which will be entitled to carry the message 'An International Video Game of the Year MERIT AWARD' on their retail packaging. It's a great challenge. And the rewards, both financially and in terms of prestige, are tremendous. This is the most exciting competition ever for creative computer and video enthusiasts.

YOU'RE A TV STAR TOO! All six winning games and their inventors will be featured on an internationally distributed, spectacular TV special. That's going to make your name!

HOW TO ENTER

Just send in your game, or games, programmed on cassette for any popular home computer. Use the coupon, today, and we'll send you all the facts you need.

**CLOSING DATE FOR ENTRIES IS
31st MAY 1984**

To: IRP Limited, Pinewood Film Studios, Iver, Bucks, England.

Name

Address

.....
.....
.....

PC1

aculab

data switches

- * RS232 serial.
- * Centronics compatible parallel.
- * Two way and four way versions.
- * Passive operation.
- * Fully bidirectional.
- * High quality.
- * High reliability.
- * No hand soldered connections.

2 Into 1 Serial	£95.00
4 Into 1 Serial	£126.00
2 Into 1 Parallel	£101.00
4 Into 1 Parallel	£126.00

All prices exclude VAT & P&P.

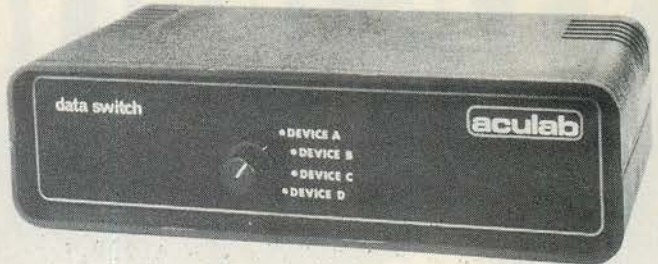

For further information,
Telephone 0525 371393

aculab Ltd.

Unit A, Station Approach,
Leighton Buzzard,
Beds. LU7 7LY

● Circle No. 142

A+G COMPUTERWARE

* ALL THE BEST FROM A + G *

APPLE SOFTWARE

Send now for new 1984 catalogue
24 pages of exciting bargains

Send for your free copy

SPECIAL DAISYWHEEL PRINTER OFFER

SMITH CORONA TP1 PARALLEL OR SERIAL
SALE PRICE £220!!

EXCELLENT VALUE FOR SCHOOLS — OFFICE — HOME
YOUR CHANCE TO GET A REAL BARGAIN!
COMPATIBLE WITH MOST MICROS
FREE DELIVERY IN UK MAINLAND.

MONITORS HI-RES

GREEN £84 — AMBER £90

WORDPROCESSOR PACKAGE ON APPLE IIe,
COMPLETE WITH PROFESSIONAL SOFTWARE &
DAISYWHEEL PRINTER
FROM ONLY £1400! — COMPLETE —
ASK FOR QUOTE — NO OBLIGATION!

DO IT NOW! RING FOR OUR BARGAIN OFFERS

GOVT & EDUC. ORDERS WELCOME.
FREE DELIVERY BY FAST INTERLINK COURIER
PLEASE ADD VAT TO ALL TOTALS

P.O. Box 34, Cheadle, Cheshire, SK8 4PT
Telephone 061-428-2014



● Circle No. 141

Anglia Computer Centre

88 ST BENEDICTS STREET NORWICH NR2 4AB
TELEX 975201 ACOMP G

SPECIALISTS IN BUSINESS COMPUTERS

BUSINESS COMPUTERS

Phone (0603) 667032/3 or 21117

APPLE, SIRIUS,
OSBORNE, ANADIX,
IBM*, DEC, EPSON.

* Complete with professional
back-up service *

HOME COMPUTERS

Phone (0603) 26002/667031

BBC, DRAGON,
COMMODORE 64,
SINCLAIR, ORIC, LYNX.

* On special offer *
Call for Price £££

BOOKS AND STATIONERY CENTRE

Phone (0603) 29652

PROBABLY THE
LARGEST SELECTION
OF COMPUTER BOOKS
IN EAST ANGLIA

ACCESS AND BARCLAYCARD WELCOME

*IBM authorised dealer — IBM Personal Computer

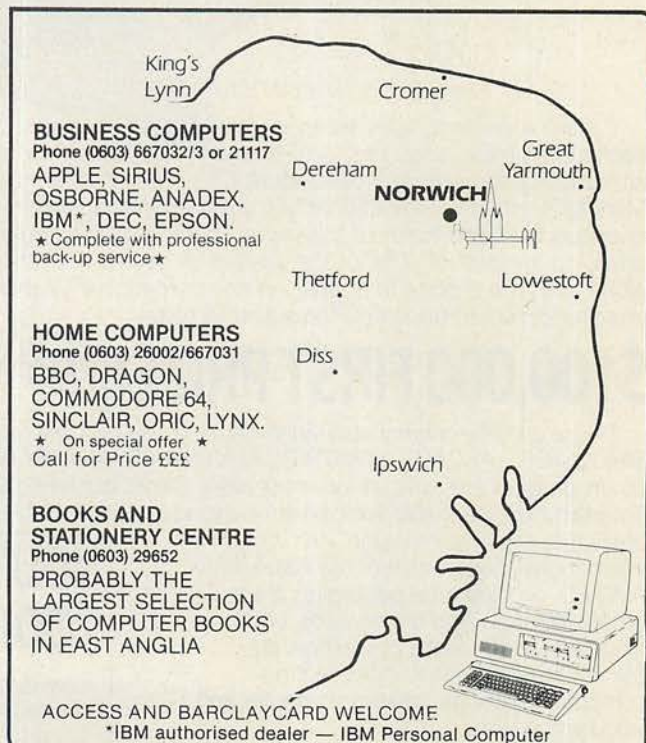

● Circle No. 143

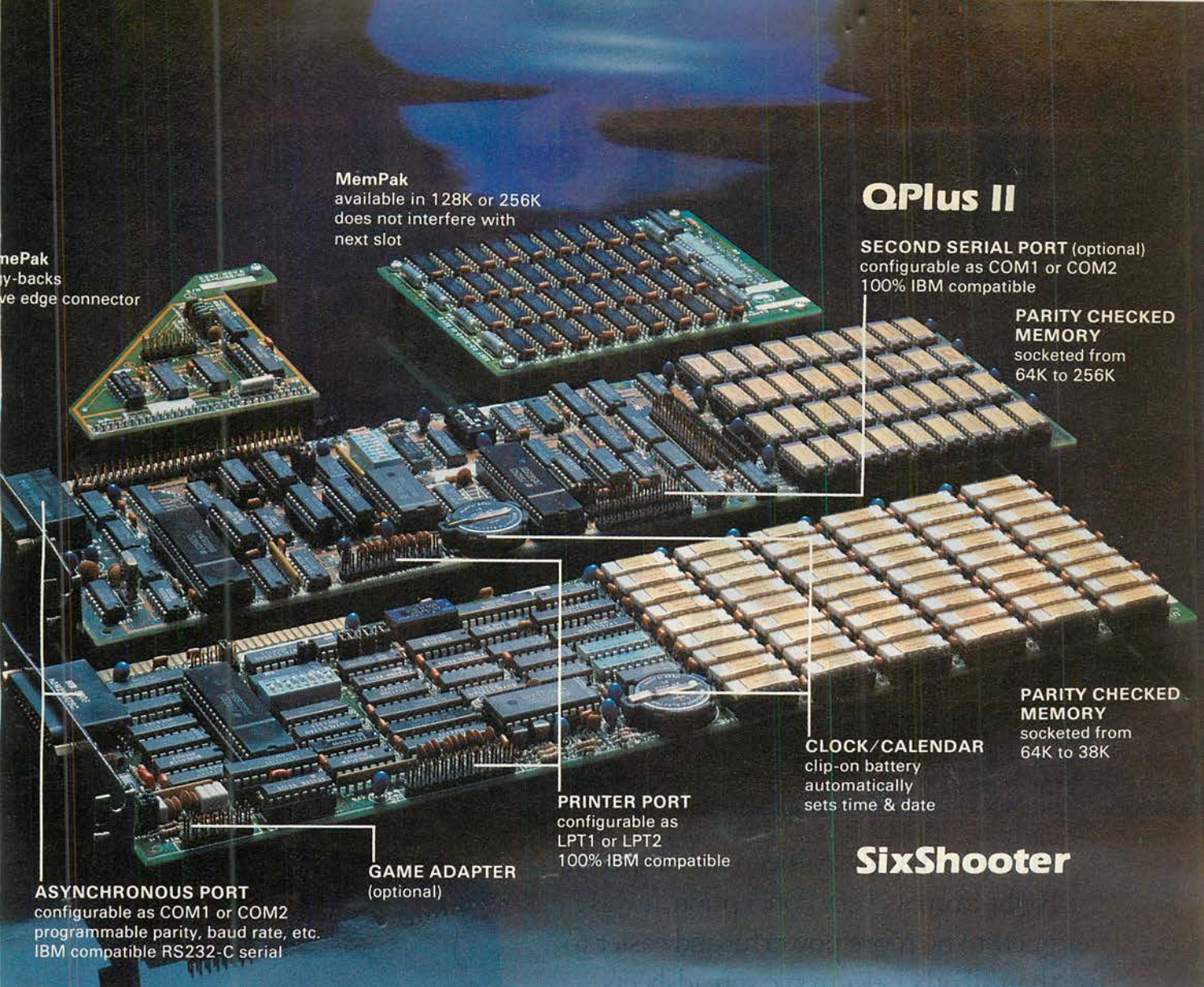

MemPak
 plug-in backs
 with edge connector

MemPak
 available in 128K or 256K
 does not interfere with
 next slot

OPlus II

SECOND SERIAL PORT (optional)
 configurable as COM1 or COM2
 100% IBM compatible

**PARITY CHECKED
 MEMORY**
 socketed from
 64K to 256K

**PARITY CHECKED
 MEMORY**
 socketed from
 64K to 38K

CLOCK/CALENDAR
 clip-on battery
 automatically
 sets time & date

PRINTER PORT
 configurable as
 LPT1 or LPT2
 100% IBM compatible

SixShooter

ASYNCHRONOUS PORT
 configurable as COM1 or COM2
 programmable parity, baud rate, etc.
 IBM compatible RS232-C serial

GAME ADAPTER
 (optional)

The Only Boards You Really Need For Your IBM PC or XT.

OPlus II and the SixShooter are America's most popular pair of enhancements for the IBM PC & XT. They offer the most comprehensive list of features available while occupying just one slot in your computer. State of the art engineering along with the most rigorous quality controls in the industry result in a product in keeping with the high standards set by IBM.

The OPlus II comes standard with clock/calendar, asynchronous serial port (RS232C), Qubie'Pak software, and your choice of memory from 64k to 256k. Options include: a second asynchronous port, a parallel printer port, a game port on a plug-in "piggy-back" board, and a choice of 128k or 256k MemPaks. MemPaks give you the ability to add a total of 384k or 512k of memory in one slot.

The SixShooter is ideal for the new model PC. It offers a battery powered clock/calendar,

asynchronous port, parallel printer port, Qubie'Drive & Qubie'Spool software, and your choice of memory up to 384k, all standard. Optional is an IBM compatible game port adapter.

Also included with both boards is the Qubie'Drive™ disk emulation software. It allows you to create up to three "electronic disk drives" in memory which access your programmes at the speed of RAM memory. You also get Qubie'Spool™, a programme which allows you to assign a portion of memory to act as a print spooler.

Both boards are backed up by a one year parts and labour warranty. Visit your local dealer and pick up a brochure with the full details. If he doesn't have the information have him give us a call. Your PC will really thank you.



QUBIE' DISTRIBUTING LTD.

Tempo House, 15 Falcon Road
 London, SW11 2PH
 (01) 223-4569, 223-7662

● Circle No. 144

There are spreadsheets and spreadsheets And there's

Multiplan has always been rather special. Right from its very conception, it was designed to be more powerful and easier to use than all other electronic spreadsheets.

And it is.

Multiplan will give you fast access to the information needed to make decisions.

And allow you to explore the possibility of that information.

All presented in attractive easy to read formats, rather than the cryptic codes of

	1	2	3	4	5	6	7	8
	January	February	March	April	May	June		
SALES:	4700	6000	6500	7500	9000	9500		
COSTS:								
Materials	300	250	310	420	530	620		
Wages	1500	1500	1500	1500	1500	1500		
Heat/Light	100	100	100	100	100	100		
Rent	1750	1750	1750	1750	1750	1750		
Stationery	60	20	15	20	25	30		
TOTAL COSTS:	3750	3655	3695	3790	3910	3995		
GROSS PROFIT:	950.00	2345	2005	3710	5090	5505		

COMMAND: BLANK Blank Copy Delete Edit Format Copy Help Insert Lock Move
Name Options Print Quit Sort Transfer Value Window Xternal
Select option or type command letter
R19C3 R1-151C-R1-31C 99% Free Multiplan: one

Easy to read formats.

	1	2	3	4	5	6	7	8	9	10	11
	January	February	March	April	May	June	July	August	September	October	Six-months
SALES:	4700.00	6000.00	6500.00	7500.00							43200.00
COSTS:											
Travel	13.00	19.00	27.00	17.00							138.00
Stationery	60.00	20.00	15.00	20.00							175.00
Heat/Light	100.00	100.00	100.00	100.00							590.00
Materials	300.00	250.00	310.00	420.00							2430.00
Equipment	500.00	1200.00	300.00	900.00							4100.00
Wages	1500.00	1500.00	1500.00	1500.00							9000.00
Rent	1750.00	1750.00	1750.00	1750.00							10500.00
TOTAL COSTS:	3750.00	3655.00	3695.00	3790.00							3995.00
GROSS PROFIT:	950.00	2345.00	2005.00	3710.00							5505.00

COMMAND: BLANK Blank Copy Delete Edit Format Copy Help Insert Lock Move
Name Options Print Quit Sort Transfer Value Window Xternal
Select option or type command letter
R1C1 99% Free Multiplan: FOUR

Comparing information with windows

our competitors.

When we say Multiplan is easy to use, we mean just that.

With a capacity of 63 columns by 255 rows, there's not much you can't feed in. And, more importantly, it can actually link information in different worksheets.

Which means that adjustments on a primary worksheet can automatically be made on related sheets.

readsheets readsheets.

Multiplan.

Move up to Multiplan

Because Multiplan offers such powerful models and presentation capabilities, it's capable of all sorts of little extras.

You can sort entries alphabetically, or present the result of a formula in either numbers or as a message.

And users of 'other products' can move

up to Microsoft as Multiplan can read their models directly. So there's no excuse.

There are businessmen and businessmen.

And there's you.

MICROSOFT[®]
Right. First time.

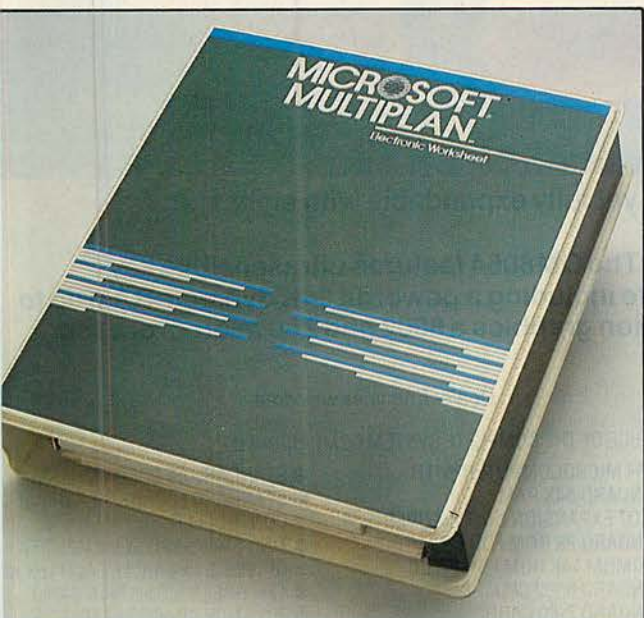

Multiplan is available on MS-DOS, Apple and CP/M 80 microcomputers.

If you require more information complete the details below or telephone us direct.

Please send me further information on Microsoft Multiplan.

Name _____

Position _____

Company _____

Address _____

Microsoft Ltd., Piper House, Hatch Lane, Windsor, Berks
SL4 3QT. Tel: (0753) 559951.

PRA03/4P1

Revolutionize the way you think about computers

The new OM8064



The 8064 packs all the power you will ever need. Sleek and trim, yet fully expandable with eight slot expansion unit.

The newly designed compact keyboard is a piece of art in itself. The OM8064 features ultrasensitive key and single key programming commands, you will get much more including a powerful 64K dynamic RAM up to 14K of ROM, 24 line x 40 character text display with high resolution graphics a 6502 and Z80 microprocessor.

CP/M Wordstar, SuperCalc 11 and Friday
OR
CP/M Wordstar, Calstar and Info star
OR
CP/M, CP/M Trainer, BASIC Trainer, BBC BASIC,
Personal Database and PlannerCalc.
Complete systems plus maintenance on the software package.
£1,600 plus VAT

Dealer Enquiries welcome

THE PRICE OF THE COMPLETE SYSTEM COMPRISING OF:

OM8064 MICROCOMPUTER WITH
* STANDARD 64K RAM
* 8 SLOT EXPANSION UNIT & COVER
* STANDARD 2K ROM FOR CP/M®
* MAXIMUM 14K ROM FOR BASIC
* STANDARD 6502 CPU
* STANDARD Z-80 CARD
* STANDARD CENTRONIC I/F CARD & I/F
CABLE

* STANDARD 80 COLUMN CARD
* STANDARD FLOPPY DISK DRIVE
CONTROLLER
* TWO 5¼in SSSD SLIMLINE DISK
DRIVES & I/F CABLES EACH 163 KE
* 12in GREEN MONITOR & CABLE
* JOYSTICK ADAPTOR CABLE
* TV ADAPTOR
* TAPE RECORDER CABLES

● Circle No. 146

● Circle No. 20

TASHKL COMPUTER SYSTEMS LTD
24 LOGAN ROAD, WEMBLEY, MIDDLESEX HA9 8PX
TEL No. 01-904 4467. TELEX No. 296708

CP/M is a registered trade mark of Digital Research Inc.

A new accent on PC performance

These instantly installed plug-in expansion boards offer major functionality enhancement for the IBM PC and other micros. They come with full software support on floppy disk.

FORTE MODEL PC 78

Gives your PC direct access to your mainframe (IBM 43xx through 30xx). A single plug-in board connects to your IBM 274/3276 Cluster Controller via existing coaxial cable. No extra phone lines, modems or peripherals.

Entire functionality on floppy disk, no PROM changes.

- Parity check memory on display RAM.
- Complete configuration from keyboard.
- Re-configures colour attributes to taste.
- Choice of Basic or C, with broad sub-routine library.
- Serial interface.
- User-friendly, high-speed file transfer.

PARADISE MULTI-DISPLAY BOARD

Gives a slot in the PC. Colour display controller, monochrome display controller and printer interface all on one plug-in board.

Compatible with PC/XT and all the best productivity software.

High-resolution colour graphics, fully IBM compatible.

2 pages of high-resolution graphics, facilitating animation or high demand graphics operation.

- Flicker-free scrolling, even in colour.
- External switch or software control for monochrome or colour mode.
- IBM character sets and test modes.
- Compatible with widest range of RGB and composite video monitors.
- IBM type printer port.
- IBM-compatible light pen and RF modulator ports.

LSI 1553-NET

The ultimate in user-friendly Local Area Networks (LAN's) - very low cost, very high speed, plus reliability that approaches a 10⁻¹⁷ bit error rate.

Connects IBM PC, Apple II/III and any S100 bus micro.

3 megabit/sec transmission rate, operating at around 15% utilization and giving a throughput which approximates to that of current 10 megabit bandwidth LAN's.

Superior error checking, collision detection and collision avoidance.

- Lives entirely within constraints of host operating system, preserving upward compatibility; e.g. the interface to the IBM PC is at the ROM BIOS level.
- Simple coax connection.
- Up to 4000 feet, without the use of repeaters.
- Protocol entirely contained in software, permitting various implementations of LAN protocols.
- Variable block sizes supported, from 20 bits to over 64K bytes.

ACCENT ON PERFORMANCE

Accent Computers is a new European force in specialised hardware distribution, bringing you selected state-of-the-art products from some of the world's most innovative designers and manufacturers.

Accent Accent Computers Ltd
PO Box 62 London SW10 9LT
Tel: 01-370 0862

To Accent Computers, I would like further information on:
FORTE MODEL PC78 PARADISE MULTI-DISPLAY BOARD VSLI 1553-NET Please tick

Name _____
Company _____
Address _____
Tel. _____

PC3

Dealer enquiries welcome

When you add up micro equals ours.

You won't find another micro offering a range of benefits that add up like the Olivetti M20's. There's a choice of seven M20's ranging from a personal computer through to a highly intelligent workstation that can take you into a multi-user network.



A wider choice of software.

We've designed a range of software programs that includes general accounting, word processing, financial planning, spreadsheets and graphics. But if you find you need specialised software that is not available from us, the M20 offers a choice of four main operating systems (MS-DOS, CP/M-86, PCOS and UCSD-P*). So it can handle literally hundreds of different software programs to satisfy virtually every business or professional application.



True 16 bit technology for speed and efficiency.

Unlike some of its major competitors, the M20 is a true 16 bit personal computer. So it's more powerful than most micros.



Choice of 20 printers.

As the world's leading producers of electronic typewriters, we also lead in computer printing technology. We make no less than 20 printers compatible with the M20.



The M20 can talk to other office machines.

With its own built-in communications facilities the M20 can talk to other office machines such as typewriters, making them intelligent word processors and printers. And linked to a telephone and communications equipment it can access Prestel, mainframe computers, receive or send telex messages and even Autodial. So the M20 can take you further into office automation.



The M20 can handle new networking developments.

The M20 allows you to build a multi-user network incorporating a massive central memory for extensive file storage with fully integrated software for electronic mail and text and data processing. Building a network like this with any other company would normally mean having to buy components from separate manufacturers. Olivetti supply everything from a single in-house source.

We are pioneers in computer technology.

Our total investment in R&D is one of the largest the world and is committed to advancing computer technology for the businessman. We developed the first true 16 bit personal computer for under £2000 and are the leaders in ergonomic design of computers.



The depth of service you'd expect from a multi-national company.

Our distributors are the best trained in Europe. Before they are allowed to so much as look at an M20 they are put through a comprehensive course at our very own school. And our force of 600 service engineers cover the entire country to give fast and efficient service to every Olivetti customer.



Proven reliability in a computer marathon.

The M20 is one of the most reliable micro computers in the world. In fact, in a recent computer marathon, not one but two Olivetti M20 micro computers ran continuously, day and night, for a full week without even a single hiccup.



It's our experience that helped us become the leading European manufacturer.

For 75 years we have been helping all sizes of business become more efficient. No other company has this understanding of the businessman's needs combined with over 30 years experience in computer technology. Olivetti is now the largest European manufacturer of computer and office equipment. So we will always be around whenever you need us, unlike a lot of computer manufacturers who won't even be in business in a few years time.



At £1,795 it doesn't just add up to a better computer, it adds up to complete office productivity.

The Olivetti M20 is available now from only £1,795 or £9.88 per week to lease (plus VAT). And unlike most micros, it comes complete with free manuals and a one year guarantee. For more information on how to take your business into complete office productivity, complete the coupon.

the facts, no other



The M20E personal computer from
£1,795 or £9.88 per week to lease (plus VAT).

To: Valerie Belfer, British Olivetti, Olivetti House, 86-88 Upper Richmond Road, Putney, London SW15 2UR.
Tel: 01-785 6666. Please send me brochures on the M20 personal computer.

PC/1

NAME _____
POSITION _____
COMPANY _____
ADDRESS _____
TEL NO. _____

olivetti

● Circle No. 147

Isn't it time you stopped running your computer at printer speed?

In ten seconds, your computer can output enough print data to keep your printer busy for five minutes, or longer.

Instead of waiting around for the printer, you could install a print buffer, and free your computer for its next task in seconds.

Print buffers take care of the printing — and the waiting. And the more you print, the more time a buffer will save.

Buffers for any combination of micro and printer/plotter. Internal buffers for Epson printers; Apple Computers. 'In-line' buffers for IBM PC, Sirius, Commodore 20/40/80 series, Super Brain, BBC, Tandy, etc.

Data transfer in RS232c serial, Centronics-parallel, IEEE-488 formats. Protocol conversion. RAM sizes from 2K to 256K.

A-Line Computer Systems

1 Church Farm Lane,
Willoughby Waterleys,
Leicestershire LE8 3UD.

Telephone:
Peatling Magna (053 758) 486

Talk to the specialists.
We have the answers.

● Circle No. 148

DISKS DISKS DISKS

*** LOWEST PRICES — FAST DELIVERY ***

PRICE PROMISE

We will Better any lower delivered price advertised in the current issue of PC Please Telephone

5.25" DISKS — BOXES OF 10

	Prices per Box (£)			QTY	AMOUNT
	1-4	5-9	10-49		
DYSAN					
104/1 S/ide S Dens 48tpi 40Tr	21.00	20.00	19.00		
104/1D S/ide D Dens 48tpi 40Tr	23.00	22.00	21.00		
104/2D D/ide D Dens 48tpi 40Tr	31.00	30.00	29.00		
204/1D S/ide Q Dens 96tpi 40Tr	33.00	32.00	31.00		
204/2D D/ide Q Dens 96tpi 40Tr	39.00	38.00	37.00		
VERBATIM DATALIFE (Five year warranty)					
MD525-01 HR S/ide S or D Dens 48tpi 40Tr	15.25	15.00	14.50		
MD550-01 HR D/ide S or D Dens 48tpi 40Tr	21.50	20.75	19.50		
MD577-01 HR S/ide D or Q Dens 96tpi 77/80Tr	22.00	21.25	20.00		
MD557-01 HR D/ide D or Q Dens 96tpi 77/80Tr	28.00	27.50	26.00		
10 or 16 hard sectors at same price.					
Free plastic case for limited period only.					
VERBATIM VEREX (One year warranty)					
MD200-01 Soft Sector uninitialised	14.25	13.75	13.25		
MD200-AS Apple Systems Only	14.00	13.50	13.00		
MEMOREX					
3431 HR S/ide S Dens 48tpi 40Tr	14.50	14.25	13.75		
3481 HR S/ide D Dens 48tpi 40Tr	14.80	14.50	14.00		
3491 HR D/ide D Dens 48tpi 40Tr	20.50	19.75	19.00		
3504 HR S/ide Q Dens 96tpi 40Tr	23.00	22.25	21.50		
3501 HR D/ide Q Dens 96tpi 40Tr	25.00	24.25	23.25		
BASF (Qualimetric) — Special Offer					
1X S/ide S Dens 48tpi 40Tr	13.25	13.00	12.50		
1D S/ide D Dens 48tpi 40Tr	16.50	16.00	15.50		
2D D/ide D Dens 48tpi 40Tr	20.00	19.25	18.50		
ACCESSORIES					
HCK5 head Clean Kit with Fluid	15.90	15.50	15.00		
LC5 5.25 Library cases EGLY	1.90	1.80	1.70		
LB40-5 Lockable Box 40 Cap inc Disk Pen	13.50	13.00	12.50		
LB85-5 Lockable Box 85 Cap inc Disk Pen	17.50	16.50	15.50		
VCK-5 Verbatim 5 in Head clean kit	6.40	6.20	6.00		
VCD-5 Verbatim 5 in Hic disks (per 10)	12.50	12.30	12.10		

p & p

Total Exc. VAT

VAT 15%

Total Payable

8" DISKS — BOXES OF 10

Phone for most Competitive Prices for Verbatim, Basf, Memorex and Accessories.

POSTAGE/PACKING (UK)

5.25 Disks/Clean Kit £1/Box* (75p/Box 5+, 50p/Box 10+)

Library Case £2.50/Box (£2/Box 5+, £1/Box 10+)

Lockable Box

*Add 30p/Box for 1st Class

Please contact us for Quantity Discounts (10+ Boxes) and Trade Accounts. Official orders accepted from Government and Educational Establishments.

Name

Address

Access/Barclaycard/Cheque No

If you do not wish to cut out form send order separately

34 Cannonbury Avenue, Pinner, Middx HA5 1TS

Telephone orders any time — we do the rest — 01-868 9548



Pinner Wordpro



● Circle No. 149

VAT INCLUDED | MRLSM | FREE DELIVERY

Expand your
ELECTRON
with
MRL'S ELECTRON-CLOUD®

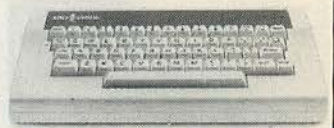

A NEAT "BLACK BOX" CONTAINING:

- EC1 Centronics Printer Interface (with Cable)
- EC2 A/D Converter and Joystick Ports
- EC3 Double User I/O Ports

Complete only £79

SEPARATE:

- EC1 Printer Interface (Base Unit) £39
- EC2 A/D Converter and Joystick Ports £29
- EC3 Double User I/O Ports £29

Available Mail Order (10 Days), soon to be on sale in many High Street Outlets.

Coming soon:

- ECDI Disk Interface approx £99
- ECSP Speech Synthesiser approx £39

Also Available: Spectrum Printer Interface (Fully compatible, e.g. with TASWORD 2) £39 and ATARI PRINTER DRIVER £45 Plus lots more.

Micro Research Ltd, FREEPOST 0506- Industrial Unit 6, Knightsbridge East, 31605 LIVINGSTON, West Lothian, Scotland. EH54 5BR.

● Circle No. 150

IBM P/C £15

That's right you could win an I.B.M. p/c when you become a member of Computer Consortium. This competition is open to all members who have joined the consortium on or before the 30th March 1984. The draw will take place on the 2nd of April 1984. The winner will be notified by post.

The computer consortium has been operating in the U.S. for the past two years with an incredible amount of success. At last these facilities are now available in the U.K. There are six very good reasons why you should become a member of the consortium as thousands have in the U.S.

Reasons-

- 1/ You will have access to a huge selection of different products, which you can buy at the same price as your high street dealer.
- 2/ Free delivery anywhere in the U.K. within 3-4 days.
- 3/ Credit facilities on hardware over 1-2-3 years.
- 4/ Monthly newsletter showing latest additions to product range, advertisement section, competitions.
- 5/ New products being added to the range every month.
- 6/ Facility to advertise your used computer hardware to all members, we can even give you credit facilities on 2nd hand equipment.

And of course all hardware is covered by the manufacturers warranty.

Once you become a member you can buy the following products from the consortium. Star Printers. Juki, Sanyo, Shinwa, Fidelity, B.M.C., Zappler, Olivetti, Oric, Tec, Oki, Epson, Hermes, Kokusai, Hitachi, Cannon, Riteman, Commodore, Acorn, Spectravideo, Cumana, C.A.L., Atari, Sinclair, + All games and software.

How do you join? That's simple all you have to do is send off with your application your annual subscription fee of only £15 + VAT that will immediately entitle you to use all the facilities of the consortium. We will by return send you your membership number with all the information of products, software, orderforms, & prices.

Please enrol me as a member of the computer consortium. Send me my member starter pack. I enclose a cheque/po for £15 + VAT. (£17.25p) made payable to COMPUTER CONSORTIUM

Name _____

Address _____

_____ Postcode _____

Send to Computer Consortium
20 Kerris Way, Lower Earley, Reading Berks.

● Circle No. 151

**Now that Rank Xerox has
come up with the most
versatile microcomputer
system, what will the
competition do?**

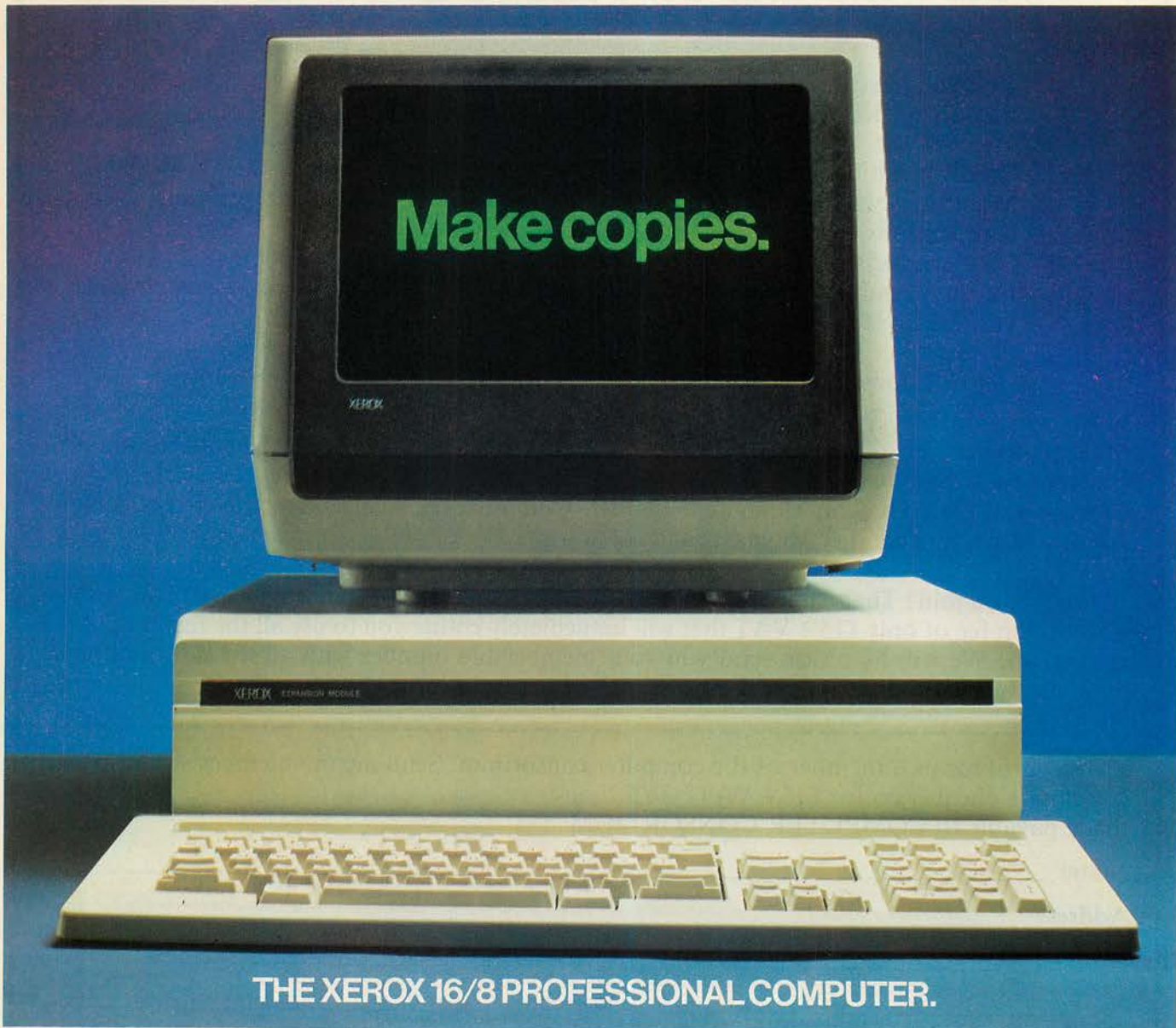

THE XEROX 16/8 PROFESSIONAL COMPUTER.

RANK XEROX

It may surprise some people to discover that the most versatile micro-computer package is made by the pioneers of photocopying—Rank Xerox.

Others would have expected it.

Because Rank Xerox has always been on hand to make life easier in the office. And now the time is right for the microcomputer to take its turn.

Eventually, we expect the most versatile microcomputer range to have its imitators.

But there can only be one original—the Xerox 16/8PC.

So, what is so special about the Xerox 16/8 professional computer?

It is a unique package of features which together make up a system programmed to meet both your present and future needs.

It's actually two computers in one.

With two processors and two memories. A 16 bit computer with 128K memory and an 8 bit computer with 64K memory.

We've used a pure 16 bit 8086 chip which is faster and more powerful than other 16 bit computers. The 16/8PC enables you to carry out two functions at the same time.

For example, you can be working on a financial spread-sheet program while the second computer outputs a word processing document to a printer.

The expansion box allows you to select extra functions (such as graphics, 3278 emulation or additional memory).

The system is modular. This means you can add 'peripherals' as you need them and be assured that they will all be totally compatible with each other.

In this, the Xerox 16/8PC is unique.

This is the Xerox way to combat obsolescence.

Because you can upgrade our system as and when you need to. Being compatible, you will never need to scrap what you have and start again. We have also made the Xerox 16/8PC easy to operate. The low profile keyboard has clear graphics to represent the various functions and the layout makes it simpler and quicker to use.

Last, but not least, the 16/8PC has a built-in capacity for a mouse, the unique means of cursor addressing invented by Xerox.

All in all, we're offering you a flexible and totally integrated package. Not one of our competitors can say as much.

But, given time, they'll make copies.

Find out more today. Freepost this coupon or call the operator and ask for Freefone Rank Xerox.

FREEPOST THIS COUPON TODAY. NO STAMP REQUIRED
To Rank Xerox (UK) Ltd., Freepost, Admail 38, London NW1 1YH.
Please let me have, without obligation, further information on the Xerox 16/8PC.

Name _____

Position _____ Tel. No. _____

Company/Organisation _____

Address _____

Postcode _____

Type of business _____ Please tick if you are a Rank Xerox customer

24-HOUR INFORMATION SERVICE. ASK THE OPERATOR FOR
FREEFONE RANK XEROX

OR DIAL 01-380 1418

© Xerox and Rank Xerox are registered trade marks of Rank Xerox Ltd.

COLOURJET

7 COLOUR INK JET PRINTER

Logic seeking in dot address mode

£499 + VAT

With Centronics parallel interface and free BBC Micro dump listing.

Options available:

- Buffered RS232 interface.
- Viewdata & RS232 interface.
- Apple II interface.
- IBM PC dump.

Specifications:

640 dots/line.

84 dots/inch both axes.

Friction feed rollpaper with single sheet feed A4.

37cps in full colour.

Ink cartridges, 4 million character life.

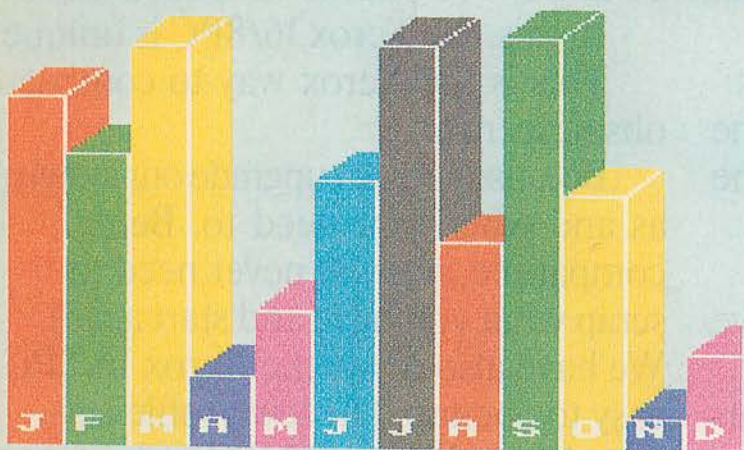

from BBC Micro screen — ½ size mode

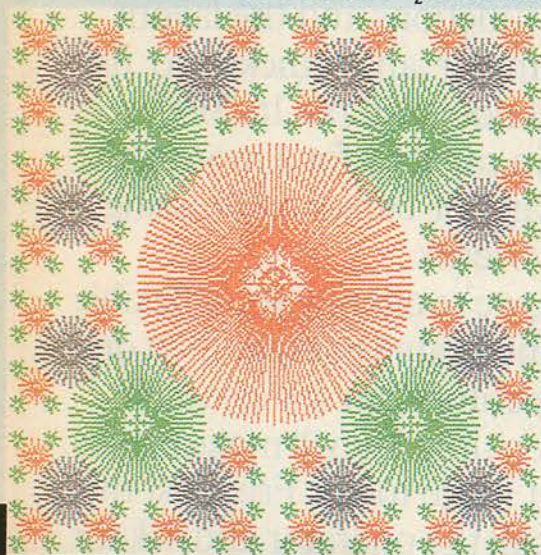

Virtually
silent

INTEGREX

INTEGREX LTD.

Church Gresley, Burton-on-Trent, Staffs DE11 9PT
Tel: 0283 215432 Telex: 377106

• Circle No. 153

Dealers, OEM & Educational
enquiries welcome

YOU HAVEN'T SEEN ANYTHING LIKE THIS ON A COLOUR MONITOR BEFORE.

An RGB monitor from JVC offering a resolution of 370x470 pixels for less than £150?

We guarantee you won't see another bargain like that in this or any other micro mag—or in any other supplier's showroom.

For we've managed to acquire the sole distribution rights to these superb machines and we are able to offer them at an unbeatable price.

There are two models available: medium resolution (370x470 pixels) at £149.95; and high resolution (580x470 pixels) at £229.95. (Both excluding VAT.)

The units have a 14" screen and are suitable for the BBC Micro, Lynx, Oric, Apple, and most other leading micros.

They are robustly constructed in a handsome cream casing. And come with a full year's guarantee.

Delivery is good: your monitor should arrive by courier service within ten days of our receiving your order.

You can order by filling in the coupon below and posting to: Opus Supplies Ltd., 158 Camberwell Road, London SE5 0EE. Or by telephoning 01-701 8668 quoting your credit card number. Or, of course, you can buy in person at our showroom between 9am-6pm Monday-Friday, 9am-1.30pm Saturday.



MODEL REFERENCE	1502-1 Medium Resolution	1502-2 High Resolution
RESOLUTION	370 x 470 Pixels	580 x 470 Pixels
C.R.T.	14"	14"
SUPPLY	220 2.40v 50/60Hz	220 2.40v 50/60Hz
E.H.T.	Minimum 19.5kv Maximum 22.5kv	Minimum 19.5kv Maximum 22.5kv
VIDEO BAND WIDTH	6MHz	10MHz
DISPLAY	80 characters by 25 lines	80 characters by 25 lines
SLOT PITCH	0.63mm	0.41mm
INPUT VIDEO	R.G.B. Analogue/ TTL Input	R.G.B. Analogue/ TTL Input
SYNC	Separate Sync on R.G.B. Positive or Negative	Separate Sync on R.G.B. Positive or Negative
EXTERNAL CONTROLS	On/off switch and brightness control	On/off switch and brightness control

To Opus Supplies Ltd., 158 Camberwell Road, London SE5 0EE.

Please send me _____ Medium Resolution Colour Monitor(s) at £149.95 each (ex. VAT).

_____ High Resolution Colour Monitor(s) at £229.95 each (ex. VAT).

_____ Connection lead(s) at £6.00 each.

I understand carriage per monitor will cost an extra £7.00.

(N.B. A Medium Resolution Monitor including VAT, lead, and carriage costs £187.39. A High Resolution Monitor including VAT, lead, and carriage costs £279.39.)

I enclose a cheque for £_____ Or please debit my credit card account with the amount of £_____ My Access/Barclaycard

(please tick) no. is _____

Please state the make of your computer _____

Name _____

Address _____

Telephone: _____

Opus.
Opus Supplies Ltd.

PC5

● Circle No. 154

**Somehow we at the University of Artscience
must move into the 80's and
provide computers for class teaching.
The budget is inadequate.
What is the best solution?
Who understands the needs of
University Departments?**

**I run a window cleaning service
from my own home.
I need to keep track
of staff and regular bookings.
I want a computer for the business
that the kids can use as well.
Which is the best?
Who can tell me about software?
Who will provide me with training?**

Whatever the question, you're more likely to find the answer at Transam.

We recognise that the choice of microtechnology is becoming overwhelming, and it's growing all the time.

That's why we're redesigning and enlarging our showroom to accommodate one of the widest ranges of business, home and portable micros.

Doesn't that make the choice more difficult?

Not with the advice and expertise available at Transam.

A wide range enables us to explain, demonstrate and compare systems and software more objectively.

We can answer all your questions on software, peripherals and upgrades and provide a comprehensive range of books and manuals to give you more insight at every level.

Where else could you find all this in one store?

That's one question we can't answer.

Transam Microsystems Limited
59/61 Theobalds Road London,
WC1X 8SF Telephone: 01-404 4554



Transam
MICROSYSTEMS LIMITED

I do the accounts for a group of charities.

**I need a computer
to speed up the process,
help forecast future needs
and do letters**

to the sponsors and membership.

Where can I get advice?

Who would help me start?

**I want a portable computer
for site work and calculations.**

**Which one would provide me
with what I want on site
and link easily with
the office computer?**

**Could a similar machine
be used by
the Sales Team?**



THE computer store.

Phone us today for your FREE copy of our new 36 page products guide.
Access, Barclaycard and American Express welcome. Telephone orders accepted. Opening hours are
9am to 5pm weekdays and 9.30am to 1pm Saturdays. Export enquiries welcome.

● Circle No. 243

MIR MICROCOMPUTER RENTAL

From Micro-Rent, Britain's top-value specialist in microcomputer rental.

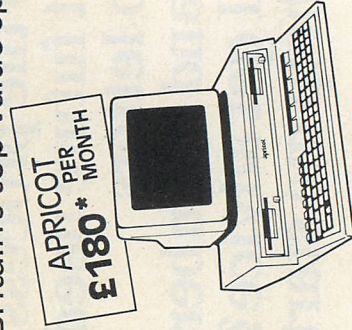
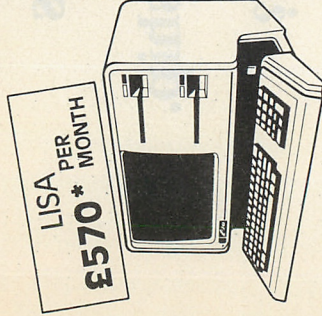

- Try before you buy
- Flexible terms to suit your needs
- Immediate delivery of all these models
- No capital outlay

Micro-Rent is Britain's top-value microcomputer rental specialist. You can hire on a short-term basis, try the leading machines fully in your own business before deciding which one is the right choice for your particular needs.

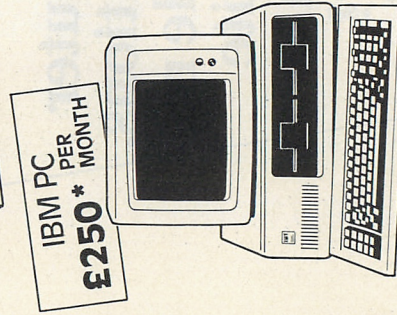
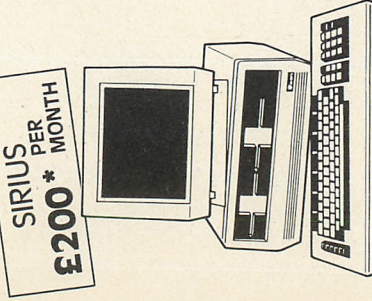

Micro-Rent is completely independent of any manufacturer, and offers expert impartial advice on all aspects of microcomputer use.

CALL TODAY 01-607 8797

* Prices quoted are based on 3-month rental, excluding VAT.



MICRO RENT

8 Thornhill Road, London N1.

● Circle No. 155

LONDON COMPUTER CENTRE

8/16 bit SOFTWARE The comprehensive range includes

WORDSTAR £235	D BASE II £349
SUPERCALC II/III £190/£275	SPELLING CHECKER £80
WORD PROCESSING	LANGUAGES
Spellbinder 290	MBasic 215
Peach Pack* 332	MBasic Compiler 235
Multimate 134	C Compiler 330
Spellstar 50	Fortran 80/86 325
Mailist 85	Cis Cobol/Forms2 399/105
FINANCIAL PLANNING	Pascal MT + SSP 240
Plannercalc 85	Pascal MT + SSP 350
Multiplan 170	ACCOUNTING
Lotus 1-2-3 357	Pegasus from 250
D BASE CORNER	Peachtree from 325
FastBase 150	Sage 375
Autocode 195	Exact 500
Quickcode 205	Pulsar from 195
Dgraph 190	COMMUNICATIONS
Friday 185	Bstam 130
Innotsar 266	Crosstalk 135
DMS 400	Movet 80/86 90
UTILITIES	*incl. PeachSpell/Mailist
Sid £60, ZSid £76.	Please telephone for the LCC
Mac £133	Software Catalogue

FORMATS: Superbrain, Televideo, Sirius, Sanyo, Osborne Northstar, 8" SD, DEC, Epson QX-10, IBM ICL, H-P, XEROX, ALTOS, Apricot, NEC-APC & many more
All prices are exclusive of VAT

New! The fast and easy way to generate your own dBase 11 Applications programs – use fastBase. £150.

- * only fastBase allows 7 index files per data base, all others allow 1 index file
- * only fastBase allows report generation on 3 files others 1 file
- * fastBase Structures Command files with indentations allowing maximum speed in execution
- * fastBase uses a series of on-screen prompts and Help Menus to lead you through the process of generating your own dBase 11 Command files.

Demonstrations on all software daily – call in or order by mail.

43 Grafton Way, London W1P 5LA (Opposite Maples)

Opening Hours: 10-7 Mon-Fri. 12-4 Sat.

01-387 4455 (4 lines) Telephone Answering Service After Office Hours

Telex: 8953742

● Circle No. 156

Analysts/Programmers

£8,000-£15,000 PSION 

We are a leading microcomputer software house with an outstanding record of growth and profitability, active in the fields of business applications, systems and home entertainment software.

We are currently recruiting analysts/programmers with microcomputer experience and experience of VAX VMS, C, MS-DOS, 8086, 68000, Z80, 6502, Cross Assemblers or Simulators.

Competitive salaries are offered, based on relevant experience. This is an exciting opportunity to join a young, dedicated and highly trained team in one of Britain's fastest growing companies.

Apply in writing, enclosing a Curriculum Vitae to: The Recruitment Manager, Psion Ltd, 2 Huntsworth Mews, Gloucester Place, London NW1 6DD

● Circle No. 193

PayRight

Payroll software you can trust

PAYRIGHT IS A HIGHLY RELIABLE PAYROLL PACKAGE, DESIGNED TO MEET THE MOST EXACTING REQUIREMENTS. IT MAY BE USED BY YOUR EXISTING CLERICAL STAFF, AND NO TECHNICAL KNOWLEDGE IS NEEDED.

- * Sixty different pay elements and deduction types.
- * Wide choice of payslip style, with all payslip stationery easily available off the shelf.
- * Fully conforms to statutory requirements for PAYE, NIC, and SSP. Rates may be changed by the operator in minutes.
- * Equally suitable for payroll bureaux and for companies' own wages departments.

PAYRIGHT RUNS ON MOST CP/M-BASED MICROS. PRICES FROM £300 TO £500 DEPENDING ON FEATURES. DEMONSTRATION PACK £50, REFUNDABLE AGAINST SUBSEQUENT PURCHASE. TRADE ENQUIRIES WELCOME.

From the payroll experts:

MIKE LEWIS CONSULTANTS LTD.

48 Willoughby Road, London NW3 1RU. Tel: 01-794 3886

Please send full details of PAYRIGHT, without obligation.

PC2.

Name _____

Position _____

Company _____

Address _____

Postcode _____

Type of business _____

● Circle No. 194

make your apple a leader

... give it the advantage of a "next generation" operating system — more flexible; more friendly; more powerful; and at least three times faster.

Every month a new crop of rivals for the Apple appears. Now with the aid of ALS you can put *your* apple to the front of the class.

The Apple started off first — is still in the top group — and now you can put your Apple back in front where it belongs . . .

With CP/M PLUS and the CP/M CARD by Advanced Logic Systems and Digital Research your Apple can now run 3,000 application programmes, including WORDSTAR and the MicroPro range; the PERFECT range including Perfect Writer/Speller/Filer etc. and other world-leading software.

For less than £300.

For more information, contact:

scope systems ltd

13 carlisle road
queens park
london nw6 6tl

01 969 9365

CP/M PLUS and CP/M CARD are registered trademarks of Digital Research Inc. Apple is a registered trademark of Apple Computer Inc. Wordstar is a registered trademark of MicroPro International Corp. Perfect is the registered trademark of Perfect Software Inc.

● Circle No. 195

The Alpatronic

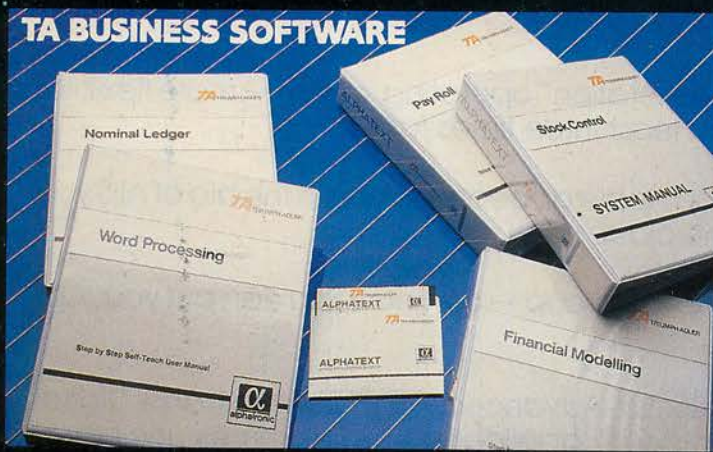

The Alpatronic Personal Computer makes playing, learning and working more fun, more fulfilling, more rewarding. But when you put it to work, then it really means business. In fact it's probably the cheapest way to access business programmes through CP/M software.

The games first though — enough for the most ardent player. Some just plug into a socket at the back, with their own 16K Rom module. Others can be played from virtually any cassette recorder. There are arcade games to sharpen reflexes and test imagination. Educational programmes to increase knowledge, plus chess and other traditional games.

You'll benefit from the learning programs. There are cassette instruction courses on writing programs in BASIC. Other cassettes get you and your family off to a flying start into skills like typing, household budgeting, tax returns and investment management. And of course there's our own

instruction and BASIC interpreter manual.

Now to business. The Alpatronic PC is unusual in giving you low-cost access to a complete version of CP/M, the world's most popular operating system for business software. You just connect up one or two floppy disc drives and a printer, then you can run a whole host of new management programs: office word processing, business accounting packages and financial planning — the choice is tremendous.

The keyboard is a real delight compared with competitive models. There are very few confusing multi-function keys, and a really professional numeric keypad included. Six separate keys can be programmed and indexed for special routines. And the full alphanumeric keyboard is just like a modern electronic typewriter.

You may recognise the keyboard, because the

C means business

TA ALPHATRONIC PC



TA GAMES HARDWARE



TA EDUCATION HARDWARE



TA BUSINESS HARDWARE

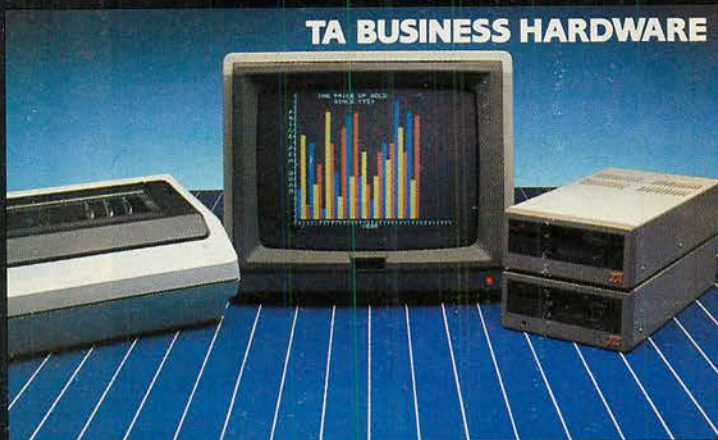

Alphatronic PC is from Triumph Adler, leading European manufacturers of business machines, who supply offices in 100 countries worldwide.

That means real commitment and continuity in design, engineering and software support. For instance, TA can ensure you can get everything you'll need — ribbons, paper, ink, disks, upgrading peripherals — from just one source.

So you play and learn on the Alphatronic PC, and get good value for money. Or you can really make it work for you. Then you'll really see what it's worth.

For you, your family and your business, get your own on an Alphatronic PC now.

Please let me know where I can try the Alphatronic PC.

Name: _____

Address: _____

Telephone: _____

TA

TRIUMPH-ADLER

Triumph Adler (UK) Limited, 27 Goswell Road, London, EC1M 7AJ.
Telephone: 01-250 1717

● Circle No. 158

J3

APPLE MACINTOSH

Ian Stobie reports on an afternoon spent with Apple's latest contender for the fleet market.

AT FIRST glance the Macintosh seems to be a junior version of Apple's Lisa — a smaller, portable Lisa which will probably sell for around £1,500. But the Macintosh is far more important to Apple than this. It is intended to be Apple's main mass-market office computer: the key machine if the company is to have any chance of defending its position against IBM.

In spite of the pressures on Apple, which has slipped to number 2 behind IBM in the PC market, the company has kept its nerve. The Macintosh continues the independent architecture pioneered with the Lisa — it is not a standard MS-DOS, CP/M or Unix machine. This time Apple has taken steps to ensure a larger amount of independent software for the machine in addition to the

initial range of Apple-written applications. Some 25 major software houses have signed deals to transfer their established packages across to the Macintosh, with Microsoft's Multiplan and Lotus 1-2-3 in the first batch. A version of MS-DOS is likely to be available at some stage, providing a broader bridge between Macintosh and the IBM software universe.

Volume building

Huge volumes of Macintoshes are reputedly going into production at Apple's new factory in Fremont, California. According to one independent source, upwards of half a million units is the target for 1984. Meanwhile the Lisa will be sold in

smaller numbers to users with more specialised requirements who need a higher-capacity machine.

Physically the Macintosh looks neat, compact and distinctive. It is a box system comprising main unit, separate keyboard and mouse. The main unit has a 9in diagonal high-resolution black and white screen and a single built-in Sony 3.5in microfloppy drive. The keyboard is on the end of a coiled cable, and looks like the Apple IIe keyboard. The mouse is connected by a thin cable to the back of the main unit. It is restyled and more square-looking than the Lisa mouse, but it is of the same type, with a single button on top and a large ball-bearing underneath. Set up on a desk the whole system is very upright, and



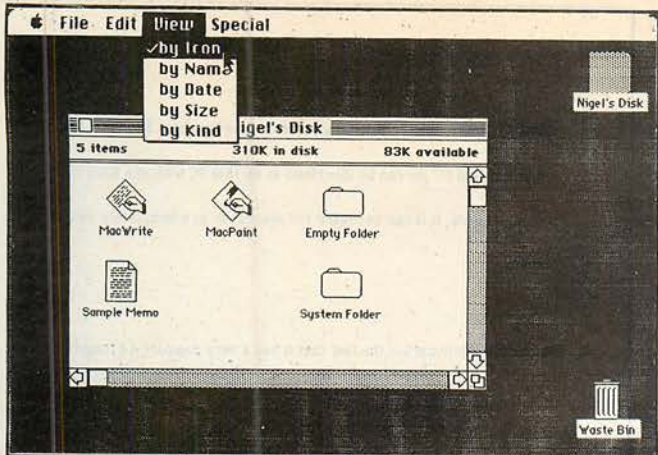

The Macintosh presents a very similar face to the user as the Lisa, with multiple windows, high-resolution graphics symbols and pop-down menus. Here a window has just been opened up to see what is on a disc called Nigel's disc. This is an accurate dump of the screen, produced on the Macintosh printer.

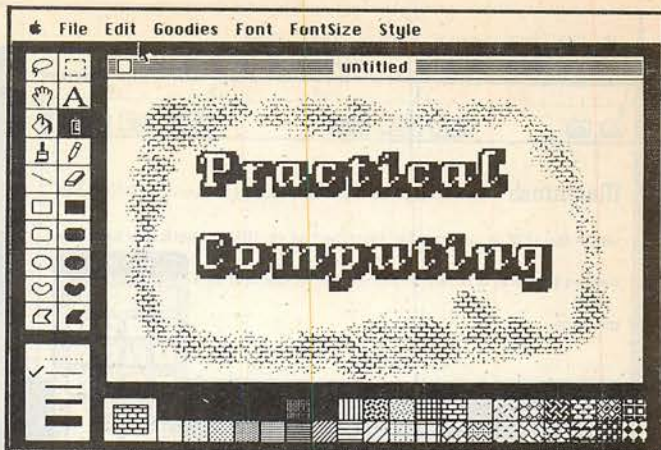

The Macpaint aerosol can has been selected from the set of painting tools shown down the left-hand side of the screen together with a brick-wall pattern from the set of patterns shown along the bottom. Used in combination they sprayed a brick-wall pattern around lettering entered earlier as text.

looks unlike any other computer I have come across, the nearest being the Hewlett-Packard 150 and 200 series.

Together all three units weigh 21lb., and fit easily into the optional Macintosh carrying case. Setting the system up again is straightforward, since a power cable is all that is needed to connect up to the mains. Interestingly, Apple does not see portability as a particularly strong selling point — the design goal was to produce a machine of which vast numbers could sit on office desk tops. Therefore neatness and compactness matter most and portability is a side benefit. The main unit takes up the same space on a desk surface as an A4 pad.

Lisa-like

The other major feature which Apple hopes will appeal to office-equipment buyers is the easy-to-use Lisa-style software covering all the major office tasks — word processing, financial planning, scheduling and so on. Built into the Macintosh is VT-100 emulation software to allow it to take over the mainframe computer terminal's role.

There are probably about eight million office desks in the U.K. alone, plus 25 million in Europe and 50 million in the U.S. About seven percent of U.S. office workers presently use personal computers, so the potential for growth is enormous. All the design ideas embodied in the Macintosh attempt to exploit this marketing opportunity: it is not intended as a traditional data-processing machine but is meant to be a simple tool for office use. Apple would have us believe this kind of personal computer will soon be as accepted as the telephone.

Like the Lisa, the Macintosh is built around Motorola's powerful 68000 chip. This allows some multi-tasking capacity to be built in, and makes simultaneous handling of the mouse input device, the high-resolution graphics display and the main applications task a practical proposition at an acceptable speed. Eight-bit

technology could not support the demands imposed by this level of highly graphic and interactive software.

The other major constraint on any systems performance is how much memory is available. The Macintosh comes with 128K of RAM as standard. This is supplemented by 64K of ROM, which contains the Lisa-like operating system and a host of useful routines for doing things like reading the mouse position or displaying windows.

The 128K of RAM available is good but not exceptional for a modern machine. Lisa comes with 1Mbyte, while the fundamental limitation imposed by the Motorola 68000's 24-bit wide address bus is 16Mbyte. The obvious question is why the user is not provided with more memory. The answer seems to be the world-wide shortage of RAM chips. When 256Kbit RAM chips become readily available the Macintosh will almost certainly be expandable internally to 512K. At the moment 128K looks like being both the standard and the maximum RAM for the Macintosh when it is launched. Of this 128K of memory, 85K is available for the user's applications.

Microflops

The Macintosh's built-in 3.5in. micro-floppy has a formatted capacity of 400K and is single sided. The mechanism is bought in by Apple from Sony. The decision to use Sony discs suggests that the floppy-disc system Apple developed for the Lisa, which requires non-standard 5.25in. floppy media with two read/write slots in place of the usual one, will soon be dropped. A revised version of the Lisa with Sony discs seems likely.

The Macintosh comes fitted with a disc controller that will accept a second microfloppy drive plugged into the back of the machine. No hard disc is planned for the Macintosh at present, although it is an obvious product for a third-party supplier to offer.

On the back of the Macintosh are two

high-performance RS-232 serial interfaces capable of transferring up to 1Mbit per second. One is configured as a printer interface, the other for communications. Apple itself is supplying only one printer for the machine, a 120 cps dot-matrix printer priced around £430. It is made by the Japanese C. Itoh company, but Apple has adapted it to print Macintosh graphics. In use it is surprisingly quick, and a good deal faster than the Lisa and its printer at dumping graphics. Apple says it will cooperate with a third-party printer supplier to get other printers working with the Macintosh.

Apple Bus

Details of Apple Bus, which will use the serial ports, will be announced some time after the Macintosh launch. Apple Bus is a low-cost alternative to the Ethernet-style network offered by the Lisa. It will allow you to connect up several Macintoshes, and to mix Macintoshes and Lisas in a local area network, along with other peripherals.

A lot of thought has gone into the design of the Macintosh. Both the main unit and keyboard have reinforced anchor points for anti-theft chains. There is no Reset button in the conventional sense; instead you have to push a separate plastic key through the side of the case to reset.

Getting inside the Macintosh is also not easy, and is not meant to be. You need an especially long Allen-key to get the casing off. Although a full technical manual will be available for the Macintosh, it is not an open system in hardware terms. Apple does not force a whole host of hardware add-ons, with users forever opening up the case to try out a new card as with the Apple II. Third-party add-ons will have to connect up externally through the serial ports or the disc-interface socket.

I am not sure whether the change of strategy is altogether a good idea. Third-party suppliers will be more restricted in what they can provide for the Macintosh.

(continued on next page)

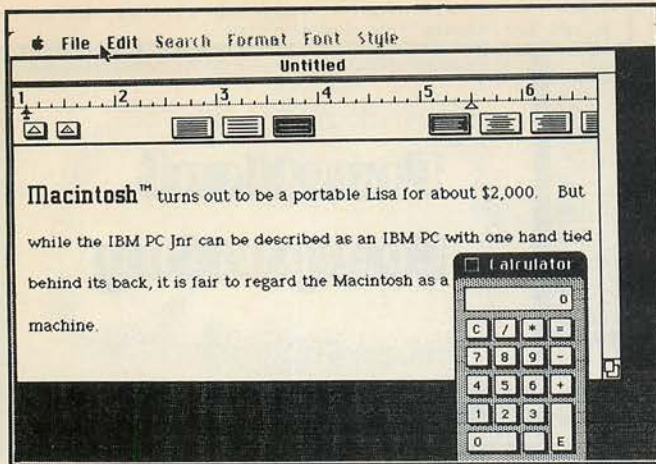

The ruler at the top shows Macwrite's margins, Tab stops and the spacing and formatting selected. This document is to be triple-spaced and justified left, so the appropriate symbols are emphasised in black. As with any other Macintosh application, while using Macwrite you can get out the calculator, the clock or other Macintosh tools to help.

(continued from previous page)

The Apple II's success owes a lot to the flexibility the user gained from a universe of add-ons which fitted into the seven free expansion slots. The fact that the Apple II series is now the most widespread CP/M system owes little to Apple's original concept and everything to the independent makers of add-on Z-80 processor cards. I would have thought that when taking on IBM, Apple needs all the allies it can get.

Turning the machine on, the first thing that comes up on the screen is a picture of a smiling face followed by a "Welcome to Macintosh" message. If you insert a disc, a detailed picture representing an empty desk top is displayed; on the desk top is a disc symbol with the name of the disc underneath it and a waste-basket symbol. If you move the cursor over the disc symbol using the mouse, the disc symbol opens up into a window showing what is on the disc.

Applications like Macpaint or Macwrite are initiated in the same way. Macpaint is an impressive drawing package, suitable for producing visual aids for presentations combining text, diagrams and graphics. Text is entered at the current cursor position using the keyboard, and can then be moved, enlarged and restyled in a variety of fonts. You use the mouse to control a variety of drawing tools including a paintbrush, pencil and aerosol can — Macintosh displays an appropriate cursor in each case. Several ways of undoing work are provided, including a simulated eraser whereby you move a pencil-eraser symbol on the screen to rub out lines.

A palette is available for providing particular types of shape, like rectangles and circles. A rubber-band feature, which lets you stretch a line across from a fixed point and move it around until you are ready to fix the other end down, is particularly fun to use.

Macpaint is much faster in use than the equivalent Lisa package, Lisadraw, reviewed in *Practical Computing* August 1983, though the Lisa is a more powerful

machine with hard disc and more memory. This is partly the result of the extra year the Apple software team have had since the Lisa to rethink things.

Single sheet

But Macpaint is more limited than Lisadraw in several ways. With Macpaint you work on a single sheet of paper, whereas Lisadraw allows you a large number of contiguous sheets to let you do true scale drawings. Further Macpaint is manipulating bit patterns rather than the stored parameters of graphic objects, which limits your ability to redraw things. But for the ordinary office, as opposed to the drawing office or studio, these limitations are not important, whereas the advantage of speed is. However, when duplicating entire documents — or making disc back-ups — the absence of a second disc drive slows the Macintosh down.

Macpaint and Macwrite will probably be bundled together and sold in the U.K. for about £100. Other Apple applications will be available at the time of the launch for other typical office tasks and will cost £99 each.

The Macintosh takes a significant step forward in terms of software integration. All the Apple-written packages work in similar ways and you can transfer data between them. But the big advance is that many of the third-party packages, including the Macintosh versions of well known established products, promise to have the ability to share data with the Apple applications and with each other.

This ability is connected with the Macintosh's 64K of ROM. The entry points to all the routines in the ROM are being made public, and third-party suppliers are encouraged to use them when rewriting their software for the Macintosh. The ROM routines observe certain conventions for representing data. One part of the operating system, called Scrap Manager handles the cut and paste operations for

Macintosh™ turns out to be a portable Lisa for about \$2,000. But while the IBM PC Jr can be described as an IBM PC with one hand tied behind its back, it is fair to regard the Macintosh as a completely new machine.

For its intended market the fact that it has a very compact A4 footprint

Macwrite prints out the same text in the normal way, as a document. The Macintosh dot-matrix printer is adequate for correspondence. Apart from cost and the fact that it is the only compatible printer available yet, its advantage over a daisywheel printer is that it can handle all the Macintosh's graphics and typefaces.

applications like Macpaint and Macwrite. Scrap Manager recognises two formats for transferring data: pure ASCII text and graphic objects using Macintosh conventions.

Any package using Scrap Manager to manipulate data internally should also be able to transfer data across to another package that uses Scrap Manager. Most independent suppliers of Macintosh software will probably make extensive use of the ROM routines simply to shorten their development time and shorten the length of their code. The additional benefit to the end-user is the ability to move data between applications.

The initial two languages Apple will be offering for the Macintosh are impressive. MacBasic is a structured Basic; line numbers are optional and you can have labelled subroutines with named para-

Specification

CPU: Motorola 68000 running at 8MHz.

RAM: 128K, for max RAM.

ROM: 64K containing operating system, user interface software and programming toolkit.

Display: 9in. diagonal CRT with high 512-by-342 dot resolution. Shows graphics and text in wide variety of type sizes and styles which can include 80-by-24 characters if you like.

Keyboard: Detached QWERTY-layout keyboard very similar to the Apple IIe's. All keys software redefinable. Optional numeric keypad available as separate unit.

Mouse: One-button rolling-ball type.

Discs: One 3.5in. Sony microfloppy drive built into main unit, single-sided, with formatted capacity of 400K. Optional external boxed 400K microfloppy drive. No hard disc at present.

Interfaces: Two RS-232 high-speed serial ports running at up to 1Mbit per second one configured for comms, the other for printer. External disc-interface. Sound output socket.

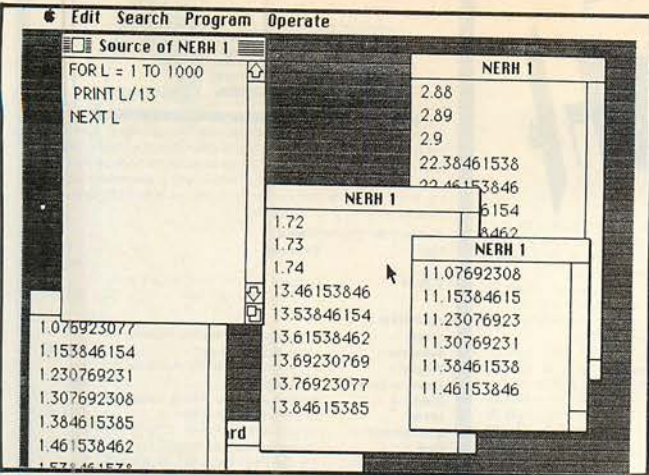

The Macintosh can do some clever tricks to help the programmer using MacBasic. Here one version of a short Basic program is shown in the window at the top left for editing. Four other windows show the output from various earlier versions of the program, which were all still running and displaying new results when this snapshot screen dump was taken.

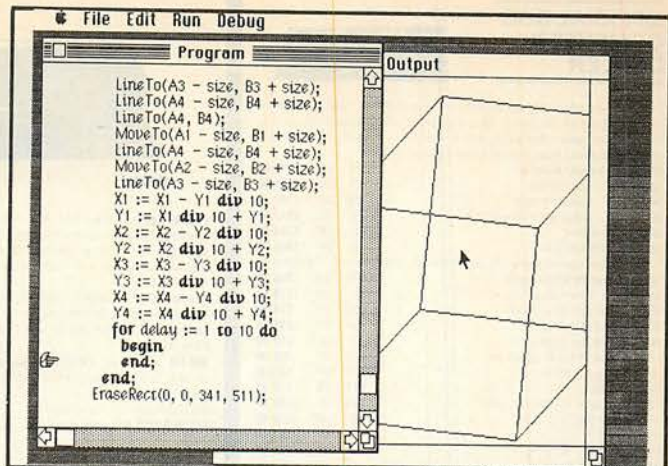

One window shows part of a MacPascal program as it executes; the other shows the output, in this case an animated graphic of a rotating box. The little hand in the program's window shows the instruction currently being executed.

ometers passed to them. Normally you would use Basic in conjunction with the routines in the Macintosh's ROM to handle the screen display. All the usual structured constructs are included.

The ability of the Macintosh to handle multiple windows helps when debugging programs. You can define a window for program output then run the program while you examine the code in another window. This is useful when using the single-stepping debugging aid. Although the Macintosh does not have the full multitasking abilities of the Lisa, you can run several small Basic programs simultaneously, with the output going to different windows. I did not have the opportunity to run our standard set of Benchmarks, but MacBasic is manifestly fast, as you would expect with a 58000-based system.

Portability: Weighs 21lb. Mains-powered. Optional carrying case available. Footprint on desk without keyboard is A4.

K. price: Probably £1,500 for single-disc system with 128K of RAM, screen, keyboard and mouse. Application software is priced separately, but system disc, tutorial disc, owner's manual and tutorial audio cassette are included in the base price.

Software: Apple-written packages will probably cost £99 each in the U.K., with Macpaint and Macwrite bundled together at a lower price. The initial list is Macwrite, Macpaint, Macproject, Macterminal, MacBasic, MacPascal, MacLogo, Macassembler. Other languages — C, Fortran, Cobol and Forth — are under development. Third-party software includes Multiplan, Lotus 1-2-3 and the PFS database series.

Manufacturer: Apple Computer Inc. Made in U.S.

K. Distributor: Apple Computer (U.K.) Ltd, Eastman Way, Hemel Hempstead, Hertfordshire HP2 7HQ. Telephone: (0442) 60244. Available April 1984.

MacPascal is an interpreted Pascal. Syntax is checked as you type the program in, and you then run it without having to compile. MacPascal is source-code compatible with Lisa Pascal and programs can be easily transferred between the two types of machine via the serial link.

Rival micros

In hardware terms the Macintosh has no exact equivalent but there are other machines aimed at the same office-market slot, the most successful being the IBM PC. The Macintosh starts with a big price advantage: a system with a dot-matrix printer and a couple of applications probably works out at just over £2,000 compared to about £3,000 for a similar IBM set-up. As the IBM PC contains roughly five times as many components as the Macintosh the scope for cost reduction is not great. Admittedly, the Macintosh only has one disc drive, but I found this to be little problem in practice and for the general office user doing unambitious tasks the second drive should not be needed.

The IBM PC is very conventional compared to the Macintosh. To get a system running software with the same kind of data integration and ease of use, the real comparison is with either the Lisa or an IBM which is running Visi On. Visi On unfortunately requires a hard disc to run and is expensive. The cost works out at around £6,000 for either an IBM XT with Visi On software or the Lisa with some of its software. Although both these systems have much greater disc capacity, a Macintosh system at £2,000 probably offers just as much of what the typical office users want.

Conclusions

● The Macintosh is intended for the general office user, and packs a powerful but appropriate set of features into a neat,

compact package. At around perhaps £2,000 for a complete system with printer and an application or two, it looks attractive against the competition.

● Employing similar concepts to the Lisa, the high-resolution graphics screen and the mouse are used to great effect by the system. It is genuinely easy to use.

● The single Sony microfloppy provides enough disc-storage capacity for what most people will want to do, but some users may need to add the extra disc drive. A hard disc does not seem to be planned at present by Apple; users requiring one may be steered away from the Macintosh to the Lisa or to an as yet unannounced machine — see news item on page 13 of this issue.

● Users requiring a daisywheel printer may have trouble getting one in the Macintosh's first few months. The Apple dot-matrix printer is fast, does graphics superbly but is only suitable for in-house memos and presentations.

● Macintosh's Apple-written software that we were able to examine is very good. Macpaint appears to be better than the equivalent Lisa package for the typical non-specialist office user. Macword is an up-to-date easy-to-use word processor.

● A good range of languages is planned for the Macintosh. The two we have seen, Basic and Pascal, have impressive features, and as well as being suitable for serious commercial programming will bring the Macintosh to the attention of scientific and educational users.

● Third-party software will be available for the Macintosh, including well established packages such as Multiplan.

● It appears that much third-party software is being rewritten in such a way that data will be transferrable across to Apple-written packages. It should be emphasised that we had no opportunity to test this out, but if it works this is a tremendously useful ability.

● On the evidence of the Macintosh, Apple is still the most exciting computer company around.

BBC Microcomputer System

OFFICIAL BBC COMPUTER DEALER



This is the best microcomputer currently on the market. 32K RAM, 32K ROM, 8 modes of operation, full colour, full-size keyboard, internal expansions such as disc interface, speech synthesizer, Econet interface. In short, it is a personal computer capable of expanding into a small business system.

BBC Microcomputer Model B	£348 + VAT	£399.00
BBC Mod B - disk interface	£409 + VAT	£469.00
BBC Mod B - Econet interface	£389 + VAT	£447.35
BBC Mod B - disk and Econet interfaces	£450 + VAT	£517.50
BBC 100K disk drive	£230 + VAT	£264.00
BBC dual 800K disk drive	£699 + VAT	£803.85
Torch Z80 disk pack including Z80 2nd processor, 64K RAM and CPN operating system + free Perfect Software	£699 + VAT	£803.85
BBC Teletext receiver (Aug)	£196 + VAT	£225.40
BBC Cassette recorder and lead	£26 + VAT	£29.90
Disk interface kit (free fitting)	£86 + VAT	£96.60
Mod A to Mod B upgrade kit	£50 + VAT	£57.50
Fitting charge for A to B upgrade kit	£20 + VAT	£23.00
16K memory upgrade kit	£11 + VAT	£12.65
Games paddles	£89 + VAT	£102.35
12" Monochrome monitor incl. cable	£289 + VAT	£327.85
16" Colour monitor incl. cable	£389 + VAT	£447.35
User guide	£10 + VAT	£10.00
Econet interface (free fitting)	£30 + VAT	£33.00
Speech interface (free fitting)	£30 + VAT	£33.00
BBC disk manual - formatting disk	£30 + VAT	£34.50
Parallelogram printer cable	£10 + VAT	£11.50
BBC word processor (view)	£52 + VAT	£59.80
BBC Fourth language cassette	£15 + VAT	£17.25
BBC Lisp language cassette	£15 + VAT	£17.25

100% BBC COMPATIBLE MITSUBISHI AND TEAC SLIMLINE DISK DRIVES

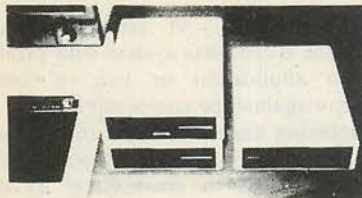

These drives are supplied ready cased with all the necessary cables, formatting program and user disk system guide.

There are some useful utilities included, e.g. Epson Screen Dump Program, Memory Dump, Free Duplicate, Merge and Relocate. Power consumption of these drives is very low (0.2A typ. at 12V, 0.4V typ. at 5V per drive). Power is taken from the BBC computer.

Single drive 100K 40 tracks	£169 + VAT	£194.
Dual drive 200K 40 tracks	£329 + VAT	£378.35
Single drive 400K 80 tracks	£239 + VAT	£274.35
Single drive 400K 40 tracks switchable	£259 + VAT	£297.85
Dual drive 800K 80 tracks	£449 + VAT	£516.35
Dual drive 800K 40 tracks switchable	£469 + VAT	£539.35

COMPLETE WORD PROCESSOR FOR ONLY £1,099 + VAT

This package consists of: BBC Microcomputer, View, wordprocessor, 400K Slimline disc drive, High resolution 12" Green monitor, Juki 6100 18CPS Daisy Wheel printer and all the necessary cables and documentation. The above package can be supplied with components of your own choice, e.g. 800K disc drive or a different printer. Please phone us for a price for your particular requirement.

Special package deal £1,099 + VAT = £1,263.85

PROFESSIONAL MONITORS

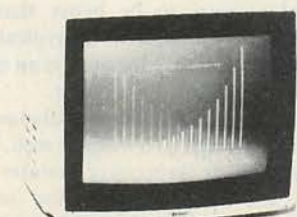

GREEN MONITORS

12" Green screen monitors with composite and sync input. Suitable for most computers.

* 18 MHz band width, high resolution	£89 + VAT	£102.35
* 15 MHz band width, normal resolution	£69 + VAT	£79.35

COLOUR MONITORS

* MICROVITEC RGB input 14" monitor supplied with RGB lead for BBC	£209 + VAT	£240.35
* SANYO SCM 14" Normal res. 14", 400 dots, RGB input supplied with RGB lead	£199 + VAT	£228.85
* SANYO SCM 14M Medium res. 14", 600 dots, RGB input supplied with RGB lead	£299 + VAT	£343.85
* SANYO SCM 14H High res. 14", 800 dots, RGB input supplied with RGB lead	£399 + VAT	£458.85

EPSON FOR RELIABILITY

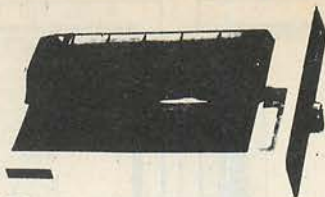

EPSON FX80: 80 column, 160 CPS, normal, italic and elite characters, 256 user-definable characters, superscript, subscript, 11 x 9 matrix, bi-directional logic seeking, hi-res bit image printing (960 x 8 dots line), friction and tractor feed, 9 international character sets, Centronic parallel interface.

FX80 PRICE £349 + VAT = £401.35

EPSON RX80: 80 column, 100 CPS, normal, italic, and elite characters, 11 international character sets, hi-res bit image printing, bi-directional logic seeking, 4 to 10" adjustable pin feed, Centronic parallel interface.

RX80 PRICE £229 + VAT = £263.35

MX-100: 136 column, 100 CPS, friction and tractor feed, up to 15" adjustable carriage, hi-res bit image printing, true descenders, Centronic parallel interface.

MX-100 PRICE £399 + VAT = £458.85

RS232: Interface for all above printers.

EPSON RX80FT (friction & tractor) £259 + VAT = £251.85

FX100 £479 + VAT = £550.85

Roll holder for FX80 £12 + VAT = £13.80

Ribbon for MX80, FX80, RX80 £8 + VAT = £9.70

Ribbon for MX100 £12 + VAT = £13.80

SEIKOSHA DOT MATRIX PRINTERS WITH HIGH-RES GRAPHICS



GP-100A: 80 column, 50 CPS, dot addressable hi-res graphics, 10" wide, fully adjustable, tractor feed, 7 x 5 print matrix, Centronic parallel interface.

GP-100A 50CPS PRICE £175 + VAT = £201.25

GP-250X: 80 column, 50 CPS, 10" wide, fully adjustable, tractor feed, true descenders, 64 user definable characters, double height and/or double width printing, 8 x 5 print matrix, Centronic parallel and RS232 (serial) interfaces both included.

GP-250X PRICE £219 + VAT = £251.85

NEW GP-700A 7 COLOUR PRINTER

This latest addition to Seikosha range gives you print in seven colours, 10" wide carriage, friction and tractor feed, 50 CPS print speed, dot addressable high-res graphics, 4 nammer printing mechanisms, 10 CPI or 13.3 CPI, special Qute printing mode, Centronic parallel interface.

GP-700A SPECIAL INTRODUCTORY PRICE £349 + VAT = £401.35

GUARANTEE LOWEST PRICES

We guarantee that our prices are the lowest on the market. If you can find any item advertised and in stock at less than our price we will match that price.

NEW LOW PRICES ON STAR



The most cost effective quality matrix printers to be launched this year. DP510 and DP515 features include friction and tractor feed and roll holders as standard, 100 CPS print speed, bi-directional logic seeking, 9 x 9 matrix gives true descenders, 2.3K buffer as standard, hi-res bit image plus block graphics, sub and super script, italic printing, auto underlining, vertical and horizontal tabulation, left and right margins set, skip over perforation, back space and self test.

STAR GEMINI 10 10" carriage, 80 columns, 120 cps

SPECIAL PRICE £219 + VAT = £251

STAR DP515 15" carriage 136 columns

SPECIAL PRICE £219 + VAT = £251

RS232 INTERFACE FOR ABOVE £50 + VAT = £57.50

SHARP MZ 700 SERIES COLOUR COMPUTER

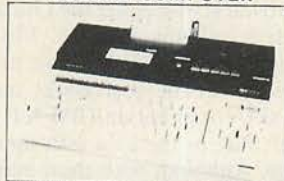

The new Sharp MZ 700 has the flexibility to run programs in BASIC, FORTRAN, MACHINE CODE, PASCAL, ASSEMBLER and many other languages. The 64K memory caters for advanced programming, and the MZ 700 gives you access to a wide choice of software.

£60 worth of software FREE — ten games

SPECIAL PRICE £199 + VAT = £228.85

TEXAS INSTRUMENTS TI 99/4A

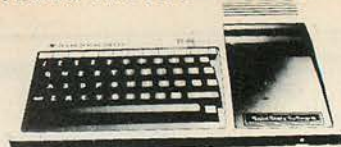

This microcomputer is based on TMS9900 16-bit microprocessor. It includes 16K RAM, 16 colour high resolution graphics (192 x 256). The screen display is 32 characters, 24 lines TI-BASIC. Full-size keyboard. For Software there are about 1000 programs to choose from. There are a lot of peripherals available, e.g. Disk Drives, Disk Interface, Speech Synthesizer, Extra RAM, Additional Language (PASCAL, TI-LOGO, ASSEMBLER).

TI HOME COMPUTER HARDWARE

Title	Description	Price inc VAT
T199-4A	Complete with UHF modulator and power + free cassette lead	£89.95

PERIPHERALS

Speech Synthesizer: When used with selected modules will reduce electronic speech.

Peripheral Expansion System: This unit takes all card peripherals and on internal disk drive.

Disk Drive - Internal: 92K formatted drive, mounts internally in peripheral expansion system.

Disk Controller: Controls up to 3 disk drives, complete with disk manager command module.

Card: 92K formatted capacity per side acts as 2 drives DSK1 & DSK2 total capacity 184K bytes.

Disk Drive Double Sided: Complete with own case, power supply & connecting cables.

Disk Drive External RS232: Provides 2 serial RS232 ports, and one parallel port for interfacing.

Expansion Card RAM: Adds 32K bytes extra RAM bringing total capacity to 48K bytes.

Expansion Card P-Code Card: Includes the UCSD-PASCAL P-code interpreter.

Matrix Printer: 80 column matrix printer pinter GP-100A - cable.

Matrix Printer GP250X: 80 column matrix printer with RS232 and Centronic parallel interface.

Epson RX80 Printer: 80 column, 100 CPS matrix printer.

Please send S.A.E. for software prices

THE AFFORDABLE DAISYWHEEL PRINTER

ONLY £369 + VAT

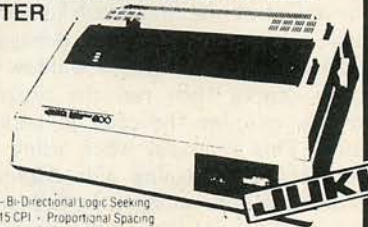

- * 18 CPS - Bi-Directional Logic Seeking
- * 10, 12, 15 CPI - Proportional Spacing
- * "Drop in" Daisywheel - Triumph Adier Compatible
- * Supports all Wordstar features
- * Diablo protocols - IBM Selectric ribbon
- * 2K Buffer as standard - 100 character Daisywheel

SPECIAL OFFER JUKI 6100 DAISYWHEEL £369 + VAT = £424.35

THE CP80 QUALITY PRINTER

ONLY £199 + VAT



- * 80 CPS - Bi-Directional Logic Seeking 80 Column
- * Friction and Adjustable Tractor Feed
- * Patented Square Needles up to 9 x 13 matrix
- * Hi-Res Graphics and Block Graphics

SHINWA CP80 PRINTER £199 + VAT = £228.85

SPARE RIBBON FOR CP80 £5 + VAT = £5.75

BROTHER HR-15 PRINTER

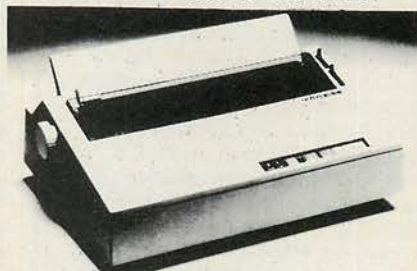

The Brother HR-15 high specification daisywheel printer. BRP is £500.

SPECIAL OFFER 3 FREE daisywheels supplied 4 FREE spare ribbons

ONLY £399 + VAT = £458.85

Akhter Instruments Limited

Dept. E.C.,

28 BURNTMILL, HARLOW, ESSEX CM20 2HU. UK.

TEL: HARLOW (0279) 443521 OR 412639

TELEX 818894

ORDERING INFORMATION

All orders which accompany a cheque, cash or postal orders are CARRIAGE FREE (UK only). Please make cheques and postal orders payable to "AKHTER INSTRUMENTS". A carriage charge of 3% of invoice total is applicable to BARCLAYCARD and ACCESS orders. We accept official orders from Government and Educational establishments. We accept VAT FREE EXPORT orders, please phone or write to check shipping cost.

OPENING HOURS: MON-FRI 9am-5.30pm, SAT 10am-2pm.

We welcome callers, no parking problems.



ATA

The market leaders!...



NEW!
Apple HOME COMPUTER PACK

Apple IIe Computer Disc Drive with Controller, T.V. Modulator, Apple Books, Software Vouchers + FREE Apple Sports Bag

ONLY £759
ring 01 833 0044 for latest PRICES

Attention Dealers!
As a result of demand ATA UK has been established to supply dealers, computer products at attractive prices.
Ring Now (dealers only).
(0727) 37327
(0742) 700802

Export specialists — ring or telex for details

...with recognised professional support



Apple Hardware

Apple IIe	£
Apple IIe 64K	499.00
Disk drive with controller	250.00
Disk drive	199.00
Apple IIe minitor	125.00
Phoenix hi-res green 12" monitor	99.00
Phoenix hi-res amber 12" monitor	105.00

Apple III

Apple III 256K including Monitor III, Disk drive & SOS	1980.00
Additional 5.25" disk drive	270.00
Profile 5mb Winchester	1299.00

Accessories

80 column card	65.00
80 column card 64K extended	145.00
Numeric keypad (I/e)	85.00
Numeric keypad (II+)	75.00
T.V. modulator with sound	12.00
Videx Videoterm 80 column card	195.00
Videx Soft Switch (40/80 column)	20.00
Videx Keyboard Enhancer	87.00
Videx Inverse ROM and character sets	18.00
Microsoft Softcard (Z80 CP/M)	220.00
Microsoft Softcard Apple III (Z80 CP/M)	265.00
Accelerator card (3.6 mHz 6502C & 64K)	289.00
Joystick (I/e)	29.00
System Saver fan & voltage reg.	59.00
Dust cover for Apple II	6.50
Dust cover for Apple II 2 x DD & 12" minitor ..	9.00
Dust cover for Apple III & Monitor III	11.99

Colour Monitors

Luxor high resolution 25Mhz linear & TTL	499.00
Kaga Denshi medium resolution TTL	325.00
Kaga Denshi low resolution	265.00

We also stock the Hantarex RGB monitors, as recommended by Apple in Europe.

PRICES EXCLUSIVE OF VAT AND CURRENT AT TIME OF PRINTING

Interfaces

Apple RS232 Super Serial card	£ 99.00
Apple IFEE 488 card	205.00
Apple parallel interface with cable	99.00
Apple III parallel interface with cable	130.00
CCS 7710-01 RS232 serial interface	109.00
Grappier + parallel graphics interface	105.00
PACT 8 bit A/D converter	115.00
Keyzone 12 bit A/D converter	138.00
PACT 12 channel D/A converter	125.00
RGB card TTL/analog output (programmable)	99.00
RGB card TTL output	85.00

Digitek Accessories & Interfaces

64K RAM	199.00
128K RAM	299.00
PrintMaster parallel printer	75.00
interfaces available for Anadex, Epson, Centronics, Citoh, NEC & TEC	
Super PrintMaster III interface	100.00
available for all printers as above and also for the Apple Dot Matrix printer	
RS232 high speed serial interface	80.00
Z80 with manuals	149.00
Screenmaster 80 inc. soft switch	185.00
inverse video, 3 scroll speeds & altern. chr. sets	
Eurocolour card with modulator (II+)	95.00
UHF Modulator with 'clean signal'	39.00

Robocom Bit Stik C.A.D. Graphics System

Robocom Bit Stik 1.1 system	390.00
Robocom Bit Stik 1000 upgrade software ..	350.00
Robocom Bit Stik 1000 system package ..	545.00
Plotter driver for A4 and A3 plotters	180.00

WE ALSO STOCK APPLE AND HEWLETT PACKARD

Kaypro II

KAYPRO II 2 x 200K disc drives	£ 1395.00
--------------------------------------	-----------

Hyperion

Hyperion 256 x 2 MSDOS, BASIC	£2395.00
-------------------------------------	----------

Apricot

Apricot Computer 256K RAM + 315K s/s 3 1/2" disk	£1399.00
Apricot Computer 256K RAM + 315K s/s 3 1/2" disk + monitor	£1595.00
Apricot Computer 256K RAM + 315K s/s 3 1/2" disks + monitor (inc. basic, utilities, comms, Super Calc)	£1795.00

Printers & Plotters

Epson

Epson RX80 120 CPS	245.00
Epson FX80 160CPS	349.00
Epson RX80FT	265.00
Epson FX100 160CPS	480.00

Apple

Apple Dot Matrix 120 CPS	349.00
Apple Letter Quality Printer	1199.00

Ricoh

Ricoh 1300 Flow Writer	1150.00
Ricoh RP1600 Flow Writer	1499.00
Mannesmann Tally MT160L	449.00
Mannesmann Tally MT180L	649.00
Plus full range of Centronics Printers Available.	

Plotters

Hewlett Packard HP7470	750.00
Hewlett Packard HP7475(A3) TBA	1399.00
Calcomp 8 PEN (A3)	2999.00

TERMS AND CONDITIONS

For delivery please add
£0-£199 + £5, £200-£1499 + £13,
£1500 + 1 1/2%.

CHEQUES WITH ORDERS

Please allow 10 days for clearance.
PLC's, public sector etc 30 days
credit available on official orders,
subject to 5%
credit charge.



ATA — LONDON 4 Albion Hse,
1 Back Hill, London EC1. 01-833 0044
Telex 25102 CHACOM G

ATA — ST ALBANS 70 Park Street,
St Albans. 0727 74361

ATA — SHEFFIELD 72 Eldon Street,
Sheffield, S1 4GT. (0742) 700802
FREEPOST SHEFFIELD S1 1AY

Apple IIe
BUSINESS PACK WITH
DISC DRIVE AND 12" MONITOR
+ 80 COLUMN CARD £899

ATA

● Circle No. 159

apricot

The 4th generation personal computer

A computer that, for the first time, works with you rather than just for you. Hardware and Software co-ordinating perfectly, Apricot arrives complete and ready to work.

The MicroScreen™ on the keyboard, unique to Apricot, performs a variety of practical functions—as a calculator, calendar, time display, and as a window on the screen. Most significantly the MicroScreen™ prompts and assists the user by presenting simple options whilst running applications.

As you'd expect with a 4th generation system, Apricot offers true 16-bit processing, multi-processor architecture and 256k RAM as standard.

With Pulsar 16-bit business software and compatibility with the best selling ACT Sirius 1 and IBM PC, Apricot already has the largest available software library.



Incorporating the very latest advances in computer technology, Apricot uses 3½" pocket-size diskettes. Secure and compact, yet offering increased storage capacity.

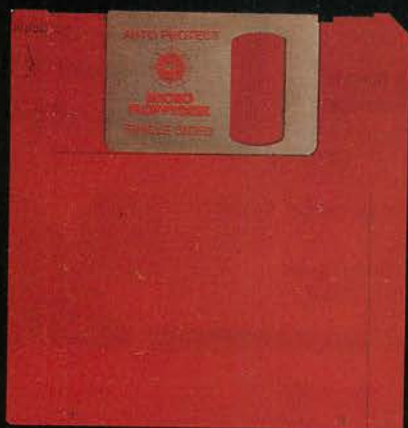

ot



Apricot includes over £750 of software—SuperCalc spreadsheet, business and communications software—to ensure that your system is immediately effective.

And because executives are not office bound, Apricot offers portability, a further feature aimed at improving efficiency.

Powerful sleek and sophisticated—and all at an amazing 4th generation price.

**Go 4th
from £1495**



ACT (UK) Limited
FREEPOST, Birmingham B63 1BR
or call 021-501 2284

Please send me the latest information on Apricot—the 4th generation personal computer.

Name _____
Company _____
Address _____

Post Code _____

● Circle No. 160

OBVIOUSLY DESIGNED to be compatible with the Apple II and II Plus, the Unitron 2200 incorporates many features which Apple should have included in the IIe. However, the differences are almost entirely mechanical and do not affect the Unitron's ability to run applications programs which have been developed for the Apple II.

The Unitron 2200 comes in two boxes: one for the keyboard and encoder, the other for the computer. They are connected by a coiled lead which plugs into a 15-pin D-connector socket in the main housing. The plastic case of the Unitron is thinner than the Apple's and not as robust. In particular, the guides for expansion-card ribbon cables are flimsy and could easily be snapped off.

The main housing is constructed in two parts held together by four mating pegs and sockets. You have to take great care not to break off the pegs when you take the case apart. There is no warning in the instruction manual, and I nearly did irreparable damage before I became aware of the problem.

Inside the case, there are some immediate differences between the Unitron 2200 and the Apple IIe, but they are superficial. The Unitron motherboard measures approximately 400mm. by 250mm., is blue and is made in Taiwan; the Apple PCB is 300mm. by 230mm., is green and is made in Singapore. The extra space accommodates the disc controller and Z-80 second processor circuits.

FCC standard

The Unitron has a switching power supply made in Taiwan and housed in a 250mm. by 89mm. by 57mm. black metal case, mounted on pedestals for free air circulation. The Apple has a switching power supply made in Hong Kong and housed in a 250mm. by 89mm. by 57mm. gold-coloured metal case, mounted directly on the metal base of the cabinet to dissipate heat. The case of the IIe has been constructed partly of metal in order to meet FCC radiation screening specifications; this refinement has not been provided on the Unitron.

The Unitron 2200 has only four expansion slots, compared to seven on the Apple IIe and eight on the II Plus. The connectors are labelled Slots 1, 3, 5 and 7. Slot 0 is omitted for the same reason that Slot 0 disappeared from the Apple IIe: 64K RAM chips are used for read/write memory so there is no longer any need to make provision for the language card. Slots 4 and 6 will not be missed since they are the conventional homes for a Z-80 second processor card and the disc controller respectively. These features are an optional extra with the Apple but form an integral part of the Unitron motherboard.

The absence of Slot 2 could prove more serious because this is the place for a communications card. No computer with aspirations to business use can now exist without provision for comms, and to

UNITRON 2200

Roger Cullis was hard put to find any practical differences between the Apple IIe and its Taiwanese rival, except the built-in Z-80 card and disc controller — and the £389 price tag.

rectify the omission is not simply a matter of plugging a card into one of the vacant slots. A software patch will also be required to make the system function correctly.

There is provision for connecting a cassette recorder, though this is a feature which is unlikely to be used: discs are much faster and more reliable. More useful is the

games connector, which can be used to connect a bit pad or house a dongle for software protection. The socket is sensibly mounted at the rear of the case so that connections can be made from the outside without having to remove the lid.

The circuit board is of good quality, with all of the ICs in sockets for ease of

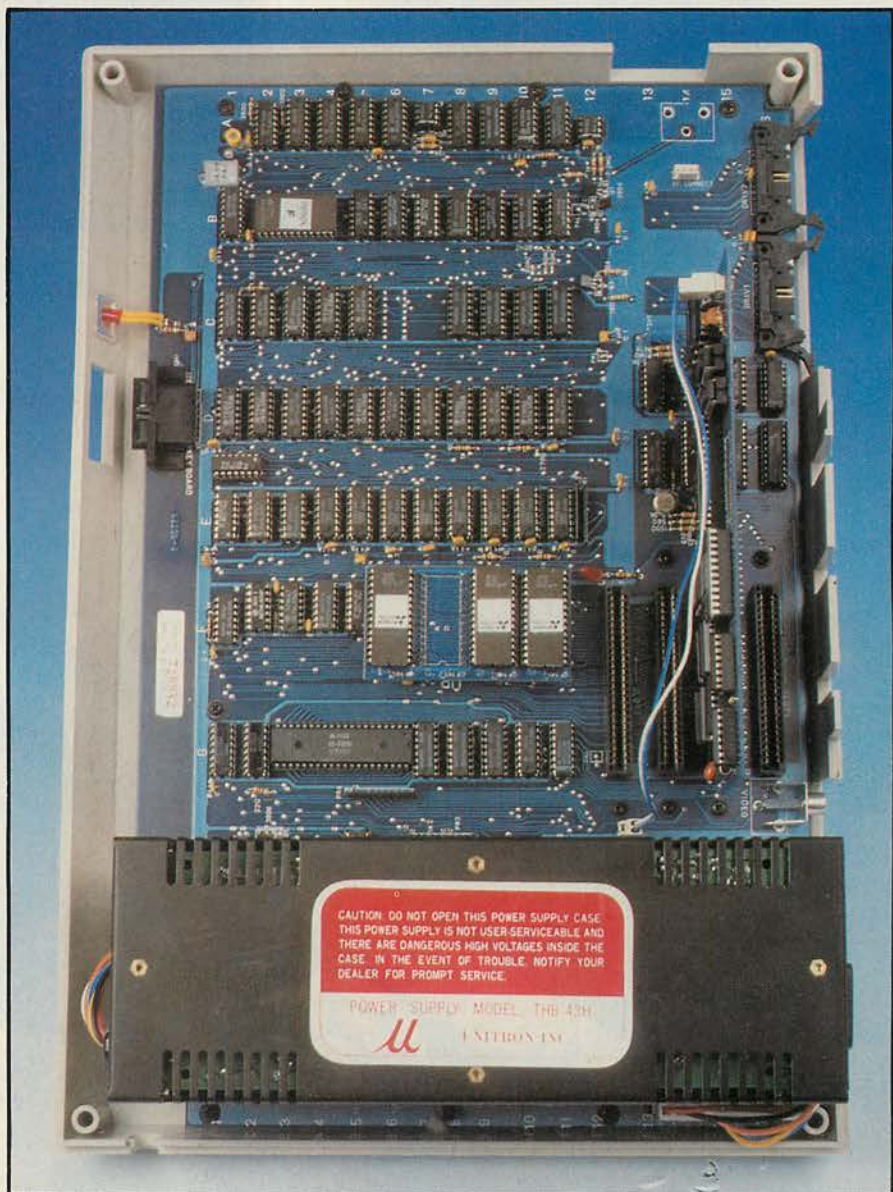

servicing. There is plenty of room for air circulation, so there should be no overheating difficulties even when the expansion sockets are fully populated. There are, however, several holes which are larger than the British Standard finger, so users with small children beware!

At the rear of the PCB there are two shrouded, polarised headers which accept the insulation displacement connector sockets for a standard Apple disc drive. I plugged in the Cumana drives I use with my Apple IIe. They worked first time and without any tweaking, which is not really surprising since the Unitron's disc interface is virtually identical to the Apple's.

The separate keyboard with an additional numeric keypad is a welcome departure from Apple practice. The feel of the keys is not as firm as those of the IIe, but proved quite acceptable. Layout of the keyboard follows that of the Apple II Plus. Normal display is 40-column, but with upper and lower case controlled by a Shift Lock toggle key.

The numeric keypad has four function keys: Home, ?, Delete and Return. There is

no provision for an alternative character set but the motherboard has a connector for an 80-column card and one was supplied with the test machine. This card followed the soft-switching protocols used by the Videx and Vision 80 cards rather than those of the latest Apple cards. It was enabled automatically on booting a Microsoft CP/M disc.

Graphics

Hires and Lores graphics provide 280-by-192 and 48-by-40 pixel monochrome displays. The PCB had two jumper points marked "Pal", but I was unable to investigate whether it was possible to obtain a colour display since no UHF modulator is built in and I did not have a spare one to hand.

An autoboot EPROM is included so that languages can be loaded into the upper 16K of RAM in the manner of the Apple language card. As an alternative, the EPROM can be replaced with a small PCB which plugs into the D/L socket. This auxiliary card carries three 8K EPROM

chips to provide floating-point Basic and integer Basic in firmware.

Integer Basic seems a curious choice, since it is no longer supported by Apple. It would have been more useful to use the 12K it occupies for the altered version of DOS 3.3 that many people load into the Apple language card, plus a few utility routines. A further anomaly is that switching between the two languages is achieved by a Call -1101 instead of the usual FP and Int commands. It would have required only a minimal alteration to the Basic code to make these commands operable. Both the Autostart and old monitor are available with their respective languages. The firmware old monitor is distinguished by a % prompt, although when it is loaded from disc into RAM it has the usual *.

To check the similarity of the two Unitron Basics to Applesoft and Integer Basic, I ran the Master Diagnostics test disc. Applesoft matched exactly, but Integer differed in the F0 ROM routines. This near identity was confirmed by a

(continued on next page)

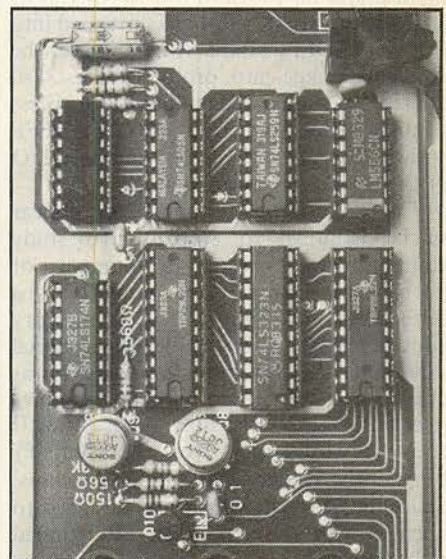

The disc-controller on the Unitron's board (above) and the Apple card (below)

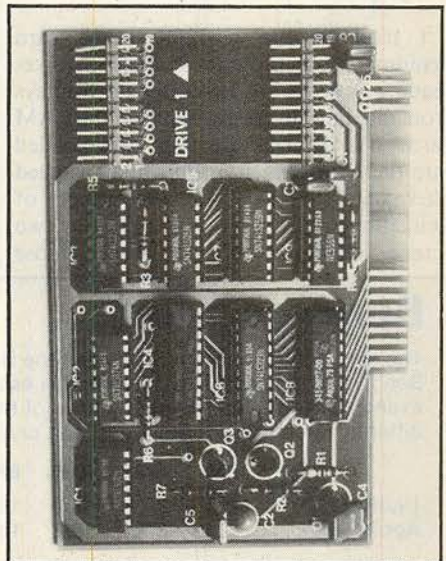

(continued from previous page)

Monitor Verify command, comparing Unitron floating-point Basic and Applesoft loaded from the DOS 3.3 master disc.

The memory map of the Unitron follows established Apple practice. Pages 0 and 1 are used by the 6502 CPU for workspace and stack. Page 3 carries DOS vectors and has a small area available for user machine-language routines. Pages 4 to 7 and 8 to B are Text/Lores screen buffers while the Hires screens occupy pages 20 to 3F and 40 to 7F.

Memory map

User program space runs from \$C00 to \$1FFF and \$8000 to \$BFFF. \$C000 to \$CFFF is memory-mapped I/O, soft switches and peripheral ROM and workspace. Soft switches are as listed in the Apple reference manual with the addition of Call -1101, which toggles between floating-point and integer Basic ROMs.

Three banks of memory are mapped into \$D000 to \$FFFF. Two are ROM based and carry the two Basics and the corresponding monitors, while the third consists of 16K of RAM with two 4K sub-banks mapped into \$D000 to \$DFFF. Bank switching uses the Apple language-card protocol. The Z-80 address lines are gated so that it can access contiguous memory from \$0000 to \$DFFF without conflict with memory-mapped I/O or the 6502's zero page or stack.

The expansion card connections appear to be identical to Apple's. To study compatibility I tested a number of peripherals which are sensitive to differences in timing signals or memory addressing. With an Apple Super Serial card and ASCII Express software I was able to transfer files to another computer over an RS-232 serial link. A Snapshot II copy card did not work, presumably because the Unitron has 64K RAM chips; Snapshot Copykit, which was designed to operate with the Apple IIe, functioned satisfactorily.

Apple software

I tried to run a 128K RAM card demonstration program which involves loading a series of Hires screen displays from disc into successive banks of the RAM card. The displays are then downloaded into the Hires screen buffers and switched alternately to give an appearance of animation. With this program, the two screen displays did not superimpose

accurately, so the overall appearance was fuzzy. However, an arcade game and three-dimensional Supergraphics functioned correctly. They use a similar animation technique but work solely in motherboard memory, which suggests that there may be

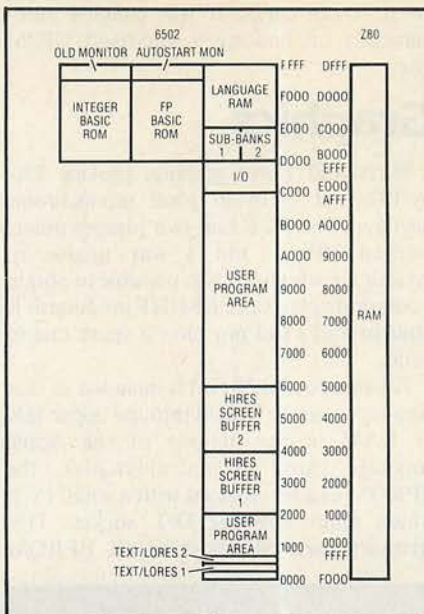

Z-80 address lines are gated to access memory from \$0000 to \$DFFF.

Specification

- CPU:** 6502 main processor with Z-80 second processor
- Memory:** 64K RAM, 24K ROM
- Languages:** Apple-compatible integer Basic and floating-point Basic in ROM
- Operating system:** CP/M, Apple DOS 3.3, Apple-compatible old monitor and Autostart monitor in ROM
- Bus:** Apple II compatible
- Dimensions:** 16.5in. wide by 11.5in. deep by 4.5in. high, ignoring keyboard
- Keyboard:** detached; Apple II Plus layout with separate numeric keypad and four function keys
- Display:** socket for video monitor; provision to connect UHF modulator; text display 40 columns by 25 lines, or 80 columns by 25 lines with plug-in card; Hires graphics 280 by 191 monochrome; Lores graphics 40 by 48 monochrome
- Standard interfaces:** Apple DOS 3.3-compatible disc interface
- U.K. Price:** £389
- U.K. Supplier:** Chiltern Electronics, High Street, Chalfont St. Giles, Buckinghamshire HP8 4QH. Telephone: (02407) 71234.

Benchmarks

The similarity of operation between the Unitron and the Apple IIe is shown by the Benchmark timings. The difference in each case is no greater than might be expected between different samples of the same computer, and can be attributed to differences in the controlling quartz crystal.

	BM1	BM2	BM3	BM4	BM5	BM6	BM7	BM8	Av.
Unitron 2200	12.7	8.7	16.2	18.0	19.8	29.1	45.4	104.6	31.8
Apple IIe	12.7	8.7	16.2	18.0	19.8	29.3	45.7	105.3	32.0

a problem in the downloading from the RAM card.

The Unitron 2200 comes with a scanty 32-page manual containing the barest minimum of information required to get the system going. You are clearly expected to have a knowledge of Apple procedures; indeed, the most helpful part of the manual is the appendix which lists the Apple and Microsoft manuals containing the instructions necessary to operate the computer satisfactorily.

Crude changes

The text of the manual appears to have been produced with a dot-matrix printer, but many of the figures and tables are typeset and bear a remarkable resemblance to figures and tables from the Apple II reference manual, Apple product number A2L0001a. Some of the diagrams have been crudely amended in places — generally where there are differences between the Unitron and the Apple II.

With CP/M, the user is instructed to switch on, insert a CP/M disc and press a key to boot the system. No guidance is given on how to get Apple DOS up and running but, since the first boot routines on an Apple CP/M disc are identical with those on an Apple DOS 3.3 disc, the obvious thing is to try a similar procedure. Not surprisingly, it works.

A similar technique can be employed with VisiCalc, Pascal and other software which has its own variant of the operating system. I tried out several, including Merlin Assembler, Universal Boot Initializer, Fastdos and Nibbles Away II — all without any problems. They appeared to function in the usual manner. Software which can make use of additional memory boots normally and enables the additional RAM automatically; VisiCalc showed the expected 34K free.

Conclusions

- In terms of performance, there is little to choose between the Unitron 2200 and the Apple IIe, and only a minute proportion of Apple software is likely to fail to run on the Unitron.

- The Unitron is considerably cheaper, at £389, compared with around £933 at current discount prices for an Apple IIe with disc interface, numeric keypad, 80-column card and Z-80 second-processor card.

- As the model is newly introduced there are no indications of its long-term reliability. However, the standard of construction is high and the board should prove easy to service since the integrated circuits are socketed. Standard Apple diagnostic software can be used for testing and fault finding.

- The novice user would not be able to obtain sufficient information from the data provided with the Unitron and would need to purchase a set of Apple manuals to find out how to operate the computer.

A SELECTION FROM OUR PRODUCT RANGE

FORMATS
A1 - 8" SINGLE SIDED
SINGLE DENSITY

High Level Languages

	CP/M	CP/M-86	MS-DOS	PC-DOS
ASIC INTERPRETER	Supersoft	•	•	•
ASIC COMPILER	Microsoft	•	•	•
ASIC COMPILER V5.3	Supersoft	•	•	•
BUSINESS BASIC COMPUTER COMPILER	Microsoft	•	•	•
COMPILER	Supersoft	•	•	•
ASIC	Digital Research	•	•	•
ASIC COMPILER	Digital Research	•	•	•
COBOL	Micro Focus	•	•	•
COL COMPILER	Microsoft	•	•	•
AL-66	Micro Focus	•	•	•
ITH	Supersoft	•	•	•
TRAN	Supersoft	•	•	•
TRAN COMPILER	Microsoft	•	•	•
EL-2 COBOL	Micro Focus	•	•	•
P	Supersoft	•	•	•
LISP	Microsoft	•	•	•
MATH/muSIMP	Microsoft	•	•	•
SCAL COMPILER	Microsoft	•	•	•
SCAL MT+	Digital Research	•	•	•
I	Digital Research	•	•	•

Telecommunications (Cont.)

	CP/M	CP/M-86	MS-DOS	PC-DOS
ICL C03 EMULATION (Bulk)	•	•	•	•
ICL C03 EMULATION (Interactive)	•	•	•	•
ICL C03 EMULATION (Interactive & Bulk)	•	•	•	•
REFORMATTER CP/M ↔ DEC	•	•	•	•
REFORMATTER CP/M ↔ IBM	•	•	•	•
Synchro Systems	•	•	•	•
Synchro Systems	•	•	•	•
Synchro Systems	•	•	•	•
Microtech Exports	•	•	•	•
Microtech Exports	•	•	•	•

Word Processing/Text Editing/Editors

	CP/M	CP/M-86	MS-DOS	PC-DOS
CORRECTOR	Supersoft	•	•	•
EDIT-80 V2.02	Microsoft	•	•	•
LEXICON (WORD ANALYSIS)	Microtek	•	•	•
MAILMERGE	Micropro	•	•	•
MEMOPLAN	Chang Labs	•	•	•
WORD	Microsoft	•	•	•
WORD WITH MOUSE	Microsoft	•	•	•
PARAGRAB	Focus	•	•	•
PEDIT	Phoenix Software Associates	•	•	•
PMATE	Phoenix Software Associates	•	•	•
SPELLSTAR	Micropro	•	•	•
STARBURST	Micropro	•	•	•
STARINDEX	Micropro International	•	•	•
WORDMASTER	Micropro	•	•	•
WORDSTAR	Micropro	•	•	•
WORDSTAR PROFESSIONAL (WS-MM+SS+STAR INDEX)	Micropro	•	•	•

Low Level Languages

	CP/M	CP/M-86	MS-DOS	PC-DOS
CRO-80	Microsoft	•	•	•
GRAMMERS UTILS (IRASM)	Digital Research	•	•	•

Program Development Tools

	CP/M	CP/M-86	MS-DOS	PC-DOS
AMATOR	Micro Focus	•	•	•
PLAY MANAGER	Phoenix Software Associates	•	•	•
UMB	Digital Research	•	•	•
EL II ANIMATOR	Micrology	•	•	•
VELOP	Micro Focus	•	•	•
ANK	Phoenix Software Associates	•	•	•
ANK II	Phoenix Software Associates	•	•	•
ANK-86	Phoenix Software Associates	•	•	•
ED PROGRAMMING PACKAGE	Digital Research	•	•	•
86	Digital Research	•	•	•
86	Digital Research	•	•	•

Databases/Data Management Systems

	CP/M	CP/M-86	MS-DOS	PC-DOS
CONVERT	Southdata	•	•	•
DATASAR	Micropro	•	•	•
DBASE-II	Ashton Tate	•	•	•
INFOSTAR	Micropro	•	•	•
MAILING LIST	Southdata	•	•	•
REPORTSTAR	Micropro International	•	•	•
SUPERFILE (SINGLE-USER)	Southdata	•	•	•
SUPERFILE (MULTI-USER)	Southdata	•	•	•

Financial Accounting

	CP/M	CP/M-86	MS-DOS	PC-DOS
INCOMPLETE RECORDS SYSTEM	MPI	•	•	•
NOMINAL LEDGER	Padmede Computer Services	•	•	•
OPEN ITEM PURCHASE LEDGER	Padmede Computer Services	•	•	•
OPEN ITEM SALES LEDGER	Padmede Computer Services	•	•	•
PADMEDE BUSINESS CONTROL SYSTEM	Padmede Computer Services	•	•	•
PAYROLL	MPI	•	•	•
PURCHASE LEDGER	Padmede Computer Services	•	•	•
SALES INVOICING	Padmede Computer Services	•	•	•
SALES LEDGER	Padmede Computer Services	•	•	•
TIME & COST RECORDING	Padmede Computer Services	•	•	•

Financial Modelling/Problem Solving

	CP/M	CP/M-86	MS-DOS	PC-DOS
CALCSTAR	Micropro	•	•	•
DECISION ANALYST	Executive Software	•	•	•
LINEAR & GOAL PROGRAMMING	Electronic Accounting Services	•	•	•
MATHSPACK	MPI	•	•	•
MICROPLAN	Chang Labs	•	•	•
MULTIPLAN	Microsoft	•	•	•
PLANTRAC 1	Computerline	•	•	•
PLANTRAC 1 - PROFIT PLAN	Computerline	•	•	•
QSTAT	Chang Labs	•	•	•
STATSPACK	Pivotal Software	•	•	•
TKI SOLVER	MPI	•	•	•
TKI SOLVER PACKS	Software Arts	•	•	•
FINANCIAL MANAGEMENT		•	•	•
MECH ENGINEERING		•	•	•

Business Applications

	CP/M	CP/M-86	MS-DOS	PC-DOS
JOB COSTING	Heseltine	•	•	•
POLICY MASTER	CSA Micro Systems	•	•	•
PRINT ESTIMATION	Software Mgmt Systems	•	•	•
STOCK CONTROL	Padmede Computer Services	•	•	•

Training Aids

	CP/M	CP/M-86	MS-DOS	PC-DOS
CP/M TUTOR	Syntax Software	•	•	•
KEYBOARD MASTER	Anthony Ashpittel	•	•	•
TYPING MASTER	Anthony Ashpittel	•	•	•

Graphics

	CP/M	CP/M-86	MS-DOS	PC-DOS
dGRAPH	Fox & Geller	•	•	•
STATSGRAPH	Supersoft	•	•	•

Utilities/System Tools

	CP/M	CP/M-86	MS-DOS	PC-DOS
P	Keele Codes	•	•	•
SPPOOL	Digital Research	•	•	•
GNOSTICS II	Supersoft	•	•	•
K DOCTOR	Supersoft	•	•	•
KED-2	Slogger Software	•	•	•
K-EDIT	Supersoft	•	•	•
KMAN	Slogger Software	•	•	•
KORG	Slogger Software	•	•	•
KTOOLS-1 (DISKMAN & DISKORG)	Slogger Software	•	•	•
KTOOLS-2 (DISKTOOLS-1 & DISKED-2)	Slogger Software	•	•	•
LIL (FOR DBASE-II)	Fox & Geller	•	•	•
ESHARE	Micro Focus	•	•	•
Rainbow (1) Format/Verify SVC	Silicon Valley Corp.	•	•	•
Rainbow (2) Autorun Service	Silicon Valley Corp.	•	•	•
Rainbow (3) Function Key Service	Silicon Valley Corp.	•	•	•
Rainbow SVC S/W Vol 1 (1+2+3)	Silicon Valley Corp.	•	•	•
TEM CHECKER	Supersoft	•	•	•
OPERATING GUIDE	Decision Systems	•	•	•
ILITIES I	Supersoft	•	•	•
ILITIES II	Supersoft	•	•	•

Porting

	CP/M	CP/M-86	MS-DOS	PC-DOS
PORT	Microsoft	•	•	•
PERSORT	Micropro	•	•	•

Code Generators

	CP/M	CP/M-86	MS-DOS	PC-DOS
OCODE	Stemmos	•	•	•
MS-2	Micro Focus	•	•	•
CKCODE	Fox & Geller	•	•	•
LAST ONE	D.J. 'A1' Systems	•	•	•
LAST ONE—COMPACT	D.J. 'A1' Systems	•	•	•

Telecommunications/Conversions

	CP/M	CP/M-86	MS-DOS	PC-DOS
DEBIT	Comley Computer Services	•	•	•
SCOPY	Comley Computer Services	•	•	•
AM	Byrom Software	•	•	•
MS	Byrom Software	•	•	•

Free Catalogue Available

*Retailer and OEM Terms Available

ORDER INFORMATION

When ordering software please specify the format you require. All software items are subject to VAT. Manuals, when purchased separately, are not subject to VAT. Please add £3.75 (plus VAT) for postage and packing for the first item purchased, and then £2.00 for each extra item. For overseas please add £6.50 for the first item and then £2.15 for each extra item required. Most software in this advertisement is available from stock. These details are current as of January 1984 (Telephone at time of purchase to confirm latest prices.) All payments must be in Sterling and drawn against a U.K. bank. Prices may change without notice due to fluctuations in the dollar exchange rate. Please confirm price at time of ordering.



MICROCOMPUTER PRODUCTS INTERNATIONAL LIMITED

THE HOME OF MICROCOMPUTER SOFTWARE

Room PL2,
Central House,
Cambridge Road,
Barking,
Essex IG11 8NT.

Tel: 01-591 6511
Telex: 892395

RML 480Z

Ian Stobie assesses Research Machines' 480Z and discovers it to be a bargain buy for the school desk top.

YOU ARE UNLIKELY to come across Research Machines' Link 480Z outside a school or college, although there is no reason why this eight-bit CP/M machine could not be used in an office or factory. However, from the earliest days of the microcomputer Research Machines Limited has specialised in selling into the educational sector, and this experience is reflected in the design of the 480Z and in the considerable body of software available for it.

The complete system under review here would cost the typical education user about £2,100, which includes dual floppy-disc drives, a Microvitec 14in. high-resolution colour monitor and an Epson RX-80 dot-matrix printer. The RML components of the system comprise the main unit, which in

our case is the more expensive model L4 with colour graphics capacity, and the twin floppy-disc drive unit. The lowest priced 480Z system would cost £483 for the monochrome model L2 main unit. Both models come equipped with cassette and TV interfaces. RML operates a dual-pricing policy. Educational users pay about 20 percent below list prices on average size orders and it is these discount prices which are quoted here.

The 480Z was introduced at the end of 1981, intended primarily as a station on the company's Chain local area network. But the cassette-based 480Z configuration rapidly evolved into a stand-alone CP/M system with the expansion of memory to 64K and the addition of discs. Recently the 480Z has been through a restyling exercise, with a new layout of the main circuit board reducing the component count and a plastic, structural-foam case replacing the original metal one.

The cream-coloured foam casing of the main unit appears to be very strong, and there are no gaps to allow access for probing small fingers. It is larger than a BBC Micro, and takes up a space 21in.

wide by 13in. deep. Moreover, the main unit is the wrong shape for you to place the Microvitec monitor on top of it, so both units take up their full measure of space on the desk top. The separate disc-drive box is also very bulky, so the system really requires a table of its own.

The 480Z keyboard has the normal QWERTY typewriter layout. The cursor keys are sensibly laid out to form a diamond pattern in a separate block together with four programmable function keys. All the keys are well constructed and have a good feel and generate upper- and lower-case characters, so the system is suitable for word processing.

Inside the main unit is the Z-80A processor and a standard 64K of RAM, expandable to 256K. On opening up the casing the impression is of a well put together system. Unusually for this size of machine, there is a cooling fan, which should enhance reliability.

The two floppy-disc drives are in a box weighing 15lb. Each drive provides a formatted capacity of 328K, recording on both sides of a standard 5.25in. disc. A single drive unit is available for about £500.

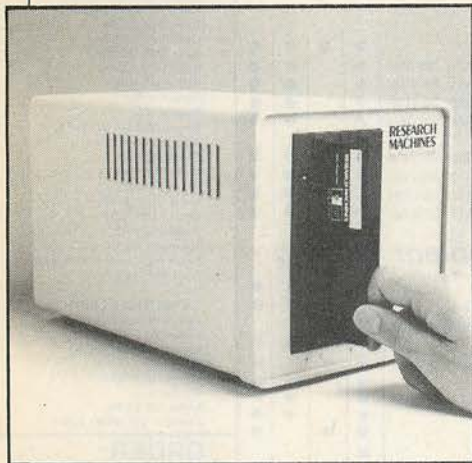

Software is available on cassette and disc, as well as on small ROM cartridges which stick precariously out of the back of the machine.

Connecting up the system is simple, although the discs, monitor, main unit and printer have mains leads of their own, adding to the untidy impression given by the system. This is unlikely to be regarded as an important point by schools, but a rethink would be necessary if RML ever wanted to sell a version of the machine into the office market.

When you turn the machine on and insert a disc in the left-hand drive the system does not immediately boot up CP/M. Instead a large-character 40-column wide display comes up on the screen, inviting you to hit R to enter the RML Basic contained in ROM, or hit H for Help. This display is put out by the monitor program called ROS 1.2 also contained in the 28K of software in ROM, which functions as the cassette operating system.

Normally you would type in B to boot up CP/M from disc. The system then loads CP/M 2.2 in the normal way, with the screen automatically resetting to 80

columns wide. The disc drives themselves are quiet except when accessing, when they clatter loudly. The fan in the 480Z main unit runs too quietly to be noticed.

Our system came fitted with the full 256K of RAM so we could try out a silicon disc feature which RML plans to offer soon as an option. At the time of writing price details are not available. What you will get when the system is released, apart from the additional 192K of RAM, is a disc with a modified version of CP/M 2.2 on it. You switch on and boot up from the ROS display in the normal way, then run a utility called Mdisc to format the extra RAM area so that it emulates a disc; 174K of the RAM is available for use. You then copy the files you want to use across from a floppy to the disc emulated in RAM. The RAM disc is known as M: to CP/M so you can use Pip. For instance

```
PIP M: = B:*.*
```

copies the files across from drive B.

The aim of the exercise is to speed up

programs which will access the disc frequently. Running WordStar off M: accelerated things appreciably with negligible disc delay when pulling up menus or printing from the last few pages of a document. If you reset while running off M: the contents are still there, but if you switch off the 480Z you lose the contents of the RAM. So it is important with any silicon-disc system to remember to copy your files back to a real floppy disc at the end of a session.

ROM packs

ROM packs are another recent development for the 480Z. They plug into the parallel port at the back of the machine and are available in 16K or 64K versions. As yet there is not much software available using the system but RML says there will be, with several educational software suppliers preparing programs. The packs contain common types of EPROM so costs will probably be low enough for small-volume software producers like local education authorities to release programs on ROM.

We were supplied with a ROM pack which had some Basic demo programs on it. You plug in the ROM pack, and press Reset. The RML system appears to copy the ROM contents into RAM before the program is run. This takes a few seconds, but compared to using a cassette it is convenient. Most ROM packs on other machines switch out part of the existing memory and are then directly addressed by the processor. The only weakness to the RML system is the ROM pack design, which looks vulnerable. It sticks out the back of the machine, held only by the pins of the parallel-port connector. The likely price of ROM packs from volume producers is about £88.

The 480Z was originally developed as the disc-less work station for the Chain network. Up to 16 disc-less 480Zs can be attached to the network via a central network controller based around a modified version of RML's larger 380Z computer. The 380Z has extra boards added and its screen and keyboard removed to fulfil its role as network controller. A floppy or Winchester hard-disc unit and printer are typically attached to it. A single coaxial cable runs between all the 480Zs and the network controller so the wiring is not messy.

All the 480Zs can then use the discs and printer, with the network controller sorting out any clashes and, for example, temporarily storing output destined for the printer until the device is free. An individual 480Z user can link into the network by switching on their machine and choosing the N option from the initial Help display put up by ROS.

Regrettably, I did not have a Chain network to play with but the obvious advantage is cost. A typical educational price for a twin-drive network server is £1,734, with a printer at £333, so for just

(continued on next page)

Benchmarks

The table shows the time in seconds to run eight standard Basic routines. The Benchmark routines test out various typical tasks, each repeating an appropriate set of Basic statements 1,000 times. The Basic interpreter used was RML Extended Basic in ROM version 5.48, as supplied with the 480Z.

Machine and CPU	1	2	3	4	5	6	7	8	Av.
BBC Model B—6502	1.0	3.1	8.3	8.7	9.2	13.9	21.9	52.0	14.8
IBM PC—8088	1.2	4.8	11.7	12.2	13.4	23.3	37.4	30.0	16.8
RML 480Z—Z-80A	1.1	6.9	13.5	13.0	15.0	23.2	33.1	50.7	19.6
Spectrum—Z-80A	4.8	8.7	21.1	20.4	24.0	55.3	80.7	253.0	58.5
Apple IIe—6502	12.7	8.7	16.2	18.0	19.8	29.3	45.7	105.3	32.0

Specification

CPU: Z-80A running at 4MHz
RAM: 64K, expandable to 256K
ROM: 28K, containing 20K Basic and monitor

Display: sockets for external black and white TV and monitor outputs are standard on model L2 with colour option available on model L4; shows 24 lines by 40 columns or 24 lines by 80 columns and 160-by-72 dot medium-resolution graphics in two grey tones; model L4 adds TTL RGB colour output and three graphics modes including 640-by-192 dot monochrome and 160 by 96 dots in eight colours

Keyboard: QWERTY-layout keyboard forms part of main unit, with separate cursor and control-key block, generating upper- and lower-case characters; 65 keys in total

Interfaces: one eight-bit parallel port; two RS-232 serial ports, one low-speed suitable for printer, the other high-speed for communications or disc; cassette interface, one joystick port; network interface comes as standard, allowing the 480Z to become a station on RML's Chain LAN

Dimensions: main unit's footprint on desk is 21in. by 13in.

Discs: twin 5.25in. floppy drives in separate unit, double sided, each drive with formatted capacity of 328K; disc

unit weighs 15lb.; single-drive option also available; on 480Z systems fitted with 256K of RAM most of it can be configured as a silicon disc

U.K. price: RML quotes a typical education price about 19 percent lower than the list price which allows for 10 percent educational discount and 25-plus volume order; typical education price for the complete system reviewed here comes to just over £2,100, with 480Z model L4 with high-resolution graphics at £585, twin 5.25in. floppy drive at £748, 14in. Microvitec high-resolution colour monitor at £450, and Epson RX-80 printer at £333; typical education price of monochrome 480Z model L2 is £483, single 5.25in. floppy drive, £499; model L2 can be upgraded to model L4

Software: RML has its own operating systems and versions of Basic but CP/M 2.2 comes with disc system; a wide variety of software is available on cassette and disc, with some programs available on 16K or 64K ROM packs which plug into the parallel port; RML is offering low-price disc software bundles

Manufacturer: Research Machines Ltd, made in U.K.

U.K. distributor: Research Machines Ltd, PO Box 75, Mill Street, Botley Road, Oxford OX2 0BW. Telephone: (0865) 249866

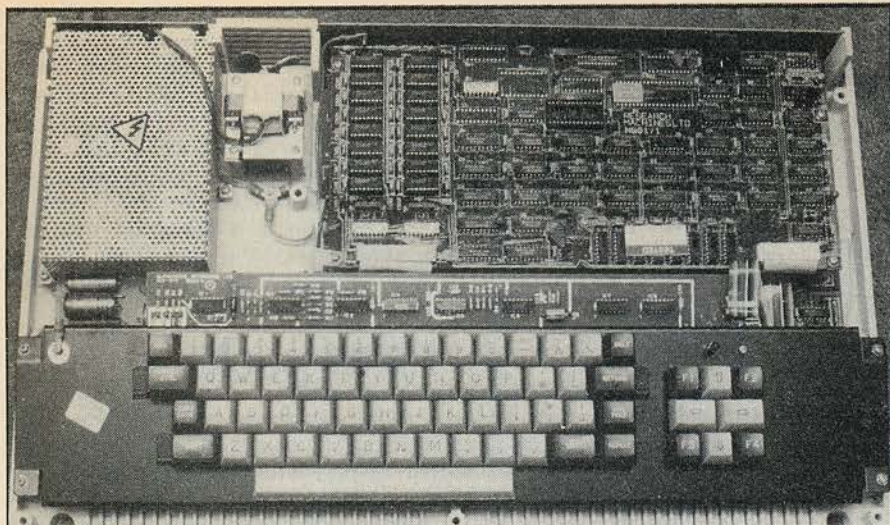

The well designed circuit board is cooled by a small, quiet fan.

(continued from previous page)

over £2,000 you can add disc and printer facilities to up to 16 480Zs.

RML is also experimenting with a more limited but cheaper system which works along similar lines. The shared-disc system is scheduled for release in early 1984 and will allow up to four 480Zs to share a disc drive.

Ever evolving

The 480Z is a continuously evolving system. This is praiseworthy, but does have some drawbacks. For example, RML is for ever releasing new versions of its Basic and upgrades to operating system ROMs, and although the software packages generally come with a piece of paper in the manual telling you what set-up they will run on, at first all the version numbers can look very confusing.

Documentation takes the form of a mass of separate manuals on Basic, the cassette system, the disc system and on any other products you have opted for, like Logo or WordStar. All the information is there, but dedication and a serious turn of mind are assumed. This uncontrolled approach can be contrasted to that now adopted by Apple: you can obtain various reference manuals if you want them but the standard documentation set is carefully restricted to easy-to-understand manuals which are often accompanied by tutorial material on disc.

As a CP/M machine the 480Z can run general business software packages like WordStar and Multiplan. RML is offering mixed bundles of educational and general business packages to schools and colleges at very low prices. The packages are well chosen and enhance the attractions of the 480Z to qualifying purchasers. Logo, Touch'N'Go, Word and Quest cost £39, Pascal, Assembler, Telesoftware, Sir and Text Editor cost £95; these prices apply to any RML user. Schools using the 480Z attached to a Chain network will receive these together with Basic and WordStar for nothing. For £395 educational users of

Chain can have the same package plus Cobol, Fortran and Multiplan.

RML does not face any direct competition. Although the BBC Micro, the Apple II, the Commodore Pet and the Sinclair Spectrum are popular in schools and colleges, they all plug into different software bases.

The Apple comes nearest to the RML machines as it can be enhanced cheaply to run CP/M programs. Apple and Commodore are American companies so American-written educational software is available to supplement that which is produced locally — which may be an advantage. Probably the only machine which rivals the strength of RML in offering software tied closely to U.K. curricula is Acorn's BBC Micro. However, the best recommendation to any potential purchaser is to look at the software first and let the availability of what you want determine your choice of machine.

Conclusions

● Beautifully built, the 480Z cannot be faulted for the quality of construction of the hardware.

● Although very robust, the system takes up an unnecessarily large amount of space.

● The 480Z is conservative in specification terms — after all it is an eight-bit CP/M machine like countless others built over the last nine years. This is not necessarily a bad thing for educational users, since educational software, especially packages properly integrated with other course material, takes a long time to develop so it is not likely to be available for the latest machines or operating systems.

● The 480Z is amply provided with educational software. The eight-bit CP/M used on the 480Z also offers the advantage of a vast range of business software at a low price.

● RML's special software deals for schools and colleges are good value. The packages are well chosen and show the company's attention to understanding the needs of educational users. □

RML

Questions

- Which of these is **not** a programming language?
A. Dibal B. Snobol
C. Cobol D. Lisp
E. Gargol
- Which of these is not a **high-level** programming language?
A. Pascal B. Basic
C. Assembler D. Fortran
E. Cobol
- When did high-level programming languages first come into use?
A. 1940s B. 1950s
C. 1960s D. 1970s
E. 1980s
- Which of these languages was the first to be implemented?
A. Pascal B. Fortran
C. Basic D. Cobol
E. Logo
- Which of these languages was first developed by Professors Kemeny and Kurtz?
A. Pascal B. Modula-2
C. BCPL D. Basic
E. Smalltalk
- Which of these languages was originally developed to control radio-telescopes?
A. Logo B. Forth
C. Fortran D. Lisp
E. Occam
- Which of these languages was designed for children to use, and embodied for the first time the idea of turtle graphics?
A. Logo B. Lisp
C. C D. Forth
E. Pilot
- Which of these languages was designed with the intention of inculcating good structured programming habits among students?
A. Basic B. Fortran
C. Assembler D. C
E. Pascal
- Which of these languages was developed in Britain?
A. Ada B. Pascal
C. BCPL D. Fortran
E. C
- Which of the following figures is closest to the percentage of British secondary schools that use Research Machines 380Z or 480Z computers?
A. 5% B. 10%
C. 20% D. 40%
E. 80%

COMPETITION

Win a complete 480Z system in our great Languages Competition.

THOUGH DESIGNED especially for educational use, the 480Z is also suitable for general business applications as it is a solidly built CP/M machine. The prize system, generously provided by Research Machines Ltd, is based on the model L4 version with high-resolution colour graphics, so it would also make a luxurious home system. Also included are a high-resolution Microvitec colour monitor, a RML dual-floppy disc drive, an Epson RX-80 dot-matrix printer and all the software packages provided under the RML school and college network scheme.

The competition is open to all individual U.K. readers of *Practical Computing*; however, we will accept one entry per person so schools and colleges have a certain advantage if they care to photocopy the entry form.

The winning entry will be the one which in the judge's opinion answers the questions correctly and provides the most original and witty suggestions to the tie-breaker problems. Each question only has one correct answer. Write down the letter corresponding to the correct answer to each question in the boxes on the entry form. Then do the tie-breakers.

Rules

1. The competition is open to all readers of *Practical Computing* normally resident in the U.K., except for employees of Business Press International Ltd or Research Machines Ltd, or their families.
2. Each entry must be written in ink on the official entry form printed here or on a clear photocopy. Only one entry per person is permitted.
3. Completed entry forms should be posted to the address shown on the entry form to arrive not later than April 30, 1984. Envelopes must be clearly marked "COMPETITION" in the top left corner.
4. The Editor of *Practical Computing* is the sole judge of the competition. No correspondence can be entered into regarding the result of the competition and it is a condition of entry that the judge's decision is final.
5. The winner will be notified by post and the result of the competition announced in the first available issue of *Practical Computing*. The winning entry will be reproduced, and other entries may be reproduced without payment.
6. The prize is a RML 480Z system with monitor, discs, printer and software. No cash substitute will be offered.
7. The prize will be awarded to the individual named on the winning entry form, unless the contestant names a U.K. educational institution they would like the prize to go to instead, in which case the prize will go to the institution.

Entry form for *Practical Computing* 480Z Languages Competition

Name

Address

.....

.....

.....

If I win I want my prize awarded to

.....

.....

(write either "myself" or the name of a U.K. educational institution)

Signed

Answers

- | | | | | |
|-----------------------------|-----------------------------|-----------------------------|-----------------------------|------------------------------|
| 1. <input type="checkbox"/> | 2. <input type="checkbox"/> | 3. <input type="checkbox"/> | 4. <input type="checkbox"/> | 5. <input type="checkbox"/> |
| 6. <input type="checkbox"/> | 7. <input type="checkbox"/> | 8. <input type="checkbox"/> | 9. <input type="checkbox"/> | 10. <input type="checkbox"/> |

Tie-breakers

1. The name "Basic" is supposed to stand for Beginners' All-purpose Symbolic Instruction Code. Make up a name for a new language out of the initials of words explaining the special purpose of the language. The acronym does not have to be exact, but in any case limit yourself to under 12 words of explanation.

.....

.....

.....

2. *Practical Computing* is thinking of producing a tasteful sweatshirt; all we need is a suitable slogan. Suggest one of eight words or less.

First try

.....

.....

Second try

.....

.....

Return this entry form to: *Practical Computing*/ RML Competition, Room L306, Quadrant House, The Quadrant, Sutton, Surrey SM2 5AS. Write "COMPETITION" clearly on the top left-hand corner of the envelope.



SINCLAIR QL

Jack Schofield reports on the new Sinclair micro, which once again combines low price with an astonishingly ambitious spec.

EACH OF Sinclair's new machines has been more amazing than the one before, but this time he has really excelled himself. The QL fully deserves the initials, which stand for Quantum Leap, it is so far ahead of everything else at the same price.

The Sinclair QL is a 32:8-bit multi-tasking micro with windowing, 128K of RAM, two built-in Microdrives, a good-quality keyboard, a good selection of I/O ports and four software packages, all for £399.

The CPU is the Motorola 68008, the newest and most junior member of the powerful 68000 family. It has a 32-bit internal architecture and an eight-bit data bus. The 68000 itself is a 32:16-bit chip used in more expensive machines such as Apple's Lisa at £7,500, the Fortune 32:16, the Sage II, Wicat 150, Hewlett-Packard Model 16 and similar models at £3,500 upwards.

Perhaps the micro which is closest in terms of functionality would be a £2,000 IBM PC running the window manager Desq which costs \$399 extra, not including the applications software. That, at least, was my impression at the launch of the QL, where all the demonstrations were run using real machines, said to be "pilot production models".

Obviously there will be teething problems — all new micros suffer from them. However, the QL is being made by Thorn-EMI at its Feltham plant which used to build the Newbrain, an earlier Sinclair design. On past performance, the QL should be well made but there will probably be supply problems due to demand.

There will also be bugs, and some features of the QL will turn out to have unforeseen and possibly

unwanted consequences. But even so, the Sinclair QL is too powerful a machine for anyone to ignore — and that includes professional and educational as well as home micro users.

The QL comes complete with 128K of RAM, of which 32K is dedicated to the screen display. That leaves 96K of user RAM, some 2½ times the amount free to Basic in a 64K Commodore or Atari. Sinclair says a half-megabyte RAM pack will be available later to fit the expansion bus. Let's hope it doesn't wobble.

Mbyte addressing

The QL has 32K of ROM, which contains both Sinclair SuperBasic and the QDOS multi-tasking operating system. A further 32K of ROM can be added via the cartridge slot in the back. This slot and its cartridges appear to be physically the same as the Spectrum ones, but are not compatible. Altogether this accounts for 704K, while the total linear addressing capability of the 68008 is 1Mbyte, from 00000 to FFFFF.

The QL has no cassette-tape port and no disc interface. Mass storage is provided by two built-in Sinclair QL Microdrives. Each contains a 200in. loop of video tape moving at 30in. per second, making a circuit every 7.5 seconds. This justifies Sinclair's claim of average access time around 3.5 seconds

Each Microdrive has a capacity of up to 255 sectors of 512 bytes. The capacity is quoted conservatively at 100K each — about 16K more than the Spectrum Microdrives. The two versions are not compatible, though both can use the same cartridges if they are appropriately formatted. Up to six extra QL Microdrives can be added, to provide 800K on-line storage, and a hard-disc interface has been promised for the future.

The Microdrives remain as yet unproven for serious use, so obviously many people will want to add conventional floppy-disc drives. This may be possible via the expansion bus, or the two RS-232C ports provided. The ports transmit at 75 baud to 19,200 baud, or provide full duplex transmit/receive at up to 9,600 baud.

The ROM-resident QDOS operating system was not demonstrated at the launch, but appears to be Unix-like. It seems most commands can be used from SuperBasic. The Exec command will load a sequence of programs and run them in parallel.

Sinclair SuperBasic is an enhanced



Mass storage is provided on 100K Microdrive floppy-tape cartridges.

version of Spectrum Basic — with some massive improvements. The wretched multiple-shift “single keyword” entry has, thankfully, gone. Other enhancements make the language much more BBC-like. For example, SuperBasic has procedures, and variables can be defined as Local. Structured commands include If-Then-Else, If-Endif, and Repeat-End Repeat.

Special commands to handle the windowing capability include Window, which is used to create one, and Pan to allow sideways scrolling. Pan 50 means Pan left by 50 pixels. To the Spectrum concepts of Paper and Ink you can now add Under, Over and Strip. Windows look like fun. There is also Date\$ for the battery-backed real-time clock, a nice feature sadly lacking from the Acorn BBC machine and the IBM PC.

The QL can drive a colour TV or RGB monitor directly. The screen display is bit mapped with co-ordinate 0,0 in the top left. Screen RAM is organised as 16-bit words starting at 20000 hex and progressing with the raster scan.

There are two display modes. The four colours black, red, white and green can be used with 512-by-256 pixel definition. In the 256-by-256 pixel mode, eight colours are available: black, blue, red, magenta, green, cyan, yellow and white.

The SuperBasic command CSize is used to set character size. Characters can be 6, 8, 12 or 16 pixels wide, and 10 or 20 pixels high, opening up a wide range of effects. The character set can be redefined. On a monitor the QL will normally display 85 columns of text by 25 lines. On a TV set, the width may be from 40 to 60 columns.

There must be reservations until production samples become available, but the QL's 65-key keyboard seems excellent. With the legs supplied to lift the back it has a good angle, and the full-travel keys seem fine for touch-typing. They are also pleasantly quiet.

Key layout

The key layout is excellent, with a full space bar, two Shift keys and an over-sized L-shaped Return key in exactly the right place. There are four cursor-control keys: left and right arrows are to the left of the space bar, up and down to the right. There are also five function keys, plus Control and Alt.

Most of the key assignments seem correct, though there are some oddities. For example, there is no Delete key: you use Ctrl-Left Arrow instead, but at least they're close together. As on the Spectrum, both £ and \$ are present. Sinclair's brochure, attached to U.K. copies of this magazine, reproduces the keyboard full size.

The QL is well supplied with ports, most of which have already been mentioned. The two ports labelled CTL1 and CTL2 are for one or two joysticks. Regrettably they will not accept the standard nine-pin D Atari-type connector used on the Spectrum

interface. The same ports will undoubtedly run other accessories too. The QL has no parallel port, but a Centronics printer port is promised as an add-on extra.

The network ports are for QLAN, the QL's built-in local area network. It allows up to 64 QLs and Spectrums to be connected with a data-transmission rate of 100K baud. Has no one at Sinclair noticed that there already is an entirely different system called QLAN? It is produced by Quorum for the Canon AS-100 micro — see our November 1983 issue, page 113.

Four software packages are supplied with the QL: a word processor, a spreadsheet, a database and a business graphics package. Data can be passed between them using the Import and Export commands. All four programs have been written by Psion, which will fully support and upgrade the software for people who

Specification

CPU: Motorola 68008 running at 7.5MHz; 32-bit internal bus, eight-bit data bus; 1 Mbyte linear addressing capability

Other ICs: Intel 8049 controller plus four semi-custom ULAs

Memory: 128K RAM, including 32K video RAM; 32K ROM; RAM expandable to 640K; ROM expandable to 64K via 32K cartridge slot

Keyboard: 65-key moving-key QWERTY layout with four cursor keys and five function keys

Storage: two built-in 100K Microdrive floppy tapes, average access time 3.5 seconds

Display: via additional TV or monitor; monitor display up to 85 characters by 25 lines; TV from 40 to 60 characters by 25 lines; user-defined character sets

Graphics modes: 512 by 256 pixels in four colours or 256 by 256 pixels in eight colours; colour coding is non-compatible between modes

Built-in software: Sinclair SuperBasic structured Basic with procedures, extendability and full-screen editor; QDOS multi-tasking operating system with time-slice job scheduler, multiple windowing and device independent I/O

Software in price: Quill word processor; Abacus spreadsheet; Archive database and Easel business-graphics package; all written by Psion

Interfaces: TV and RGB monitor ports, Microdrive expansion, two RS-232 serial ports, two joystick ports, two local area network ports, main-board expansion bus, internal expansion socket

Power supply: 9V DC at 1.8A; 15.6V AC at 0.2A

Dimensions: 138mm. by 46mm. by 472mm.

Weight: 1,388g (3 lb.)

Price: £399 including VAT, plus £7.95 post and packing

Availability: mail-order only, in limited quantities from the end of February

join QLUB at a cost of £35 per year.

Extravagant claims have been made for these packages: “They outperform the software for all existing micros”. On demonstration they looked fast, attractive and user-friendly — but then, it would be a poor demonstration if they did not. Judgement must be reserved until after we have had the chance to test them.

Competition

If the claims are true, the software alone must be worth somewhere between £400 and £1,500. But even if they are not the QL on its own looks worth rather more than the asking price so it's hard to see how you can lose on the deal.

At the moment, only one company has a comparable machine at under £5,000, including software. That is Apple, whose new Macintosh is also previewed in this issue.

Several other companies are rumoured to be working on 16/32-bit small micros. Commodore is said to be using the Z-8000, Atari and Apple the 68000, and IBM has an 8088 in the PCjr. Acorn is readying the ABM, a business micro using the National Semiconductor 16032 chip. But the Sinclair QL is almost here, and the rival machines are not. Sinclair will be selling the machine in the U.S. at \$499.

It will be most interesting to see Acorn's response. The QL makes the Electron look feeble, and it offers so much for the money the BBC Model B itself could be threatened. A redesigned, cheaper main board looks overdue, as does a price cut.

Conclusions

- The Sinclair QL has an excellent specification, a good keyboard, a good range of ports and looks unbeatable value for money.

- Although it will be initially short of software, especially until everyone learns 68000 assembler, the packages included promise to make it a usable machine from the start.

- SuperBasic, the real keyboard and LAN make the QL a very attractive machine for schools, colleges and, especially, students of computing.

- When the hard-disc interface arrives, or someone hooks up a couple of standard twin floppies at, say, £400 the Sinclair QL has the potential to beat every business micro on the market at under £2,000 — and most that are under £5,000. If I ran ICL, I would launch just such a version, at £999, at the earliest possible moment.

- If the QL is reliable, delivered in quantity and lives up to its promise, it should do very well indeed, providing competition even for IBM.

- The Sinclair QL is designed by Sinclair Research of Cambridge. Enquiries can be sent to Sinclair at Freepost, Camberley, Surrey GU15 3BR. Telephone: (0276) 686100.

BY NOW, even the most Luddite of executives is probably convinced that the spreadsheet is a valuable tool. Apart from saving them and their accountants endless recalculations, managers can see what is happening in their business; at the flick of a switch the budgets and forecasts of a company are laid bare.

The strength and success of the spreadsheet lie in being able to provide a wide range of analyses. Because it provides a minimum of structure, it is almost endlessly flexible. But what is simple can often be too simplistic. Now that spreadsheets have come of age, there is a need for management tools based on related software techniques.

A step further

Integrated packages like Lotus 1-2-3 are a step in the right direction. By allowing sophisticated spreadsheet methods to be linked to graphics, direct, easy-to-understand representations of otherwise dull esoteric figures can be obtained, so that broader judgements are more likely to be made. A similar development can be found in Fox and Geller's dGraph, which produces graphics output from dBase II. Now Fox and Geller has gone one step further with Oz, a management-control system uniting spreadsheet-type features with extended graph options.

Oz runs on the IBM PC or XT with 256K of RAM and, it is claimed, on compatibles. The cost is £330. It is aimed specifically at companies and other similar organisations: standard management and financial structures of companies are built into Oz, but the greater depth of analysis is bought at the expense of versatility.

OZ

Glyn Moody examines a management-control system that aims to wave a magic wand over the mystique of company accounts.

When you boot the main program, which occupies a healthy 135K of RAM, the entry menu presents two classes of objects, namely Actions, which manipulate the data, and the data itself. The names Actual, Budget and Forecast represent three parallel sets of data. Budget and Forecast are entered at the beginning of a financial year, and Actual is entered as figures become available.

The figures entered are all quantities that must be defined beforehand as line items — see figure 4. They represent some of the basic variables of the situation. For example, it will be possible to single out Rev, the total sales, for detailed analysis and graphical representation. Entering Budget or Actual data consists of assigning some of these variables with, for example, budgeted or actual sales of product X or Y.

A further refinement is the breakdown of the company into a hierarchy of units. Thus a typical organisation Softco might be made up of three divisions: Admin,

administration; Market, marketing; and Tech, technical. They might be broken down further with, say, Market comprising Adv, advertising, as well as Planning and Sales. The basic variables defined are entered only for these elementary units. It is possible to unite the various components using the Consolidate option of the main menu; figures are then available for elementary and consolidated divisions. All these actions may be performed separately on any of the basic data sets such as Budget, etc.

Figures analysis

Having set up the company structure and the data, it is now possible to begin analysing the figures. Again, analysis can be of any data set for any division of the company. For example, the budget figures for Sales might be chosen. This is done by entering the relevant name in the main menu. Movements within the menu are achieved by cursor controls or initial-letter commands — M for Modify and so on.

Each command is usually followed by a further menu, where movement is effected similarly. Movement back up to higher levels of the nested menus is done by means of the Esc key. This is fine except that one Esc too many and you are back in MS-DOS, with Oz and its input junked. Consistent commands for mobility are all very well, but a distinction should be made for the final exit.

Analysing the Actual figures for Softco produces figure 1. Here the Rev, Exp and net — which equals Rev - Net — are given for the year so far. Now Softco has three divisions, and by pressing the Oz-defined function key F8, you can obtain the same

Actual		SOFTCO											
	Jan	Feb	Mar	Apr	May	Jun	Jul	Aug	Sep	Oct	Nov	Dec	Total
REV	10	11	13	16	18	20	21	20	21	-	-	-	150
EXP	12	12	11	16	16	16	17	17	17	-	-	-	133
NET	-2	-1	2	-	2	4	4	3	4	-	-	-	17

Figure 1. Raw data for Softco.

Actual		January			
		SOFTCO	ADMIN	MARKET	TECH
TOTAL SALES	10	-	10	-	-
TOTAL EXPENS	12	4	4	4	4
NET INCOME	-2	-4	6	-4	-

Figure 2. The Cube provides a two-dimensional analysis of the data

Actual		TOTAL EXPENSES											
	Jan	Feb	Mar	Apr	May	Jun	Jul	Aug	Sep	Oct	Nov	Dec	Total
SOFTCO	12	12	11	16	16	16	17	17	17	-	-	-	133
ADMIN	4	4	3	3	4	3	5	5	4	-	-	-	34
MARKET	4	4	4	7	7	7	8	8	8	-	-	-	59
TECH	4	4	4	5	5	5	5	5	5	-	-	-	40

Figure 3. An alternative analysis, by month and division.

figures for Admin, Market and Tech.

You can examine the analysed data in a different way. Hitherto the three elements Rev, Exp and Net have been considered for 12 months, for Softco, for Market and so on. But you could consider these three things for Softco and its three divisions, simultaneously for one particular month. This is effected by using the key F6 — the Cube as Fox and Geller terms it. Figure 2 shows the result.

The name Cube arises from the fact that there are three sets of variables: you have a choice of divisions, a choice of financial breakdown and a choice of month. These three sets can be thought of as lying along three edges of a cube which meet at a corner. Each of the previous possible analyses is like slicing through the cube to give a two-dimensional table which is printed out as in figure 2. Moving the slice along corresponds to producing successive tables for January, February, and so on.

Cube cutting

There remains a third way of cutting the cube. It is shown in figure 3, where the Total Expenses are broken down by month and division.

Two simpler facilities should also be mentioned. By pressing Q, the totals are converted from monthly to quarterly ones; pressing Q again converts them back. Pressing the minus sign enables negative quantities to be highlighted. At this point Oz makes striking use of its colour facilities. Hitherto, the entries have been against a blue background but pressing — sends shocks of bright red throughout the sheet, illustrating where deficits occur.

Colour is also important in a further facility sinisterly called the Midas Touch, and instigated by function keys F2 and F7. This highlights in garish yellow selected entries of the analyses obtained. It allows for the chosen entries to be "exploded" to find out what the constituent parts of that entry are by using another function key, this time F4. For example, the Actual figures for Market can be exploded to reveal the contributions from product X, product Y and Oz. Since this exploding facility can be combined with the Cube

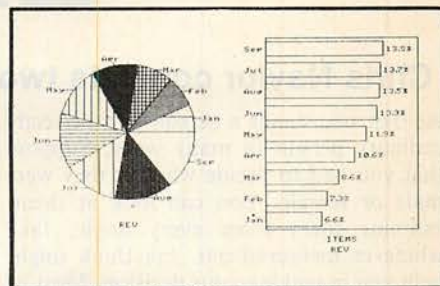
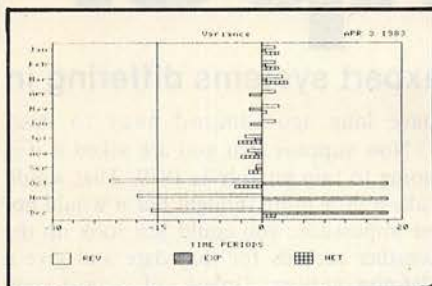
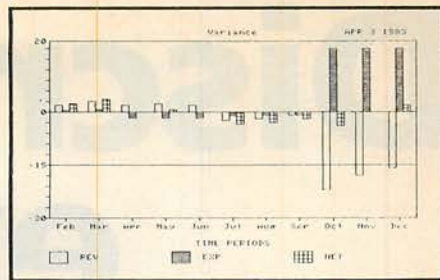
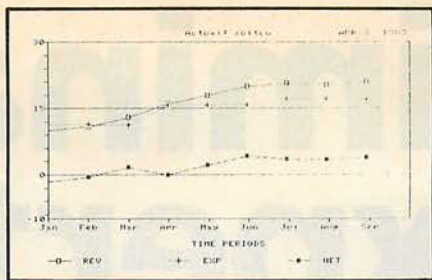

A range of graphing options can be invoked from a single menu.

option, and for any of the data sets, it can be seen that Oz's manipulative power is extraordinary, if dizzying in its complexity.

Happily, salvation is at hand in the graphics options. At any point during the generation of figures a last function key can be invoked: F4, the graph key. From an on-screen menu it is possible to produce instantly bar, line, area, percentage bar, stacked bar and horizontal bar graphs. The colour graphics are superb and generally very fast; only the pie charts falter slightly.

One other facility provided by Oz is a variance analysis report. A Budget variance, for example, produces Actual versus Budget comparisons by month, quarter and year. This is a standard but useful procedure.

Powerful tool

Within its limitations, Oz provides a very powerful tool for analysing and displaying company and organisational information. It is, however, strongly geared to its archetype of a company with several divisions, manufacturing several products. Firms offering services will probably find it less flexible. It must also be remembered

that Oz cannot produce anything that was not originally fed in. It merely allows end effects to be chased and finally compared to initial inputs. One useful facility here is the option of adding a reason for an input figure — why it has been entered or changed. This comment is stored as the lowest level of the information's nested tree structure.

Refinements that might be contemplated include simplification of the Midas Touch and, to a lesser extent, the Cube. Since an obvious method of filling in the figures would be to have each division input them directly, it would be sensible to add a hierarchical password structure. Also it would be useful to have an integral linked spreadsheet. It would allow managers to try out budgets and forecasts for their divisions before transferring across to the main body of the program. The maker claims that Oz can read data from VisiCalc and SuperCalc.

The version reviewed here was a demonstration one only. A number of further facilities such as a Help option are promised.

Conclusions

- Oz represents the first of a new generation of specific management tools. Within its particular sphere of company-type accounts, it presents a full and detailed analysis.

- It is not totally user-friendly since it is possible to degrade some of the input formats with strings that are too long. However, frequent use will probably ease some of these problems.

- It has excellent graphics and an aesthetically pleasing use of colour.

- It will not tell you anything which somebody in your organisation would not have known already, but Oz will make that information readily available to you.

- It is not a straight integrated package, and lacks certain facilities. When it is enhanced, it will be very powerful indeed. □

Ln#	Tag	Description	Cat	Computation
1	BDX	Brand X Product	R	
2	BDY	Brand Y Product	R	
3	OZ	Oz Product	R	
4	REV	TOTAL SALES	R	BDX+BDY+OZ
5	MAN	Management Salaries	E	
6	REG	Staff (Regular)	E	
7	OT	Staff (Overtime)	E	
8	PAY	Payroll	E	MAN+OT
9	REN	Rent	E	
10	SUP	Supplies	E	
11	EXP	TOTAL EXPENSES	E	PAY+SUP
12	NET	NET INCOME	R	REV-EXP
13	HC	Headcount	H	

Figure 4. All quantities must be defined before figures are entered.

Discriminating experts

Chris Naylor consults two expert systems differing in price more than capability.

BEFORE YOU stands a person — a perfectly ordinary person in many ways. Suppose that you had to decide whether they were male or female. You can look at them, examine them from every angle, take whatever measurements you think might help you in making your decision. Most of the time you would be able to make a perfectly adequate decision straight off — one glance should suffice.

But suppose that this person happened to have died several thousand years ago. How, then, would you make your decision? Some of the most crucial evidence would

have long ago vanished away to dust.

Now suppose that you are asked if it is going to rain on July 1, 1979. That would take a little more thought but it would not be impossible: you could just look up the weather records for that date and give a definite answer. Unless, of course, you happened to be asked the question on the last day of June 1979, in which case this one piece of crucial evidence would again be missing.

Now consider a third problem: you have to decide whether a patient has gallstones or not. No evidence at all is missing in

this case because the questioner has thoughtfully provided you with a mass of data on the patient. You have the case history, signs and symptoms, X-Ray report, urine analysis — everything. But although all of the evidence is there, in your medically untutored state you do not know which bits of evidence are important and which can be ignored. You are swamped with data.

Each of these examples illustrate the problem of discrimination: between male and female, between rain and no rain, between gallstones and good health. Every

Discrimination

The general problem

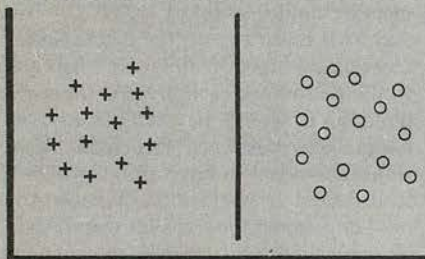

In general, the discrimination problem is an attempt to separate two groups of objects. In the figure these objects are measured on two variables — or two dimensions — and it is possible to discriminate between the two groups simply by drawing a line between them.

In practice, there may be more than two groups of objects, but in a clear-cut example like this it is easy to decide exactly where to draw the separating line.

The parametric case

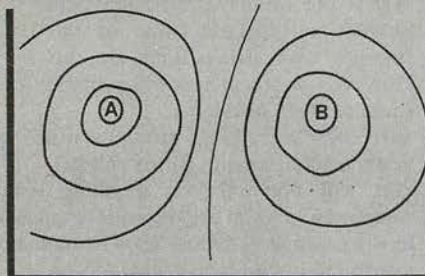

In many discrimination problems it is possible to assume something

about the distribution of the variables upon which the objects are measured. A typical assumption may be that the variables are normally distributed. When a known distribution can be assumed the analysis may be parametric, using statistics based on known parameters for the distributions of the objects. When this is the case, it is very much like having n sets of objects each with their own particular contour lines to indicate the probability of an object belonging to any particular class.

A good discrimination method might then be to find the equal contour line between the two groups and use this to discriminate between the classes of objects. Every time a discrimination decision is made, it is possible to say with what probability that decision is likely to be correct.

Non-separable classes

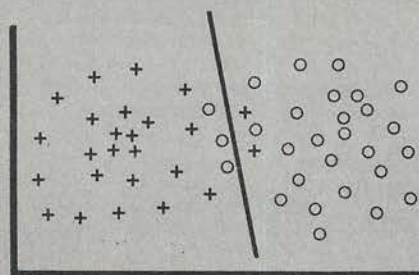

In general, there may be a considerable amount of overlap between the two groups. Little or no information may be available about

the underlying distribution of the measured variables, so parametric statistics cannot readily be used.

In this case a non-parametric method has to be found to separate the two groups. Not only may the method make mistakes, it may also prove to be difficult to estimate just what the probability of a mistake is in any given case. Overall, the method might work well — it is just that we might not know how well it is working on any particular example.

A non-parametric method

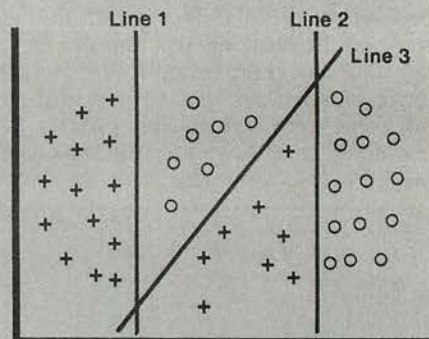

Most parametric discrimination methods attempt to solve the problem by drawing a single line or curve between the two groups of objects and many non-parametric methods try to do the same.

However, some non-parametric methods make use of the fact that there is no necessary reason why one single line should be used. In this example line 1 is used as a first cut in the discrimination process.

day, in hundreds of different ways people make discriminatory judgements. As these examples illustrate, there are many cases in which such judgements are difficult. Anyone capable of offering good judgements in these matters qualifies as an expert in that field.

Wouldn't it be nice to have a computer to make good judgements for you? Then you could think of that computer as an expert and there would be no need to wear out your brain cells trying to do what the computer could do. The ability to make good, expert judgements is, in many cases, right at the heart of an expert system.

Real problem

Perhaps this sounds a little removed from the usual world of computers and programming. It isn't really, but the connection is not usually made explicitly. For a start, consider the If statement as in

```
IF X = 0 THEN ...
```

That is an example of discrimination. The program discriminates between cases in which X is zero and in which X is non-zero. Discrimination is something that you are already doing in your programs.

Objects to the left of it all belong to the first group while those to the right of it remain a mixture. Line 2 improves the discrimination, inasmuch as objects to the right of it belong to the second group, leaving only the middle ground to represent uncertainty. Line 3 finally discriminates between those objects falling between the first and second cuts.

An impossible case

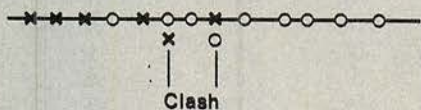

Consider this example of two groups of objects measured on only one variable. Clearly no single line would separate them. By using multiple cuts it would be possible to achieve better discrimination, but it may prove necessary to make as many cuts as there are objects in the samples, in which case the method reduces to naming each object and developing a rule for each individual point.

Even this method may not work if two points happen to occupy exactly the same location, in which case these two points cannot be separated by any means and there is an insoluble clash. Further, if the points occupied by the objects had only been approximate anyway then the method used might separate the original group but might not prove to be applicable to any other similar samples.

From this rather trivial example we can now turn to the subject of discrimination as it is usually taught — especially to statisticians. In general, the problems involving discrimination consist of a set of two or more classes of objects in which for each object there is a set of measurements available; the problem is to allocate each object to the correct class on the basis of its measurements.

If you look at some of the examples in the box on the left you will see a broad overview of some of the methods that have been used at various times to solve this problem. In general they tend to be esoteric and, probably for that reason, have so far attracted little popular interest.

It would be handy if these methods could be implemented on a home micro so that you could use them without having to understand the maths behind it all. Then you would be able to predict the weather, or determine the sex of ageing skeletons, or diagnose gallstones — indeed solve any number of problems which were previously beyond you. This is the thinking behind Expert-Ease and Hulk, the two packages reviewed here. Both attempt to provide a general-purpose method for discriminating between objects in a wide range of situations.

In general terms, both Expert-Ease and Hulk work in the same way. You provide the program with a sample of objects upon which you have made certain measurements. For this initial sample you know which classes the objects belong to. Then, using the programs, a method of discrimination is developed which will enable the program to classify the objects you have given it. Then, keeping your

fingers crossed, you hope that the method developed will also apply to other objects whose correct classification is unknown.

So you could provide sample data based on the measurements of skeletons whose sex was known, in the hope of developing a method which would later enable you to sex skeletons in general. Or you could provide some weather data from the past in the hope of being able to predict the weather in the future. Or, again, you could provide it with some case histories of gallstone and non-gallstone patients in the hope of finding a good method of diagnosing gallstones in future patients.

Can it be done?

It all sounds like pretty good stuff — but a few words of caution are in order. The first thing to remember is that not all objects are intrinsically separable from a given set of measurements. Consider the problem of distinguishing between birds and planes: if the only measurement you have is the Boolean quantity Wings/No Wings then the two groups of objects cannot be separated using the data at your disposal. That may be an extreme example, but many objects can be intrinsically hard to separate totally.

Some methods of discrimination are better than others. The catch here is that there is usually no single method that is better or worse than any other — it all depends on the data you have. For instance, a parametric method based on the normal probability distribution can give results which are second to none, but only if the data is normally distributed. Most data

(continued on next page)

The Bird/Plane problem

Given an object, you have to decide whether it is a bird or a plane. Birds have wings and no engine; planes have wings and an engine. Using the following data:

Birds: sparrow, tit

Planes: Comet, Harrier

Birds have: wings, no engine

Planes have: wings, engine

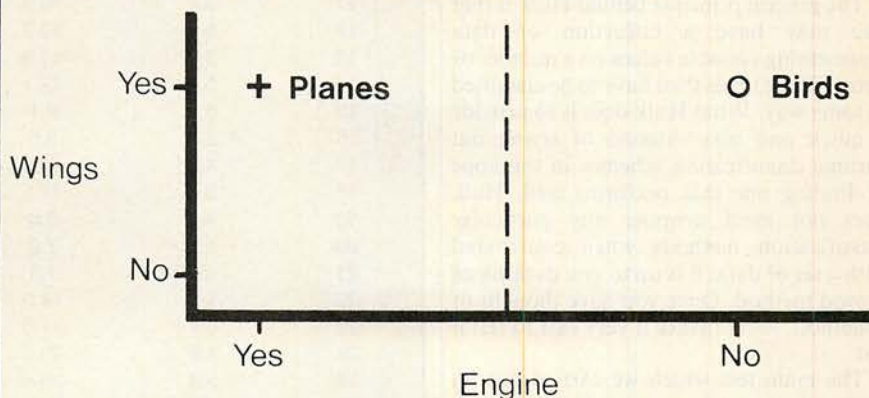

This trivial example serves to demonstrate that discrimination methods are equally applicable, in general, to non-probabilistic data. In this case there is no doubt at all about the correct classifications and all of the quantities are Boolean. Yet the problem can still be seen as one in which a dividing line or rule must be found which will discriminate between two classes of objects measured in a two-dimensional space.

(continued from previous page)

is not, even if statisticians wish it were otherwise.

If a method is to be generally applicable to a large range of problems it usually has to use a non-parametric approach which assumes nothing in particular about the data it is working on. This allows a general-purpose approach but can lead to results which are in some cases inferior. The most usual problem arises when the method simply is not sure about the answer. Non-parametric methods often fail to provide any way of saying exactly how uncertain the answer is except that it may be possible to make a statement about the soundness of the answers in general, rather than a specific statement about each answer in particular.

On the brighter side, plenty of problems in discrimination are easily soluble. Take the question of whether or not you should go to the cinema this evening. Do you like going to the cinema? Is there a film on you haven't seen? Do you have the necessary funds? Is there anything else you should be doing? If the answers are Yes, Yes, Yes and No then you go to the cinema. If they are No, No, No, and Yes then you don't.

This is an example of discrimination at work. There are four Boolean variables, and the discrimination task is so simple that almost any method would work on the problem. If you can devise a program which will ask you those questions and offer cinema-going advice on the basis of your answers, then you have a primitive expert system.

Hulk

The name derives not from the comic strip but from the fact that it helps uncover latent knowledge. Hulk comes on cassette with a fairly slim manual so it could be run on a cassette-based system. However, it is recommended that you transfer the original cassettes to floppy disc and then run from there.

The general principle behind Hulk is that you may have a collection of data representing variable values on a number of items. These items then have to be classified in some way. What Hulk does is to provide a quick and easy method of trying out various classification schemes in the hope of finding one that performs well. Hulk does not itself propose any particular classification methods when confronted with a set of data; it is up to you to think of a good method. Once you have thought of a method, Hulk makes it very easy to test it out.

The main test which we carried out on Hulk was to create a set of rules which would help to predict whether or not it would rain tomorrow. The test data, shown in figure 1, consists of data for the 31 days of March 1982. It includes minimum temperature, maximum temperature, rainfall, sunshine and a fifth variable showing whether or not it rained the

following day. These figures originated from the London Weather Centre.

The first task was to get this data into the machine. It is entered a format very much like the lines of Basic

```
10 WEATHER, 31,5
20 MINTEMP
30 MAXTEMP
40 RAINFALL
50 SUNSHINE
60 RAINDUE
70 D1, 9.4, 11.0, 17.5, 3.2,1
```

```
.....
370 D31, 4.6, 9.6, 3.2, 4.2, 1
```

In plain words this says there are 31 samples in the data set, each of five items. The five items are named in separate lines, which are followed by 31 lines each giving the values on these items for one of the samples. The data is then saved on a disc file. It is hardly elegant, but it works.

The next stage is to run a program called Prescan. It first asks what hypothesis you want to test. To test the hypothesis that it rains tomorrow reply

```
RAINDUE = 1
```

Any hypothesis involving arithmetic or logical operators on any of the five named variables could have been set up for the test. Prescan does a preliminary check through the five variables to see which, if any, might act to distinguish between those days on which rain followed and those days on which it did not. It is done by carrying out an approximate t-test on each of the five variables in turn to see which gives the highest score.

In this case Prescan suggested that the

variable Rainfall would be worth investigating because high rainfall figures for one day seemed to suggest rain was due the next day. It also suggested that Rain Due was another good variable to look at.

The next program, called Look, prompts the user to provide rules which it then tests out against the data to see if they are any use at predicting the hypothesis — that is of discriminating between days for which rain is due and days for which it is not. Rules could be any combination of arithmetic or logical operators. So, keying in

```
RAINFALL > 1
```

as rule 1 tests the prediction that rain is due if today's rainfall is greater than 1mm. The Look program then assesses this rule against the examples it had been given: it found that it could predict tomorrow's rainfall in 24 out of 31 days and advised that the rule be retained. A number of other rules were proposed, most of which did little, if anything, to help matters. Look suggested that these rules should be abandoned.

Eventually, two more rules were unearthed which did help to improve the score and which Look advised the user to keep. They were rule 2:

```
((MAXTEMP - MINTEMP)/MINTEMP)*
100 > 40
```

and rule 3:

```
SUNSHINE > 3 AND MAXTEMP < 10
```

which improved the forecast to 26 days correct out of 31. Rule 2 indicates a wide range of temperature variation during the

Day	Min temp °C	Max temp °C	Rainfall mm.	Sunshine (hours)	Rain tomorrow
1	9.4	11.0	17.5	3.2	yes
2	4.2	12.5	4.1	6.2	yes
3	7.6	11.2	7.7	1.1	yes
4	5.7	10.5	1.8	4.3	no
5	3.0	12.0	0	9.5	no
6	4.4	9.6	0	3.5	no
7	4.8	9.4	0	10.1	yes
8	1.8	9.2	5.5	7.8	yes
9	2.4	10.2	4.8	4.1	yes
10	5.5	12.7	4.2	3.8	yes
11	3.7	10.9	4.4	9.2	yes
12	5.9	10.0	4.8	7.1	yes
13	3.0	11.9	0.2	8.3	no
14	5.4	12.1	0	1.8	yes
15	8.8	9.1	8.8	0	yes
16	2.4	8.5	3.0	3.1	yes
17	4.3	10.8	4.2	4.3	no
18	3.4	11.1	0	6.6	yes
19	4.4	8.4	5.4	0.7	yes
20	5.1	7.9	3.0	0.1	yes
21	4.4	7.3	1.0	0	no
22	5.6	14.0	0	6.8	no
23	5.7	14.0	0	8.8	no
24	2.9	13.9	0	9.5	no
25	5.8	16.4	0	10.3	no
26	3.9	17.0	0	9.9	no
27	3.8	18.3	0	8.3	no
28	5.8	15.4	0	7.0	yes
29	6.7	8.8	6.4	4.2	no
30	4.5	9.6	0	8.8	yes
31	4.6	9.6	3.2	4.2	yes

Figure 1. Data for weather-prediction problem.

day, and rule 3 indicates that the day was sunny but cold.

The selected rules are saved in a named rule file and you are then ready for the final stage, which is to run the program Leap. This program takes a data set and a rule set from existing disc files and applies the rules to the data, giving a classification for each data item according to the rule set.

In general, given the nature of this test data, the results obtained using Hulk are good. There is a distinct limit to the ability to predict rain on the morrow from data like this and that limit probably does lie around the 75 percent correct level.

A second test gave more ambiguous results from the simple task of identifying whether an object was either a bird or a plane. The data used was

```
10 BIRDPLANE, 4,4
20 BIRD
30 PLANE
40 WINGS
50 ENGINE
60 SPARROW, 2,0,1,0
70 TIT, 1,0,1,0
80 COMET, 0,1,1,1
90 HARRIER, 0,1,1,1
testing the hypothesis
BIRD = 1
```

The problem lies in the fact that Prescan, in carrying out an approximate t-test, assumes that the variables have a non-zero standard deviation, which these variables do not. On finding a standard deviation of zero the t-test scores go to infinity — or at least to the limit of the machine's range — and every variable is then reckoned to be important enough to warrant investigation. So, according to Prescan, variable Wings should be investigated, which is clearly wrong.

Even without Prescan's help it was possible to devise a set of workable rules as the methods used by Look and Leap make no assumptions about the data. They simply set up a two-by-two contingency table showing which data items are correctly classified according to the current rule set, and which are not. From this, they estimate the overall probabilities of each rule set giving correct classifications.

Hulk does not give an exact probability estimate on individual items of data in the data set. For instance, it does not say exactly what the probability might be of rain following the weather given in, say, day 3. It simply gives a prediction for day 3 that rain will follow on the basis of whether or not it satisfies the rule set. It is very much an all-or-nothing decision which is likely to give good results on a large number of examples.

In many ways Hulk can be thought of as a batch process. You give it a file of test data, develop a file of rules and then implement these rules on a new file of data. There are no facilities for wandering up to the machine with a single example and asking it what it thinks about it. Even a single example would first have to be turned into a Hulk-format file. Hulk's strong point is the ability to try out different rules rapidly on a set of data to see

whether they are any good. It is very quick and interactive and justifies its name — it does help uncover latent knowledge.

Apart from predicting the weather and deciding if a tit is a bird or a plane, people may well wonder what they could do with Hulk. The National Coal Board has used it for categorising samples of coal: from a chemical analysis of coal samples Hulk developed a set of rules from which the NCB could determine which pit any coal sample came from.

As with any general-purpose tool the uses it could be put to depend as much on the user's imagination as anything. A credit-control manager who wants to identify risky customers might think that marital status could do the job, or perhaps income, or age. Given a set of test data to work on it would not take long to test and refine the rules used to assess creditworthiness. It is just another example of what is, in statisticians' jargon, a classification or discrimination problem. Think of another classification problem and you have another application: there is no definitive list of application areas for Hulk.

If Hulk were being sold at a much higher price than £25 there would still be a hard core of interested purchasers. It can genuinely help people to make sound decisions — and bad decisions are extremely costly in many enterprises. The £25 price tag suggests there is more than a touch of idealism to it. A large number of people will be able to have a go and get the feel of this still uncommon type of product.

Expert-Ease

Expert-Ease comes on disc with an exceptionally clear and unambiguous manual. It is hard to imagine that anyone would have the slightest difficulty in using the system.

As in Hulk, there are two main stages to using Expert-Ease. In the first stage, you give the program some examples of the

```
rainfall
<2 : nanteap
  <16 : rainfall
    <1 : nanteap
      <15 : nanteap
        <13 : nanteap
          <4 : sunshine
            <7 : yes
              >7 : no
                >4 : sunshine
                  <6 : nanteap
                    <5 : no
                      >5 : yes
                        >6 : yes
                          >13 : no
                            >15 : yes
                              >1 : no
                                >16 : no
                                  >2 : sunshine
                                    <4 : yes
                                      >4 : sunshine
                                        <5 : nanteap
                                          <3 : yes
                                            >3 : rainfall
                                              <4 : yes
                                                >4 : no
                                                  >5 : yes
```

Figure 2. Expert-Ease induces rules from raw data you supply to it.

problem you wish it to work on and, from them, a series of rules is developed to distinguish between different classes of objects. In the second stage, these rules can be applied to new data to help you draw conclusions from it. Unlike Hulk, Expert-Ease does not leave you to your own devices when it comes to dreaming up the appropriate rules. Expert-Ease does this automatically using non-parametric methods.

Expert-Ease offers four main screens. The File screen shows the names of all the problems held on disc to date; the Attribute screen is used to define the variables to be used in any given problem; the Example screen is used to input examples from which Expert-Ease will build up its discriminatory rule set; and the Rule screen is used to display the rules which Expert-Ease has developed for your problem. The screens are pretty well self-explanatory for the user. You kick off by defining the variables involved on the Attribute screen and giving some examples on the Example screen. You can then look at the rules which Expert-Ease has drawn up for you on the Rule screen.

Refinement

You can refine the rule by adding small sections of text here to turn them into a neat query system which will interrogate the user interactively on a novel problem of the type you have just defined. An enquiry system is then generated automatically by Expert-Ease, and from then on you have your very own expert sitting on your desk ready to work on any example of this type of problem you might want to give it.

On booting the system you are first shown the File screen displaying all current problems held on the disc. If you want to start a new problem key A to enter the Attribute screen, where you can start to define it. Like the other screens in this package, the Attribute screen is made up of a series of cells in a VisiCalc-like structure which is as easy to manipulate.

You start by entering headers across the top of the screen to define the variables. For the Bird/Plane problem they are Wings, Engines and Object. For each of these variables enter values which the variables can take: Wings can take the values Yes or No, as can Engine: Object can take the values Bird or Plane.

The right-hand column is always assumed to be the hypothesis under test; in this case the hypothesis is that the object is either a bird or a plane. The preceding columns can refer either to logical or integer values. In this case all of the variables are assumed to be logical because entering values Yes or No indicates the finite range of possibilities for these variables. If you do not enter any values for these variables the system assumes them to be integer variables in the range 32,768 to -32,768.

(continued on next page)

(continued from previous page)

Key E to enter the Example screen. In this case you enter a couple of examples — a bird and a plane — showing that a plane has wings and an engine whereas a bird has wings and no engine. When you key ! Expert-Ease sets about inducing a rule by which it can tell the two objects apart.

Keying R takes you to the Rule screen, where you can see the induced rule. It looks good: the rule only considers the variable Engine, and decides that if it has one it's a plane and, if it doesn't it's a bird.

Now key Q to enter the query system, which runs this miniature expert system interactively. Each time you run it it asks if the object has an engine or not and, depending on the answer, pronounces it to be a bird or a plane accordingly.

To return to the File screen, key F. You can Save this problem so that it will appear on the File screen as one more area of expertise for Expert-Ease.

Rainfall

A similar procedure is followed for the rainfall-prediction problem. An Attribute screen shows the variables Mintemp, Maxtemp, Rainfall, Sunshine and Raindue. The first four variables are integer variables as they could take any numerical value: the hypothesis under test, in the last column, is a logical variable which takes only the values Yes or No.

The sample values are entered on the Example screen. They are the same examples that were given to Hulk, truncated to integer values. Reals are accepted neither by Expert-Ease nor by Hulk, so the test remains the same for both products. When all the data has been entered, key ! and sit back for a minute or so while the machine tries to unravel the complexities of weather forecasting and induce a rule. Then key R to look at the rule it has induced — see figure 2.

At this point two distinct points emerge. I was genuinely surprised that Expert-Ease managed to induce a rule for this data without blowing a fuse in the process. The thinking behind Expert-Ease is that there is a definitive rule which will correctly classify every object given to it as an example. With such a diffuse problem as weather forecasting, this is no mean feat.

Common sense

There is a marked similarity between the induced rule and rules which might have been suggested by common sense — which is a virtue, not a fault. The first item it always looks at is the question of Rainfall. If it is less than 2mm, it passes into one section of the decision process; if it is greater than or equal to 2mm, it passes to another section. The rule which Hulk liked made a decision on the basis of rainfall being greater than 1mm, or not. Both rules correspond with the common-sense knowledge that rain tends to go in spells. Expert-Ease has produced, of its own

accord, something which seems eminently sensible.

Some nice points emerge from Expert-Ease's rule. For instance, if rainfall is greater than or equal to 2mm, and sunshine is greater than or equal to five hours then it will predict rain. These figures are for March weather, and you can almost see the sunny, rainy days that Expert-Ease seems to have in mind. Or consider the case of rainfall less than 2mm, and maximum temperature greater than or equal to 16°C, you can envisage a dry, warm day, rather settled weather for which Expert-Ease would predict a dry day to follow. The rules which Expert-Ease has induced are undoubtedly interesting in themselves, and studying them might well help to throw light on the underlying situation.

Keying Q to enter the Query system, and entering the data for March's weather again gave a 100 percent accurate prediction of every day's weather. However, running the same query system on fresh data — in this case the weather figures for the following month, April — gave less than perfect results.

Expert-Ease then made 18 correct predictions out of 29 — a score of only 62 percent. With a much simpler rule, Hulk was right in 28 out of 29 days.

Testing the two systems with the same type of problem helped to produce a comparative review, but there are differences in the type of problem to which each is most suited. Expert-Ease can show you what problems it is intended for if you run one of the expert systems supplied with it called Problems.

Suitability

Running Problems on the Bird/Plane problem suggested that this problem was suitable. Running Problems on the weather-forecasting problem suggested that Expert-Ease would not have been suitable in this case. "You will get an unacceptable level of wrong answers because your examples do not cover enough situations". It is a fair piece of advice to give when it comes to predicting the weather from only one month's data.

Clearly Expert-Ease would excel on

problems which have strictly defined conditions associated with them. To get the most for your money, these conditions should be previously unknown to you. Examples might include the problem of working out a suitable testing schedule for a quality-control process, or generally unravelling some problem which is intrinsically separable — unlike weather prediction — but for which you are unsure about the exact method that might be used to separate the items.

For really complex processes Expert-Ease can unravel rules in situations with up to 31 variables, each of which can have either integer values or a maximum of 255 logical values. It is possible to give it up to 30,000 examples to work from. At the end of the process you have a tailor-made interactive expert system which can be copied on to another disc and given to a naive user, who can then become an expert.

Conclusions

- Both Hulk and Expert-Ease are revolutionary in the micro market-place. They assist the user in carrying the discrimination tasks which are at the heart of any expert system.

- Both packages use non-parametric methods which would be broadly applicable to any sets of data, and both work by establishing a rule set from given examples.

- Hulk does not discover discriminant rules for you, it merely makes it very easy for you to test out rules which you think might have some bearing on the case. Expert-Ease, on the other hand, will look for rules, and tries to give perfect results.

- Hulk essentially works in batch mode. You set up files of data and then run the programs on these files. Only the development of the rules is a genuinely interactive process between machine and user via the screen. This makes it more suitable for problems in which reasonably large sets of data are to be examined at one go, rather than for casual enquiries.

- Expert-Ease is interactive in its operations from the start. It is extremely user-friendly and lets you develop a stand-alone expert which can be run on a very casual basis.

- Neither system allows the use of real variables as data. It is not immediately apparent why this should be the case, although most reals could, in practice, be turned into integer values by suitable scaling.

- If Hulk were a little more interactive in the inputting of data and had a query system comparable to that of Expert-Ease as its end result, it could be sold at a much higher price. It is thoroughly recommended, very interesting and likely to undergo continual enhancement.

- Expert-Ease costs nearly 30 times as much as Hulk. It is a very substantial system which is easy to use — and if it were to divide its price by 10 could become a best seller on a par with VisiCalc. □

Suppliers and prices

HULK
Supplied by: Brainstorm Computer Solutions, 103A Seven Sisters Road, London N7 7QN.
Runs on: BBC Model B, Torch
Price: £25

EXPERT-EASE
Supplied by: Export Software International Ltd, 4 Canongate Venture, New Street, Royal Mile, Edinburgh EH8 8BH.
Runs on: IBM PC, Sirius 1
Price: £1,725, VAT included

The low cost LAN with all the right connections

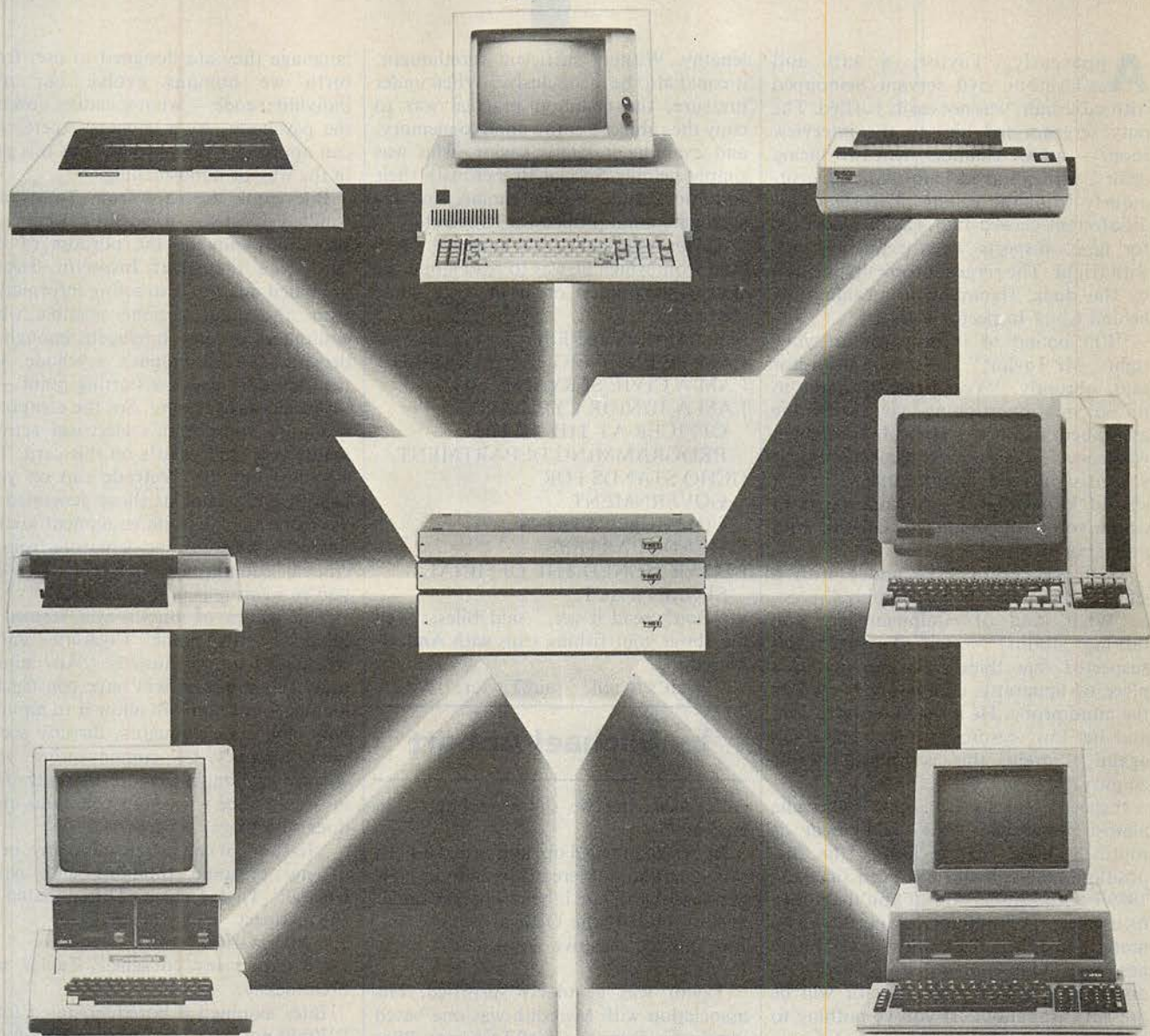

If you thought Local Area Networking was beyond your budget, take a look at V-NET.

Simplicity itself to use, V-NET cuts the cost of micro networking to give you a system that is not only affordable – but so flexible too.

V-NET utilises the standard RS 232C interface and is therefore totally machine and operating system independent. Users may transfer files either directly or via the V-NET fileserver, share printers and plotters or access mini and mainframe computers.

An 11 MHz microprocessor and 2K memory buffer for each port allows data rates to be mixed and ensures that there is no degradation of performance, regardless of system

usage. With V-NET, your network can start with just four ports, and expand up to 32.

Also V-NET "stacks" may be linked together to form larger networks, or alternatively V-NET will let you access any global network via a modem link, or other LANs – like Ethernet or Cambridge Ring.

To find out more about how V-NET will make your micros more efficient, contact one of our distributors and discover an easier, more cost effective solution to your business communications.

MBS Personal Computers. Windsor (07535) 68171
Midlectron Distribution. Head Office: Belper (077 382) 6811
London Office: (01) 481 9919

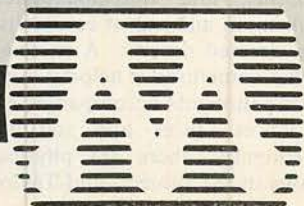

MIDLECTRON SPECIAL PRODUCTS

Mind probe

Apparently, Taylor, a tall and cadaverous civil servant bemopped with sable hair, was not easily ruffled. The duty sergeant led him to the interview room — a bare chamber with two facing chairs, with a naked lamp hanging grotesquely from the ceiling. The stench of disinfectant clawed into Taylor's nostrils; for here, suspects were frequently sick with fright. The sergeant took up position by the door, slamming it meaningfully behind Chief Inspector Biles.

"I'm bound to inform you of your rights, Mr Taylor," the stubby inspector said, abruptly. "You have the right to refuse our questioning you with the assistance of any technical equipment whatsoever, even a tape recorder. But if you insist on a conventional interview, you should know that I am empowered to detain you until completely satisfied with your statement.

"Off the record," he added with a smirk, "this could be indefinitely."

"What kind of equipment are you talking about?" said Taylor, who suspected that Biles was referring to a piece of apparatus commonly known as the mind probe. He resisted intimidation, and his low, resonant voice started up again. "Surely, this is only a simple enquiry?"

Inspector Biles's frail quaver became almost defensive, "All equipment is routinely used, sir, including the disposition analyser, and has been since the 1989 Police Powers Act. If you'll agree to its use, sir, the full interview need take no more than 15 minutes, and there'll be no need to trouble your solicitor. There's no discomfort, and a police doctor will be present throughout. If you've nothing to hide, you'll consent."

Biles became impatient. Why detainees needed to deliberate was a mystery to him. After all, he had made it clear that the conventional alternative would be stretched so as to detain Taylor beyond endurance.

Taylor had barely consented when the equipment trolley was wheeled in, accompanied by a female doctor offering a mawkish smile. The transferral to a reclining couch, and the fitting of a hideous electrode cap, fractured Taylor's composure. His voice became as taught as a child's. "Let me get this straight. This machine merely extracts answers to your specific questions?"

"Something like that," Inspector Biles twanged, buoyantly.

The doctor raised an eyebrow. The approved procedure was inconvenient and

lengthy. Without sufficient forethought, it could also be inconclusive. When under pressure, the common practice was to copy the subject's entire mind to memory, and examine it later. Taylor, who was simply helping Special Branch with their enquiries, could be sent home, and his surrogate mind probed for its secrets.

Taylor was shown an unwieldy black card from which he was to read aloud the statements printed on it in large white characters.

MY NAME IS JEREMY TAYLOR
I AM TWENTY-EIGHT YEARS OLD
I AM A CIVIL SERVANT
I AM A JUNIOR CYPHERS
OFFICER AT THE GCHQ
PROGRAMMING DEPARTMENT
GCHQ STANDS FOR
GOVERNMENT
COMMUNICATIONS
HEADQUARTERS
I HAVE SIGNED THE OFFICIAL
SECRETS ACT

"Don't read it yet," said Biles, "Tell me about your fishing trips with Andrew Meredith."

"What's to tell?" said Taylor. "We are

by Michael Abbott

colleagues, and we share an interest in angling."

Biles straightened up, and issued a stern proclamation, "Meredith is here in New Scotland Yard, and is being charged under Section One of the Official Secrets Act, for leaking sensitive information to a foreign power."

Taylor was genuinely surprised. His association with Meredith was one based purely on fishing. Chief Inspector Biles resumed his all-knowing smirk. "Long boat trips, eh? Ideal for exchanging information and ideas without being bugged. Surveillance is difficult, even for the security services, when you're sitting in a row-boat in the middle of a lake."

Taylor twitched. Not at the accusation, but because the probe had been activated. Biles handed him the big black card. "Read it!"

Taylor read it, and then repeated the alphabet three times, as requested. Chief Inspector Biles explained, "As a computing and cyphers operative, perhaps an explanation will not be wasted on you, Mr Taylor." Biles lit a cigarette before continuing, "You see, the problem with reading a person's mind is that everyone thinks with a language of their own. Unlike computers, which think with the machine

language they are designed to use, from birth we humans evolve our own individual code — what scientists now call the psychode. As a cyphers expert, you can appreciate the obstacle that this puts in the way of mind-reading."

Biles took the card from Taylor and fondled it absent-mindedly. Taylor insisted on knowing the purpose of this card, and the Chief Inspector became animated again. "Extracting information from the mind became possible when computers became intelligent enough to decypher an individual's psychode. But the computer needs a starting point — a set of clues, as it were. So, the computer, monitors your brain's electrical activity whilst you read what's on this card. The signals from the electrode cap on your head are the same as those generated by electroencephalograph equipment used in hospitals. There is one departure from its clinical counterpart, however. The cap you're wearing is bi-directional."

The whites of Biles's eyes seemed to bloat at this point. Cigarette smoke streamed from his nostrils. "Any minute now, this machine will have constructed an algorithm that will allow it to monitor your conscious thoughts, directly access your memory by circumventing your conscious thoughts, and evoke memories in order to see what your conscious mind does with them."

"In short, it can help itself to any, or all of my personal thoughts and experiences?" Taylor croaked, humiliated by the prospect.

"Affirmative!"

"I retract my consent," Taylor said breathlessly.

Biles assumed a bored, irritated tone, "Fraid not, sir. You've signed the form. If necessary, I can use restraint." He summoned the sergeant as a show of force.

Phase two of the mind probe commenced. The subject's mouth hung open as the soporific tingling sensation intensified. He heard the computer's voice somewhere in his mind, saying blandly, "Relax, Mr Taylor. Just relax."

The experience is not one that can be meaningfully related, save to say that images, sounds, and long-abandoned memories spring in and out of consciousness like accelerated dreams. A peculiar awareness that something is helping itself to your private thoughts accompanies the waves of voices, faces and startling visions. Frequently, there are physical manifestations in the subject, and Taylor

was no exception. He began talking to himself, then he cried out, sang, and laughed heartily. The doctor mopped saliva from his chin. It was a sight that disturbed even Biles.

When the probe was completed Taylor slept for three or four hours. By the time he awoke, Biles and the sergeant were at the probe console, studying their detainee's mind. Taylor's weaknesses and strengths, be he incriminated by the probe or not, would be passed on to New Scotland Yard's database.

Music floated down the corridor behind the sergeant, reaching Taylor's ears as the officer entered bearing a cup of tea. "Doctor says you can go as soon as you feel up to it," the sergeant said. "I must compliment you on your memory for music, sir. It's just like listening to the real thing."

As Taylor left, the sergeant was recalled

to the console. Biles had become excited about something.

"Usual thing until now, sergeant," Biles was pointing at the screen. "Likes golf and fast cars. Thinks his wife is sexually boring. Fancies himself at squash. But look at this one. She's a hooker. Our friend goes on regular sorties into the Earls Court red light district."

Biles rubbed his chin angrily. "Guys like Taylor are time bombs waiting for a subversive somewhere to light their fuse. He's wide open to corruption. I'm going to ask the computer to set up a scenario. Mark my words, sergeant, you're about to see Taylor sell a state secret — not for money, nor in the face of violence, but for services rendered. I'm going to arrange a seduction, and see Taylor move in."

"Not Taylor, sir, but his surrogate," the sergeant added plaintively. "It all happens inside the computer, not in real life."

"Same thing," said Biles. "The computer is capable of simulating Taylor's decision-making processes. After all, a human being's thinking is conditioned entirely by his experiences, and our computer has all of Taylor's experiences at its disposal. The Taylors of this world are law abiding by default. They are circumstantially innocent. Anyone who is potentially willing to commit a crime at the right price is a criminal."

The sergeant found his superior's attitude distasteful. "Hardly fair, sir. The computer can romp around Taylor's memory seeking out his weaknesses and fears. What chance would any human stand? So what if he performs as you suspect, sir? He can't be charged. He the right price is a criminal."

"No, but he'll cease to be a civil servant. In fact, he'll never hold a position of trust again. Either way, sergeant, the information concerning personality will be secured with Scotland Yard, and surveillance will do the rest."

The sergeant cleared his throat in readiness to make an impertinent remark. "Are you sure such information would not be more secure left inside Taylor's head, sir — how secure is New Scotland Yard's database? I've heard worrying stories about unauthorised taps. If they're true, we could actually be giving our adversaries a leg-up."

Chief Inspector Biles gave the young sergeant a long, hard look, before replying. "You've been with Special Branch five minutes, sergeant. What makes you think you're in a position to improve the procedures already? I'd be interested to hear. I don't care what you've read in the fringe press, you can take it from me, no one accesses police or government databanks without authorisation. No one. Every precaution is taken."

Taylor was about to sip his coffee when he heard a noise in the hall. More mail? He switched off the TV, yawned, and went to the front door. There on the mat was the now commonplace pile of envelopes which he would have to sift through before his wife became curious.

Three envelopes contained exotic fun-ware catalogues; one other a West End contact magazine. There were also two golfing accessories special offers and a magazine for sports car owners. He rolled up the saucy brochures, furtively poked them into his dressing-gown pocket, and returned to the kitchen. There he sat with his toast and marmalade, reading the sports car journal.

Since the police enquiry, Taylor had been dismissed from his job in Cheltenham, and had become the target of numerous commercial enterprises that seemed to know an awful lot about him. He had his suspicions, but like the others to whom this had happened, it was prudent to remain silent. □



CAMEL PRODUCTS

BLOPROM-81
A uniquely sophisticated
EPROM
PROGRAMMER

In use at various labs incl. Sinclair Research

Eprom programmer for the 2516, 27XX single supply families, yes, even the 27128 from Intel. Check, Read, Program + Verify all or part of Eprom.

So immensely user friendly you'll hardly need the manual. Designed for the beginner but includes a single key entry route for the professional. Supplied as firmware, the m/c driver routine alone is worth more than the price of BLOPROM-81. No Personality

Cards, or other additions, just a ZX81. Several inbuilt safety features. On-board Vpp generation. 28pin ZIF socket. Cabled connector and extender plug. ABS case.

Note: Can provide up to 36 inputs or 40 outputs as an I/O £79.95

Note: A Spectrum version of this very popular instrument will be released in 1984.

DREAM-81

A 64K with extras

Full 64K Rampack with link options to disable 0-8-16K. Plus a 28 pin EPROM socket for 2716, 2732/2764 and even the latest 27128 from Intel. Fast/slow Eprom option, professionally built and tested. In an ABS case with an LED indicator. £59.95

PROMER-81

At last! A low cost reliable programmer for 2516/32, 2716/32 EPROMS. This is the solution to using EPROMs instead of tape. Requires 4xPP3 batteries for a regulated 25 volts. Remarkably priced at £19.95

PROMER 81-S

The very popular PROMER-81 for the ZX81 has been adapted to the Spectrum, and the price kept low. £22.95

PROMER-SP

A brand new Spectrum programmer for 2764/128. Zero insertion force socket & software on tape. Delivery Jan. 84. Order now at £29.95

ROM-SP

Ingenuous unit for Spectrum, with 2x28 pin sockets and a Reset button allows up to 16K of Basic or M/C program to RUN or LOAD instantly from EPROMS. Cabled connector and full extender card. NOTE: Does not disable Sinclair ROM. £29.95

ROM-81

Provides two 24 pin sockets for up to 8K of EPROM memory in the 8-16K area. Can use 2516/32 or 2716/32 £14.95

MEMIC-81

A 4K CMOS RAM and lithium battery unit. Easy SAVEing, 10yr storage and instant retrieval of programs. Resides in 8-12K or 12-16K of ZX81. £29.95

CRAMIC-81

Ingenuous hardware/software allows this 16K CMOS RAM with lithium battery to CO-exist in same memory area as ordinary RAM. ZX81 can multitask on two completely independent programs. £79.95

PIO-81/PIO-SP

Rugged TTL user ports for ZX81/Spectrum. 8 Inputs + 8 Outputs on 16 pin sockets. Mating plugs are supplied. £14.95/£18.50



PRINTER/MONITOR ACCESSORIES

MSB Monitor Stand for BBC micro. Sits over the Beeb 17"X12"X3.75" P&P £3.50 £19.95

PSS Standard printer stands for OK1. Epson etc. 15"X12"X4.5". P+P £3.50 £16.95

PS1 Large model 17"X14.5"X3.75" P&P £3.50 £19.95

PSC-3 for Epson MX-100 etc. 21"X14"X3.75". P&P £3.50 £22.95

CUSTOM PRINTER STANDS for larger printers P.O.A.

POT Printer Output Tray for 11" fanfold paper P&P £3.50 £16.95



UK. VAT extra. No VAT on exports P+P UK. Free Europe +5% - Overseas +10% TLX 81574

Cambridge Microelectronics Ltd, One Milton Rd, Cambridge, CB4 1UY Tel (0223) 314 814

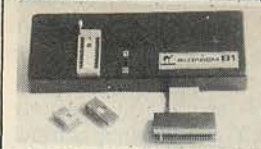

STATUS NO. OF SYSTEM —HEX
EPROM TYPE —27128
RAM START ADDR —4000
EPROM ST. ADDR —0000
JOB LENGTH —4000
TASK —CHECK

WHICH TASK DO YOU WISH TO DO
W) CHECK THAT EPROM IS CLEAN
X) READ THE CONTENTS OF EPROM INTO RAM
Y) BLOW AN EPROM WITH DATA FROM RAM
Z) VERIFY THAT EPROM DATA IS THE SAME AS IN RAM
Q TO QUITR TO RESTART

FAST CODES AVAILABLE:
D H PQR WXYZ

TH
THE TEXT HANDLING PACKAGE
for programmers

ADD UNLIMITED TEXT TO CP/M-80 PROGRAMS !

The TH package allows the machine instruction parts and the text parts of a program to be stored in separate files. Menus, sign-on messages, help and error messages will often account for up to 50% of a program's size: one screen of text occupies almost 2k bytes. TH frees up this space by allowing text to be held in a separate random access file, to be accessed as required by the program. The advantages of this are —

- * The program is smaller, reducing the need for chaining or overlays and also providing more space for data
- * Messages for the user can be as long and as frequent as required, irrespective of memory size. (How often have you found it necessary to cut down the size of help messages as your program grows in size?)
- * Compiling time is reduced, as text is not being 'compiled'
- * Text may be prepared on a wordprocessor, bringing 'What you see you get' to programming
- * Text may be modified without re-compiling the program

TH works with programs which are compiled initially to a relocatable format: currently MBASIC, Pro Pascal and MACRO-80 compiler formats are catered for in the package.

TH consists of:

- a text arranger (written in C) to convert ordinary text files to random access files
- relocatable subroutines (written in 8080 assembler) which can access the individual messages

Up to 64 messages per file are separately accessible; the size of the message is limited only by disk capacity. Full instructions are provided for linking and calling the subroutines.

PRICES (including postage)

TH package, including user manual £35
User manual only £10
Complete source code (hard copy & disk) £50

In addition to 8" SS/SD, most 5" formats are available, including Apple, Cromemco, MZ80K, Nascom, Osborne, QX-10, Rainbow, Fair, RML, Shelton, Superbrain & Tuscan. (Please specify density and number of sides).

Write to:
Y-Software Limited
34 Watson Road
Killiney
Co. Dublin
Ireland
Tel: 854250



FREE
DESCRIPTIVE
LEAFLET
AVAILABLE

• Circle No. 164

FACIT
4510



The Facit 4510 Low Cost 80-column Serial Matrix Printer is a thoroughbred micro printer. Engineered for quality and professional computer outputs. Smart, versatile, three way paper handling, block and pin graphics secure optimum system performance.



FACIT

Facit, Maidstone Road, Rochester, Kent ME1 3QN. Telephone: Medway (0634) 401721/7.

• Circle No. 165

• Circle No. 163

VER-WORD

THE ULTIMATE WORD PROCESSOR

For your CP/M™ Microcomputer

Write now for a full specification brochure.



VERWOOD SYSTEMS
Verwood House
High Street,
West Haddon,
Northants NN6 7AP.

CP/M™ is a registered trade mark of Digital Research, Inc.

● Circle No. 167

A USER-EXTENDABLE BASIC WITH INBUILT SELF-PROGRAMMING CAPABILITY

XTAL BASIC 3 comes with over 110 commands and functions which the user can easily extend - using his own vocabulary.

XTAL BASIC 3 contains its own on-screen editor, independent of VDU or terminal, allowing fast, easy access and modification to programs.

XTAL BASIC 3 permits variables of any length, multi-DIM arrays, string arrays, integer arrays.

XTAL BASIC 3 handles all **TAPE** and **DISC** filing. It has extensive user benefits, including:

- ★ applicable to CP/M & Z-80 systems software
- ★ 32 error-trapping messages, extendable
- ★ compatibility with other BASICs
- ★ 12K/24K size (according to system)
- ★ large and growing range of software

XTAL BASIC 3 - cassette version £40.00
disc version £60.00

Full details are available on request. Licenses are available to manufacturers and software houses at highly competitive rates. VAT should be added to the above prices on all UK orders.

Phone, write or call
Crystal Research Ltd,
40 Magdalene Road, TORQUAY,
Devon TQ1 4AF
Tel: Torquay (0803) 27890.



XTAL BASIC are devices owned and used by Crystal Group companies.

● Circle No. 166

If you want it tomorrow . . .
call us today
01-455 9823

COMPUTER/CALCULATORS

HEWLETT PACKARD		HP 16C (Hex Con)	£84.00
HP 4 1C (Comp Cal)	£129.95	HP 15C (Adv Sci)	£84.00
HP 4 1C (Card Reader)	£129.95	HP 75C (Portable)	£650.00
HP 4 1CV (SCI Comp Cal)	£176.00	HP Plotter 747A RS232 or HP1B	£832
Printer 82143A	£230.00	HP 75C portable cassette drive	£290.00
Printer 82162A	£300.00		
SHARP		New HP 150 personal office computer terminal unit or upgradable with disc drives to 14.7M bytes	£2300.00
PC 1500 Pocket Computer	£130.00		
CE 148 RS232 and Cent I/F	£130.00		
CE 158 printer cassette I/F	£115.00		
CE 159 8K Add on mem with BATE	£79.00		
CE 152 Cassette	£36.00	Epson QX-10 (desk top comp)	£1700.00
MZ-711 Computer	£199.00		
MZ-711 Printer Plotter	£110.00		
MZ-8080AEU Exp Unit	£86.00		
MZ-80A 48K Computer	£380.00		

WORD PROCESSING PRINTERS

NEC 2000		BROTHER*	
(RS232 or Centronics)	£650.00	HR1 *Highly Recommended*	£598.00
7710 RS232/7730 Centronics	£1650.00	Serial or Centronics -	
Tractors, Sheet Feeders and Paper Guides for NEC, Ex-Stock		HR15 (3K Buffer 13 CPS)	£399.00
		HR25 (3K Buffer 25 CPS)	£715.00
UCH IDA 305 (18CPS)		DIABLO 630*	
Low cost daisywheel	£375.00	620(RO)	£550.00
QUME		630(RO)	£1750.00
9/45 RO-FFP	£1650.00	630 API - RO	£1200.00
9/55 RO-FFP	£1999.00	630(KSR)	
11/40 RO (Also IBM-PC)	£1225.00	Tractor (Bi-Di)	£136.00
		FUJITSU	
TEC STARWRITER*		Model RP 1300 (S) (4K Buffer)	£990.00
F10-55 CPS (serial/parallel)	£1350.00	Flowriter (8K) PR 1600	£1450.00
Tractor (Bi-Di)		IBM-PC Version	£1500.00
Sheet Feeder		Mechanical Sheet Feeder	£475.00
Mechanical Sheet Feeder		Tractor Feed	£175.00
OLYMPIA*		RUTISHAUSER	
ESW 103	£899.00	Sheet Feeders and Tractors for: Qume, Diablo, NEC, Ricoh, TEC Starwriter, Olivetti, etc. From	£99.00
TOSHIBA		RICOH*	
The all-in-one speed - Word Processing/Draft/Data Processing printer using a - 24 wire printhead to give exceptionally high letter quality output		Model RP 1300 (S) (4K Buffer)	£990.00
		Flowriter (8K) PR 1600	£1450.00
		IBM-PC Version	£1500.00
		Mechanical Sheet Feeder	£475.00
		Tractor Feed	£175.00

PHONE US FOR BEST DEAL

DOT MATRIX PRINTERS

OKI*		SEIKOSHA GP700A	
M82A (120 CPS)	£295.00	Colour	£378.00
M92P (160 CPS)	£425.00	GP-100A	£210
Tractor	£50.00	(RS232 Option)	£63
M83A	£499.00	GP-100 (VIC 20)	£175.00
(120cps Friction, removable Tractor and RS232 and Centronics Parallel as standard)	£695	GP-250X	£220.00
M84A		EPSON	
ANADEX*		Epson RX80 (100cps)	£245.00
DP-900 B/B	£850.00	Epson FX80 (160cps)	£350.00
DP-9500 B/B	£893.00	Epson RX80FT	£260.00
DP-960 B	£999.00	Epson MX100 Type III	£399.00
DP-9625 B	£1155.00	Keyboard	£210.00
		Epson FX100FT (160cps)	£487.00
		BROTHER	
		EP22 Portable Printer/Typewriter/Calculator	£165.00

STOP PRESS NOW IN STOCK IBM/PC
IBM/PC SUPPLIED ON VERY COMPETITIVE TERMS. ALSO AVAILABLE EXTENSIVE RANGE OF SUPPORT HARDWARE/SOFTWARE

EPSON HX20 Briefcase computer. Weighs less than 4 lbs. 16K expandable. 64K Rom. 32K Ram. Full size ascii keyboard. Runs on own power for 50 hours. Complete Serial and RS232 interface. £350. Accessories & Software for Epson HX20 available from stock.

SOFTWARE

Word Processing APPLE		Word Processing IBM	
Applewriter 1.1	£55.00	Wordstar	£285.00
Applewriter 2	£85.00	Easywriter II	£230.00
Wordstar	£245.00	Volkwriter	£149.00
Applewriter IIe	£105.00	Mailmerge	£140.00
Word Processing SIRIUS		Easyspeller	£115.00
Supr. Calc	£140.00	Superwriter	£230.00
Multiplan	£149.00	Epson HX20	
Wordstar	£269.00	Word Processing	£85.00
Select	£265.00	M list (cassette)	£30.00
Mail Merge	£85.00	Epson QX10	
		Peach Text	£175.00
		Spell Checker	£95.00
		Mailing List Manager	£175.00

Other Software including Microsoft/Comsoft/BOS etc. also in stock

GOODS FULLY GUARANTEED
PRICES EXCLUDING VAT AND P + P.

Company and Government orders accepted by phone.
Barclaycard Access Visa accepted by phone.

Tel.: 01-455 9823

MOUNTAINDENE

22 Cowper Street London EC2

● Circle No. 168

BBC letter writer

With Peter Hodson's program you can prepare and print short documents without resorting to expensive commercial software.

THIS PROGRAM is designed to provide BBC owners with a "clever typewriter" suitable for home use. It performs straightforward text-processing functions on a Model B machine with a printer but no discs. The limitations of cassette-tape storage mean that the entire text file has to be held in RAM during processing, so it was necessary to resist the temptation of building too much into the program.

The following features were considered essential:

- an 80-column display;
- quicker and easier editing than the standard BBC Copy and Delete keys provide;
- support for special printer control codes, albeit rather limited ones on the Tandy Line Printer VII used while the program was being developed;
- ability to save and load text using named files.

A means of assigning commonly used strings to the function keys was also included. Features such as full-screen

editing, automatic justification and others found in full-scale word-processing packages were ruled out by the need to retain a reasonable amount of memory for the text. The program as it stands allows some 80 lines or more of text to be handled in a single file.

When the program is run, the first display selects whether a new file is being

Cnn — change line nn; includes deletion or reproducing with a different line number
Ann — add a new line nn, and renumber all succeeding lines
Lnn — list the text on the screen, starting from line nn
P — print the text on the line printer
S — save the text file
K — define the contents of function keys
E — end the program

Table 1.

set up, selection I, or an existing file loaded, selection L. In the latter case the file name is then input and the file is loaded.

The main display shows up to 20 lines of the text, with line numbers — which are not stored as part of the text — and an input line which is used to select all the remaining functions of the program. The functions available are shown in table 1.

Functions P, S, K and E have further menus to control their use. Functions C, A and L expect a line number; if one is not supplied, the program defaults to one based on the line number of the preceding function:

- for function C, the same line number is used;
- for function A a line number 1 higher is used;
- for function L a line number 19 higher is used, subject to not exceeding the highest line number in the file.

If no function code is entered the previous function is repeated with the default line

(continued on page 120)

Procedures

ProcStart, line 260. Sets up user-defined characters for the special characters ASCII 128-132 and 146; initialises some variables; determines whether a new file is to be set up or an existing one loaded.

Proclnit, line 440. Performs basic initialisation of the environment.

ProcLoad, line 510; and ProcSave, line 580. Load and save the text file.

ProcMsg, line 680. Receives a message as a parameter, which is displayed in reverse colours on line 21.

ProcList, line 720. Displays up to 20 lines of text on the screen, ensuring that the most recently processed line is within the displayed text.

ProcSet, line 820. Prompts for input of the function to be performed next and checks for a valid selection.

ProcAdd, line 940. Adds a new line to the text file, making space by shifting the array along one place. The new line is all blank.

ProcChg, line 1000. Creates a string in the work area addressed by W%, containing the line number and the text of the line. Prints this line at the bottom of the screen and positions the

cursor at the start of the text, c = 5, using a VDU 31 command. In the Repeat-Until loop in lines 1070 to 1190, a character is input from the keyboard and acted upon . The character is placed into the text string — except cursor-control keys, which do not affect the text — and the changed character is printed. Line 1150 is the process for the Delete key which closes up the text, and line 1160 for the Copy key which inserts blanks in the line. Line 1130 processes the Ctrl-f2 input and flags the start of the line with CHR\$146 to signal deletion of the line. When the Repeat-Until loop is complete, the changed line is usually replaced in the text. If the first position is flagged with CHR\$146 the line is deleted from the text array; if the line number has been changed it is added with its new line number, the old line remaining unchanged.

ProcCr, line 1300; ProcCl, line 1330; ProcDel, line 1360; and ProcDup, line 1400. These procedures are used by ProcChg.

ProcPrint, line 1440. The hard-copy print procedure. The line is actually printed by ProcPrintline, line 1610, which may need to be changed, depending on the printer being used. ProcPrintline

expects the string to be printed to be at the address in X%. It prints the string up to the first character which needs to be translated into special codes for the printer and outputs the codes relevant to that special character. It then updates the value of X% to point to the next character and calls itself again to continue printing the string. The printer codes may need to be changed for printers other than the Tandy Line Printer VII. In line 1740, 31 means switch to double-width characters; in line 1750, 30 means switch to normal-width characters; line 1820 prints a horizontal line for underlining; line 1830 prints a £ sign in dot graphics.

ProcEnd, line 1850. Allows the file to be saved and processing continued either with this file or restarted from scratch.

ProcDefkey, line 1900. Defines the function keys as required. A call to the OSCLI routine is used to assign the string variable to a key.

ProcRestart, line 2020. Not called from the program: used to restart the program if it terminates for any reason, by entering a command ProcRestart, which initialises the environment correctly without clearing any variables.

```

10 REM Text Processor
20 ONERRORGOTO200
30 MODE3:M%=87:WX=&D00
40 DIMt$(M%),sc$(5)
50 PROC_start
60 REPEAT:PROC_list:PROC_ms9("No of
lines: "+STR$(n))
70 REPEAT:PROC_sel
80 IFs$="A"PROC_add:PROC_ch9
90 IFs$="C"PROC_ch9
100 IFs$="L"t=i
110 IFs$="P"PROC_print
120 IFs$="S"PROC_save
130 IFs$="K"PROC_defkey
140 IFs$(">")E" PROC_list
150 UNTILs$="E"
160 PROC_end
170 UNTILs$="E"
180 RUN
190
200 IFERR=17 VDU3:CLS:PRINT"Press RE
TURN to continue, SPACE to end.":REPEAT
:a=GET:UNTILa=130Ra=32:IFa=13 GOTO60
210 VDU26:Q%=10:CLS:REPORT:PRINT" at
line ";ERL
220 *OPT
230 *FX4,0
240 END
250
260 DEFPROC_start
270 *FX226,128
280 *FX227,144
290 VDU23,128,65,65,73,73,54,0,127,0
300 VDU23,129,62,64,64,64,62,0,127,0
310 VDU23,130,72,36,18,9,18,36,72,0
320 VDU23,131,8,8,73,42,28,8,127,0
330 VDU23,132,255,0,0,0,0,0,0,0
340 VDU23,146,170,85,170,85,170,85,17
0,85
350 PROC_init
360 b$=STRING$(75," ") :f$=LEFT$(b$,8)
:s$="A"
370 sc$(0)=CHR$(128):sc$(1)=CHR$(129):sc$(
2)=CHR$(130):sc$(3)=CHR$(131):sc$(4)=CHR$(
32):sc$(5)="`"
380 FOR I%=1TOM%:t$(I%)=LEFT$(b$,68):
NEXT:i=0:t=0:n=0
390 CLS:PRINTTAB(24);"Text Processor"
;TAB(24);STRING$(14,"=")
400 PRINT"I - Init new text file""L
- Load text file""Press ""I"" or ""L
"".""Press ESCAPE to end.""
410 a$=FN$key("IL"):IFa$="L" PROC_loa
d
420 ENDPROC
430
440 DEFPROC_init
450 Q%=&303
460 *OPT1,1
470 *OPT2,1
480 *OPT3,10
490 ENDPROC
500
510 DEFPROC_load
520 b=0:REPEAT:VDU8:INPUT"File name",
f$:b=7:UNTILLENf$>0 ANDLENf$<11 ANDINST
R(f$, " ")=0
530 VDU28,16,22,63,19:CLS:f=OPENIN(f$
):n=0
540 REPEAT:n=n+(N(M%)):INPUT#f,t$(n):U
NTILEOF#f
550 CLOSE#f:t=1:i=1:VDU26:CLS
560 ENDPROC
570
580 DEFPROC_save
590 CLS:COLOUR0:COLOUR129:PRINT" Save
text "" :COLOUR1:COLOUR128
600 IFf$<=" "PRINT"File has no
name.":a$="N":GOTO620
610 PRINT"File name: ";f$;": OK? (<Y
or N):a$=FN$key("YN")
620 IFa$="N" b=0:REPEAT:VDU8:INPUT"Fi
le name",f$:b=7:UNTILLENf$>0 ANDLENf$<1
1 ANDINSTR(f$, " ")=0
630 VDU28,16,22,63,19:CLS:f=OPENOUT(f
$)
640 FOR I%=1 TO n:PRINT#f,t$(I%):NEXT
650 CLOSE#f:VDU26:CLS
660 ENDPROC
670
680 DEFPROC_ms9(m$)
690 COLOUR0:COLOUR129:PRINTTAB(0,21);
" ;m$; " ;:COLOUR1:COLOUR128:PRINTLEFT
$(b$,72-POS):VDU8
700 ENDPROC
710
720 DEFPROC_list
730 IFt<i-190Rt>i t=i+(i>1)+(i>2):IFt
>n-17 t=n+17*(n>19)
740 IFt<1 t=1
750 VDU26:CLS
760 FORI%=t TOT+19
770 PRINT:I%,t$(I%):IFI%>n I%=999
780 NEXT
790 IFs$="L" i=t+19:IFI%>n i=n-10
800 ENDPROC
810
820 DEFPROC_sel
830 PRINTTAB(0,22);"A-add C-change
L-list P-print S-save K-key def E-e
nd >":f=FALSE:b=7
840 REPEAT
850 PRINTTAB(60,22);" " :VDU8,
8,8,8,8:INPUT"i$
860 IFi$="" THENa$=s$:a=i-(a$="A")
ELSEa$=CHR$(ASCI#AND&DF):IFLENi$=1 THEN
a=i-(a$="A") ELSEa=VAL(RIGHT$(i$,LENi$-
1))
870 PRINTTAB(0,21);b$
880 I%=INSTR("ACLPKSKE",a$):IFI%=0 P
ROC_ms9("Bad selection "+LEFT$(i$,1)):G
OTO900
890 IF I%>3 THEN f=TRUE ELSE IF a>0
ANDa<=(n-(a$="A")) AND a<M% THEN f=TRUE
:i=a ELSE PROC_ms9("Bad line no "+STR#a
)
900 UNTIL f
910 s$=a$:s=i
920 ENDPROC
930
940 DEFPROC_add
950 IFn=M% n=n-1
960 FORI%=n TO1 STEP-1:t$(I%+1)=t$(I%
):NEXT
970 t$(i)=LEFT$(b$,74):n=n+1
980 ENDPROC
990
1000 DEFPROC_ch9
1010 *FX4,1
1020 *FX15,0
1030 REPEAT
1040 I%=1:IFI<100 I%=2:IFI<10 I%=3
1050 $W%=LEFT$(b$,I%)+STR#i+" "+t$(i
)+LEFT$(b$,75-LENt$(i))
1060 PRINTTAB(0,23);$W%;:c=5:VDU31,5
,23
1070 REPEAT
1080 a=GET
1090 PRINTTAB(0,21);b$;:VDU31,c,23
1100 IFa=9 a=133
1110 IFa=136 PROC_cl:UNTILFALSE
1120 IFa=137 PROC_cr:UNTILFALSE
1130 IFa=146 c=5:?(W%+5)=146:PRINTTAB(
5,23);CHR$(146):VDU31,5,23:UNTILFALSE
1140 IFa=145 ANDc>4 PRINTTAB(c,23);b$;
:$(W%+c)=LEFT$(b$,80-c):VDU31,c,23:UNTI
LFALSE
1150 IFa=127 ANDc>4 $(W%+c)=$(W%+c+1)+
" ":PRINTTAB(c,23);$(W%+c):VDU31,c,23:
UNTILFALSE
1160 IFa=135 ANDc>4 $(W%+c)=" "+LEFT$(
$(W%+c),79-c):PRINTTAB(c,23);$(W%+c):V
DU31,c,23:UNTILFALSE
1170 IF(a=32OR(a>47ANDa<58)OR(c>4ANDa
>31ANDa<135ANDa<>127) ?(W%+c)=a:PRINTTA
B(c,23);CHR#a;:PROC_cr:UNTILFALSE
1180 IFa<>13 ANDa<>144 VDU7
1190 UNTILa=13 ORa=144
1200 UNTILa=13
1210 IF?(W%+5)=146 PROC_del:GOTO1270
1220 x=VAL$W%:IFx<>1 THEN PROC_dup:IFc
=FALSE GOTO980

```

(continued on next page)

(continued from previous page)

```

1230 FOR I%=W%+79 TO W%+6 STEP-1
1240 IF I%=32 ? I%=13 ELSE I%=W%+6
1250 NEXT
1260 t$(i)=$$(W%+5)
1270 *FX4,0
1280 ENDPROC
1290
1300 DEFPROC_cr
1310 c=c-(c<78)-(c=3):VDU31,c,23
1320 ENDPROC
1330 DEFPROC_cl
1340 c=c+(c>0)+(c=5):VDU31,c,23
1350 ENDPROC
1360 DEFPROC_del
1370 IF i<n FOR I%=i TO n-1:t$(I%)=t$(I%+
1):NEXT ELSE i=n-1
1380 t$(n)="":n=n-1
1390 ENDPROC
1400 DEFPROC_dup
1410 IF x>n+1 OR x<1 OR n=>M%+1 PROC_lm9(
"Can't add line "+STR$(x)+" "):c=FALSE EL
SEC=TRUE:i=x:PROC_add
1420 ENDPROC
1430
1440 DEFPROC_print
1450 CLS:COLOUR0:COLOUR129:PRINT" Outp
ut to Printer ""':COLOUR1:COLOUR128
1460 PRINT"Press ""Y"" to continue, ""
N"" to cancel.""':a$=FN_key("YN"):IFA$=
"N" ENDPROC
1470 b=0:REPEAT:VDUB:INPUT"Left margin
(0-10)":LX:b=7:UNTIL LX>=0 AND LX<11
1475 b=0:REPEAT:VDUB:INPUT"Line spacin
g (1 or 2)":LSX:b=7:UNTIL LSX=1 OR LSX=
2
1480 b=0:REPEAT:VDUB:INPUT"Lines Per P
age (40-63)":PX:b=7:UNTIL PX>19 AND PX<
64
1490 Q%=0
1500 VDU2:PRINT:VDU3
1510 PRINT"Set Paper at a new Page an
d Press RETURN.":REPEAT UNTIL GET=13
1520 COLOUR0:COLOUR129:PRINTTAB(0,12):
b$:PRINTTAB(20,12):PRINTING -- Press
SPACE to stop":COLOUR1:COLOUR128:VDU28
,0,24,79,13,12,2
1530 FOR I%=1 TO n:W%=t$(I%):X%=W%:PR
INTTAB(LX%):Q%=Q%+1:PROC_printline:PRIN
T
1535 IF L$%=2 PRINT:Q%=Q%+1
1540 IF Q%>P% FOR K%=Q% TO 66:VDU10,1
3:NEXT:Q%=0
1550 IF INKEY(-99) I%=n
1560 *FX21,0
1570 NEXT:PRINT:***
1580 VDU3,26,12
1590 ENDPROC
1600
1610 DEFPROC_printline
1620 IF ?%>13 ENDPROC
1630 Y%=LEN($$X%)+1:Z%=-1
1640 FOR K%=0 TO 5
1650 A%=INSTR($$X%,sc$(K%)):IF A%>0 AN
DR A%<Y%:Y%=A%:Z%=K%
1660 NEXT
1670 PRINTLEFT$(X%,Y%-1)
1680 IF Z%=-1 X%=X%+LEN($$X%):ENDPROC
1690 ON Z%+1 GOSUB1740,1750,1760,1770,
1820,1830
1700 X%=X%+Y%
1710 PROC_printline
1720 ENDPROC
1730
1740 VDU1,31:RETURN
1750 VDU1,30:RETURN
1760 PRINTLEFT$(b$,10):RETURN
1770 FOR K%=1 TO L$X%:VDU10,13:Q%=Q%+1:
NEXT:IF Q%<P% OR X%?Y%=132 GOTO1800
1780 FOR K%=0% TO 66:VDU10,13:NEXT:Q%=
0
1790 Y%=Y%-1:REPEAT:Y%=Y%+1:UNTIL X%?Y
%<>131:Q%=X%+Y%-1
1800 IF X%?Y%<>131 PRINTSPC(LX%)
1810 RETURN
1820 VDU1,18,1,28,1,6,1,129,1,30:RETUR
N
1830 VDU1,18,1,232,1,188,1,202,1,201,1
,194,1,128,1,30:RETURN
1840
1850 DEFPROC_end
1860 CLS:PRINT"Save text? (Y or N)":a
$=FN_key("YN"):IF a$="Y" PROC_save
1870 PRINT"Finished with this file?
(Y/N)":a$=FN_key("YN"):IF a$="N" s$="L"
1880 ENDPROC
1890
1900 DEFPROC_defkey
1910 CLS:COLOUR0:COLOUR129:PRINT" Defi
ne Function Keys ""':COLOUR1:COLOUR128
1920 REPEAT
1930 PRINT"Press 0-9 to define key
f0-f9 (SPACE to end)":b=0:REPEAT:VDUB:a
$=GET$:b=7:UNTIL a$=" "OR(a$)="0"AND a$<=
"9"
1940 IF a$<>" " THEN PRINT"*KEY "+a$
+":"+W%="KEY"+a$:INPUT LINE $(W%+4):X%=W%
MOD 256:Y%=W% DIV 256:CALL&FFF7
1950 UNTIL a$=" "
1960 ENDPROC
1970
1980 DEF FN_key(v$)
1990 b=0:REPEAT:VDUB:a$=CHR$(GET AND &
DF):b=7:UNTIL INSTR(v$,a$)
2000 =a$
2010
2020 DEFPROC_restart:PROC_init:GOTO60:
ENDPROC

```

(continued from page 118)

number. Allowing the program to supply the next function and line number in this way enables many lines to be added or deleted, or the whole file displayed, without repeated keying of the function code or line number.

When functions C or A are selected the line to be edited is presented at the bottom of the display and the cursor is placed on the first character of the text. The cursor may be moved to left or right using the left and right cursor keys, and text at the cursor position may be overwritten.

The Delete and Copy keys operate somewhat differently from the normal BBC practice. Delete removes the character at the cursor position and shifts succeeding text to the left; Copy inserts a blank at the cursor position and moves succeeding text to the right. This is a simpler method of making small changes to text than the

BBC's usual editing method, and is similar to that commonly found on mainframe VDUs. It is much easier to use than to explain. A line may be copied to a new location in the text by overtyping the line number with the new line number.

The function keys are used to provide special functions, in combination with the Ctrl and Shift keys, as shown in table 2. The printer-control codes are those

required by the Tandy Line Printer VII; if the printer you are using responds to different codes the function keys must be programmed accordingly. Shift-f2 and Shift-f3 pack several short lines of text into a single line in the text file in order to save space. The shifted function keys are used to control printing; these codes would need modifying for printers other than the Tandy Line Printer VII.

Key	ASCII	Meaning
Ctrl-f0	144	Cancel the changes made to this line so far and restart the Change function
Ctrl-f1	145	Blank from cursor position to end of line
Ctrl-f2	146	Delete this line; sets the first byte in the edit line to a special character which will cause the line to be deleted
Shift-f0	128	Set printer to double-width character mode
Shift-f1	129	Set printer to normal-width character mode
Shift-f2	130	Print 10 blanks at this point
Shift-f3	131	Carriage Return Line Feed at this point
Shift-f4	132	Underline

Table 2.

No 1 source for software

SOFT OPTION SOFTWARE CENTRE

PHONE FOR YOUR FREE COPY OF OUR 1984 PRICE LIST

Make Soft Option your No 1. Chances are we'll have the right product, in the right format, in stock in quantity.

- Full technical support
- Friendly service
- **SAME DAY DESPATCH** Wherever possible



CP/M 80



CP/M 86



MS-DOS

and IBM PC Software



MACHINE FORMATS INCLUDE:

Software can be made available in 8 BIT or 16 BIT formats to suit most micro-computers currently on the market including:

IBM PC

Televideo ■ Sirius

North Star Horizon

North Star Advantage

Columbia PC ■ Superbrain

Apple ■ CP/M 8" ■ Rair



SOURCES INCLUDE:

We hold stocks of most software manufacturers including:

MICROPRO

MICROSOFT

DIGITAL RESEARCH

SORCIM

IUS

ASHTON TATE



RING THE SOFTLINE Grantham (0476) 860171

All products are supplied complete with full originator's documentation. Please send large s.a.e. for full details. TRADE ENQUIRIES WELCOME.



Soft option SOFTWARE CENTRE

The Soft Option (UK) Ltd. Home Farm House Colsterworth
Grantham Lincolnshire NG33 5HZ Tel: Grantham (0476) 860171

• Circle No. 169

Where to draw the line

Boris Allan offers help to frustrated Commodore 64 owners with a series of routines to tap their machines' graphics capabilities.

Listing 1.

```
1000 REM -----
1010 REM
1020 REM          GRAPHIC ART FOR THE C64
1030 REM
1040 REM          (C) BORIS ALLAN, 1983
1050 REM
1060 REM -----
1070 REM
9997 REM
9998 REM    C64 HIRES : INITIALIZATION
9999 REM
10000 GOSUB 11000 : REM ACTIVATE FUNCTIO
NS
10010 POKE 53265,PEEK(53265) OR 32 : REM
  ENABLE BIT MAP MODE
10020 POKE 53272,(PEEK(53272) AND 240) O
R 8 : REM POINT VIC-II CHIP
10030 FOR I=8192 TO 16191
10040 POKE I,0 : REM CLEAR BIT MAP
10050 NEXT I
10060 FOR I=1024 TO 2023
10070 POKE I,1 : REM WHITE BACK, BLACK P
LOT
10080 NEXT I
10090 RETURN
```

Listing 2.

```
10997 REM
10998 REM          C64 HIRES : FUNCTIONS
10999 REM
11000 DEF FNCD(Z) = 8192 + 320*FNCH(Y) +
  8*FNCH(X) + Y - 8*FNCH(Y)
11010 DEF FNCH(Z) = INT(Z/8) : REM ROW O
R COLUMN NUMBER
11020 DEF FNBI(Z) = 7 + 8*FNCH(Z) - Z :
REM BIT POSITION IN BYTE
11030 RETURN
```

Listing 3.

```
11997 REM
11998 REM          C64 HIRES : LINE CHOICE
11999 REM
12000 IF ABS(LX-NX) >= ABS(LY-NY) THEN G
OSUB 14000 : REM X IS FIXED
12010 IF ABS(LX-NX) < ABS(LY-NY) THEN GO
SUB 15000 : REM Y IS FIXED
12020 RETURN
```

HIGH-RESOLUTION graphics on the Commodore 64 permit a resolution of 320 by 200. The graphics are bit mapped, with each of the 64,000 locations represented by a bit in memory. The bits are grouped into bytes — that is, in eights — so a total of 8,000 bytes or almost 8K is required.

The first problem you encounter when embarking on graphics programming is to find 8K free from Basic in which to store the bit map. One obvious way is to raise the start of Basic to 16348 so that the 8K bit map can be located in the area from 8192 to 16383.

The start of Basic is changed by altering the value of the appropriate pointer, which is held at location 44. Inserting a zero into location 16384 tidies up and checks on the start of Basic programs. You change the start by altering the pointer, resetting the contents of location 16384 to zero. Then enter New to activate all the other pointers which are dependent upon the crucial Start of Basic pointer. The complete sequence is:

```
POKE 44,64:POKE 16384,0:NEW
```

which should be the first action on setting up the system. It should be done before you load any programs or do any ordinary programming.

The pointer to the start of Basic is contained in locations 43 and 44. The start is calculated by:

```
PRINT PEEK(43) + PEEK(44)*256
```

which is normally 2049. The value stored in location 43 is thus 1, and that stored in location 44 is normally 8.

One location before 2049 is 2048 and to
PRINT PEEK(2048)

is to find the result zero. By setting the value of location 44 to 64, the start of Basic becomes 16385, and the contents of the preceding location, 16384, becomes zero. You are now left with the portion of memory from 2048 to 16383 in which to store your bit map.

Bit map

To tell the Commodore 64 that you want to store the bit map from 8192 onwards you must address location 53272, used by the Vic memory-control register. The *Programmer's Reference Guide* published by Commodore discusses the location of character memory on page 104.

The bit map is nothing more than a

collection of characters, each of eight bytes. The bit map coincides with memory available for user-defined characters, and the full screen is made up of 40 columns and 25 rows of the eight-pixel by eight-pixel characters. If bits 3 to 1 of location 53272 are set to 100, then character memory is taken to start at 8192. To make this change enter

POKE 53272, (PEEK(53272 AND 240) OR 8)

To switch on the bit map mode, set bit 5 of location 53265 to 1. Location 53265 is the Vic control register, so you set bit 5 to 1 by

POKE 53265, PEEK(53265) OR 2^5

When you have switched into bit-map mode you have to set all bytes in the bit map to zero so as to clear the decks for plotting. You also have to set the colours needed for plotting. The colour for the bit map comes from the screen memory, normally stored from locations 1024 to 2023, and not the colour memory. The lower four bits of the byte corresponding to a character in screen memory set the colour of the high-resolution background. The upper four bits set the colour of the plotted pixels.

Colours

The colours are those normally associated with the Commodore 64. They range from 0 for black to 15 for grey 3 and are set by each 64-pixel character location. Pixels can only be coloured in eight-by-eight blocks; they cannot be individually coloured.

Subroutine 1000 sets up the high-resolution graphics system, once the Basic area has been set to start at 16385. The routine is more or less self-explanatory, apart from the call to functions in the subroutine at line 11000. It plots black pixels against a white background. The number Poked into locations in screen memory is 1, or binary 00000001; if you prefer a black background and white pixels Poke 16, or 00010000 in binary.

The three functions necessary for plotting in high resolution are collected together in subroutine 11000. They are called as part of the initialisation subroutine because all functions have to be defined explicitly before they can be used.

FNCH(Z) is used to work out the row and column of the character which corresponds to specified co-ordinates. The X co-ordinates range from 0 on the left to 319 on the right. If the X co-ordinate of a particular pixel is 115 this corresponds to a character in the column given by

INT(115/8)

which is column 14. The Y co-ordinates run from 0 at the top of the screen to 199 at the bottom. So 89 corresponds to a character in the row given by

INT(89/8)

which is row 11. Both columns and rows are numbered from zero.

There are 320 bytes per row, and eight bytes per column along the row. FNCO(Z) calculates the byte number/location for the

(continued on next page)

Listing 4.

```
13997 REM
13998 REM C64 HIRES : X COORD IS FIXED
13999 REM
14000 S = 0 : IF LX-NX <> 0 THEN S = (LY
-NY)/(LX-NX) : REM GRADIENT
14010 FOR X=INT(LX+.5) TO INT(NX+.5) STE
P SGN(NX-LX) : REM X IS NOW FIXED
14020 Y = INT((X-LX)*S+.5+LY) : REM DERI
VE Y VALUE
14030 P = FNCO(0) : IF P>8191 AND P<1619
2 THEN POKE P,PEEK(P) OR 2^FNBI(X)
14035 REM POKES 1 INTO BIT FNBI(X) AT AD
MISSABLE LOCATION P
14040 NEXT X
14050 RETURN
```

Listing 5.

```
14997 REM
14998 REM C64 HIRES : Y COORD IS FIXED

14999 REM
15000 S = 0 : IF LY-NY <> 0 THEN S = (LX
-NX)/(LY-NY)
15010 FOR Y=INT((Y-LY)+.5) TO INT(NY+.5)
STEP SGN(NY-LY)
15020 X = INT((Y-LY)*S+LX)
15030 P = FNCO(P) : IF P>8191 AND P<1619
2 THEN POKE P,PEEK(P) OR 2^FNBI(X)
15040 NEXT Y
15050 RETURN
```

Listing 6.

```
100 REM
110 REM C64 HIRES : EXAMPLE I
120 REM
130 INPUT "LX,LY"; LX,LY : INPUT "NX,NY"
: NX,NY : REM COORDINATES
140 GOSUB 10000 : REM INITIALIZE
150 GOSUB 12000 : REM DRAW LINE
160 GOTO 160
170 END
```

Listing 7.

```
200 REM
210 REM C64 HIRES : EXAMPLE II
220 REM
230 GOSUB 10000 : REM INITIALIZE
240 LX = 0 : LY = 0 : REM LAST COORDINAT
ES
250 FOR NX=20 TO 300 STEP 20 : REM SET N
X COORDINATE
260 NY = NX*NX/300 : REM CALCULATE NEW N
Y COORDINATE
270 GOSUB 12000 : REM DRAW LINE
280 LX = NX : LY = NY : REM RESET LAST C
OORDINATES
290 NEXT NX
300 GOTO 300
310 END
```

(continued from previous page)

co-ordinates X and Y, starting from memory location 8192. FNCH(Y) gives the number of the character row which contains the co-ordinate Y, which is multiplied by 320 to give the number of bytes before the present row.

FNCH(X) gives the number of the character column which contains the co-ordinate X. This column is then multiplied by 8 to determine the number of bytes in that row prior to that column. The final part of that line

$$Y - 8 * INT(Y)$$

works out how many bytes through the character is that Y co-ordinate.

The final function, FNBI(Z), is used to find the bit position within a byte in the character. The left-most bit is numbered 7 and the right-most is numbered zero, which is in the opposite sense to the co-ordinates. Just as the byte position in FNCO is calculated by

$$Y - 8 * FNCH(Y)$$

so the bit position is worked out by

$$X - 8 * FNCH(X)$$

and then subtracting that value from 7 to give

$$7 + 8 * FNCH(X) - X$$

The most important decision you have to make when drawing lines is whether to fix the X co-ordinates or the Y co-ordinates. In the Line choice subroutine at 12000 the system expects that the line starts at LX, LY and extends to NX, NY. The first of the two If statements is activated when the

difference between co-ordinates in the X direction is greater than or equal to the difference in the Y direction, otherwise the second If statement is activated. The first If makes a call to subroutine 14000, and the second calls subroutine 15000. Both subroutines are similar in operation, so to describe one effectively describes them both. The difference comes from whether the X axis or the Y axis is accentuated.

Gradient

Subroutine 14000 starts by setting the gradient S to zero. Subroutine 14000 concentrates on the X axis, so the first step is to find whether LX is equal to NX. If not, the beginning and the end of the line are at different points, and the next step is to calculate the gradient. If LX is equal to NX this step would involve division by 0.

The subroutine takes values of X from the rounded value of LX to the rounded value of NX in steps of 1, 0, or -1 depending upon the sign of the difference between NX and LX. For each value of X, it calculates the equivalent rounded value of Y, and then calls function FNCO to find the correct location number P. If P is within the limits 8191 and 16192 then a value is Poked into location P.

The value Poked is the already existing value in that location, Ored with $2^{FNBI(X)}$. Since FNBI(X) gives the number of the bit in the byte at location P, Oring with $2^{FNBI(X)}$ sets that bit number

to one and leaves the other bits unchanged. Drawing a line therefore you only need to call Gosub 12000, with values set for LX,LY and NX,NY. Nothing else is needed.

The program in listing 6 draws one straight line between specified co-ordinates, and is a useful way of checking on the workings of the system as a whole. The final line puts the machine into a waiting state without putting any prompt up on the screen which messes up screen memory.

You input the co-ordinates, then initialise the system by a call to Gosub 10000 and draw the line by Gosub 12000. This program is good for experimenting with reasonable and unreasonable co-ordinates to see what happens.

The program in listing 7 draws a parabola, though with modification other functions can be used. It starts at the origin, and the value of NX is increased from 20 to 300 in steps of 20. The corresponding value of NY calculated by

$$NX * NX / 300$$

A line is drawn to the new co-ordinates NX, NY by Gosub 12000.

The starting co-ordinates for the next line are made equal to the present values of NX and NY, and new values for NX and NY are calculated on the next step of the loop. The parabola is drawn as a succession of straight lines, without calculating the exact co-ordinate for every value of X from 0 to 319.

SHOCKING NEWS FROM MICRO MIRACLES...!!

GIGANTIC STOCKTAKING CLEARANCE

(for a limited period)

EPSON FX80	£425	£325
EPSON RX80FT	£315	£239
EPSON RX80	£275	£209
EPSON FX100	£565	£419
STAR	£255	£199
APPLE IIe	£845	£499
COMMODORE 64	£195	£159
BASF DISKETTES 5 1/4 SS/SD	£275	£1.00
TEXAS T1820	£1340	£899
TEXAS T1820KSR	£1580	£995
RICOH 1600 DL	£1635	£1190
QUME 5/55	£1785	£995

BROTHER HR15		CALL
APPLE III 128K	£2418	£1395
TEC F10-40	£1285	£849
APPLE L/Q PRINTER	£1360	£995
APPLE MATRIX PRINTER	£425	£345
JUKI D/WHEEL PRINTER	£399	CALL
IBM PC		CALL
EPSON QX10 256K	£1800	£1550
EPSON HX20	£402	£369
ACT SIRIUS		CALL
APRICOT (S/DRIVE)	£1495	£1245

DELIVERY NATIONWIDE AT £5 PER ORDER

- Official orders accepted
- Nationwide maintenance contracts arranged
- Prices exclude VAT and delivery

WHY NOT PHONE FOR SOME MORE SHOCKING NEWS

Tel. Nos. are: **0962 66191/0962 66783**

OR call at our showroom, next to Winchester BR Station



micro miracles

50A Stockbridge Road, Winchester, Hants
SO22 6RL England

● Circle No. 263

SYMBIOTIC

COMPUTER SYSTEMS

CAREER OPPORTUNITIES

Due to our continued growth in the local area networking and winchester technology marketplace for micro computers; Urgent vacancies exist in the following SYMBIOTIC group of companies.

ENGLAND

CP/M 86 and MS DOS Systems Experience:
Programmers and Sales Support Personnel
Experience Micro Peripheral Service Engineers
Pascal Applications Programmers.

AMERICA

6 month contract for CP/M 86 and MS DOS
Customer Support Engineer
applicant must hold B2 visa or work permit.

CONTACT: SYMBIOTIC COMPUTER SYSTEMS

DUROMA HOUSE, 32 ELMWOOD ROAD, CROYDON, SURREY CR9 2TX ☎ 01 680 1137 PBX

NEDERLAND/La HOLLANDE

Verkoop Personeel voor Noord Nederland en frans sprekend Belgie.
Jonge Technicus, ervaring gewenst, maar training is mogelijk.

Des Commerciaux pour la région nord de la Hollande et la Belgique francophone.

Un Jeune Technicien, experience souhaité mais une formation peut être donnée.

Schrijf Uw brief naar/Contactez: SYMBIOTIC COMPUTER SYSTEMS (BENELUX)
KEIZERSGRACHT·26·5611 AG·EINDHOVEN·NEDERLAND·☎·040 456055·

BUNDESREPUBLIK DEUTSCHLAND

Verkauf Personal fur das Ruhr Gebiet und Gebend Frankfurt.

Schreiben Sie nach: SYMBIOTIC COMPUTER SYSTEMS (BENELUX)
KEIZERSGRACHT·26·5611 AG·EINDHOVEN·NEDERLAND·☎·040 456055·

LA FRANCE

Secrétaire de préférence ayant une expérience de multi national mais pas essentielle.

Un jeune technicien, experience souhaité mais une formation peut être donnée.

Contactez: SYMBIOTIC COMPUTER SYSTEMS S.A.R.L.
87 RUE LEMERCIER·75017·PARIS·FRANCE·☎ (1) 228-14-18+

NORGE

Customer Support Programmer med variert erfaring fra Mikro Computere

Contact: SYMBIOTIC COMPUTER SYSTEMS A/S
POSTBOKS 162·OKERNVEIEN·OSLO 5·NORWAY·☎ (47) 2 64 55 77

Deal with the experts on Portable Computers

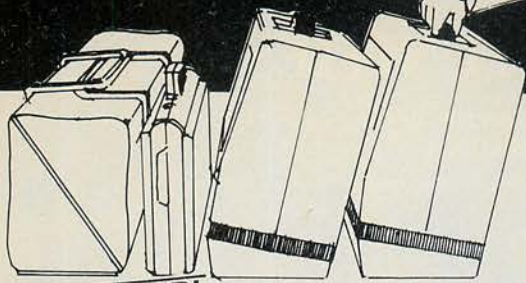

FREE WORDSTAR!

Sanyo MBC 55 Series ...from **£699**

128k ● MS-DOS ● 160k drives

Sanyo MBC 1150 **£1695**

64k ● CP/M ● Dual disc drives 320k

Apricot from **£1495**

256k RAM ● 315k drives

Epson HX20 **£411**

Epson QX10 normally ~~£2594~~

Includes printer and Peachtree software now **£1999**

OSBORNE SPECIAL OFFER

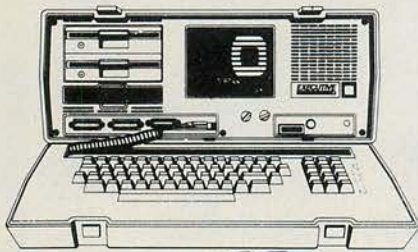

52 Column double density **£945**
 80 Column double density **£1145**
 Executive **£1695**

NOW AVAILABLE Double side disc drives

FREE Peachtree accounts package worth £375 or Personal Pearl worth £190 with every Osborne purchased!

Offer available while stocks last

Osborne's largest UK dealer
On site training, servicing and support.

Fraser Associates Ltd.

1 Bristle Hill, Buckingham. Bucks
 MK18 1EZ (0280) 816087

(0280) 816087

● Circle No. 135

Ranmor Computing Ltd

TRAINING CENTRE

- Professional instruction
- Effective
- At your premises or our Training Centre
- All training notes supplied
- Regular courses
- Courses/Beginners to advanced
- Flexible
- Dealer & Trainer Training

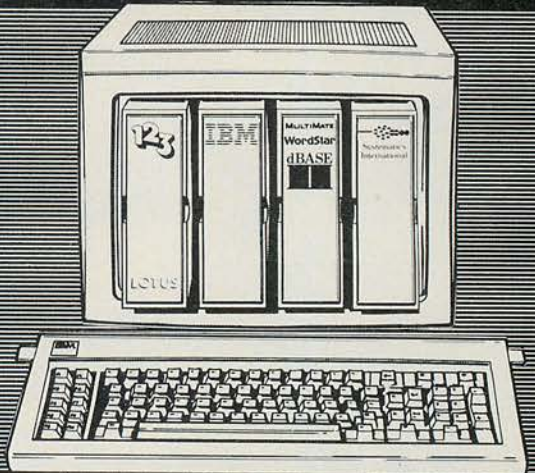

Systematics International
 Training Centre



Tel: 0702
339262



IBM
 Personal Computer

IBM Authorised Dealer

● Circle No. 136



Datalife™

WORDFLOW ELECTRONIC OFFICE SERVICES LIMITED

The Datalife People

DISK PRICES PER BOX OF TEN		1-3	4-7	8+
5 1/4" Mini Disks		£	£	£
MD525-01/10 SSSD/DSDD		18.79	18.30	17.84
MD550-01/10 DSDD		26.71	26.01	25.36
MD577-01/10 SSQD		29.00	28.26	27.53
MD557-01/10 DSQD		35.07	34.16	33.30

8" DISKS		26.50	25.00	23.00
FD34-9000 SSSD 26SEC 128 BYTES/SEC		26.50	25.00	23.00
FD32-9000 SSSD 32SEC HOLES + 1				
INDEX HOLE		26.00	25.00	24.00
FD10-4008 DSSD 8SEC 512 BYTES/SEC		31.00	29.00	28.00
DD34-4001 D2TM DSDD UNINITIALISED 1				
INDEX HOLE		31.00	28.50	27.00



We are currently taking orders for the new 3" and 3 1/2" compact disks. Ring now for the best possible price.

19 SHEEPCOTE ROAD HARROW MIDDLESEX
 Telephone 01 863 0994/863 4463

● Circle No. 137

Battery portables

Ian Stobie's selection of the machines which provide computing power anywhere you need it.

TRULY PORTABLE battery-powered computers form one of the most rapidly growing sectors in the computer market. These machines now have enough processing power to do a real job of work, while their independence from the mains supply lets them get out to wherever the work may be.

For this survey we are defining the true portable computer to be battery powered with at least one working day's endurance, with a full-size keyboard and a built-in display of at least 80 characters. A weight of 15lb. would be a reasonable maximum for ready portability, but in practice most of the machines included here weigh far less. As a rule heavy machines are not battery powered.

The distinction between true portables and Osborne-style transportables therefore almost reduces to power source, while the distinction with pocketables is given by keyboard size. We have excluded portable terminals as they are not programmable as stand-alone machines.

The computers in this survey are finding a very wide variety of uses. Rugged machines like the Fieldwork Fifty and Husky are collecting data and solving problems down mines and, literally, in the field. Lower-cost machines like the Epson and Tandy models have proved popular for assembling text; a number of firms are now able to transfer it from there directly into typesetting machines. Perhaps more typical is the use of this kind of machine by sales reps to collect client details and give an instant quote.

More surprisingly, many of these port-

ables are being used attached via a power adaptor to the mains, for instance set on the dispensing counter at the back of a chemist's shop. What machines like the Epson HX-20 provide is a complete data-processing system in a neat and cheap package. They may offer all that is required for a simple label-printing and stocktaking

system. What is more, such a system brings even greater benefits when attached via an acoustic modem to the phone line, and thence to the wholesaler's mainframe.

Our top 10 selection appears on the next two pages. Contact addresses for manufacturers and U.K. distributors are given in the panel below.

Suppliers

Casio FP-200: Casio Electronics Co. Ltd, Unit 6, 1,000 North Circular Road, London NW2 7JD. Telephone: 01-450 9131

Epson HX-20: Epson U.K. Ltd, Dorland House, 388 High Road, Wembley, Middlesex HA9 5UH. Telephone: 01-902 8892

Fieldwork Fifty: Immediate Business Systems plc, 3 Clarendon Drive, Wymbush, Milton Keynes, Buckinghamshire MK8 8DA. Telephone: (0908) 568192

Gavilan: Adam Computer Systems, Ripon Way, Ripon Road, Harrogate, North Yorkshire HG1 2AU. Telephone: (0423) 501151

Husky: Husky Computers Ltd, PO Box 135, Foleshill Road, Coventry CV6 5RW. Telephone: (0203) 668181

Olivetti: British Olivetti Ltd, PO Box 89, 86-88 Upper Richmond Road, London SW15 2UR. Telephone: 01-785 6666

NEC PC-8201: NEC Business Systems (Europe) Ltd, NEC House, 164-166 Drummond Street, London NW1 3HP. Telephone: 01-388 6100

Sharp PC-5000: Sharp Electronics (U.K.) Ltd, Sharp House, Thorp Road, Manchester M10 9BE. Telephone: 061-205 2333

Tandy Model 100: Tandy Corporation, Tameway Tower, Bridge Street, Walsall, West Midlands WS1 1LA. Telephone: (0922) 648181

Workslate: Convergent Technologies, 38-40 Sycamore Road, Amersham, Buckinghamshire HP6 5DR. Telephone: (02403) 28515

An Epson HX-20 on site, running estate agent's software from Sydney Development Co.





CASIO FP-200

£299

A4-sized portable with spreadsheet software in ROM. Weighs 3lb. and has an eight-line by 20-character liquid-crystal display. Full-size keyboard is acceptable but not of Tandy or Epson quality. The FP-200 is built around the eight-bit 80C85 processor and comes with 16K of RAM expandable to 32K, and 32K of ROM. The ROM contains a spreadsheet program and a Casio Basic. Data can be exchanged with other Casio machines through cassette interface. A small range of Casio software is available on cassette. Mains-powered four-colour printer/plotter costs around £170; other printers connect to parallel printer port. Upgraded machine with 16K RAM and a more advanced spreadsheet program in ROM costs £399.

For. Price. Built-in spreadsheet.

Against. Keyboard not really WP quality. Not much software.



EPSON HX-20

£402

Well established A4-sized portable with best range of software of the under £1,000 portables. Weighs 4lb. and has a four-line by 20-character liquid-crystal display, a good-quality full-size keyboard and a built-in 24-column printer. Microcassette drive fits next to display and is well worth the extra £75 for data and program storage. Built around the eight-bit 6301 processor with 16K of RAM, expandable to 48K with clip-on expansion unit. The 32K of ROM holds Microsoft-written OS and Basic, but the software is quite different to the NEC/Olivetti/Tandy machines. Lots of optional hardware add-ons from independent third-party suppliers, including full-size display and modems.

For. Good software base. Microcassette option. Well established.

Against. Screen too small by current standards.



FIELDWORK FIFTY

£2,236

Tough, light portable that runs CP/M software and uses bubble memory. Intended for use in harsh environments and designed to keep operating in temperatures from -30°C to $+70^{\circ}\text{C}$; it is also waterproof, and it floats. Weighs under 4lb. and has a two-line by 40-character liquid-crystal display. Full-size keyboard available in QWERTY, ABC or AZERTY layouts. Built around a CMOS variant of the eight-bit Z-80 and comes with 32K of RAM. The standard 64K of bubble memory is expandable to 256K; it functions like a disc drive but is tougher. An extra £250 buys Microsoft Basic and CP/M 2.2 capability. Full RS-232C is fitted and various hardware add-ons are available.

For. Very tough. Runs CP/M software.

Against. Toughness dictates high price and small display.



GAVILAN

£2,695

16-bit 8088-based portable with MS-DOS operating system and advanced touch-screen user interface. Base model Gavilan SC has eight-line by 80-column liquid-crystal display and comes with MS-DOS. More expensive 16-line Gavilan costs £3,495. Packages available at extra cost include WordStar and Supercalc-2. Runs Gavilan's own-brand OS as well as MS-DOS, and comes with integrated word processing, spreadsheet and communications software. Both models weigh about 9lb. and have full-size QWERTY keyboard, 64K of RAM expandable to 288K and a built-in 3.5in. microfloppy drive. Clip-on battery-powered A4 printer available. Plug-in modem awaiting BT approval. Gavilan's U.K. arrival expected March 1984.

For. Large screen. Neat design. Runs MS-DOS software.

Against. Price. Not yet here.



HUSKY

£1,784

Tough portable that runs CP/M software. Intended for use in harsh environments, using large amounts of battery-backed CMOS RAM for storing data and programs. Weighs just over 4lb. and has a four-line by 32-character LCD screen. Flat, waterproof, membrane-covered keyboard is about standard size but has unusual layout, with numerics easier to generate than alphabet. Built around a CMOS version of the eight-bit Z-80 processor. Comes with 32K to 144K of RAM and a full Basic. Runs CP/M 2.2 programs. Fitted with full RS-232; IBM 2780 protocol option is available for Husky-to-mainframe communications.

For. Very tough. Runs CP/M software.

Against. Non-standard keyboard. Gets expensive as you expand memory.



NEC PC-8201

£475

A4-sized portable with Microsoft-written software in ROM. Weighs under 4lb. and has an eight-line by 40-character liquid-crystal display and a full-size keyboard. Built around the eight-bit 80C85 and comes with 32K of ROM and 16K of RAM, expandable to 96K. The ROM includes Microsoft's text-editing program and a full Basic, which is slightly better than the Olivetti's. The PC-8201 is built in Japan for NEC by Kyocera, which also makes the similar Olivetti and Tandy machines surveyed here. The NEC version starts with more RAM and can be expanded further. You can get exchangeable battery-backed RAM cartridges for program and data storage. Equipped with cassette port and full RS-232 interface.

For. Good memory expansion. Good Basic. Nice keyboard.

Against. Newer and rarer than Tandy variant so less software.



OLIVETTI M-10

£430

A4-sized portable with Microsoft-written software in ROM. Weighs under 4lb. and has an eight-line by 40-character liquid-crystal display which pops up. Full-size keyboard. Built in Japan by Kyocera around eight-bit 80C85 processor. Base model comes with 8K of RAM, expandable to 32K. The 32K ROM contains Microsoft's text editor, a good Basic and a simple address-list and appointments program. Four-pen printer/plotter and battery-powered £250 BT-approved acoustic coupler available. RS-232 serial port and cassette interface fitted as standard.

For. Good Basic. Nice keyboard. Olivetti name.

Against. Newer than Tandy. Less memory than NEC.



SHARP PC-5000

£1,195

16-bit 8088 based portable with MS-DOS operating system and optional bubble memory. Weighs 11lb.; has eight-line by 80-character liquid-crystal display and full-size QWERTY keyboard. Standard model comes with 128K of RAM expandable to 256K. MS-DOS 2 and GWBasic are contained in ROM. Optional 128K plug-in bubble-memory module costs £164 and functions like a more robust floppy disc. Supercalc and other MS-DOS software available on bubble. Optional clip-on battery-powered A4 printer. External floppy promised, plug-in modem awaiting BT approval. Similar to Gavilan but with bubble memory instead of microfloppy for mobile use.

For. Neat design. Keen price. Runs MS-DOS software. Bubble-memory option.

Against. Software comes on bubble which may restrict choice.



TANDY 100

£424

Well established variant of the Kyocera A4-sized portable, with more available software than the NEC or Olivetti versions. Weighs under 4lb. and has an eight-line by 40-character liquid-crystal display. Full-size keyboard has the nicest typing feel of the Kyocera machines. Eight-bit 80C85 processor and 8K of RAM, expandable to 32K; 32K of ROM with similar Microsoft-written contents to the Olivetti's. Fitted with RS-232 serial port and cassette interface; mains-powered four-pen printer/plotter and acoustic coupler are options. The Tandy was the first of the three Kyocera machines on the market, and has been very successful in U.S. benefiting its software base.

For. Good Basic. Excellent keyboard. Reasonable software base.

Against. Less memory than NEC. Less scope for memory expansion.

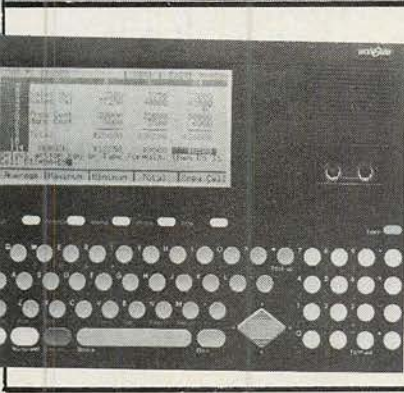

WORKSLATE

around £750

Small portable with spreadsheet in ROM, aimed at executives. Weighs 3lb. and has a 16-line by 46-character liquid-crystal display. Keyboard slightly smaller than full-size. Built around a Hitachi eight-bit CMOS processor with 16K of RAM, and 64K of RM with diary/alarm program. The spreadsheet software has models already set up for common business tasks. Built-in microcassette can be used for voice recordings. Range of software available on microcassettes in U.S. Battery-powered four-colour printer/plotter uses 4.5in. paper roll. Built-in plug-in modem in U.S. model. U.K. distribution still being set up.

For. Compact. Built-in software seems relatively straightforward.

Against. Non-standard operating system. Small keyboard. Not yet here.

THE FIRST surprise when you visit Xerox's Palo Alto Research Center, Parc, is that the front door is on the third floor. The terraced building is draped over the side of Coyote Hill, its windows facing south and east over Silicon Valley, its back to San Francisco, which lies 40 miles away to the north.

Since it opened its doors in 1970, Parc has been a place of pilgrimage for computer scientists from all over the world.

The Apple Lisa, introduced with great fanfares in 1982, is a dead ringer for the Xerox Alto, which has been widely used inside the company, but never marketed, since 1972. Bit-mapped screens, optical disc storage, the languages Mesa and Smalltalk, and the Ethernet local area network are some of Parc's firsts.

So why has Xerox not sold more computers? Indeed, what relation is there between all the activity in Palo Alto and the company's business? Robert Taylor, the head of Parc's computer science division from its inception until he left in September, says that Xerox finds it hard to answer these questions.

Computer science made Parc famous, but never accounted for more than 20 percent of the laboratory's budget or resources. Part of the reason for Xerox's failure to capitalise on Parc's undoubted successes can be found in its unhappy experiences as a computer manufacturer in the early 1970s.

High flyer

In 1968 Xerox acquired Scientific Data Systems, a high-flying computer manufacturer at the time of the merger, at a cost of \$918 million worth of Xerox shares. Seven years later, after absorbing losses of more than \$250 million, Xerox announced it was leaving the mainframe computer business.

Senior Xerox executives still wince at the memory, and while they were prepared to

Xerox's ivory tower

Christopher Roper talks to the key figures at Xerox's Parc about their long-term plans.

market the Star as a personal executive work station, it was not described as a computer. The trauma of the SDS collapse meant that Xerox did not build on the research being done at Parc in its early years. Even though 100 Alto machines were installed in the White House and are still in daily use, it was not regarded as a suitable product for the company in the Xerox executive suite.

Today, Xerox has a new chief executive, and there is some hope among research workers at Parc that their computers will soon make a direct impact on the market place. Two factors combine to give Xerox a second chance. The first is that very large scale integration, VLSI, means that the real cost of Xerox's advanced personal computers will drop to a level which is comparable to that of competing machines. The second is that users are beginning to demand higher software standards and

improved networking facilities from their personal computers.

No company, and that includes IBM, is better placed than Xerox to provide the next generation of personal computers. While Commodore and Apple derived their ideas for personal computers from the sudden availability of cheap micro-processors, Alan Kay at Parc was dreaming up a personal computer which was independent of the hardware constraints of the time.

His notion of a hand-held Dynabook with a high-resolution screen, 2Mbyte to 3Mbyte of internal memory, and simple access to communications seemed quite fanciful when he first propounded it 15 years ago. The engineers at Parc accepted the challenge and the Alto's first name was the interim Dynabook. The latest portable computers, like the Tandy 100 and the Grid Compass — designed by a Parc alumnus —



Parc and the future

One of the major bottlenecks for Xerox, wanting to sell more advanced systems, and for anyone wishing to apply expert systems to their current problems, is an acute shortage of qualified personnel.

Researchers at Parc are looking for ways to enlarge the neck of the bottle by increasing the impact and scale of knowledge engineering by simplifying the methods of knowledge programming and making them more widely accessible. In pursuit of this objective, they have developed an experimental knowledge programming system called Loops. Unlike other systems, which are based on a single programming language, Loops borrows widely from different methods and traditions of abstract knowledge representation. In order to test the validity of Loops, the research team at Parc developed Truckin, which is a board game with road stops. The players drive around, buying and selling commodities. Their job is to plan a route and make a profit. There are various hazards along the way, such as places where goods and profits can be lost. None of this sounds very different from other role-playing simulation games which use a computer to keep track of the consequences of different moves, and feed the players randomised hazards. There is one twist which sets Trucking apart: the players are computer programs constructed by the human participants. The task is to build the program which plays the best, by reaching Alice's Restaurant with the most cash.

The game has been refined into a three-day course which is being distributed by Xerox and is available to any institution with a Xerox computer and Interlisp-D. This may seem remote to *Practical Computing* readers, but soon such products may be soon sitting on our desks.

look more and more like Kay's original vision.

Software has always been developed in conjunction with hardware at Parc, and this has sometimes created headaches for would-be imitators. The Mesa systems programming language, developed at Parc and the source of several of Niklaus Wirth's ideas for Modula-2, is based on an exceptionally economical instruction set.

When Larry Tesler of Apple sought to achieve the same effects on the Lisa, based on the 68000 processor, he found that he needed far more memory than he originally estimated. This greatly increased the cost of Lisa. The high-resolution screen, with multiple windows, the icons, and the enhanced Pascal programming environment are all characteristic of Parc. This is

not surprising as Tesler is another migrant from Xerox to the competition.

The new generation of Xerox computers, the 1100 series, descendants of the old Alto design, is only just coming on to the market, costing upwards of \$30,000 per system. They are more expensive than other personal computers, but they are also cheaper than some minicomputers with comparable capabilities. Universities wanting to do advanced artificial Intelligence work with Lisp, for example, can now buy a Xerox system for less than half the price of a machine from Symbolics Inc.

The 1100 and the smaller 1108 provide the best models I have seen of what an ordinary personal computer, costing no more than an IBM PC does today, should look like in four or five years time, with

software to match the most demanding user's needs. However, it is still not clear that it will be Xerox which will provide the next generation of personal computers. The departure of Xerox research workers to rival companies prompted an article in *Fortune* magazine last September on "The lab which got away". There is talent still remaining at Parc, and as Lisa shows, it is one thing to walk out of the door with great ideas and another to make them work.

Xerox is not indifferent to attempts to emulate their achievements — a substantial corner of Parc is occupied by patent and copyright lawyers beavering away to protect the company's intellectual property. The law seems to say that while imitation is the sincerest form of flattery, duplication is theft.

In one important respect, Xerox has refused to follow the wishes and advice of its research workers. Smalltalk and Mesa have remained firmly in-house, unavailable on anything other than a Xerox machine. This policy was maintained throughout the 1970s despite enormous public interest in Smalltalk, and the fact that Mesa represented the state of the art in systems programming languages.

Exclusive

In fact, Mesa today can do almost everything that is claimed for Ada. But Xerox believed that the language should remain exclusive to its machines, which were not for sale at that time. This policy is now being re-evaluated: Smalltalk is already available under licence to other manufacturers and Mesa will be shortly. The third Xerox language, Interlisp-D, is available only on the Xerox 1100 series.

Bob Taylor says firmly that senior Xerox management never understood computers, and may still not. He was able to assemble the most talented computer research team ever gathered under one roof because, in

(continued on next page)

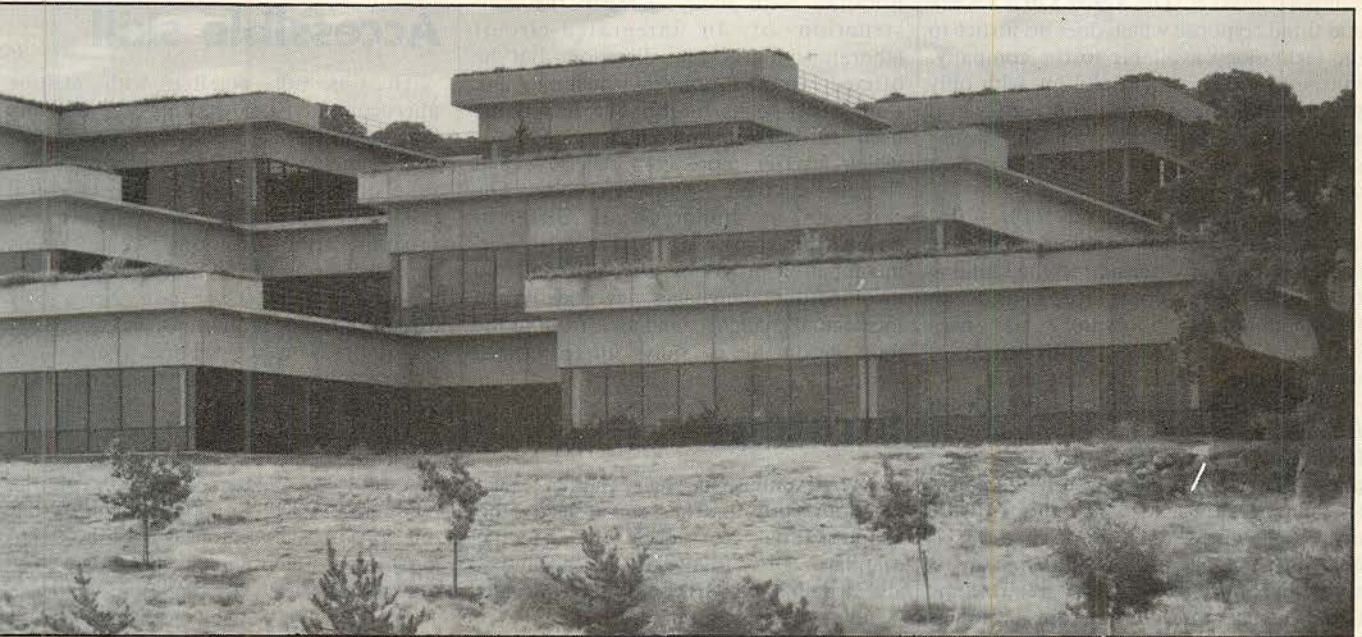

(continued from previous page)

the late 1960s, he was running the computer science division of the Defense Department's Advanced Research Projects Agency. In this capacity, he had been responsible for setting up Arpanet, one of the world's first computer networks, and for funding the first computer science departments in American universities. By the time he went to Xerox in 1970, Taylor believed that with the cost of integrated circuits dropping and their reliability improving rapidly it was no longer useful to pursue the idea of time-sharing.

The new concept, which had developed among the Arpanet community and dominated thinking at Xerox Parc from the beginning, was distributed computing. It implies computing power and memory distributed through a networked system of personal computers, equally available to all users, and without any central mainframe being used to control the operations of the network.

The vision cannot easily be faulted. No one who has ever used a network wants to go back to time-sharing or to a stand-alone personal computer. But the vision was wrong in one important respect — timing. When personal computing began to take off in the mid-1970s, the boom built up around stand-alone systems.

Smuggled Apples

The multi-national corporations, which might have bought Xerox's networked systems, ignored personal computers until their own executives began to smuggle in Apples and Pats through the back door. Data-processing departments resisted the idea of personal computing until the last minute, and IBM did not consider building a personal computer until 1980, and even then did not foresee the dramatic impact of the PC.

Xerox has been slower than IBM to respond to the rapidly changing personal-computer market. The Xerox 820 is a weak and timid response which does no justice to the technology available to the company. Furthermore, it is a closed box, with only proprietary hardware and software, even though the users want the widest possible freedom to choose their own configurations.

Despite defections and other discouragements, Xerox is still committed to Parc. A major extension to the building has just been completed, and an integrated-circuit laboratory has been built next door, a combined investment of more than \$50 million in plant alone.

William Spencer, who was brought in from Bell Labs to run the integrated-circuit laboratory, now controls the whole operation. The rise of Spencer is seen by some as the end of an era in which the software drove the hardware at Parc, but this is denied by management. VLSI, they say, is where hardware and software really come together. The absolute prerequisite now is

The 1100 Series

Xerox's 1100 series of personal computers all descend from the Alto, and represent the culmination of 10 years of integrated hardware and software design. The smallest is the 1108, which comes with up to 1.5Mbyte of main memory, and either 10Mbyte or 29Mbyte of disc memory. The 1100 is very similar to the 1108, but has a larger main memory, expandable to 2Mbyte.

The 1132, known as the Dorado, is described by Xerox as the most powerful personal computer ever produced, with its main memory expandable to 8Mbyte. The Dorado is not yet available in production quantities. Those sold so far, mainly to universities, were hand-built at Parc. It is hot and noisy in its present form in comparison to the 1100.

A recent article on AI complained that the Xerox 1108 had "rather small address space". The 1100 series are not based on single-chip processors; they use boards developed at Xerox from standard components, and the price is expected to drop dramatically with VLSI.

for overall control to be in the hands of someone who understands VLSI.

A senior Parc man drew a parallel with Intel, a company which started just before Parc opened. In 1980, the year in which Xerox decided it could no longer buy chips off the shelf, Intel decided it could no longer ignore high-level software considerations.

It is easy to underestimate Xerox's presence in the computer business, partly because several of its subsidiary companies still operate under their original names. For example, Diablo produced the first daisywheel printer and is now a Xerox company; one of its inventors has become a member of the Parc staff, working on the next generation of printer products.

Shugart is another Xerox company and recently announced an optical non-erasable storage disc with a capacity of 1,000 Mbyte. In quantities of 250, the new drive will cost a modest \$6,000. The development of the optical drive was for years the most expensive project at Parc, and many believed it would never result in a saleable product.

On a recent visit to Parc, I asked Dr Harold Hall what Xerox's strategic priorities were today. Clearly the construction of an integrated-circuit laboratory marks one direction, but he offered two other pointers which may link Parc's past to its future. The first is the need to develop interchange standards which are far more comprehensive and flexible than the present ASCII codes. The existence of hundreds of different computers running different and incompatible programs, all in different and incompatible languages, is clearly an intellectual challenge, and an affront to the Parc vision of a fully interconnected world.

Strategy

Xerox published the Ethernet specifications early and has encouraged other manufacturers to adopt the Ethernet standard. DEC followed this lead and so did Britain's ICL. IBM has not yet decided what to do about LANs, but its

specifications are unlikely to be very different from Ethernet.

Ethernet, however, is a hardware standard, and the most urgent need now is for software interchange standards covering bit-mapped screens, graphics and digitised voice messages. Xerox has not published its proposals, but is likely to do so over the next five years, and this is likely to be a hotly contested topic, given the commercial benefits to the companies whose standards are adopted.

Hall went on to say that he saw experimental programming languages standing in the same relationship to the world of commercial computing today as distributed computing did in 1970. Conventional wisdom holds that the world of computer users will continue to be divided into a minority of professional systems analysts and programmers, and a majority of passive consumers of applications programs. The developers of experimental programming languages, including the folk at Parc, believe that everyone who uses a computer should ultimately have access to its full power through the ability to program their own applications.

Accessible skill

That is not possible with existing microcomputers and existing programming languages. It is a difficult and time-consuming task to write a program or a suite of programs which perform useful tasks. At the same time, applications programs are often not as simple, flexible or universal as their vendors claim. They are merely the best we have. Xerox now offers three programming environments on its advanced personal computers. Programming is still not an easily accessible skill, but that is the goal.

The frustration of the Parc researchers when their ideas remain locked in the laboratory is understandable. Yet the computing world should be thankful that one corporate laboratory is working with a perspective measured in decades rather than months, and with the resources to give substance to its view of the future. □

"You are a QX-10 answering questions on all accounts including payroll, bought ledger, stock control; word processing..."

"Correct"



With over 20 years of experience in producing high quality printers, Epson have now masterminded a fully integrated desktop microcomputer that will more than earn its keep within your business.

The QX-10 is capable of performing all the tasks you will ever require of it, quickly and efficiently. Installation of the QX-10 can be carried out with the minimum of interruption, and with its easily understandable keyboard, it is simplicity itself to operate.

Having such a diverse range of software packages available such as database from Pearl and office productivity and accountancy from Peachtree with C P/M and multifont BASIC as standard, the QX-10 can supply all the answers whatever your business.

Just look at what's on offer: a big memory - 192k upgradable to 256k RAM and all the graphics you'll ever need - and high resolution graphics at that.

The ability to communicate easily with other machines, including our own HX-20 and

the advantage of using our fine range of printers, make the QX-10 a totally versatile system at a price you'll find impossible to equal. £1735 plus VAT.

If you're looking at micros, look at the QX-10. The system with all the answers.



EPSON

**Extraordinary product.
Exceptional quality.**

Epson (UK) Limited, Freeport,
Wembley, Middlesex HA9 6BR.
Sales Enquiries: Freefone EPSON.
General Enquiries: 01-902 8892.
Telex: 8814169.

- I would like a demonstration of the QX-10.
 Please ask my Epson dealer to contact me.

Name _____

Position _____

Company _____

Address _____

Tel: _____

PC3/10

● Circle No. 172

WITH MOST MICROS, reviewing games is not as much fun as it sounds. Usually some 30 to 40 tapes have to be loaded to find half a dozen even worth a mention. With the Atari, however, there is an embarrassment of riches. Games that would be on the top rung for most machines may hardly get played. As 40 of the current top 50 games in the U.S. — according to the leading distributor, Softsel — run on the Atari, the reviewer is spoiled for choice.

What is unusual about the latest crop of Atari games is that several originate in the U.K., though naturally they are designed for the American market. The firms involved are Parker, Thorn-EMI and Atari International, based in Slough, which has published a British game on tape as part of Atari's main line of programs.

As with the most recent collection of Spectrum games, reviewed in our November 1983 issue, the new offerings also have a strong three-dimensional content. However, unlike most of the Spectrum ones, nearly all the Atari programs are excellent games.

Zaxxon/Blue Max

Both Zaxxon from Datasoft and Blue Max from Synapse are three-dimensional flying shoot-em-up games with landscapes that scroll one pixel at a time. In each case you fly a bottom left/top right diagonal, and judge altitude partly by the shadow of your plane travelling across the landscape. In both games you have to strafe the enemy on the ground, and fight enemy planes in the air.

Zaxxon is already well known from the arcades. The home-computer version from Datasoft is still number 2 on the Softsel chart over a year after its American launch. Last year it was voted the Game of the Year and won various awards. Zaxxon's only problem is that Blue Max is even better.

In Zaxxon you fly a space fighter — though it looks rather like an old Vulcan bomber — over a modernistic enemy base. You blow up fuel tanks and enemy planes while threading through parapets and force fields. In the end, if you are very good, you destroy a deadly robot. It is all done mainly in blues and whites with very detailed graphics — though not as good as the arcade ones. Sound effects are whooshes and crumps.

In Blue Max you are Max Chatsworth, pilot of a rickety World War I biplane. The sortie begins with a rousing rendition of *Rule Britannia*. You fly along a river, then a road, until after several hours practising take-offs and landings you eventually reach a city base. On the way you strafe or bomb tanks, buildings, boats, bridges, passing vehicles and other targets.

Blue Max has several improvements over Zaxxon. First, the area covered is enormous, unlike the restricted landscape of Zaxxon. In some respects Blue Max gives a strong feeling of flight simulation. Second, there are enemy planes which come from in front and behind, each with its own

Plenty of choice

Atari owners still have the widest range of games to choose from. Jack Schofield makes another selection from the newer offerings.

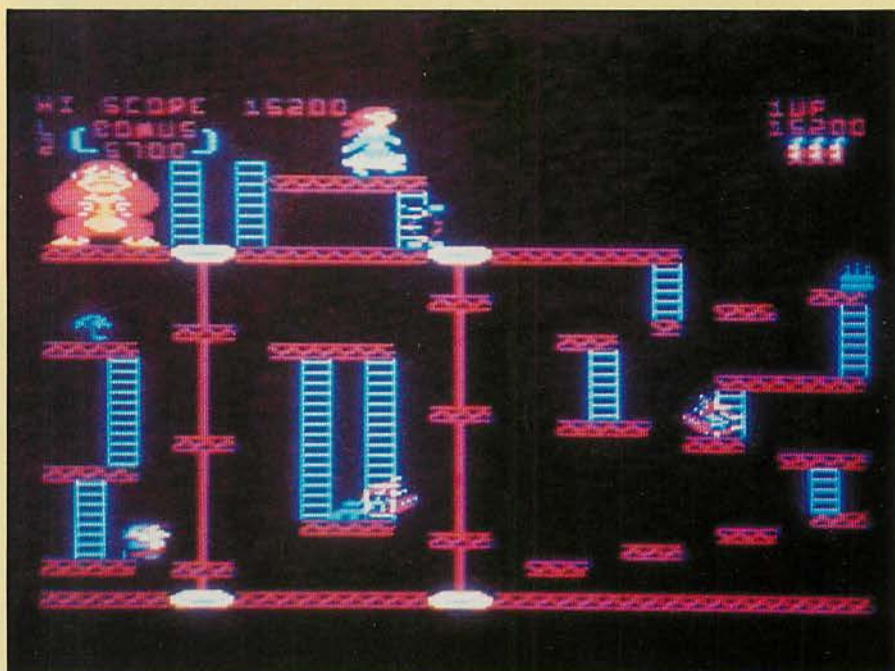

Donkey Kong is an arcade classic, with smooth action and brilliant animation.



Olive Oyl's hearts replace Kong's barrels in Popeye from Parker.

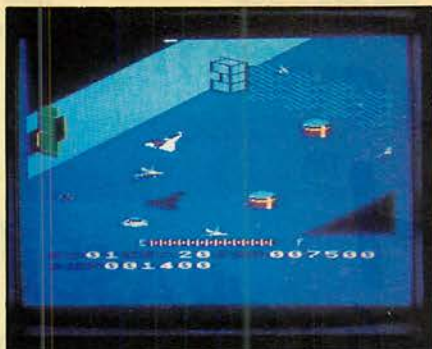

Zaxxon — still at number 2.



Bob Palin's brilliant Blue Max.



Legionnaire includes arcade elements.



Eastern Front — now better than ever.

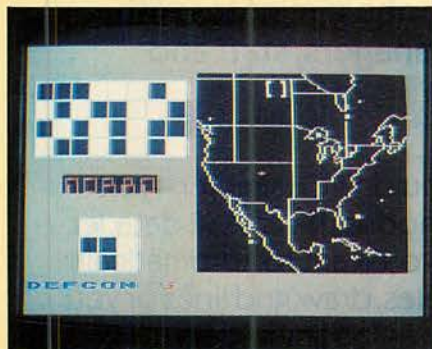

Computer War is tough and tense.



Pole Position — strictly for drivers.

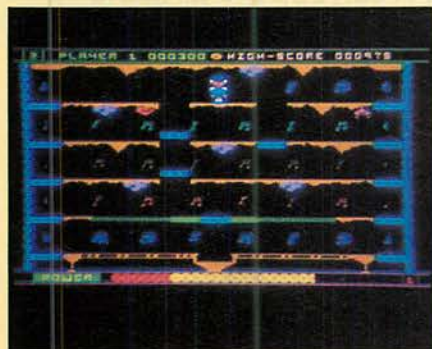

Jet Boot Jack by Jon Williams.

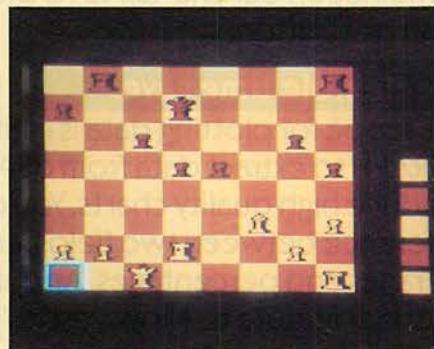

Atari's powerful ROM-based Chess.

shadow on the landscape. Shooting them down is great. By contrast, the enemy planes in Zaxxon come out of a safe, solid black background.

Blue Max also offers more variety in that you can bomb targets as well as firing at them. This brings a wider variety of semi-realistic sound effects, too. Yet in spite of all this, the game is very easy to play, because everything is controlled from the joystick. At the end of each sortie your score is converted into a rating, as in Star Raiders. A Class 1 Kamikaze trainee is lower than a Class 4 Runway Sweeper, and so on.

Zaxxon is brilliant — everyone seems to agree on that. Although Blue Max's graphics are not quite as fine it is a better game, and Bob Palin is to be congratulated on a brilliant feat of programming.

Zaxxon will soon be available for the Tandy Color Computer, and Blue Max is being put on the Commodore 64.

Pole Position

The other huge three-dimensional hit last year in the arcades was Atari's grand prix circuit-driving simulation Mount Fuji Racetrack. Its colour graphics are so sharp, so fast and so brilliant they have to be seen to be appreciated. If you have not seen them, go and do so.

Pole Position is the home-computer version, available on cartridge. It seems to be a fairly accurate copy except that all the advertising hoardings round the track have been left blank, which is a shame. Though the graphics are, inevitably, not up to the arcade standard they are still very impressive. This is one category where the official version is laps ahead, leaving the rip-offs versions for other micros looking tacky in comparison.

Like the arcade original, Pole Position gives a very strong sense of speed as you hurtle round the track. The super-realism of the three-dimensional effect adds a lot to the game. It is a great graphics demo. However, in other respects it is not very interesting. Control is wholly from the joystick with two gears: forward for low, back for high. That is not much of a challenge if, like me, you don't even like driving.

Donkey Kong/ Popeye

Donkey Kong is another arcade classic which it is best to see in the arcades before you consider the home version. The game involves the usual climbing of ladders, leaping over barrels, riding conveyor belts, collecting your girlfriend's accoutrements and generally trying to stay alive. Once again the Atari version is streets ahead of the competition. The particular strengths of this ROM-based game are the very smooth action, compulsive melodies and brilliant animation of Kong himself.

(continued on page 137)

Game	Publisher	Format	Price	Rating
Blue Max	Synapse	Cassette or disc	£27.75	18/20
Chess	Parker	ROM cartridge	TBA	17/20
Computer War	Thorn-EMI	ROM cartridge	£29.95	16/20
Donkey Kong	Atari	ROM cartridge	£29.99	17/20
Eastern Front	Atari	ROM cartridge	£29.99	19/20
Jet Boot Jack	English Software	Cassette	£14.95	14/20
Leggit	Imagine	Cassette	£5.50	10/20
Legionnaire	Avalon Hill	Disc	£29.30	15/20
The Lone Raider	Atari	Cassette	£14.99	14/20
Pole Position	Atari	ROM cartridge	£29.99	16/20
Popeye	Parker	ROM cartridge	£34.50	17/20
Zaxxon	Datasoft	Cassette or disc	£33.00	17/20

ASHTON · TATE ■ dBASE II

The world's leading micro database package can now give you even more.

dGRAPH™

The powerful graphics partner for dBASE II

Introducing a unique database graphics system that enables you to produce high

quality bar, line and pie bar charts without any specific programming knowledge. Everyone can now produce graphs in minutes with dGRAPH: managers, staff and secretaries.

The AUTOGRAPH feature

The Fox & Geller dGRAPH system couldn't be simpler – just select the graph you require, and choose the dBASE data, let AUTOGRAPH do the rest. Whether you want to automatically load your dBASE data, compute scales, draw grid lines or you need more advanced features such as 'zoom-in' capability, or combination bar charts, AUTOGRAPH can cope ... all at the push of a button.

The flexible time saver

The scope for plotting data is limitless with dGRAPH. Use dGRAPH to extract data from dBASE II so that you can produce high quality charts. You can even graph the difference between two fields, and create graphs showing averages and percentages. And, in addition, there's a calendar feature to allow you to 'build' data by day, month or year. Think about how much time you spend drawing sales graphs and comparison charts – think how easy it could be from now on.

Talk to your local dealer now and feel confident about presentations in the future.

● Circle No. 173

**DEALERS – Contact Fox & Geller
or one of these distributors for more details**

Softsel
Tamsys
Pete & Pam
MPI
Soft Option
ACT(Pulsar)

01-844 2040
(Windsor) 56747
01-769 1022
01-591 6511
(0476) 860171
021-455 7000

Midlectron
Software Ltd
Xitan
Tradesoft
Ferrari

(077382) 6811
01-833 1173
(0703) 871211
01-627 1800
01-751 5791



FOX & GELLER

Fox & Geller (UK) Ltd, 17 Wigmore Street, London W1. Tel: 01-580 5816.

dGRAPH is a trademark of Fox & Geller. dBASE II is a trademark of Ashton-Tate.

(continued from page 135)

If you are no particular fan of the arcade original, then Popeye is an interesting variation. Here you are Popeye the Sailor Man. Instead of Kong throwing down barrels while she shouts "Help!", here Olive Oyl throws little pink hearts. You have to catch them as they drift down while avoiding Bluto, who aims to grab you and grind you into pulp. The trick seems to be to punch the beehive so that it falls on Bluto's head while he's walking past the ladder.

The Donkey Kong tunes are nicer, but the Popeye colours are brighter. Both are extremely well animated and great fun to play.

Eastern Front/ Legionnaire

Some years ago Chris Crawford's Eastern Front was included in the cheap APX line of Atari programs. After all, who would want to buy it? It is only the best computer war game — of the sort more familiar from board games — ever written. It was later promoted to the main line of Atari programs, but only the price and the packaging changed. It still took three hours to play, had no Save Games feature, and you were certain to lose.

Now Atari has solved all the problems by putting the game on a ROM cartridge with a handful of play options from beginner to expert. You can learn to play with a couple of armies before you take on all Russia. In addition the top level has been made more difficult — as if it wasn't hard enough before. The result is a truly outstanding game.

Byte magazine gave Legionnaire a rave review, saying it was even better than Eastern Front. This time you are Caesar and command a small group of Roman legions. The background is a green scrolling landscape, produced using a multi-colour redefined character set, as in Eastern Front. Romans are red, Barbarians are blue . . . Your enemies are Gauls and other primitive types, who outnumber you by at least two to one.

Legionnaire also takes place in real time: it has arcade-game as well as war-game elements, including insistent sound effects. Perhaps the most attractive feature of the game used to be that you could use it as a training ground for Eastern Front. But with the new Eastern Front ROM, that has been taken care of.

Computer War

Our own Thorn-EMI pulled off something of a coup with Computer War, which is based on the film *War Games*. It came out very soon after the movie and, what is more, it is the company's best game yet.

You start with a map of North America, and pick up tiny white dots that show cruise

missiles heading for Norad, and us for thermonuclear oblivion. Position your cursor over the dot, leap to that part of the landscape, find the missile and destroy it. Then again, and again, and again. Periodically you also have to solve codes and deactivate bases to make the world safe, finally, for Reaganomics.

The landscapes of Computer War are all three dimensional, and display a huge variety to resemble the actual landscapes of North America. That said, they are diagrammatic rather than naturalistic. The cruise missiles themselves are larger or smaller according to distance, and can whoosh right overhead.

With a few minor alterations, the description of Computer War could also apply to the fabulous Star Raiders. Both games can be reduced to "jumping from spot to spot and blasting things". For map read galactic chart; for cruise missiles read Zylons. Computer War also has the same instant changes of scene, achieved by page-flipping between screens held in RAM. The one thing Computer War has as its own is the brilliant colour effect of some of the landscapes, done using dynamic display-list interrupts.

Other games from Thorn-EMI include Ice Hockey, River Rescue and Orc Attack. I found River Rescue too tedious, Orc Attack too grizzly and Ice Hockey too fast. In Orc Attack you get your head sliced off. In Ice Hockey the computer takes a seven-nil lead in 30 seconds while you are trying to figure out how to play.

Well, you can't win them all.

Chess

The Atari Chess ROM was alright in its day, but is far too weak by contemporary standards. Now, however, much stronger opposition has appeared from Parker in the form of an 8K ROM cartridge.

The Parker program is a version of the tournament-winning Cyrus Chess from London-based Intelligent Software. It has also appeared as Spectrum IS Chess and as Cyrus Chess for the Dragon, while Parker also plans to market an IBM PC version.

As you would expect, the graphics of the Atari version are rather better than the others. It also has most of the features you could want, including the facility to take back moves and to have the computer replay a finished game automatically. You can also set up positions.

Considering all the features it packs into 8K — and which the Atari ROM lacks — Cyrus also plays extremely well. It can play on eight levels, from moving instantaneously to taking an average of five minutes per move. To give some idea of the strength, here is a game I played at Level 5. The computer averaged about 40 seconds per move. I took longer over mine, and the total time for 25 moves each was an hour:

White: Schofield; black: "Cyrus"

1. P-K4 P-QB4 2. N-KB3 P-Q3 3. P-Q4 P x P 4. N x P N-KB3 5. N-QB3 P-KN3 6. P-B4 N-

QB3 7. N x N P x N 8. P-K5 P x P 9. Q x Qch K x Q 10. P x P N-N5 11. B-KB4 B-N2 12. 0-0-0ch B-Q2 13. P-K6 P x P 14. N-K4 P-K4 15. B-K2 P-KR4 16. B-Q2 R-QN1 17. P-KR3 N-B3 18. B-KB3 N-K4 19. B-QB3 B-KR3ch 20. B-Q2 B x Bch 21. R x B K-B2 22. N-B5 cries of "At last" after I had spent so long working up to this move. K-Q3 23. N x B K x N 24. P-QB4 P-K3 25. P x N P x P

Look at the position, shown in the photo on page 135. Have I been outsmarted? I have won a piece for a pawn, but black's central pawns are now so strong I really have no choice but to swap off with the bishop. Or do I? Where did I go wrong in trying to crush this thing?

I would not claim this to be a great game, but black's moves would look perfectly rational and believable from quite a good human player: they look intelligent. Eventually white duly won by swapping off two of the central pawns, later the rooks, and queening the QRP.

Parker Chess is the best chess game I have seen for the Atari, and recommended. I hope to play it against Odesta's new Chess 7.0 at some time in the future.

Quickies

Other new Parker games include Q*Bert, the cubist, and Super Cobra, which is a version of Scramble played with a helicopter. Q*Bert is arcade quality. Super Cobra is brilliantly coloured, and rather easy to play. It should suit beginners.

English Software has continued to issue cassette-tape games for the Atari, and its range now runs to over a dozen. I tried Venus Voyager and found it unplayable. I also tried Xenon Raid, but the three-dimensional effect is minimal compared to the other games reviewed here and it is too fast for my reflexes.

Jet Boot Jack is a new game from English Software, which I got from Prism. It has been written by Jon Williams, who has obviously been doing the right thing: learning from the Americans. The result is a game that is far better, in my view, than any of this company's previous efforts. Jet Boot Jack is somewhat like Manic Miner on the Spectrum, except there are lifts, and you have to duck instead of jumping.

Possibly there will be a whole Jack Series, like Horace and Cuthbert. English Software also sells Steeple Jack. I loaded it twice but both times it crashed on the title page so I am none the wiser. A Spectrum game called Jumping Jack is also available from Imagine for the Atari — under the name of Leggit. It isn't bad as a Spectrum game, but it's not in the Atari class.

The Lone Raider is the first U.K. game to become part of Atari's main line of programs. It features three screens: the first is just a warm-up; the second is like Jumping Jack/Leggit meets Pacman. I never made it to the third screen, but at the end of the 10th there is a secret message. 

MAYFAIR MICROS

★ ★ PRINTERS ★ ★

	PRICE EX VAT
EPSON	
RX 80T	£229.00
RX 80F/T	£256.00
FX 80	£335.00
MX 100F/T III	£375.00
FX 100F/T	£430.00
SEIKOSHA	
GP100A	£175.00
GP250X	£219.00
GP700A Colour	£349.00
OKI MICROLINE	
OKI 80A	£180.00
OKI 82A	£289.00
OKI 83A	£435.00
OKI 84A (P)	£855.00
OKI 84A (S)	£730.00
OKI 82P	£395.00
OKI 83P	£545.00
OKI 82S	£480.00
OKI 83S	£812.00
MANNESMANN TALLY	
MT80	£265.00
MT180	£495.00
MT190	£600.00
PIXY PLOTTER	£505.00
QUME	
9/45 RO	£1500.00
9/55 RO	£1790.00
11/40 RO	£1120.00
11/55 RO	£1250.00
SHEET FEEDER	£490.00
TEC	
STARWRITER F1040	£959.00
STARWRITER F1055	£1235.00
SHEET FEEDER	£459.00

DIABLO

830 RO	£1699.00
SHEET FEEDER	£490.00

RICOH

PRICE
EX VAT

£945.00

£1185.00

£459.00

£138.00

£1249.00

PRINTERS — OTHER

ANADEx DP8500 500cps	£1718.00
BROTHER HR15	£349.00
CANNON AP400KSH	£780.00
DRE 8925 240cps	£1495.00
JUKI 6100	£350.00
OLIVETTI ET121 + INTERFACE	£830.00
OLIVETTI INK-JET	£299.00
OLYMPIA ESW102	£675.00
PRINTRONIX P300 3001pm	£3663.70
SHINWA CP80	£240.00
SMITH CORONA TP1	£299.00
STAR DP510	£235.00
STAR DP515	£299.00

★ ★ MONITORS ★ ★

NEC JB1201ME	£185.00
NEC JC1201DE	£325.00
NEC JC1202DHE	£545.00
PHOENIX P12	£84.50
SANYO 14in Colour Hi-Res	£280.00
SANYO 14in Hi-Res	£84.50

★ ★ COMPUTERS ★ ★

PRICE
EX VAT

£1275.00

£1440.00

£1445.00

£1575.00

APRICOT

256K 0.315MB	£1275.00
256K 0.315MB MONITOR	£1440.00
256K 315Kx2	£1445.00
256K 315Kx2 MONITOR	£1575.00

SIRIUS

128K 1.2MB

128K 2.4MB

256K 2.4MB

256K 10MB

128K MEMORY EXPANSION

256K MEMORY EXPANSION

512 MEMORY EXPANSION

WASP 40MB STREAM/HARDDISK

160KB 2x320KB Disk Drives

160KB 2x640KB Disk Drives

160KB 10MB Hard Disk

SPECTRUM 48K

COMMODORE 64

COMMODORE DISK 1541

COMMODORE C2N CASSETTE

COMMODORE 1525 PRINTER

COMMODORE 64 INTERFACE

IBEK 64/Parallel INTERFACE

COMMODORE 1311 JOYSTICK

COMMODORE 1312 PADDLES

COMMODORE 8096

HX20 EXECUTIVE

HX20

OX10

EPSON

£1675.00

£2025.00

£2165.00

£2995.00

£225.00

£335.00

£473.00

£4495.00

£1995.00

£2395.00

£3995.00

£108.70

£156.51

£165.21

£36.51

£175.00

£28.69

£59.95

£8.09

£11.30

£735.00

£575.00

£375.00

£1600.00

MAYFAIR MICROS

362A YORK RD WANDSWORTH LONDON SW18 TEL 01-870 3255

● Circle No. 175

reprints

If you are interested in a particular article/special feature or advertisement in this journal **HAVE A GOOD LOOK AT OUR REPRINT SERVICE!**

We offer an excellent, reasonably priced service working to your own specifications to produce a valuable and prestigious addition to your promotional material. (Minimum order 250 copies).

Telephone Michael Rogers on 01-661 3457 or complete and return the form below.

To: Michael Rogers, Practical Computing, Reprint Department, Quadrant House, Sutton, Surrey SM2 5AS.

I am interested in copies of article/advert.

headed featured in this

journal on pages, issue dated

Please send me full details of your reprint service by return of post.

Name

Company

Address

..... Tel No

KINGSLEY ENTERPRISES

Mail Order Discs

Prices are for boxes of 10 discs

Soft Sector	Nashua	Xidex	Dysan	GenTech
5.25" Diskettes				
SS/SD 48	17.00		22.00	-
SS/DD 48	18.00	19.00	23.00	24.00
DS/DD 48	20.00	24.00	31.00	30.00
SS/DD 96	24.00	25.00	32.00	33.00
DS/DD 96	25.00	31.00	40.00	38.00

8" Diskettes

SS/SD 48	22.00	-	26.00	-
SS/DD 48	23.00	23.00	30.00	30.00
DS/DD 48	25.00	27.00	35.00	36.00

Sony 3.5" (Apricot) Diskettes £40.00

Add carriage (£1 per box) and V.A.T. (15%)
Prices correct at time of going to press
Please write for full-range price list

KINGSLEY ENTERPRISES
87 Whitefield Road
Stockton Heath
Warrington
WA4 6NB

Organise your files on
GenTech Colour
discs

● Circle No. 176

"Just the ticket for increased sales"

Complete and present this form at the Show for entry

VISITOR REGISTRATION FORM

Name _____
 Job Title _____
 Company _____
 Address _____

- Nature of business** (tick one box only please)
- Computer/WP retailer
 - Computer/WP dealer
 - Computer/WP distributor
 - Independent sales organisation
 - Other (please state) _____
 - Computer OEM
 - Other OEM
 - Consultant
 - Office systems dealer
 - Systems house/integrator

- Job Function**
- Management
 - Marketing/Sales
 - Service
 - Software development
 - Engineering
 - Consultant
 - Other (please state) _____

Main area of interest: _____
 Computer related advertising material may be sent to you as a result of filling in this card. If you do not wish to be included on any other mailing list please tick box
 * For additional tickets please state figure here _____
 Please send a covering letter stating name, job title, company and address of ticket recipients.
 Return to: The Exhibition Manager, The Computer Trade Show,
 Reed Exhibitions, Surrey House, 1 Throwley Way, Sutton, Surrey SM1 4QQ.

Wembley Conference Centre, March 13-15 1984 Open 09.30-17.00 daily

In a fast changing market like computers you need to see the very latest hardware and software developments if you're going to be able to offer your customers the most up to date systems.

For keeping up with developments The Computer Trade Show is just the ticket – so to help you attend this exclusive trade only show we have printed the visitor registration form here. Simply fill it in and bring it with you to Wembley Conference Centre when The Computer Trade Show is on from March 13 to 15 and you will be admitted free.

If you want tickets for your colleagues or other bona

fide visitors return the* form to Exhibition Manager and tickets will be forwarded to you immediately.

Because the show is for the trade only you can expect a warm welcome from all the exhibitors who will be only too eager to discuss trade prices, distribution agreements, licensing agreements and so on. You can see many different suppliers all in one day, and have the kind of discussions which would normally require several formal appointments. You owe it to yourself and your clients to keep up to date so let The Computer Trade Show be your ticket to increased sales.



Saracen Data Products



FLEXIBLE DISKETTES

	Prices per Box (£)			
	1-4	5-9	10-49	50-99
104/1 Single Sided, Single Density	21.30	19.20	18.30	17.39
104/1D Single Sided, Double Density	23.43	21.20	20.13	19.12
104/2D Double Sided, Double Density	35.20	31.46	29.92	28.42
204/1D Single Sided, Quad Density	35.20	31.46	29.92	28.42
204/2D Double Sided, Quad Density	44.22	39.60	37.62	35.74
3740/1 Single Sided, Single Density	33.11	29.59	28.16	26.75
3740/1D Single Sided, Double Density	34.21	30.58	29.10	27.59
3740/2D Double Sided, Double Density	40.51	36.41	34.54	32.81

SONY

3½" OMD 3220
AVAILABLE FROM
STOCK
£45.00 PER BOX OF 10

MEDIAGUARD — Fire Safe
£279.00 Each —
FREE BOX OF 8", 5½" OR 3½"
DISKETTES WITH EVERY
MEDIAGUARD.

THIS OFFER ONLY AVAILABLE
TO RETAIL CUSTOMERS

Dysan UHR II Media CONTACT US FOR PRICES & DELIVERY

DYSAN RIGID DISK PACKS

THE FULL RANGE OF DYSAN DISK PACKS IS AVAILABLE CONTACT US FOR PRICES.

RING US NOW FOR
YOUR COPY OF OUR ILLUSTRATED PRICELIST

- LARGE VOLUME DISCOUNT PRICES
- TRADE PRICES AVAILABLE ON REQUEST
- FREE DELIVERY ON ORDERS OVER £100.

ALL PRICES SUBJECT TO V.A.T.

Saracen Data Products Limited

176-180 High Street, Dorking, Surrey, RH4 1QR Tel: (0306) 887550 / 888271

● Circle No. 197

CAMDEN

THE COMPUTER PEOPLE

COMPUTER SYSTEMS LIMITED

462 COVENTRY ROAD, SMALL HEATH
BIRMINGHAM B10 0UG
Telephone: 021-771 3636 (10 lines) Telex: 335909 (Camden G)

5MB WINCHESTER



SPECIAL OFFER

APPLE IIE PLUS GREEN SCREEN
MONITOR
5 MEG WINCHESTER WITH BUILT-IN
FLOPPY.
RECOMMENDED PRICE £2810
OUR PRICE £1995

	RRP	CAMDEN PRICE
APPLE IIE	845	645
80 COL CARD	80	70
80 COL + 64K	180	150
DISK WITH CON	345	270
DISK W/OUT	245	220
TRIDENT 5 MEG	1450	1150
TRIDENT 5 MEG PLUS FLOPPY	1700	1465

10 MEG VERSION £2275

ALL PRICES EXCLUDING VAT



12 MONTHS PARTS AND LABOUR ON ALL APPLE AND TRIDENT PRODUCTS

● Circle No. 179

DATA MASTER

AT LAST – a database designed to let you organise your business the way you want it!

Easy to use you'll start using it in minutes

Employees New Records Written

Male 2 Female

EMPLOYEE RECORD

Name: John R. Smith

Ins. No.: YE IS 42 48C

Address: 12 Main Road

Tel: Ilford County Essex Post code IG1 4LU

Sex: male Married: no

Salary: 15,000

fully menu driven to remove the guesswork. Full use of function keys with the assignments always displayed. All cursor movement and editing functions on the keyboard are supported. Provides full colour support and screen style customisation.

System Features:

A list of users can be kept, with passwords and security levels. The print style is customisable. Data can be interchanged with mainframe computers, other databases or spreadsheet programs. Database back-up and restore functions are integrated to reduce errors.

System Requirements:

Available on IBM-PC, SIRIUS, NCR, TEXAS, Wang-PC, DEC and other 16 bit computers. Requires a minimum of 128K memory and 2 disk drives (on some micros a minimum of 192K memory is required). Supports floppy or hard disk drives. Supports all popular printers.

NAME OF THE DATAMASTER APPLICATIONS:

Inventory Control, Personnel Management, Job Accounting, Mailing List, Accounting, Order Processing, Market Analysis, Financial Portfolio, Medical Office Systems, Real Estate, Agriculture, Distribution Management, Social Sciences, Bibliography, Library Management, School Records.

So powerful you'll have a complete application within hours

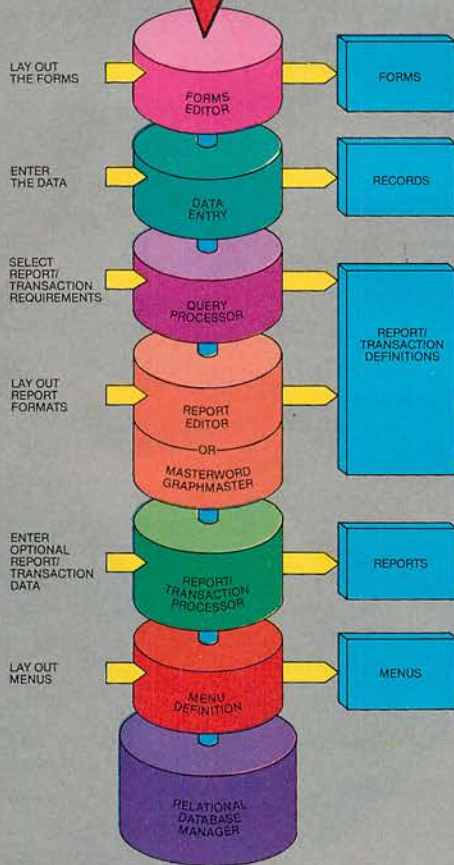

- Lay out your forms on the screen. Define data entry fields anywhere by answering simple questions. Revise the forms any time without losing data.
- Easy, fast and accurate way to fill-in the forms and enter, view or revise records.
- The reports or transactions requirements are defined in the English-like query language by answering simple questions. Select records any number of ways, combine up to 5 forms per report, perform calculations, get totals, sub-totals, or statistical summary. For complete transaction processing, delete, modify or enter records.
- Reports are automatically formatted in several ways, or specify your own format using the Report Editor.
- To format a report complete with text, data, and graphs; use the optional MASTERWORD word-processor or the GRAPHMASTER graphics facility.
- Display or print the report output, or take it to your spreadsheet, word processing, or graphics programs.
- Organise the access to your forms and reports by setting up your own menus.
- The underlying Relational Database Manager provides efficient storage and retrieval of records. It uses B-tree indices for efficient accessing of records, and cache memory to retain the most recently used disk sectors to reduce disk access by 50 percent.

ANOTHER NEW PRODUCT FROM



SAPPHIRE SYSTEMS LTD, 1-3 PARK AVENUE ILFORD, ESSEX IG1 4LU TELEPHONE: 01-554 0582

DATAMASTER is available **NOW** to let YOU organise your business the way you want it. So clip the coupon to see a demonstration of DATAMASTER on your own micro or at your local Sapphire dealer.

To: Sapphire Systems Ltd., 1-3 Park Avenue, Ilford, Essex IG1 4LU. Telephone: 01-554 0582.

Please send me.....copies of the DATAMASTER DEMONSTRATION SYSTEM @ £5.50 inc. VAT & p.p. per copy for my: -

IBM-PC Sirius NCR Texas Wang-PC DEC

Please debit my:

Access Card No:..... for £.....

Barclaycard No:..... for £.....

I understand that £5.00 will be refunded on the return of the demonstration system or on the subsequent purchase of the DATAMASTER full system.

Please arrange for a demonstration of DATAMASTER.

Please send me further details of DATAMASTER and the SAPPHIRE SYSTEMS MASTER RANGE of business software.

Signature

Name

Position

Company

Address

.....

..... Tel No:

Computer type

Please allow 28 days for delivery-Reg. No. 1467831 VAT No. 250078973

• Circle No. 180



PULSAR BLUE

Heaven sent for IBM users.

Pulsar, the 16-bit business software which became a best seller on the Sirius 1 microcomputer is now available for IBM PC users. Already over 10,000 Pulsar systems have been sold, bringing the benefits of true 16-bit computing to multinational companies, small businesses and institutions throughout the UK.

Pulsar Blue is an integrated range of commercial accounting, office systems, planning and modelling software from ACT bringing a new dimension to personal computing. Pulsar Blue is powerful, but friendly. Help routines, concise documentation and simple menus built in to the programs ensure that first time users can quickly familiarise themselves with even the most sophisticated systems. This combination of user friendliness and powerful processing has made Pulsar the most successful 16-bit business software in the country. And its available from IBM dealers now.

Pulsar Blue – a gift from heaven for IBM users.

The Pulsar Blue Range

Sales Ledger	£195	d Graph [™]	£195
Purchase Ledger	£195	MicroModeller [™]	£595
Nominal Ledger	£195	Mars [™]	£395
Payroll	£195	SuperCalc 2 [™]	£195
Stock Control	£195	SuperCalc 3 [™]	£295
Invoicing	£195	(graphics spreadsheet)	
Data Analysis	£195	Multiplan [™]	£195
Informer Database	£295	Wordstar [™]	£295
d Base II [™]	£395	MailMerge [™]	£95
		SuperWriter [™]	£295



For more information on Pulsar Blue for the IBM PC clip the coupon and return to

ACT (Pulsar) Ltd

Freepost

Birmingham B16 1BR

or call 021-455 7000

Please send me details of Pulsar Blue – business software for the IBM user.

Please state make of Micro currently used _____

Name _____

Position _____

Company _____

Address _____

Tel _____

Circle No. 181
PCMAR/84

[™] indicates registered trade mark. Ownership details on request. All prices exclude VAT.



Spreadsheet or Financial Planning

SPREADSHEET

Splitscreen display, menus and matrix, scrolling without losing row descriptions, comprehensive matrix and file manipulation, flexible data input.

ANALYSIS AND SORTING

Sort data by row, by column, in ascending or descending order, even by row name. Highlight values meeting specified criteria, statistics include regression for forecasting.

JOB AUTOMATION

Compiled job streams make running comprehensive systems quick and easy; options allow for operator prompts and choices to be built in.

REPORT WRITER

Compiled for fast production of formal reports with graphics, sorting comprehensive formatting and display facilities.

DATA INPUT

Direct into spreadsheet or from files built in Encore, or from files external to Encore. Plus random number generation and arithmetic on entry.

FINANCIAL MODELLING

Spreadsheet plus comprehensive procedural language; IF, THEN, ELSE, GOTO, and WHILE. Shorthand models (R3 = R1 + R2) or in plain English 'Total Cost' = 'Fixed Costs' + 'Variable Costs'.

GRAPHICS

'Quick and Dirty' from spreadsheet or comprehensively from Exec. Provides over ten different chart types. Can be used with external data files.

EXEC!

A compiled language for systems writing, includes formal reports, graphics, menus, over 100 commands for writing comprehensive systems, perfect for consolidations!

EDIT

A powerful screen text editor for writing models and procedures, or letters and memos.

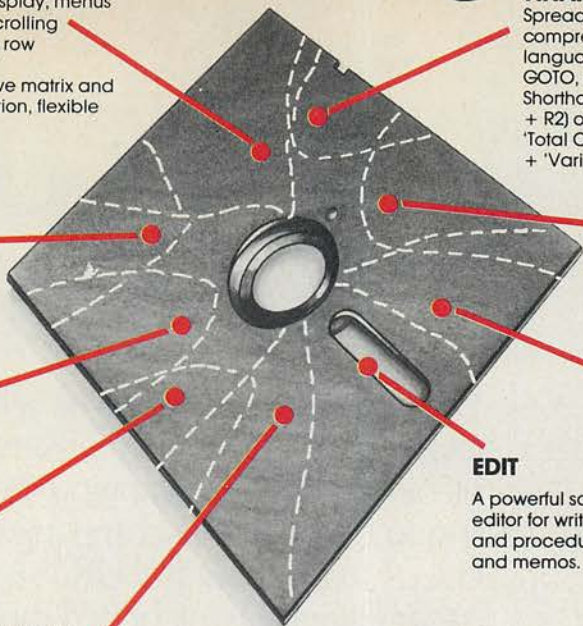

ENCORE
A COMPLETE PACKAGE

See Encore at your IBM Dealer* today at only £395 + VAT **can you afford to ignore it?** Sirius version available soon.

ENCORE is written by FEROX:
authors of DSS/F - The Micromodeller

*in case of difficulty contact:
Dataflex Ltd, 238-246 King St.
London W6 0RF, 01-748 4176

● Circle No. 182



MAGIC

MEMORY

is the application of micro technology combined with the sophisticated operating techniques usually only associated with large mini computer systems. Literally hours each week can be saved with **MAGIC MEMORY** both by increased performance with the micro cache and by not waiting for printing to finish before being able to resume working. All this is available to users from £195 for 64K up to £595 for a full 512K, from dealers or direct from DATAFLEX. More details available from PHILLIP BERGE or DAVID LOW at DATAFLEX LIMITED on 01-748 4176.

Name: _____

Address: _____

TEL: _____

PHONE 01-748 4176 OR SEND BACK COUPON TO
Dataflex Ltd The System Centre 238-246 King Street London W6 0RF

● Circle No. 183

>OPEN FILE

PRACTICAL COMPUTING

MARCH 1984

Open File monitors

Apple John Harris
Atari Jack Schofield
BBC Nicholas McCutcheon
Commodore Mike Todd
Dragon Ian Stobie
Epson HX-20 John Wellsman
IBM PC Jack Schofield
Newbrain David Watt
Tandy John Wellsman
Research Machines Ian Stobie
Sharp John Hooper
Sinclair John Wellsman

Open File is the part of the magazine written by the readers of *Practical Computing*. All aspects of microcomputing are covered, from games to serious business software and utilities. Fully-debugged programs can be submitted for any micro, and for standard CP/M machines such as the Osborne and Superbrain. Programs can be in machine code or any language, including Forth and Pascal.

Submissions should include a brief description which explains what your program does, and how it does it. If possible it should be typed, with lines double-spaced. We need a printed program listing. Hand-written listings cannot be accepted. A tape or disc of the program helps if it is in a standard format.

When printing listings, please remember to use a new ribbon or double-intensity printing — faint listings reproduce badly. Use plain paper only, and try to list the program across either a 35-character or a 70-character width. Also, make sure all special graphics or inverse-video characters are either listed correctly or else include Rem statements to explain them fully.

Each program listing, tape or disc must have your name and address on it, or we cannot promise its safe return. A stamped addressed envelope is appreciated.

If you write in with a comment, correction or enquiry please remember to state the machine and the program title.

We pay at least £10 for any programs used, or £35 per page and pro rata for part pages.

>BBC

146 ACCESSING RECORDS

David Miller supplies a set of routines for indexing a random-access data file.

147 HIGH SCORE

Games players will appreciate Kathryn Armstrong's program which helps you keep a record of the top scores in all your favourites.

148 THE GRID

An amusing variation on the "stop the aliens" theme, written by Keith Miles.

>IBM PC

153 CREATION

Take a break from writing your quarterly report or planning next year's profits with this diverting combination of graphics and sound by Paul Myerscough.

153 MENU

John Lewis's Basica program displays an alphabetical list of the Basic files you have stored on disc.

>APPLE

155 GALACTIC INTRUDERS

An arcade-style game by P Walkley, with a step-wise playing style that is all its own.

>COMMODORE

161 TELEPHONE MONITOR

Michael Garrard has written a program that keeps track of the cost of a phone call while you are actually making it — but wouldn't it be better on ROM?

162 SAVING PAPER

If you have to list data to a printer you can save a great deal of paper with this program, which prints it out on the page in several parallel columns.

>SINCLAIR

165 EXTRA CHARACTERS

If you need more than the standard 21 user-defined characters available on the Spectrum, try this Basic routine by Magnus Davidson.

166 FOUR IN ONE

A strategy game for two players, written for the Spectrum by Charles Cowan.

>RESEARCH MACHINES

171 DISC COPIER

David Lane has a fast and efficient alternative to CP/M's Pip utility for copying the complete contents of a disc; it checks for errors too.

172 PLOTTING

A suite of programs by Daniel Freeman which offers a choice of styles for plotting a three-dimensional representation of any object.

>TANDY

173 ONE-WAY TICKET

A graphic edition of the well known Moon Lander game, played in real time and devised by George Speller.

173 SORT ROUTINE

This exceptionally fast Basic routine rearranges a substantial list of items; it is written for the Tandy Model II micro by R C G Bryant.

Send your contribution to:

Open File, Practical Computing,
Quadrant House, The Quadrant,
Sutton, Surrey SM2 5AS

Accessing records

A COMMON technique for accessing records in a random-access file is the use of an index in which a record number is associated with each record key. FNRecno, ProcInsdel and ProcChange by David McMillan are routines for use in searching and updating an index file. They are listed here set in a test bed which generates some alpha keys at random and then allows you to perform various operations on them.

The routines require that the file consists of two arrays held in memory. The first array, Key\$(), contains the keys of records held on the file and the second, Recno%(), contains all the possible record numbers that can exist in the file. The keys must be sorted into ascending sequence.

The record numbers are split into two sections. The first contains those that are in use, along with the keys to which they relate.

The function FNRecno returns either the record number for a key which exists or zero for a key which does not. It uses the binary chop method to search the list of keys. One parameter is required, namely the key of the desired record.

ProcInsdel inserts or deletes keys. On insertion of a key the number of the record to be used is obtained from the beginning of the section of unused record numbers. On deletion of a key, the freed record number will be placed at the beginning of the section of unused record numbers.

This method ensures that all available space within the file is used automatically. Like FNRecno it uses the binary chop method for searching. Two parameters are required: the key to be inserted or deleted, an I or D to indicate which of the options is required.

ProcChange allows a key to be changed. Normally it should never be necessary to change the key of a record. This procedure simply deletes the old key and immediately inserts the new key. The method of reusing freed record numbers ensures that the same record number is used for the new key. This procedure uses both FNRecno and ProcInsdel. Two parameters are required: the current key and the new key.

```

10 REM INDEX
20 REM by David McMillan
30 REM A program that demonstrat
es
40 REM routines:-
50 REM          FNRECNO
60 REM          PROCINSDEL
70 REM          PROCCHANGE
80 Max%=10
90 DIM Key$(Max%),Recno%(Max%)
100 Key$(0)="" : Recno%(0)=0
110 REM***FILL LIST OF RECORD NUMB
ERS***
120 FOR L%= 1 TO Max%
130 Recno%(L%) = L%
140 NEXT
150 REM*****GENERATE RANDOM KEYS**
*
160 PRINT"NO. OF RECORDS (max ";Ma
x%;")":INPUT Top%
170 IF Top%<1 OR Top%> Max% VDU7:G
OT0160
180 INPUT"KEY LENGTH",L2%
190 IF L2%<1 VDU7:GOTO 180
200 FOR L%= 1 TO Top%
210 Key$(L%)=STRING$(L2%," ")
220 Key$(L%)=""
230 FORL1%=1TO L2%
240 Key$(L%)=Key$(L%)+CHR$(64+RND(
26))
250 NEXT
260 NEXT
270 REM***** SORT KEYS ***
*****
280 PROCSORT(1,Top%)
290 PROCLIST
300 REM*****TEST ROUTINES*****
*****
310 REPEAT
320 PROCTEST
330 UNTIL FALSE
340 END
350 REM***** PROC SORT *****
*****
360 DEF PROCSORT(M%,N%)
370 LOCAL I%,J%
380 IF M% > N%-1 THEN 430 ELSE IF
N%-M% = 1 AND Key$(N%) < Key$(M%) P
ROCEXCH(M%,N%):GOTO 430 ELSE XX = FN
RN(M%,N%):Y$=Key$(X%):I% = M%: J% =
N%
390 I% = I%-1:REPEAT I%=I%+1:UNTI
L I% = N% OR Y$ < Key$(I%):IF Y$ >=

```

```

Key$(I%) I%=N%
400 J% =J%+1:REPEAT J% = J%-1:UNTI
L J% = M% OR Key$(J%) < Y$:IF Key$(J
%) >= Y$ J% = M%
410 IF I% < J% PROCEXCH(I%,J%):I%
= I%+1:J% = J%-1:GOTO 390 ELSE IF I
% < X% PROCEXCH(I%,X%):I% = I%+1 ELS
E IF X% < J% PROCEXCH(X%,J%):J% = J%
-1
420 PROCSORT(M%,J%):PROCSORT(I%,N%
)
430 ENDPROC
440 REM***** FN RN *****
*****
450 DEFFNRN(E%,F%)=RND(F%-E%)+E%-1
460 REM***** PROC EXCH *****
*****
470 DEFPROCEXCH(E%,F%)
480 LOCALH%,H%
490 H$=Key$(E%):Key$(E%)=Key$(F%):
Key$(F%)=H$
500 H%=Recno%(E%):Recno%(E%)=Recno
%(F%):Recno%(F%)=H%
510 ENDPROC
520 REM***** PROC LIST ***
*****
530 DEF PROCLIST
540 IFTop%<1GOTO600
550 VDU14
560 FOR L%=1TO Top%
570 PRINTKey$(L%),Recno%(L%)
580 NEXT
590 VDU15
600 ENDPROC
610 REM***** PROC TEST ***
*****
620 DEF PROCTEST
630 INPUT"KEY",Key$
640 INPUT"F-ind/I-insert/D-elete/C-
hange",opt$
650 IF opt$ <> "F" GOTO 680
660 IF FNRECNO(Key$) = 0 PRINT"KEY
NOT IN INDEX":VDU7 ELSE PRINT"RECOR
D NUMBER IS ";FNRECNO(Key$)
670 GOTO 730
680 IFopt$="I" OR opt$ = "D" PROCI
NSDEL(Key$,opt$):PROCLIST:GOTO 730
690 IF opt$ <> "C" PRINT"NOT F, I
, D OR C":VDU7:GOTO 640
700 INPUT"NEW KEY",Nkey$
710 PROCCHANGE(Key$,Nkey$)
720 PROCLIST
730 ENDPROC

```

```

740 REM***** FN RECNO *****
*****
750 DEF FNRECNO(Key$)
760 IF Top% < 1 = 0
770 low% = 1
780 high% = Top%
790 IF high% - low% < 2 GOTO 840
800 mid% = low% + (high%-low%)/DIV2
810 IF Key$>Key$(mid%) low% = mid%
:GOTO 790
820 IF Key$<Key$(mid%) high% = mid
%:GOTO 790
830 GOTO 860
840 IF Key$(low%)=Key$ mid%=low%
:GOTO 860
850 IF Key$(high%)=Key$ mid%=high
%ELSEmid%=0
860 =Recno%(mid%)
870 REM***** PROC INSDDEL *
*****
880 DEF PROCINSDEL(Key$,opt$)
890 IF Top% < 1 AND opt$ = "I" Top
%=0: mid%=1:GOTO 1050
900 IF Top% < 1 AND opt$ = "D" PRI
NT "INDEX EMPTY":VDU7:GOTO 1240
910 IF Top% >= Max% AND opt$ = "I"
PRINT"INDEX FULL":VDU7:GOTO 1240
920 low%=1
930 high% = Top%
940 IF high% - low% < 2 GOTO 1000
950 mid% = low% + (high%-low%)/DIV2
960 IF Key$>Key$(mid%) low% = mid%
: GOTO 940
970 IF Key$<Key$(mid%) high% = mid
% :GOTO 940
980 IF opt$ = "D" GOTO 1160
- 990 PRINT"KEY ALREADY IN LIST":VDU
7:GOTO 1240
1000 IFKey$=Key$(high%) mid% = high
%:GOTO 980
1010 IF Key$ = Key$(low%) mid% = lo
w%: GOTO 980
1020 IF opt$ = "I" GOTO 1040
1030 PRINT"KEY NOT IN INDEX":VDU7:G
OTO 1240
1040 IF Key$>Key$(high%) mid%=high
%+1 ELSEIF Key$<Key$(low%) mid%=low%
ELSEmid%=low%+1
1050 Recno%=Recno%(Top%+1)
1060 IF Top%<1 GOTO 1120
1070 IF mid% > Top% GOTO 1120

```

(listing continued opposite)

```

1080 FOR L%=Top%Tomid%STEP-1
1090 Key$(L%+1)=Key$(L%)
1100 Recno%(L%+1)=Recno%(L%)
1110 NEXT
1120 Key$(mid%)=Key$
1130 Recno%(mid%)=Recno%
1140 Top%=Top%+1
1150 GOTO 1240
1160 IFmid%=Top%GOTO 1230
1170 Recno%=Recno%(mid%)
1180 FOR L% = mid% TO Top%-1
1190 Key$(L%) = Key$(L%+1)
1200 Recno%(L%) = Recno%(L%+1)
1210 NEXT
1220 Recno%(Top%)=Recno%
1230 Top%=Top%-1
1240 ENDPROC
1250 REM***** PROC CHANGE *
*****
1260 DEF PROCCHANGE(Key$,Nkey$)
1270 IF FNRECNO(Key$) = 0 PRINT"OLD
KEY NOT IN INDEX":VDU7:GOTO 1320
1280 IF FNRECNO(Nkey$) <> 0 PRINT "
NEW KEY ALREADY IN INDEX":VDU7:GOTO1
320
1290 Recno%=Recno%(FNRECNO(Key$))
1300 PROCINSDEL(Key$,"d")
1310 PROCINSDEL(Nkey$,"I")
1320 ENDPROC
>

```

High score

Kathryn Armstrong of Marlow has submitted a program called High Score. It keeps track of the scores from games you own or have typed in from pages of *Practical Computing*. The program will work with either disc or cassette. A colour monitor is preferable, although not essential.

First of all you have to initialise an empty file for saving the data. Openout a file with the following procedure:

```

10 DIM score(10,10)
20 f = OPENOUT("D.SCORE")
30 FOR I% = 1 TO 10
40 FOR J% = 1 TO 10
50 PRINT #f,score(I%,J%)
60 NEXT J%: NEXT I%
70 CLOSE #f

```

Then run the program. It reads data and then displays both personal high scores and game scores. After it has been initialised, the program reads and saves the data each time it is called.

High score.

```

10 MODE7
20 PROCinit
30 REPEAT
40 PROCget_name
50 IF table PROctable_choice ELSE
PROCscores
60 UNTIL FALSE
70 ::::::::::::::::::::::::::::
80 ::::::::::::::::::::::::::::
90 DEFPROCinit
*****
110 DIM SCORE(10,16)
120 DIM NAME$(10)
130 DIM GAME$(16)
140 DIM SORT(10)
150 DIMSORT$(10)
160 REM set up colours eg r=red
170 r=129
180 g=130
190 y=131
200 b=132
210 m=133
220 c=134
230 REM change VDU7
240 *FX213,200
250 *FX214,1
260 PROCheader("HIGH SCORES")
270 ON ERROR GOTO1080
280 table=FALSE
290 F=OPENUP("D.SCORE")
300 FORI%=1TO10
310 FORJ%=1TO10
320 INPUT#F,SCORE(I%,J%)
330 NEXT,
340 CLOSE#F
350 players=0
360 REPEAT
370 players=players+1
380 READ NAME$(players)
390 UNTIL NAME$(players)="END"
400 players=players-1
410 REM enter up to 9 players as d
ata before "END"
420 DATA" SARAH", "SIMON", "KATHRYN"
430 DATA"ROBERT", "ANOTHER", "END"
440 No_games=0
450 REPEAT
460 No_games=No_games+1
470 READ GAME$(No_games)
480 UNTIL GAME$(No_games)="END"
490 No_games=No_games-1
500 REM enter up to 15 games as da
ta before "END"
510 DATA"ROCKET RAID", "DEFENDER", "
SNAKE", "G. PRIX", "LANDER", "MONSTER"
520 DATA" HOG", "END"
530 ENDPROC
540 DEFPROCget_name
*****
560 PROCheader("HIGH SCORES")
570 PRINTTAB(0,4)CHR$g"Choose a pl
ayer : "
580 IF players<7 spc=2 ELSE spc=1
590 FOR I=1 TO players
600 PRINTTAB(14,I*spc+5)CHR$(I+64)
SPC2CHR$(c)NAME$(I)
610 NEXT
620 PRINTTAB(0,23)CHR$b"Press 'T'
for high score tables"
630 PRINTTAB(0,24)CHR$b"Press 'ESC
APE' to play games";
640 PRINTTAB(11,19)CHR$m" Enter A
to "CHR$(players+64)" ";
650 REPEAT
660 who=GET-64
670 UNTIL (who>0 AND who<=players)
OR who=20
680 IF who=20 table=TRUE
690 VDU7
700 ENDPROC
710 DEFPROCscores
720 *****
730 PROCheader("HIGH SCORES FOR "+
NAME$(who))
740 IF No_games<8 spc=2 ELSE spc=1
750 REPEAT
760 FOR I=1 TO No_games
770 PRINTTAB(6,I*spc+3)CHR$(64+I)C
HR$(m)GAME$(I);TAB(15)CHR$b": "CHR$(c
)SCORE(who,I)
780 NEXT
790 PRINTTAB(0,24)CHR$b"Press 'RET
URN' for another player"SPC4;
800 PRINTTAB(0,21)CHR$r" To change
a score enter game letter : ";
810 REPEAT
820 alter=GET-64
830 UNTIL (alter>0 AND alter<=No_g
ames) OR alter=-51
840 VDU7
850 IF alter=-51 GOTO950
860 PRINTTAB(0,24)CHR$r"Press 'RET
URN' to keep present score ";
870 oldscore=SCORE(who,alter)
880 PRINTTAB(6,alter*spc+3)CHR$(al
ter+64)CHR$(y)GAME$(alter)
890 PRINTTAB(0,21);SPC39
900 PRINTTAB(0,21)CHR$y"New score
for ";GAME$(alter);
910 INPUT " : "SCORE(who,alter)
920 IF SCORE(who,alter)>5000000 PR
INTTAB(0,21)CHR$r"!! SCORE TOO BIG !
!"SPC20:TIME=0:REPEAT UNTIL TIME>200
:GOTO890
930 IF SCORE(who,alter)=0 SCORE(wh
o,alter)=oldscore
940 VDU7
950 UNTIL alter=-51
960 VDU7
970 ENDPROC
980 DEFPROCheader(text$)
990 *****
1000 CLS
1010 gap=(39-LEN(text$))/2
1020 FOR I=1 TO 2
1030 PRINTCHR$141CHR$(g)TAB(gap)tex
t$
1040 NEXT
1050 ENDPROC
1060 REM SAVE/ERROR ROUTINE
1070 *****
1080 IF ERR<>17:REPORT:STOP
1090 ON ERROR OFF
1100 PROCheader("HIGH SCORES")
1110 PRINT'CHR$m"Saving the data"
1120 IF PAGE=&1900 PRINT'CHR$m"Plea
se wait....";
1130 REM reset VDU7
1140 *FX213,100
1150 *FX214,6
1160 VDU7
1170 F=OPENOUT("D.SCORE")
1180 FORI%=1TO10
1190 FORJ%=1TO10
1200 PRINT#F,SCORE(I%,J%)
1210 NEXT,
1220 CLOSE#F
1230 REM delete if games not menu d
riven
1240 CHAIN"$ .MENU"
1250 END
1260 DEFPROctable_choice
*****
1280 REPEAT
1290 PROCheader("HIGH SCORE TABLES"
)
1300 PRINTTAB(0,4)CHR$g"Choose a ga
me : "
1310 IF No_games<8 spc=2 ELSE spc=1
1320 FOR I=1 TO No_games
1330 PRINTTAB(14,I*spc+4)CHR$(64+I)
CHR$(y)SPC2GAME$(I)
1340 NEXT
1350 PRINTTAB(0,24)CHR$b"Press 'p'
for player scores";
1360 PRINTTAB(13,20)CHR$m"Enter A t
o "CHR$(No_games+64)" ";
1370 REPEAT
1380 GAME=GET-64
1390 UNTIL (GAME>0 AND GAME<=No_gam
es) OR GAME=16
1400 VDU7
1410 IF GAME<>16 PROctable
1420 UNTIL GAME=16
1430 table=FALSE
1440 ENDPROC

```

(continued on next page)

(continued from previous page)

```

1450 DEFPROCtable
1460 *****
1470 PROCHeader("HIGH SCORE TABLE F
OR "+GAMES(GAME))
1480 PROCsort
1490 IF players<7 spc=2 ELSE spc=1
1500 FOR I=1 TO players
1510 PRINTTAB(5,I*spc+6)CHR$(y)SORT
$(I)TAB(15)CHR$(b)";";CHR$(c)SORT(I)
1520 NEXT
1530 PRINTTAB(0,24)CHR$b"Press 'RET
URN' to continue ";
1540 REPEAT
1550 A=GET
1560 UNTIL A=13
1570 VDU7
1580 ENDPROC
1590 DEFPROCsort
1600 *****
1610 FOR I%=1 TO players
1620 SORT(I%)=SCORE(I%,GAME)
1630 SORT$(I%)=NAME$(I%)
1650 NEXT
1660 FOR L1%=1 TO players
1670 FOR L2%=2 TO players
1680 IF SORT(L2%)>SORT(L2%-1) temp=
SORT(L2%):SORT(L2%)=SORT(L2%-1):SORT
(L2%-1)=temp:temp%=SORT$(L2%):SORT$(
L2%)=SORT$(L2%-1):SORT$(L2%-1)=temp%
1690 NEXT,
1700 ENDPROC
>A

```

The Grid

Keith Miles of Ely, Cambridgeshire has submitted this amusing variant on the old "stop the alien invasion" theme. It is also an interesting exercise in programming which makes the most of the structured nature of BBC Basic.

The aim of the game is to stop the aliens from occupying the Grid by descending to its bottom-most rung. To halt them you move your ship about the grid and try to hit them with your missiles, which have limited range. Additional hazards include the fallout from your own successful missile strikes and the fuel dropped by the X-Y Droids that inhabit the sides of the grid.

The program is controlled by a Repeat-Until loop in lines 160 and 170. Movement is achieved by using VDU31 to generate Print Tab commands. Hits are signalled through the Point command, to detect colour.

The Grid.

```

10 REM THE-GRID: Copyright K.MILES.
4, WILLOW WALK. ELY. CAMBS
20 MODE2
30 ENVELOPE3,129,2,4,6,28,14,7,0,0,
0,-80,80,80
40 VDU23,1,0;0;0;0;
50 DIMXX(18),YX(18)
60 PROCCHARACTERS
70 HI%=0
80 PROCTITLES
90 CLS:SC%=0:QX=1:WX=2:GX=1:LX=1:FU
ELX=0:LVLX=0:SPX=8
100 RAX=1:ALX=4
110 IFALX>18 ALX=18
120 IFRAX>5 RAX=5
130 RX=0:MX=0:CX=0:EX=0:HX=1:SX=10:
SYX=28:AX=225:MX=0:MYX=0:FLX=0:FUELX=
FUELX+200:S1X=10:S2X=10:GOX=1
140 PROCBOARD
150 PROCINVADEERS
160 REPEAT:PROCV:PROCSHIP:PROCDROI

```

```

DS:PROCHOMER:FUELX=FUELX-RAX:IFFUELX<0
FUELX=0
170 COLOUR4:PRINTTAB(5,0);FUELX;" ";
:UNTIL CX=ALX+1 OR EX=1 OR FUELX<=0
180 IFEX=1OR FUELX<=0 THEN200
190 IFCX=ALX+1AND ALX=18 LIX=1:SPX=S
PX=2:GOTO100 ELSE RAX=RAX+1:ALX=ALX+5:
GOTO110
200 PROCINVADEE
210 COLOUR8:PRINTTAB(6,15)"THE-GRID"
:COLOUR3:PRINTTAB(0,30)"ANOTHER INVASI
ON?" ;
220 *FX15,0
230 AS=GET$:IFAS="Y"OR AS="y"GOTO80
240 IFAS="N"OR AS="n" PRINTTAB(0,31)
:;END
250 GOTO230
260 DEFPROCBOARD
270 COLOUR4:PRINTTAB(0,0)"FUEL ";FUE
LX:COLOUR6:PRINTTAB(10,0)"SCORE ";SC%
280 COLOUR1:FORIX=1TO19:FORJX=1TO28:
VDU31,I,X,J,X,240:NEXT:NEXT
290 COLOUR5:PRINTTAB(0,30)"HI-Score
";HI%;
300 ENDPROC
310 DEFPROCCHARACTERS
320 VDU23,225,195,219,219,255,255,21
9,129,0,23,226,0,129,219,255,255,219,2
19,195
330 VDU23,227,254,252,24,124,124,24,
252,252,23,228,127,63,24,62,62,24,63,1
27
340 VDU23,229,224,96,62,51,51,62,96,
224,23,230,24,60,36,36,60,255,195,129
350 VDU23,231,24,60,60,24,24,60,36,0
,23,232,0,36,60,24,24,60,60,24
360 VDU23,233,0,0,102,252,252,102,0,
0,23,234,0,0,102,63,63,102,0,0
370 VDU23,235,24,36,90,189,189,90,36
,24,23,236,102,189,189,90,90,189,189,1
02
380 VDU23,237,36,129,219,255,126,36,
66,129,23,240,24,24,24,255,255,24,24,2
4
390 ENDPROC
400 DEFPROCINVADEERS
410 COLOUR2:FORIX=0TO ALX:XX(I%)=1+R
ND(18):YX(I%)=HX:VDU31,XX(I%),YX(I%),2
37:NEXT
420 ENDPROC
430 DEFPROCV
440 RX=RND(ALX+1)-1
450 MX=RND(3)-2
460 IFYX(RX)=-32THEN560
470 T1X=FNPT(CXX(RX)+MX),YX(RX)):IFT
1X=11 PROCFAILOUT:GOTO560
480 T2X=FNPT(CXX(RX)+MX),(YX(RX)+1)
:IFT2X=11 PROCFAILOUT:GOTO560
490 COLOUR1:VDU31,XX(RX),YX(RX),240
500 XX(RX)=XX(RX)+MX
510 IFMX=0 YX(RX)=YX(RX)+1
520 IFXX(RX)>19 XX(RX)=19
530 IFXX(RX)<1 XX(RX)=1
540 COLOUR2:VDU31,XX(RX),YX(RX),237
550 IFYX(RX)>28 EX=1
560 ENDPROC
570 DEFPROCSHIP
580 KPX=0
590 COLOUR1:VDU31,SXX,SYX,240
600 *FX15,0
610 IFINKEY(-99) VDU7:SXX=RND(18)+1:
SYX=RND(28):GOTO690
620 IFINKEY(-2)AND SXX<19 KPX=1:SXX=
SXX+1:AX=228:IFFLX=0 XX=1:YX=0:BX=234
630 IFKPX=1THEN690
640 IFINKEY(-65)AND SXX>1 KPX=1:SXX=
SXX-1:AX=227:IFFLX=0 XX=-1:YX=0:BX=233
650 IFKPX=1THEN690
660 IFINKEY(-89)AND SYX>1 KPX=1:SYX=
SYX-1:AX=225:IFFLX=0 XX=0:YX=-1:BX=231
670 IFKPX=1THEN690
680 IFINKEY(-1)AND SYX<28 SYX=SYX+1:
AX=226:IFFLX=0 XX=0:YX=1:BX=232
690 IFINKEY(-74)OR FLX>0 PROCMISSILE
700 TX=FNPT(SXX,SYX):IFTX=11OR TX=13
OR TX=2 EX=1:GOTO720
710 COLOUR6:VDU31,SXX,SYX,AX
720 ENDPROC
730 DEFPROCMISSILE
740 IFFLX=0 FLX=1:MXX=SXX:MYX=SYX
750 VDU31,MXX,MYX,240
760 MYX=MYX+YX:MXX=MXX+XX
770 FLX=FLX+1
780 IFFLX=11 OR MXX>19OR MXX<10R MYX
<10R MYX>28 FLX=0:GOTO840
790 PX=FNPT(MXX,MYX)
800 IFPX=2OR PX=3 PROCCHIT:FLX=0:GOTO
840
810 IFPX=11OR PX=5 FLX=0:GOTO840
820 IFPX=13 FLX=0:FUELX=FUELX+50+(RN
D(RAX)+50):VDU31,MXX,MYX,240:SOUND0,-1
5,4,8:GOTO840
830 COLOUR4:VDU31,MXX,MYX,BX
840 ENDPROC
850 DEFPROCHIT
860 FORJX=0TO ALX
870 IFMXX<>XX(JX)ORMYX<>YX(JX)THEN91
0
880 COLOUR11:VDU31,MXX,MYX,236
890 SC%=SC%+YX(JX):CX=CX+1
900 YX(JX)=-32
910 NEXT
920 SOUND3,3,50,10
930 COLOUR6:PRINTTAB(16,0);SC%
940 IFHIX<SC% COLOUR5:HIX=SC%:PRINTT
AB(9,30);HI%;
950 ENDPROC
960 DEFPROCFAILOUT
970 COLOUR1:VDU31,XX(RX),YX(RX),240
980 SC%=SC%+YX(RX)
990 CX=CX+1
1000 YX(RX)=-32
1010 SOUND3,3,50,10
1020 COLOUR6:PRINTTAB(16,0);SC%
1030 IFHIX<SC% COLOUR5:HIX=SC%:PRINTT
AB(9,30);HI%;
1040 ENDPROC
1050 DEFPROCINVADEE
1060 FORI=1TO20:SOUND0,-15,6,10:FORJ=
1TO5:VDU19,1,RND(6);0;:NEXT:NEXT
1070 VDU20
1080 ENDPROC
1090 DEFPROCDROIDS
1100 VDU31,0,QX,32,31,WX,29,32
1110 QX=QX+GX:WX=WX+LX
1120 IFQX>27 GX=-1
1130 IFQX<2 GX=1
1140 IFWX>19 LX=-1
1150 IFWX<2 LX=1
1160 COLOUR4:VDU31,0,QX,229,31,WX,29,
230
1170 IFRND(1)>.97 COLOUR13:VDU31,WX,Q
X,235:SOUND0,-15,2,4
1180 ENDPROC
1190 DEFPROCTITLES
1200 CLS:COLOUR1:FORIX=0TO30:FORJX=0T
019:PRINTCHR$(240);NEXT:NEXT
1210 COLOUR4:PRINTTAB(6,0)"THE-GRID"
1220 COLOUR3:PRINTTAB(2,2)"CAN YOU HA
LT THE""TAB(2,3)"ALIEN INVASION OF""TA
B(6,4)"THE GRID."
1230 PRINT""AVOID COLLIDING WITHTHE A
LIENS AND EVADE""TAB(1,8)"THE FALL-OUT
FROM""TAB(1,9)"YOUR OWN MISSILES.""TAB
(2,10)"BEWARE OF HOMER."
1240 PRINTTAB(1,12)"HIT THE FUEL DUMP
S""TAB(1,13)"DROPPED BY THE X-Y""TAB(2,1
4)"DROIDS TO REFUEL."
1250 COLOUR2:PRINTTAB(2,16)CHR$(237)"
ALIEN"
1260 COLOUR5:PRINTTAB(2,17)"@ HOMER"
1270 COLOUR4:PRINTTAB(2,18)CHR$(230)"
X-Y DROID"
1280 COLOUR11:PRINTTAB(2,19)CHR$(236)"
FAILOUT"
1290 COLOUR13:PRINTTAB(2,20)CHR$(235)"
FUEL DUMP"
1300 COLOUR6:PRINTTAB(2,21)CHR$(225)"
YOUR SHIP"
1310 COLOUR3:PRINTTAB(1,23)"CONTROLS:
""TAB(2,25)"CAPS-LOCK LEFT""TAB(2,26)"C
TRL RIGHT""TAB(2,27)"J U
P""TAB(2,28)"SHIFT DOWN""TAB(2,29)"
RETURN FIRE""TAB(2,30)"SPACE P
ANIC"
1320 COLOUR4:PRINTTAB(3,31)"PRESS <SP
ACE>";
1330 I=0:REPEATI=I+1:SOUND0,-15,I,10:
UNTILI=5
1340 IFINKEY$(100)=" "THEN1350ELSE133
0
1350 ENDPROC
1360 DEFNPT(dx,ex)
1370 =POINT(dx+64+32,1008-(ex*32))
1380 DEFPROCHOMER
1390 IFLVX=0THEN1490
1400 IFSPX<2 SPX=2
1410 GOX=GOX+1:IFGOX<>SPX THEN1490
1420 Q1X=S1X:Q2X=S2X
1430 S1X=S1X+(S1X>SXX)-(S1X<SXX):S2X=
S2X+(S2X>SYX)-(S2X<SYX)
1440 IFFNPT(S1X,S2X)=6 EX=1
1450 IFFNPT(S1X,S2X)=11 S1X=Q1X:S2X=Q
2X:GOTO1480
1460 COLOUR1:VDU31,Q1X,Q2X,240
1470 COLOUR5:VDU31,S1X,S2X,64
1480 GOX=0
1490 ENDPROC

```

The right software or your application from COMPUTECH



apple
Authorised Dealer
Service Centre
System Consultancy



COMPUTECH FINANCIAL ACCOUNTING PACKAGES

Payroll £375
Invoicing and Stock Recording £295
Sales, Purchases and General Ledgers each £295
Also costing and group consolidation

COMPUTECH UTILITIES DISK

for reliable error checking copying, diskette scan, interpret and patch, etc £20
VisiCalc, Applewriter and other Apple software (Prices on request)

COMPUTECH CHAIN MAIL

A mailing merging document processor which may be used with text files, including random files and Applewriter 1.1 binary files £45

COMPUTECH GRAPHICS DISK

for printing Apple pictures and graphs on Epson and Microline (free with printers purchased from Computech) £30

COMPUTECH TERMINAL UTILITIES

Apple to Apple and Apple to mainframe from £130

COMPUTECH hardware...just plug it in and go!

switches and jumpers provide hardware options without soldering



DIPLOMAT VIDEO DIGITISER

store a frame from video camera in a fiftieth of a second, process and print — for Apple II £195
for APPLE IIe, including 64K Extended 80 Column Card £345

DIPLOMAT PARALLEL Interface £80

DIPLOMAT SERIAL COMMUNICATIONS Interface £85

DIPLOMAT RAM 16 Memory Expansion £95

DIPLOMAT CLOCK/CALENDAR £80

LOWER CASE Character Generator with Applewriter 1.1, enhancements £50

MICROMUX Data Exchange (Max 16 Ports) from £850

MATRIX PRINTERS, Microline and Epson with graphics and up to 200 cps from £222

MICROLINE Optional Character Generator £15

DAISY WHEEL PRINTERS, Olympia, Qume, Ricoh from £798

Prices exclude VAT, Carriage and Packing

For full details phone for data sheets and a FREE demonstration

COMPUTECH SYSTEMS

168 Finchley Road, London NW3 6HP. Tel: 01-794 0202



The problem with buying a home computer, as you may already have discovered, is there's often very little software to go with it. Or all that is available is games, games and more games.

There's no such problem, however, with the Commodore 64. It has a more extensive range of serious software than any other home computer.

It also has an unusually large (in fact elephantine) 64K memory, as well as every peripheral you're ever likely to need.

Put simply, this means the computer has the capacity to run more interesting, entertaining and complex programs.

You can teach yourself just about any subject

you care to mention, even computer programming.

And for the office there are programs like word processing, financial planning, information storage and stock control.

Finally, when you're mentally exhausted, you can even entertain yourself – yes, with games.

When all's said and done, however, we do have to admit that in one respect the Commodore 64 is up with the competition. It costs around £229, much less than any comparable machine.

And that's a fact we hope you'll never ever forget.

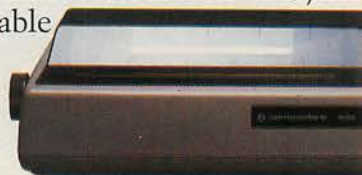



When you have an enormous memory there's no end to the things you can do.

Please send me further information on: the 64 computer 64 software
 disk drive cassette unit printers monitor

Name (Mr. Mrs. Miss) _____

Address _____

Send to: The Commodore Information Centre, 675 Ajax Avenue, Slough, Berkshire SL1 4BG. Or telephone (0753) 79292.



6S PCO 0384

● Circle No. 185

Please be brief

THIS SECTION of Open File is for the IBM PC and its numerous emulators. Actually, any routines in Basic or Microsoft's GWBasic are acceptable, which means most pseudo 16-bit micros. If you send programs on disc they must be IBM PC readable.

When sending contributions, please try to make them either original or short — or preferably both. While some fascinating programs have been received already, most have been several pages long. About 100 lines of code is the maximum that is likely to be used. And even if we had room to publish anything longer, would anyone have the time to key it in?

Creation

The first offering this month is Creation from Paul Myerscough of north London. It is very short: what it does is throw IBM characters on to the screen at random, while the sound routine makes a noise like Hollywood's idea of a computer. On our PC, Breaking the program produces an interesting ruled screen.

Menu

The second program is Menu from John Lewis of Oxford. It can be loaded automatically by an Autoexec.Bat file after the Keyboard U.K. routine — see pages 6 to 31 of the DOS handbook for an explanation of how to do this.

Menu is written for version 2 of Basic, which lists files four across, so it will need to be modified if you have version 1.05, which lists them six across the screen. It works by setting the colour of the characters on the screen to black, making them invisible. The Files command then displays on the screen an invisible directory of the disc. Using the screen command, each entry is read into an array — lines 100 to 190. A simple sort routine in lines 200 to 250 then arranges them alphabetically.

Then line 280 turns the display on again, and the files on the disc are displayed in three columns. A prompt on the bottom line of the screen asks you to input the number of the program required; alternatively you can look at the files on the other drive. If you choose the former option the program prints a reminder that function key F1 is programmed to recall the menu program, then after a short delay the program is Run.

If the response is an alpha character, it is checked to see if it is lower-case a or b. If so, it is changed to upper case in lines 540 or 550 so that the drive designation can be changed. The new designation is passed back to line 80, where the Files procedure is repeated.

Error routines at lines 520 and 600 take care of the cases where an invalid program number is entered or the wrong disc-drive letter is input. In line 60, only files with the .Bas extension are chosen. It would be possible to display all the files on a disc but since they may not run under Basic it would not serve much purpose.

Creation.

```
0 REM CREATION BY PAUL MYERSCLOUGH
10 CLS:KEY OFF
20 ROW = INT (RND*25)+1:COL=INT (RND*80)+1
30 ASCI=INT (RND*255)+1
40 IF ASCI>6 AND ASCI<14 THEN GOTO 30
50 IF ASCI>27 AND ASCI<33 THEN GOTO 30
60 ATTR1=INT (RND*17):ATTR2=INT (RND*2)+6
70 NOISE = RND*3000+1000
80 LOCATE ROW,COL:COLOR ATTR1,ATTR2
90 PRINT CHR$(ASCI);:SOUND NOISE,1
100 GOTO 20
```

Menu.

```
10 REM DISPLAYS A MENU OF BASIC PROGRAMS ON THE DISK
20 REM ADAPTED BY JOHN LEWIS DECEMBER 1983
30 DIM TITLE$(100)
40 KEY OFF
50 WIDTH 80
60 DRIVE$ = "A:*.BAS" 'ENSURES LOOKS AT DRIVE 'A' FIRST
70 KEY 1, "RUN" + CHR$(34) + "MENU" + CHR$(13) 'KEY 1 RUNS MENU
80 CLS : COLOR 0,0 'SETS COLOUR TO BLACK - INVISIBLE
90 FILES DRIVE$ 'GETS .BAS FILES
100 D$ = CHR$(SCREEN(1,1)) 'GETS DRIVE LETTER
110 FOR SR$ = 2 TO 24 'ROW ON SCREEN
120 FOR SC$ = 0 TO 55 STEP 18 'FOUR COLUMNS DISPLAYED
130 IF CHR$(SCREEN(SR$,SC$+1)) = " " THEN 200 'STOP WHEN NO MORE NAME
140 PR$ = PR$ + 1 'ARRAY NUMBER
150 FOR LZ = 1 TO 8 'READ FIRST 8 CHARACTERS
160 TITLE$(PR$) = TITLE$(PR$) + CHR$(SCREEN(SR$,SC$+LZ)) 'BUILD UP TITLE
170 NEXT LZ
180 NEXT SC$
190 NEXT SR$

200 FOR NZ = 1 TO PR$ - 1
210 FOR PZ = NZ + 1 TO PR$
220 IF TITLE$(PZ) < TITLE$(NZ) THEN 260
230 NEXT PZ
240 NEXT NZ

250 GOTO 280
260 Z$ = TITLE$(PZ) : TITLE$(PZ) = TITLE$(NZ) : TITLE$(NZ) = Z$
270 GOTO 230
280 COLOR 7,0
290 LOCATE 1,32 :PRINT "Basic Programs on Drive ";D$

300 FOR PS$ = 1 TO 53 STEP 26 'DISPLAY IN 3 COLUMNS
310 FOR SR$ = 3 TO 23 'ON ROWS 3 TO 23
320 .PS$ = PS$ + 1 'ARRAY NUMBER
330 IF TITLE$(PS$) = "" THEN 380 ELSE LOCATE SR$,SC$
340 PRINT USING "###";PS$ ;
350 PRINT " ";TITLE$(PS$)
360 NEXT SR$
370 NEXT PS$

380 R$ = "" : LOCATE 25,1 : PRINT SPACE$(70) ;
390 LOCATE 25,1:PRINT "Enter number of program required or disk letter " ;
400 I$ = INKEY$
410 PRINT I$ ;
420 IF I$ = CHR$(13) THEN 460
430 IF I$ = "" THEN 400
440 R$ = R$ + I$
450 GOTO 400
460 FOR T = 1 TO 1000 : NEXT
470 IF ASC(R$) > 64 THEN 540 'CHECKS FOR ALPHA OR NUMERIC
480 IF VAL(R$) < 1 OR VAL(R$) > PR$ THEN 520
490 LOCATE 25,1 : PRINT " Remember F1 runs the menu program " ;

500 FOR TZ = 1 TO 3000 : NEXT
510 IF D$ = "A" THEN RUN TITLE$(VAL(R$)) ELSE RUN "B:" + TITLE$(VAL(R$))
520 LOCATE 25,1:PRINT "Please enter a number which refers to a program shown";
530 FOR TX = 1 TO 4000 : NEXT : GOTO 380 'DELAY TO READ ERROR MESSAGE
540 IF ASC(R$) = 97 THEN R$ = "A" 'CONVERTS a TO A
550 IF ASC(R$) = 98 THEN R$ = "B" 'CONVERTS b TO B
560 IF R$ = "A" OR R$ = "B" THEN DRIVE$ = R$ + "/*.BAS"
570 FOR XZ = 1 TO PS$ : TITLE$(XZ) = "" : NEXT
580 PR$ = 0 : PS$ = 0
590 GOTO 80
600 LOCATE 25,1:PRINT "Please enter a valid drive letter - either A or B
"; : GOTO 530 'SPACE TO CLEAR EXISTING LINE
```

Flexibility for Spectrum users!



56-way I.D.C. connector and ribbon cable assembly, designed and manufactured by Varelco in conjunction with C.P.S. Ltd., to fit the Sinclair Spectrum computer. Available in both single and double end format. Also available, paddle board to convert female connector to male plug format.

Please send me the following:

		Insert Quantity here
6" grey cable with connector each end	£8.99 each	<input type="text"/>
9" grey cable with connector each end	£9.49 each	<input type="text"/>
9" colour coded cable with one connector	£5.99 each	<input type="text"/>
12" colour coded cable with one connector	£6.49 each	<input type="text"/>
Connector only	£4.95 each	<input type="text"/>
Paddle board for conversion to male plug format	£1.99 each	<input type="text"/>

Prices include VAT and Post & Packing
I enclose cheque/PO value £

Block capitals please

Name
Address
Town
County Post Code



If paying by Access, enter number here

Available from:

Hawnt Electronics Limited
Firswood Road, Garretts Green, Birmingham B33 0TQ
Reg. in England No. 306808 PC3/84

● Circle No. 186

SKILLS TRAINING

- 'dBASE II' User & Programming
- Advanced 'dBASE II' Techniques

NEW

- WordStar
- MailMerge
- SuperCalc

For further details, please contact:

The Training Dept.,
LANTECH Information Systems Ltd.
55 Peascod St., WINDSOR, Berks.

Tel Windsor 58182

LANTECH
Information Systems

● Circle No. 187



The First Name In Computer Packaging



Ring us on 01-607 9938 for quotations on computer presentation packs and sleeves printed in one to four colours.

● Circle No. 188

(continued from previous page)

```

525 X%(I) = INT ( RND (1) * 20 +
      1):Y%(I) = 2: IF A%(X%(I),Y%
      (I)) < > 0 THEN 525
530 DRAW 12 AT X%(I) * 10,Y%(I) *
      10 + 30:A%(X%(I),Y%(I)) = 12
      :I = 0:F = 0:SC = SC + 30
535 SCALE= 2: ROT= 16: DRAW 27 AT
      MX * 10 - 5,MY * 10 + 15:Z =
      USR (3900): XDRAW 27 AT MX *
      10 - 5,MY * 10 + 15: SCALE=
      1: ROT= 0: DRAW 27 AT MX * 1
      0,MY * 10 + 30:Z = USR (300
      0): XDRAW 27 AT MX * 10,MY *
      10 + 30:MX = 0:MY = 0: RETURN

574 REM ** MOVE YOU
575 XDRAW 11 AT YX * 10,YY * 10 +
      30:A%(YX,YY) = 0:YX = YX + D
      : IF YX < 1 OR YX > 20 THEN
      YX = YX - D
580 IF A%(YX,YY) = 13 OR A%(YX,Y
      Y) = 12 OR A%(YX,YY) = 15 THEN
      2000
585 DRAW 11 AT YX * 10,YY * 10 +
      30:A%(YX,YY) = 11: RETURN
599 REM **MAIN LOOP
600 K = PEEK ( - 16384): POKE -
      16368,0
605 IF K = 136 THEN D = - 1
610 IF K = 149 THEN D = 1
613 IF K = 13 THEN D = 0
615 IF FL > 0 AND D < > 0 THEN
      GOSUB 575
617 IF FL = 0 THEN 2000
620 IF K = 32 AND F = 0 THEN K =
      0:MX = YX:MY = YY - 1:F = 1:
      DRAW 14 AT MX * 10,MY * 10 +
      30:A%(MX,MY) = 14: FOR I = 2
      56 TO 300:Z = USR (I): NEXT

625 IF F = 1 THEN GOSUB 500
630 IF D < > 0 THEN FL = FL - 1
      : IF FL < = 0 THEN D = 0
635 IF FL > - 1 THEN HCOLOR= 0
      : HPLLOT 242,169 - FL TO 248,
      169 - FL: HCOLOR= 3
640 IF FI = 0 AND RND (1) > .3 THEN
      FI = 1: GOSUB 375
645 IF FI = 1 THEN GOSUB 300
650 GOSUB 200
655 IF F = 1 THEN GOSUB 500
660 IF FI = 1 THEN GOSUB 300
665 IF FL = 20 THEN FOR I = 1 TO
      4: FOR J = 20 TO 10 STEP -
      1:Z = USR (J * 256 + J): NEXT
      J,I
695 IF TS < > SC THEN GOSUB 70
      0
696 IF SC > HS THEN GOSUB 750
698 GOTO 600
699 REM ** UPDATE SCORE
700 SC# = STR# (TS): FOR I = 1 TO
      LEN (SC#)
705 NU = VAL ( MID# ((SC#),I,1))
      : IF NU = 0 THEN XDRAW 10 AT
      45 + I * 10,10: GOTO 713
710 XDRAW NU AT 45 + I * 10,10
713 NEXT :FC = FC + (SC - TS): IF
      FC > 130 THEN FC = 0:FL = 13
      0:PP = 1
715 TS = SC:SC# = STR# (SC): FOR
      I = 1 TO LEN (SC#): NU = VAL
      ( MID# ((SC#),I,1)): IF NU =
      0 THEN DRAW 10 AT 45 + I *
      10,10: GOTO 725
720 DRAW NU AT 45 + I * 10,10
725 NEXT : IF PP = 1 THEN PP = 0
      : GOSUB 10095
730 RETURN
749 REM ** HIGH SCORE
750 HS# = STR# (HS): FOR I = 1 TO
      LEN (HS#)
755 NU = VAL ( MID# ((HS#),I,1))
      : IF NU = 0 THEN XDRAW 10 AT
      215 + I * 10,10: GOTO 760
758 XDRAW NU AT 215 + I * 10,10
760 NEXT :HS = SC
765 HS# = STR# (HS): FOR I = 1 TO
      LEN (HS#): NU = VAL ( MID#
      ((HS#),I,1)): IF NU = 0 THEN
      DRAW 10 AT 215 + I * 10,10:
      GOTO 780
770 DRAW NU AT 215 + I * 10,10
780 NEXT : RETURN
1999 REM ** END GAME
2000 FOR I = 40 TO 10 STEP - 2:
      Z = USR (256 * I + 20): CALL
      787: NEXT : TEXT : HOME : POKE
      766, INT (HS / 256): POKE 76
      7,HS - PEEK (766) * 256
2005 VTAB 10: PRINT "YOU WERE DE
      STROYED,": PRINT : PRINT : PRINT
      "BUT YOU SCORED ":SC: PRINT
      : PRINT : PRINT "HIGH SCORE
      IS ":HS: POKE - 16368,0
2010 VTAB 24: INVERSE : PRINT "P
      RESS THE SPACEBAR TO PLAY AG
      AIN.....": GET A#: NORMAL
      : IF A# < > CHR# (32) THEN
      END
2015 CLEAR : RESTORE : CALL 6245
      0:HS = PEEK (766) * 256 + PEEK
      (767): HOME : ROT= 0: SCALE=
      1: DIM A%(20,16),X%(5),Y%(5)
      : GOSUB 10020: GOTO 600

10000 TEXT : HOME : INVERSE : PRINT
      SPC (54): NORMAL : PRINT "
      INTRUDERS ": INVERSE : PRINT
      SPC (73): NORMAL : PRINT "
      BY ": INVERSE : PRINT SPC(
      72): NORMAL : PRINT " P.WAL
      KLEY ": INVERSE : PRINT SPC(
      55): NORMAL
10005 PRINT : PRINT " DESTROY
      AS MANY ALIENS AS POSSIBLE":
      PRINT : PRINT "BEFORE YOU R
      UN OUT OF FUEL OR ARE": PRINT
      : PRINT "HIT."
10010 PRINT : PRINT "USE :-": PRINT
      : PRINT "THE ARROW KEYS TO M
      OVE,": PRINT : PRINT "RETUR
      N' TO STOP MOVING,": PRINT :
      PRINT "AND THE SPACE BAR TO
      FIRE."
10015 VTAB 24: INVERSE : PRINT "
      PRESS ANY KEY TO CONTINUE...
      .": GET A#: NORMAL
10020 FOR I = 1 TO 18: READ SH,X
      ,Y: DRAW SH AT X,Y: NEXT : IF
      PEEK (787) < > 169 THEN FOR
      I = 768 TO 815: READ C: POKE
      I,C: NEXT : POKE 10,76: POKE
      11,0: POKE 12,3
10025 DATA 25,0,10,16,10,10,23,2
      0,10,24,30,10,17,40,10
10030 DATA 20,120,10,21,130,10,1
      9,140,10,20,150,10,25,170,10
      ,16,180,10,23,190,10,24,200,
      10,17,210,10
10035 DATA 18,225,185,26,235,185
      ,17,245,185,22,255,185
10040 DATA 32,12,225,172,161,0,1
      73,160,0,32,168,252,173,48,1
      92,136,208,244,96,169,0,133,
      0,169,32,133,1,160,133,177,0
      ,73,255,145,0,230,0,208,246,
      230,1,165,1,41,31,208,238,96
10045 FOR I = 0 TO 4: HPLLOT I,14
      TO 1,191: HPLLOT 0,14 + I TO
      218,14 + I: HPLLOT 214 + I,14
      TO 214 + I,191: NEXT
10050 HPLLOT 240,170 TO 240,30 TO
      241,30 TO 241,170: HPLLOT 249
      ,170 TO 249,30 TO 250,30 TO
      250,170: HPLLOT 237,171 TO 25
      3,171 TO 253,172 TO 237,172
10055 FOR I = 35 TO 155 STEP 15:
      HPLLOT 239,I: HPLLOT 251,I: NEXT
10060 POKE - 16304,0: POKE - 1
      6302,0: POKE - 16300,0
10065 YX = 10:YY = 16: FOR I = 0 TO
      4: X%(I) = I * 4 + 2: Y%(I) =
      2: NEXT
10070 SC = 0:TS = 0:FL = 130:FC =
      0:IN = - 1
10075 DRAW 10 AT 55,10: IF HS =
      0 THEN DRAW 10 AT 225,10
10080 IF HS > 0 THEN GOSUB 765
10085 DRAW 11 AT YX * 10,YY * 10
      + 30:A%(YX,YY) = 11: FOR I =
      0 TO 4: DRAW 12 AT X%(I) * 1
      0,Y%(I) * 10 + 30:A%(X%(I),Y
      %(I)) = 12: NEXT
10090 Z = USR (7300):Z = USR (6
      300):Z = USR (8000):Z = USR
      (6300):Z = USR (8000):Z = USR
      (9150)
10095 QQ = 19: HCOLOR= 6: FOR I =
      0 TO FL: HPLLOT 242,170 - I TO
      248,170 - I
10100 IF I / 7 = INT (I / 7) THEN
      Z = USR (256 * QQ + 30):QQ =
      QQ - 1
10110 NEXT : HCOLOR= 3:Z = USR
      (8000): RETURN

```

Dyneer monitors... the perfect definition



THE DYNEER 14CMI Colour Monitor, pictured above, offers full IBM PC compatibility with 16 vivid colours.

Add to this the special dark glass, high-contrast CRT. This gives the user a crisp alpha-numeric display even in 80-column mode, whilst retaining true colour quality and balance.

Full IBM PC compatibility is also a major feature of the 12MHI, a 12 inch monochrome monitor featuring an anti-glare, P31, dark glass, chemically etched CRT. This high quality display incorporates high resolution – 900 lines minimum horizontal – with an unbeatable video amplifier response.

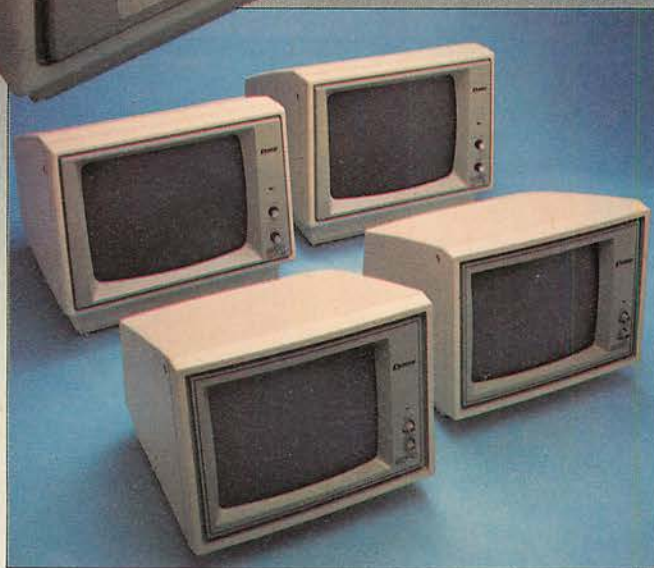

Two more monitors complete the Dyneer Family – the 14CHI is a Texas Instruments PC compatible Colour Monitor incorporating many features from the 14CMI, but offering even higher resolution and greater band-width.

The 12MHC is a Monochrome Monitor designed for composite video input requirements, but having exactly the same video attributes as the 12MHI.

And whether it's colour or mono, every Dyneer Monitor is built to the highest engineering standards and features the Dyneer Hallmarks – Quality, Reliability, and Unbeatable Price/Performance.

Ring us, and we'll tell you how.

X-DATA

THE NAME BEHIND
THE PRODUCTS IN FRONT

X-DATA LIMITED, 750 DEAL AVENUE, SLOUGH TRADING ESTATE, SLOUGH, BERKS SL1 4SH. TEL: SLOUGH (0753) 72331

a **Dyneer** company

The new Argus Above all, a true



Pro-personal. 16-bit computer.

On performance alone, the new Argus Pro-personal computer is way above the rest.

It's a true 8086-based 16-bit machine. And it's fast—8MHz.

Our Argus Pro-personal also gives you a choice of backing store from floppy right up to big Winchester, and memory up to 896K.

So you've got the capacity and speed for professional-sized programs, and that means savings in expensive professional time.

A NEW WORLD OF SOFTWARE

Running industry-standard CP/M-86[†], the Argus Pro-personal opens your door wide to a vast array of 16-bit application software.

Ferranti also supplies software packages for major applications such as word processing and spreadsheet calculations. Of course the Argus Pro-personal can also run your existing 8-bit software.

It adds up to all the power and capacity you need. Benchmark tests have proved it outperforms its competitors.

A COMPLETE PACKAGE PUTS YOU ONE UP

Right from the start the Argus Pro-personal gives you what you want. CP/M-86[†] and BASIC are included. So is 128K of memory—and it's all available to you because the VDU has its own memory for both alphanumeric and high resolution graphics.

Check this out against the competition.

A COMPUTER WITH THE HUMAN TOUCH

For all its professionalism, the Argus Pro-personal computer is easy to live with. It's user-friendly in every way. Compact and good

looking, with clear characters on an anti-reflective screen. The VDU tilts and swivels, and the keyboard, VDU and processor box can be placed to suit the operator.

CP/M-86[†] is menu-driven so it's easier to use.

IF YOU'RE LAUNCHING AN AUTOMATED OFFICE

The Argus Pro-personal with the rest of the Ferranti office product range allows access to mainframe computers, so if you want it to be part of a general office automation scheme, there's no problem.

YOU'RE ON FIRM GROUND WITH FERRANTI

Behind the Argus Pro-personal computer, a product at the leading edge of a fast moving technology, is a company with over 20 years in the computer business.

Ferranti has an unsurpassed reputation for quality assurance and reliability.

So, your investment is protected for the longest possible time. And you get a first-class maintenance service to back it up.

For a high-flying computer the Argus Pro-personal price tag is remarkably low level. It starts at just £2,800.

Ferranti Computer Systems Limited,
Simonsway, Wythenshawe,
Manchester M22 5LA.
Telephone: 061-499 3355, Telex: 668084

FERRANTI Computer Systems

Please show me how the Ferranti Argus Pro-personal computer can serve my computing needs.

Name _____

Position _____

Company _____

Address _____

Telephone _____ Telex _____

Ferranti Computer Systems Limited,
Simonsway, Wythenshawe
Manchester M22 5LA.

PC3/84

ARGUS
PRO-PERSONAL COMPUTER



● Circle No. 190

[†]CP/M-86 is a trademark of Digital Research Inc.

IS POOR SOFTWARE KEEPING YOU POOR ?

A good tool is worth its weight in gold.

GOLDEN TOOL

software for the 64.



SM TEXT64

The professional text processor with more than 80 functions to aid productivity; multi-colour display; up to 120 columns without extra hardware; search & replace; enhanced block handling; direct access to addresses in CUDA files; etc etc

ONLY £50

SM CUDA64

Your professional standard, personal address filing system. Direct access to 620 addresses per disk; 5 extra lines per address for comments; totally menu-driven; powerful editing and back up facilities; several hardcopy facilities.

ONLY £40

SM KIT64

The famous programming tool for Commodore micros. Extends BASIC – merge, find, re-number, dump, trace, enhanced floppy monitor (disk doctor), highly efficient machine language monitor with built-in assembler, disassembler, trace, and many other helpful features. A real golden tool!

ONLY £40

SM ISM64

This index sequential file manager gives you a new dimension on direct access file handling. Up to 40 keys, variable record lengths, simultaneous handling of 10 files. How can you program without such a tool?

ONLY £40

SM MAE64

The definitive tool for the would-be master of the 64. If you are ready for programming in assembler, buy it now. Not for beginners, this tool will help you to fashion masterpieces of the programmer's art. Coexists with Commodore BASIC.

ONLY £40

PLACE YOUR ORDER NOW!

If your Commodore dealer cannot supply, contact us direct. Cheque with order please. Prices include vat, packing and carriage within the UK. Allow 7 days for delivery. All programs on disk and described in detail in a manual.

Prices firm to end 1983



SM SOFTWARE (UK) Ltd
Raglan House, Long Street
Dursley Glos.
tele: 0453 46065 & 2101



Part of the SM Software group, supplying international software.

Dealer enquiries invited.

Telephone monitor

WITH TELEPHONE charges as high as they are, it is useful to be able to keep an eye on the cost of a call as it is being made. Michael Gerrard of Slough has written this useful program which monitors the progress of the call, displaying its time and cost.

The program is designed for use on the Pet, but will also work with a Commodore 64. First ask it for the type of call being made — local, up to 56km., etc. — and the charging rate — cheap, standard or peak. The screen then displays all the necessary

information, including the number of units used, and the cost so far, including VAT.

There is a timer shown at the bottom right of the screen which shows how much of the current unit is remaining, so that a call can be terminated just before the cost of the next unit is incurred.

All the current charges for calls to the U.K. and Eire are included in Data statements in lines 210 to 250, and lines 185 and 190 hold the current VAT rate and unit charge, all of which are easily changed when phone charges rise. At the end of

every unit, a bell sounds.

The only drawback of the program is the time and effort needed to load it before every phone call, but if a number of expensive calls are made, then it is well worthwhile. There is scope for development of such a program, including the addition of a facility to log the details of each call on cassette, disc or printer once the call is complete. I would also like to see something like this written in machine code and put into a ROM so that it is available at all times with a minimum of keystrokes.

```

100 REM*****
110 REM*
120 REM* TELEPHONE CHARGE PROGRAM *
130 REM* (C) M GERRARD 1983 *
140 REM*
150 REM*****
160 REM* DATA TABLE SHOWING TIME *
170 REM* (IN SECS) OF ONE UNIT: *
180 REM*****
185 DATA 15 :REM* VAT %
190 DATA 4.4 :REM* UNIT COST
200 REM CHEAP, STAND, PEAK UNIT LENGTH
210 DATA 480, 120, 90:REM* LOCAL
220 DATA 144, 45, 30:REM* AREA A
230 DATA 48, 16, 12:REM* AREA B
240 DATA 60, 20, 15:REM* AREA B1
250 DATA 15, 8, 8:REM* TO EIRE

300 REM** READ ARRAY
310 READ TAX,U
320 DIMC(5,3)
330 FOR X=1TO5:FOR Y=1TO3
340 READ C(X,Y)
350 NEXT Y:NEXT X

400 REM** INPUT DETAILS OF CALL
410 PRINT"PLEASE GIVE DETAILS OF CALL TO BE COSTED":RESTORE:READTAX,U
420 PRINT:PRINT:PRINT"TYPE OF CALL:"
430 PRINT:PRINT L) LOCAL CALL
440 PRINT:PRINT A) CALLS UP TO 56KM (35 M)"
450 PRINT:PRINT B) CALLS OVER 56KM (35 M)"
460 PRINT:PRINT C) OVER 56KM-LOW COST ROUTE";
470 PRINT:PRINT I) TO IRISH REPUBLIC"
480 PRINT:PRINT O) OTHER."
490 GETA$:IFA$="L"THENX=1:GOTO600
500 IFA$="A"THENX=2:GOTO600
510 IFA$="B"THENX=3:GOTO600
520 IFA$="C"THENX=4:GOTO600
530 IFA$="I"THENX=5:GOTO600
540 IFA$="O"THENX=C:Y=0:GOTO560
550 GOTO490
560 INPUT"LENGTH OF EACH UNIT (IN SECONDS)";C(0,0)
570 PRINT:PRINT:INPUT"HOW MANY PENCE IS EACH UNIT ";U
580 GOTO700
600 PRINT:PRINT"CHARGE RATE : "
610 PRINT:PRINT C) CHEAP (6PM-8AM & W/E)";
620 PRINT:PRINT S) STANDARD (1PM-6AM,8-9AM)";
630 PRINT:PRINT P) PEAK (9AM-1PM)"
640 GETB$
650 IFB$="C"THENY=1:GOTO700
660 IFB$="S"THENY=2:GOTO700
670 IFB$="P"THENY=3:GOTO700
680 GOTO640

700 PRINT" ":REM** SCREEN DISPLAY
710 PRINT" "
720 PRINT" | TYPE RATE UNIT TIME UNIT COST | "
730 PRINT" | | | | | "

```

(continued on next page)

Subscribe Now!

Make sure of your copy every month. Practical Computing is mailed direct to subscribers in a strong polythene wrapper, ensuring that it arrives folded and in good condition.

Free information!

Make Practical Computing work for you! Use the reader enquiry service to obtain information about hardware and software products before you buy them.

Place a regular order!

Even if you don't want to subscribe you can still ensure a regular supply of newsagents. Fill in the order form and pass it to your newsagent to reserve your personal copy of Practical Computing.

Please send me Practical Computing each month for 12 months:

Practical Computing SUBSCRIPTION ORDER FORM

I enclose cheque/PD to the value of £13.00 (UK) £19 (Overseas). Cheques should be made payable to Business Press International Ltd.

OR

Please debit my credit card account:

Enter number

Tick relevant box:

Access Barclaycard/Visa Diners Club American Express

Signed _____ Date _____

Name _____

Address _____

Job Title (if any)

Type of Business (if any)

Do you own a computer? Yes No

Do you have access to a computer? Yes No

If so please state type

Number of Employees (if any) Please tick box

1 2 3 4 5 6 7 8 9
1-24 25-49 50-99 100-249 250-499 500-999 1000-1999 2000-4999 5000+

Registered in England 151537
Registered Office: Quadrant House, The Quadrant, Sutton, Surrey SM2 5AS.

MARCH 1984 PCO 8463

(This card is valid for 6 months only)

To obtain free information about items advertised in this issue circle the appropriate enquiry numbers listed below:

101	102	103	104	105	106	107	108	109	110	111	112	113	114	115	116	117	118	119	120	121	122	123	124
125	126	127	128	129	130	131	132	133	134	135	136	137	138	139	140	141	142	143	144	145	146	147	148
149	150	151	152	153	154	155	156	157	158	159	160	161	162	163	164	165	166	167	168	169	170	171	172
173	174	175	176	177	178	179	180	181	182	183	184	185	186	187	188	189	190	191	192	193	194	195	196
197	198	199	200	201	202	203	204	205	206	207	208	209	210	211	212	213	214	215	216	217	218	219	220
221	222	223	224	225	226	227	228	229	230	231	232	233	234	235	236	237	238	239	240	241	242	243	244
245	246	247	248	249	250	251	252	253	254	255	256	257	258	259	260	261	262	263	264	265	266	267	268
269	270	271	272	273	274	275	276	277	278	279	280	281	282	283	284	285	286	287	288	289	290	291	292
293	294	295	296	297	298	299	300	301	302	303	304	305	306	307	308	309	310	311	312	313	314	315	316
317	318	319	320	321	322	323	324	325	326	327	328	329	330	331	332	333	334	335	336	337	338	339	340
341	342	343	344	345	346	347	348	349	350	351	352	353	354	355	356	357	358	359	360	361	362	363	364
365	366	367	368	369	370	371	372	373	374	375	376	377	378	379	380	381	382	383	384	385	386	387	388
389	390	391	392	393	394	395	396	397	398	399	400	401	402	403	404	405	406	407	408	409	410	411	412
413	414	415	416	417	418	419	420	421	422	423	424	425	426	427	428	429	430	431	432	433	434	435	436

Job Title (if any)

Type of Business (if any)

Do you own a computer? Yes No

If so please state type

Please remove include my name for business direct mail.

No of Employees (if any) Please tick box

1 2 3 4 5 6 7 8 9
1-24 25-49 50-99 100-249 250-499 500-999 1000-1999 2000-4999 5000+

HAND THIS CARD TO YOUR NEWSAGENT

Practical Computing NEWSAGENT ORDER FORM

Why not place a regular monthly order for Practical Computing with your local newsagent? Just fill in the coupon and hand it to your newsagent.

Please order a copy of Practical Computing for me every month until further notice.

Commencing

I will call and collect it

Please deliver to my home address
(Tick appropriate box)

Name

Address

Date

**PRACTICAL COMPUTING
SUBSCRIPTION MANAGER
BUSINESS PRESS INTERNATIONAL LTD
OAKFIELD HOUSE
PERRYMOUNT ROAD
HAYWARDS HEATH
SUSSEX RH16 3DH**

Postage
will be
paid by
licensee

Do not affix Postage Stamps if posted in
Gt Britain, Channel Islands, N Ireland
or the Isle of Man

BUSINESS REPLY SERVICE
Licence No CY711

**PRACTICAL COMPUTING
READER SERVICE DEPARTMENT
OAKFIELD HOUSE
PERRYMOUNT ROAD
HAYWARDS HEATH
SUSSEX RH16 3DH**

2

**HAND THIS
CARD TO YOUR
NEWSAGENT**

NOW WITH 16-BIT MASTER PROCESSOR

Mini's too expensive

For a multi-user business system expandable to 16 screens you used to need a sizeable mini, say from **DEC** or **Burroughs**, with a hefty price-tag for hardware and software, with long time-scales.

Micro's too small

Micros, like **Altos**, **Sage** and **Rair**, 8-bit or 16-bit, are doomed by CPU degradation, being based on the time-sharing principle. PCs, like **IBM** and **Apricot/Sirius**, just aren't in this league at all, networked or otherwise.



SuperStar multi-user system...

...is just right

SuperStar is a multi-processor system in which up to sixteen 16-bit processors, each with up to 1Mb RAM, are integrated in an active desk-top unit. All users can work at top speed in genuine multi-user, multi-tasking mode with full file/record locking and spooling.

At half the price of a mini and a give-away price for the world's largest selection of software, **SuperStar** is just right for any multi-user application.

£5975 buys a complete 2-user high-performance system, with 10Mb Winchester and 2 users. Additional users for £995 each, including terminal and processor.

Supports all **CP/M** and **MS-DOS** programs as well as the wide range of **BROMCOM** genuine multi-user software.

BROMCOM

7-421 Bromley Road, Bromley, Kent BR1 4PJ
Tel: 01-697 8933 Telex 896691 TLX1RG

Local, Dealer and Overseas enquiries are welcomed.



SuperStar is a trade mark of Bromley Computer Consultancy. CP/M is a trade mark of Digital Research. MS-DOS is a trade mark of MICROSOFT.

SuperStar-16 has a 16-bit Master Processor which runs IMPOS (BROMCOM designed true 16-bit controlling operating system). IMPOS supports CP/M, MS-DOS and shortly Xenix in slave processors in any combination and it is fully upward compatible with ACTION DPC/OS, Televideo MmmOST and TurboDOS.

DIRECT DISK SUPPLIES

OUR NAME SPEAKS FOR ITSELF

FREE OFFERS!

*SEE 10 LIBRARY BOX WITH EVERY 10 DISKS

*VIDEO TAPE (E180 VHS/BETAMAX) WITH EVERY 30 DISKS

4 Star Service

What Direct Disk Supplies means:

- ★ Value for money
- ★ Top quality disks
- ★ DIAL-A-DISK telephone ordering
- ★ Immediate despatch

NO-NONSENSE WARRANTY

Full exchange or refund if not satisfied. Your satisfaction is our best advertisement. Our parent company has been selling mail-order for 7 years.

DDS PRICE MATRIX

Easy pricing. Use the DDS Price Matrix for the right price first time. Or DIAL-A-DISK, for firm quoted prices.

	BASF				Verbatim® Datalife 5 year warranty				maxell®				FUJI			
	CODE	1-3	4-9	10+	CODE	1-3	4-9	10+	CODE	1-3	4-9	10+	CODE	1-3	4-9	10+
5.25" single sided disks																
s/density 48tpi soft sect	1SSD	16.99	15.99	14.99												
d/density 48tpi soft sect	1SDD	19.99	18.99	17.99	525.01	21.99	20.99	19.99	MD1-D	23.99	22.99	21.99	MD1D	24.99	23.99	22.99
d/density 48tpi 10 sect	1SDD/10	19.99	18.99	17.99	525.10	21.99	20.99	19.99	MH1-10	23.99	22.99	21.99				
d/density 48tpi 16 sect	1SDD/16	19.99	18.99	17.99	525.16	21.99	20.99	19.99	MH1-16	23.99	22.99	21.99				
q/density 96tpi soft sect	1/96	26.99	25.99	24.99	577.01	27.99	26.99	25.99	MD1-DD	31.99	30.99	29.99	FUJI disks are high-grade Japanese quality at a price you can justify. You know the film, try the disk. It's phenomenal Fuji.			
q/density 96tpi 10 sect	1/96/10	26.99	25.99	24.99	577.10	27.99	26.99	25.99	Maxell quality, consistently high. Keenest prices.							
q/density 96tpi 16 sect	1/96/16	26.99	25.99	24.99	577.16	27.99	26.99	25.99								
5.25" double sided disks																
d/density 48tpi soft sect	2SDD	26.99	25.99	24.99	550.01	28.99	27.99	26.99	MD2-D	31.99	30.99	29.99	MD2D	32.99	31.99	30.99
d/density 48tpi 10 sect	2SDD/10	26.99	25.99	24.99	550.10	28.99	27.99	26.99	MH2-10	31.99	30.99	29.99	If you're used to quality, you'll recognise FUJI.			
d/density 48tpi 16 sect	2SDD/16	26.99	25.99	24.99	550.16	28.99	27.99	26.99	MH2-16	31.99	30.99	29.99				
q/density 96tpi soft sect	2/96	34.99	33.99	32.99	557.01	35.99	34.99	33.99	MD2-DD	41.99	40.99	39.99				
q/density 96tpi 10 sect	2/96/10	34.99	33.99	32.99	557.10	35.99	34.99	33.99	You'll never regret buying Maxell. It even looks right.							
q/density 96tpi 16 sect	2/96/16	34.99	33.99	32.99	557.16	35.99	34.99	33.99								
p&p per 10 disks		.95	.65	foc		.95	.65	foc		.95	.65	foc		.95	.65	foc
See 10 library boxes		1.95	1.95	1.75	Prices per box of 10 disks exc. VAT. Next-day delivery service per ORDER:- All orders under 100 disks £7.50. Orders of 100 disks, or mixed orders of similar value are shipped FREE OF CHARGE. Same day delivery:- By despatch rider, cab, TNT, or Red-Star. Subject to quotation.											
p&p per box		.50	.50	foc												
ABA Lockable disk boxes Smoked perspex lockable lid																
model M35 - 40 disks		14.99	13.99	POA												
model M85 - 80 disks		17.99	16.99	POA												
p&p per lockable box		1.75	1.25	foc												

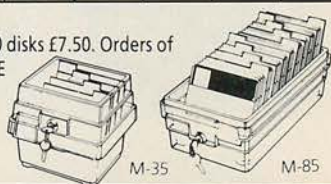

DIAL-A-DISK

- Order Hotline.

01-541 1144

Call Richard Mortimore or Felix Benzimra, to order your disks. Our answering service will record your order out of hours.

HOW TO ORDER:

1. Complete the coupon below and post with your cheque. Use our FREEPOST address for minimum cost, or send first class for extra speed.
2. Urgent orders:- DIAL-A-DISK. 01-541. 1144. Dictate your order with a credit card number and they're as good as received. COLLECT FROM OUR OFFICES - phone and they will be waiting for you. From 10.00 to 17.00 Weekdays. (Other times by arrangement).
3. Crucial Orders Same day service, phone 01-541 1144 to arrange. We guarantee you will receive them. If not we'll refund the carriage.
4. Official orders - Orders from Official bodies are very welcome (eg Govt. Depts. Local Authorities, Universities etc.). Tenders for large purchases will receive immediate attention and low bulk prices. Urgent official orders by telex to 932905 (LARCH G).

APRICOT DISKS - Sony 3.5" micro-disks

Ex-Stock Only £39.95 + VAT

LISA DISKS - DIAL-A-DISK for our prices. Ex-stock

BARGAIN BOX

BASF disks at low, low prices. **£12.99** + VAT. BASF 1SSD single sided single density disks (BASF equivalent for Dysan 104/1). APPLE, COMMODORE 64, VIC-20, BBC, or any other single density machine. Why pay more for unused double density, they don't last any longer!

£14.99 + VAT BASF 1SDD single sided double density disks (BASF equivalent for Verbatim 525-01, Dysan 104/1D). Special prices are so low that promotion items are excluded. A chance to buy at genuinely low prices, offer ends 30th April 1984, so don't hesitate. DIAL-A-DISK... 01-541 1144.

All offers and prices subject to change without notice. Video tape offer ends 30th April 1984.

Direct Disk Supplies Ltd., 29 Dagmar Road, Kingston, Surrey KT2 6BR

To: Direct Disk Supplies Ltd., FREEPOST, 29 Dagmar Road, Kingston, Surrey KT2 6BR.

Code	Qty	Description	Price
E180		E180 videotape per 30 disks*	foc

*excluding Bargain Box

Name _____ Net price _____
 Address _____ Carriage _____
 Subtotal _____
 Postcode _____ Tel _____ VAT 15% _____
 Total payable to DDS **£** _____

Cheques payable to DDS. Debit my Access/Barclaycard No: _____

Signature: _____

• Circle No. 157



```

1000 DIM P(18,8): DIM D(8)
1001 LET RNM=31832: LET ROM=1561
1002 FOR N=0 TO 7: LET D(N+1)=2+
N: NEXT N: RETURN
1003 REM CHAR EDIT
1004 LET X=0: LET Y=0
1005 PRINT AT Y+11,X+20; FLASH 1; INK 0
1006 PRINT AT Y+11,X+20; FLASH 1; INK 0
1007 IF R#="R" OR R#="r" THEN PR
: PAPER 0; FLASH 1; INK 7
1008 IF R#="S" OR R#="s" THEN PR
: PAPER 0; FLASH 1; INK 7
1009 IF R#="B" OR R#="b" THEN PR
: PAPER 0; FLASH 1; INK 7
1010 LET Y=Y+(R#="6")-(R#="7"): LET X
=X+(R#="0")-(R#="1"): GO TO 1066
1011 REM CHAR EDIT
1012 FOR B=0 TO 7: FOR R#="0" TO 7
1013 PRINT AT R+11,B+20; INK 0;
PAPER 7; " " : NEXT B: NEXT R: RET
URN
1014 REM SAVE SET
1015 GO SUB 1028: RETURN
1016 REM LOAD SET
1017 LOAD F#CODE 31832,938
1018 GO SUB 1028: RETURN
1019 REM SAVE SET
1020 SAVE F#CODE 31832,938
1021 VERIFY F#CODE 31832,938
1022 INPUT "FILENAME: "; LINE F#
1023 IF LEN F#>10 THEN GO TO 1102
1024 RETURN
1025 REM PICTURE EDIT
1026 LET X=0: LET Y=0
1027 REM PICTURE EDIT
1028 REM PEEK 20730+250*PEEK 2
0731-PEEK 20853-250*PEEK 20854

```

Charles Cowan has sent in a strategy-
 type game for two players called Four in
 One. Each player selects a colour, either red
 or blue, and takes a turn in placing a square
 of a chosen colour in one of eight columns,
 which are filled from the bottom of the
 screen. The winner is the first player to
 make a vertical, horizontal or diagonal line
 of four squares of the chosen colour. The
 game may end in a draw if neither succeeds.

Four in One

```

1108 PRINT OVER 1; FLASH 1; AT Y+
11,X+5; " ": PAUSE 20
1110 LET R#=INKKEY$: IF R#="" THEN THE
N GO TO 1110
1112 IF R#="S" OR R#="s" THEN GO
SUB 1128
1114 IF R#="R" OR R#="r" THEN PR
INT FLASH 1; AT Y+11,X+5; " ": LET
P(Y+1,X+1)=" "
1116 PRINT OVER 1; AT Y+11,X+5; "
: INK 0; PAPER 0; FLASH 1
1068 PAUSE 10
1070 LET R#=INKKEY$: IF R#="" THEN THE
N GO TO 1068
1072 IF R#="S" OR R#="s" THEN PR
: PAPER 0; FLASH 1; INK 7
1074 IF R#="R" OR R#="r" THEN PR
: PAPER 0; FLASH 1; INK 7
1076 PRINT AT Y+11,X+20; FLASH 0; RET
URN
1078 IF CODE R#="0" THEN RETURN
1080 LET X=X+(R#="0")-(R#="5"):
1082 LET Y=Y+(R#="6")-(R#="7"): LET X
=X+(R#="0")-(R#="1"): GO TO 1066
1083 REM CHAR EDIT
1084 FOR B=0 TO 7: FOR R#="0" TO 7
1085 PRINT AT R+11,B+20; INK 0;
PAPER 7; " " : NEXT B: NEXT R: RET
URN
1087 REM SAVE SET
1088 GO SUB 1028: RETURN
1089 REM LOAD SET
1090 LOAD F#CODE 31832,938
1091 VERIFY F#CODE 31832,938
1092 INPUT "FILENAME: "; LINE F#
1093 IF LEN F#>10 THEN GO TO 1102
1094 RETURN
1095 REM SAVE SET
1096 SAVE F#CODE 31832,938
1097 VERIFY F#CODE 31832,938
1098 GO SUB 1028: RETURN
1099 REM LOAD SET
1100 LOAD F#CODE 31832,938
1101 GO SUB 1028: RETURN
1102 INPUT "FILENAME: "; LINE F#
1103 IF LEN F#>10 THEN GO TO 1102
1104 RETURN
1105 REM PICTURE EDIT
1106 LET X=0: LET Y=0
1107 REM PICTURE EDIT
1108 LET X=0: LET Y=0
1109 IF COLUMN>8 THEN GO TO 180
1110 IF COLUMN=0 THEN GO TO 180
1111 LET COLUMN=URL (C$)
N: ANY OTHER KEY TO STOP; I$
IF I#="" THEN GO TO 70
STOP

```

Four in One.

(continued from previous page)

DISKPOST

* BETTER VALUE MAIL ORDER SUPPLIES FOR YOUR MICRO *

TDK DISKS



High grade flexible disks from one of the world's most famous suppliers. 5 1/4" and 8" disks, in boxes of 10.

5.25" DISKETTES

M10-S	S/S, D/D, 48 TPI	£24.30
M20-S	D/S, D/D, 48 TPI	£34.80
M2DX-S	D/S, D/D, 96 TPI	£45.50

48 TPI suitable for 35 or 40 track operation.
96 TPI suitable for 77 or 80 track operation.

8" DISKETTES

F1-S128	S/S, S/D	£27.60
F1-H32	S/S, S/D	£27.60
F2D-S1024	D/S, D/D	£40.10

DATALIFE DISKS



From Verbatim, the world's leading diskette manufacturer. Full 5 year warranty. All minidisks are certified for double density recording, and are fitted with hub ring reinforcement as standard. Prices per box of 10 disks.

5.25" DISKETTES

MD525	S/S, D/D, 48 TPI	£18.25
MD550	D/S, D/D, 48 TPI	£27.15
MD577	S/S, D/D, 96 TPI	£25.55
MD557	D/S, D/D, 96 TPI	£34.20

48 TPI suitable for 35 or 40 track operation.
96 TPI suitable for 77 or 80 track operation.
10 and 16 hard sectored versions available at same prices.

8" DISKETTES

FD34-9000	S/S, S/D	£26.10
FD34-8000	S/S, D/D	£26.60
DD34-4001	D/S, D/D	£30.95

32 hard sectored versions available at same prices.

XIDEX DISKS



The new premier quality standard, against which all other manufacturers will have to be judged. All products certified for double density recording. Now with a lifetime warranty. Unreservedly recommended. Prices per box of 10 disks.

5.25" DISKETTES

5012-1000	S/S, D/D, 48 TPI	£19.55
5022-1000	D/S, D/D, 48 TPI	£27.55
5012-2000	S/S, D/D, 96 TPI	£27.75
5022-2000	D/S, D/D, 96 TPI	£35.80

48 TPI suitable for 35 or 40 track operation.
96 TPI suitable for 77 or 80 track operation.
10 and 16 hard sectored versions available at same prices.

8" DISKETTES

8012-1000	S/S, D/D	£26.40
8022-1000	D/S, D/D	£31.90

32 hard sectored versions available at same prices.

TDK CASSETTES

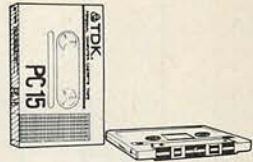

You know the name and the quality's the same. 15-minute computer grade cassettes for optimum performance in all standard microcomputer cassette drives. In boxes of 10.

TDK PC15 £5.90

DISK DRIVE HEAD CLEANING KITS



Helps to protect your valuable data, and minimise expensive downtime and repair costs. Consists of a flexible jacket, which receives a pre-saturated cleaning disk. Each disk is sealed within a foil sachet to ensure that it contains the right quantity of cleaning fluid when used. After use the disk is disposed of, and the jacket is kept for future use.

Suitable for single or dual head drives. Please specify 8" or 5.25" disks.

STARTER KIT £7.70
(contains jacket and two cleaning disks)

REPLACEMENT CLEANING KITS £14.80
(pack of 10)

DISKETTE STORAGE BOXES

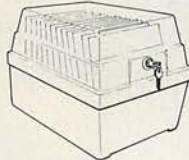

Protect your diskettes and valuable data from external contamination. Lockable, portable and secure. Two part box made from anti-static ABS plastic. Price includes dividers and index labels. Capacity 80 disks.

A5 Storage box (for 8" disks) £32.00
A6 Storage box (for 5.25" disks) £22.00

CTI - CP80 PRINTER



Features:-

Friction and tractor feed as standard
80 c.p.s.
Bi-directional logic seeking.
13 x 9 dot matrix giving true descenders.
Sub and superscripts.
Italic printing and auto underlining.
Condensed, emphasised, expanded and double strike printing (can be mixed in a line).
Parallel interface fitted as standard.
12 month warranty.

Print sample available on request.
CP-80 PRINTER £249.00
Optional RS-232 interface £40.00
Special VIC20/VIC 64 interface £46.00

PRINTER STAND

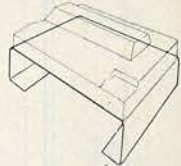

Suitable for use with dot matrix printers. Lifts printer sufficiently to enable continuous stationery to self-stack. Painted steel unit. Dimensions: 39cm wide x 28cm deep x 10cm high

Comes as package which also contains:-

200 sheets continuous stationery.
1 x 9 1/2" binder.
1 x highlighter pen.
choice of rubber feet/sticky pads.

PRINTER STAND £19.95

COMPUTER FURNITURE



Suitable for use with all leading personal computers. Features a top shelf for monitor/printer, lower shelf for books, paper and general storage; large desk top surface at keyboard height; attractive teak finish, and castors for mobility.



U.K. Manufacture. Comes in flat pack for self assembly - full instructions provided.

A further range of more sophisticated units is available - please ask for details.

THE ORGANISER £55.00

To: DISKPOST, FREEPOST, WEST MOLESEY, SURREY, KT8 0QF. Tel: 01-941 4066

All prices inclusive of delivery and insurance on British mainland.

Qty	Product	Price	YOUR NAME
.....	£	ADDRESS
.....	£
.....	£
.....	£	Tel. No.:
Sub Total		£	Please charge to my Visa/Mastercharge/American Express/Diners Club account.
Delivery/Insurance		£ FREE	My card number is
V.A.T.		£	  
TOTAL VALUE OF CHEQUE PAYABLE TO DISKPOST		£	Credit Card Orders
Company Orders			We welcome Visa, (Barclaycard), Mastercharge, (Access), Diners Club and American Express. There is no credit card surcharge. Either write your card number on your order, or telephone your order to our sales office.

* NEW 1984 PRICES *

DISKPOST

DISKPOST* is the mail order division of the BFI Electronics Group Europe's largest independent diskette supplier.

FREEPOST West Molesey
Surrey KT8 0QF. Tel: 01-941-4066

● Circle No. 196

THE RAINBOW 10



0 + HAS ARRIVED

In the deluge of computers, at last there's a ray of light.

The Rainbow 100+ personal computer. The latest addition to the Rainbow range from Digital.

It allows you to cope with increasing business demands by having a more powerful memory. (Up to 896Kb for the technically minded.)

It lets you change programmes from CP/M to MS DOS by simply pressing a key. (When using the integral 10MB Winchester Disk drive.)

A choice of monitors is available. High resolution monochromes or colour,

for graphics and text.

Lotus 1-2-3 has been added to the leading range of software that already covers most types of businesses.

Two days at one of our 25 personal computer training courses are included in the price of £4,200.

As are full customer support, and twelve month on-site servicing warranty.

And of course our telephone helpline.

Call our Customer Information Centre on 0256 59299 for more about the new Rainbow 100+.

Think of it as the pot of gold.

1-2-3 is a Trade Mark of Lotus Development Corporation.

● Circle No. 247

digital™



EVERY commodore **64** DESERVES A DATABASE

No matter what your business or interest, with **Superbase 64** you have a totally flexible 'record' system, as big as you want it, as fast as you need it.

Create your own formats, enter your records, change layouts and data fields.

Superbase 64 gives you unrivalled control in home or office, business or professional practice, with an extensive range of features.

Superbase 64

The complete information control system for the Commodore 64. By the authors of "Easyscript", the Commodore No. 1 word processing system.

Precision Software Limited
6 Park Terrace
Worcester Park, Surrey KT4 7JZ
Telephone: 01-330 7166
Telex: 8955021. PRECIS G

● Circle No. 198

ACOUSTIC COVERS

Whispering Sound Sense



- Stop the disruptive effect of a noisy printer (Noise reductions of up to 90% possible)
- Available for all makes of printer
- Top quality at **very competitive** prices
- Full range of printers and accessories available
- Detailed information available immediately

Please send me information on AWS Acoustic Covers
Please send me your Computer & Word Processor Supplies Catalogue

Name

Company

Address

Tel No.

AWS Computer Supplies Ltd, 57 Surbiton Road, Kingston-upon-Thames, Surrey KT1 2HG Tel: 01-541 1188

PC3/84

● Circle No. 177

Superbase 64

TRANSFORMS THE COMMODORE 64 INTO A FULL-FEATURED AND PROFESSIONAL DATABASE SYSTEM! WITH UP TO 1000 CHARACTERS PER RECORD ON UP TO 4 SCREENS... AND UP TO 128 ITEMS PER RECORD, DEFINABLE AS KEY, TEXT, NUMERIC, CONSTANT, RESULT OR DATE... IN FILES OF UP TO 16M CHARACTERS!

SUPERBASE EVEN HAS SPREADSHEET AND CALCULATOR CAPABILITY, CALENDAR FUNCTIONS, EASY INPUT FROM WORDPROCESSOR/DATA FILES, BOTH MENU-DRIVEN AND PROGRAM OPTIONS, SORTING/SEARCHING, FULLY DEFINABLE OUTPUTS... SUPERBASE 64 IS ESSENTIAL IF YOU WANT THE MOST FROM YOUR 64! SUPPLIED ON CBM 1541 DISK WITH EXCELLENT TUTORIAL/REFERENCE MANUAL. EX-STOCK NOW!

● OUR PRICE ONLY ~~199.95~~ £88!

VIZAWRITE 64

NOW AVAILABLE ON CARTRIDGE, VIZAWRITE 64 IS A HIGH-PERFORMANCE, LOW-COST WORD PROCESSOR, WITH ON-SCREEN FORMATTING, THAT TAKES FULL ADVANTAGE OF THE 64'S COLOUR, GRAPHICS AND MEMORY FEATURES... AND SUPPORTS VIRTUALLY ANY PRINTER! WITH A COMPREHENSIVE AND EASY-TO-FOLLOW USER MANUAL, VIZAWRITE OFFERS THE ULTIMATE IN PERSONAL COMPUTER WORD PROCESSING! ALSO AVAILABLE ON DISK (OUR PRICE ~~199.95~~ £68!), OR COMBINED WITH VIZASPELL (OUR PRICE ~~199.95~~ £85!).

● OUR PRICE ONLY ~~189.95~~ £75!

Master 64

MASTER 64 IS A TOTALLY NEW CONCEPT... A COMPLETE PROGRAM DEVELOPMENT PACKAGE, THAT'S AVAILABLE NOW FOR THE CBM 64. MASTER HAS 85 NEW COMMANDS... AND BASIC IV TOO! PLUS PROGRAMMER'S TOOLKIT, MACHINE CODE MONITOR, BUSINESS BASIC, KEYED DISK ACCESS, SCREEN MANAGEMENT, USER-DEFINABLE INPUT ZONES, REPORT GENERATOR, 22-PLACE ARITHMETIC, DATE CONTROL, STRING FUNCTIONS, DISK DATA COMPRESSION, SCREEN PLOTTING, SCREEN DUMP, AND MORE... IN FACT EVERYTHING YOU NEED TO PROGRAM YOUR 64 TO TOP PROFESSIONAL STANDARDS! (SCREEN MANAGEMENT, TOOLKIT, HI-RES GRAPHICS AND DOS SUPPORT ARE AVAILABLE SEPARATELY ON CARTRIDGE - £49.50). MASTER IS ALSO AVAILABLE FOR CBM 700 (£339.25) AND CBM 4032/8032/8096 (~~199.95~~ £225!).

● SPECIAL OFFER PRICE ~~143.75~~ £115!

THESE ARE JUST SOME OF OUR FINE SOFTWARE PRODUCTS FOR COMMODORE COMPUTERS... PLEASE TELEPHONE OR WRITE FOR FREE DATA SHEETS! PRICES SHOWN INCLUDE 15% VAT AND ARE CORRECT AT TIME OF GOING TO PRESS. ORDER BY POST/TELEPHONE/PRESTEL, USING CHEQUE, ACCESS, BARCLAY CARD OR OFFICIAL ORDER. TELEPHONE 01-546-7256 FOR SAME-DAY DESPATCH! POST FREE EXCEPT ON CREDIT/OVERSEAS ORDERS. (REF A25)

Calco Software

LAKESIDE HOUSE, KINGSTON HILL, SURREY KT2 7DT TEL 01-546-7256

● Circle No. 178

Disc copier

CP/M'S PIP utility is the standard means of copying from one disc to another. This program by Dave Lane of Herne Bay Secondary School in Kent provides an improved alternative when you want to copy the entire side of a disc. Its advantages are that it is faster, performs error checking, copies everything including CP/M, and automatically initialises the drive, eliminating the annoying Read Only error which careless use of Pip can give.

Each disc sector is checked for Read and Write errors and all are reported, although execution continues regardless. Copying a

disc surface on to itself is therefore permitted and performs a useful verification function.

To assemble the program use the following procedure, which assumes that the disc in drive A has on it CP/M, TXED, ZASM, and the CP/M program Load. Load TXED and create the source text file using

A>TXED DSKCPY.ZSM

Type in the Assembler program from the listing, ignoring the two left-hand columns which contain hexadecimal numbers. Comments and the preceding semicolons

may also be omitted. Start from ORG 100H and finish with End. Exit from TXED with

*EX\$\$

Load ZASM and assemble the source file
A>ZASM DSKCPY.AAA
If any errors are reported, reload TXED and correct them.

Create the machine code .COM file with
A>LOAD DSKCPY
There are now a multitude of DSKCPY files on the disc. DSKCPY.COM is the end result. It is executed by typing:
A>DSKCPY

```

A>TYPE DSKCPY.PRN
;DSKCPY D.LANE H.B.S.S. 1983
;RML 380Z MDS (or FDS) COS 3.4M
0100 ORG 100H
;calls to monitor
000D = CR EQU 00DH
0019 = INIT EQU 19H
001A = RDSEC EQU 1AH
001C = WRCHK EQU 1CH
1000 = BADD EQU 1000H
0017 = MSG EQU 17H
0021 = KBDW EQU 21H
0001 = OUTC EQU 01H
0013 = GETHEX EQU 13H
0015 = BYTED EQU 15H
0100 C33602 JP START
;disk controls blocks used by RDSEC & WRCHK
0103 00 RUNIT: 00H
0104 00 RTRACK: 00H
0105 00 RSECT: 00H
0106 0000 RADDR: 00H,00H
0108 00 WUNIT: 00H
0109 00 WTRACK: 00H
010A 00 WSECT: 00H
010B 0000 WADDR: 00H,00H
;output store used by BYTED
010D 0000B0 HEXOUT: 00H,00H,80H
;messages
0110 5741524E M0: 'WARNING - overwrites destination disk',80H
0136 4469736B M1: 'Disk Copy. D.Lane. H.B.S.S',80H
0151 536F7572 M2: 'Source Drive ? ',80H
0161 44657374 M3: 'Destination Drive ? ',80H
0176 496E7365 M4: 'Insert Disks then press RETURN ',80H
0196 52656164 M5: 'Read Error... ',80H
01A5 57726974 M6: 'Write Error.. ',80H
01B4 436F7079 M7: 'Copy complete ',80H
01C3 44726976 M8: 'Drive ',80H
01CA 436F7079 M9: 'Copying....',80H
01D6 54726163 M10: 'Track....',80H
01E0 20536563 M11: 'Sector ',80H
;error messages
01E9 57726974 E6: 'Write protect',80H
01F7 57726974 E5: 'Write fault',80H
0203 5265636F E4: 'Record not found',80H
0214 43524320 E3: 'CRC error',80H
021E 44617461 E2: 'Data lost',80H
0228 44617461 E1: 'Data mismatch',80H
0236 213601 START: LD HL,M1
0239 F717 EMT MSG
023B 3E0D LD A,CR
023D F701 EMT OUTC
023F 211001 LD HL,M0
0242 F717 EMT MSG
0244 3E0D LD A,CR
0246 F701 EMT OUTC
0248 215101 SOURCE: LD HL,M2 ;get source drive
024B F717 EMT MSG
024D F713 EMT GETHEX
024F 3E0D LD A,CR
0251 F701 EMT OUTC
0253 7D LD A,L ;check valid
0254 D60A SUB 0AH
0256 320301 LD (RUNIT),A
0259 FE04 CP 04H ;bad...retry
025B 30EB JR NC,SOURCE
025D C641 ADD 41H
025F 21C301 LD HL,M8
0262 F717 EMT MSG
0264 F701 EMT OUTC
0266 3E0D LD A,CR
0268 F701 EMT OUTC
026A 216101 DEST: LD HL,M3 ;get dest. drive
026D F717 EMT MSG
026F F713 EMT GETHEX
0271 3E0D LD A,CR
0273 F701 EMT OUTC
0275 7D LD A,L ;check valid
0276 D60A SUB 0AH
0278 320B01 LD (WUNIT),A
027B FE04 CP 04H ;bad...retry
027D 30EB JR NC,DEST
027F C641 ADD 41H
0281 21C301 LD HL,M8
0284 F717 EMT MSG
0286 F701 EMT OUTC
0288 3E0D LD A,CR
028A F701 EMT OUTC
028C 217601 INDSK: LD HL,M4 ;insert disks
028F F717 EMT MSG
0291 3E0D LD A,CR
0293 F701 EMT OUTC
0295 F721 GETCR: EMT KBDW
0297 FE0D CP 0DH
0299 20FA JR NZ,GETCR
029B DD210301 LD IX,RUNIT ;initialise rdrive
029F F719 EMT INIT
02A1 FE0D CP 0H
02A3 20E7 JR NZ,INDSK ;error
02A5 DD210B01 LD IX,WUNIT ;initialise wdrive
02A9 F719 EMT INIT
02AB FE0D CP 0H
02AD 20DD JR NZ,INDSK ;error
;copying routine follows
02AF 21CA01 LD HL,M9
02B2 F717 EMT MSG
02B4 3E0D LD A,CR
02B6 F701 EMT OUTC
02B8 0600 LD B,00H
02BA 78 NXTTRK: LD A,B ;display track
02BB 210D01 LD HL,HEXOUT
02BE F715 EMT BYTED
02C0 21D601 LD HL,M10
02C3 F717 EMT MSG
02C5 210D01 LD HL,HEXOUT
02C8 F717 EMT MSG
02CA 3E0D LD A,CR
02CC F701 EMT OUTC
02CE 110010 LD DE,BADD ;read sector
02D1 0E01 LD C,01H
02D3 78 NXTRS: LD A,B
02D4 320401 LD (RTRACK),A
02D7 79 LD A,C
02D8 320501 LD (RSECT),A
02DB ED530601 LD (RADDR),DE
02DF DD210301 LD IX,RUNIT
02E3 F71A EMT RDSEC
02E5 FE0D CP 00H ;any errors?
02E7 2808 JR Z,ROKAY
02E9 219601 LD HL,M5 ;'READ' error
02EC F717 EMT MSG
02EE CD3B03 CALL ERROR ;report type & sector
02F1 210001 ROKAY: LD HL,100H
02F4 19 ADD HL,DE
02F5 EB EX DE,HL
02F6 0C INC C
02F7 79 LD A,C
02FA FE11 CP 11H
02FB 20D7 JR NZ,NXTRS ;next sector
02FC 110010 LD DE,BADD ;write sector
02FF 0E01 LD C,01H
0301 78 LD A,B
0302 320901 LD (WTRACK),A
0305 79 LD A,C
0306 320A01 LD (WSECT),A
0309 ED530B01 LD (WADDR),DE
030D DD210B01 LD IX,WUNIT
0311 F71C EMT WRCHK
0313 FE0D CP 00H ;any errors?

```

(continued on next page)

(continued from previous page)

```

0315 2808      JR Z,WOKAY
0317 21A501    LD HL,M6      :WRITE error
031A F717      EMT MSG
031C CD3B03    CALL ERROR      :report type & sector
031F 210001    WOKAY: LD HL,100H
0322 19        ADD HL,DE
0323 EB        EX DE,HL
0324 0C        INC C
0325 79        LD A,C
0326 FE11      CP 11H          :( or 1BH on FDS )
0328 20D7      JR NZ,NXTWS    :next sector
032A 04        INC B
032B 78        LD A,B
032C FE28      CP 28H          :( or 4DH on FDS )
032E C2BA02    JP NZ,NXTTRK   :do next track
0331 21B401    LD HL,M7      :all done
0334 F717      EMT MSG
0336 3E0D      LD A,CR
0338 F701      EMT OUTC
033A C9        RET
033B CB77      ERROR: BIT 6,A  :identify error
033D 2803      JR Z,B5
033F 21E901    LD HL,E6
0342 CB6F      B5: BIT 5,A
0344 2803      JR Z,B4
0346 21F701    LD HL,E5
0349 CB67      B4: BIT 4,A
034B 2803      JR Z,B3
034D 210302    LD HL,E4
0350 CB5F      B3: BIT 3,A
0352 2803      JR Z,B2

0354 211402    LD HL,E3
0357 CB57      B2: BIT 2,A
0359 2803      JR Z,B1
035B 211E02    LD HL,E2
035E CB4F      B1: BIT 1,A
0360 2803      JR Z,REPORT
0362 212802    LD HL,E1
0365 F717      REPORT: EMT MSG      :display error type
0367 21E001    LD HL,M11
036A F717      EMT MSG
036C 79        LD A,C          :and sector
036D 210D01    LD HL,HEXOUT
0370 F715      EMT BYTED
0372 210D01    LD HL,HEXOUT
0375 F717      EMT MSG
0377 3E0D      LD A,CR
0379 F701      EMT OUTC
037B C9        RET
0000          END

035E B1        0357 B2        0350 B3        0349 B4        0342 B5
1000 BADD     0015 BYTED  0000 CR        026A DEST  0228 E1
021E E2      0214 E3      0203 E4      01F7 E5      01E9 E6
033B ERROR   0295 GETCR  0013 GETHEX   010D HEXOUT  028C INDSK
0019 INIT    0021 KBDW   0110 M0       0136 M1     0106 M10
01E0 M11     0151 M2       0161 M3     0176 M4     0196 M5
01A5 M6      01B4 M7       01C3 M8     01CA M9     0017 M56
02D3 NXTRS   02BA NXTTRK  0301 NXTWS   0001 OUTC   0106 RADDR
001A RDSEC   0365 REPORT  02F1 ROKAY   0105 RSECT  0104 RTRACK
0103 RUNIT   0248 SOURCE  0236 START   010B WADDR  031F WOKAY
001C WRCHK   010A WSECT   0109 WTRACK  0108 WUNIT

No errors

```

Plotting.

```

C>TYPE GOBLET.BAS
10 REM GOBLET -- BY DANIEL FREEMAN (A 3D GRAPHICS PROGRAM.)
20 PUT 12
30 FOR Q=1 TO 9
40 READ X(Q),Y(Q)
50 NEXT Q
60 FOR B=2 TO 100
70 CALL"RESOLUTION",0,0
80 CALL"OFFSET",-160,-50
90 FOR C=1 TO 9
100 LET A#="PLOT"
110 FOR D=0 TO 7.854 STEP 6.283/B
120 CALLA#,X(C)*COS(D),Y(C)+X(C)*0.2*SIN(D),1
130 LET A#="LINE"
140 IF C=1 THEN NEXT D,C
150 CALL"PLOT",X(C-1)*COS(D),Y(C-1)+X(C-1)*0.2*SIN(D),1
160 CALL"LINE",X(C)*COS(D),Y(C)+X(C)*0.2*SIN(D),1
170 NEXT D
180 NEXT C
190 NEXT B
200 DATA 50,0,50,10,5,10,5,40,40,40,75,100,65,100,30,45,0,45

```

```

C>TYPE GOBLET2.BAS
10 REM GOBLET2 -- BY DANIEL FREEMAN (A 3D GRAPHICS PROGRAM.)
20 PUT 12
30 FOR Q=1 TO 9
40 READ X(Q),Y(Q)
50 NEXT Q
60 INPUT"NUMBER OF SIDES";B
70 CALL"RESOLUTION",0,0
80 CALL"OFFSET",-160,-50
90 FOR G=0 TO 6.3 STEP 0.1
100 CALL"DISPLAY",0,6*10
110 CALL"UPDATE",0,6*10-1
120 CALL"FILL",-76,-20,75,120,0
130 FOR C=1 TO 9
140 LET A#="PLOT"
150 FOR D=0 TO 7.854 STEP 6.283/B
160 CALLA#,X(C)*COS(D+G),Y(C)+X(C)*0.2*SIN(D+G),1
170 LET A#="LINE"
180 IF C=1 THEN NEXT D,C
190 CALL"PLOT",X(C-1)*COS(D+G),Y(C-1)+X(C-1)*0.2*SIN(D+G),1
200 CALL"LINE",X(C)*COS(D+G),Y(C)+X(C)*0.2*SIN(D+G),1
210 NEXT D
220 NEXT C
230 NEXT G
240 GOTO 90
250 DATA 50,0,50,10,5,10,5,40,40,40,75,100,65,100,30,45,0,45

```

```

C>
TYPE GOBLET3.BAS
10 REM GOBLET3 -- BY DANIEL FREEMAN (A 3D GRAPHICS PROGRAM.)
20 PUT 12
30 FOR Q=1 TO 9
40 READ X(Q),Y(Q)
50 NEXT Q
60 INPUT"STEPPING BY";B
70 CALL"RESOLUTION",0,0
80 CALL"OFFSET",-160,-50
90 FOR G=0 TO 6.2 STEP B
100 FOR C=1 TO 9
110 LET A#="PLOT"

```

```

120 FOR D=0 TO 7.854 STEP 6.283
130 CALLA#,X(C)*COS(D+G),Y(C)+X(C)*0.2*SIN(D+G),1
140 LET A#="LINE"
150 IF C=1 THEN NEXT D,C
160 CALL"PLOT",X(C-1)*COS(D+G),Y(C-1)+X(C-1)*0.2*SIN(D+G),1
170 CALL"LINE",X(C)*COS(D+G),Y(C)+X(C)*0.2*SIN(D+G),1
180 NEXT D
190 NEXT C
200 NEXT G
210 DATA 50,0,50,10,5,10,5,40,40,40,75,100,65,100,30,45,0,45

```

```

C>TYPE GOBLET4.BAS
10 REM GOBLET4 -- BY DANIEL FREEMAN (A 3D GRAPHICS PROGRAM.)
20 PUT 12
30 FOR Q=1 TO 9
40 READ X(Q),Y(Q)
50 NEXT Q
60 LET I=1
70 CALL"RESOLUTION",0,2
80 CALL"OFFSET",-160,-50
90 FOR G=0 TO 6.2 STEP .1
100 FOR C=1 TO 9
110 LET A#="PLOT"
120 FOR D=0 TO 7.854 STEP 6.283
130 CALLA#,X(C)*COS(D+G),Y(C)+X(C)*0.2*SIN(D+G),I
140 LET A#="LINE"
150 IF C=1 THEN NEXT D,C
160 CALL"PLOT",X(C-1)*COS(D+G),Y(C-1)+X(C-1)*0.2*SIN(D+G),I
170 CALL"LINE",X(C)*COS(D+G),Y(C)+X(C)*0.2*SIN(D+G),I
180 NEXT D
190 NEXT C
192 LET I=I+1
194 IF I=4 THEN LET I=1
200 NEXT G
210 DATA 50,0,50,10,5,10,5,40,40,40,75,100,65,100,30,45,0,45
220 FOR A=1 TO 3
230 CALL"COLOUR",A,255
240 LET A#="GET$(10)"
250 CALL"COLOUR",A,0
260 NEXT A
270 GOTO 220
C>

```

One-way ticket

```

5 * * * ONE WAY TICKET * * * BY
GEORGE SPELLER 1983
10 PDK16561,226:PDK16562,127:REM *
SET MEM SIZE AT 32738 *
20 *
30 * 25 DATA VALUES FOR PASSING SHIPS
+ FIVE FOR MUSIC *
40
DATA187,140,157,166,140,140,140,140,153
,174,140,183,40,35, 45,70,60
50 CLEAR800:DEFINT
N,A,B,C,D,E,G,K,L,I,F,S,H
60 INPUT"GAME1 OR 2":W:IFW=0 W=2
70 *
80 * * GENERATE PASSING SHIPS AND PUT
THEM INTO STRINGS *
90 FORN=1T06:
READA:READB:A#=#+CHR$(A):B#=#+CHR$(B)
: NEXT
100
D#=#STRING$(20,32):C#=#STRING$(64,32):
E#=#STRING$(40,32):A#=#C#+A#+D#+A#+C#:
B#=#C#+B#+E#+B#+C#
110 CR#=#CHR$(187)+CHR$(140)+CHR$(183)
120 BR#=#CHR$(132)+CHR$(179)+CHR$(136)
130 *
140 PDK16526,227:PDK16527,127 *
CHANGE TO DEFUS0=32739
* FOR DISK BASIC
150 FORN=1T05:READX(N):NEXT
160 GOTO1300
170 *
180 * * THIS SECTION SETS OUT THE GAME
BOARD *
190 * * GENERATES CITY SKYLINE ON
SCREEN AND MAKES INTO A STRING*
200 CLS
210 FORX=1T0127:SET(X,46):NEXT
220
FORX=1T0127:IFRND(2)=1THENSET(X,45)
230
NEXT:FORX=1T0127:IFRND(3)=1ANDPOINT(X,4
5)THENSET(X,44)
240
NEXT:FORX=1T0127:IFRND(4)=1ANDPOINT(X,4
4)THENSET(X,43)
250
NEXT:FORN=896T01022:T#=#+CHR$(PEEK(N+1
5360)):NEXT
260
PRINT@896,T#:#SET(127,46):SET(126,46)
270 *
280 * * MAKE THE LANDING PLATFORM *
290
X1=RND(64)+32:FORN=1T06:SET(X1,47-N):NE
XT
300 SET(X1-1,41):SET(X1+1,41)
310 *
320 * * SET POSITIONS OF CROSSING
SHIPS AND LANDING CRAFT *
330 C=RND(97):D=RND(100):E=RND(92)
340 H=460:V=0:X=RND(127):G=0
350 *
360 * * GAME LOOP STARTS HERE WITH
GRAVITATIONAL EFFECT *
365 * * PLUS MESSAGES AND SOUND *
370 V=V-1
380 PRINT@0,"FUEL
USED":G,"SPEED":V:CHR$(30):
390 K=PEEK(15359)
400 IFG)100THENPRINT@0," * FUEL OUT
**":CHR$(30):X=USR(1550):
XS=USR(1600):GOTO490
410 *
420 * * INTERPRETS KEYBOARD CONTROLS
AND OPERATES BOOST *
430 IFK=96THENV=V+2:G=6+2:GOTO490
440
IFK=32THENXL=XL-.2:XR=XR/1.1:V=V+1.5:G=
6+1:GOTO490
450
IFK=64THENXR=XR+.2:XL=XL/1.1:V=V+1.5:G=
6+1:GOTO490
460
IFK=128THENV=15:H=H+100:G=6+20:FORN=760
T0550STEP-6:
XS=USR(N):NEXT:IFG)100THEN400
470 *
480 * * MOVES LANDING CRAFT AND TESTS
FOR LANDING (OR CRASH!!) *
490 D=Y:Y=47-H/10
500 IFY)47THEN1010
510
IFD)=0ANDD=(47ANDP(127ANDP)ORESET(P,D)
520 IFY)00RX)127GRX)0THENS30
ELSEIFPOINT(X,Y)CRAFT
ELSESET(X,Y):XS=USR(768)
530 IFINT(Y)=40AND(INT(X)=X1
ORINT(X)=X1-1ORINT(X)=X1+1)THEN1130
540 H=H+V
550 P=X
560 X=X+XL:X=X+XR':IFXV)0THENXV=XV-.1
570 XL=XL*.95:XR=XR*.95
580 *
590 * * MOVE CROSSING SHIPS *
600 C=C-2:IFC)1C=92
610 PRINT@768,MID$(A#,C,64):
620 IFW=1THENFORT=1T075:NEXT:GOTO690
630 D=D+1:IFD)120THEND=1
640 PRINT@640,MID$(B#,D,63):
650 E=E-1:IFE)1THENE=92
660 PRINT@512,MID$(A#,E,64):
670 F=F+2:IFF)120THENF=1
680 PRINT@364,MID$(B#,F,63):
690 GOTO370
700 *
1000 * * CRASH ROUTINE *
1010 L=(X/2+INT(Y/3)+64)-1
1020
XS=USR(520):XS=USR(530):XS=USR(509):XS=
USR(550):
XS=USR(600):XS=USR(509):IFL)1022:FORN=1
T020:
PRINT@L,CR#:#PRINT@L,BR#:#PRINT@L,"
":NEXT)* 3 SPACES *
1030
IFX(127ANDX)ORANDY(47ANDY)0THENRESET(X,Y)
1040 IFY(44PRINT@L-6," "):
* 12 SPACES *
1050 FORT=1T040:NEXT:CLS
1060 PRINT@471,"YOU
CRASHED":FORT=1T060STEP3:XS=USR(330-T):
NEXT:FORT=1T070STEP5:XS=USR(270+T):NEXT
1070 PRINT" YOUR SCORE
TS":ST*10:" HIGHEST SCORE":
HS*10:PRINT@19)"PRESS BAR FOR NEW
GAME"* 10,5 SPACES *
1080 IFPEEK(15359)()128THEN1080
1090
IFPEEK(15359)()0THENXS=USR(256):GOTO109
0
1100 ST=0:SC=0:CLS:GOTO260
1110 *
1120 * * SUCCESSFUL LANDING ROUTINE *
1130 FORN=1T05:PRINT@0,"* * * YOU
LANDED * * * "
XS=USR(XS(N)):FORT=1T020:NEXT:PRINT@0,C
HR$(30): FORT=1T020:NEXT,N' * 8
SPACES *
1140 IFV=0
THENV=V-.5:SC=10*(100-G)/ABS(V):PRINT@6
" A PERFECT LANDING AT ZERO
VELOCITY-SCORE":SC*10: GOTO1160
1150 SC=10*(100-G)/ABS(V):
PRINT@12,"SPEED":V:" FUEL USED":G:"
SCORE":SC*10
1160 ST=ST+SC:SC=0: PRINT"
TOTAL SCORE":ST*10)* 20
SPACES *
1170 IFST)HS THENHS=ST
1180 PRINT" PRESS BAR
FOR REPLAY"* 17 SPACES *
1190 IFPEEK(15359)()128THEN1190
1200:
PRINT@0,"":FORN=1T03:PRINTCHR$(30):NEX
T
1210 ST=ST+SC:SC=0:RESET(X,Y)
1220 IFPEEK(15359)()0
THENXS=USR(256):GOTO1220
1230 FORT=1T0100:NEXT
1240 GOTO340
1300 CLS:PRINT@13,"* * * ONE WAY
TICKET * * * "
1310 PRINT"YOU HAVE LEFT YOUR ORBITING
SPACESHIP AND ARE IN"
1311 PRINT" A LANDING SHUTTLE. YOU HAVE
TWO RETRO ROCKETS."
1312 PRINT"ONE ON EACH SIDE, WHICH
FIRE AT AN ANGLE."
1313 PRINT"USE THEM SINGLY TO GET SIDE
THRUST AND SOME LIFT."
1314 PRINT"OR TOGETHER TO GIVE
UPTHRUST ONLY. USE THE LEFT"
1315 PRINT"AND RIGHT ARROW KEYS TO
CONTROL THEM."
1316 PRINT"YOU MUST LAND YOUR SHIP
WITH LEAST SPEED AND"
1317 PRINT"LEAST FUEL USED TO GET
MAXIMUM POINTS."
1318 PRINT"AVOID CROSSING SPACE SHIPS.
IN EMERGENCY USE"
1319 PRINT"BOOSTER (SPACE BAR).
PENALTY: 20 FUEL UNITS."
1330
FORN=0T028:READXP:PDK32739+N,XP:NEXT
1340
DATA205,127,10,76,69,62,1,211,255,16,25
4,69,16,254,69,62,
0,211,255,16,254,69,16,254,13,194,231,1
27,201
1350 PRINT"PRESS ((ENTER)) TO
BEGIN":INPUTZ#
1360 GOTO200

```

A GRAPHIC edition of the Moon Lander game comes from Mr George Speller. It is in real time and you have to dodge other spacecraft coming in from the side. Finally, you have to finish up on a landing pad which is on top of what looks like the Post Office tower in London. There are two levels of difficulty, labelled Game 1 and Game 2.

Although it is not mentioned in the instructions, your fuel is limited to 100 units. If injudicious use of fuel sends you off the screen you can still control the craft even though you cannot see it.

Sort routine

Mr R G C Bryant of Chesham, Buckinghamshire has sent in a sort routine in Basic. Except for very short sorts of less

than 50 items, Basic is very slow for this operation and a machine-language routine is necessary. Most DOSs incorporate a sort routine, so for disc users this is no problem, but we do not all have discs and to those who are deterred by the idea of incorporating machine language in their programs, I can recommend Mr Bryant's sort routine as one of the fastest I have seen in Basic.

The program includes a routine for setting up any required number of dummy items for testing purposes, which takes longer than the sort itself. Mr Bryant says that he uses it on the Model II, which is surprising since there is a good sort routine published by Tandy for TRS-DOS on the II. I tested it on the Model I and 50 items are sorted in less than 20 seconds. **[M]**

Sort routine.

```

10 CLEAR 10000:CLS
60 INPUT "NUMBER TO SORT":N
70 DIM W$(N),AC(26,2),Z(N)
80 * TEST ARRAY
90 FOR R=1 TO N:FOR R1=1 TO
RND(5)+5:W$(R)=W$(R)+CHR$(RND(26)+64):N
EXT R1:PRINTR;W$(R):NEXT R
130 PRINT"STARTING SORT NOW"
140 FOR A=1 TO
N:AC=ASC(W$(A))-64:AC(AC,1)=AC(AC,1)+1:
NEXT A
150 FOR A=1 TO
26:TT=TT+AC(A,1):AC(A,2)=TT+1-AC(A,1):
NEXT
160 A=0
170 A=A+1:IF A=N+1 THEN GOTO 250
180 AC=ASC(W$(A))-64:N1=AC(AC,2):N2=N1
190 IF W$(A)W$(Z(N1-1)) THEN
Z(N1)=A:AC(AC,2)=N2+1:GOTO 170
200 Z(N1)=Z(N1-1):AC(AC,2)=N2+1
210 N1=N1-1:GOTO 190
250 CLS:FOR A=1 TO
N:PRINTW$(Z(A)):NEXT

```

LVL COMPUTERTOWN

Whether its your first computer or whether you're already a enthusiast, LVL COMPUTERTOWN offers you the quality of service you expect from experts. If you invest money, you go a bank or a broker - a specialist who can guide and advise you on the best return for your capital. At LVL COMPUTERTOWN we're specialists too. We're there to help guide you through the micro maze, keep you up to date on innovations, help you get the best value for money, whether your computer is for you, your children or your business. Your computer can change your life - make sure you change it for the better: Come and talk to the experts and move into micros with LVL COMPUTERTOWN



A REFLECTION OF SUPERIORITY

(WHICH EVER WAY YOU LOOK AT IT).

£39.95

The Bell & Howell/LVL Computer Compatible Data Recorder.

- Automatic Level Control
- Automatic Tape Stop
- Tape Counter
- Remote Motor Control.

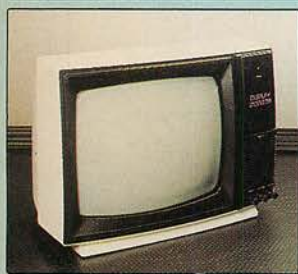

MONITORS



SABA 14" COLOUR MONITOR/
COLOUR TV.

£274.

MICROVITEC 14" Colour Monitor
£247.25

BBC MICROCOMPUTER

- MODEL A £299
- MODEL B £399
- MODEL B with ECONET £446
- MODEL B with DOS £469
- Model B with DOS & ECONET
..... £516



DECCACOLOUR

14" Colour Monitor
£247.25

SANYO

12" Green Screen
£102.35

PRINTERS



£503.70



£734.85

EPSON FX-80

An astonishing 160 characters per second, proportional spacing, quick forms tear-off, superscripts, subscripts, dot addressable graphics and down loadable character set.

TRI-WRITER

- * IT'S A PORTABLE COMPUTER TERMINAL!
- * IT'S A LETTER QUALITY COMPUTER PRINTER
- * IT'S A FULL FEATURE ELECTRONIC TYPEWRITER

SOFTWARE

DESIGNED FOR THE BBC MICROCOMPUTER

LANGUAGES	
ASP	£16.85
ORTH	£16.85
GAMES	
Monsters	£9.95
Mapper	£9.95
Planetoid	£9.95
Decade Action	£11.90
Socket Raid	£9.95
Meteors	£9.95
Scadians	£9.95
Ending-Block Puzzle	£9.95
Tube Master	£9.95
Marship Command	£9.95
Booker	£9.95
Super Invaders	£9.95
Upper	£9.95
Olditz	£9.95
Doctor Who	£10.00
White Knight II	£10.00
Missile Base	£9.95
draughts & Reversi	£9.95

ADVENTURES	
Philosophers Quest	£9.95
Castle of Riddles	£9.95
Countdown to Doom	£9.95
Sphinx Adventure	£9.95

GENERAL	
Desk Diary	£9.95
Creative Graphics	£9.95
Graphs & Charts	£9.95
Tool Box	£21.00
Record Keeper	£13.80
Magic Garden	£9.95

EDUCATIONAL	
Business Games	£9.95
Tree of Knowledge	£9.95
Peeko Computer	£9.95
Algebraic Manipulation	£9.95
Word Sequencing	£11.90
Missing Signs	£11.90
Number Balance	£11.90
Word Hunt	£11.90
Density Circuit	£11.90
Chemical Analysis	£13.80
Chemical Structures	£13.80
Jars	£11.90
Vu-Type	£16.10

BOOKS

GENERAL	
Programming for the BBC	£8.95
Advanced User Guide	£12.95

CORN	
Creative Graphics	£7.50
Graphs and Charts	£7.50
North Book	£7.50
Map Book	£7.50
View Guide	£2.50
Go to View	£2.50
CPL User Manual	£15.00

BBC	
The Computer Book	£6.75
The Book of Listings	£3.75
30hr. Basic	£5.95
Beyond Basic	£7.25
The Friendly Computer	£4.50
Sound & Graphics	£7.95



The items featured represent a very small selection from our vast product range. Further information of both product and services available can be obtained by telephoning or visiting our nearest LVL Computertown Dealer.

CHESHIRE

C-TECH SOFTWARE
184, Market St.
HYDE
Cheshire
061 366 8223
* COMPUTER CITY
78, Victoria Rd.
WIDNES
Cheshire
051 420 3333
* OAKLEAF COMPUTERS
100, Boughton
CHESTER
0244 310099

CUMBRIA

* THE COMPUTER SHOP
56/58 Lowther St.
CARLISLE
Cumbria
0228 27710

ESSEX

A.C.L.
1, Northmall
GRAYS, ESSEX
0375 79834
BROADWAY MUSIC
AND VISION
Woodford Green
ESSEX
01 504 7500

GREATER MANCHESTER

* LOMAX
8, Exchange St.,
St. Annes Square.
MANCHESTER
061 832 6167

WORC'S

SPURTREE COMPUTING
LTD.
Council Buildings,
Teme Street,
TENBURY WELLS,
Worcestershire
0584 811353/811304

MERSEYSIDE

* THORNGUARD
46, Pensby Rd.
HESWALL
The Wirral,
Merseyside
051 342 7516

NOTTS'

* BASIC BUS. SYS.
Trent Boulevard
WEST BRIDGFORD
Nottingham
0602 819713
S P ELECTRONICS
48, Linby Rd.
HUCKNALL
Notts.
0602 640377

LEASALINK VIEWDATA Ltd
230, Derby Rd.
STAPLEFORD
Notts.
0602 399484

OXFORD

ABSOLUTE SOUND
AND VIDEO (Oxford) Ltd.
19, Old High St, Headington
OXFORD
0865 65961

AVON

K & K COMPUTERS
32, Alfred Street,
WESTON SUPERMARE
Avon
0934 419324
COLSTON COMPUTER
CENTRE LTD.
The Colston Centre,
11, Colston Ave.,
BRISTOL
0272 276619

WARWICKSHIRE

CARVELL
9, Bank St.
RUGBY
Warwickshire
0788 65275

WEST MIDLANDS

RICHARD MORRIS
523, Bearswood Rd.
Smethwick
WARLEY
021 429 1161
JBC MICRO SERVICES
200 Earlsdon Ave.,
Nth. Earlsdon
COVENTRY
0203 73813

WILTSHIRE

WILTSHIRE MICRO
CENTRE
Unit 6,
Central Trading Estate,
Signal Way,
Old Town,
SWINDON
0793 612299

BUCKS'

HI-VU ELECTRONICS
38, Church St. Wolverton
MILTON KEYNES
Bedford
0908 312808

SUSSEX

C.J.E. MICROS
78, Brighton Rd.
WORTHING
West Sussex
0903 213900

ISLE OF WIGHT

EXCELL
4, Foreland Rd.
BEMBRIDGE
Isle of Wight
098 387 2578

YOUR LOCAL



DEALER

HEREFORD

KEMPSONS
26, St. Owen St.,
HEREFORD
0432 273480

KENT

KENT MICRO
57, Union St
MAIDSTONE
Kent.
0622 52784
GRAVESEND
COMPUTERS
39, The Terrace,
GRAVESEND
0474 50677

NORTHANTS'

M A ELECTRICAL
7, High St.
IRLINGBORO
N'Hants
0933 650133

LEICESTER

PERCY LORD & SON
63, Blaby Rd.
WIGSTON
Leicester.
0533 785033

LINCOLNSHIRE

* OAKLEAF COMPUTERS
121, Dudley Rd.
GRANTHAM
0476 70281

LONDON

CANNONBURY RADIO
185 Upper St.
ISLINGTON N1
London
01 226 9392
PAUL ELECTRICAL
250/2, Grand Drive,
Raynes Park,
LONDON SW20
01 542 6546
WOODS RADIO
257, Lavender Hill,
Battersea,
LONDON
01 228 1768

SALOP

MEDLICOTT BROS
53, Mardol
SHREWSBURY
Shropshire
0743 3060

SUFFOLK

SJ EMERY & CO.
10, Market Place
BUNGAY,
Suffolk
0986 2141

IRELAND

EVERYMAN COMPUTER
SERVICES
BALLYMONEY
Co-Antrim
N. Ireland
026 56 62658
NEWBURN
ELECTRONICS
BALLYCARRY
Co.-Antrim,
09603 78330

STAFFS

J W BAGNALL
18, Salter St.,
STAFFORD
0785 3420

KIRKLANDS

City Rd., Fenton.
STOKE ON TRENT
0782 415787

* COMPUTERAMA

59, Foregate St.
STAFFORD
0785 41899

SURREY

* HASLEMERE COMPS
25, Junction Place,
HASLEMERE
Surrey
0428 53850
P & H ELECTRONICS
5, The Parade,
Reading Road,
YATELEY
Surrey.
0252 - 877 222

* Spectrum Members

LANCASHIRE

* P V MICROS
38A Water St.
ACCINGTON
Lancs.
0254 36521
Home & Business
Computers Ltd.
54, Yorkshire Street,
OLDHAM
061 633 1608
Home & Business
Computers (RCH) Ltd.
73, Yorkshire Street,
ROCHDALE
0706 344654

WALES

BUCON
18, Mansel St.
SWANSEA
0792 467980

S.I.R.
91, Whitchurch Rd.
Cyncoed
CARDIFF
Wales
0222 621813

THE COMPUTER SHOP
41, The Hayes,
CARDIFF,
Wales.
0222 26666

SCOTLAND

COMMSCOT
30 Gordon St.
GLASGOW
041 226 4878

NORTH LAND

NEWTONS
Main St.
SEAHOUSES
0665 720307

• Circle No. 199

The HX-20. For business on the move.



In today's fast moving business world, your information has to move with you. Over the past few years there has been an increasing demand for a totally portable computer with the ability to meet so many challenges.

Epson, with over 20 years experience in designing and manufacturing high quality printers, have produced the HX-20, a precision machine with its own rechargeable power supply that can be used for just about any task within today's discerning business: from data capture to word processing, from card indexing to sales order entry. Communicating with other machines is no problem and the HX-20 is easily coupled to one of our fine printers. You can even link in another computer system by using an acoustic coupler.

Don't be fooled by its size, the HX-20 has all the software back-up you'd expect from a much larger machine and incorporates many "bigger computer" features - 16k RAM expandable to 32k with serial interfaces, a full size typewriter keyboard, its own built in LCD

screen and a dot matrix microprinter. A microcassette facility is available as an optional extra.

A complete computer that will either stand on its own or could be the obvious extension to your existing system.

More and more people are finding out just how big the small compact HX-20 is. Why don't you find out for yourself - you owe it to your business.



EPSON
Extraordinary product.
Exceptional quality.

Epson (UK) Limited, Freepost,
Wembley, Middlesex HA9 6BR.
Sales Enquiries: Freefone EPSON.
General Enquiries: 01-902 8892.
Telex: 8814169.

- Please send me full details of the HX-20.
 Please ask my Epson dealer to contact me.

Name _____

Position _____

Company _____

Address _____

Tel: _____

PC3/20

● Circle No. 20

Keeping up with Commodore



Mike Todd reviews some recently published books for Commodore computers.

BOOKS FOR the Commodore range of computers are still being published more quickly than I can read them, so here is a selection of just those books published very recently. Inevitably, books for the Commodore 64 predominate, but there are also some useful books for the Vic-20 being produced, and even some which are relevant to the earlier range of Commodore computers, including the Pet.

For the absolute beginner, there are five books worth looking at, two for the Vic and three for the 64. For the Vic, Albert Kler has produced *Key into your Vic-20* which takes you from the moment you take the Vic out of its box. It briefly explains some of the hardware and software features of the Vic and its peripherals and then goes on to explain the techniques of programming in Basic.

There are lots of simple example programs covering most aspects of programming, including the use of cassettes, but there is only a little about sound, even less about graphics and no mention of high-resolution techniques.

Strangely, having left out the more advanced graphic techniques and any discussion of the video capabilities of the 64, the book has a section on machine code which jumps in at the deep end, and appears out of place in a book of this nature.

The appendices consist of the usual regurgitation of material from the *User Manual* and *Programmers' Reference Guide*, both published by Commodore. There are several example programs included at the end of the book and these are well worth studying as they provide a useful example of how Basic is used in practice, albeit at a rather simple level. However, at £5.95 the book is expensive for what is provided.

At half the price is Tim Hartnell and Mark Ramshaw's *Getting Started on your Commodore/Vic-20* which also starts right at the beginning and takes you right through the principles of Basic programming. There is nothing about using the cassette unit nor any mention of machine code — for which I suspect beginners will be grateful — but details of how to use the sound and graphics capabilities of the 64 are mentioned briefly. These include high-resolution user-defined graphics and sound, but no sprites.

While some of the example programs are rather complex and sometimes obscure the principles that they are illustrating are not, and many of them are useful illustrations given the adequate commentary provided. Unfortunately, the use of the book as a reference is severely limited by the lack of reference charts, appendices or an index.

For owners of the 64, the three beginners' books are *Teach Yourself Computer Programming with the Commodore 64*, by L R Carter and E Huzan; *Commodore 64 — Getting the most from it*, by Tim Onosko, and *Easy Programming for the Commodore 64*, by Ian Stewart and Robin Jones.

The *Teach Yourself* book is cheap, at only £2.75, and follows a more or less conventional approach although it tends to get mathematical at times. Certainly the book is crisp and text-book like with a useful selection of appendices and index.

Once Basic programming techniques have been covered, the book goes on to look at applications and how to use the printer and disc unit with special emphasis at the end on using data files. There are many example programs including some for using sprites, sound and high-resolution graphics.

Tim Onosko's book is also intended for

the beginner but has a much broader approach to all aspects of Basic programming. The book is well presented and wide ranging: from how the 64 should be connected and set up, to programming with the disc drive; from the Basic command set, to using and selecting software packages including word processors. What the main text lacks in detail is made up for three appendices written by different authors covering the more intricate features of the 64. The book is expensive at £7.95 but worth considering.

Easy Programming for the Commodore 64 is only a little cheaper at £6.95, but it is undoubtedly one of the best and most thorough introductions to Basic programming that I have seen, with more than adequate coverage of all aspects of the 64, including sound, graphics, cassette and file programming. The book is full of examples — many of them short and to the point, and designed to be tried out as the text is read.

The techniques used in debugging programs are often forgotten in books for beginners, but not so in this case. All this, coupled with many exercises — complete with solutions — for the reader to carry out, many good example programs, an adequate set of appendices and two indexes make this book extremely good value.

For the more advanced programmer, Melbourne House has two books *Vic-20 Exposed* and *Commodore 64 Exposed*. Both books are similar in their coverage. They are really intended for use by more experienced programmers and are comprehensive in their coverage of the internal structures of both the Vic and the 64, making them useful reference books.

The books cover aspects of disc and printer operations, with only the briefest

(continued on next page)

(continued from previous page)

mention of how to use the devices. Most of the coverage is of the very advanced disc-programming commands that only the most enthusiastic of programmers are likely to want to use.

For those who simply want a book of games programs, Robert Erskine and Humphrey Walwyn have produced *Sixty Programs for the Vic-20* and a similar collection for the 64. To provide 60 programs for only £5.95 is good value under any circumstances, and when the games are of reasonable quality and variety, then this becomes exceptional value.

All the games in the two books are written in Basic, and range from the Space-Invaders type of arcade game through to tests of mental agility and quizzes to a couple of utility and educational programs. They are not all rehashes of all the old favourites, although these are not forgotten entirely, among a number of new and innovative games.

Both books use the graphics capabilities of the machines, including sprites on the 64, and the Vic programs state clearly which memory configuration is required for each game. If you yearn for serious games, Mr Walwyn has also written *Micro Wars on the Commodore 64*. This is a collection of six programs which range from a simulation of the Battle of Waterloo to a real-time Torpedo Bomber game.

There is more than adequate commentary on each game listing, including the historical background. There are also several printouts taken from the screen displays, all of which makes for a well put together collection. But don't be fooled into thinking that these games are easy to play — all of them are designed to tax the wits of the players and are as different to the normal arcade-style games as could be imagined.

If your tastes go as far as writing your own games, Mike Grace's book *Commodore 64 Adventures* describes the process of writing an adventure game from scratch. The first section of the book explains the principles behind writing an adventure game and develops a framework into which any simple adventure scenario could be slotted. This includes the more complicated problems of setting up the necessary maps and plans, and how they can be represented in the computer.

The second section takes these techniques and develops them into a complete adventure game called Nightmare Planet. This is written in modular form with an excellent commentary full of notes and anecdotes about the problems likely to be encountered and their solution. The techniques, which include programming graphics, sprites and sound, can be utilised to produce your own adventure games and the book is a superb introduction to this type of game.

If gaming is not your scene, there are four books intended for those taking their computers that bit more seriously. Boris

Allan's *Graphic Art on the Commodore 64* develops a high-resolution turtle-graphics system for the 64 and then shows how such a system can generate graphics effects.

The actual turtle-graphics program is made up from Basic subroutines which are developed during the course of the text, but at no time is the complete package presented in a form ready to be typed into the computer. Instead, it is necessary to pick out the relevant subroutines from all over the book and piece them together — fortunately, the line numbering has been chosen to make this relatively easy.

Mathematics on the Commodore 64 by Czes Kosniowski contains a variety of mathematical routines for use in your own programs. Although they are designed for the 64, the Vic and other Commodore machines use the same Basic so most of the material can be used on these machines with little difficulty.

The range is wide, from codes and cryptography to random numbers, from trigonometry to manipulating dates. The commentary is clear and concise but does need some understanding of mathematics to be able to understand it fully.

Along similar lines is *Basic Subroutines for Commodore Computers* by Eddie Adamis. The big difference with *Basic Subroutines* is the triviality of many of the routines it provides and I have serious doubts as to how many people will need to buy such a book in order to have a program to convert, for example, kilograms to pounds, or degrees Fahrenheit to degrees

Centigrade. To be fair, there are some useful programs included, such as mathematical operations and some financial programs but the overall level is more suited to beginners.

The final applications book to be examined is James W Coffron's *The Vic-20 Connection*, which is devoted to interfacing the Vic to the outside world. Its 260 pages are packed with software and hardware descriptions for very simple interface tasks, from driving light-emitting diodes right through to designing a speech synthesis unit for the Vic. The book concentrates on both hardware and software aspects of interfacing, and assumes knowledge of Basic and elementary electronics, although some of the concepts required are explained as the book progresses.

Many circuit diagrams are included, mostly using readily available components but there may be problems obtaining a Votrax speech synthesis chip SC-01 or a Creative Microprocessor Systems I/O board which provides a visual indication of the output port of the Vic. Fortunately, the principles involved are explained well enough to allow the techniques used to be adapted for use with other components.

The book has copies of the manufacturer's data sheets on some of the devices used and a section on how to read circuit diagrams but it does not provide a construction details for the many projects. Despite all this it does provide a valuable resource for the Vic enthusiast.

Basic Subroutines for Commodore Computers by Eddie Adamis. Published by John Wiley, £12.95. ISBN 0 471 86541 9

Commodore 64 Adventures by Mike Grace. Published by Sunshine Books, £5.95. ISBN 0 946408 11 4

Commodore 64 Exposed by Bruce Bailey. Published by Melbourne House, £6.95. ISBN 0 86161 133 0

Easy Programming for the Commodore 64 by Ian Stewart and Robin Jones. Published by Shiva Publishing Ltd, £6.95. ISBN 0 906812 64 X.

Getting Started on your Commodore/Vic-20 by Tim Hartnell and Mark Ramshaw. Published by Futura Publications, £2.95. ISBN 0 7088 2445 5

Key into your Vic-20 — The basic course for your new computer by Albert Sickler. Published by W Foulsham & Company Ltd, £5.95. ISBN 0 572 01244 6

Mathematics on the Commodore 64 — essential routines for programming by Czes Kosniowski. Published by Sunshine Books, £5.95. ISBN 0 946408 14 9

Micro Wars on the Commodore 64 by Humphrey Walwyn. Published by Century Publishing Co Ltd, £5.95. ISBN 0 7126 0229 1

Sixty Programs for the Commodore 64 by Robert Erskine and Humphrey Walwyn. Published by Pan Books, £5.95. ISBN 0 330 28358 8

Sixty Programs for the Vic-20 by Robert Erskine and Humphrey Walwyn. Published by Pan Books, £5.95. ISBN 0 330 28357 X

Vic-20 Exposed by John Vander Reyden. Published by Melbourne House, £6.95. ISBN 0 86161 132 2

The Vic-20 Connection by James W Coffron. Published by Sybex. ISBN 0 89588 128 4

Graphic Art on the Commodore 64 by Boris Allan. Published by Sunshine Books, £5.95. ISBN 0 946408 15 7

Commodore 64 — Getting the most from it by Tim Onosko. Published by Prentice Hall International, £7.95. ISBN 0 13 152273 6

Into a world of chaos, clutter and conflict-OZ brings control!

OZ combines sophisticated management techniques with utter simplicity to give you total control over your business. Whether it's for corporate managers, small businesses, line managers, financial analysts, controllers, sales managers, engineers or investors OZ will change the chaos, clutter and conflict into simple, effective and total control.

CONSOLIDATION

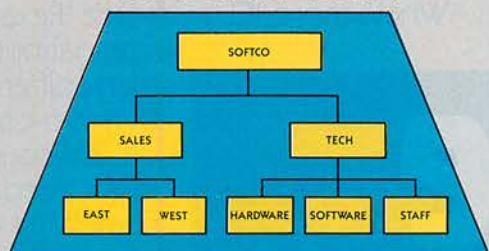

Managers don't have time to teach their computers about business. With OZ they don't have to. OZ will actually store your organisation chart as an organisation chart and all data relationships will be controlled by this simple chart. So OZ will automatically perform consolidations for you on any organisation up to 50 units. OZ will make your re-organisations and mergers as easy as touching a key. It can't get much easier than that.

VARIANCE ANALYSIS

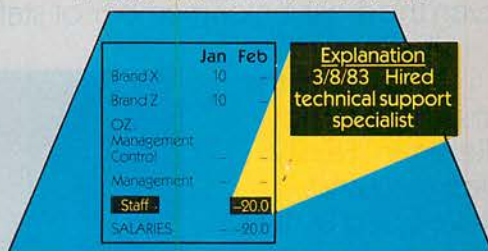

Business managers must know whether they are 'on plan'. OZ has a variance analysis system that will assist in understanding when and why performance is 'off the mark'. With OZ you can look at variances for all the line items by month and by department then, at the touch of a key, get the reasons which explain the variance. OZ gives you complete control over your costs.

FINANCIAL REPORTS

Description	Y-T-D	O/U Budget
Brand X	10	-
Brand Y	15	-5
OZ	20	10

With OZ, the profit and loss forecast is always up-to-the-minute because OZ will up-date it automatically whenever it's needed. Not only that, but also the annual budget is always available for comparison at the touch of a single key.

In addition OZ provides a complete reporting package with indicators such as: actual vs budget, quarterly actuals and full year forecasts. And as all reports are presentation-quality you can use them immediately. Finally, to back up reports OZ gives you a 3D financial analysis capability so you can view your information in a way that's precisely relevant to what you're analysing.

COLOUR GRAPHICS

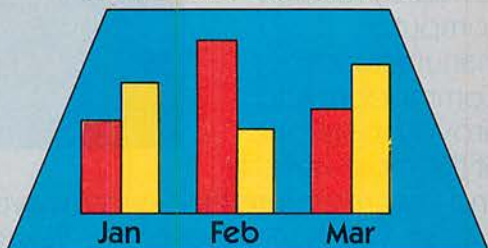

With just a single keystroke OZ lets you see important trends as a colourful chart on screen. There is a wide variety of formats and OZ prints or plots any chart instantly with just one keystroke.

DEALERS

Contact Fox & Geller or one of these distributors for more details:
 Softsel 01-844 2040 Midlectron (077382) 6811
 Tamsys (Windsor) 56747 Software Ltd 01-833 1173
 Pete & Pam 01-769 1022 Xitan (0703) 871211 MPI 01-591 6511
 Tradesoft 01-627 1800 Soft Option (0476) 860171.

To use OZ you must have IBM PC or XT with 256K memory
 Retail Price: £330 + VAT.



MANAGEMENT CONTROL™

FOX & GELLER



Fox & Geller (UK) Ltd, 17 Wigmore Street, London W1. Tel: 01-580 5816.



Isn't it about time you considered an interface system for data acquisition and process control? A system versatile enough to link up with most popular micro-computers,

capable of doing several jobs

at once but simple enough to be used by even the most junior member of staff.

It is?

Then meet the missing link: The "Rexagan" Family. Designed and developed by ICI to meet the widely varying needs of our own scientists and engineers, The "Rexagan" Family has been tried and tested by leading computer manufacturers Commodore and proved to be one of the most versatile and integrated interface systems available.

So, which member of the "Rexagan" Family is right for your requirements?

Well, if all you call for is a simple, easy to understand interface, we suggest Junior "Rexagan." The first low cost interface designed especially for schools, colleges and universities, Junior "Rexagan" offers students and beginners the opportunity to become familiar very quickly with the fundamentals of computer interfacing. Complete with its own software for teaching and demonstrating, Junior "Rexagan" is conceptually simple because it's memory-mapped and has analogue input and output plus digital inputs and outputs all contained within a single, neat package.

For something more powerful, then "Rexagan" itself is the answer. A compact,

modular system, "Rexagan" saves on space and time.

And as a means of automating laboratory instruments or for simple process control, it's incredibly cost effective too.

Nor does it occupy the computer's IEEE or RS232 ports, so these remain available for other peripherals. "Rexagan" also comes complete with its own assembly and programming instructions in an easy to follow well-written, well-illustrated manual.

What's more, ICI guarantee "Rexagan's"

compatibility with many different makes of micro-computer.

Of course you might need something still more sophisticated.

No problem.

The Missing Link

Say hello to Super "Rexagan." Developed for more complex interfacing tasks, Super "Rexagan" is quite simply expandable without practical limit. In fact

it's a system so versatile that ICI alone found over one hundred different, valuable applications during its intensive development programme.

Available for 19" rack mounting, Super "Rexagan" is also memory-mapped for very high speed operation.

Also available is an advanced operating system "Tomult" which allows the writing of true multi-tasking programs in BASIC which can, therefore, be easily altered at will, so



● Circle No. 20

providing an extremely powerful resource for micro-computer control of processes which, in the past, required an expensive mini or main frame computer.



If you'd like to know more about The "Rexagan" Family, just cut the coupon and put an end to your search for the missing link today.



The 'Rexagan' Family

from



Imperial Chemical Industries PLC
 Petrochemicals and Plastics Division
 Physics and Radioisotope Services
 Box 1, Billingham, Cleveland, TS23 1LB.
 (0642) 523260

commodore
 COMPUTER

Tell me more about the missing link.

Name _____

Position _____

Company _____

Address _____

PC/MR

MicroSight



MicroSight I on the BBC model B includes:—

- A CCTV camera with lens and tripod.
- MicroEye vision interface 256 x 300 resolution with 8 bit video plus all copies.
- Fully documented hardware and software.
- MicroSight software package with area perimeter routines as well as disk and printer dumps.
- Hi Res software package with mode O display, disk and printer dumps and thresholding.
- Package using mode 2 high quality display.

All for £495 + VAT

MicroScale

An image processing package with editing area and perimeter calculations, dimensioning, windowing, threshold and contrast setting. £295 + VAT

Colour

RGB filters with 8 colour display software. £99 + VAT

MicroEye

Vision interface 256 x 300 resolution 256 grey levels with full documentation and software.

£295 + VAT

Available on Sirius, IBM, Apple, RML, CBM etc.

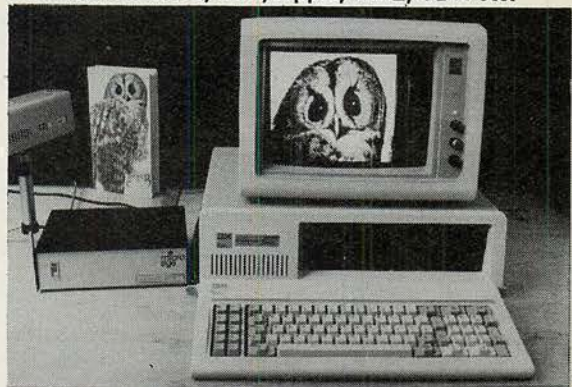

MicroScale II

An image analysis system for the IBM PC which comes complete with camera, vision interface, plug in card and software, offering the following:—

- Object area measurement (absolute and %)
- Perimeter measurement to user defined scaling
- User definable and standard windows.
- Disk and printer dumps.
- Dimensioning and object counting.
- Fully documented C software. £1950 + VAT

Available for Hewlett Packard and Sirius.

For further details contact:—

DIGITHURST

The image analysis people

Leaden Hill, Orwell, Royston,
 Herts. SG8 5QH

Telephone (0223) 208926

• Circle No. 203

Success Breeds Success

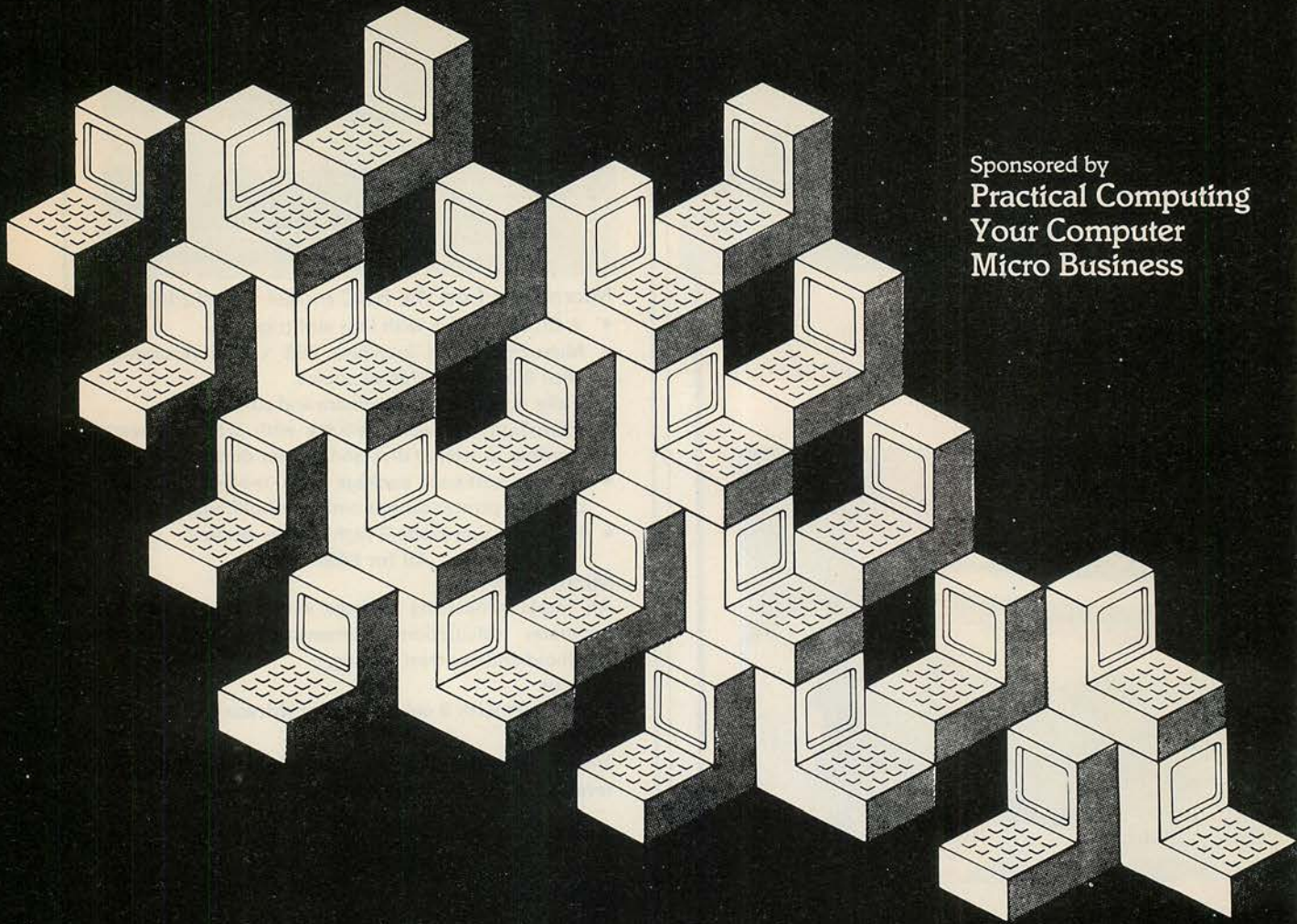

Sponsored by
Practical Computing
Your Computer
Micro Business

National Exhibition Centre, Birmingham. May 4-7, 1984.

After one show the Midland Computer Fair has already established itself as an outright winner. Not only is it the leading exhibition in the Midlands for microcomputers and related products, but it stands in its own right as a major national event.

In recognition of this, and the need to accommodate thousands of expected visitors the venue for the 1984 Midland Computer Fair is to be Britain's premier showcase – the National Exhibition Centre, Birmingham. The NEC with its superb facilities for exhibitors and visitors alike will

be the fitting site for this major event which attracted over 17,000 people for the first show.

Whether you are interested in microcomputer enthusiasts or would prefer to take space in the Business Section to meet small business micro-users, the Midland Computer Fair is definitely for you.

So why not let a little of the Midland Computer Fair's success rub off on your company by reserving a stand at the next show.

The road to success starts by filling in the coupon below:

THE Midland
Computer
Fair *Personal computers*
Home computing
Small business systems

Return to the: Exhibition Manager, Reed Exhibitions,
Surrey House, 1 Throwley Way, Sutton, Surrey SM1 4QQ
Tel: 01 643 8040 Telex: 946564 BISPRS.G

Name _____

Position _____

Company _____

Address _____

SOFTWARE CENTRE

CP/M

CP/M-86

MSDOS

MICROPRO SOFTWARE SYSTEM

WORDSTAR: Best selling professional Word Processing software; On screen formatting, Block manipulation, File read/write, Simultaneous Editing and Printing £295
MAILMERGE: Enhancement for document personalisation and mailing applications £145
SPELLSTAR: Enhancement for checking spelling and maintaining spelling dictionaries £145
STARINDEX: Useful package for creation of Table of Contents, Index, List of Figures, Interfaces to Wordstar to improve document presentation quickly and easily £116
INFOSTAR: Impressive Data Base system combining the power of Datastar with the flexibility of Reportstar £295
DATASTAR: Screen based Data Entry, vetting and retrieval system. Screen formats under user control £175
REPORTSTAR: Powerful report generator, provides much needed enhancement to Datastar for report production and transaction processing £210
CALCSTAR: Electronic spreadsheet with interfaces to all MicroPro products £116

NB: Combination prices — WS/MM
 £390; WS/MM/SP/SI £495

DATABASE MANAGEMENT

FORMULA II: Unique information management system with exceptional capabilities for Application Generation. Multiple files and indexes, transaction processing, interactive, no programming language required £495
dBASE II: The most popular of data management systems, very powerful application generator £437
QUICKCODE: Add-on facility for dBASE programmers to speed development process by generating dBASE command files £200
dGRAPH: Extremely useful program for graphical representation of dBASE and user created data files £200
dUTIL: Utility to speed up dBASE execution £69
CARDBOX: Highly popular electronic card index system. Easy to use, with powerful retrieval facilities £155
FRIDAY: End user file management system from the authors of dBASE II. File definition, input and reporting under user control £195
RESCUE: UK written database management system £295
DMS: Well accepted data management system from Compsoft £195

Telesystems Ltd

PO Box 12 Great Missenden Bucks Tel: 02406 5314

LANGUAGES

Microsoft	CP/M	MSDOS	Digital Research	CP/M	CP/M-PCDOS	86
BASIC Interpreter	£259	£269	CBASIC Interpreter	£100	£217	
BASIC Compiler	£295	£303	CBASIC Compiler	£333	£400	£400
FORTRAN Compiler	£369	£269	PASCAL/MT+	£233	£400	£400
DBOL Compiler	£549	£575	C Compiler	£233	£233	
Compiler		£384	PERSONAL BASIC Int		£100	
PASCAL		£269	CIS COBOL	£425	£425	
BUSINESS BASIC		£460	FORMS-2	£110	£110	
Comp						
MACRO ASSEMBLER	£149		FILESHARE	£250	£425	
SUPERSOFT C Comp	£185	£185	SUPERSOFT BASIC		£200	£200
			Compiler			
FORTRAN	£220		PRO PASCAL	£220	£320	£320

UTILITIES

ASCOM: The most flexible asynchronous communications package available to the micro world. Interactive, batch, menu-driven. Available for CP/M, CP/M-86, MS/PCDOS £135
BSTAM: Simple communications program for exchanging files between CP/M systems £135
TRANSFER: System for exchanging files between CP/M systems. Provided with full 8080 source code £130
CONVMS: Operating system converter. Runs MSDOS programs under CP/M-86 £70
CONVCP: Operating system converter. Runs CP/M-86 programs under MSDOS £70
SID/ZSID: Disassembler for 8080 and Z80 programs £69
DISKEDIT: Facility for editing disk held data by sector. Invaluable aid £70
IBM-CP/M COMPATIBILITY: Set of programs that enable IBM 3740 disks to be used on CP/M, permitting transfer of files to/from IBM mainframes £110
SPP: Speed Programming Package for use with Pascal/MT+ £133
XL786: Converts 8080 assembler code to 8086 £106
EM80/86: Emulator to run CP/M software under CP/M-86 £70
DISPLAY MANAGER: Screen handling productivity aid for Digital Research compilers £267
ACCESS MANAGER: File handling productivity aid for Digital Research compilers £200

APPLICATIONS

MULTIPLAN: Exceptional electronic worksheet from Microsoft £199
MULTI-TOOL WORD: Microsoft's advanced Word Processor with optional Mouse for added flexibility £275
SUPERCALC: Fast action spreadsheet and planning aid £200
MICROMODELLER: Financial planning system for model building £250
GRAPHSTAT: Versatile statistics and graphics package for the Epson QX10, IBM-PC and Sirius £195
ALIAS ACCOUNTS: Fully integrated accounts system with inbuilt hooks to dBASE II £1200
ALIAS PAYROLL/SPP: Standalone or integrated system with optional links to ALIAS accounts each £600
RCS LEDGERS: Sales, Purchase, Nominal ledgers in MBASIC source code each £300
RCS PAYROLL: Full function, highly used package £500
STATISTICS PACK: Over 25 easily used routines in MBASIC £120
MATHS PACKAGE: Interactive routines (40+) in MBASIC £120

MISCELLANEOUS

CP/M 2.2: Standard operating system on 8" disk £100
CP/M-86: Standard 16-bit operating system £167
SUPERSORT: Full function Sort/Merge/Selection package £145
MSORT: Standalone and COBOL hosted Sort package £143
MAGSAM: MBASIC utility to provide multi-key ISAM file facilities £130
TOUCH 'N' GO: Teach yourself keyboard skills £25
MICROSOFT MOUSE: Mouse, interface card and software £140
OPTIMISER: Interactive Linear Programming package £325
PROSTAR TRAINING GUIDE: Independent instruction on the use of MicroPro 'STAR' products £30

MICROPACS

Simulation, training and control packages available
TUTSIM, a powerful digital dynamic simulation tool. £250

This unique and very popular package can be used for all types of simulations, socio economic, physiological, electronic, servo mechanism, chemical plant, aero-space Etc.

CONTROL, Comprehensive control design and advanced training tool. £850

FILTER, Digital filtering tutorial £850

PID, A PID control loop tutorial £850

LEVEL, A level control tutorial £850

All these packages run on the Apple 2/2e system are very interactive, easy to use and make full use of graphics. IBM PC versions are becoming available (Tutsim now). Substantial discounts on the software are available for bonafide educational establishments.

For the **INSTRUMENT OR CONTROL ENGINEER**, we supply a complete "toolkit" comprising the above packages integrated with micro, dual floppy and hard cop printout at a **BUNDLED PRICE OF £4190, A SAVING OF OVER £1000**, extras include;

Applescope 2 channel fast digital storage scope £695

Control loop draughting system with A3 size plotter and instrument/control symbols £1950

Total bundled price £6450

THINK OF DESIGNING, TESTING, DEBUGGING, TRAINING FOR AND DOCUMENTING ALL YOUR CONTROL SYSTEMS FROM ONE INTEGRATED DESKTOP PACKAGE.!!

SEND FOR DETAILS TO MICROPACS, GRAPHICS HOUSE, 50 GOSPORT STREET, LYMINGTON SO 9BE Tel: 0590 73503.

(Micropacs is a division of Process Automaton And Control Systems Ltd.)

● Circle No. 207



REGISTERED REFERRAL CENTRE
 FOR THE BBC PROJECT
BEEBUG FOR THE BBC MICRO
 INDEPENDENT NATIONAL USER GROUP FOR THE BBC MICRO

MEMBERSHIP NOW EXCEEDS 20,000

18,000 MEMBERS CAN'T BE WRONG — BEEBUG PROVIDES THE BEST SUPPORT FOR THE BBC MICRO. BEEBUG MAGAZINE — NOW 62 PAGES INCLUDING NEW PRODUCT GUIDE SUPPLEMENT — DEVOTED EXCLUSIVELY TO THE BBC MICRO. Programs — Hints & Tips — Major Articles — News — Reviews — Commentary. PLUS member discount scheme with National Retailers. PLUS members Software Library — a growing range of software from around £3.50 per cassette. 10 Magazines a year. First issue April 1982. Reprints of all issues available to members.

Jan/Feb issue: Program Features: Block Blitz, an excellent arcade style game, **A Disassembler for the BBC micro**, the **Ray Box** game to test your powers of deduction, **Large Digital Displays in Mode 7**, **Dancing Lines**, an interesting visual demonstration of random numbers. Plus articles on **Machine Code Graphics**, the first of an introductory series, **Teletext Mode (Part 4)** with a set of useful procedures, **Protecting your own programs**, and an **Introduction to forth**. Plus reviews of **Double Density Disk Controllers**, **Graphics Tablets**, **new Software**, **Product news**, **Postbag**, **Hints and Tips**.

Magazine programs now available on cassette to members at £3.50 inc: VAT & p + — see April/May issue for details.

BEEBUG NEW OPERATING SYSTEM OFFER
 BEEBUG members can now obtain the new 1.2 OPERATING SYSTEM ROM at around HALF PRICE

See BEEBUG Magazine February, March or April for details. As a result of BEEBUG negotiations with Acorn the ROM now may also be offered by other user groups to their members.

MEMBERS SOFTWARE LIBRARY — BEEBUGSOFT: BEEBUG SOFTWARE LIBRARY
 offers members a growing range of software from £3.50 per cassette.

1. STARFIRE (32k). 2. MOONLANDER (16k). 3D NOUGHTS AND CROSSES (32k). 3. SHAPE MATCH (16k). MINDBENDER (16k). 4. MAGIC EEL (32k). 5. Cylon Attack (32k). 6. Astro Tracker (32k).

Utilities: 1. Disassembler (16k). Redefine (16k). Mini Text Ed (32k). Applications: 1. Superplot (32k). 2. Masterfile (3k).

13% discount to members on the excellent wordwise word processing package — this represents a saving of over £5.00.

Send £1.00 & SAE for Sample.
 Membership: UK £5.40 for six months
 £9.90 for one year

Overseas one year only:
 Europe £18.00 Middle East £19.00
 Americas & Africa £21.00
 Other Countries £21.00

Make cheques to BEEBUG and send to:
 BEEBUG Dept 5, PO Box 109
 Baker Street, High Wycombe,
 Bucks HP11 2TD.
 Send Editorial material to:
 The Editor Beebug
 PO Box 50 St. Albans, Herts.

● Circle No. 2

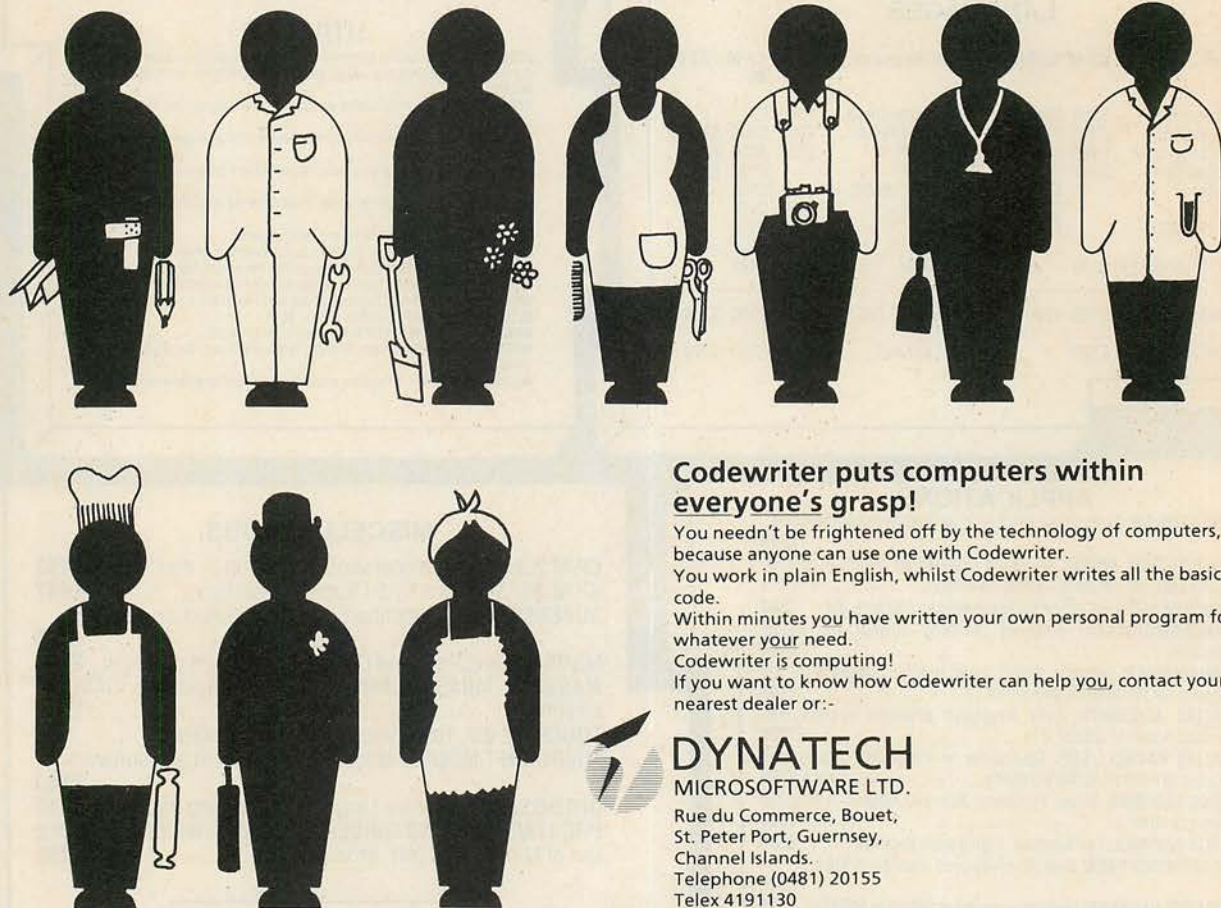

Codewriter puts computers within everyone's grasp!

You needn't be frightened off by the technology of computers, because anyone can use one with Codewriter.

You work in plain English, whilst Codewriter writes all the basic code.

Within minutes you have written your own personal program for whatever your need.

Codewriter is computing!

If you want to know how Codewriter can help you, contact your nearest dealer or:-



DYNATECH
 MICROSOFTWARE LTD.

Rue du Commerce, Bouet,
 St. Peter Port, Guernsey,
 Channel Islands.
 Telephone (0481) 20155
 Telex 4191130

● Circle No.

BLOBBO
NOW AVAILABLE
FOR THE ZX SPECTRUM

SOFTWARE FOR THE
MTX
SERIES

CHESS

A fully comprehensive chess package. Ten levels of play, from novice to championship standard. Pitch your wits against the computer with this fast, versatile machine code program.

TOADO

The object of the game is to navigate each of **five toads** across a **road** and **two rivers** without being run down or drowning (toads can't swim).

— ALICE IN — WONDERLAND

A fully interactive machine code adventure game set in **Wonderland**. You play the part of **Alice**, and explore the fascinating world of Wonderland, full of excitement and suspense. Delve deep into tunnels, caves and wells in search of hidden treasure.

KILOPEDE

Eliminate **mushrooms** and the descending segmented **Kilopede** to gain bonus points — avoid killer **crabs**, **fleas**, **spiders** and **jellyfish** which chase you across multiple levels of increasing difficulty.

— SUPER — MINEFIELD

The object of the game is to get from one side of the minefield to the other without being **blown up**. You only get one life so be careful — not all the mines are visible. The only way you can tell how many mines are nearby is by looking at the **mine detector** in the top right hand corner of the screen.

BLOBBO

Run at high speed around the maze collecting **treasure** and **fruit** worth bonus points — but don't get caught by the **Blobbo-eaters**! Tactical dodging must be employed to avoid them. If you're caught or step on a skull and crossbones you lose one of your three lives.

KNUCKLES

Move **Knuckles** around his maze, using a joystick to kick **Roks** and **Magic Squares**. The object is to line up the Magic Squares, using the fire key, and so advance to the next level, gaining a level bonus.

Please send for our free colour catalogue of Business, Education and Games Software.
Illustration: Nick Mynheer.

Continental Software Limited,
Unit 23, Station Lane,
Witney, Oxon

● Circle No. 124

BLOBBO

N. MYNHEER

BEEF UP AN IBM SOUP UP A SIRIUS

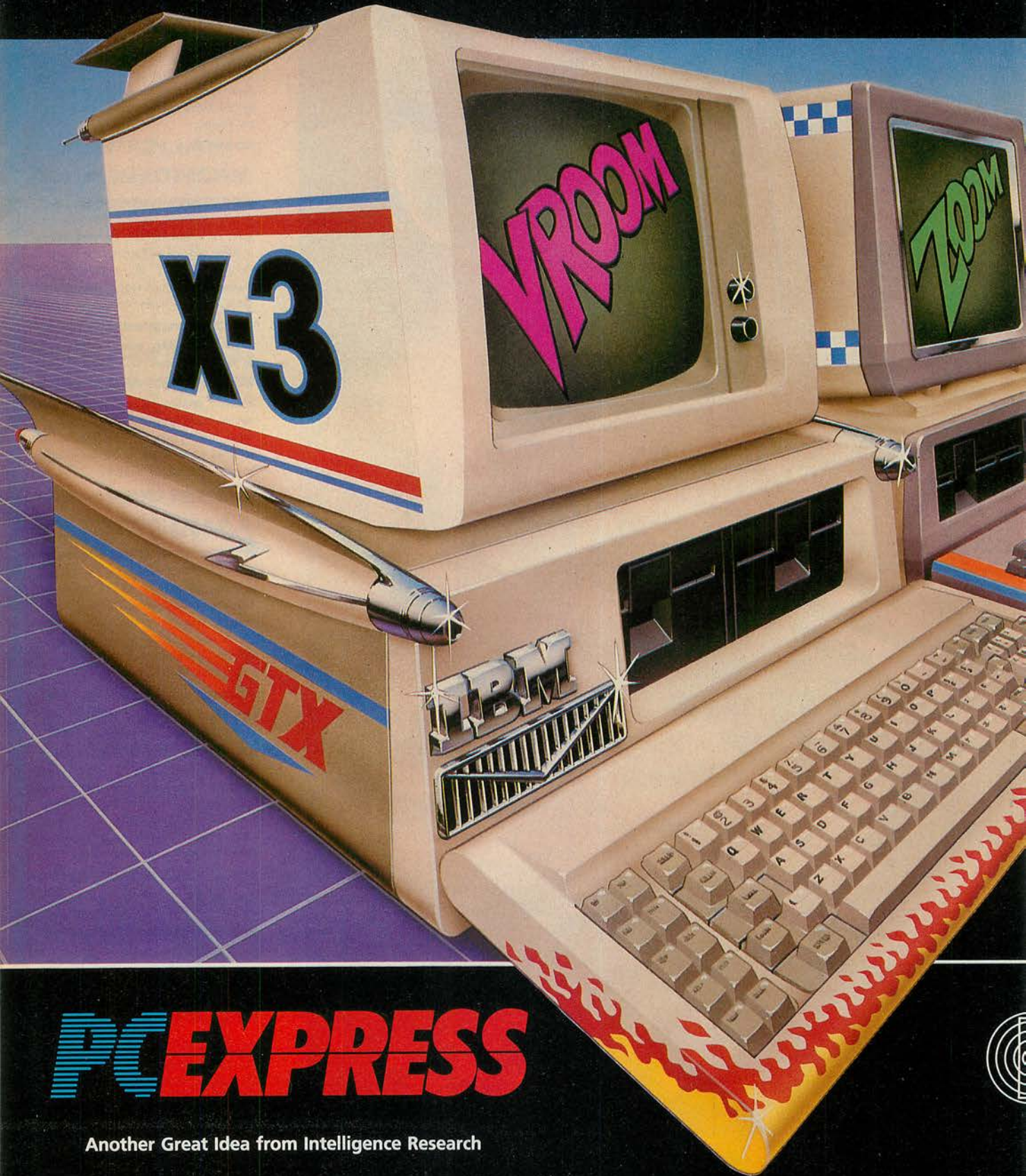

PC EXPRESS

Another Great Idea from Intelligence Research



**LAST
TRUE 16 BIT
PROCESSING WITH
AN INCREDIBLY
FAST 10MHz 8086
PROCESSING BOARD**

Introducing the PC Express expansion card from Intelligence Research. PC Express not only doubles the processing speed of an IBM PC or Sirius/Victor but expands the memory up to 512K. Installation is fast and simple. The card plugs straight into one of the machine's expansion slots leaving the others available to meet your future needs.

PC Express is fully compatible with existing hardware and software and is produced with the performance and reliability for which our products are renowned.

Make sure that you get our brochure. It will explain why PC Express is the most advanced new enhancement card on the market.

Currently available for IBM PC, IBM XT, SIRIUS 1, VICTOR 9000.

Intelligence Research Limited
Unit 6, Sergeant Industrial Estate
Crittall Lane
London SW18 4DJ
Telephone 01-871 1422
Telex 919368 INTSYS

Intelligence Research is a division of Intelligence (UK) PLC

Circle No. 208

>NEXT MONTH

>FREE! 16-BIT SUPPLEMENT

Following the enormous success of last year's special 16-bit supplement we've decided to do it again — only better — with a practical guide to most of the dozens of machines available.

>OPERATING SYSTEMS

The special section inside the April issue will be devoted to operating systems, including CP/M, MS-DOS, Unix, Pick and other important examples of the software writer's art. You may not like them, but you can't run software without them.

>REVIEWS

The Kaypro, voted Transportable Computer of the Year, gets the full treatment next month. Among the pieces of software piling up in the office are three of the heftiest packages of all time — Tomorrow's Office, Delta and Rescue. By next month lucky Paul Myerscough might have finished reviewing them on the IBM PC. We will also be comparing two Commodore 64 spreadsheets: Practicalc and Multiplan. We will be surveying the transportables available, and for light relief there is a round-up of games on the BBC Micro.

>YOUR GOOD HEALTH

Among the features next month you will find Chris Naylor stripping off to try some of the many programs which help you to stay young, live longer and diagnose your own diseases. The Bensons return with part 2 of their series on Apple interfacing — if you missed part 1 it was last month. And of course there will be the usual round-up of news, views, programming tips and book reviews, not to mention the pages and pages of free software in Open File.

Make sure you don't miss the April issue of

Practical Computing

On sale at W H Smith and all good newsagents after March 14.

SOME SEARCHING QUESTIONS TO ASK A DATABASE MANAGER

Now that microcomputers are capable of serious data storage, the hot phrase in software is 'database manager.' A good one, such as Superfile, turns a micro into a hyper-intelligent filing cabinet, combined with an amazingly deft assistant.

Any business that uses a card index or a filing cabinet would benefit from a database manager. It could do more for an enterprise than hiring a new executive – but it is necessary to be just as careful when interviewing candidates for the job. Vast sums of money are lost by companies investing in software that doesn't work hard enough. So it's vital to ask the right questions – and get the right answers.

"ARE YOU CAPABLE OF DOING A WORTHWHILE JOB?"

"You may do well with a small database, but how much can you store? How fast are you when full?"

Superfile's capacity is limited only by the hardware. The 8 bit version is fast, but the 16 bit version is lightning. On a suitable machine it can find one Record out of a hundred thousand in 3 seconds. A lot of main-frame computers would like to do as well.

"DO YOU KNOW THE FACTS OF LIFE?"

"In real life, everyone changes their minds about the structure of their databases. Can you adapt? Can you hold many different sorts of information at once? Can you find someone who says they're called 'Smith' when they're actually 'ssmythe'?"

Superfile has a completely flexible structure. A user can change the shape of Records after he has started to enter data. He can store as many different kinds of Record as he wants. Superfile also has a unique 'sounds-like' searching facility – very useful for anyone who deals face to face with the public.

"ARE YOU ECONOMIC?"

"Do you insist on storing everything in fixed length spaces, so that 'Mr Ho' takes up as much room on the disk as 'Miss Featherstonehaugh-Willoughby-Fanshawe-Tupman'?"

Superfile has variable length Records that can double or treble the useful space on your expensive disks.

"ARE YOU FRIENDLY?"

"Do your users need a PhD in computer science? Are your manuals as thick as telephone books and as tedious to read?"

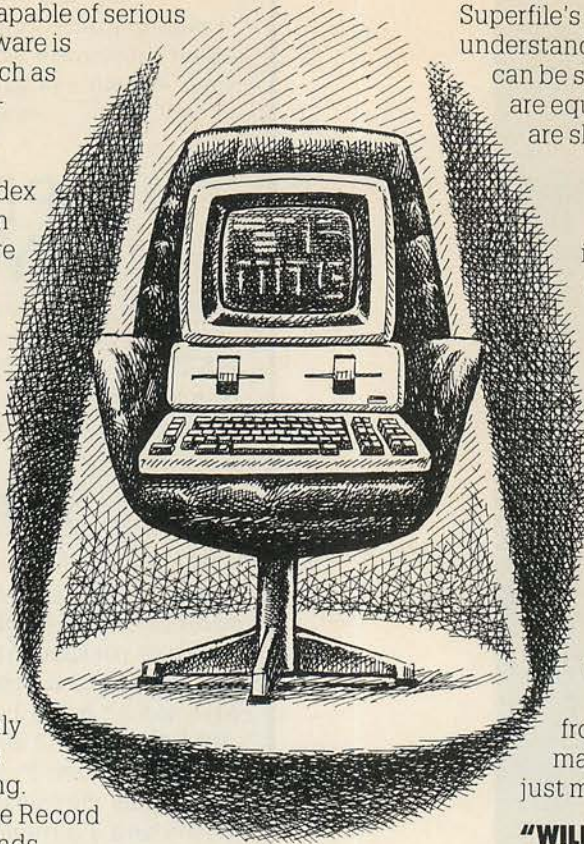

Superfile's underlying concepts are simple to understand. Its screen Forms for data entry can be set up in minutes. Its paper Reports are equally straightforward. The manuals are slim and concise.

"ARE YOU MULTI-USER?"

"A database is vastly more useful if several people can consult it at once. Can you cope with many hands on your keys without hysterics?"

Superfile is available in single and multi-user versions. Very few others can make this claim.

"CAN YOU KEEP PACE WITH TECHNOLOGY?"

"Hardware is changing and improving so fast – can you keep up with improvements? Or will all my database work be wasted when I buy a new computer?"

Superfile will run on anything from small 8 bit machines to main-frames. Users' databases will just move across without trouble.

"WILL YOU BE FAITHFUL?"

"Will you take my money and run? If I have problems will you help?"

Superfile's publisher, Southdata, is a family business committed to good customer relations. When users buy Superfile, they can be sure of individual attention and full technical support.

Superfile is an advanced, British made package. It runs on most modern micros and is widely used, among others, by the Ministry of Defence and British Telecom – organisations that do not have to settle for second best. To find out more about Superfile and how it could become a powerful member of your company, just send the coupon.

Please send me details of Superfile:

SUPERFILE

DATABASE MANAGEMENT

Name _____

Address _____

Phone _____

Or, you are welcome to ring us to make an appointment to see Superfile in action at our offices.

Southdata Ltd 166 Portobello Rd., London W11 2EB
01-727 7564 01-229 2724

PC-1

● Circle No. 171

Fifth generation panic

Christopher Roper speculates on the significance of developments in AI research.

THE CURRENT panic in the U.S. about the Japanese fifth-generation computer project is reminiscent of an earlier scare over the Sputnik. Politicians and newspaper editors are wringing their hands over the U.S. educational system, and asking where it all went wrong.

Now, as then, a good deal of the hue and cry is directed towards extracting more money from public funds for expensive research projects. This time it is the turn of the artificial intelligence research community, and one public manifesto of this group is a best-selling book called *Fifth Generation* by Professor Edward Feigenbaum of Stanford University and Pamela McCorduck, an AI journalist.

Neglect

The book's message can be summarised as follows: AI research has been neglected in the U.S., despite clear demonstrations of its feasibility and utility. Now the Japanese are building intelligent machines which will dominate the world market in the 1990s, and America should wake up to the situation.

Although damned by the *New York Review of Books*, the book is important at a time when Clive Sinclair and Acorn Computers are claiming to be about to fill their next generation of micros with AI goodies.

There are people who object on moral grounds to the idea of attempting to simulate human intelligence. Others do not believe it can be done, either purely because it has not yet been done, or because they do not believe there is any correspondence between the way a human thinks and the way a computer works.

McCorduck mentions these objections, but omits the most telling objections of all. These have to do with the very nature of knowledge and information, and the limitations of human language as a map of reality. AI workers are no closer than they were 25 years ago to providing a program which may be said to understand natural

language, or generate its own language to explain concepts which it has discovered.

The Japanese are pinning their hopes on highly parallel architecture, and on Prolog, which is a programming language built up from declarative sentences such as "John is the father of Mary" and rules of inference. McCorduck and Feigenbaum speak as if it were an established fact that this combination will usher in a new age of intelligent machines. There is no good reason to suppose that it will, though almost certainly the Japanese will make some exciting discoveries along the road, build some fancy computers, and generally advance our understanding of programming languages.

Readers of *The Fifth Generation* should be warned of the authors' sleight of hand. A great deal of the book is about the construction of expert systems. The building of these systems, designed to permit the detailed analysis of a large body of specialised data, represents a triumph of the programmer's art, but has nothing to do with the goals of the AI as they were originally laid out in the 1950s.

The authors describe the process by which a "knowledge engineer", to use their misleading label, works with an expert to translate his or her analytic skills into a computer program, operating on a complex but limited domain such as the diagnosis of blood and meningitis infections. However, such programs have a limited utility since their reliability drops when used by non-experts.

Perhaps the best measure of the continuing failure of AI in achieving its primary goals is the lack of progress in producing a program which will satisfactorily translate one natural language into another. Moreover, having had the experience of struggling with the Epson printer manuals for some days, I have little hope that a Japanese logic machine, even if it did operate at a speed of 100 million logical inferences per second, would use English in the way I use it. And I am convinced that it would not process

knowledge in the same way that I process it.

The problem is that everything which goes into a computer is language, and everything which comes out is language. We can agree on the meaning of mathematical and other formal languages, but we are still miles away from any agreement on the multiple meanings of natural language.

Limits

Some computer scientists suggest that there may be theoretical limits to what computers can do, and that these limits are more likely to be discovered by philosophers and psychologists than by engineers. Exciting work is being done in this field, both at Stanford and at the University of California at Berkeley. A fundamental insight is that language does not simply represent knowledge, it is first of all a distinctively human action. When a computer outputs language, it is the projection of the human being who programmed it. Those interested in pursuing further the topic of AI should read Herbert Dreyfus' book *What Computers Can't Do*.

Reading McCorduck and Feigenbaum, it is easy to feel that the world has gone totally mad, that there are people at large who would really like to subordinate human beings to machines. The reality is probably even more depressing. Although they stoutly deny it, they seem quite willing to do without human beings. McCorduck has a chilling fantasy of being cared for in her old age by a robot which will read to her and listen to all her jokes without getting bored.

It is both interesting and odd that governments are willing to spend untold millions in the quest for artificial intelligence rather than spending the same money on making personal computers easier to program, and therefore more useful to human beings. Computers can be used creatively to enhance human intelligence, and it seems sad to waste so much energy on trying to replace it. ■

SERIOUS SOFTWARE FOR THE **4**



DATABASE SYSTEM



WORD PROCESSOR

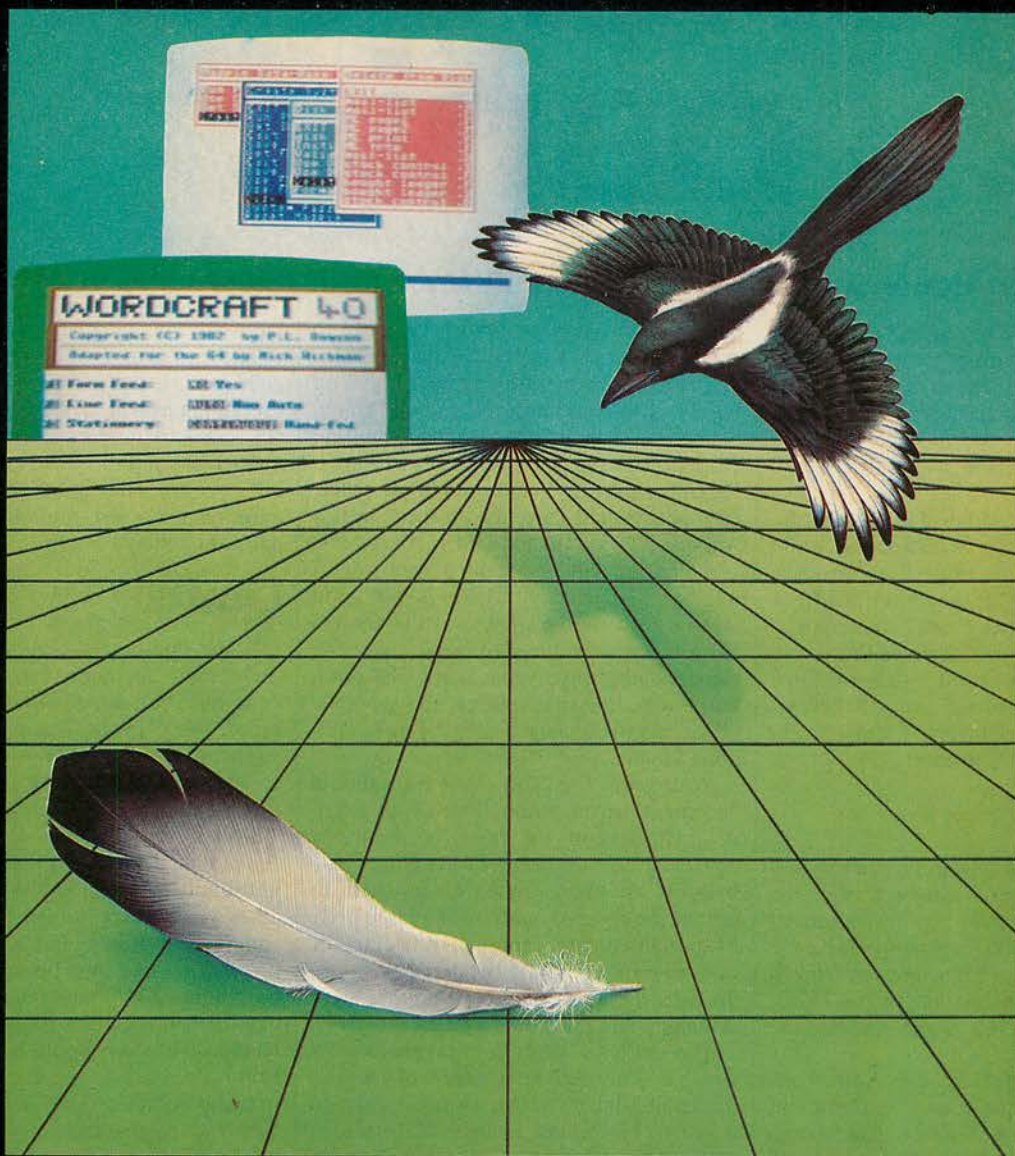

**MAILING LIST, INVOICING, STOCK CONTROL, SALES LEDGER,
BOUGHT LEDGER, DIARY, EXPENSES, CHEQUE BOOK**

Now there is one program which can handle all these things

- MAGPIE -

The most powerful Database System for ANY Home Micro

WORDCRAFT 40 gives you all the powerful Word Processing facilities of an office system at a fraction of the cost. WORDCRAFT 40 works with any printer or printer because it comes on cartridge you can use it with disk or tape files!

SEND FOR FURTHER DETAILS NOW!

Audioogenic LTD

● Circle No. 261

PLEASE SEND ME FURTHER DETAILS OF
MAGPIE AND WORDCRAFT 40

Name

Address

AUDIOGENIC LTD
P.O. BOX 88
READING
BERKS.
RG3 8JF

GRAFPAD

for as many uses
as YOU
can imagine!



BBC MODEL 2 • SPECTRUM COMMODORE 64

With Grafpad you can now add a new dimension to your computer enjoyment, but most important, it helps you create your own application programmes by the simple use of the Grafpad!

The Grafpad comes complete with a cassette comprising two programmes.

THE FIRST PROGRAMME

displays the co-ordinates of your screen area. The co-ordinates are based on the screen with a grid size of 1023 x 1279 pixel, also in the Grafpad giving you a grid size of 320 x 256 pixels!

THE SECOND PROGRAMME

provides you with the utilities for circles, squares, triangles, free-hand, erasing line-drawing etc, and of course, full "Fill-in" facility in 16 different colours by the simple use of the pen!

Draw from a simple apple to a computer circuit - store in cassette or disk, perhaps transfer direct to a printer - in black and white or full glorious colour!

Purchase unique C.A.D. (Computer Aided Designs) programme and add further enjoyment and professionalism to your computer designs!

The Grafpad comes complete with Operational Manual, Programmes, The Grafpad and Pen and it simply plugs in your computer.

(Size: 25mm height x 55mm width x 260mm depth)
Weight: 1.2 kg (Gross)

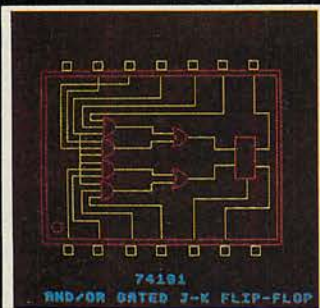
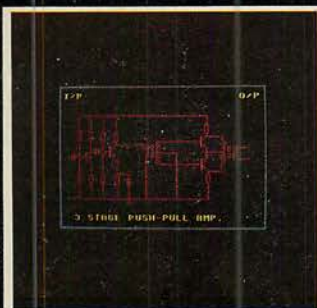
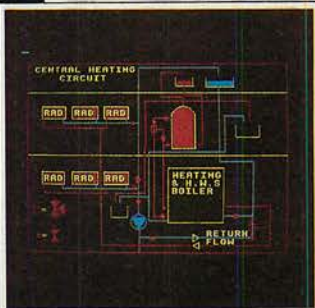
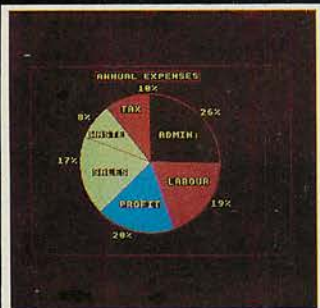
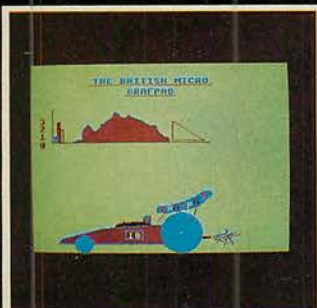

HOW TO ORDER:

BY TELEPHONE:
If you are an American Express, Barclaycard, Diners Club or Access Card Holder simply telephone us giving your Card No., Name, Address and item(s) required and your orders will be dispatched within 48 hours!

BY POST:
Simply fill in the coupon, enclosing your cheque/P.O. made payable to: BRITISH MICRO, or use the special section for Credit Card Holders, and post to the address below. Please allow 14 days for delivery.

(The above designs were drawn by a 12-year-old at our showrooms!)

● DEALER INQUIRIES WELCOMED
● SPECIAL DISCOUNTS FOR EDUCATIONAL AUTHORITIES

BRITISH MICRO

A HEGOTRON GROUP COMPANY

Unit Q2, Penfold Works,
Imperial Way, Watford, HERTS WD2 4YY
TEL: (0923) 48222. TELEX: 946024



Post to: BRITISH MICRO, UNIT Q2, PENFOLD WORKS
IMPERIAL WAY, WATFORD, HERTS. WD2 4YY

Please send me Grafpad for:

BBC MODEL 2 SINCLAIR SPECTRUM COMMODORE 64
(Please tick)

Qty.	Item	Ex. VAT	Inc. VAT	Total
	Grafpad Complete	£125.00	£143.75	
	C.A.D. Programme	£18.00	£20.70	
			Postage, Packing & Insurance	£5.00
			TOTAL	£

I enclose my cheque/P.O. for £.....

I prefer to pay with my American Express, Barclaycard, Diners, Access Card
(Please cross out whichever is not applicable)

CARD NO. _____

SIGNATURE _____

NAME _____

ADDRESS _____

Address above must be the same as card holder.

1984 On Course For Record Computer Sales

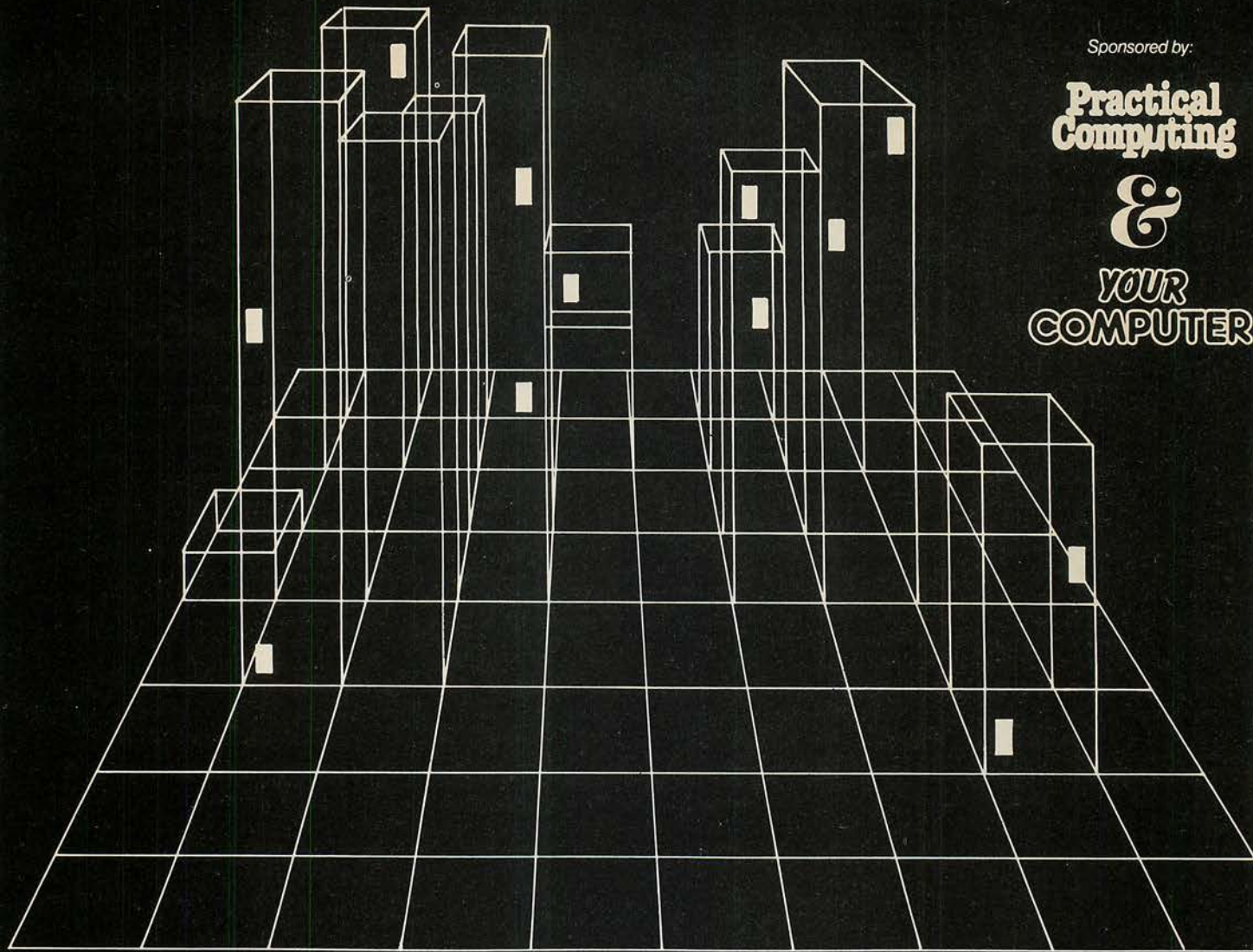

Sponsored by:

**Practical
Computing**
&
**YOUR
COMPUTER**

There can be few – if any – comparable exhibitions capable of generating such intense public interest as The Computer Fair series.

As expected, the 1983 Computer Fair, held at Earls Court, has consolidated its position as the major showcase for home and small business computers, to the extent that it became necessary for the original exhibition area to be doubled to a record 2,300 square metres. And all the signs are emerging to support our belief that 1984 will see further growth in an exhibition which provides an unrivalled opportunity for promoting personal computer systems of all kinds.

Sponsored by 'Practical Computing' and 'Your Computer' and organised by Reed Exhibitions, the 1984 London Computer Fair will again be backed by a massive publicity campaign using radio, television and press media. Advance stand reservations are understandably already well up on 1983. If you want to ensure that you do not miss out on a preferential site, you really must fill in the coupon below NOW, and return to the

Exhibitions Manager, The Computer Fair,
Reed Exhibitions, Surrey House, Throwley Way,
Sutton, Surrey. SM1 4QQ

THE
**Computer
Fair** *Personal computers
Home computing
Small business systems*
Earls Court, London. June 14–17 1984

I am interested in exhibiting at The Computer Fair, Earls Court, London. June 14–17 1984.

Please send full information to

Name _____

Position in Company _____

Company _____

Address _____

Telephone No. _____

Telex _____

If you're selling at
The Computer Trade Show,
you should be seen in

micro business

Micro Business is the magazine read by retailers and dealers for trade information on microcomputer products.

Each issue carries news of the latest hardware and software available for retail sale, with information on the terms of trade, technical support and promotion - plus a whole range of reports and comments designed to keep the retailer and dealer up to

date with what suppliers are offering and what the market is buying.

The March issue will preview The Computer Trade Show, Britain's premier exhibition for dealers and retailers, **and will carry the official catalogue.** If you're exhibiting at the show, or need to be seen by an audience of thousands of dealer visitors, you need to advertise in this issue.

Phone Ken Walford on **01-661 3139** or clip the coupon

In am interested in advertising in your March issue. Please let me have details.

Name _____

Job Title _____

Company _____

Address _____

Tel _____

Telex _____

PGOM

Mail this coupon to Ken Walford, Advertising Manager, Micro Business,
Quadrant House, The Quadrant, Sutton, Surrey SM2 5AS, UK

'1984' THE YEAR OF 2000

SAPPHIRE 2000 SERIES REMOTE CONTROL PRINTERS

Imagine the Printer of the Future. The printer which offers everything. At power-on, miriads of LED'S twinkle their vital information to you. Banks of microswitches on the Extended Front Panel allow selection of the precise option of your choice, and with the aid of touch sensor control switches, you're ready to go. About as easy to operate as Concorde – all simply described in the 3 volume instruction manual.

Now imagine the Printer Beyond the Future. The printer which offers million's of configurations. The printer which needs no tuition, on manuals, no exasperated phone calls.

The printer which has no switches or LED'S, no control panel.

The Sapphire 2000 combines sophistication with ingenuity. The result: fast, clear. Perfect Simplicity.

The Remote Control Unit provides the window through which the operator can select, from the thousands of millions of options, the precise configuration required. Simply, quickly and permanently. Sapphire doesn't forget when you switch it off – it retains the precise options you select for next time.

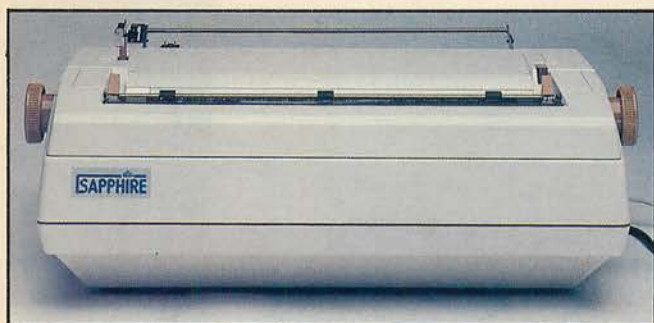

It even retains more than one set of options – so you can have it set up ready for different jobs. A mere seven buttons allow this, full paper handling options and the usual master controls all from where you sit.

For further details of this revolutionary printer, fill in the coupon below to-day and we will make 1984 the Year of 2000 for you.

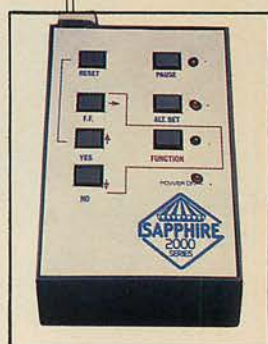

Please send me further details of the SAPPHIRE 2000 SERIES by return.

NAME: _____

ADDRESS: _____

POST CODE: _____

TELEPHONE: _____

MICROPUTE, Catherine Street, Macclesfield,
Cheshire. SK11 6QY.

TELEPHONE: 0625-615384.

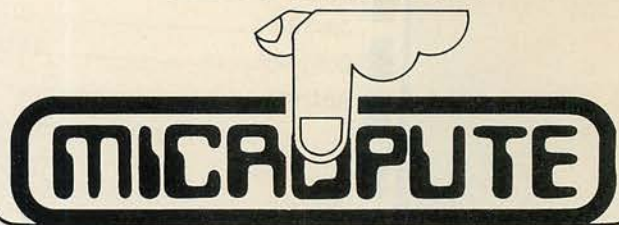

THE YEAR OF THE SAPPHIRE 2000.



SAPPHIRE 2000 SERIES

RESET PAUSE

FF. ALT. SET

YES FUNCTION

NO POWER ON

SAPPHIRE
2000
SERIES

The control panel features a grid of buttons and indicator lights. A red circuit diagram is overlaid on the panel, showing connections between the 'FF.' and 'NO' buttons, and between the 'ALT. SET' and 'FUNCTION' buttons. The 'POWER ON' button is accompanied by a red indicator light.

An important conference for companies buying products to sell on to the user



Wembley Conference Centre
March 13-14

The Computer Trade Conference is aimed at the serious computer trader. Manufacturers, suppliers and third party vendors will exchange ideas on the marketing and selling of computer products. Acknowledged specialists will present their ideas on the best ways to tackle third party sales.

Being held in conjunction with the Computer Trade Exhibition, the event is sponsored by Computer Weekly, Micro Business, Practical Computing, Systems International and Software.

TUESDAY, MARCH 13TH

RETAILING

- 8.30 COFFEE AND REGISTRATION
- 9.15 Mass Retailing of Business Micros — Michael Milman, managing director, Greens Business Systems (a subsidiary of Debenhams Ltd.)
- 9.55 How dealers should present themselves — Chuck Hansen, managing director, Computerland.
- 10.35 COFFEE
- 10.55 What Apple expects from their dealers; what Apple gives their dealers in return — Keith Hall, sales and marketing director, Apple Computers (UK).
- 11.55 Retailing through education and training — G. Summers, managing director, Planning Consultancy Ltd.
- 12.25 LUNCH

MARKETING TO THE PROFESSIONAL AND CORPORATE MARKET

- 2.00 Choosing Your Products — Jack Schofield, editor, Practical Computing.
- 2.40 Market products and sales channels — key considerations in the building of the dealer programme — John Crawford, vice president, world wide dealer programmes, Data General Corporation.
- 3.20 Personal computer dealer marketing in 1984 — Nigel Henzell-Thomas, personal computer dealer manager, IBM Ltd.
- 3.45 DEC's approach to the marketplace — Mike Harding, marketing specialist, Digital Equipment.
- 4.10 How to approach the corporate customer — Hal Hovland, joint managing director, Hovland Business Systems.
- 4.50 CLOSE.

WEDNESDAY, MARCH 14TH

SOFTWARE

- 8.30 COFFEE AND REGISTRATION
- 9.15 Vertical market software — coverage of vertical markets by specific packages varies greatly — some sectors are over-supplied and there are many open opportunities — Russ Nathan, managing director, Romtec.
- 9.55 Procurement — How you evaluate software from various sources — David Turley, director information systems division, Tamsys.
- 10.05 COFFEE
- 10.55 Marketing Software — The Business Market — Barry Neil, sales manager, Micro Computer Products International Ltd.
The Games Market — Nick Alexander, managing director, Virgin Games.
- 11.35 Systems and applications software developments — David Fraser, general manager, Microsoft Ltd.
- 12.15 LUNCH — Guest speaker — John McNulty, McNulty's Interchange.

SYSTEMS INTEGRATORS AND OEMs

- 2.00 Communication is the key to office automation — Malcolm Reip, OEM marketing manager, Computer and Systems Engineering PLC.
- 2.40 Discs and Peripherals — Bob Britten, sales and operations manager, Kennedy International Inc.
- 3.20 Printer products and the markets — Alan Clemmetsen, consultant, Mannesmann Tally.
- 4.00 Market trends in VDUs and VDU terminals — Harvey Ulijohn, managing director, Lear Siegler Data Products Ltd.
- 4.40 CLOSE.

REGISTRATION FORM

Please indicate which day(s) you will be attending

- 13 March
- 14 March

The fee of £185 plus £27.75 VAT for two days or £95 plus £14.25 VAT for one day covers attendance, coffee, lunch, conference documentation and exhibition admission. Tax invoice will be sent.

Cheques to be made payable to Reed Conferences

Please complete in block capitals and send to: Conference Administrator, Room 1313, Surrey House, Throwley Way, Sutton, Surrey SM1 4QQ. Tel: 01-643 8040. Ext: 4890 and 4892.

Please reserve places for the Computer Trade Conference.

Please send me details about exhibiting visiting the Computer Trade Show (tick where appropriate).

Name

Position

Company

Address

Tel

Authorised Signature



CDP Consultants Limited
The Moors Estate, Harlow Road,
Roydon, Essex CM19 5HF

CONSULTANTS
IN COMPUTER
SYSTEMS

**THE FUTURE IS
YOURS WITH THE
FX20 AT ONLY
£1875.00**

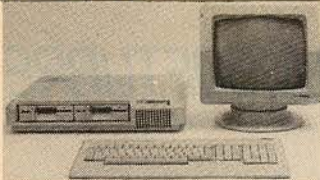

- FX20 — 16 Bit/8Bit Formulation, 128K — 1mbyte ram, Integral LAN, choice of 4 OPERATING SYSTEMS and SPELLBINDER, the total wordprocessing software supplied FREE

SOFTWARE APPLICATIONS AVAILABLE

- Product Pricing/Enquiry
- Video Library
- Printers Estimating/Job Control
- Accounts (Integrated)
- Estate Agents
- Special (Bespoke) Software written ● Circle No. 206

ZORBA THE SERIOUS PERSONS PORTABLE

- Software writers/Developers/Engineers
- College and University Dept.
- Business Executives who want to work at home

This is the computer for you. It has

- 8 Bit, 800KDisc, 5 R/W Formats and coms for up and down loading to Minis and Mainframes.
- FREE Software is CBASIC, WORDSTAR/MAILMERGE AND CALCSTAR

All at the NEW 1984 price £1395.00

Phone 0279-792505/6

AND PLACE YOUR ORDERS NOW

● Circle No. 259

VAT No. 215 551877 Directors: C.A. Pearce, D.K. Pearce Registered in England No. 1448753
Registered Office: Price Bailey & Partners, Aylmer House, The High, Harlow, Essex

TECHNICAL SUPPORT MANAGER

Longman Group is a leading British publisher and is active in publishing software packages for school, home and professional uses. Longman is looking to strengthen its creative team for home learning software by the addition of a Technical Support Manager.

The requirement is for a good working knowledge of 6502 Assembly language (a working knowledge also of Z80 is desirable but not essential). Previous experience of working on computer software in publishing or education will be a considerable advantage. The person selected will work as part of a team both designing and commissioning entertaining software for learning purposes and will require a creative and entrepreneurial outlook.

Please write enclosing a full curriculum vitae together with salary expectation to:-

**Mrs. Sally Ingle, Personnel Manager, Longman Group,
Longman House, Burnt Mill, Harlow, Essex CM20 2JE.**

Longman

● Circle No. 211

ORBIT—ORBIT—ORBIT—ORBIT—ORBIT—ORBIT—ORBIT—ORBIT—ORBIT—ORBIT—ORBIT

ELBUG FOR THE ACORN ELECTRON

IF YOU HAVE AN ACORN ELECTRON OR ARE THINKING OF BUYING ONE THEN YOU SHOULD JOIN THE ELECTRON USER GROUP.

Members receive 10 copies of the magazine ELBUG each year. ELBUG is devoted EXCLUSIVELY to the ELECTRON MICRO. It is packed with news, Reviews, Hints, Tips, Programming ideas, Major articles, plus Regular program features including games and useful utilities.

ELBUG, is produced by BEEBUG Publications Ltd., publishers of BEEBUG, the magazine of the National User Group for the BBC Micro. BEEBUG now has some 20,000 members, and has achieved a high reputation both in this country and abroad. Acorn and the BBC have both taken out multiple memberships, for example, and our articles are now syndicated in Australia. (For further details of BEEBUG, see separate advertisement elsewhere in this issue.)

The formula which makes BEEBUG an invaluable companion for users of the BBC micro will be applied to ELBUG. By subscribing to ORBIT you gain all the advantages of a single-micro magazine, with no space wasted on programs and articles for other computers.

Further benefits of membership:

- Members' discount scheme with national retailers of software, hardware and books, with savings of up to 25%.
- Members' software library with a growing range of titles at special prices for members.

SPECIAL OFFER

SUBSCRIBE NOW, AND GET A FREE INTRODUCTORY CASSETTE CONTAINING 8 TESTED PROGRAMS FOR THE ELECTRON.

1. **SPACE CITY** Defeat the invading Aliens with your laser, and save the city.
2. **3D NOUGHTS AND CROSSES** Pit your wits against the ELECTRON on a 4x4x4 board.
3. **RACER** Guide your racing car to victory, avoiding other cars and obstacles on the track.
4. **3D MAZE** In this challenging game, you must escape from the maze — The screen displays a 3D view from inside the maze.
5. **PATCHWORK** A multicoloured display of continuously changing patterns.
6. **KEY SET ROUTINE** A program to set up the user function keys.
7. **MEMORY DISPLAY** An efficiently written utility to display the contents of memory (ROM and RAM).
8. **CHARACTER DEFINER** Define individual graphics characters with this useful utility for use in your own programs.

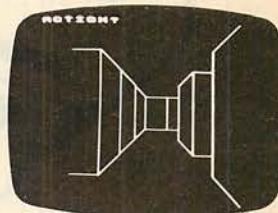

BEEBMAZE



RACER

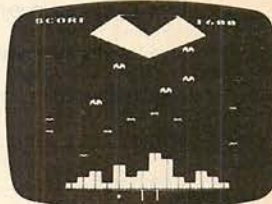

SPACE CITY

HOW TO JOIN

To subscribe for one year, and get your free cassette, send £9.90 (payable to Orbit) plus a strong stamped addressed envelope (for the cassette) to:

ORBIT, PO BOX 109, High Wycombe, Bucks HP11 2TD

SIX MONTH TRIAL SUBSCRIPTION (5 ISSUES) UK ONLY £5.90 — FREE CASSETTE OFFER STILL STANDS.

Membership outside UK (one year only): Eire and Europe £16, Middle East £19, America & Africa £21, other countries £23.

Editorial address BEEBUG Publications, PO Box 50, St Albans, Herts, AL1 2AR

● Circle No. 246

(THE KEY * TO SUCCESSFUL SOFTWARE SALES)

Earls Court,
London.
June 5-7, 1984

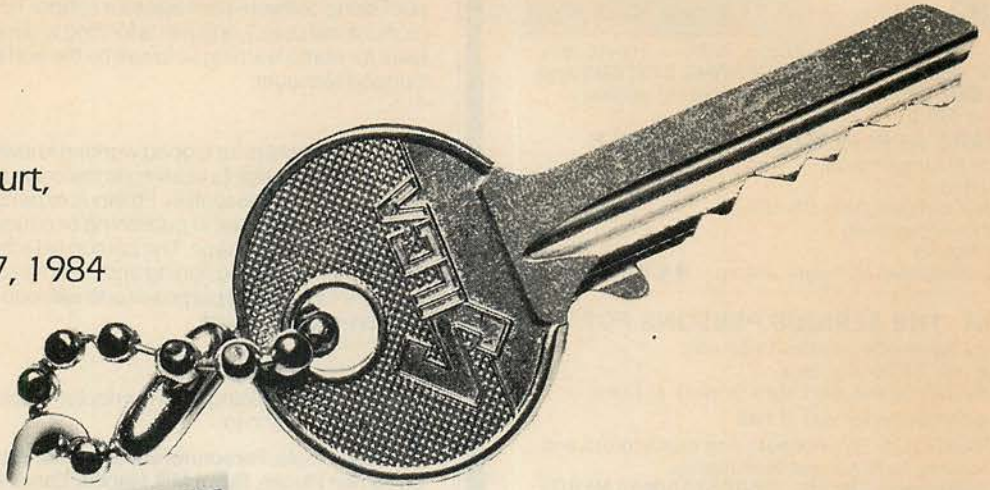

software '84

EXHIBITION AND CONFERENCE

Certainly the major software event of 1984 will be **Software '84**, to be held for the first time in Central London. **Software '84** will be totally dedicated to professional software sales and will be held from June 5-7, 1984 at Earls Court in the centre of London, the Nation's biggest commercial market place.

Such a show could only come from a company that understands the computer market. Reed Exhibitions, the country's largest exhibition organisers, will be staging **Software '84** with all the skill the company has already brought to the highly successful Compec shows.

Computer Weekly, Software and the National Computing Centre (NCC) will be sponsoring both the exhibition and the prestigious conference, running at the same time, guaranteeing a high level of interest in both events. The event has the full support of the Computer Services Association (CSA) and The Institute of Data Processing Management (IDPM) and are co-sponsored by 'Systems International', 'Practical Computing', 'Micro Business' and 'Computer Talk'.

Inevitably, top quality business visitors will be drawn to such a show, with DP professionals, dealers, OEM's and serious business and professional end-users all visiting the exhibition with nothing but software purchase at the forefront of their minds.

With that kind of captive audience you can't afford not to be a part of this important event. So turn the key to the booming software market and make **Software '84** the key to successful software sales. The first step is to fill in the coupon below:

Return to: The Exhibition Manager, **Software '84**, Reed Exhibitions, Surrey House, 1 Throwley Way, Sutton, Surrey SM1 4QQ

I am interested in exhibiting at '**Software '84**'. Please send me full details.

I am interested in visiting '**Software '84**'. Please send me a visitor registration form.

I am interested in attending '**Software '84**' Conference. Please send details.

Name _____ Position _____

Company _____

Address _____

Telephone No. _____ Telex _____

software '84

EXHIBITION AND CONFERENCE

Practical Computing SHOPWINDOW

Telephone 01-661 3612 to reserve your space

ADVERTISEMENT RATES

£15.00 per single column centimetre (minimum 5 cms x 1 col.)
Series discounts available, details on request.

COPY DATES

4 weeks preceding Publication date.

DISKETTES

VERBATIM 5 $\frac{1}{4}$ " SSSD BOX 10 £21.80
VERBATIM 8" SSSD BOX 10 £30.60
DSSD BOX 10 £30.90
DSSD BOX 10 £36.10

Prices include delivery but exclude VAT
SPECIAL OFFER — COMPUTER TABLE FOR HOME OR OFFICE, 2 TIER FULLY ADJUSTABLE IN TEAK OAK OR WHITE MELAMINE.

£36.50
+ VAT

For full price list phone or write

COBRA

Office & Data Products Ltd.,
Lichfield House,
21, High Street,
Amblecote,
Stourbridge, DY8 4DE
Tel: 03843 74880

● Circle No. 212

northern computers

THE
COMPUTER
CENTRE
OF THE
NORTH

**THE
showroom
for all the
leading
micros**



easy parking off the M56 (junc 12) * VIC 20 * VIC 64
BBC micros * Newbrain * Acorn Atom * Books
Apple 11e, 111 * Dragon * Electron * Games
Sinclair Spectrum
Secondhand computers * EASY PAYMENTS
ALL ACCESSORIES SALES AND SERVICE *
northern computers Churchfield Road,
FRODSHAM Cheshire WA6 6RD
TEL: FRODSHAM (0928) 35110

WE WILL PURCHASE AND PUBLISH YOUR PROGRAMS. Call Steve Rhodes for details

● Circle No. 215

OFFICE, STUDIO, WORKSHOP & DESK SPACE near BLACKFRIARS BRIDGE London S.E.1

A wide variety of unit sizes from 50sq.ft. to 1,500sq.ft.
No legal fees or premiums
Reception, telephone lines & telephone answering service available.



For further information or an appointment to view phone Tamias

01-928 7311 ●▲

RENT FROM ONLY £20 ALL INCLUSIVE

Design Resource Association

● Circle No. 217

REPAIRS & SERVICE

- * COMPUTERS (Business & Personal)
- * DISC DRIVES (5 $\frac{1}{4}$ & 8")
- * VDU's
- * MONITORS
- * PRINTERS
- * S100 BOARDS
- * EPROM PROGRAMMING
- * MAINTENANCE CONTACTS

48 hour service for alignment and test of disc drives

A.N. ELECTRONIC & COMPUTER SERVICES LTD

130B North Lane, Aldershot, Hants
Tel: Aldershot (0252) 25608

● Circle No. 213

COMPUTER STANDS

A full range of moderately-priced robust units for offices, schools and computer rooms

From
£42.00
+ VAT

Repairs to personal computers and instrumentation

Telephone for details

PROTOTYPE DEVELOPMENT SYSTEMS LTD
Enterprise House, 44-46 Terrace Road,
Walton-on-Thames, Surrey, KT12 2SD
Tel: Walton-on-Thames (0932) 45670

● Circle No. 214

SCIENTIFIC SUBROUTINE LIBRARY

VOLUME 1 — STATISTICS AND FITTING FUNCTIONS

Mean, SD, normal distribution, partial expectation, Chauvenet's criterion, least squares fit to polynomial and arbitrary function, repetitive least squares fits, covariance matrix, chi-squared statistic, matrix inversion, solution of simultaneous equations.

VOLUME 2 — LINEAR PROGRAMMING

Reduction of a Simplex tableau, integer programming, partial integer programming, conversational linear programming system, least cost mix problem.

VOLUME 3 — FURTHER STATISTICS

Ranking, quantiles, frequency, 2-way table, correlation coefficient, T, chi-squared and F distributions and their inverses, T test, chi-squared test, Wilcoxon test, linear and multiple regression, ANOVA 1-way and 2-way.

VOLUME 4 — TRANSFORMATIONS & SORTING ALGORITHMS

Fourier, FFT, Laplace, numerical integration and differentiation. Exchange sort, Quicksort, Shell sort, Tree sort.

Manuals including full source listings with implementation notes and documentation —

BASIC £25 per volume
PASCAL £30 per volume

Software in CP/M (8" SSSD) or DEC RT-11 (RX01) formats — £75 + VAT per volume.

CP/M TO DEC FILE TRANSFER

Software to read and write RT11 format RX01 diskettes under CP/M. Supplied on 8" SSSD diskette — £25 + VAT.

MICRO LOGIC CONSULTANTS LTD.
57, Station Rd., Southwater, Horsham,
W. Sussex.

Telephone: 0403 731818

● Circle No. 216

HAVE YOU CONSIDERED BAR CODES



Bar-codes give a speedy and error free means of data entry and provide a foolproof method of identification for any item or document. Typical uses include stock control, libraries, filing systems, security & checkpoint verification, point of sale terminals, spare parts identification, etc. etc. Already most grocery products are bar-coded at source and many other areas of industry and commerce are following. Bar-codes will soon be commonplace.

APPLE 2 PET BBC micro

A complete low cost bar-code identification system is available for these micros. It contains all the hardware, software and documentation needed to read and print bar-codes (using an Epson dot matrix printer). Most bar-code formats may be read and the system may easily be patched into an existing applications program.

£199.00 + VAT

*** NEW *** RS232 bar-code reader

This new stand-alone unit decodes the bar-code and converts it into ASCII for transmission to the host computer via a RS232 port. Complete with scanning wand, power supply & cables. Works with virtually any computer.

£385.00 + VAT

More information on these products is available on request. Please state your micro & area of interest. The decoder board is available separately to OEMs.

DOT MATRIX & DAISYWHEEL PRINTERS LOWEST PRICES GUARANTEED!

EPSON FX80 RX80
NEC 8023 STAR
SHINWA CP80
BROTHER TEC etc. etc. etc.

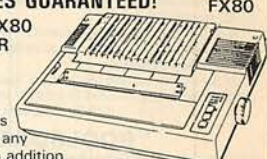

Our pricing policy is to match or better any other advertiser. In addition . . . enthusiastic and knowledgeable technical advice and backup is available to all our customers. Delivery is from stock to your door, often within 24 hours. Phone for a quote or write for full lists.

**ALTEK (PC) 1 GREEN LANE
WALTON ON THAMES SURREY**
please phone before calling
(0932) 244110



SHOP WINDOW

Every computer needs
CHATTERBOX II
"Listen creep, I am the leader....."

For ZX81 SPECTRUM TRS 80 APPLE NASCOM VIC/PET/64 (Please state)

NEW! EXCLUSIVE! **PITCH CONTROL**

CHATTERBOX II can say anything! Genuine phoneme synthesis - not just recorded speech - hence unlimited vocabulary. Programmable pitch for more natural intonation (exclusive to Wm Stuart Systems) - solid tone cabinet for quality sound - integral beep/music amplifier. PLUS expansion socket for BIG EARS voice recognition system. Full instructions technical notes and software supplied with this outstanding educational unit.
DEALER ENQUIRIES WELCOME

£49 COMPLETE OR £39 (O.V. KIT)

As seen on BBC TV "Computer Programme"

BIG EARS

SPEECH INPUT FOR ANY COMPUTER

Hugely successful Speech Recognition System, complete with microphone, software and full instructions.
BUILT TESTED & GUARANTEED
PLEASE STATE COMPUTER: UK101, SPECTRUM, ATOM, NASCOM2, Vic 20, Micron, ZX80/81, PET, TRS80, MZ80K, APPLE II, BBC MICRO

ONLY £49

ZX81/SPECTRUM

MUSIC SYNTHESIZER (Stereo) +16 LINE CONTROL PORT

Play 3-part music, sound effects, drums etc. Full control of attack, decay and frequency. Input/Output lines provide control and monitor facility for Home Security, Robot Control, Model Railway etc. etc. Works with or without 16K RAM.

Full instructions/software included. Add keyboard to make a live performance polyphonic synthesiser!

Note: up to 3 units can be used simultaneously, giving 9 music channels & 48 I/O lines

AMAZING VALUE AT ONLY
£19.50 (KIT)
£25.50 (BUILT)

SOFTWARE

THE COMPOSER
Synthesiser Music Programme. Enter & play 3 part harmony. Includes demonstrations. (Spectrum ZX81) recommended £7

TALKING HANGMAN
For Chatterbox! The classic game claims its victims with a dry vocal accompaniment (Spectrum) £6

ZX ARP/DRUMSEQ
Fascinating synthesiser demonstrations. Generates automatic sequences and plays from keyboard. Some weird effects (Spectrum) £6

CHROMACODE??????
Can you defuse the bomb by cracking the secret combination before time runs out? With Chatterbox voice output (Spectrum) £6

COLOUR MODULATOR
RGB in, PAL/UHF out (not for ZX)

KIT £16
BUILT £22

Please add VAT at 15% to prices. Barclay/Access orders accepted by telephone.

All enquiries S.A.E. please

WILLIAM STUART SYSTEMS Ltd
Quarley Down House, Cholderton, Nr. Salisbury, Wiltshire, SP4 0DZ
Tel: 098 064 235

Circle No. 218

POOLS PREDICTION "POOLSWINNERS"

The most sophisticated Pools Prediction Aid available. Gives probabilities of score draws, draws, homes or aways, based on two databases holding over 20,000 matches included.

The databases are automatically updated as results are entered. Can be used in simple mode, or with parameter adjustments to develop your own unique forecast method.

Fully documented, available now for Apple, Spectrum (48K), Dragon, ZX81 (16K), BBC Model B, Commodore 64 (others - please enquire).
£15.00 (discs/tapes)

"POOLSDATA"

Complete record of all English Football League matches 1978-83. Teams, scores and dates of 10,000 matches held in simple format, ready for your analysis. Starter analysis programs and full documentation included. Available for Apple, Spectrum, ZX81, BBC, Dragon, Commodore series.

Discs (5 year) £15.00
Tapes (5 year) £12.50 all prices
Tapes (2 year) £7.70 (p&p included)

SELEC SOFTWARE (PC)

37 Councillor Lane, Cheshire, Cheshire
061-428 7425

Circle No. 219

1984 ARTIFICIAL INTELLIGENCE WEEKEND

A Seminar at the City University, London, 7th & 8th April 1984.

- Topics covered include:
- natural language processing
 - machine learning strategies
 - computer vision and speech
 - knowledge-based systems.

The news about machine intelligence that appears in the computer press is only the tip of an iceberg of unexploited possibilities. This seminar provides an opportunity for computing professionals to learn about developments at the frontiers of information technology.

For full details write to:
Course Organizer
Warm Boot Limited
23 Torrington Gardens
London N11 2AB

Circle No. 220

ORDER YOUR **EXECUTIVE** for early delivery **OSBORNE**

48 microcentres Ltd

Telephone (0295) **67551**
North Bar, Banbury, Oxon. OX16 0TF

Circle No. 221

: GO FORTH & * ;

Laboratory Microsystems FORTHs - the professional FORTHs complete with editors, assemblers, turn-key compiler, many system utilities, multi-tasking, and extensive documentation. These FORTHs are available for 8080, Z80, 8086/88, and 68000 processors using CPM-80, CPM-86, MSDOS/PCDOS, or CPM-68K.

CPM-80 £60 CPM-86 £105
MSDOS/PCDOS £105 CPM-68K £190

NEW - FORTH + packages have 32-bit stacks and can access the processor's full address space for both program and data.

CPM-86/MSDOS/PCDOS £190 CPM-68K £290

Nautilus Systems Cross-compilers - transport FORTH to different processors, generate ROMmable code, these compilers will run on any of the FORTHs above. The complete development system - a real time saver. Choose targets from - 8080, 8086/88, Z80, 6800, 6301/6801, 6809, 68000, 1802, Z8, 9900/99000, Z8000, LSI-11. First compiler from £230, additional targets from £95.

NEWBRAIN FORTH in PROM - includes screen editor, full integration to NEWBRAIN i/o handlers, a complete Z80 assembler, decompiler, utilities and manual - £55 + VAT EPROM/RS232 card and comms software also available.

DRAGON FORTH cartridge - full fig-FORTH with editor, colour management, sound facilities, and manual - £45 + VAT

??? !!! **JUPITER ACE DISC CONTROLLER** !!! ??? Well ain't that magic - just add 12 volts and a disc drive - 3", 5", or 8". Includes full FORTH DOS software. A snip at £98 + VAT. Additional disc utilities £15.

DIY FORTH Kits Installation manual - How to do it, model, definitions, editor £7

Source code listing for one processor - choose from 6502, 6800, 6809, 8080, Z80, 8086/8088, 9900, 1802, 68000, Z8000, VAX, Apple II, LSI-11, Eclipse £7

Comprehensive range of FORTH books includes -
'Starting FORTH' by Brodie - the classic £16
'Systems Guide to fig-FORTH' by Ting £26

Jpe MicroProcessor Engineering Ltd
21 Hanley Road, Shirley, Southampton SO1 5AP
Tel: 0703 775482

We welcome Access

Circle No. 222

FULL COLOUR Inlay Cards

Sell your programs with colour inlay cards and add that professional sales appeal from as little as £28 per 1,000. A.W.P. are the specialist trade colour printers for both Audio and Computer cassette inlay cards. They are produced in two types the deluxe finish (min. 1,000) and the standard finish (min. 8,000).

Details and samples from A.W.P. Ltd, 5 Bexley Squ., Salford, Manchester. 061832 4533.

MAYDAY
A PERFECT MATCH
ROBERT GOLD

The Trade Colour Printers

Circle No. 223

ZORBA
THE SERIOUS PERSONS PORTABLE PLUS
LUCAS LOGIC LX80
The Low Cost 80cps Printer
(A great Partnership)
ADD

DBASEII
The Most Powerful Micro Database
(Now the system is complete)
And you can take it anywhere
Deliveries are immediate

Contact Chris Pearce
CDP Consultants Ltd
Wicken Rd., Clavering, Essex. CB11 4QT
(0799 85) 617

Circle No. 224

MICROCOMPUTER INSURANCE

Comprehensive cover at a reasonable premium:

- All Risks Cover (incl. Transit) - up to £8,000 for £20
- Increased Cost of Working - to reinstate lost data
- Breakdown & Derangement - alternative to maintenance agreement

Write with details of equipment to:

Geoffrey Hoodless & Associates
Freepost (no stamp required)
Woking
Surrey GU21 3BR
Tel: Woking (04862) 61082 (24 hrs)

Circle No. 225

TRS-80 VIDEO GENIE

NEWDOS-80
APL-80
PASCAL-80
FORTH (MMS)

Details of these and over 200 other programs are contained in our new loose leaf catalogue price £1.00 (refundable) from:-

MICROCOMPUTER APPLICATIONS

41 QUEEN'S ROAD
BLANDFORD FORUM
DORSET DT11 7LA

TEL: (0258) 55100

Monitor and Colour TV

Why buy just a monitor, when you can have a monitor AND a colour TV. Based on the superb Philips 14" Colour TV. Inputs for RGB, VIDEO, SOUND and UHF. Suitable for home computers, video discs and VCRs£245.00

FORTH FOR SINCLAIR SPECTRUM with MICRODRIVES

Supplied complete with assembler, editor, utilities and documentation£19.95

FIG-FORTH

Installation manual + source listing£12.50
Available for the following CPU's; 6502, 8080/Z80, 6800, 68000, 6809, PDP-11/LSI-11.

FORTH Disc systems available from£25.00

CONGUIN SOFTWARE

14 GOODWOOD CLOSE, MORDEN, SURREY, SM4 5AW

No callers please. Phone 0524 381423

● Circle No. 226

MJ MICRO SUPPLIES

Disks Wabash - Box of Ten			
SSDD 5.25"	15.10	SSSD 8"	17.90
SSDD	19.16	SSDD	22.33
OSDD	21.60	OSDD	26.30
Samsong Data Binder			
9.5" x 12" ea.	1.15	ABA 30/40	16.00
14.5" x 11" ea.	1.22	ABA 60/80	22.00
Listing Paper 9.5" x 11"			
500	3.45	A4 Clean-Edge	6.95
1000	6.50	1000	13.25
2000	11.95	2000	24.95
Listing Paper 14.5" x 11"			
500	4.25	1000 1up	4.95
1000	7.95	4000 1up	17.50
2000	14.25	8000	32.00

All sizes of stationery available.

Prices excl. P&P and VAT.

Ribbons-Apple Peripheral Cards-Disk Drives

Pre-printed Stationery-Cassettes-Printers

For all your supplies, write for full prices to

MJ MICRO SUPPLIES, FREEPOST (BS3661),

NAILSEA,

BRISTOL BS19 2BR. 24 hr. Answer Phone

No stamp required

Tel: Nailsea (0272) 857354

● Circle No. 227

DBASE II ON SITE TRAINING

Phone Mike Gardner on

01-421 0266

Computer
Training
Services

96 Grimsdyke Road,
Hatch End Pinner
Middx HA5 4PW

● Circle No. 228

NEWBURY DATA PRINTERS

8510 from £480.00

1550 from £600.00

are, what other printers want to be

Continuous Stationary 1000 SHTS

11 x 9 1/2 plain £5.25

11 x 9 1/2 plain (zip margins) £6.00

11 x 14 1/2 plain/lined £7.00

Min. Quantity = 1 Box (2,000 sheets)

Contact Chris Pearce
CDP Consultants Ltd.

Wicken Rd., Clavering, Essex CB11 4QT.
(079985 617)

● Circle No. 229

SHARP MZ80B twin discs printer C/PM MBasic CBasic Sharp — Database Wordstar, Wordpro, Mailpro, Accounts, Supercalc. 2nd RAM Graphics, Games galore. Very reliable system costing £4000 + offers around £1600 accepted. Tel. 0222-7413 Day, 568286 evenings.

32 BIT (4-PORT) I/O card for Apple II, 4 timers, interrupt facilities and user's handbook. New condition £42.00. 0473 78290 after 6pm please.

SUPERBRAIN MKI (QD) £1250 with wordstar, DBase-II, MBasic BStam Macro-80 Bascom etc. Rutishauser sheet feeder £280. 01-229 8802

SIMONS BASIC for the Commodore 64, new in box £35. Tel: East Horsley 3709.

BBC programmers with teaching experience required to prepare physics, chemistry, biology and geography programs for new rapidly expanding company: science software, Dolgellau, Gwynedd, LL40 1TB.

NASCOM-2, Kenilworth Case, display monitor. 40K-RAM, I/O Board with Uart/PIO Nas-sys-3, tool kit, Hullforth, Wordease, assembler and games. Manuals, magazines and IMP printer (not working) for £400 ono. Tel: 029668-651 evenings.

APPLE SOFTWARE — Arcade/Adventure games, business and utilities plus over 150 Software manuals — SAE List. J. Davey, 44, Hazelmere Road, Stevenage, Herts.

EPSON HX-20, case, Microcassette, Manuals. mint List £561. Accept £350. Thame (Oxon) 084421 4468.

MACHINE language program (1300 bytes) enabling the use of A 64 x 32 Screen on the Acorn-Atom instead of the standard 32 x 16 screen. Other features: printing text on Mode-4 graphics screen (move X, Y; P. "Text"); easy definition of own character set; use of upper- and lower-case letters. No hardware requirements. Prize: £10 (cass. + list). Dr. A. Naus, Ringweg 46, 6097EE Heel, The Netherlands.

TRS 80 MODEL I and expansion interface 48K £300. Green V.D.U. £50. Two disk drives £300. MX80 printer £300. Desk £20. Word processing, label and mailist programs included with full package. Richards (0482) 843303 (Hull) after 8.00pm.

MZ80 TAPES, mostly surplus to requirements, games, demonstration etc for details phone Gainsborough 2891.

TELEVIDEO (1983) TS802H 10 MByte Microcomputer, Wordstar, Mailmerge, Dastar, Calcstar, Spellstar, Supersort, BStam, DBase2, CBasic, MBasic, Cobal, Pascal, PL/1, List over £8,000 accept £3,800 plus Vat. Telephone 01-486 1670 anytime.

TRS-80/L2 Plus expansion interface, plus disc drive, many games — manuals, offers. Tel: 028373 3494 Evenings.

CPM. Alphabetic DIR. complete directory or range of files. £5.00 for assmebler listing + assembly instructions. J. Duffell, 17, orchard brow, Hollins Green, Warrington.

Exchange or Sell complete 16mm Bolex cine outfit RXVS Finder 17-85mm Pan Cinor Zoom Lens — Rare 10mm — 16mm — 25mm — 75mm Switar Lens — 150mm Yvar Lens — Accessories — spare reflex body — H16 Body — 25mm two 75mm Yvar Lens — Octometer — Pro 16mm Splicer Pro 16mm Murray Editor — Arms on stand — 16mm Sond Ampro Profector — Original Transformer — Films — Cartoons — Etc. **Wanted** Complete outfit Apple IIe (Series) Computer — Monitor — Printer Disks — Storage — to value £2,500 — IBM may be considered — Adjustment if required — 0278-58404 Genuine offers only please or exchange — phone evenings best.



DISK COPYING SERVICE

Moving data and program files from one machine to another is often made difficult because different manufacturers have adopted different disk format standards.

We can copy your files to and from almost any disk format including CP/M, MSDOS, PCDOS, TRSDOS, ISIS, APPLE, SIRIUS, PDP11, VAX, and IBM.

Disks are normally despatched on the day they are received.

Our charge is £10.00 + disk + VAT. Special prices for quantities and tape to disk transfers.

For more information call us.

GREY MATTER

4 Prigg Meadow, Ashburton, Devon TQ13 7DF.

TEL. (0364) 53499

● Circle No. 230

WANTED Winchester and Interface suitable Appler Plus 021-427 2283.

COMMODORE "4032" with Pic-Chip Super-Chip and Toolkit. Anadex "8000" Printer Tape Recorder Leads Extensive Software Manuals Books etc. Excellent condition. Offers on £500. Falmouth (0326) 316160.

ORIC 1 48K including £30 worth software, Books, £99 + P.P. 0782 610607.

WANTED Superbrain DQD Dot Matrix Printer 2nd Hand. Bristol (0272) 737222.

OLIVETTI ET351 Text Editor for sale including Twin Disk Drive plus quantity of Discs etc. £1500. Phone 01-363 0356.

APECTRUM USERS — We specialise in Professional Programs for Home and Business Management. SAE for catalogue. SD Systems (PC) PO Box 24, Hitchin, Herts. Trade Enquiries welcome.

PET 4016 Small Screen Cassette Programs V.G.C. £300 o.n.o. Aldershot 311754.

APPLE IIe, 128K, 80 Col., Twin Disk, Zenith Green Screen Monitor, Epson RX80 Printer; nominal purchase, sales ledgers, payroll, stock control, 3 months old, list £3850, take £1950 plus vat. 0736 3121 evenings.

BBC HOBBIT Tape System 6 months old £110 including tapes 01 423 0745

DIABLO 630 WORD Processing Printer, Async I/A with 2 Daisy Wheels 2 Ribbons. Removable cut sheet feeder with adjustable bins. Also separate tractor feed device. Complete with A4 and continuous stationery £800 o.n.o. Tel 076 727 427 evns.

Rair Black Box Two user 6MB Hard disk 1 year old £2,000 also Epson RX-80 FT unused boxed £270 Tel 0963 22280.

Business Software for Dragon. Mailing list £19.95, stock control £19.95 business utility £9.95. Plus much more. Sae for list. Cheques/PO's to: B. Mistry 75 St. Margaret's Road, Bradford BD7 2BY.

Apple II Europlus, 2 disc drives, DOS 3.3, Kaga Monitor, Praxis Daisywheel printer. Language + 80 col. + Clock cards. Visifile, book-keeper, Applew.ter II, Graphics Tablet, 1yr old, Mint, hardly used. £1600. 01-455 3608.

Fieldwork Fifty

The microcomputer that goes where the job is



- POWERFUL** Up to 256 kbytes of non-volatile bubble memory for permanent data storage. 32 K bytes of RAM and 16 kbytes of PROM for program operations. Z80 processor.
- PORTABLE** 1.6kg battery (rechargeable) operated. 273mm wide x 190mm high x 49mm deep (less than A4).
- RUGGED** Waterproof, shockproof, operates from -30°C to +70°C (including LCD 2 line by 40 character display).
- FLEXIBLE** RS232 interface for communication with a wide range of desktop micros, printers, modems, terminals, bar code readers, etc. BASIC programmable. Designed to work with DP/M systems and programs.
- VERSATILE** Choice of keyboards (QWERTY/ABC/AZERTY/etc). Programmable function keys.

BRITISH



Immediate Business Systems plc

3 Clarendon Drive, Wymbush
Milton Keynes MK8 8DA

Telephone: 0908 568192 Telex: 825256

● Circle No. 240

Advertisement Index

A		D		M		R	
A&G Computerware	68	Dataflex Ltd	144	3m (UK) PLC	40,41	Rank Xerox	78,79
A-Line Computer Systems	76	Digital Equip Co.	168,169	MSI	62	Ranmoor Computing	126
ACT Hardware	94,95	Digithurst Ltd	181	MT Direct	152	Real Time Developments	66
ATA	93	Direct Disk Supplies	164	Mayfair Micros	138	Reprints	138
AWS	170	Diskotek	48	Memotech	26,27,37		
Accent Computers	73	Dynotech Microsoftware	184	Micro Business	193	S	
Acorn	17,25			Micro Miracles	124	Sapphire Systems	141
Act Pulsar	142,143	E		Micro Peripherals	IBC	Saracen Data Products	140
Aculab Ltd	68	Epson HX20	176	Micro Rent	84	SCI (UK) Ltd	16
Aimgram Ltd	16	Epson Printer	18,19	Micro Research Ltd	76	Scope Systems	85
Akhter Instruments	92	Epson QX10	133	Microcomputer Disks	24	Simmons Magee	36
Alpha Micro	4	Everyday Electronics	66	Microcomputer Products	99	Sintrom	24
Anglia Computer Centre	68			Micronix	31	SM Software	160
Audio Genic Ltd	190	F		Micropacs	184	Soft Option	121
		Facet	116	Micropute	194,195	Software Ltd	BC
		Ferranti	158,159	Microsoft	20,70,71	Southdata	188
		Fox & Geller	136,179	Microware Ltd	63	Swan Packaging	154
		Fraser Assoc.	126	Midland Computer Fair	182	Symbiotic	125
B				Midlectron	113		
BFI/Diskpost	167	G		Mike Lewis	85	T	
Beebug	184,197	GCC Cambridge Ltd	49	Mountaine	117	Tandata Marketing	30
British Micro	191	GW Computers	32,33			Tashki Computers	72
British Olivetti	74,75			O		Teledigital	22
Bromcom	163	H		OKI Electric	50	Telesystems Ltd	183
		Hewlett Packard	9	Opus Supplies	81	The Computer Trade Confer	196
				Oxford Computer Publishing	185	Transam Microsystems	82,83
C		I		Oxford Computer Systems	30	Triumph Adler	86,87
C.C.L.	77	ICIP&P Division	180,181			V	
CDP Consultants	197	Immediate Bus Systems	202	P		Varelco Ltd	154
Calco Software	170	Integrex Ltd	80	Page Plus	14	Verwood Systems	117
Cambridge Micro Electric	116	Intelligence UK	186,187	Pete & Pam Computers	42,43	Video Games	67
Camden Computers Systems	140	Interam	28	Pinner Wordpro	76		
Chiltern Electronics	44			Precision Software	170	X	
Comart	34	K		Prospero	49	X-Data	157
Commodore	150,151	Keyaki Ltd	IFC	Psion	85		
Compssoft Ltd	12	Kingsley Enterprises	138	Q		Y	
Computech Systems	149			Qubie	69	Y-Software	116
Computer Fair	192	L		Oudos Systems Ltd	45	Z	
Computer Trade Show	139	LSI Computers Ltd	10,11			Zero Electronics	66
Computer Trade Show Conference	196	LVL	174,175				
		Langman Group	197				
Crowther Cosine	16	Lantech	154				
Crystal Research	117	Laskys	46,47				
Cyber Robotics	62	London Computer Centre	6,84				

JUKI

The Art of Daisywheel Printing



The new Juki Model 6100 letter quality daisy wheel printer, has features you'd expect to find on a more expensive printer. It can support word processing and graphic functions, print 20 CPS and use a simple drop-in daisy wheel. The 6100 has 10/12/15 pitch, proportional spacing, utilizes IBM standard Selectric ribbons, has 2K buffer memory, parallel interface with tractor feed and serial interface are available as options. That's only the beginning - Best of all, the low-noise Juki 6100 is extremely reliable. You can pay more, but you can't buy better than the Juki 6100.

FEATURES:

- *BSI Approval No. BS5850
- *20 CPS (max.) print speed
- *Bold and shadow printing
- *Subscripts and superscripts
- *Wordstar compatible
- *Diablo protocols
- *Auto Underlining
- *Standard 2K buffer
- *1 year parts and labour warranty
- *Comprehensive user friendly manual

Micro Peripherals Ltd
 'THE POWER BEHIND THE PRINTED WORD'

59 The Street, Basing, Basingstoke, Hampshire RG24 0BY
 Telephone: 0256 3232 (12 lines) Telex: 859669 MICROP G

Call your local dealer NOW for full information on the Juki 6100 Daisywheel Printer or clip this coupon and we'll send you brochures and print samples.

Name.....

Address.....

Tel. No.....

**Just because you
need it in a flash,
don't expose
yourself!**



You've a deadline to meet, the right CP/M Software package is needed, the right decision has to be made; which format, which product, when can it be delivered, at what price?

You need good advice, and just as important, you need to talk to someone who has a large enough range to be able to offer honest advice. Someone who can then deliver on time, someone whose catalogue is fast becoming the byword of the software industry.

So don't expose yourself, talk to Software Limited. Choice, advice and delivery, all aimed at meeting your deadline.

Software Limited...
Because there's more to choose from, we're the only choice to make.

01-833 1173/6

Software Limited
No.2 Alice Owen Technology Centre
251 Goswell Road, London EC1

CP/M is a trademark of Digital Research

